

MACHINE VISION SMART PRODUCT CATALOG

Vision for Imagination



Overview

SC1000 Series Vision Sensor P13



- Resolution range 0.3MP-0.8MP
- It has vision tools such as existence, count, measurement, and recognition

SC2000 Series Vision Sensor P15



- Resolution range 0.4MP-1.6MP
- It has existence, position, defect, logic, count, measurement and recognition vision tools

SC2000A Series Navigation Sensor P17



- Support for wide field code reading and positioning
- Provide precise positioning information for AGV

SC3000 Series Vision Sensor P18



- Resolution range 1.6MP-5MP
- It has existence, position, defect, logic, count, measurement and recognition vision tools

SC5000X Series Smart Camera P21



- Resolution range 2MP-5MP
- It has VM Platform, including deep learning modules.

SC6000 Series Smart Camera P23



- Resolution range 1.6MP-25MP
- It has VM Platform, including deep learning modules

ID800 Series Industrial Code Reader P35



- Compact fixed industrial code reader, various data interfaces, and large depth of field
- Suitable for retail, logistics, medical treatment, intelligent manufacturing, enterprise and public institutions.

ID2000 Series Industrial Code Reader P36



- Extremely small fixed industrial code reader, which can be embedded in automated machine equipment
- Suitable for lithium, packaging, consumer electronics and other industries

ID3000 Series Industrial Code Reader P38



- Compact fixed industrial code reader, high speed reading, high reading rate
- Suitable for lithium, consumer electronics, photovoltaic, panel, auto parts, tobacco and other industries

ID5000 Series Industrial Code Reader P40



- Full-featured fixed industrial code reader, large FOV
- Suitable for PCB, automotive, manufacturing, internal logistics, food and drug industries

ID6000 Series Logistics Code Reader P42



- Logistics industry special type high-resolution code reader
- Responding to complex logistics code reading application scenarios

ID7000 Series Logistics Code Reader P44



- Logistics industry special type smart line scan code reader
- Easily covers conveyor belts up to 1.4m wide

IDS Series Integration Code Reader

P46



- Core component products for code reading devices, standard and smart models available
- Integrates image acquisition, data processing and result output functions

IDH2000 Series Handheld Code Reader

P48



- Compact and lightweight design, strong code reading ability
- Suitable for chain retail, e-commerce, logistics, supermarkets and asset inventory scenarios

IDH3000 Series Handheld Code Reader

P50



- General-purpose, comprehensive functions, high cost performance
- Suitable for 3C electronics, semiconductors, lithium battery new energy, logistics, food and medicine scenarios

IDH7000 Series Handheld Code Reader

P52



- Durable class, high-level protection design and outstanding DPM code reading capability
- Suitable for automotive parts, metal processing, 3C electronics, semiconductors, lithium batteries and new energy industries

IDH9000 Series Handheld Code Reader

P54



- Ultra-durable class, resistant to harsh environments, support 0.4mm micro code reading
- Suitable for automotive parts, aerospace, metal processing, 3C electronics, semiconductors industries

VC2000 Series Vision Controller

P60



- Equipped with Intel high-Performance CPU, equipped with rich data acquisition and control interface
- Compact in design, it provides a complete solution for multi-camera simple vision applications

VC3000 Series Vision Controller

P61



- Devices for control and processing of vision inspection with strong arithmetic power, as well as rich data acquisition and control interfaces
- Good compatibility of machine vision components in positioning, inspection, measurement, identification and other tasks

VC5000 Series Vision Controller

P63



- A high-Performance AI edge vision computing platform
- Flexible modular design, meeting the extended requirements of acquisition interface or graphics card in machine vision

VT2000 Series TouchScreen PC

P65



- Equipped with Intel Elkhart Lake processor and multi-point capacitive touchscreen
- Used in simple multi-camera vision applications, providing more flexible choices for machine vision devices

VT3000 Series TouchScreen PC

P66



- Equipped with Intel Elkhart Lake processor and multi-point capacitive touchscreen
- Used in simple multi-camera vision applications, providing more flexible choices for machine vision devices

VM Algorithm Development Platform

P67



- Self-developed machine vision software with 140+ modules and tools
- Applications in machine vision applications such as visual positioning, Dimensional measurement, defect detection, and information recognition

CodePlatform

P74



- Comprehensive code reading software platform, including data acquisition, image processing, communication output, data statistics and other functions
- Suitable for flexible code reading needs of various complex scenarios in logistics enterprises

CONTENTS

Overview	3	Vision Controller	54
Machine Vision	7	VC2000 Series Vision Controller	54
Performance and Application of Smart Camera -	8	VC3000 Series Vision Controller	55
Smart Camera	13	VC5000 Series Vision Controller	57
SC1000 Series vision sensor	13	VT2000 Series TouchScreen PC	58
SC2000 Series Vision Sensor	15	VT3000 Series TouchScreen PC	59
SC2000A Series Navigation Sensor	17	VM Algorithm Development Platform	60
SC3000 Series Vision Sensor	18	CodePlatform	66
SC5000X Series Smart Camera	20		
SC6000 Series Smart Camera	22		
SCMVS Client	24		
Selection Guide of Smart Camera	25		
Performance and Application of Smart Code Reader	27		
Smart Code Reader	34		
ID800 Series Industrial Code Reader	34		
ID2000 Series Industrial Code Reader	35		
ID3000 Series Industrial Code Reader	37		
ID5000 Series Industrial Code Reader	39		
ID6000 Series Logistics Code Reader	41		
ID7000 Series Logistics Code Reader	42		
IDS Series Integration Code Reader	43		
IDH2000 Series Handheld Code Reader	45		
IDH3000 Series Handheld Code Reader	46		
IDH7000 Series Handheld Code Reader	47		
IDH9000 Series Handheld Code Reader	48		
IDMVS Client	51		
Selection Guide of Smart Code Reader	52		

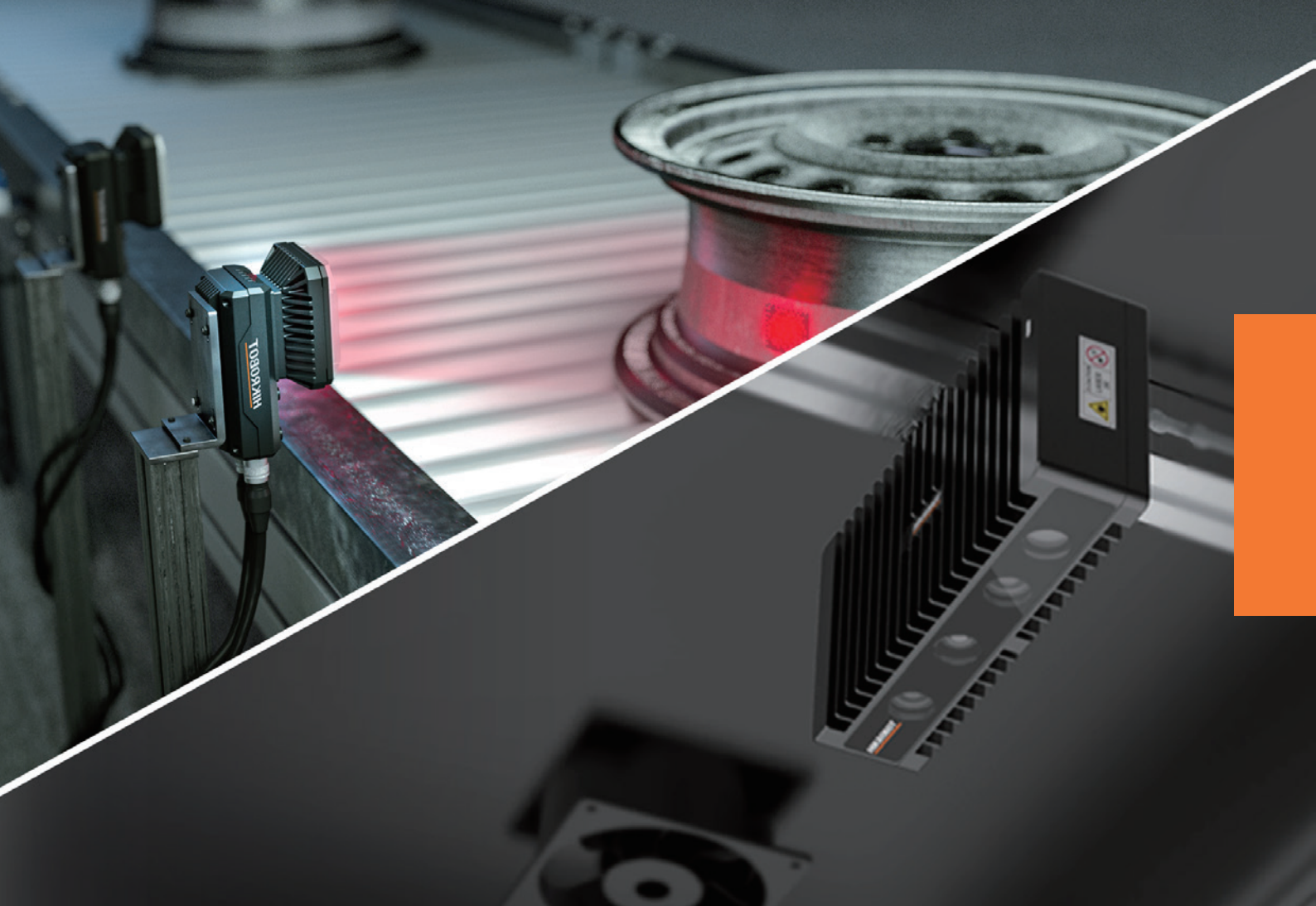

Hikrobot

Hikrobot is a global product and solution supplier specialized in machine vision and mobile robot. Focusing on IIoT, smart logistics and smart manufacturing, we build open cooperation ecosystem, provide service to industry and logistics customers, and commit to continuously promoting the intelligentization and leading the intelligent manufacturing process.

■ Machine Vision

With efforts in industrial vision sensing application and hardware technology, the company provides customers with leading machine vision products. The products cover industrial camera, lens, vision box, industrial smart camera and related accessory.

Through rigorous EMC, safety and reliability tests, Hikrobot guarantees the high precision, high efficiency and high environmental Performance of each product. The machine vision products are widely used in industrial automation sectors such as consumer electronics, semiconductors and logistics, as a part of the vision applications like positioning guidance, measurement, quality inspection, code reading, OCR, etc. They help users to greatly improve productivity, accuracy and stability.

Performance and Application of Smart Camera

Product Background

Smart camera is a highly integrated micro and small machine vision system that integrates image acquisition, storage, processing and communication functions into one, thus forming a multi-functional, modular, highly reliable and easy-to-operate machine vision solution. At the same time, due to the continuous iterative update of DSP, FPGA and a large number of storage technologies, its intelligence has been increasing to meet the needs of increasingly complex machine vision applications.

Key Features

- Resolution range 0.4MP~25MP, Support long-range and large FOV detection
- Built-in large-capacity storage space, support for cyclic saving pictures
- Includes traditional vision algorithms as well as AI deep learning, covering all types of detection
- Support a variety of industrial communication protocols
- IP65 or higher protection level, adapt to the harsh industrial application environment

Performance

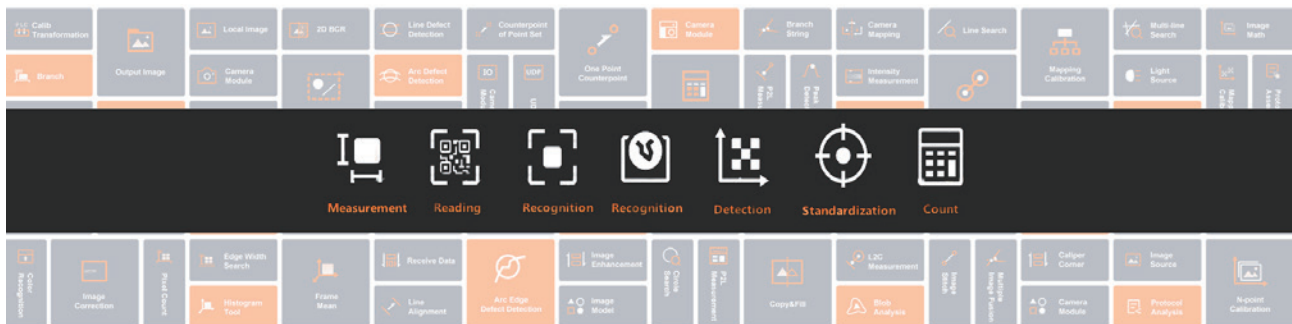

- Rich operators and over 160 detection tools, providing various choices

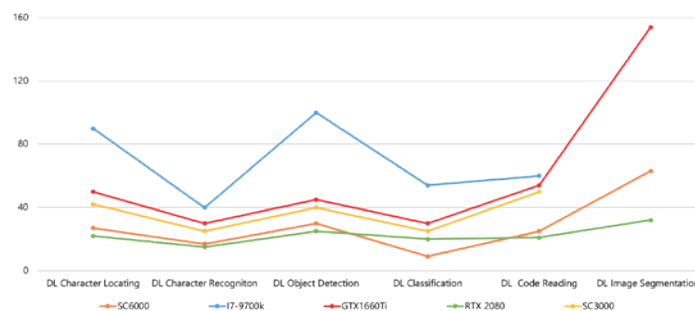

- Powerful computing platform to help more complex applications



- One-button debugging parameters, automatic setting of brightness focus and white balance

Industry Cases

Automotive & Auto Parts Industry

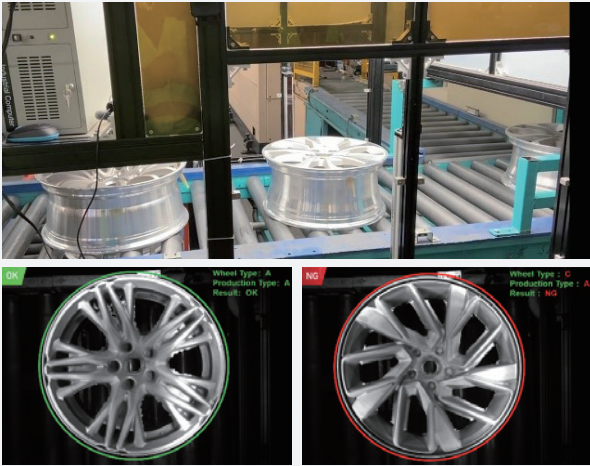

Error-proof detection of multi-model car wheels

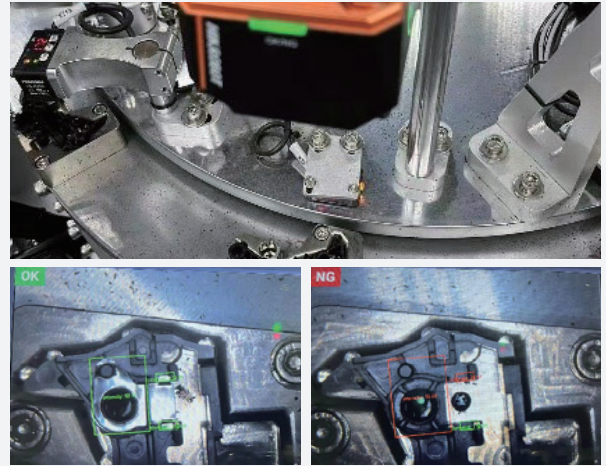

Error-proof detection of metal dome before auto part assembly

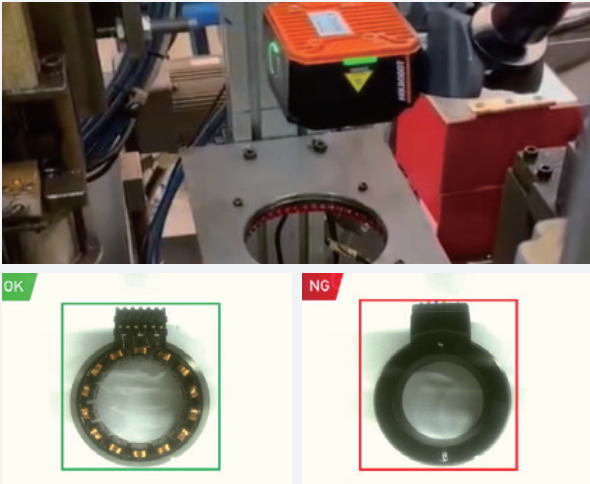

Error-proof detection of wheel bearing

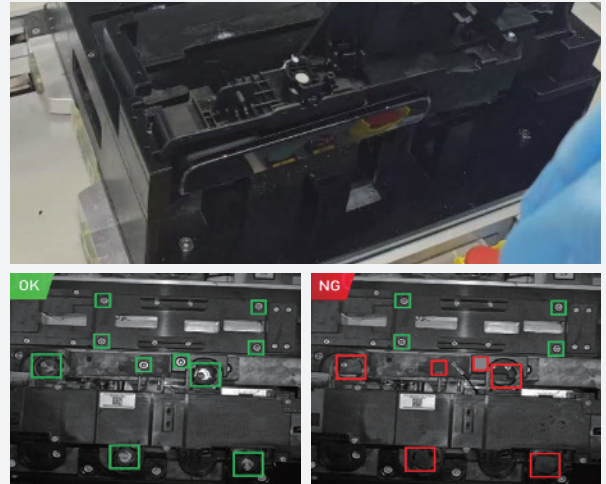

Car door handle screw installation detection

Medical Industry



Pill box code traceability

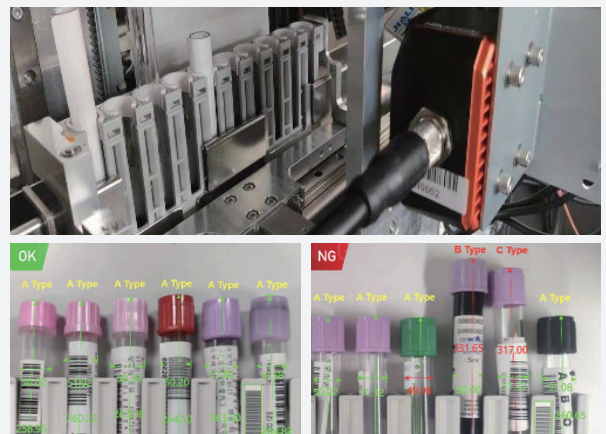

Pharmaceutical test tube multi-class judgment

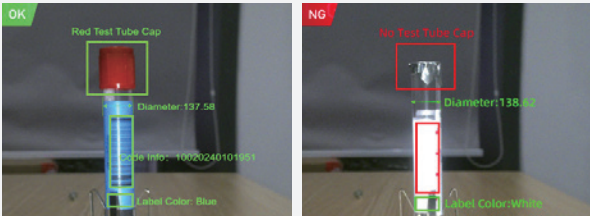

Pharmaceutical test tube information detection

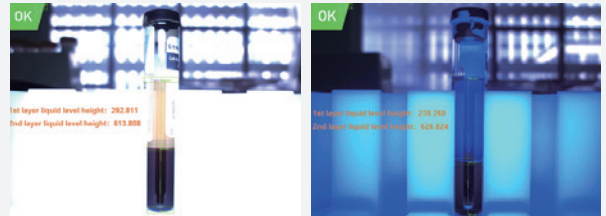

Pharmaceutical test tube liquid level measurement

Lithium Industry

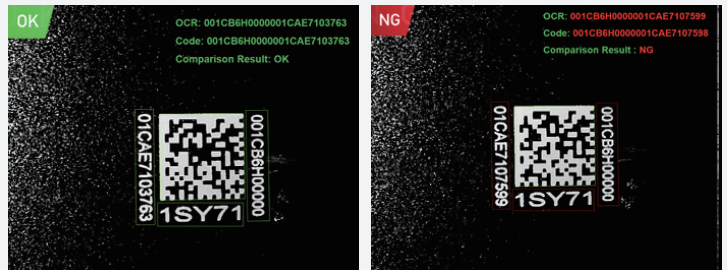

Inkjet interference in lithium battery information detection

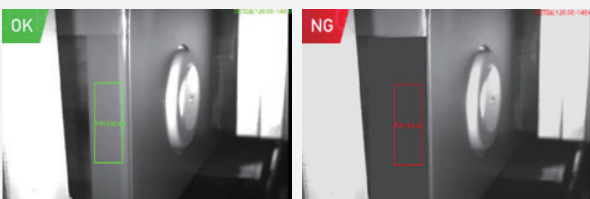
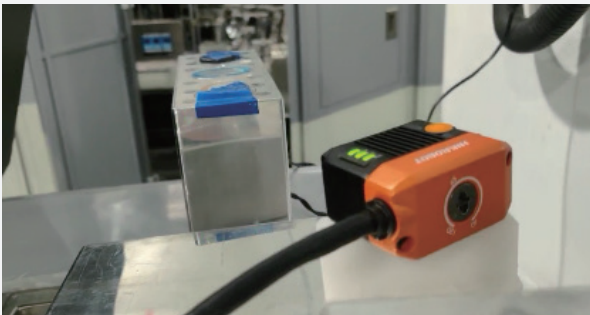

Lithium battery color detection

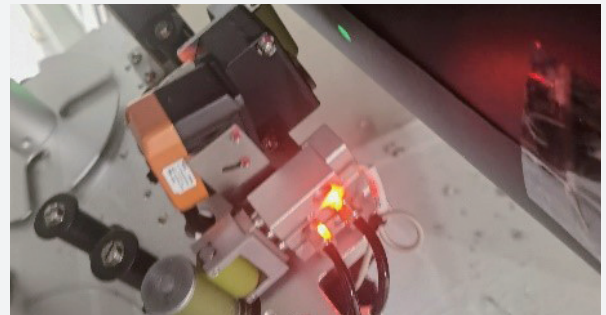

Lithium battery tab zigzag detection

Packaging Industry

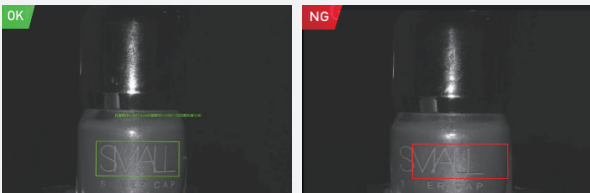
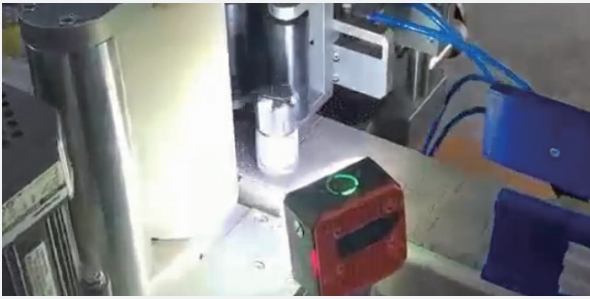

Package labeling guide ultra-high speed inspection

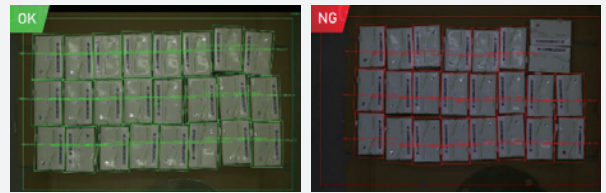

Food package number inspection

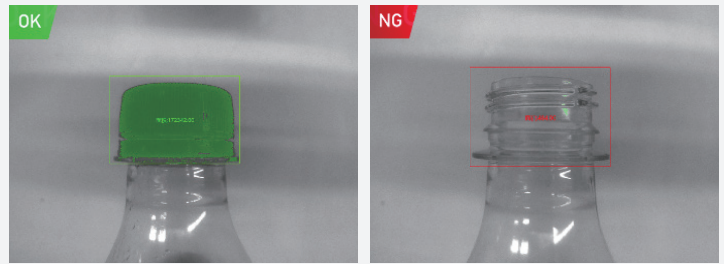

Bottle cap presence detection

Mechanical arm gripping scene

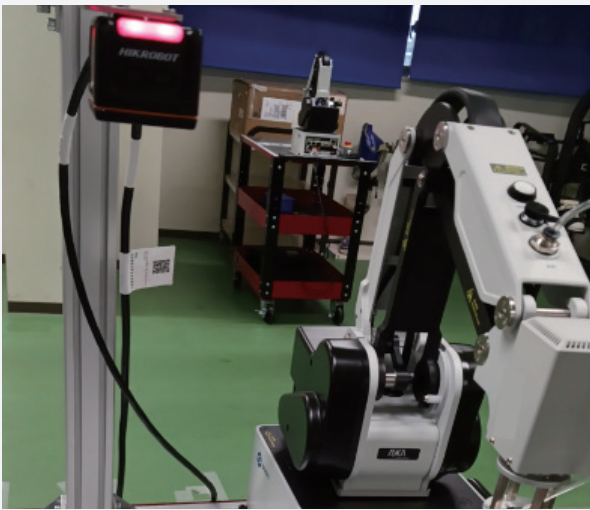

Mechanical arm guided product gripping

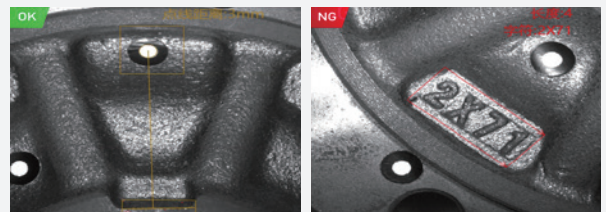

Mechanical arm multi-point detection

Photovoltaic Industry

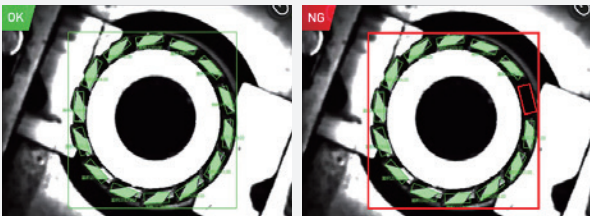
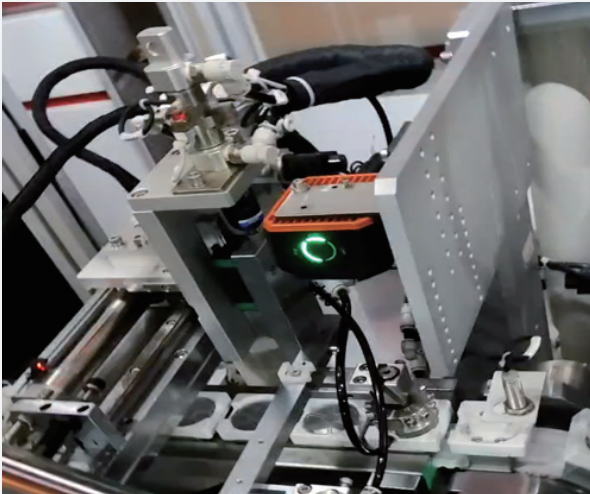

Error-proof detection of photovoltaic module

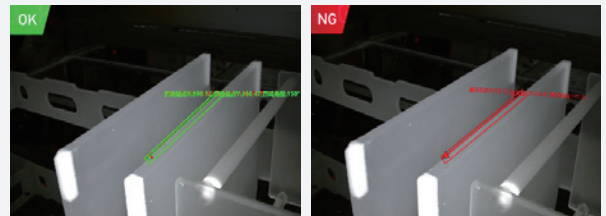
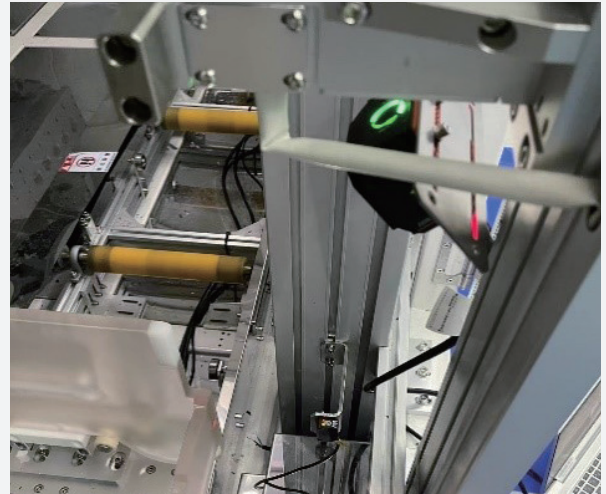

Photovoltaic quartz boat position detection

Manufacturing Industry



Vibrating tray feeder incoming material detection

Semiconductor Industry

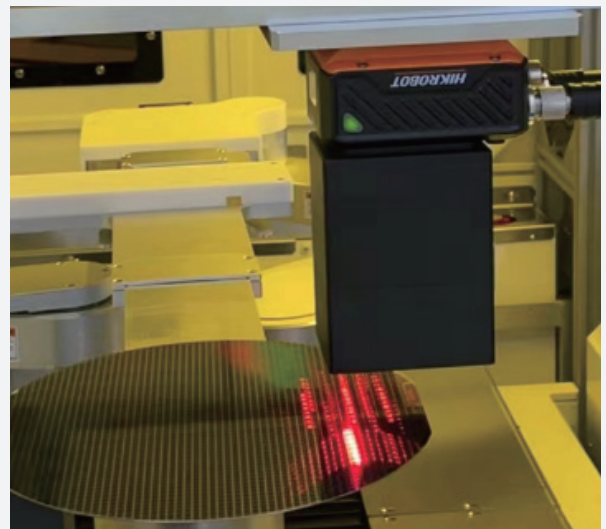

Silicon wafer SEMI font recognition

Smart Camera



SC1000 Series vision sensor

The SC1000 series has the smallest overall machine size. It integrates lighting, collection, processing, communication and other visual modules in a very small body, and can implement detection algorithms such as existence detection, forward/reverse detection, counting, size measurement, and AI registration classification. It covers the use of a single device for production quality inspection and other scenarios, and is more cost-effective.

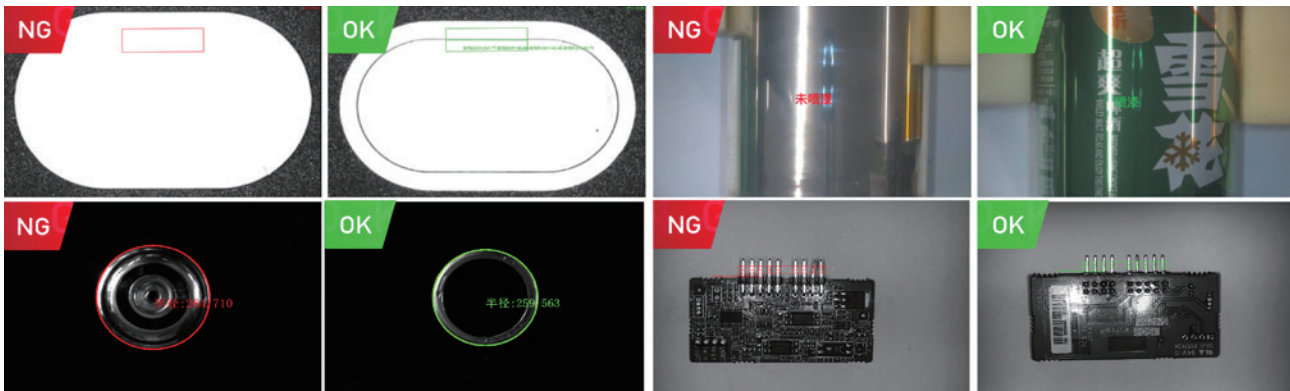

- Internally integrated algorithms bring a better choice for error-proofing detection in the automotive, new energy, consumer electronics and other industries



- The whole device is compact and can be installed freely in a small space, perfectly embedded in miniaturized machine equipment

Specifications



Model	Pixel size	Sensor size	Resolution	Max. frame rate	Mono/color	Focal length
MV-SC1003M	3.74 μm	1/6"	640 × 480	15 fps	Mono	3.1 mm
MV-SC1003C	3.74 μm	1/6"	640 × 480	15 fps	Color	3.1 mm
MV-SC1008M	2.7 μm	1/4"	1024 × 768	15 fps	Mono	4.9 mm

Vision Tool / Model		MV-SC1003M/SC1008M	MV-SC1003C
Measure	P2L Measurement	√	√
	Contrast Measurement	√	√
	Greyscale Size	√	√
	Edge Width Measurement	√	√
	Width Measurement	√	√
	Brightness Average Value	√	√
	L2L Angle	√	√
	Diameter Measurement	√	√
	Line Angle	√	√
	Color Size	×	√
Exist	Color Measure	×	√
	Spot Existence	√	√
	Edge Existence	√	√
	Contour Existence	√	√
	Circle Existence	√	√
	Line Existence	√	√
Count	Spot Count	√	√
	Edge Count	√	√
	Contour Count	√	√
	Color Count	×	√
Recognize	Classification Registration	√	√
	Color Contrast	×	√
Logic	Claculator	√	√
	Logic Judge	√	√
	Condition Judge	√	√
	Combination Judge	√	√
Locate	Fixture	√	√

Dimension

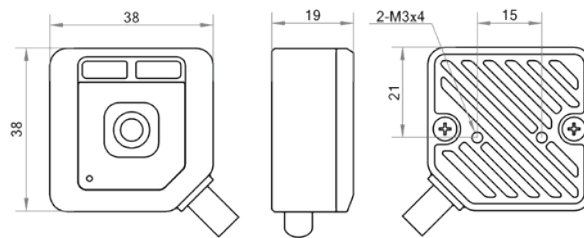

PS: Cable bending space 30mm

Unit:mm

Smart Camera

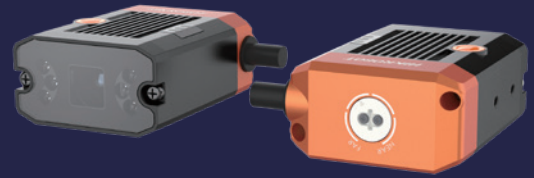

SC2000 Series Vision Sensor

SC2000 Series Vision Sensor integrates full functions of a vision system: lighting, acquisition, processing, and communication in minimal fuselage. Bring new choices for Y/N, P/N verifications with excellent performance in error-proofing detection scenarios.

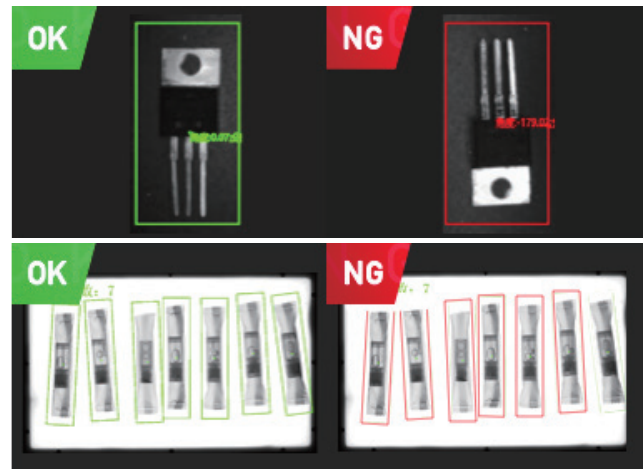
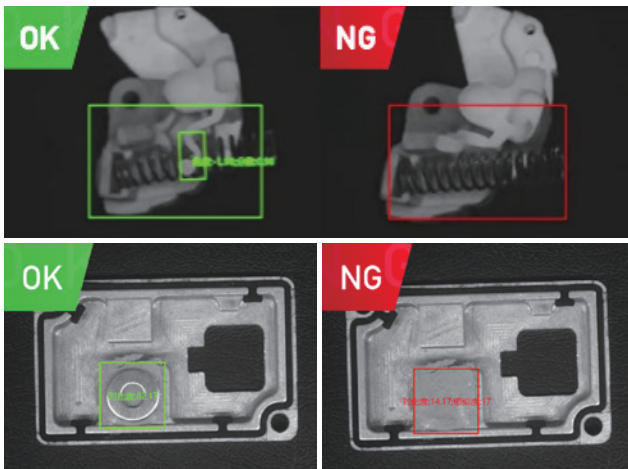

- Comprehensive Error-proofing Detection Algorithm, focusing on simple applications in single-function scenarios, with higher cost-effectiveness

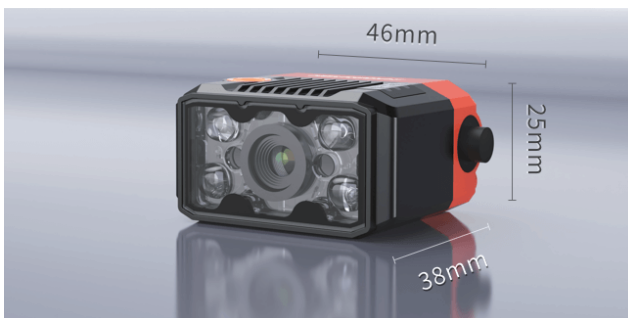

- Ultra-compact size, can be freely installed in a small space and perfectly embedded in miniaturized equipment

Specifications



Model	Pixel size	Sensor size	Resolution	Max. frame rate	Mono/color	Focal length	Label
MV-SC2004EM(Mini)	6.9 μm	1/2.9"	704 × 540	60 fps	Mono	6.72 mm	A
MV-SC2016EM(Mini)	3.45 μm	1/2.9"	1408 × 1024	60 fps	Mono	6.72 mm	A
MV-SC2004EM	6.9 μm	1/2.9"	704 × 540	60 fps	Mono	8/12.4/14.8mm	B
MV-SC2004EC	6.9 μm	1/2.9"	704 × 540	60 fps	Color	8/12.4/14.8mm	B
MV-SC2016EM	3.45 μm	1/2.9"	1408 × 1024	60 fps	Mono	8/12.4/14.8mm	B
MV-SC2016EC	3.45 μm	1/2.9"	1408 × 1024	60 fps	Color	8/12.4/14.8mm	B
MV-SC2023XM	2.2μm	1/3.52"	1920 × 1280	75fps	Mono	5/12/16mm	C
MV-SC2023XC	2.2μm	1/3.52"	1920 × 1280	75fps	Color	5/12/16mm	C

Vision Tool / Model		MV-SC2004EM(Mini) MV-SC2016EM(Mini)	MV-SC2004EM MV-SC2016EM	MV-SC2004EC MV-SC2016EC	MV-SC2023XM	MV-SC2023XC	
Measure	P2P Measurement				√	√	
	P2L Measurement	√	√	√	√	√	
	Contrast Measurement	√	√	√	√	√	
	Greyscale Size	√	√	√	√	√	
	Edge Width Measurement	√	√	√	√	√	
	Width Measurement	√	√	√	√	√	
	Brightness Average Value	√	√	√	√	√	
	L2L Angle	√	√	√	√	√	
	Diameter Measurement	√	√	√	√	√	
	Line Angle	√	√	√	√	√	
	Color Size	x	x	√	x	√	
	Color Measurement	x	x	x	x	√	
	Existence	Anomaly judge	x	x	x	√	√
		Spot Existence	√	√	√	√	√
Edge Existence		√	√	√	√	√	
Contour Existence		√	√	√	√	√	
Circle Existence		√	√	√	√	√	
Pattern Existence		√	√	√	√	√	
Line Existence		√	√	√	√	√	
Count	Spot Count	√	√	√	√	√	
	Edge Count	√	√	√	√	√	
	Contour Count	√	√	√	√	√	
	Pattern Count	√	√	√	√	√	
	Color Count	x	x	x	x	√	
Recognize	OCR	√	√	√	√	√	
	Classification Registration	√	√	√	√	√	
	Color Contrast	x	x	√	√	√	
	Color Recognition	x	x	√	√	√	
	Category recognition	x	x	x	√	√	
Logic	Code recognition	x	x	x	√	√	
	Claculator	√	√	√	√	√	
	Logic Judge	√	√	√	√	√	
	Condition Judge	√	√	√	√	√	
	Character Comparison	√	√	√	√	√	
	Combination Judge	x	√	√	√	√	
	If module	x	x	x	√	√	
	String comparison	x	x	x	√	√	
Locate	Format output	x	x	x	√	√	
	Fixture	√	√	√	√	√	
	Calibration convert	x	x	x	√	√	
	Single point alignment	x	x	x	√	√	
	Point rectify	x	x	x	√	√	
	Point grasp	x	x	x	√	√	
Defect detection	Scale transformation	x	x	x	√	√	
	Anomaly detection	x	x	x	√	√	

Dimension

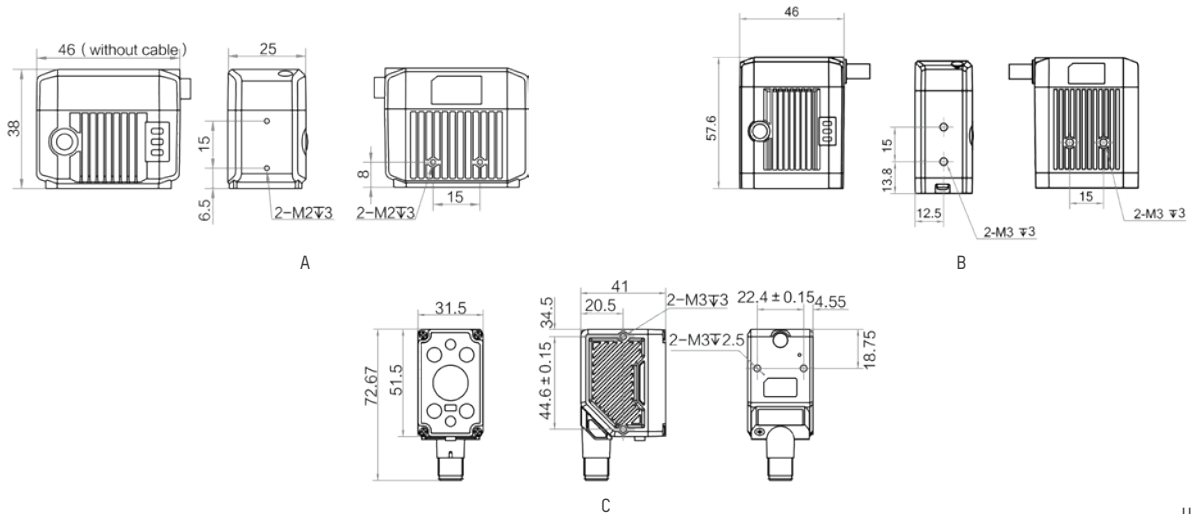

Unit:mm

Smart Camera



SC2000A Series Navigation Sensor

SC2000A series navigation sensor is a navigation sensor developed specifically for AGV. With excellent hardware design and high-Performance algorithms, the non-contact design can provide various positioning information for AGV cars stably, efficiently, and accurately. It is widely used in multiple industries such as unmanned warehousing, lithium-ion batteries, and photovoltaic systems.



- Built in multifunctional algorithms for efficient operation, supports information scanning and processing of ribbons, code strips and array codes of various colors

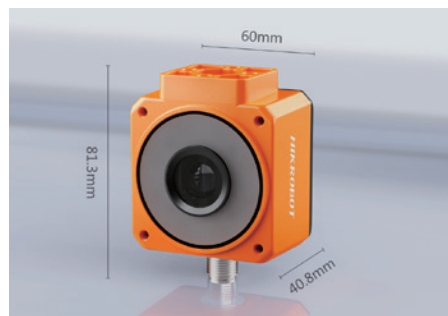

Dimension

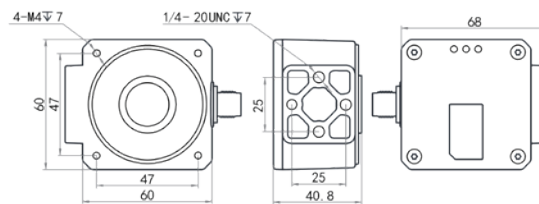

Unit:mm

- Compact structure, perfectly embedded inside the AGV

Specifications



Model	Pixel size	Sensor size	Resolution	Max. frame rate	Max. reading speed	Max.running speed	Mono/color	Focal length
MV-SC2005AM-02WBN	4.8 μm	1/3.6"	800 × 600	100 fps	100 codes/sec	3 m/s	Mono	2.5 mm
MV-SC2005AC-02WBN	4.8 μm	1/3.6"	800 × 600	96 fps	83 codes/sec	3 m/s	Color	2.5 mm
MV-SC2005AC-03WBN	4.8 μm	1/3.6"	800 × 600	96 fps	83 codes/sec	3 m/s	Color	3.4 mm

Smart Camera



SC3000 Series Vision Sensor

Integrated with imaging, processing and communication functions, the SC3000 series has a more compact size and the vision detection tools lead to better Performance. Equipped with a new SCMVS for on-site deployment and lower debugging requirements, bringing a more comprehensive and cost-effective choice for visual inspection!

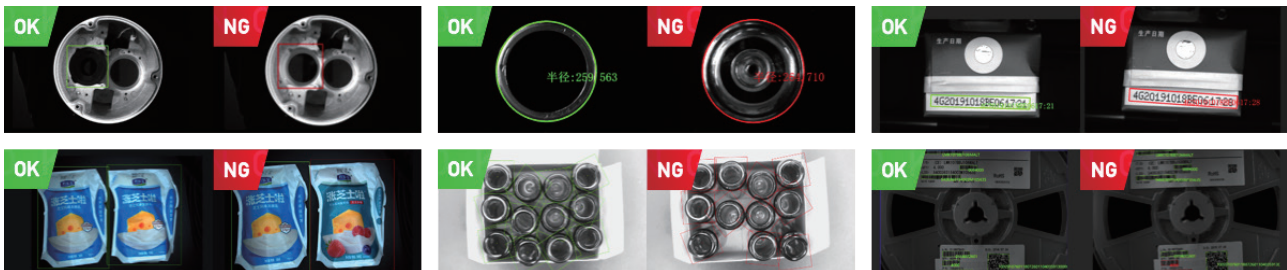

• Comprehensive Error-proofing Detection Algorithm

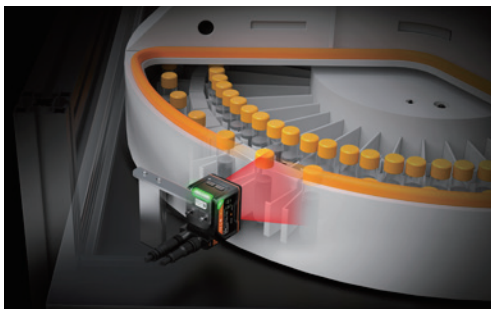

• Outgoing right angle design, supporting 180 degree rotation, flexible adaptation to narrow spaces

Specifications



Model	Pixel size	Sensor size	Resolution	Max. frame rate	Mono/color	Focal length	Label
MV-SC3016M	3.45 μm	1/2.9"	1408 × 1024	60 fps	Mono	6/12.4/14.8 mm	A
MV-SC3016C	3.45 μm	1/2.9"	1408 × 1024	60 fps	Color	6/12.4/14.8 mm	A
MV-SC3050M	3.2 μm	1/1.7"	2368 × 1760	30 fps	Mono	8/12.4/16 mm	A
MV-SC3013XM	6.9 μm	1/1.45"	1216 × 1024	60 fps	Mono	8/12/16 mm	B
MV-SC3013XC	6.9 μm	1/1.45"	1216 × 1024	60 fps	Color	8/12/16 mm	B
MV-SC3030XM	3.45 μm	1/1.8"	2048 × 1536	40 fps	Mono	8/12/16 mm	B
MV-SC3030XC	3.45 μm	1/1.8"	2048 × 1536	40 fps	Color	8/12/16 mm	B
MV-SC3050XM	3.45 μm	1/1.45"	2448 × 2048	40 fps	Mono	8/12/16 mm	B
MV-SC3050XC	3.45 μm	1/1.45"	2448 × 2048	40 fps	Color	8/12/16 mm	B
MV-SC3050XM-S	3.45 μm	1/1.45"	2448 × 2048	40 fps	Mono	8/12/16 mm	C
MV-SC3050XC-S	3.45 μm	1/1.45"	2448 × 2048	40 fps	Color	8/12/16 mm	C

Vision Tool / Model		MV-SC3016M MV-SC3050M	MV-SC3016C	MV-SC3013XM MV-SC3030XM MV-SC3050XM MV-SC3050XM-S	MV-SC3013XC MV-SC3030XC MV-SC3050XC MV-SC3050XC-S
Measure	P2P Measurement	√	√	√	√
	P2L Measurement	√	√	√	√
	Contrast Measurement	√	√	√	√
	Greyscale Size	√	√	√	√
	Edge Width Measurement	√	√	√	√
	Width Measurement	√	√	√	√
	Brightness Average Value	√	√	√	√
	L2L Angle	√	√	√	√
	Diameter Measurement	√	√	√	√
	Line Angle	√	√	√	√
	Color Measurement	×	√	×	√
	Color Size	×	√	×	√
Existence	Spot Existence	√	√	√	√
	Edge Existence	√	√	√	√
	Contou Existence	√	√	√	√
	Circle Existence	√	√	√	√
	Pattern Existence	√	√	√	√
	Line Existence	√	√	√	√
Count	Spot Count	√	√	√	√
	Edge Count	√	√	√	√
	Contour Count	√	√	√	√
	Pattern Count	√	√	√	√
	Color Count	×	√	×	√
Recognize	OCR	√	√	√	√
	Code Recognition	√	√	√	√
	Classification Registration	√	√	√	√
	Object Detection Registration	√	√	√	√
	Color Contrast	×	√	×	√
Logic	Color Recognition	×	√	×	√
	If Module	√	√	√	√
	Claculator	√	√	√	√
	Logic Judge	√	√	√	√
	Condition Judge	√	√	√	√
	Character Comparison	√	√	√	√
	Combination Judge	√	√	√	√
Locate	Calibration Convert	√	√	√	√
	Single Point Alignment	√	√	√	√
	Fixture	√	√	√	√
	Point Rectify	√	√	√	√
Defect	Point Grab	√	√	√	√
	Scale Transformation	√	√	√	√
	Exception Detection	√	√	√	√
Deep Learning	DL Object Detection	√	√	√	√
	DL Classification	√	√	√	√

Dimension

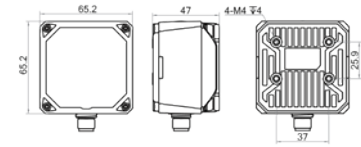

A

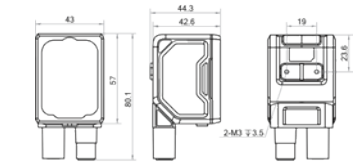

Straight angle

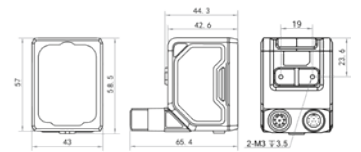

Right angle

B

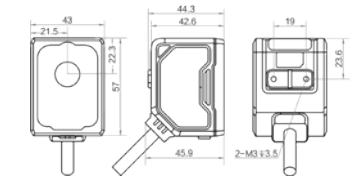

C

Unit:mm

Smart Camera



SC5000X Series Smart Camera

The SC5000 series smart cameras are developed based on an embedded platform, featuring built-in VM algorithms and powerful processing capabilities. They are highly user-friendly, and the integration of AI technology significantly reduces application difficulty and implementation costs, helping users quickly deploy them in various scenarios.



- It incorporates over 160 built-in vision algorithms, including traditional vision and AI deep learning. A flexible configuration interface and a powerful computing platform help cover a wide range of vision needs



- The modular lighting design provides users with a variety of accessories such as lens cap and lamp panel to choose from, improving the application flexibility of smart cameras and their ability to cope with complex scenes

Specifications



Model	Vision tool	Pixel size	Sensor size	Resolution	Max. frame rate	Mono/color	Focal length	Label
MV-SC5020XM	VM Platform (Including deep learning modules)	3.45 μm	1/2.53"	1600 × 1216	100 fps	Mono	6/12/16mm	A
MV-SC5020XC	VM Platform (Including deep learning modules)	3.45 μm	1/2.53"	1600 × 1216	100 fps	Color	6/12/16mm	A
MV-SC5050XM	VM Platform (Including deep learning modules)	3.45 μm	1/1.45"	2432 × 2048	60 fps	Mono	8/12/16mm	A
MV-SC5050XC	VM Platform (Including deep learning modules)	3.45 μm	1/1.45"	2432 × 2048	60 fps	Color	8/12/16mm	A
MV-SC5020XM-00C-NNN	VM Platform (Including deep learning modules)	3.45 μm	1/2.53"	1600 × 1216	100 fps	Mono	/	B
MV-SC5020XC-00C-NNN	VM Platform (Including deep learning modules)	3.45 μm	1/2.53"	1600 × 1216	100 fps	Color	/	B

Model	Vision tool	Pixel size	Sensor size	Resolution	Max. frame rate	Mono/color	Focal length	Label
MV-SC5050XM-00C-NNN	VM Platform (Including deep learning modules)	3.45 μm	1/1.45"	2432 × 2048	60 fps	Mono	/	B
MV-SC5050XC-00C-NNN	VM Platform (Including deep learning modules)	3.45 μm	1/1.45"	2432 × 2048	60 fps	Color	/	B
MV-SC5120XM-00C-NNN	VM Platform (Including deep learning modules)	3.45 μm	1/1.1"	4096 × 2944	30 fps	Mono	/	B
MV-SC5120XC-00C-NNN	VM Platform (Including deep learning modules)	3.45 μm	1/1.1"	4096 × 2944	30 fps	Color	/	B
MV-SC5020XM	VM Platform (Including deep learning modules)	3.45 μm	1/2.53"	1600 × 1216	100 fps	Mono	6/12/16mm	A
MV-SC5020XC	VM Platform (Including deep learning modules)	3.45 μm	1/2.53"	1600 × 1216	100 fps	Color	6/12/16mm	A
MV-SC5050XM	VM Platform (Including deep learning modules)	3.45 μm	1/1.45"	2432 × 2048	60 fps	Mono	8/12/16mm	A
MV-SC5050XC	VM Platform (Including deep learning modules)	3.45 μm	1/1.45"	2432 × 2048	60 fps	Color	8/12/16mm	A
MV-SC5020XM-00C-NNN	VM Platform (Including deep learning modules)	3.45 μm	1/2.53"	1600 × 1216	100 fps	Mono	/	B
MV-SC5020XC-00C-NNN	VM Platform (Including deep learning modules)	3.45 μm	1/2.53"	1600 × 1216	100 fps	Color	/	B
MV-SC5050XM-00C-NNN	VM Platform (Including deep learning modules)	3.45 μm	1/1.45"	2432 × 2048	60 fps	Mono	/	B
MV-SC5050XC-00C-NNN	VM Platform (Including deep learning modules)	3.45 μm	1/1.45"	2432 × 2048	60 fps	Color	/	B
MV-SC5120XM-00C-NNN	VM Platform (Including deep learning modules)	3.45 μm	1/1.1"	4096 × 2944	30 fps	Mono	/	B
MV-SC5120XC-00C-NNN	VM Platform (Including deep learning modules)	3.45 μm	1/1.1"	4096 × 2944	30 fps	Color	/	B

Dimension

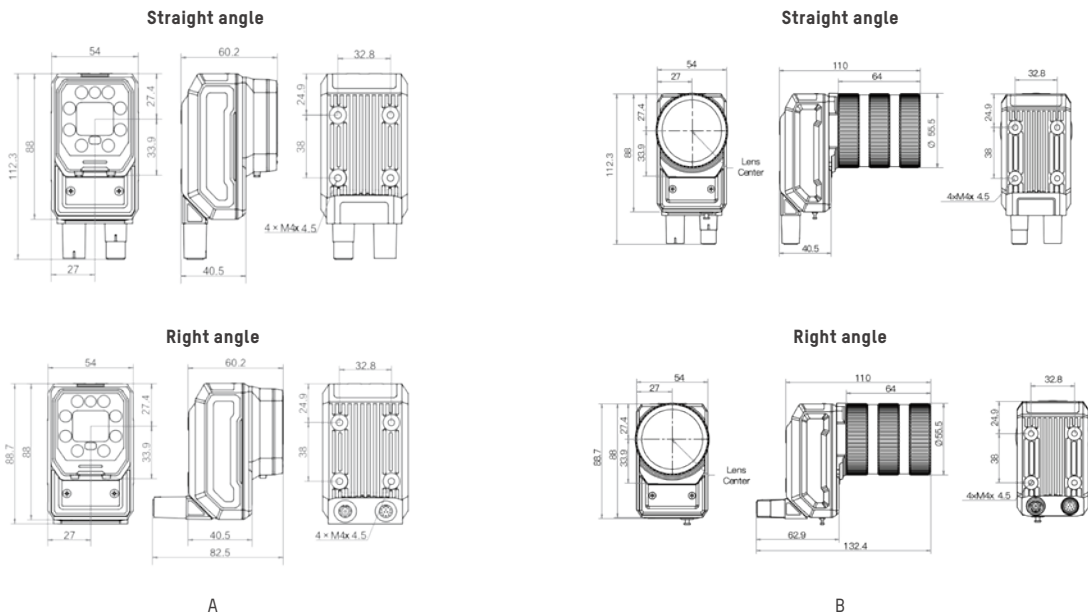

Unit:mm

Smart Camera



SC6000 Series Smart Camera

SC6000 series smart cameras are developed based on high-performance embedded processors, with powerful hardware performance and fully functional VM algorithm development platform. They can meet machine vision applications such as visual positioning, size measurement, defect detection, and information recognition. The highly integrated product form brings more choices for intelligent manufacturing.

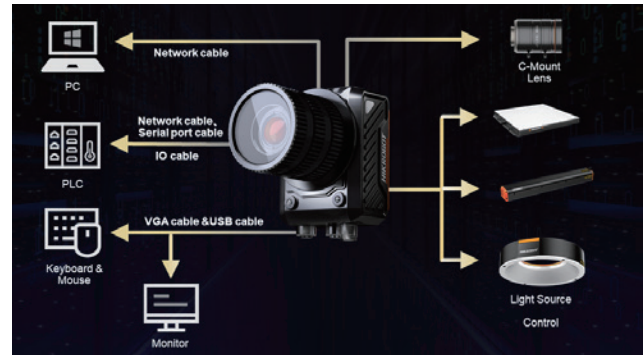

• Built in over 160 visual tools, various deep learning algorithms

• Rich interfaces, breaking through limitations

Specifications



Model	Function module	Pixel size	Sensor size	Resolution	Max. frame rate	Mono/color	Focal length	Label
MV-SC6016M	VM Platform (Including deep learning modules)	3.45 μ m	1/2.53"	1408 \times 1024	120 fps	Mono	6/12/16 mm	A
MV-SC6016C	VM Platform (Including deep learning modules)	3.45 μ m	1/2.53"	1408 \times 1024	120 fps	Color	6/12/16 mm	A
MV-SC6050M	VM Platform (Including deep learning modules)	3.45 μ m	1/1.45"	2432 \times 2048	80 fps	Mono	8/12/16 mm	A
MV-SC6050C	VM Platform (Including deep learning modules)	3.45 μ m	1/1.45"	2432 \times 2048	80 fps	Color	8/12/16 mm	A
MV-SC6016M-00C-NNN/V2	VM Platform (Including deep learning modules)	3.45 μ m	1/2.53"	1408 \times 1024	120 fps	Mono	/	B
MV-SC6016C-00C-NNN/V2	VM Platform (Including deep learning modules)	3.45 μ m	1/2.9"	1408 \times 1024	120 fps	Color	/	B
MV-SC6050M-00C-NNN/V2	VM Platform (Including deep learning modules)	3.45 μ m	1/1.45"	2432 \times 2048	80 fps	Mono	/	B
MV-SC6050C-00C-NNN/V2	VM Platform (Including deep learning modules)	3.45 μ m	1/1.45"	2432 \times 2048	80 fps	Color	/	B
MV-SC6120M-00C-NNN/V2	VM Platform (Including deep learning modules)	3.45 μ m	1/1.1"	4096 \times 2944	40 fps	Mono	/	B
MV-SC6120C-00C-NNN/V2	VM Platform (Including deep learning modules)	3.45 μ m	1/1.1"	4096 \times 2944	40 fps	Color	/	B
MV-SC6250M-00C-NNN	VM Platform (Including deep learning modules)	2.5 μ m	1/1.1"	5120 \times 5120	20 fps	Mono	/	B

Dimension

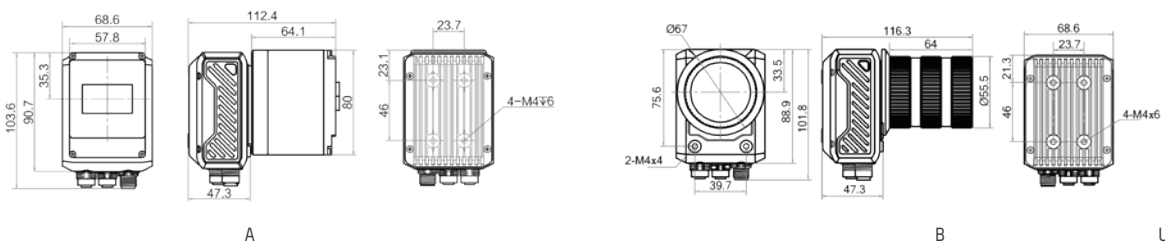

List of Smart Camera Accessories

I/O Power Cables	Adaptation Series														
	SC2000E			SC2000A		SC3000			SC3000X/SC5000X			SC6000			
	Standard	High Flex	Bend	Standard	Bend	Standard	High Flex	Bend	Standard	High Flex	Bend	Standard	High Flex	Bend	
1m	×	×	×	√	√	×	×	×	×	×	×	×	×	×	
3m	√	√	√	×	×	√	√	√	√	√	×	√	√	√	
5m	√	√	√	×	×	√	√	√	√	√	√	√	√	×	
7m	√	√	×	×	×	√	√	×	√	×	×	√	√	×	
10m	√	√	√	×	×	√	√	√	√	√	×	√	√	×	
15m	√	√	×	×	×	√	√	×	√	×	×	√	√	×	
20m	×	×	×	×	×	×	×	×	×	√	×	×	×	×	
30m	×	×	×	×	×	×	×	×	√	×	×	×	×	×	

Gigabit Ethernet Cable	Adaptation Series								
	SC1000/SC2000E/SC2000A/SC3000			SC3000X/SC5000X			SC6000		
	Standard	High Flex	Bend	Standard	High Flex	Bend	Standard	High Flex	Bend
1m	√	×	×	×	×	×	×	×	×
3m	√	√	√	√	√	×	√	√	√
5m	√	√	√	√	√	√	√	√	√
7m	√	√	×	√	×	×	√	×	×
10m	√	√	×	√	√	×	√	√	×
15m	√	√	√	√	×	×	√	×	×
20m	×	×	×	×	√	×	×	√	×
30m	√	√	×	√	×	×	√	×	×

Power Supply	Adapter	Switching Power Supply	Adaptation Series						
			SC1000	SC2000E	SC2000A	SC3000	SC3000X	SC5000X	SC6000
12V	√	√	√	√	×	×	×	×	×
24V	√	√	√	√	√	√	√	√	√

Lens Cover	Adaptation Series							
	SC1000	SC2000E	SC2000A	SC3000	SC3000X	SC5000X	SC6000	
Transparent	√	√	×	√	√	√	√	
Semi-polarization	×	×	×	√	√	×	×	
Polarization	×	√	√	√	√	√	√	
Diffusion	×	×	×	√	√	×	×	
Magnification	×	×	×	√	√	×	×	
Light uniformity	×	×	×	×	√	×	√	
YAG Guard	×	×	×	×	√	√	√	
ESD Guard	×	×	×	×	√	√	√	

Other Accessories	Adaptation Series							
	SC1000	SC2000E	SC2000A	SC3000	SC3000X	SC5000X	SC6000	
Display Extension Line	×	×	×	×	×	×	√	
Touch Screen	√	√	√	√	√	√	√	
Bracket	√	√	×	√	√	√	√	
IO Box	×	√	×	√	×	×	×	
M-mount(6/8/12/15/16/25mm)	×	√	×	√	√	√	√	
C-mount(6/8/12/16/25/35/50mm)	×	×	×	×	×	×	√	
Lamp Panel (white/blue/red/near-infrared)	×	×	×	√	√	√	√	
Extended Light Source	×	×	×	×	×	√	√	

SCMVS Client

SCMVS client is an application software independently developed by HIKROBOT for smart cameras. It supports visual detection of images acquired by the device in real time or imported into the device, and can edit, manage and store the device scheme, which can meet the requirements of various machine vision applications such as positioning, measurement, recognition and deep learning applications.

Performance Characteristics

- Support multiple platforms, compatible with Windows7/10 32/64 bit operation system.
- Simple interaction, facilitated the process of configuration mode, and only four steps to complete the plan to build.
- Support interface data statistics and camera operation monitoring.
- Support I/O, communication, time calibration, firmware upgrades, passwords and other settings.
- Support a key set camera parameters, automatically adjust the brightness focus and white balance.
- Support query operating log, equipment storage and import pictures.

SCMVS

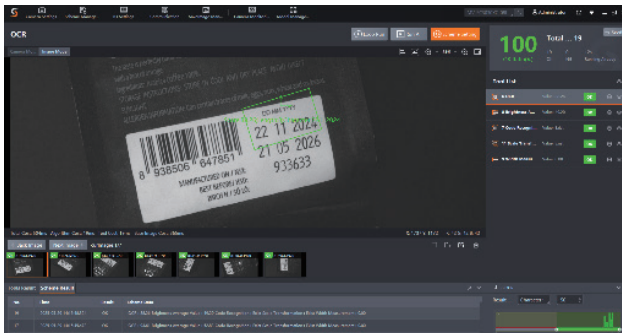

Detection Interface

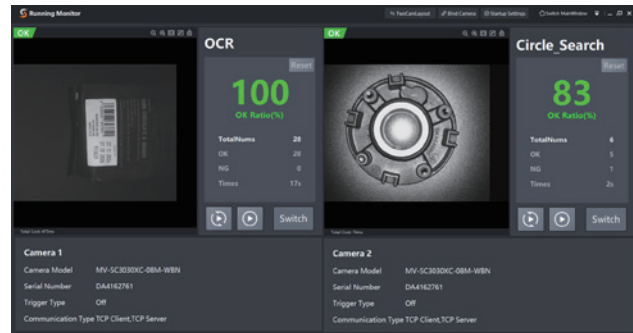

Run Monitoring Interface

Download



SCMVS client can be downloaded by visiting the website of Hikrobot.
<https://www.hikrobotics.com/en/machinevision/service/download?module=0>

■ Selection Guide of Smart Camera

Step 1: Select Camera Type

The smart camera with M-mount lens and light source

The smart camera integrated with M-mount lens and light source, easy to use. Automatic adjustment without complex operation.



The smart camera with C-mount

The smart camera with C-mount can be used with the C-mount lens that is determined by the field of view and the working distance.



Step 2: Select Camera Adjustment Method

Focus Adjustment

Select the type of smart camera according to the demands. Refer to the specification of the smart camera for the details of working distance and field of view.

SC1000 Series <ul style="list-style-type: none"> Fixed focus Fixed working distance and field of view 	SC2000E Series <ul style="list-style-type: none"> Manual focus Changeable working distance and field of view
SC3000X Series SC5000X Series SC6000-00M Series <ul style="list-style-type: none"> Auto focus Changeable working distance and field of view 	SC6000-00C Series <ul style="list-style-type: none"> Manual focus Changeable working distance and field of view

Step 3: Select Camera Capability Set

Algorithm Capability Set

Select the type of smart camera according to the application and detection requirements.

Function	Camera	SC1000 Series	SC2000E Series	SC3000X Series	SC5000X Series	SC6000 AI
		Mono/Color	Mono/Color	Mono/Color	Mono/Color	Mono/Color
Count	Spot Count	√	√	√	√	√
	Edge Count	√	√	√	√	√
	Pattern Count	X	√	√	√	√
	Contour Count	√	√	√	√	√
Existence	Circle Existence	√	√	√	√	√
	Line Existence	√	√	√	√	√
	Spot Existence	√	√	√	√	√
	Edge Existence	√	√	√	√	√
Measurement	Pattern Existence	X	√	√	√	√
	Contour Existence	√	√	√	√	√
	Color Size	X	√	√	√	√
	L2L Angle	√	√	√	√	√
	Diameter Measurement	√	√	√	√	√
	Brightness Analysis	√	√	√	√	√
	Contrast Measurement	√	√	√	√	√
	Width Measurement	√	√	√	√	√
	P2L Measurement	√	√	√	√	√
	Greyscale Size	√	√	√	√	√
Recognition	Line Angle	√	√	√	√	√
	Edge Width Measurement	√	√	√	√	√
	OCR	X	√	√	√	√
	DL Character Locating	X	√	√	√	√
	Classification Registration	√	√	√	√	√
	Object Detection Registration	X	X	√	√	√
	Register Segmentation	X	X	X	√	√
	Color Contrast	X	√	√	√	√
	Code Recognition	X	X	√	√	√
	Color Recognition	X	√	√	√	√
Location	Match Calibration	X	X	√	√	√
	Match Location	X	X	√	√	√
	Position Fixture	√	√	√	√	√
Logic Tool	If Module	X	X	√	√	√
	Condition judge	√	√	√	√	√
	Logic Judge	√	√	√	√	√
	Combination Judge	X	X	√	√	√
	Character Comparison	X	√	√	√	√
Defect Detection	Calculator	√	√	√	√	√
	Exception Detection	X	X	√	√	√
Deep Learning	DL Object Detection	X	X	√	√	√
	DL Classification	X	X	√	√	√
	DL Image Segmentation	X	X	X	√	√

Step 4: Select Algorithm Performance

Different AI Algorithm Performance

Select the type of smart camera according to the production cycle time.

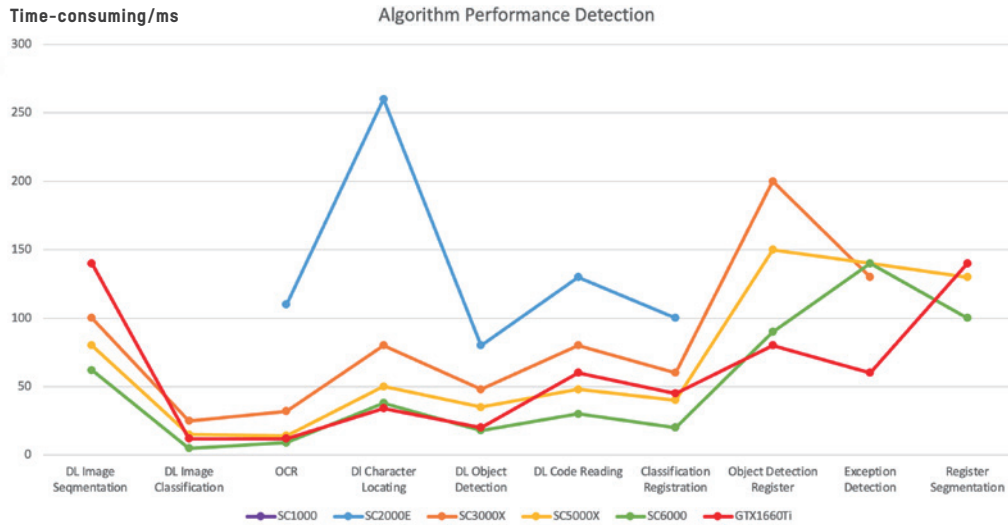

Step 5: Select Hardware

There is a limit to the number of modules that can be created for each type of camera.

Select the type of smart camera according to the application and detection requirements.

Project	Camera	SC1000 Series	SC2000E Series	SC3000X Series	SC5000X Series	SC6000 Series
Module Quantity Limit		20	40	40	1024	1024
Solution Quantity Limit		8	8	32	No Limit*	No Limit*
Image Saving in Camera		×	×	√	√	√
Image Saving via FTP		√	√	√	√	√

No Limit*: It is related to the size of the single solution and camera storage space. The solution quantity will not be limited.

Image Saving in Camera: The images will be saved in the camera without using space on the external device.

Image Saving via FTP: The images will be saved in the external device via FTP communication, that takes up space on the external device.

■ Performance and Application of Smart Code Reader

Background

In the industrial application scenario, barcode marking is a very important information storage medium, mainly applied to product information, supply chain information, production information and transportation information marking. Information collection is the basis for the formation of industrial IOT, and the acquisition of barcode information is often realized by means of code readers. In industrial scenes, the uncontrollable quality of coding, fast beat, high reading rate requirements, and harsh external use environment are the factors that determine higher requirements for industrial code reader products.



Key Features

- Rich product models, covering 0.4-25MP resolutions
- Built-in deep learning code reading algorithm, models trained by a large number of samples
- Millisecond reading efficiency, easy to cope with high-speed reading scenarios
- Support mainstream industrial communication protocols, system data interfacing more easily and stably
- Deep optimization for difficult codes to achieve over 99.95% read rate in complex scenarios
- IP65 or higher protection level, high-strength anti-drop and anti-drip design, to meet the harsh industrial application scenarios

Performance

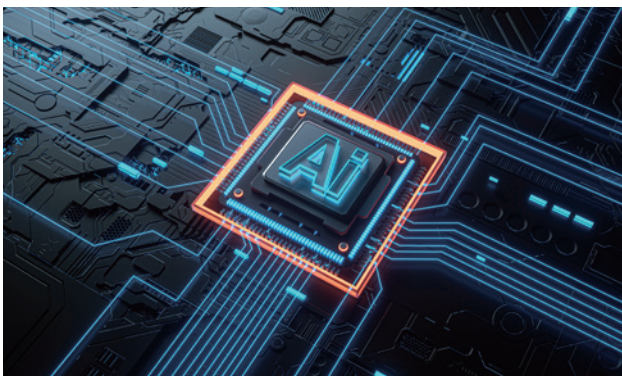

• **AI support:** An embedded platform equipped with powerful AI capabilities, combined with deep learning technology, significantly improves code reading efficiency

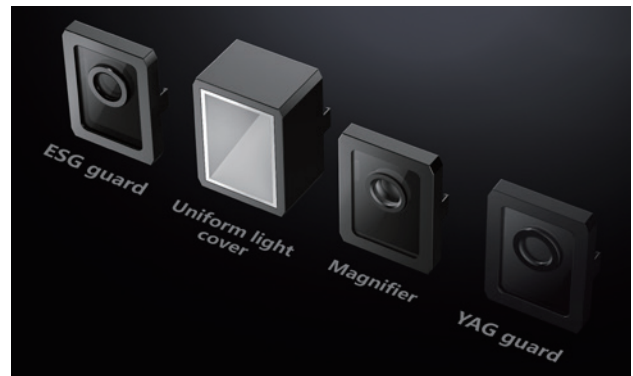

• **Strong adaptability:** providing a variety of product accessories to cope with complex industrial environments



• **Strong usability:** supports coding rating and intelligent parameter adjustment

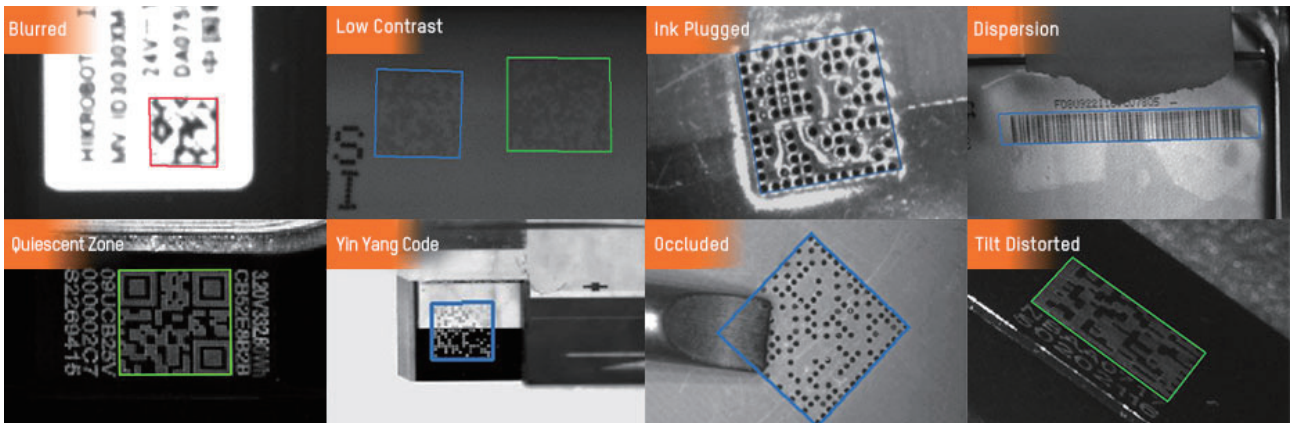

- **Strong robustness:** built-in deep learning decoding algorithm, million level sample model, capable of adapting to various complex working conditions

Industry Cases

Lithium Industry

Battery cell code reading on blue tape



Reading rate: > 99.99%

Battery top cover reflective laser-engraved code reading

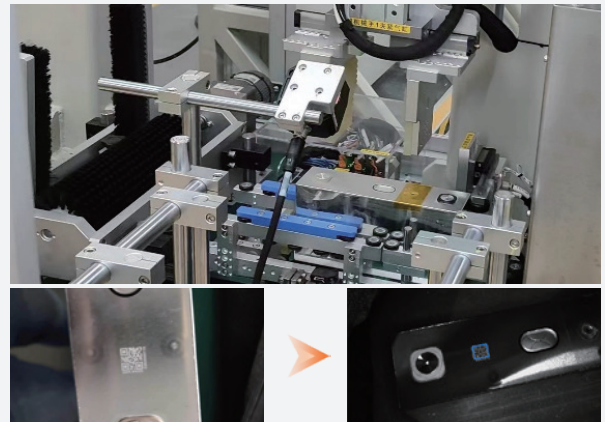

Reading rate: > 99.99%

Battery top cover reflective small code batch reading in turnover boxes



Reading rate: > 99.99%

Dirty wear and low contrast barcode reading on logistics line pallet



Reading rate: > 99.99%

Photovoltaic Industry

Silicon rod 2D code reading

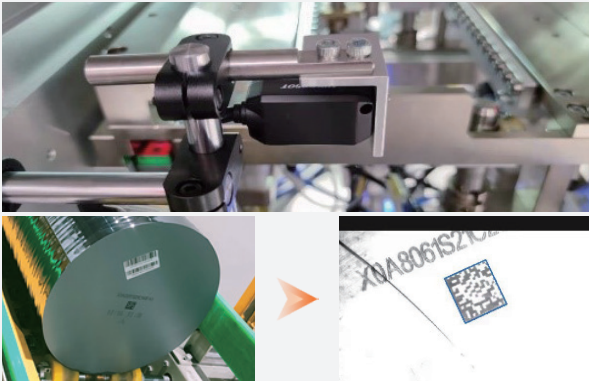

Reading rate: > 99.9%

Reflective PV module frosted rectangular code reading

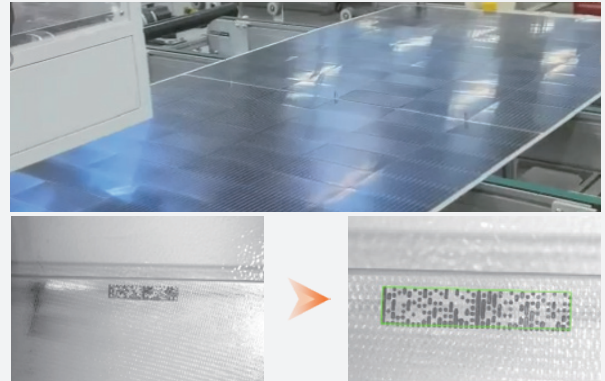

Reading rate: > 99.9%

Distorted code reading on covered PV module



Reading rate: > 99.9%

Code 128 reading on PV module backboard



Reading rate: > 99.9%

Automotive Industry

High-speed reading of distorted reflective and low-contrast codes on ECU cover

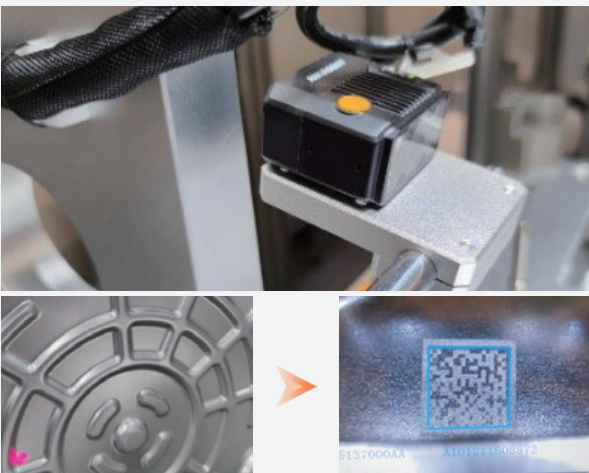

Reading rate: > 99.9%

Greasy dirt gear DPM code reading

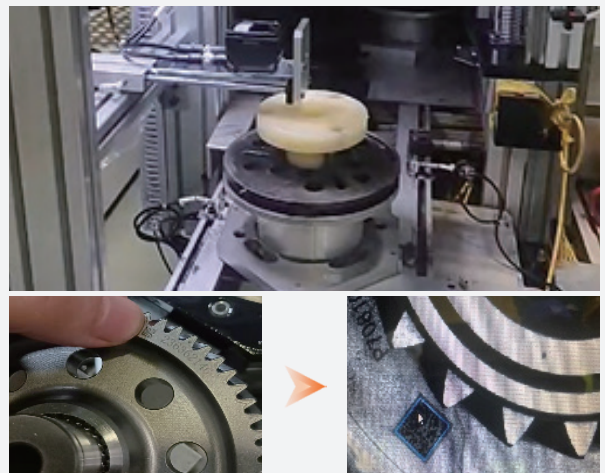

Reading rate: > 99.9%

Automotive casting part code reading with multi-DOF

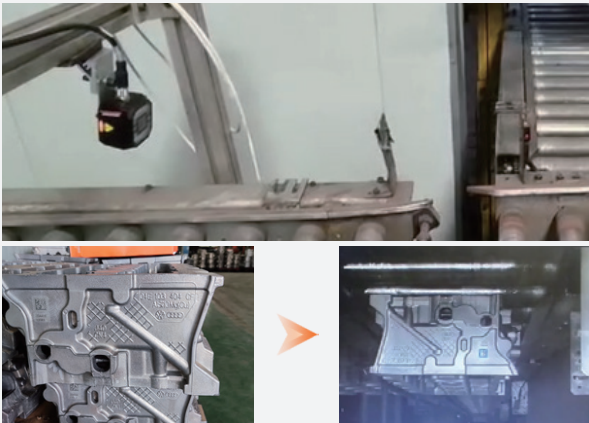

Reading rate: > 99.9%

Full view tyre code reading

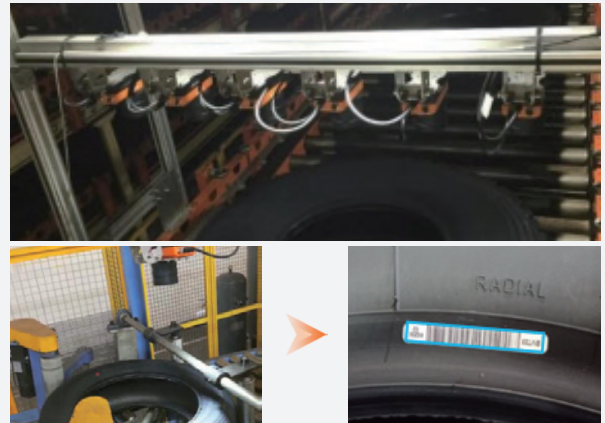

Reading rate: > 99.9%

PCB Industry

Small size code reading on PCB board with large FOV

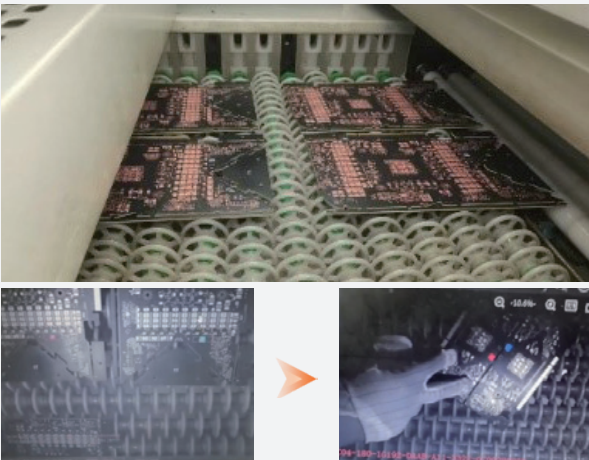

Reading rate: > 99.5%

Code reading on multi-background color PCB board

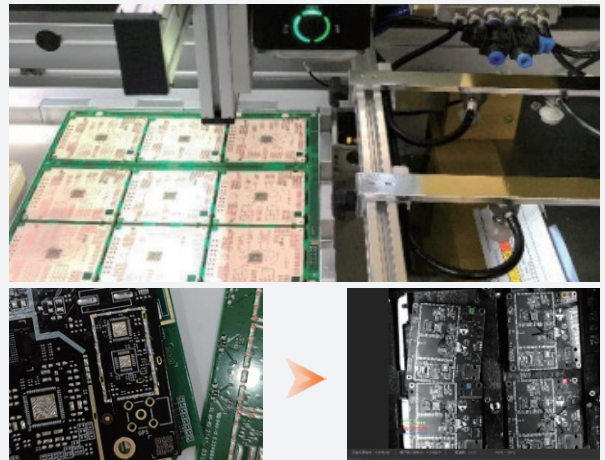

Reading rate: > 99.9%

Code batch reading in the PCB tray with large FOV

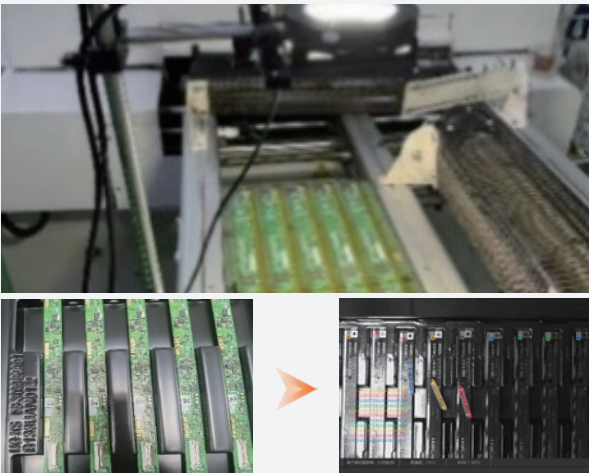

Reading rate: > 99.9%

Code reading on film cover PCB board

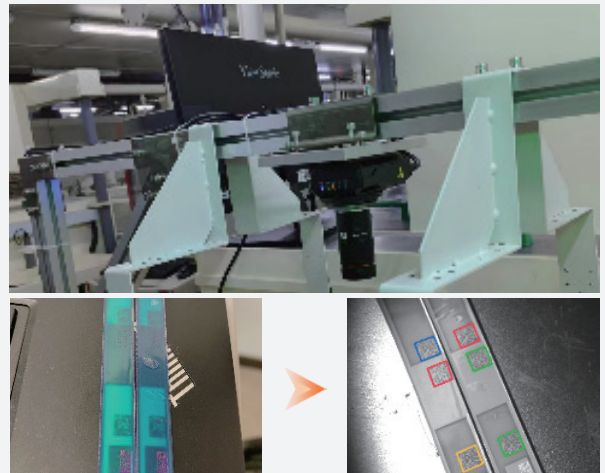

Reading rate: > 99.9%

Consumer Electronics Industry

Small size code reading on Type-C Label

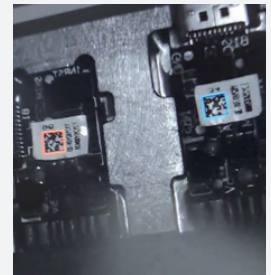
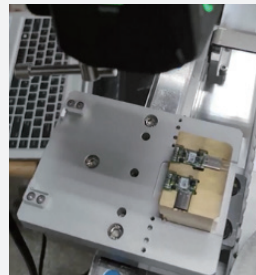
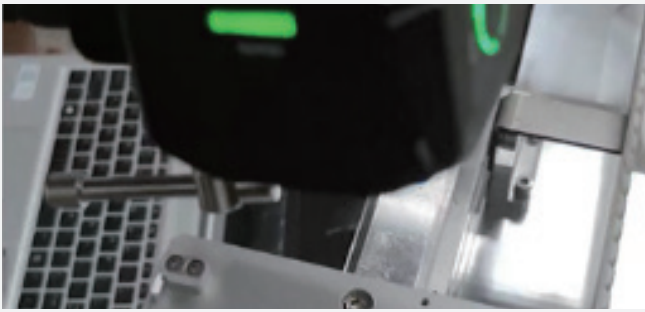

Reading rate: > 99.9%

Consumer electronic parts batch code reading

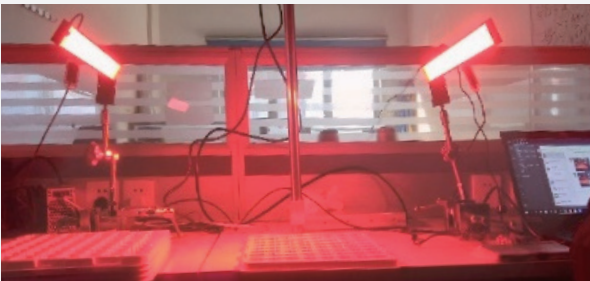

The maximum number of identifiable codes in a image: 200 pcs

Smart phone package code reading with large FOV

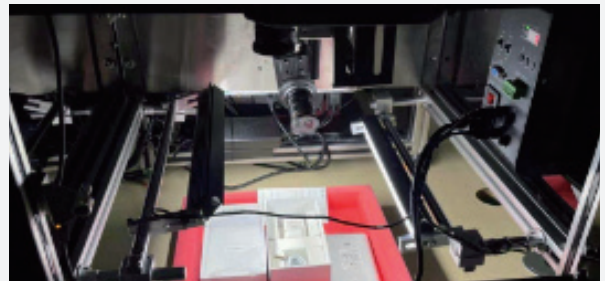

Recognize multiple types of barcodes at one time

Logistics Industry

Shoe box code reading with large FOV

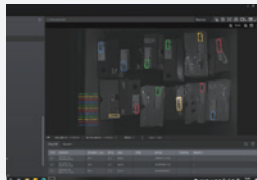

Reading rate: > 99.9%

Distorted and folded barcode reading on parcel



Reading rate: > 99.9%

Five-sided scanning solution of airport baggage claim

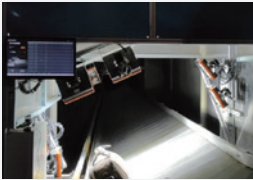
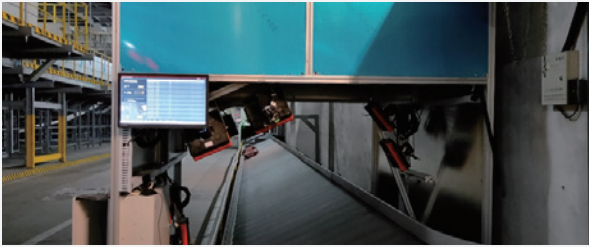

Reading rate: > 99%

Enterprise warehousing corridor code reading



Code reading door solution

Food & Medicine Industry

High-speed reading of distorted reflective and low-contrast codes on soy sauce bottle cap

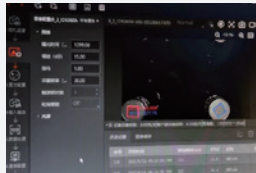

Reading rate: > 99%

Medicine tote code reading from multiple angles

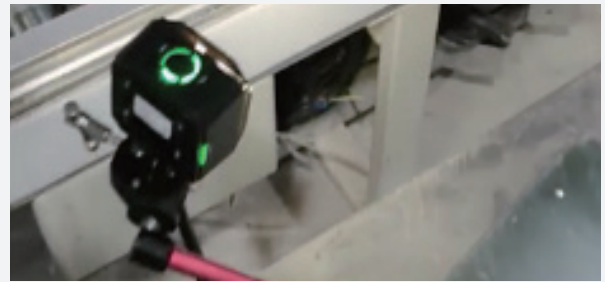

Reading rate: > 99%

Medical Industry

Test tube bottom code batch reading



Quick identification within 15 seconds, output in order

Code 128 reading of medical test tube

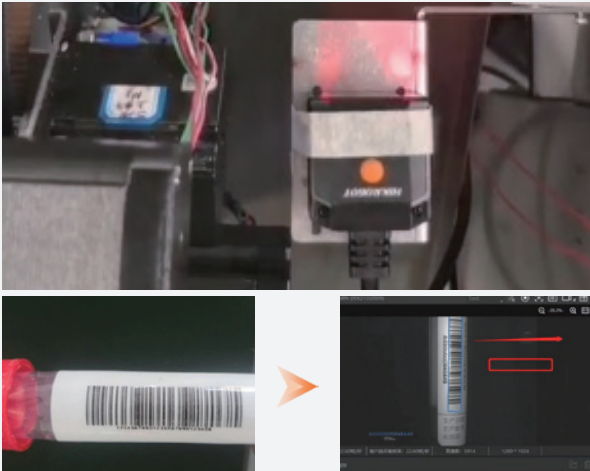

Reading rate: > 99.9%

Danamic rotation analyzer code reading

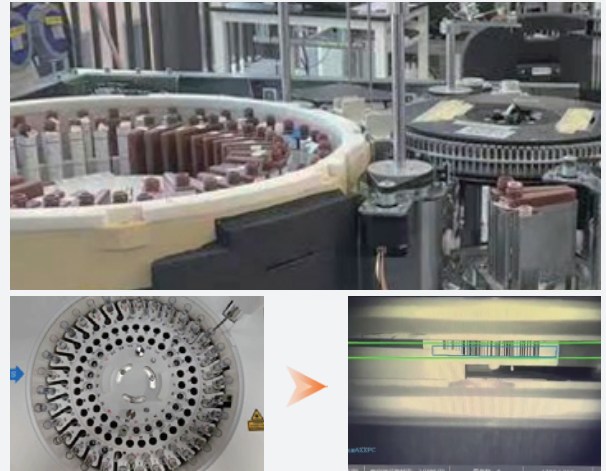

Reading rate: > 99.9%

Batch code reading and output the coordinates of unrecognized

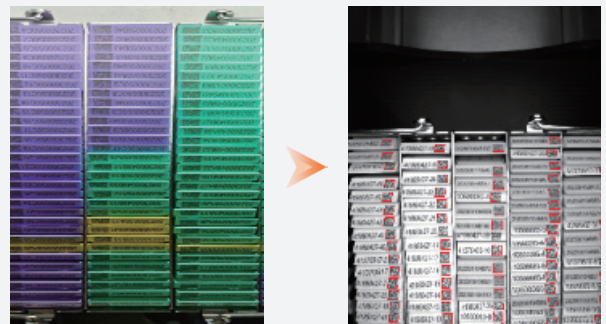
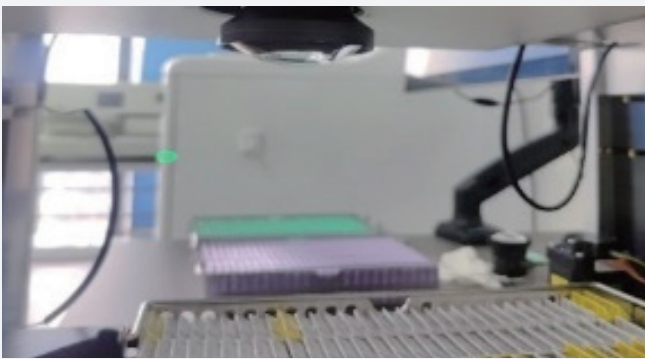

Reading rate: > 99.9%

Other Industries

Large FOV code reading in glass industry

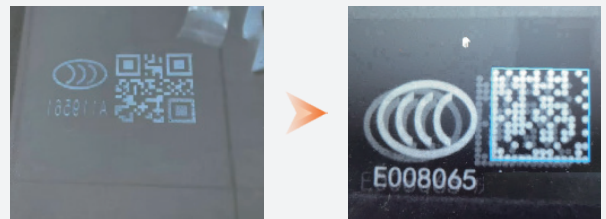

Reading rate: > 99.9%

High-speed code reading in printing industry

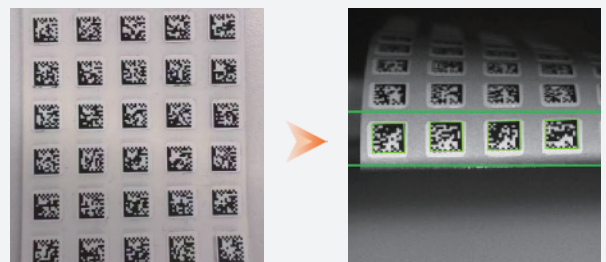
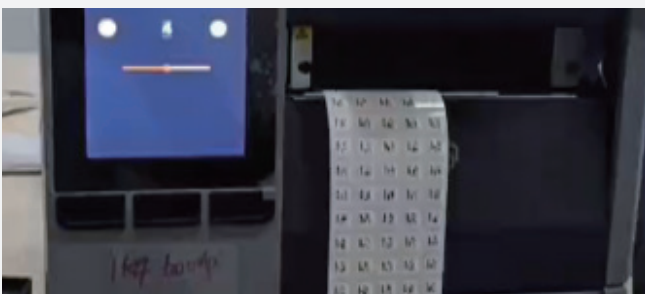

Recognize and output 75 codes per second

Smart Code Reader



ID800 Series Industrial Code Reader

As a compact industrial barcode reader, ID800 series can decode different codes rapidly, such as on-screen codes or codes on the label, and be applicable to retail, medical treatment, intelligent manufacturing, enterprise and public institutions.

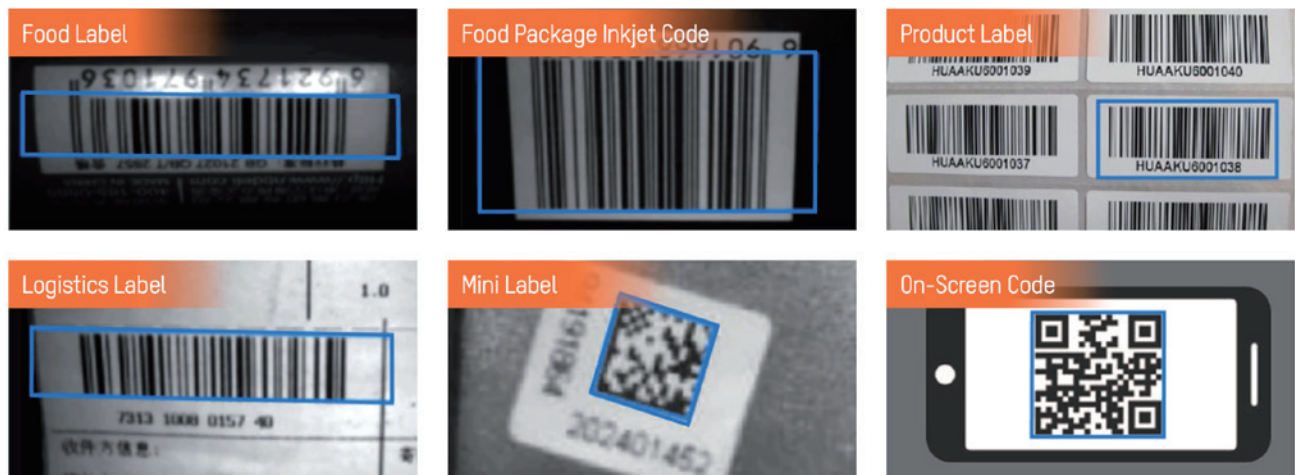

- Supports the identification of different codes, such as on-screen codes or codes on the label

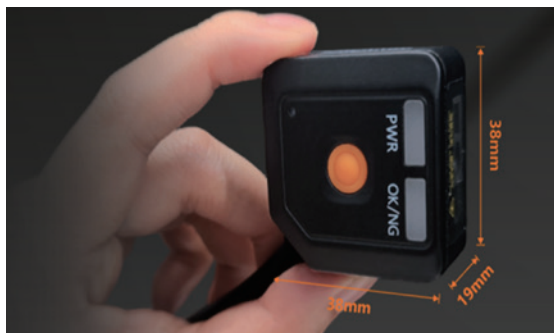

Dimension

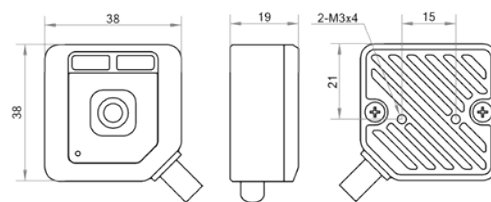

PS: Cable bending space 30mm

Unit:mm

- Ultra-compact size and ease of use

Specifications



Model	Resolution	Max. frame rate	Max. reading speed	Light source	Max. power consumption	Focal length	Data interface
MV-ID803M-03S-WBN-SR-U	640 × 480	60 fps	15 codes/sec	Warm white LED	2.5 W@5 VDC	3.1 mm	USB2.0
MV-ID803M-03S-WBN-SR-R	640 × 480	60 fps	15 codes/sec	Warm white LED	2.5 W@12 VDC	3.1 mm	RS-232
MV-ID813M-05S-WBN-SR-U	1280 × 1024	60 fps	20 codes/sec	Warm white LED	2.5 W@5 VDC	4.9 mm	USB2.0
MV-ID813M-05S-WBN-SR-R	1280 × 1024	60 fps	20 codes/sec	Warm white LED	2.5 W@12 VDC	4.9 mm	RS-232
MV-ID813M-05S-WBN-NR-U	1280 × 1024	60 fps	20 codes/sec	Warm white LED	2.5 W@5 VDC	4.9 mm	USB2.0
MV-ID813M-05S-WBN-NR-R	1280 × 1024	60 fps	20 codes/sec	Warm white LED	2.5 W@12 VDC	4.9 mm	RS-232

Smart Code Reader



ID2000 Series Industrial Code Reader

As a compact industrial barcode reader, ID2000 series can be embedded in automated machine equipment and other automated assembly line proximity barcode reading applications. Support common 1D, 2D and DPM codes, the patented lighting design provides high-quality image lighting.

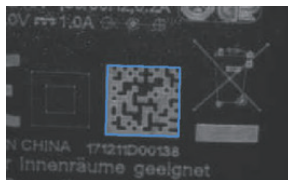

Inkjet DM Code



Product Label

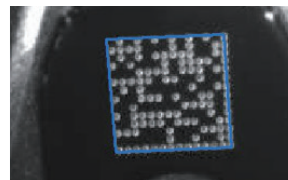

Metal Lattice DPM Code



Food Package Inkjet Code

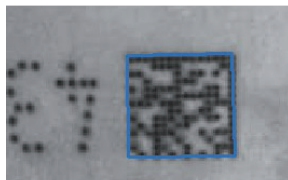

Copper plate DPM Code



Logistics Label

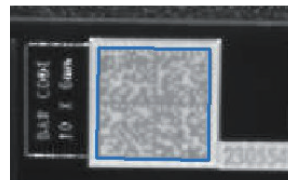

Low-contrast DPM Code



Mini Label

- Supports recognition of various 1D and 2D codes and laser engraving, inkjet and other types of DPM codes, providing efficient and reliable code reading performance

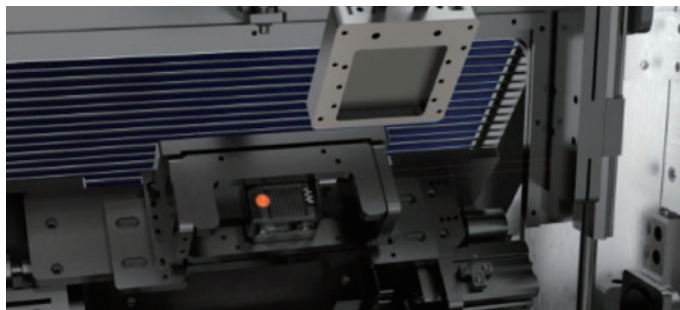

- Extremely small size, can be freely installed in a small space

Specifications



Model	Resolution	Max. frame rate	Max. reading speed	Light source	Max. power consumption	Focal length	Working/Focus distance	Label
MV-ID2004M-06S-xBN	704 × 540	60 fps	41 codes/sec	White/Red/Blue	3.8 W@24 VDC	6.72 mm	40-120 mm, manually focus	A
MV-ID2004M-06S-xBN-U	704 × 540	60 fps	38 codes/sec	White/Red/Blue	4.6 W@5 VDC	6.72 mm	40-120 mm, manually focus	A
MV-ID2004M-16T-RBN	704 × 540	60 fps	45 codes/sec	Red	4 W@12 VDC	16 mm	100 ~ 400 mm	B
MV-ID2013EM-03N-Rby	1280 × 1024	50 fps	30 codes/sec	Red/Polarized	2.5 W@12 VDC	2.45 mm	/	C
MV-ID2013EMI-05-xBy(-U/-S/-SU)	1280 × 1024	50 fps	30 codes/sec	White/Red/Polarized	2.5 W@5 VDC	4.7 mm	/	C
MV-ID2013EMI-05N-xBy(-U/-S/-SU)	1280 × 1024	50 fps	30 codes/sec	Red/Polarized	2.5 W@12 VDC	4.7 mm	/	C
MV-ID2013EMI-05H-xBy(-U/-S/-SU)	1280 × 1024	50 fps	30 codes/sec	Red/Polarized	2.5 W@12 VDC	4.7 mm	/	C
MV-ID2013M-06S-xBy(-YA6)	1280 × 1024	60 fps	45 codes/sec	White/Red/Blue/Polarized	10.6 W@24 VDC	6.72 mm	40-120 mm, manually focus	A

Model	Resolution	Max. frame rate	Max. reading speed	Light source	Max. power consumption	Focal length	Working/Focus distance	Label
MV-ID2013M-16S-RBN(-YA6)	1280 × 1024	60 fps	45 codes/sec	Red	24 W@12 VDC	16 mm	105 - 150 mm, manually focus	D
MV-ID2013M-25S-RBN(-YA6)	1280 × 1024	60 fps	45 codes/sec	Red	24 W@12 VDC	25 mm	170 - 200 mm, manually focus	D
MV-ID2016M-06S-xBN	1408 × 1024	60 fps	45codes/sec	White/Red/Polarized	3.8 W@24 VDC	6.72 mm	40-120 mm, , manually focus	A
MV-ID2016M-06S-xBN-U	1408 × 1024	60 fps	45codes/sec	White/Red	4.6 W@5 VDC	6.72 mm	40-120 mm, manually focus	A
MV-ID2016M-06T-RBP	1408 × 1024	60 fps	45 codes/sec	Red/Polarized	4 W@12 VDC	6.7 mm	70-160mm	B
MV-ID2023XM-**M-RBN*	1920 × 1280	60 fps	60codes/sec	White/Red/Blue/IR/UV	12 W@24 VDC	5/8/12/16 mm	15 - 1000 mm, manually focus	E
MV-ID2023XM-**M-RBN-U*	1920 × 1280	60 fps	60codes/sec	White/Red/Blue/IR/UV	12 W@24 VDC	5/8/12/16 mm	15 - 1000 mm, manually focus	E
MV-ID2023XM-**L-RBN*	1920 × 1280	60 fps	60codes/sec	White/Red/Blue/IR/UV	12 W@24 VDC	5/8/12/16 mm	15 - 1000 mm, manually focus	E
MV-ID2023XM-**L-RBN-U*	1920 × 1280	60 fps	60codes/sec	White/Red/Blue/IR/UV	12 W@24 VDC	5/8/12/16 mm	15 - 1000 mm, manually focus	E

Notice: *New Release. x=W represents a white light source, x=R represents a red light source, x=B represents a blue light source, y=P represents polarization, and y=N represents unpolarized. **products with different focal Lengths

Dimension

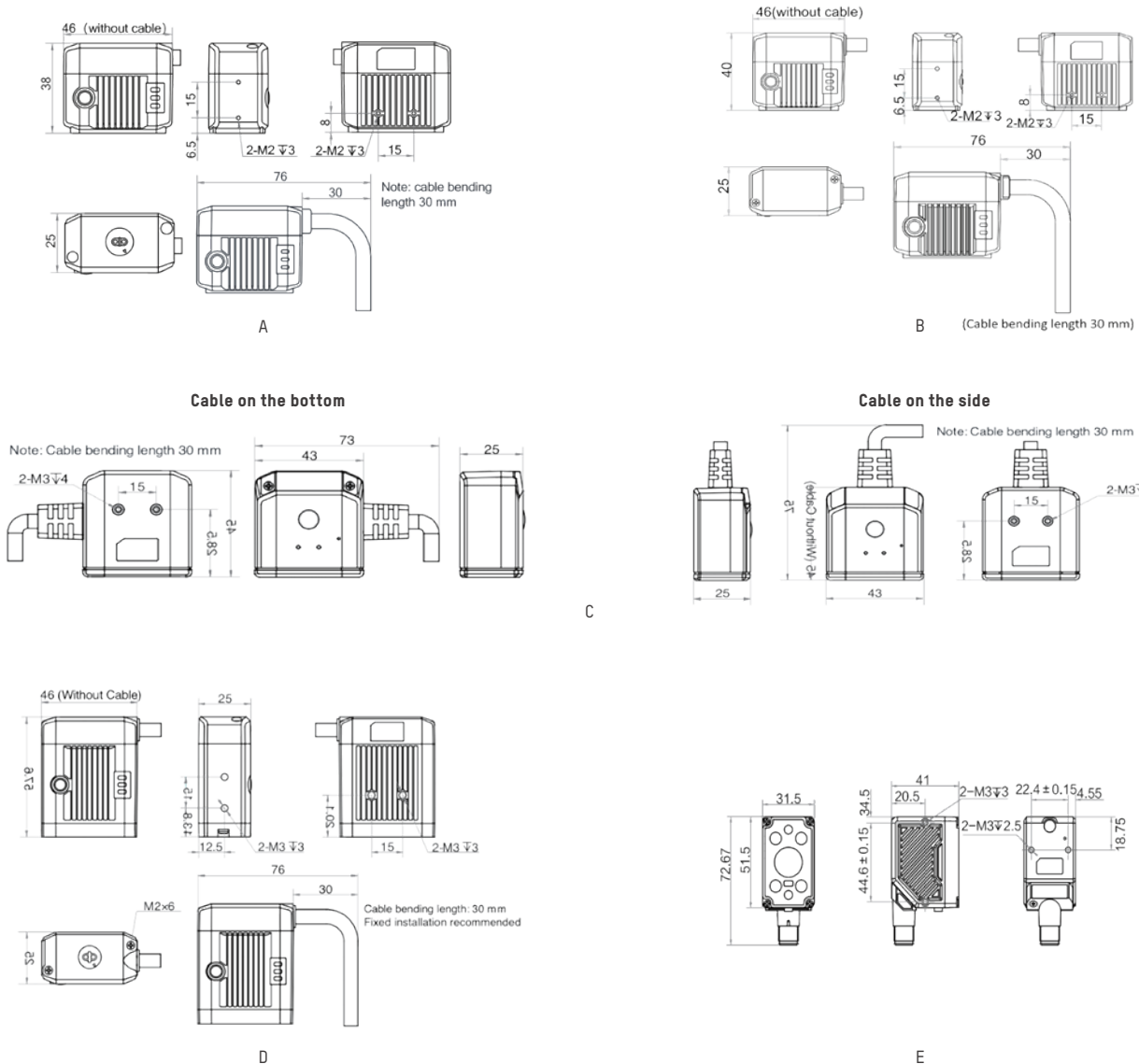

Unit:mm

Smart Code Reader



ID3000 Series Industrial Code Reader

Based on the embedded deep-learning platform, ID3000 adopt compact & modular design. With easy debugging (mechanical focusing), automatic polarization function and controllable light source branching, ID3000 can be widely used in various code reading scenarios.

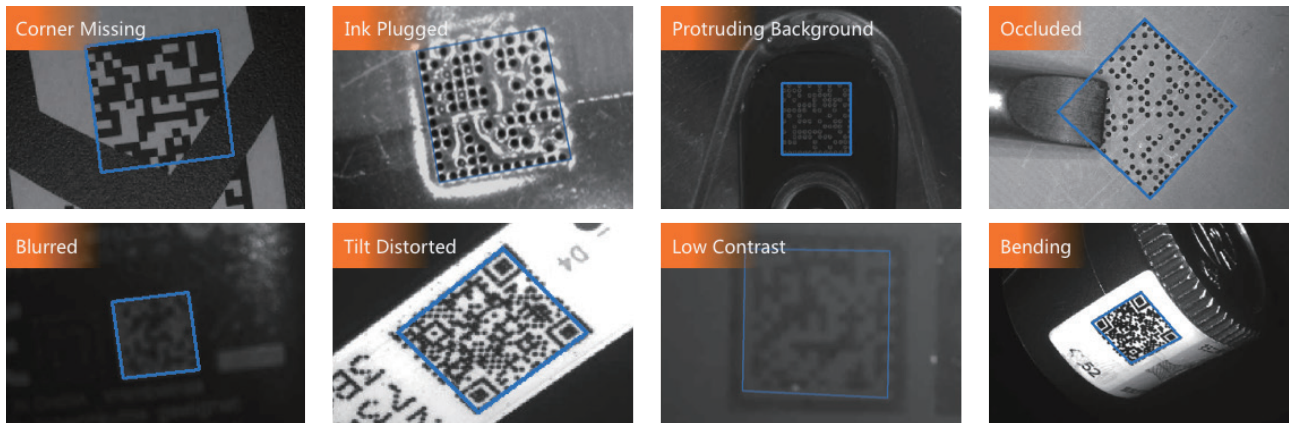

• Out-standing code reading effect



• Three ways of multiple optical lighting, with strong environmental adaptability

Specifications



Model	Resolution	Max. frame rate	Max. reading speed	Light source	Max. power consumption	Focal length	Label
MV-ID3013PM	1280 × 1024	60 fps	84 codes/sec	Focused white light, optional focused red/blue/infrared light	20 W@24 VDC	6/12/14.8 mm	A
MV-ID3016XM	1408 × 1024	60 fps	110 codes/sec	Red point light and white diffuse light, optional point white/blue/infrared light	6.2W@24 VDC	8/12/25 mm	B
MV-ID3016XM-16L-RBN	1408 × 1024	60 fps	110 codes/sec	Red point light and white diffuse light, optional point white/blue/infrared light	6.2 W@24 VDC	16mm, liquid focus	B
MV-ID3030XM	2048 × 1536	60 fps	90 codes/sec	Red point light and white diffuse light, optional point white/blue/infrared light	6.2W@24 VDC	8/12/25 mm	B
MV-ID3030XM-16L-RBN	2048 × 1536	60 fps	90 codes/sec	Red point light and white diffuse light, optional point white/blue/infrared light	6.2W@24 VDC	16mm, liquid focus	B
MV-ID3040RM*	2688 × 1536	5 fps	60 codes/sec	Red point light and white diffuse light, optional point white/blue/infrared light	6.2W@24 VDC	8/12/16/25 mm	C
MV-ID3050PM	2432 × 2048	30 fps	60 codes/sec	Focused white light, optional focused red/blue/infrared light	10.6W@24 VDC	8/12/16/25 mm	A
MV-ID3050XM	2432 × 2048	60 fps	90 codes/sec	Red point light and white diffuse light, optional point white/blue/infrared light	6.2W@24 VDC	8/12/25 mm	B
MV-ID3050XM-16L-RBN	2432 × 2048	60 fps	90 codes/sec	Red point light and white diffuse light, optional point white/blue/infrared light	6.2W@24 VDC	16mm, liquid focus	B
MV-ID3060RM*	3200 × 1920	5 fps	60 codes/sec	Red point light and white diffuse light, optional point white/blue/infrared light	6.2W@24 VDC	8/12/16/25 mm	C

Notice: *New Release

Dimension

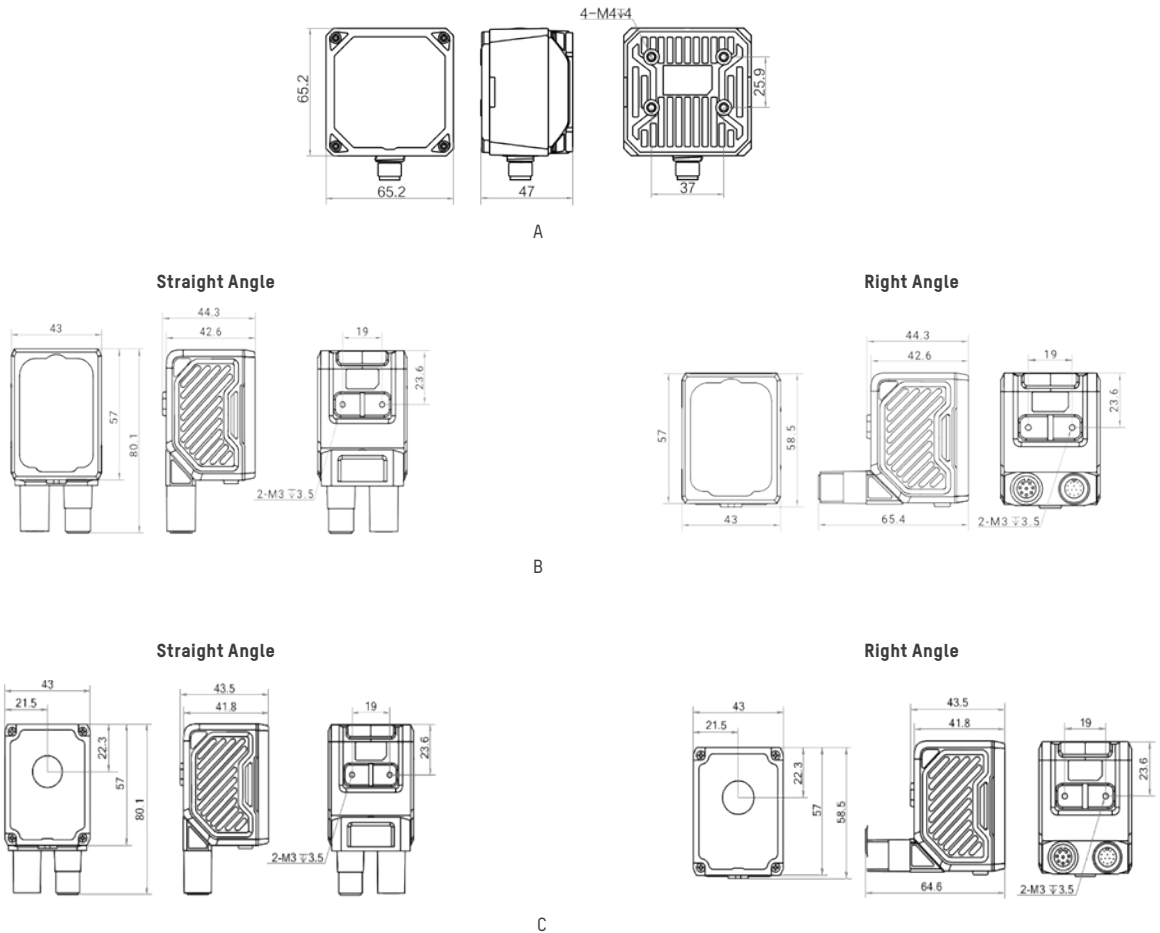

Unit:mm

Smart Code Reader



ID5000 Series Industrial Code Reader

Based on multi-core deep learning processor, the full-featured code reader brings powerful code reading performance. Equipped with mechanical focus lens and various components, ID5000 can reach up to 20M pixels, suitable for various code reading applications.

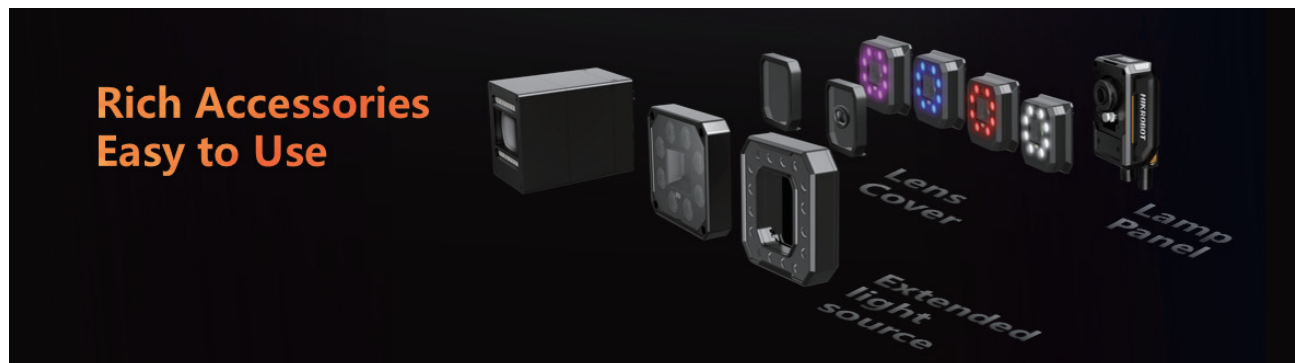

- Modular lighting, multiple lens cover to choose from, support for multiple extended light sources

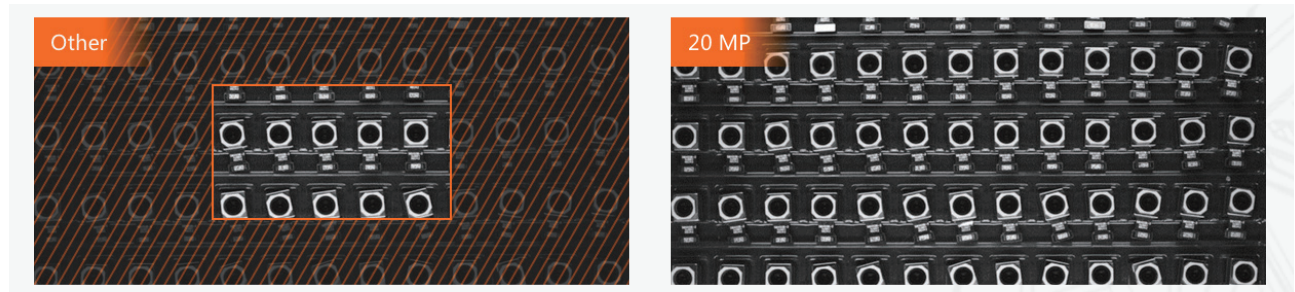

- High Accuracy & Wide View, A single ID5000 model can replace multiple code readers

Specifications



Model	Resolution	Max. frame rate	Max. reading speed	Light source	Max. power consumption	Focal length	Label
MV-ID5030M-***S-WBN	2048 × 1536	60 fps	90 codes/sec	white, optional blue/red/infrared	60 W@24 VDC	8/12/16/25 mm	A
MV-ID5030M-00C-NNN	2048 × 1536	60 fps	90 codes/sec	white, optional blue/red/infrared	20W@24 VDC	/	B
MV-ID5050M-***S-WBN	2560 × 2048	40 fps	90 codes/sec	white, optional blue/red/infrared	60 W@24 VDC	8/12/16/25 mm	A
MV-ID5050XM-***S-RBN	2432 × 2048	60 fps	96 codes/sec	red, optional blue/white/infrared	12 W@24 VDC	8/12/16/25 mm	C
MV-ID5050XM-***L-RBN	2368 × 1760	92 fps	96 codes/sec	Focused red light, optional focused white/blue/infrared light	12 W@24 VDC	8/12/16 mm	C
MV-ID5060M-***S-WBN	3072 × 2048	30 fps	90 codes/sec	white, optional blue/red/infrared	23 W@24 VDC	8/12/16/25 mm	D
MV-ID5060M-***S-RBN	3072 × 2048	30 fps	90 codes/sec	red, optional blue/white/infrared	23 W@24 VDC	8/12/16/25 mm	D

Model	Resolution	Max. frame rate	Max. reading speed	Light source	Max. power consumption	Focal length	Label
MV-ID5060M-00C-WBN	3072 × 2048	30 fps	90 codes/sec	white, optional blue/red/infrared	23 W@24 VDC	Additional purchase of C-mount lens is required	E
MV-ID5060M-00C-NNN	3072 × 2048	30 fps	90 codes/sec	/	23 W@24 VDC	Additional purchase of C-mount lens is required	B
MV-ID5120M-00C-NNN	4096 × 3072	28 fps	84 codes/sec	/	12 W@24 VDC	Additional purchase of C-mount lens is required	B
MV-ID5200M-00C-NNN	5440 × 3648	20 fps	36 codes/sec	/	12 W@24 VDC	Additional purchase of C-mount lens is required	B
MV-ID5200PM-00C-NNN	5120 × 3840	20 fps	36 codes/sec	/	12 W@24 VDC	Additional purchase of C-mount lens is required	B
MV-ID5250PM-00C-NNN	5120 × 5120	15 fps	36 codes/sec	/	12 W@24 VDC	Additional purchase of C-mount lens is required	B

Notice: **products with different focal Lengths

Dimension

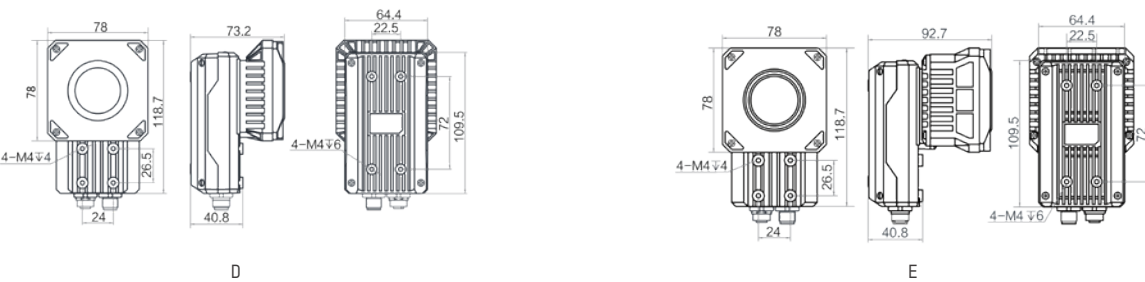
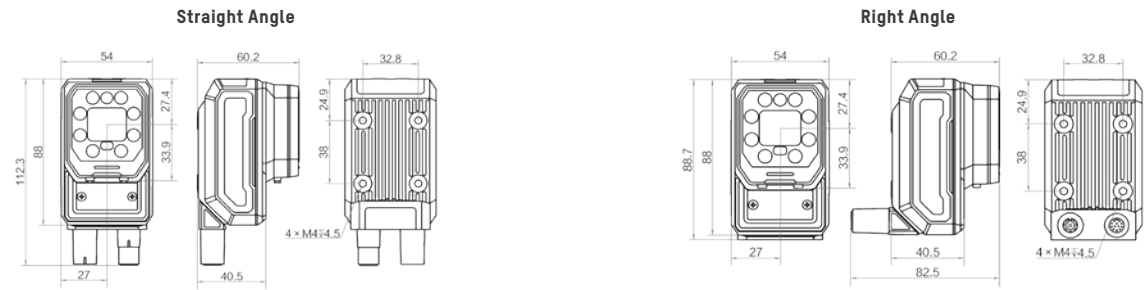
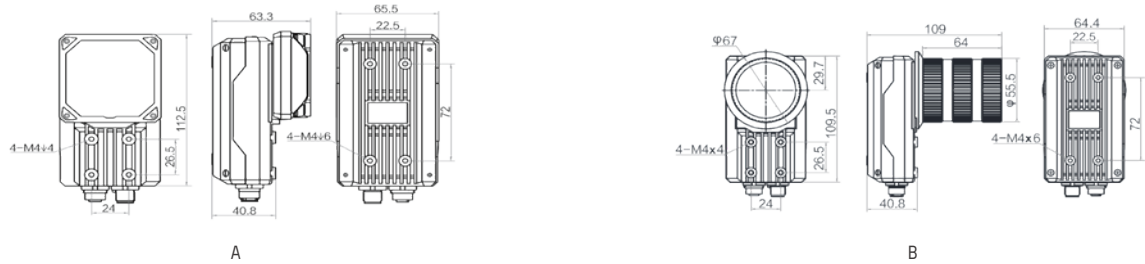

Unit:mm

Smart Code Reader

ID6000 Series Logistics Code Reader

Image-based high-resolution barcode reader ID6000 is specialized for the logistics industry. ID6000 has especially developed in algorithm development to cope with various complex logistics code reading application scenarios.



- Based on a multi-core deep learning processor, specially optimized decoding algorithm, high decoding frame rate, capable of identifying complex codes such as dirty, broken needles, and poor print quality

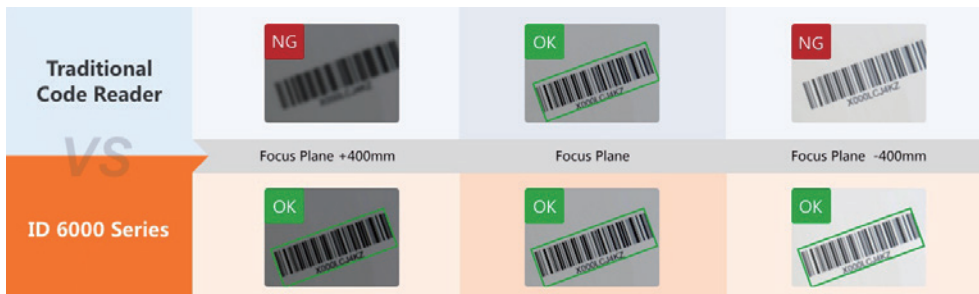

- Achieve a super-large depth of field effect of more than 700mm, and a single unit perfectly covers parcels with a height of less than 700mm commonly seen in logistics scenarios

Specifications



Model	Pixel size	Resolution	Max. frame rate	Max. reading speed	Data interface	Lens mount	Label
MV-ID6120PM-00C-NNG	3.2 μm	4000 \times 3000	28 fps	84 codes/sec	Gigabit Ethernet	C	A
MV-ID6200EM-00C-NNG	2.4 μm	5440 \times 3648	10 fps	30 codes/sec	Gigabit Ethernet	C	B
MV-ID6200M-00C-NNG	2.4 μm	5440 \times 3648	20 fps	60 codes/sec	Gigabit Ethernet	C	A

Dimension

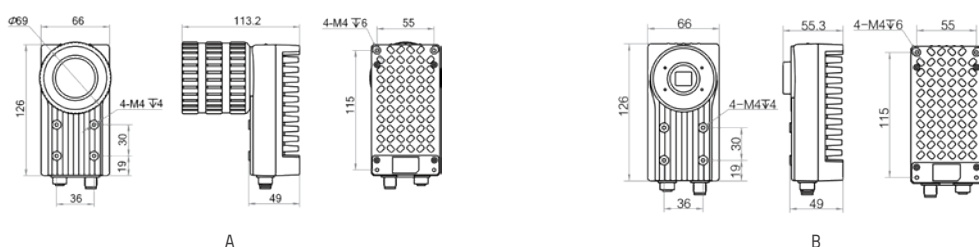

Unit:mm

Smart Code Reader

ID7000 Series Logistics Code Reader

Based on the embedded platform, ID7000 series is developed according to the application scenarios and needs of the bottom surface of the logistics industry. With 48 particles of LED light source and integrated structure design, ID7000 can realize an ultra-wide coverage.

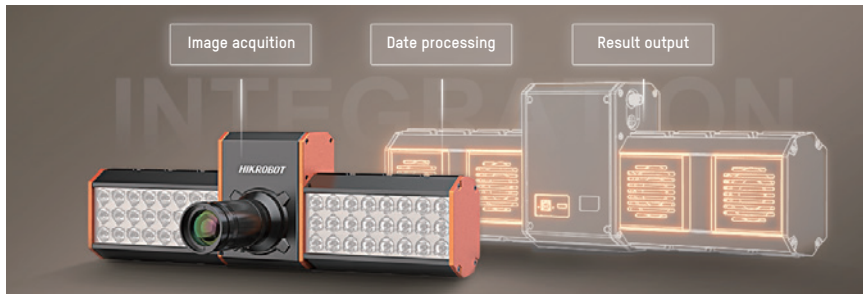

- It integrates image acquisition, data processing and result output. The 48-particle LED light source on the body constitutes the lighting system, and the 4 fans on the back constitute the cooling system

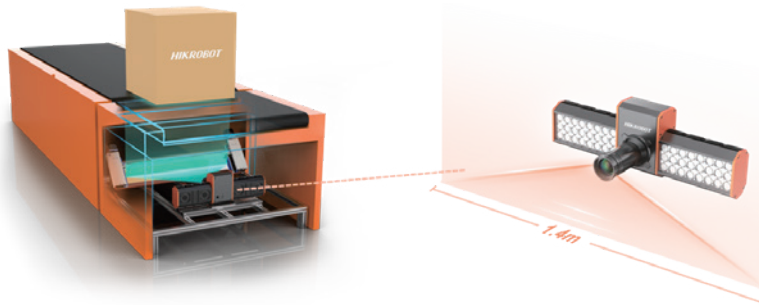

- Built-in 8K resolution linear sensor, which can cover the conveyor belt field of view up to 1.4m wide

Specifications



Model	Max. line frequency	Resolution	Data interface	Focal Length	Working distance	Field of view	Lens mount
MV-ID7080EM-35F-WHA	15 kHz	8K	Gigabit Ethernet	35 mm	1000 mm	1000 mm	F-Mount, flange back focus 46.5 mm

Dimension

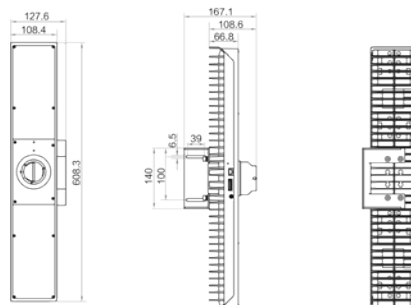

Unit:mm

Smart Code Reader

IDS Series Integration Code Reader

As the core component of a code reading device, the product is divided into two categories: standard type and smart type. The product integrates the functions of image acquisition, data processing and result output. With its features of convenient use, excellent Performance and rich supporting functions, it can be widely used in various types of code reading application scenarios.

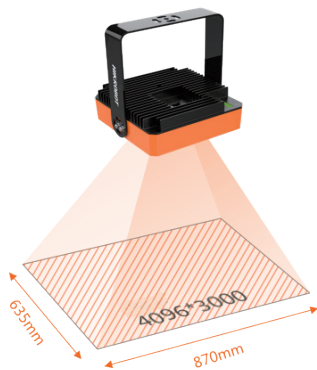

- Built-in embedded processor, integrating image acquisition, data processing, and result output functions, improving the timeliness of image data transmission and processing

Dimension

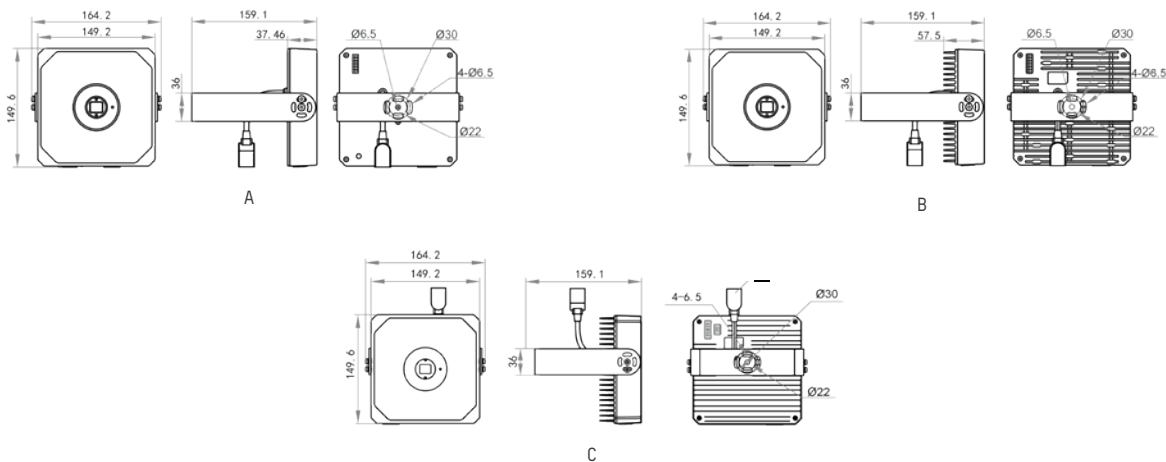

Unit:mm

Specifications



Model	Type	Max. frame rate	Resolution	Focal length	Working distance	Field of view	Depth of field	Label
MV-PD010003-06M-12C	Standard	15 fps	3072 × 2048	12 mm	900 mm	550 mm × 340 mm	500 mm	A
MV-PD010003-06C-12C	Standard	17 fps	3072 × 2048	12 mm	900 mm	550 mm × 340 mm	500 mm	A
MV-PD010003-06M-16C	Standard	17 fps	3072 × 2048	16 mm	1500 mm	550 mm × 340 mm	500 mm	A
MV-PD010003-12M-16C	Standard	9.6 fps	4024 × 3036	16 mm	1550 mm	730 mm × 550 mm	650 mm	B
MV-PD010003-12C-8C	Standard	9.6 fps	4024 × 3036	8 mm	780 mm	730 mm × 550 mm	400 mm	B
MV-IDS012M-16C-C	Smart	20 fps	3968 × 3000	16 mm	1870 mm	870 mm × 635 mm	700 mm	C

List of Code Reader Accessories

I/O Power Cables	ID1000	ID800	ID2000E		ID2000M/ID3000P			ID3000X/ID5000/ID6000			ID7000	IDS	
	Standard	Standard	Standard	High Flex	Standard	High Flex	Bend	Standard	High Flex	Bend	Standard	Standard	
Serial Port Model	1.5m	×	√	×	×	×	×	×	×	×	×	×	×
	2m	×	√	√	×	√	√	×	×	×	×	×	×
USB Model	2.5m	×	×	√	×	×	×	×	×	×	×	×	×
	3m	√	×	×	×	×	×	×	×	×	×	×	×
Network port model	3m	×	×	×	×	√	√	√	√	√	×	×	√
	3.5m	×	×	√	√	×	×	×	×	×	×	×	×
	5m	×	×	√	√	√	√	√	√	√	×	×	×
	7m	×	×	×	×	√	√	×	√	×	×	√	×
	10m	×	×	×	×	√	√	√	√	√	×	×	×
	15m	×	×	√	×	√	√	×	√	×	×	×	×
	20m	×	×	×	×	×	×	×	×	√	×	×	×
	30m	×	×	×	×	×	×	√	×	×	×	×	×

Gigabit Ethernet Cable	ID3000X/ID5000/ID6000			ID7000/IDS			
	Standard	High Flex	Bend	Standard	High Flex	Super Flex	Bend
3m	√	√	×	√	√	√	√
5m	√	√	√	√	√	√	√
7m	√	×	×	√	√	√	×
10m	√	√	×	√	√	√	×
15m	√	×	×	√	√	√	√
20m	×	√	×	×	×	×	×
30m	√	×	×	√	√	×	×
60m	×	×	×	√	×	×	×

Power Adapter	Adapter	Switching Power Supply	Adaption Series									
			ID800	ID2000	ID3000M	ID3000X	ID5000	ID6000	ID7000	IDS	IDH	
12V	√	√	√	×	×	×	×	√	×	×	×	√
24V	√	√	√	√	√	√	√	√	×	×	√	√
48V	×	√	×	×	×	×	×	×	√	×	×	×

Lens Cover	Adaption Series					
	ID3013P	ID3000X	ID5030	ID5050	ID5050X	ID5060
Transparent	√	√	√	√	√	√
Semi-polarization	√	√	√	√	√	×
Polarization	√	√	√	√	√	√
Diffusion	√	√	√	√	×	√
Magnification	√	√	√	√	×	×
Light uniformity	×	√	×	×	×	×
YAG Guard	×	√	×	×	√	×
ESD Guard	×	√	×	×	√	×

Other Accessories	Adaption Series							
	ID800	ID2000	ID3000M	ID3000X	ID5000	ID6000	ID7000	IDS
Bracket	√	√	√	√	√	×	×	×
IO Box	×	√	√	×	×	×	×	×
Lens(6/8/12/16/25/35/50mm)	×	√	×	×	√	√	√	√
Light Source Panel (white/blue/red/near-infrared)	×	×	√	√	√	×	×	×
Extended Light Source	×	×	×	×	√	√	×	×
Bottom Code Reading Mirror	×	×	×	×	×	×	√	×

Smart Code Reader

IDH2000 Series Handheld Code Reader

Compact class handheld scanner features a compact and lightweight design. Equipped with AI deep learning algorithms to easily cope with poor print quality, film – covering and bending situations. The IDH2000 series offers wired, 2.4G RF, and Bluetooth connectivity, suitable for chain retail, manufacturing, healthcare, logistics, supermarkets and asset inventory scenarios.

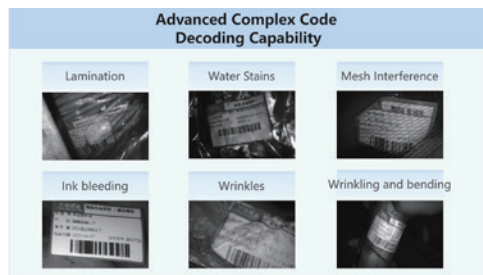
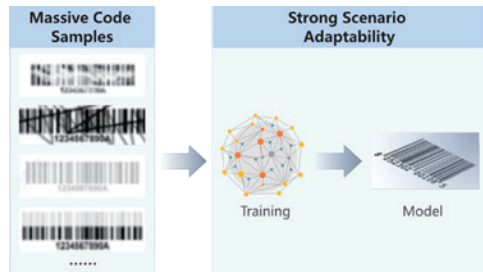

• Lightweight, compact and durable



• Multiple transmission and charging methods, flexible application

Dimension

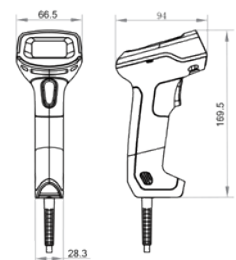

A

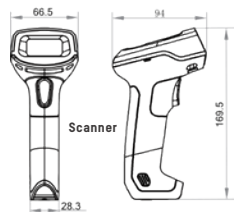

Scanner

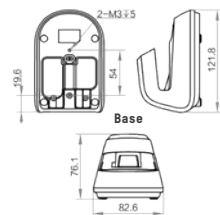

B

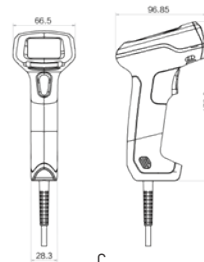

C



D

Specifications



Model	Model Description	Resolution	Best reading distance	Min. accuracy	Protocol	Power consumption	Label
MV-IDH2000/03SR/03WN/U	wired	640 × 480	100 mm	4 mil	SmartSDK,USB(HID/CDC)	2.5 W@5 VDC	A
MV-IDH2000/13xR/05WN/U	wired	1280 × 1024	NR: 70 mm SR: 150 mm	S: 1D: 3 mil; 2D: 10 mil N: 1D: 2 mil; 2D: 4 mil	SmartSDK,USB(HID/CDC)	2.5 W@5 VDC	A
MV-IDH2000B/03SR/03WN/UC	Wireless(Bluetooth), including base	640 × 480	100 mm	4 mil	SmartSDK, Bluetooth,USB	6 W@ 5 VDC	B
MV-IDH2000B/13xR/05WN/UC	Wireless(Bluetooth), including base	1280 × 1024	NR: 70 mm SR: 150 mm	S: 1D: 3 mil; 2D: 10 mil N: 1D: 2 mil; 2D: 4 mil	SmartSDK, Bluetooth,USB	6 W@ 5 VDC	B
MV-IDH2000RF/03SR/03WN/UC	Wireless (2.4G), including base	640 × 480	100 mm	4 mil	SmartSDK,USB,2.4G	6 W@5 VDC	B
Model	Model Description	Resolution	Min. accuracy	Protocol	Power consumption	Focal length	Label
MV-IDH2000RF/13xR/05WN/UC	Wireless (2.4G), including base	1280 × 1024	NR: 70 mm SR: 150 mm	S: 1D: 3 mil; 2D: 10 mil N: 1D: 2 mil; 2D: 4 mil	SmartSDK,USB,2.4G	6 W@ 5 VDC	B
MV-IDH2000P/13xR/05RN/U	wired, 3-color light sources	1280 × 1024	NR: 70 mm SR: 150 mm	S: 1D: 3 mil; 2D: 5 mil N: 1D: 2 mil; 2D: 4 mil	SmartSDK,USB(HID/CDC)	2.5 W@5 VDC	C
MV-IDH2000PB/13xR/05RN/UC	Wireless(Bluetooth), 3-color light sources, including base	1280 × 1024	NR: 70 mm SR: 150 mm	S: 1D: 3 mil; 2D: 5 mil N: 1D: 2 mil; 2D: 4 mil	SmartSDK, Bluetooth,USB	2.5 W@5 VDC	D

Note: x=S represents the standard working range, x=N represents the near working range.
The UC model is a package model. If you need to purchase a scanner separately, please contact sales.

Unit:mm

Smart Code Reader

IDH3000 Series Handheld Code Reader

General-purpose handheld scanner equipped with AI deep learning algorithms, delivering exceptional performance in reading challenging DPM codes. Wired models support USB, serial port, Ethernet and major industrial protocols, wireless options support Bluetooth. Ideal for 3C electronics, PCB manufacturing, new energy and logistics applications.

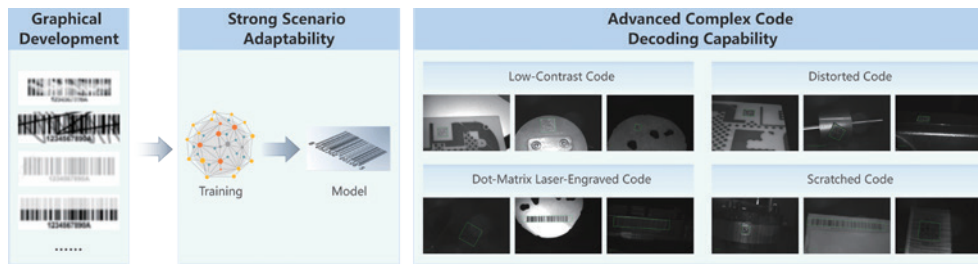

• Built-in AI deep learning algorithm, excellent DPM decoding ability



• Support network models and mainstream industrial communication protocols



• High cost performance

Specifications



Model	Model Description	Resolution	Best reading distance	Min. accuracy	Protocol	Power consumption	Label
MV-IDH3000/13xR/05RN/U	Wired, USB port, red light	1280 × 1024	NR: 50 mm SR: 120mm	S: 4 mil N: 3 mil	SmartSDK, USB (HID/CDC)	1.5 W@5 VDC(USB) 1.8 W@12 VDC(DC terminal)	A
MV-IDH3000/13xR/05RN/L	Wired, Network port, red light	1280 × 1024		S: 4 mil N: 3 mil	Fast Ethernet (100 Mbit/s), RS-232	1.8 W@12 VDC	A
MV-IDH3000/13xR/05RN/LE	Wired, Red light, support industrial protocols	1280 × 1024		S: 4 mil N: 3 mil	SmartSDK, TCP Client, FTP, TCP Server, UDP, Serial, EthernetIp, Profinet, Modbus	1.8 W@12 VDC	A
MV-IDH3000B/13xR/05RN/US	Wireless (Bluetooth), Red light, including base	1280 × 1024	NR: 50 mm SR: 120mm	S: 4 mil N: 3 mil	SmartSDK, USB (HID/CDC)	Scanner: standby model: 0.8 W@ 3.8 VDC, working mode: 1.6 W@ 3.8 VDC, sleep mode: 0.6 W@ 3.8 VDC Base: 4.5 W@ 5 VDC(USB), 6.6 W@ 12 VDC(DC terminal),	B
MV-IDH3000B/13xR/05RN/LS	Wireless (Bluetooth), Red light, including smart base	1280 × 1024		S: 4 mil N: 3 mil	Scanner: Bluetooth Base: SmartSDK, USB(HID/CDC), Bluetooth	Scanner: standby model: 0.8 W@ 3.8 VDC, working mode: 1.6 W@ 3.8 VDC, sleep mode: 0.6 W@ 3.8 VDC Base: 6.6 W@ 12 VDC,	B
MV-IDH3000B/13xR/05RN/LES	Wireless (Bluetooth), Red light, support industrial protocols	1280 × 1024		S: 4 mil N: 3 mil	Scanner: Bluetooth Base: SmartSDK, TCP Client, Serial, FTP, TCP Server, UDP, Bluetooth, EthernetIp, Profinet, Modbus	Scanner: standby model: 0.8 W@ 3.8 VDC, working mode: 1.6 W@ 3.8 VDC, sleep mode: 0.6 W@ 3.8 VDC Base: 6.6 W@ 12 VDC,	B

Dimension

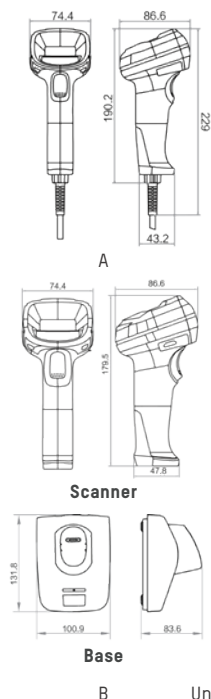

Note: x=S represents the standard working range, x=N represents the near working range

Smart Code Reader

IDH7000 Series Handheld Code Reader

Durable handheld scanner equipped with a megapixel high-sensitivity global-shutter sensor, dual-color rubberized design with superior drop protection. Equipped with AI deep learning algorithms for challenging DPM codes. Suitable for electronics, auto parts, semiconductor, metal manufacturing, PCB, glass panel, etc.

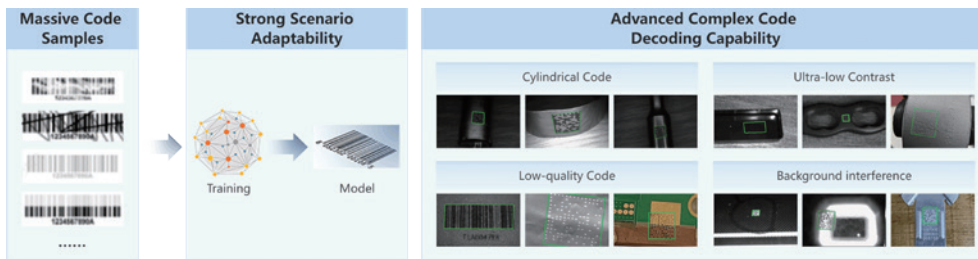

- Built-in AI deep learning algorithm, excellent DPM decoding ability



- Dual lighting modes, automatically select the optimal one according to the scenario



- Durable design, suitable for harsh environment applications

Dimension

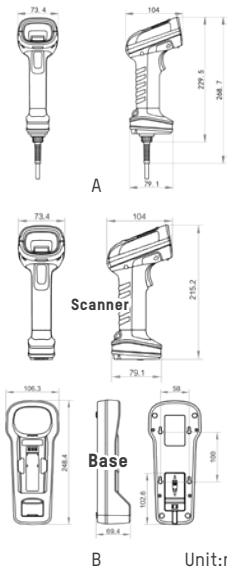

Unit:mm



Specifications

Model	Model Description	Resolution	Best reading distance	Min. accuracy	Protocol	Power consumption	Label
MV-IDH7000P/10xR/07RN/L	Wired, Network port, red light	1280 × 800	NR: 50 mm SR: 120 mm	3 mil	SmartSDK,TCP,FTP,Profinet,EthernetIP,Modbus,UDP,Serial	6 W@24 VDC	A
MV-IDH7000P/10xR/07RN/U	Wired, USB port, red light	1280 × 800		3 mil	SmartSDK,USB(HID/CDC)	USB 2.0:4.6 W@5 VDC. DC terminal:6 W@24 VDC	A
MV-IDH7000P/10xR/07RN/LP	Wired, Network port (POE), red light	1280 × 800	HHD: 10 mm	S:4 mil. N:3 mil	SmartSDK,TCP,FTP,Profinet,EthernetIP,Modbus,UDP,Serial	6 W@24 VDC	A
MV-IDH7000P/10HHD/07RN/U	Wired, USB port, red light, HHD	1280 × 800		1D:0.8 mil. 2D:2 mil	SmartSDK,USB(HID/CDC)	USB 2.0:4.6 W@5 VDC. DC terminal:6 W@24 VDC	A
MV-IDH7000P/10HHD/07RN/L	Wired, Network port, red light, HHD	1280 × 800	ER: 800 mm	1D:0.8 mil. 2D:2 mil	SmartSDK,TCP,FTP,Profinet,EthernetIP,Modbus,UDP,Serial	6 W@24 VDC	A
MV-IDH7000P/10ER/12RN/U*	Wired, USB port, red light, ER	1280 × 800		10 mil	SmartSDK,USB(HID/CDC)	USB 2.0: 4.6 W@5 VDC DC terminal: 6 W@24 VDC	A
MV-IDH7000P/10ER/12RN/L*	Wired, USB port, red light, ER	1280 × 800	NR: 50 mm SR: 120 mm	10 mil	SmartSDK,TCP,FTP,Profinet,EthernetIP,Modbus,UDP,Serial	USB 2.0: 4.6 W@5 VDC DC terminal: 6 W@24 VDC	B
MV-IDH7000B/10xR/07RN/LS	Wireless(Bluetooth), Red light, including smart base	1280 × 800		3 mil	Scanner: Bluetooth Base: SmartSDKTCP ClientSerial FTP TCP ServerUDPProfinetEthernet/IP	Scanner: standby model: 1.1 W@ 3.8 VDC, working mode: 6.4 W@ 3.8 VDC, sleep mode: 0.8 W@ 3.8 VDC Base: 7.5 W@ 5 VDC(USB), 7.5 W@ 12 VDC(DC terminal)	B
MV-IDH7000B/10xR/07RN/US	Wireless(Bluetooth), Red light, including base	1280 × 800	HHD: 10 mm	3 mil	Scanner: Bluetooth Base: SmartSDKUSB(HID/CDC)	6.4 W@ 3.8 VDC	B
MV-IDH7000B/10HHD/07RN/LS	Wireless(Bluetooth), Red light, HHD, including smart base	1280 × 800		3 mil	Scanner: Bluetooth Base: SmartSDKTCP ClientSerial FTP TCP ServerUDPProfinetEthernet/IP	6.4 W@ 3.8 VDC	B
MV-IDH7000B/10HHD/07RN/US	Wireless(Bluetooth), Red light, HHD, including base	1280 × 800	ER: 800 mm	10 mil	Scanner: Bluetooth Base: SmartSDKUSB(HID/CDC)	6.4 W@ 3.8 VDC	B
MV-IDH7000B/10ER/12RN/US*	Wireless(Bluetooth), Red light, ER, including base	1280 × 800		10 mil	Scanner: Bluetooth Base: SmartSDKUSB(HID/CDC)	6.4 W@ 3.8 VDC	B
MV-IDH7000B/10ER/12RN/LS*	Wireless(Bluetooth), Red light, ER, including base	1280 × 800		10 mil	Scanner: Bluetooth Base: SmartSDKTCP ClientSerial FTP TCP ServerUDPProfinetEthernet/IP	6.4 W@ 3.8 VDC	B

Note: *New Release. x=S represents the standard working range, x=N represents the near working range.

Smart Code Reader

IDH9000 Series Handheld Code Reader

Ultra – durable handheld scanner equipped with dual megapixel image sensors for reading micro or large DOF codes. Oil-resistant materials and full-sealed design ensure high protection. Fully rubberized design allows the product to withstand drop from a height of 2.5 meters, ideal for automotive parts, semiconductor, metalworking, glass panels, aerospace and related applications.

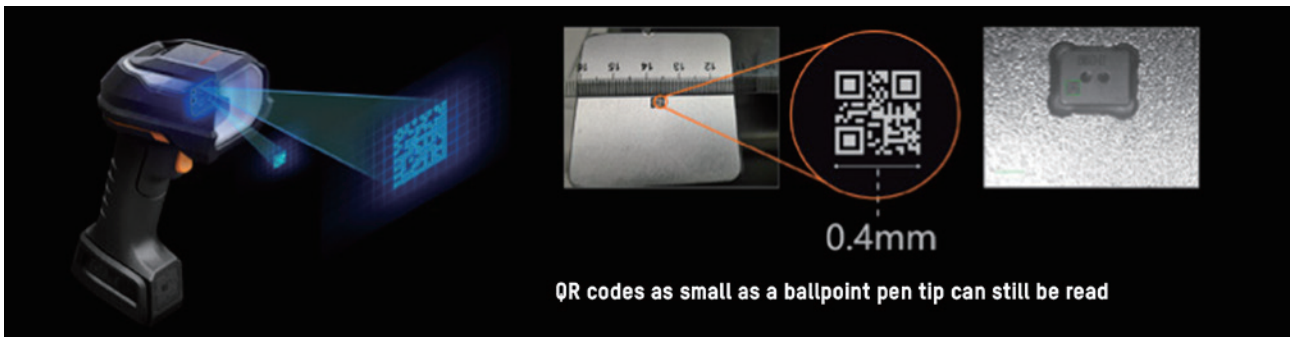

- Equipped with dual lens linkage, taking into account extremely small size and large depth of field



IP67/IP65
High IP Rating

ISO 16750
Automotive Oil-Resistant
Material

25m | 50 times
Drop and Shock
Resistance

10 million times
Extended Key
Lifespan

- comprehensive improvement in protection and durability levels, reducing total cost of ownership

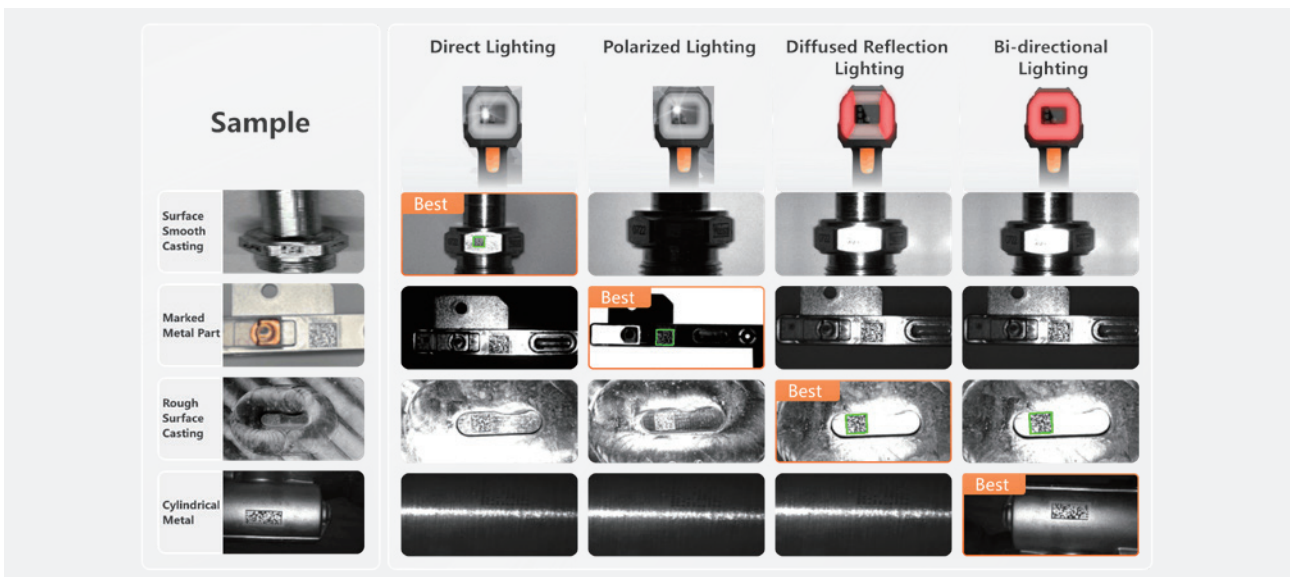

- Four integrated lighting sources automatically select the best one according to the scene



Specifications



Model	Model Description	Resolution	Best reading distance	Min. accuracy	Protocol	Power consumption	Focal length	Label
MV-IDH9000/13HHD/16RP/L	Wired, Network port, support micro code reading	1280 × 1024	65 mm	1.57mil (The overall size of the code is 0.4×0.4mm)	Fast Ethernet, RS-232	5.5 W	Short focal length lens: 4.3 mm Long focal length lens: 16 mm	A
MV-IDH9000/13HHD/16RP/U	Wired, USB port, support micro code reading	1280 × 1024		1.57mil (The overall size of the code is 0.4×0.4mm)	USB2.0/3.0, RS-232	5.5 W	Short focal length lens: 4.3 mm Long focal length lens: 16 mm	A
MV-IDH9000/13DP/04RP/L	Wired, Network port, support challenging code reading	1280 × 1024		3 mil	Fast Ethernet, RS-232	5.5 W	4.3 mm	A
MV-IDH9000/13DP/04RP/U	Wired, USB port, support challenging code reading	1280 × 1024		3 mil	USB2.0/3.0, RS-232	5.5 W	4.3 mm	A
MV-IDH9000B/13HHD/16RP/LS*	Wireless network port package, support micro/challenging code reading, including base	1280 × 1024		1.57mil (The overall size of the code is 0.4×0.4mm)	Scanner:Bluetooth Base:SmartSDK, TCP Client, Serial, FTP, TCP Server, UDP, Profinet, Ethernet/IP	10 W@24 VDC	Short focal length lens: 4.3 mm Long focal length lens: 16 mm	B
MV-IDH9000B/13HHD/16RP/US*	Wireless USB port package, support micro/challenging code reading, including base	1280 × 1024		1.57mil (The overall size of the code is 0.4×0.4mm)	Scanner:Bluetooth Base:SmartSDK, USB(HID/CDC)	USB2.0:4.6 W@5 VDC DC terminal:10 W@24 VDC	Short focal length lens: 4.3 mm Long focal length lens: 16 mm	B
MV-IDH9000B/13DP/04RP/LS*	Wireless network port package, support challenging code reading, including base	1280 × 1024		1D:3 mil 2D:5 mil	Scanner: Bluetooth Base: SmartSDK, TCP Client, Serial, FTP, TCP Server, UDP, Profinet, Ethernet/IP	10 W@24 VDC	4.3 mm	B
MV-IDH9000B/13DP/04RP/US*	Wireless USB port package, support challenging code reading, including base	1280 × 1024		1D:3 mil 2D:5 mil	Scanner:Bluetooth Base:SmartSDK, USB(HID/CDC)	USB2.0:4.6 W@5 VDC DC terminal:10 W@24 VDC	4.3 mm	B

Dimension

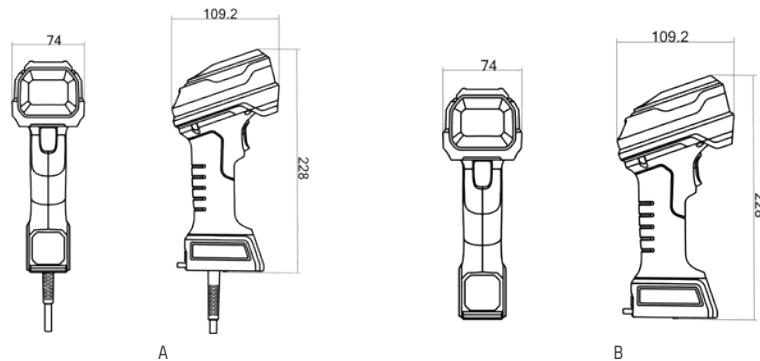

Unit:mm

List of Handheld Code Reader Accessories

IDH Accessories		Adaption Series			
		IDH9000	IDH7000	IDH3000	IDH2000
Cable	USB	√	√	√	√
	Serial Port	√	√	√	√
	Network Cable (including serial port)	√	√	√	×
	USB Spring Cable	×	√	×	×
	Network Spring cable (including serial port)	×	√	×	×
Bracket	Vertical Stand	×	√	√	√
	Wall-Mounted	×	√	√	√
Base	Wall-Mounted	√	√	×	×
	Vertical Stand	×	×	√	√
Adapter	Adapter	√	√	√	√
Wireless Accessories	Battery	√	√	√	√
	Wireless Module	×	×	×	√(2.4G RF or Bluetooth)

Product Series	Power adapter packaging configuration rules	
	USB	GigE
MV-IDH2000	×	/
MV-IDH2000RF Without Base	×	/
MV-IDH2000RF With Base	×	/
MV-IDH2000B	×	/
MV-IDH2000P	×	/
MV-IDH2000PB	×	/
MV-IDH3000	×	√
MV-IDH3000B	√	√
MV-IDH7000P	×	√
MV-IDH7000B	√	√
MV-IDH9000	√	√
MV-IDH9000B	√	√

■ IDMVS Client

IDMVS client is an application software developed by Hikrobot exclusively for code reading cameras, which supports the debugging of all series of industrial code readers, handheld scanners, code reading modules and other code reading products. Through IDMVS, you can perform a series of debugging operations such as code reader focusing, parameter setting and establishing communication, etc. You can follow the seven-step guide bar on the left side of the software interface to complete the equipment setting and easily complete the preparation before the equipment comes online.

Key Features

- Directly connected to the code reader debugging, clear configuration process, centralized module functions, easy to operate and start
- Real-time display of code reading effects for imaging optimization and debugging
- Integrated FTP client for direct local storage via FTP
- Provide SDK secondary development, support C, C++, C# development language
- Provide UI interface and other in-depth customization services to meet customer needs in all aspects

IDMVS

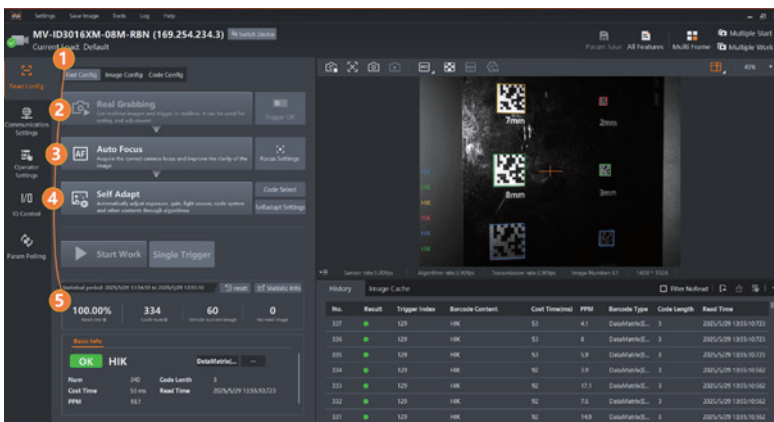

Download



IDMVS client can be downloaded by visiting the website of Hikrobot.

<https://www.hikrobotics.com/en/machinevision/service/download?module=0>

■ Selection Guide of Smart Code Reader

Step 1: Select Product Series

Select the product series based on the actual demands.

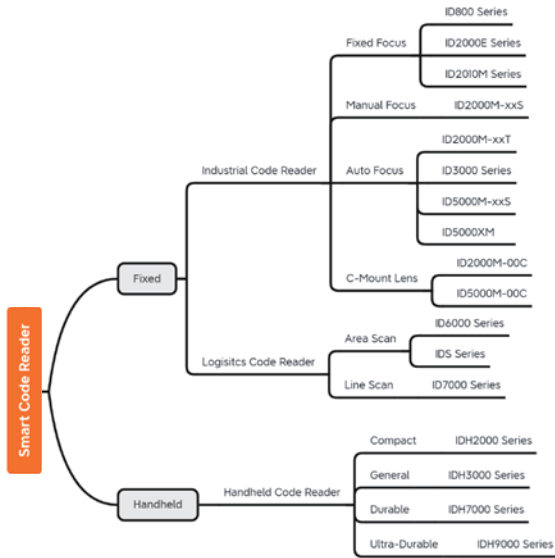

Step 2: Select Resolution and Focal Length

Select Resolution:

Confirm code information and requirements of field of view, and convert the minimum resolution of camera as follows.

Minimum Resolution of Camera ≥

$$\frac{\text{Field of View} * \text{Algorithm Performance}}{\text{Minimum Resolution of Code}} = \frac{() mm \times ()}{() mm}$$

Based on the project stability, it is recommended to select algorithm Performance from 1 to 4 for 1D codes and from 3 to 8 for 2D codes. The minimum resolution of code refers to narrow bar size for bar code and minimum module size for QR code. You can see in the figure below. The product resolution is shown below.



ID800	ID2000	ID3000	ID5000	ID6000	ID7000	IDS	IDH
30 W to 130 W	40 W to 160 W	130 W to 500 W	300 W to 2500 W	890 W to 2000 W	6 K to 8 K	600 W to 2000 W	30 W to 130 W

Select Focal Length

Refer to the specification to confirm the working distance and the field of view.

MV-ID3030XM (Unit: mm)					
Lens Focal Length	Working Distance	FoV		1D Single Pixel Accuracy	2D Single Pixel Accuracy
		H	V		
8	25	22.3	16.7	0.011	0.033
	100	89.0	66.9	0.043	0.131
	300	267.1	200.8	0.130	0.392
	600	534.3	401.5	0.261	0.784
	1000	883.2	662.4	0.400	1.300
	2000	1766.4	1324.8	0.900	2.600

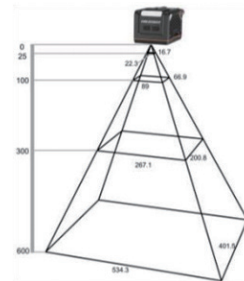

Step 3: Select Light Source and Lens Cap

Select a suitable light source and lens cap according to the carrier material, coding process, surface pattern, and other factors. The accessories are detailed in the list of code reader accessories.



Image effect of lamp panels with different colors

Step 4: Select Structure and Function

Select the supported device model, cable type, and cable length according to the device environment. See the list of code reader accessories.

For fixed products, it is recommended to consider ingress protection and Dimension.

Device Model	ID800	ID2000E	ID2000M	ID3000P	ID3000X	ID5000-xxS	ID5000-00C	ID5000X
Ingress Protection	IP54	IP54	IP65	IP67	IP67	IP67	IP67	IP67
Dimension (mm)	38 × 38 × 18	45 × 43 × 25	46 × 40 × 25	65 × 65 × 47	80 × 43 × 44	112 × 65 × 63	109 × 64 × 109	88 × 65 × 54

For handheld products, it is recommended to consider ingress protection and drop height.

Device Model	IDH2000	IDH3000	IDH7000	IDH9000
Ingress Protection	IP42	IP42	IP65	IP67
Drop Height (m)	1.5	1.5	1.8	2.5

Select the supported device models based on the software functions.

For fixed products, the following functions may be considered.

Device Model	ID800	ID2000E	ID2000M	ID3000	ID5000
Communication Protocol	USB, Serial	TCP Client, Serial, FTP, TCP Server, UDP, Profinet, EthernetIP, USB	TCP Client, Serial, FTP, TCP Server, Profinet, Ethernet/IP, Melsec, Fins, ModBus, SLMP, UDP		
Polling Function	Not supported	Not supported	8	8	8
Algorithm ROI	4	4	4	150	150
Main-Sub Function	Not supported	Not supported	Support	Support	Support
Code Score	Not supported	Not supported	Support	Support	Support

For handheld products, the following communication protocols may be considered.

Device Model	IDH2000	IDH3000	IDH7000	IDH9000
Communication Protocol	USB, RF 2.4G Bluetooth	TCP Client, FTP, TCP Server, UDP, Serial, USB, EthernetIP, Profinet, Modbus, MC/SLMP, Fins	TCP Client, FTP, HTTP, TCP Server, UDP, Serial, USB, Profinet, MELSEC/SLMP, Ethernet/IP, ModBus, Fins	

■ Vision Controller

I VC2000 Series Vision Controller

VC2000 series vision controller is equipped with Intel high-performance processing chip and rich data acquisition and control interfaces, including gigabit network port, IO, light source, serial port, etc ;

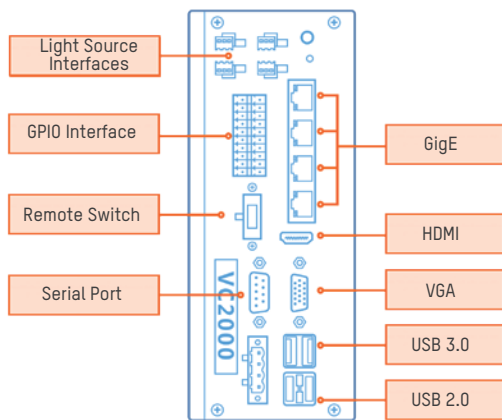

• Rich interface and simple application

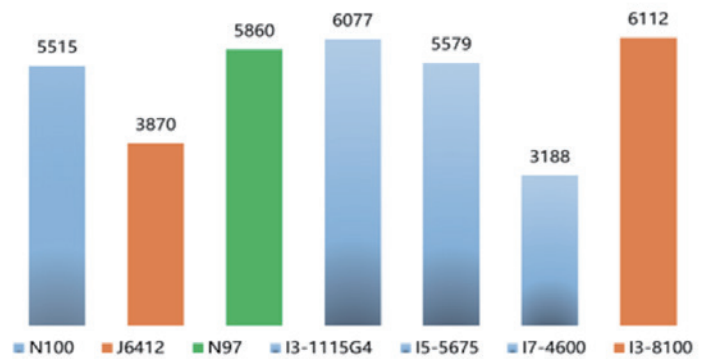

• High Performance CPU processor

Specifications



Model	CPU	Memory	Storage	Digital I/O	Light Interface	GigE	USB3.0	USB2.0(+built-in)
MV-VC2140-128G40-NN	Intel® Processor N97	8GB	128GB SSD	Opto-isolated input × 8, Opto-isolated output × 8	4	4	2	2 + 1
MV-VC2140-128G40-1T	Intel® Processor N97	8GB	128G SSD + 1T HDD	Opto-isolated input × 8, Opto-isolated output × 8	4	4	2	2 + 1
MV-VC2143-128G40-NN	Intel® Processor N97	8GB	128GB SSD	Opto-isolated input × 8, Opto-isolated output × 8	4	4 (PoE)	2	2 + 1
MV-VC2143-128G40-1T	Intel® Processor N97	8GB	128G SSD + 1T HDD	Opto-isolated input × 8, Opto-isolated output × 8	4	4 (PoE)	2	2 + 1

Dimension

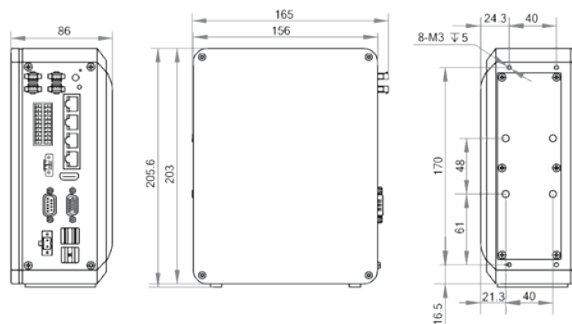

Unit:mm

■ Vision Controller

I VC3000 Series Vision Controller

VC3000 vision controller is characterized with the flagship computing power and comprehensive control/data interface. It has desirable compatibility with machine vision components in common tasks such as positioning, inspection, measurement and recognition.

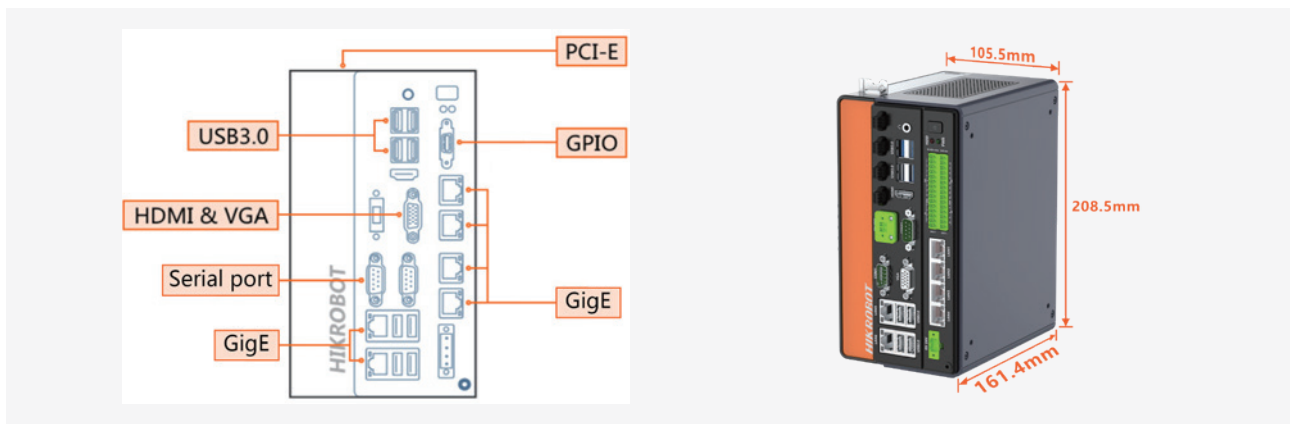

• Rich interfaces facilitate solution building



• Compact and convenient installation

Specifications



Model	CPU	Memory	Storage	Light source interface & Digital I/O	GigE	USB3.0	USB2.0(+built-in)
MV-VC3101H-128660	Intel® Celeron™ G4900	8GB	128G SSD	Opto-isolated input × 8, Opto-isolated output × 16, Light source interface × 4	6	4	4 + 1
MV-VC3102H-128660	Intel® Celeron™ G4900	8GB	128G SSD + 2T HDD	Opto-isolated input × 8, Opto-isolated output × 16, Light source interface × 4	6	4	4 + 1
MV-VC3201H-128660	Intel® Pentium™ G5400	8GB	128G SSD	Opto-isolated input × 8, Opto-isolated output × 16, Light source interface × 4	6	4	4 + 1
MV-VC3202H-128660	Intel® Pentium™ G5400	8GB	128G SSD + 2T HDD	Opto-isolated input × 8, Opto-isolated output × 16, Light source interface × 4	6	4	4 + 1
MV-VC3301H-128660	Intel® Core™ i3-8100	8GB	128G SSD	Opto-isolated input × 8, Opto-isolated output × 16, Light source interface × 4	6	4	4 + 1
MV-VC3302H-128660	Intel® Core™ i3-8100	8GB	128G SSD + 2T HDD	Opto-isolated input × 8, Opto-isolated output × 16, Light source interface × 4	6	4	4 + 1
MV-VC3303H-128660	Intel® Core™ i3-8100	8GB	128G SSD + 2T HDD	Opto-isolated input × 8, Opto-isolated output × 16, Light source interface × 4	2+4(POE)	4	4 + 1
MV-VC3304H-128660	Intel® Core™ i3-8100	16GB	128G SSD + 2T HDD	Opto-isolated input × 8, Opto-isolated output × 16, Light source interface × 4	6	4	4 + 1

Model	CPU	Memory	Storage	Light source interface & Digital I/O	GigE	USB3.0	USB2.0(+built-in)
MV-VC3501H-128660	Intel® Core™ i5-8500	8GB	128G SSD	Opto-isolated input × 8, Opto-isolated output × 16, Light source interface × 4	6	4	4 + 1
MV-VC3502H-128660	Intel® Core™ i5-8500	8GB	128G SSD + 2T HDD	Opto-isolated input × 8, Opto-isolated output × 16, Light source interface × 4	6	4	4 + 1
MV-VC3503H-128660	Intel® Core™ i5-8500	8GB	128G SSD + 2T HDD	Opto-isolated input × 8, Opto-isolated output × 16, Light source interface × 4	2+4(PoE)	4	4 + 1
MV-VC3504H-128660	Intel® Core™ i5-8500	16GB	128G SSD + 2T HDD	Opto-isolated input × 8, Opto-isolated output × 16, Light source interface × 4	6	4	4 + 1
MV-VC3701H-128660	Intel® Core™ i7-8700	8GB	128G SSD	Opto-isolated input × 8, Opto-isolated output × 16, Light source interface × 4	6	4	4 + 1
MV-VC3702H-128660	Intel® Core™ i7-8700	8GB	128G SSD + 2T HDD	Opto-isolated input × 8, Opto-isolated output × 16, Light source interface × 4	6	4	4 + 1
MV-VC3703H-128660	Intel® Core™ i7-8700	8GB	128G SSD + 2T HDD	Opto-isolated input × 8, Opto-isolated output × 16, Light source interface × 4	2+4(PoE)	4	4 + 1
MV-VC3704H-128660	Intel® Core™ i7-8700	16GB	128G SSD + 2T HDD	Opto-isolated input × 8, Opto-isolated output × 16, Light source interface × 4	6	4	4 + 1
MV-VC3101X-128660	Intel® Celeron™ 6690	8GB	128G SSD	Opto-isolated input × 8, Opto-isolated output × 16, Light source interface × 4	6	4	4 + 1
MV-VC3102X-128660	Intel® Celeron™ 6690	8GB	128G SSD + 2T HDD	Opto-isolated input × 8, Opto-isolated output × 16, Light source interface × 4	6	4	4 + 1
MV-VC3201X-128660	Intel® Pentium™ 6740	8GB	128G SSD	Opto-isolated input × 8, Opto-isolated output × 16, Light source interface × 4	6	4	4 + 1
MV-VC3202X-128660	Intel® Pentium™ 6740	8GB	128G SSD + 2T HDD	Opto-isolated input × 8, Opto-isolated output × 16, Light source interface × 4	6	4	4 + 1
MV-VC3301X-128660	Intel® Core™ 12th-i3	8GB	128G SSD	Opto-isolated input × 8, Opto-isolated output × 16, Light source interface × 4	6	4	4 + 1
MV-VC3302X-128660	Intel® Core™ 12th-i3	8GB	128G SSD + 2T HDD	Opto-isolated input × 8, Opto-isolated output × 16, Light source interface × 4	6	4	4 + 1
MV-VC3303X-128660	Intel® Core™ 12th-i3	8GB	128G SSD + 2T HDD	Opto-isolated input × 8, Opto-isolated output × 16, Light source interface × 4	2+4(PoE)	4	4 + 1
MV-VC3304X-128660	Intel® Core™ 12th-i3	16GB	128G SSD + 2T HDD	Opto-isolated input × 8, Opto-isolated output × 16, Light source interface × 4	6	4	4 + 1
MV-VC3501X-128660	Intel® Core™ 12th-i5	8GB	128G SSD	Opto-isolated input × 8, Opto-isolated output × 16, Light source interface × 4	6	4	4 + 1
MV-VC3502X-128660	Intel® Core™ 12th-i5	8GB	128G SSD + 2T HDD	Opto-isolated input × 8, Opto-isolated output × 16, Light source interface × 4	6	4	4 + 1
MV-VC3503X-128660	Intel® Core™ 12th-i5	8GB	128G SSD + 2T HDD	Opto-isolated input × 8, Opto-isolated output × 16, Light source interface × 4	2+4(PoE)	4	4 + 1
MV-VC3504X-128660	Intel® Core™ 12th-i5	16GB	128G SSD + 2T HDD	Opto-isolated input × 8, Opto-isolated output × 16, Light source interface × 4	6	4	4 + 1
MV-VC3701X-128660	Intel® Core™ 12th-i7	8GB	128G SSD	Opto-isolated input × 8, Opto-isolated output × 16, Light source interface × 4	6	4	4 + 1
MV-VC3702X-128660	Intel® Core™ 12th-i7	8GB	128G SSD + 2T HDD	Opto-isolated input × 8, Opto-isolated output × 16, Light source interface × 4	6	4	4 + 1
MV-VC3703X-128660	Intel® Core™ 12th-i7	8GB	128G SSD + 2T HDD	Opto-isolated input × 8, Opto-isolated output × 16, Light source interface × 4	2+4(PoE)	4	4 + 1
MV-VC3704X-128660	Intel® Core™ 12th-i7	16GB	128G SSD + 2T HDD	Opto-isolated input × 8, Opto-isolated output × 16, Light source interface × 4	6	4	4 + 1

Dimension

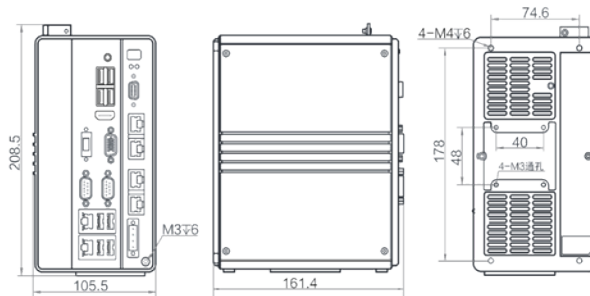

Unit:mm

Vision Controller

VC5000 Series Vision Controller

VC5000 vision controller is a high-performance edge vision computing platform that supports AI. It has a compact structure and rich interfaces, and can provide efficient and stable control and data transmission for visual inspection. The flexible modular design meets the expansion needs of common machine vision acquisition interfaces/graphics cards.

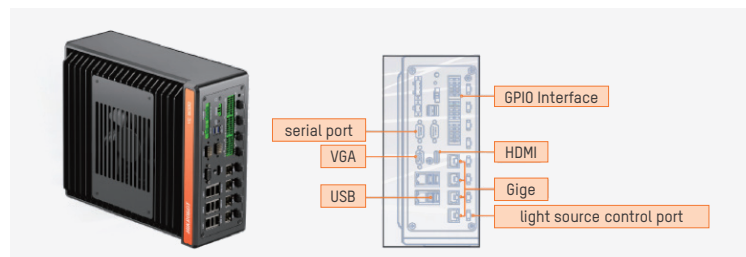
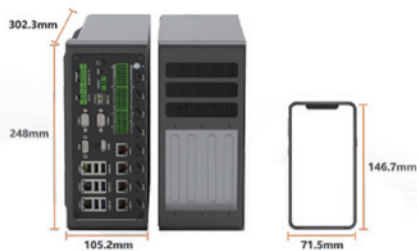

• VC5000 vision controller provides a modular and scalable design, and the configuration of multiple expansion slots allows users to freely match. The host is compact in size and can meet the complex space restriction requirements on site

• Equipped with desktop-level Intel 12th/13th generation CPU, it provides powerful computing performance for visual inspection. It has rich interfaces: Gigabit network port, PCIE, serial port, GPIO port, light source control port, etc., which can perfectly meet the application needs of industrial manufacturing

Specifications



Model	CPU	Memory	Storage	Digital I/O	6igE	USB3.0	USB2.0 (+built-in)	Label
MV-VC5314-256670-2T		8GB,16GB,32GB	256G SSD+2T HDD,256G SSD		3 + 4 (POE)	4	4+1	A
MV-VC5314-256670-NN		8GB,16GB,32GB	256G SSD+2T HDD,256G SSD	Opto-isolated input × 8	3 + 4 (POE)	4	4+1	A
MV-VC5315-256670-2T		32GB	256G SSD+2T HDD	Opto-isolated output × 12	3 + 4 (POE)	4	4+1	A
MV-VC5315-256670-NN	Intel® Core™ i3-12100	8GB,16GB,32GB	256G SSD+2T HDD,256G SSD	Digital-isolated low-side driver output × 8	3 + 4 (POE)	4	4+1	A
MV-VC5324-256670-2T		8GB,16GB,32GB	256G SSD+2T HDD,256G SSD		3 + 4 (POE)	4	4+1	B
MV-VC5324-256670-NN		8GB,16GB,32GB	256G SSD+2T HDD,256G SSD	Non-isolated bi-directional differential × 4	3 + 4 (POE)	4	4+1	B
MV-VC5325-256670-2T		32GB	256G SSD+2T HDD		3 + 4 (POE)	4	4+1	B
MV-VC5325-256670-NN		8GB,16GB,32GB	256G SSD+2T HDD,256G SSD		3 + 4 (POE)	4	4+1	B
MV-VC5514-256670-2T		8GB,16GB,32GB	256G SSD+2T HDD,256G SSD		3 + 4 (POE)	4	4+1	A
MV-VC5514-256670-NN		8GB,16GB,32GB	256G SSD+2T HDD,256G SSD	Opto-isolated input × 8	3 + 4 (POE)	4	4+1	A
MV-VC5515-256670-2T		32GB	256G SSD+2T HDD	Opto-isolated output × 12	3 + 4 (POE)	4	4+1	A
MV-VC5515-256670-NN	Intel® Core™ i5-12400	8GB,16GB,32GB	256G SSD+2T HDD,256G SSD	Digital-isolated low-side driver output × 8	3 + 4 (POE)	4	4+1	B
MV-VC5524-256670-2T		8GB,16GB,32GB	256G SSD+2T HDD,256G SSD		3 + 4 (POE)	4	4+1	B
MV-VC5524-256670-NN		8GB,16GB,32GB	256G SSD+2T HDD,256G SSD	Non-isolated bi-directional differential × 4	3 + 4 (POE)	4	4+1	B
MV-VC5525-256670-2T		32GB	256G SSD+2T HDD		3 + 4 (POE)	4	4+1	B
MV-VC5525-256670-NN		8GB,16GB,32GB	256G SSD+2T HDD,256G SSD		3 + 4 (POE)	4	4+1	B
MV-VC5714-256670-2T		8GB,16GB,32GB	256G SSD+2T HDD,256G SSD		3 + 4 (POE)	4	4+1	A
MV-VC5714-256670-NN		8GB,16GB,32GB	256G SSD+2T HDD,256G SSD	Opto-isolated input × 8	3 + 4 (POE)	4	4+1	A
MV-VC5715-256670-2T		32GB	256G SSD+2T HDD	Opto-isolated output × 12	3 + 4 (POE)	4	4+1	A
MV-VC5715-256670-NN	Intel® Core™ i7-12700	8GB,16GB,32GB	256G SSD+2T HDD,256G SSD	Digital-isolated low-side driver output × 8	3 + 4 (POE)	4	4+1	B
MV-VC5724-256670-2T		16GB	256G SSD+2T HDD		3 + 4 (POE)	4	4+1	B
MV-VC5724-256670-NN		8GB,16GB,32GB	256G SSD+2T HDD,256G SSD	Non-isolated bi-directional differential × 4	3 + 4 (POE)	4	4+1	B
MV-VC5725-256670-2T		32GB	256G SSD+2T HDD		3 + 4 (POE)	4	4+1	B
MV-VC5725-256670-NN		8GB,16GB,32GB	256G SSD+2T HDD,256G SSD		3 + 4 (POE)	4	4+1	B

Dimension

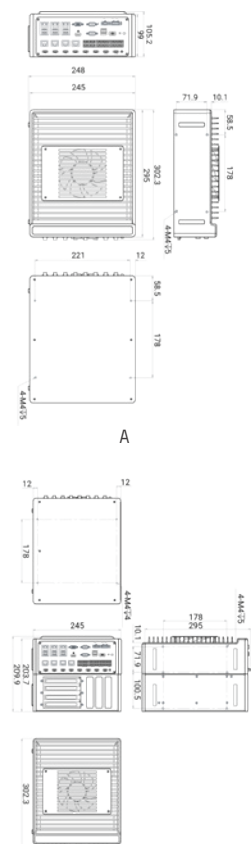

Unit:mm

■ Vision Controller

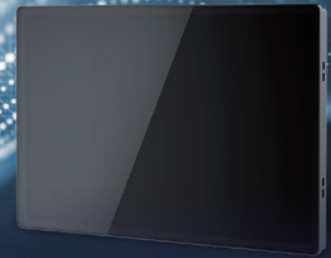

I VT2000 Series TouchScreen PC

The all-in-one touch machine is equipped with Intel's high-Performance processing chip, with an integrated chassis and screen design. It can be used in simple multi-camera vision applications with a capacitive touchscreen, providing a more flexible choice for visual equipment.

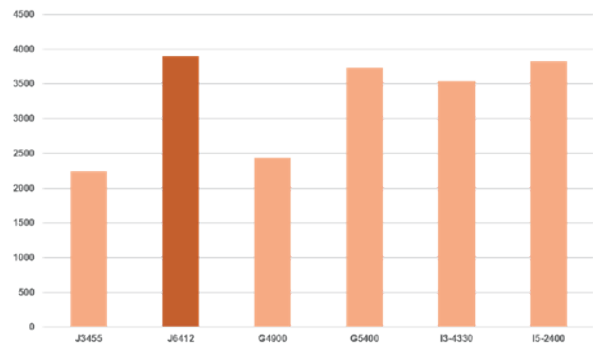

- The 10.1-inch touchscreen all-in-one machine is equipped with a variety of interfaces to adapt to various detection and display needs in small spaces on site, providing users with a more comfortable experience

- Compact hardware structure design, rich industrial interface configuration, taking into account both Performance and heat dissipation, combined with high-Performance CPU processor can implement a conventional visual inspection solution for 3 to 4 cameras to meet the application needs of on-site applications without the need for industrial computers

Specifications



Model	CPU	Memory	Storage	Digital I/O	GigE	USB3.0	USB2.0	Screen Size
MV-VT2000-128G40-NN	J6412	8GB	128GB SSD	Opto-isolated input × 7 Opto-isolated output × 7	4	2	2	10.1"
MV-VT2000-128G40-2T	J6412	8GB	128G SSD+2T HDD	Opto-isolated input × 7 Opto-isolated output × 7	4	2	2	10.1"

Dimension

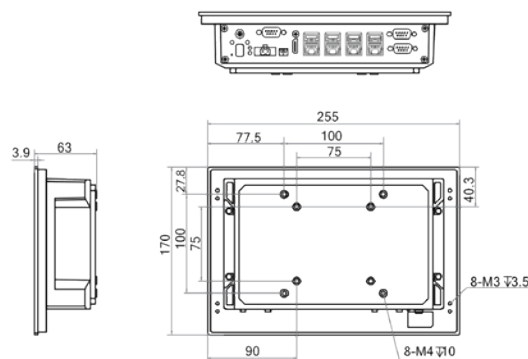

Unit:mm

■ Vision Controller

I VT3000 Series TouchScreen PC



VT3000 is equipped with an Intel coffee lake processor and a multi-point capacitive touch screen, ensuring precise operation and sensitive use. It has multiple gigabit network ports, USB, serial ports, and supports rich interfaces such as 11 GPIO. It can be used in simple multi camera visual applications, providing more flexible choices for visual devices.

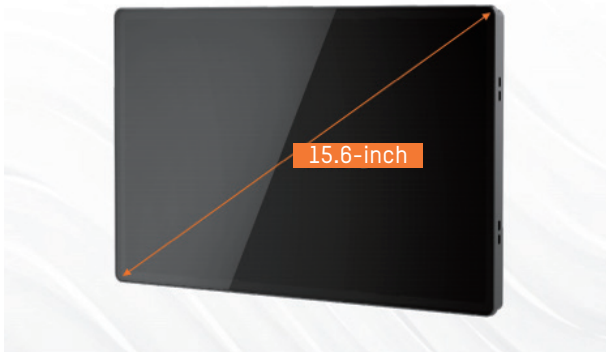

- 15.6-inch capacitive all-in-one touch screen with more rich interfaces

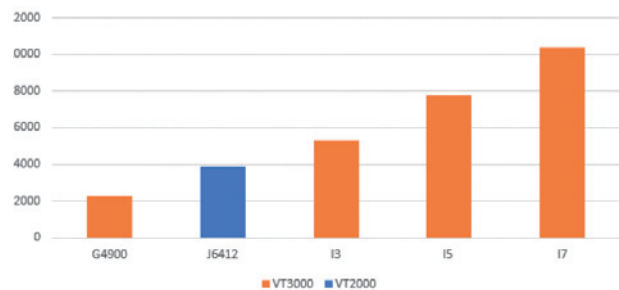

- VT3000 series provides multiple CPU models to choose from, providing the best comprehensive solution for users' different application needs

Specifications



Model	CPU	Memory	Storage	Digital I/O	GigE	USB3.0	Screen Size
MV-VT3100-128G40-NN	G4900T	8GB	128GB SSD	Opto-isolated input × 3 Opto-isolated output × 8	4	4	15.6"
MV-VT3100-128G40-2T	G4900T	8GB	128G SSD+2T HDD	Opto-isolated input × 3 Opto-isolated output × 8	4	4	15.6"
MV-VT3300-128G40-NN	I3-8100T	8GB	128GB SSD	Opto-isolated input × 3 Opto-isolated output × 8	4	4	15.6"
MV-VT3300-128G40-2T	I3-8100T	8GB	128G SSD+2T HDD	Opto-isolated input × 3 Opto-isolated output × 8	4	4	15.6"
MV-VT3500-128G40-NN	I5-8500T	8GB	128GB SSD	Opto-isolated input × 3 Opto-isolated output × 8	4	4	15.6"
MV-VT3500-128G40-2T	I5-8500T	8GB	128G SSD+2T HDD	Opto-isolated input × 3 Opto-isolated output × 8	4	4	15.6"
MV-VT3700-128G40-NN	I7-8700T	8GB	128GB SSD	Opto-isolated input × 3 Opto-isolated output × 8	4	4	15.6"
MV-VT3700-128G40-2T	I7-8700T	8GB	128G SSD+2T HDD	Opto-isolated input × 3 Opto-isolated output × 8	4	4	15.6"

Dimension

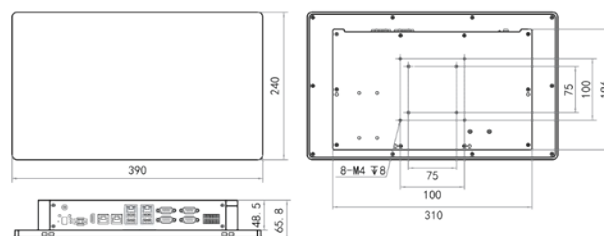

Unit:mm

VM Algorithm Development Platform

VM algorithm development platform is a machine vision software independently developed by Hikrobot, which is dedicated to providing customers with algorithm tools to quickly solve vision applications, and can meet machine vision applications such as visual positioning, size measurement, defect detection and information recognition.

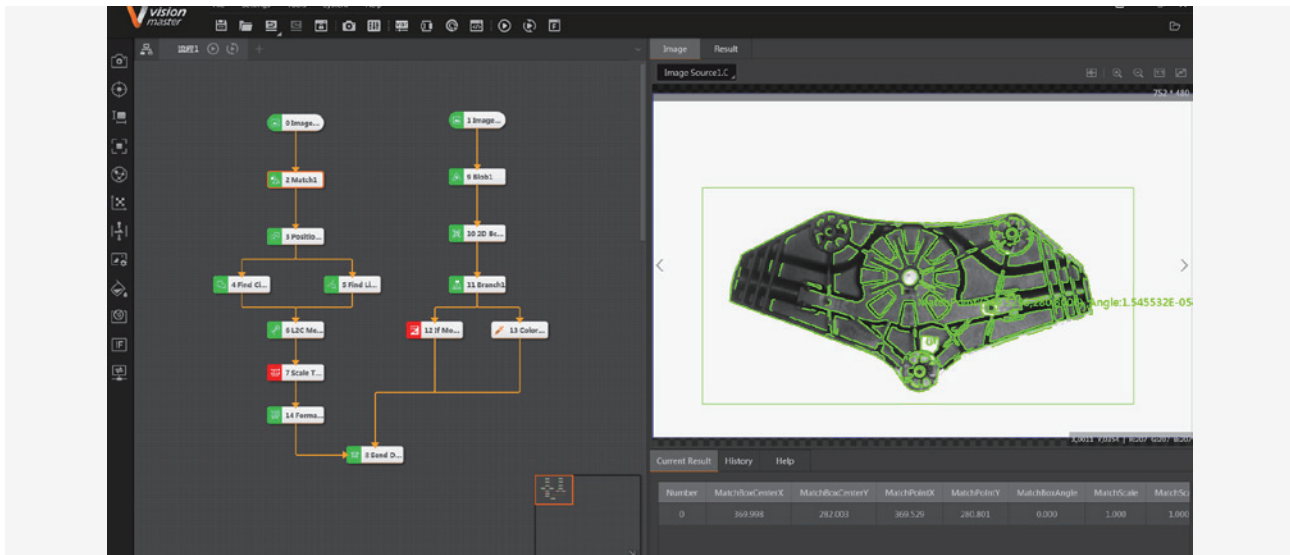

Key Features

- It consists of nearly a thousand completely self-developed image processing operators and a variety of interactive development tools, including 160 + module tools, supporting a variety of operating systems and image acquisition hardware devices.
- Fully graphical interactive interface, function icons are intuitive and easy to understand. Dragging operation can quickly set up visual scheme. Module operation status is independently identified and displayed in real time.
- Users can customize the interface, integrating background images or company logos to meet their individual needs.
- Compatible with GigE Vision and USB3 Vision protocol standards, allowing access to multiple camera brands. Support local image and camera real-time image processing.
- The secondary development is simple and easy to use. The simplified interface can save 90% of the code. The new tool can be imported into Visual Studio with one key. It supports the interface development of QT, MFC, WPF and WinForm.
- Support the development of user-defined modules. Users can directly drag and use the user-defined algorithm after it is packaged as a VM module.
- Support TCP/IP, ModBus, serial port, UDP, Ethernet/IP and other common industrial communication protocols, compatible with the communication of mainstream PLC models.

Locating and measuring tools

Accurately and efficiently locate any geometric element in the image with 1/16 pixel accuracy.

- Efficient template matching tool to overcome differences in sample translation, rotation, scaling, and illumination.
- Quickly and accurately find the position of circles, lines, blobs, edges, vertices, and other geometric objects.
- Accurately measure shapes, dimensions, areas, distances, angles, intersections, and other geometric properties.

Defect detection tools

Accurately identify defects on the surface, shape and contour of the workpiece.

- Based on deep learning technology, it can detect fine surface scratches and spots, and overcome the interference of surface texture, color and noise.
- Accurate detection of workpiece shape and contour defects, can overcome the interference of burrs, color, noise.
- Reliable tool for comparing standard parts to locate small differences in workpiece.

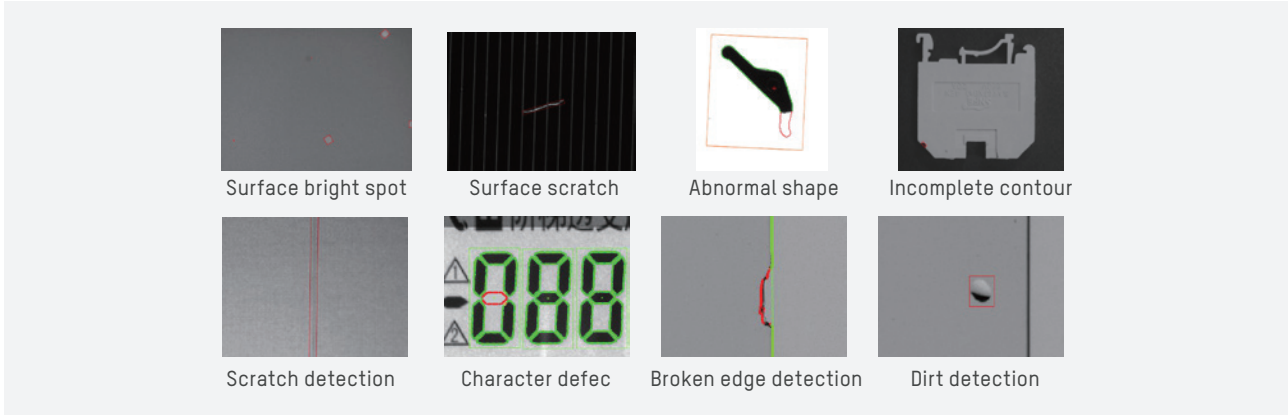

Registration learning tools

Complete visual tasks such as defect detection, recognition, and counting by online learning after registering images.

- Support GPU or CPU mode to reduce the dependence on graphics card.
- Streamlined image registration with zero offline training, accelerating project deployment.
- No need for large-scale data training, a small number of images can complete model training.



List of algorithm platform tools

Toolbox	Enumeration of Tools
Acquisition [5]	Image source, Multi-Image Acquisition, Image Output, Image Buffer, Light Source
Locating [24]	Feature Matching, Mark Locating, Position Fixture, Blob Analysis, Blob Label Analysis, Circle Search, Ellipse Find, Matrix Circle Find, Line Search, Line Search Group, Multi-Line Search, Edge Intersection, Quadrilateral Search, Parallel Line Search, Calculate Parallel Lines, Rectangle Search, Find Median Line, Find Vertical Line, Find Angle Bisector, Caliper, Edge Search, Peak Search, Path Extraction, Target Tracking
Measurement [10]	L2C Measurement, C2C Measurement, P2C Measurement, P2L Measurement, L2L Measurement, P2P Measurement, Intensity Measurement, Edge Distance Measurement, Pixel Count, Histogram
Recognition [8]	DL Code Reading, BcR, 2D BcR, DL Character Locating, DL Character Recognition, DL Single Character Detection, OCR, ML Classifier
Defect Detection [13]	Surface Defect Filter, OCV, Anomaly Detection, Edge Model Defect Detection, Edge-pair Model Defect Dection, Line Edge Defect Dection, Line-pair Defect Dection, Arc-pair Defect Dection, Arc Edge Defect Dection, Edge Combination Defect Dection, Edge-pair Combination Defect Dection, Edge Position Trend Analy, Edge Pair Position Trend Analy

Toolbox	Enumeration of Tools
Deep Learning [7]	DL Image Segmentation, DL Instance Segment, DL Object Detection, DL Classification, DL Image Retrieval, DL Unsupervised Classfy, DL Unsupervised Segmentation
Calibration [10]	N-point Calibration, N-image Calibration, CalibBoard Calibration, Camera Mapping, Mapping Calibration, Distortion Calibration, Translation Calibration, Rotation Calibration, Coordinate, Load Calibration
Calculation [11]	Single Point Alignment, Single Point Grab, Single Point Map Alignment, Single Point Rectify, Calbration Transformation, Point Set Alignment, Rotate Calculate, Line Alignment, Scale Transformation, Variable Calculation, Coordinate Transform
Image Processing [21]	Image Binarization, Image Filter, Image Morphology, Image Enhancement, Shading Correction, Image Processing Combination, Normalization, Image Computing, Image Fixture, Affine Transformation, Inverse Affine Transform, Image Resize, Geomatic Transformation, Ring Expansion, Copy Fill, Distortion Correction, Image Correction, Image Stitch, Image Clarity Estimation, Frame Mean, Multi-image Fusion
Color Processing [6]	Color Extraction, Color Measurement, Color Transformation, Color Recognition, Color Segment, Color Image Generation
Split Combination [6]	Divide Image, 2D Array Correct, Pixel Transform, Box Merge, Box Overlap, Box Filter
Image Generation [4]	Circle Fit, Ellipse Fit, Line Fit, Geometry Generation
Logic Tools [20]	Condition Branch, Condition Detection, Branch, Branch String, Save Text, Logic, Format, String Comparison, Script, Python Script, Group, Point Set, Time-consuming Statistics, Data Set, Trigger, Data Record, Graphics Set, Data Filter, Data Classification, Data Sort
Communication [5]	Receive Data, Send Data, Camera IO Output, Protocol Parsing, Protocol Assembly

Classic Application

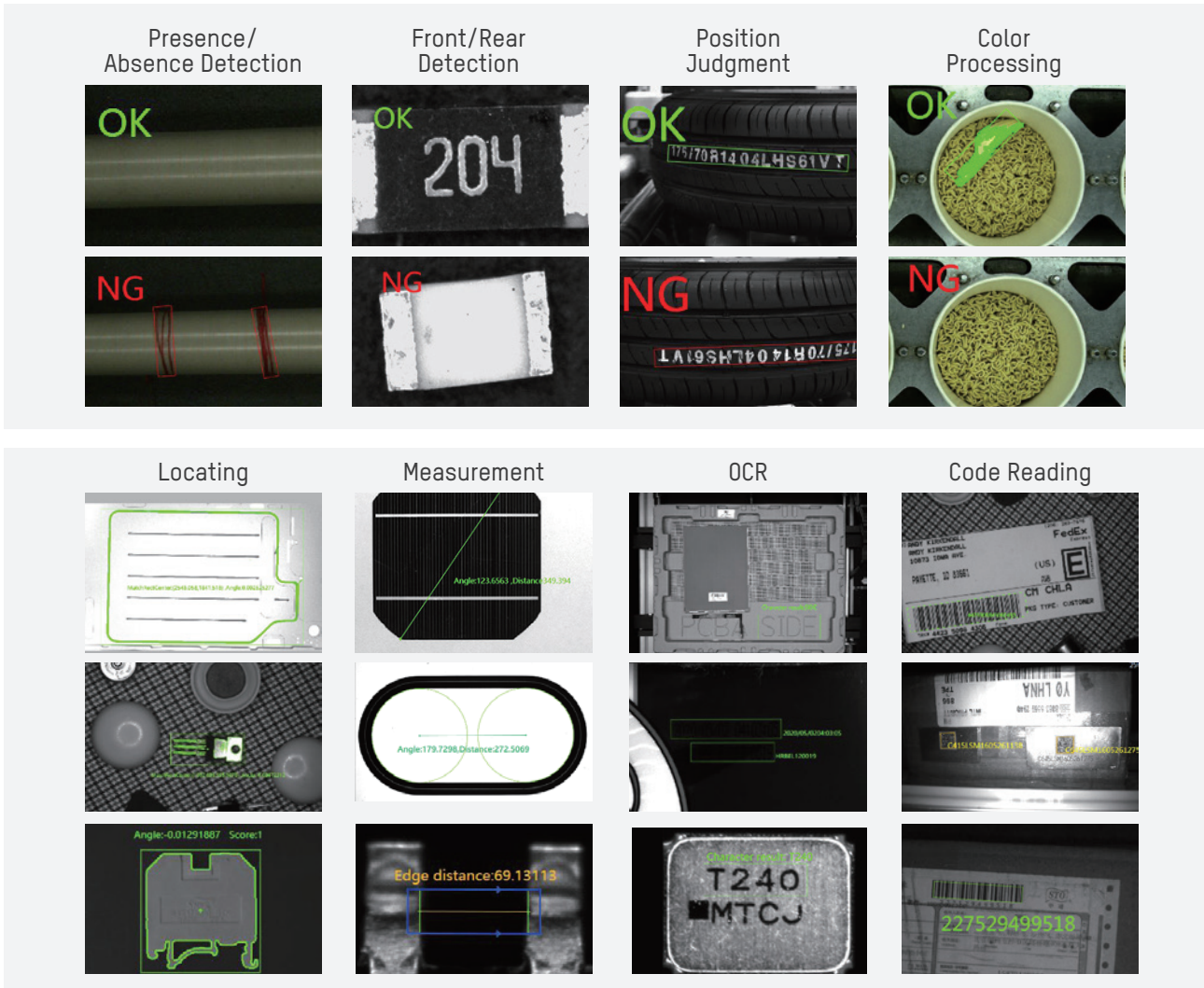

Introduction to VM secondary development

VM algorithm development platform provides users with a variety of application modes:

Mode 1: Directly use VM to build and deploy visual solutions

Mode 2: Build visual solutions in VM software and use VM platform SDK for secondary development of solutions

Mode 3: Deep development based on underlying operators

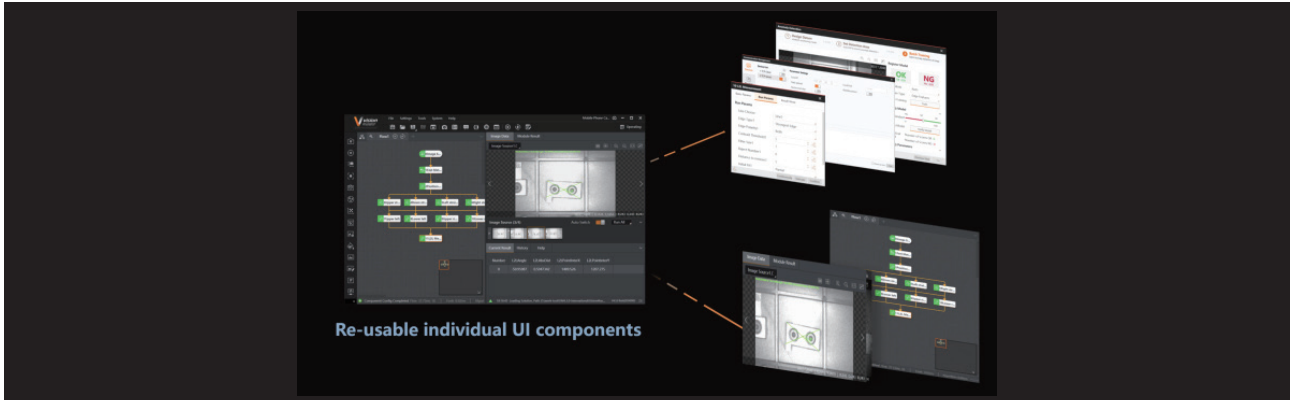

The VM algorithm development platform provides users with a simple and easy-to-use secondary development method:

Step 1: Use one line of code to load local solutions

Step 2: Run the process in your solution with three simple lines of code

Step 3: Get the running result data according to the requirements. Usually, you can get a certain data with one line of code.

Step 4: Use two lines of code to display the result data in the rendering interface

The VM algorithm development platform provides users with custom module development tools:

Users can encapsulate the required algorithms into custom modules and add them to the toolbox, and use them together with more than 160 tools that come with the platform. VM provides users with custom module development tools, which preset most of the code. Users only need a small amount of development work to generate VM modules. The application of custom modules makes VM more flexible in actual applications and can adapt to application needs in different scenarios.

Applicable Industries

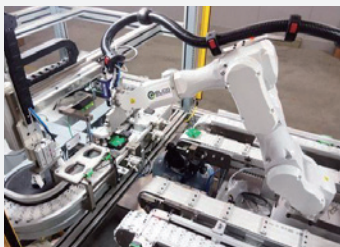

3C Manufacturing



Food/Medicine Production



Express Logistics

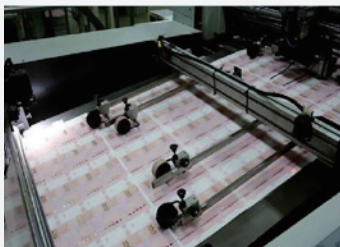

Printing and Textile



Car Manufacturing



New Energy

Application Case

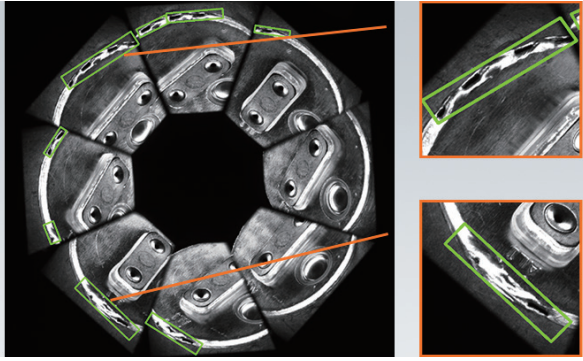

Lithium battery sealing welding defect detection: using deep learning algorithms for lithium battery sealing welding defect detection, can effectively detect welding defects such as welding offset, welding penetration, welding disconnection.

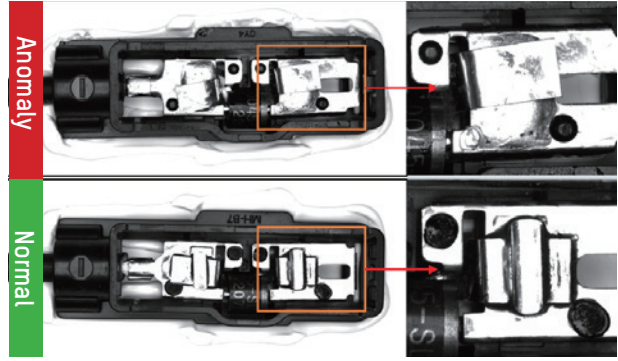

PV module junction box welding scar detection: using deep learning with traditional detection algorithms to detect PV module junction box welding scars.



PV panel defect detection: using deep learning with traditional algorithms for defect detection during EL inspection of PV panels.

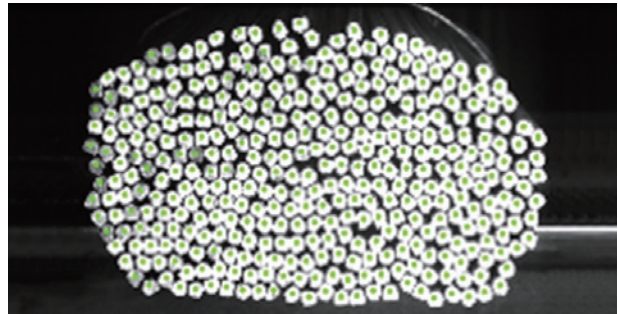

Rebar counting: use deep learning algorithm to implement counting function when rebar is bundled.

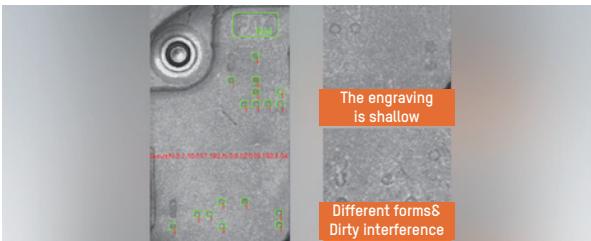

Consumer electronics industry 8421 code reading: using deep learning algorithms to extract the smallest unit of 8421 code from the complex environment, with the script module to decode it.

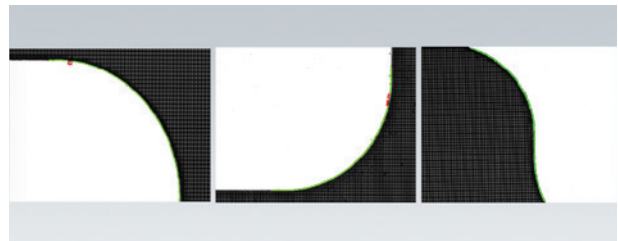

Cell phone screen edge defect detection: the use of traditional defect detection module to achieve the detection of defects on the edge of the cell phone screen.

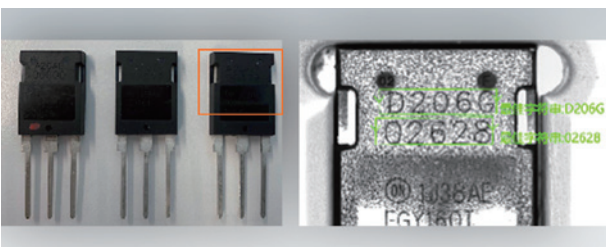

OCR recognition of electronic components: using deep learning algorithms to cope with OCR recognition of low contrast and complex backgrounds on electronic components



Food packaging character defect detection: using deep learning algorithms to achieve defect detection of spray code characters on food packaging.

CodePlatform

Hikrobot's CodePlatform is a comprehensive code-reading software platform, including data collection, image processing, communication output, data statistics and other functions. With strong compatibility and rich functions, the platform meets most demands of common code-reading application scenarios.

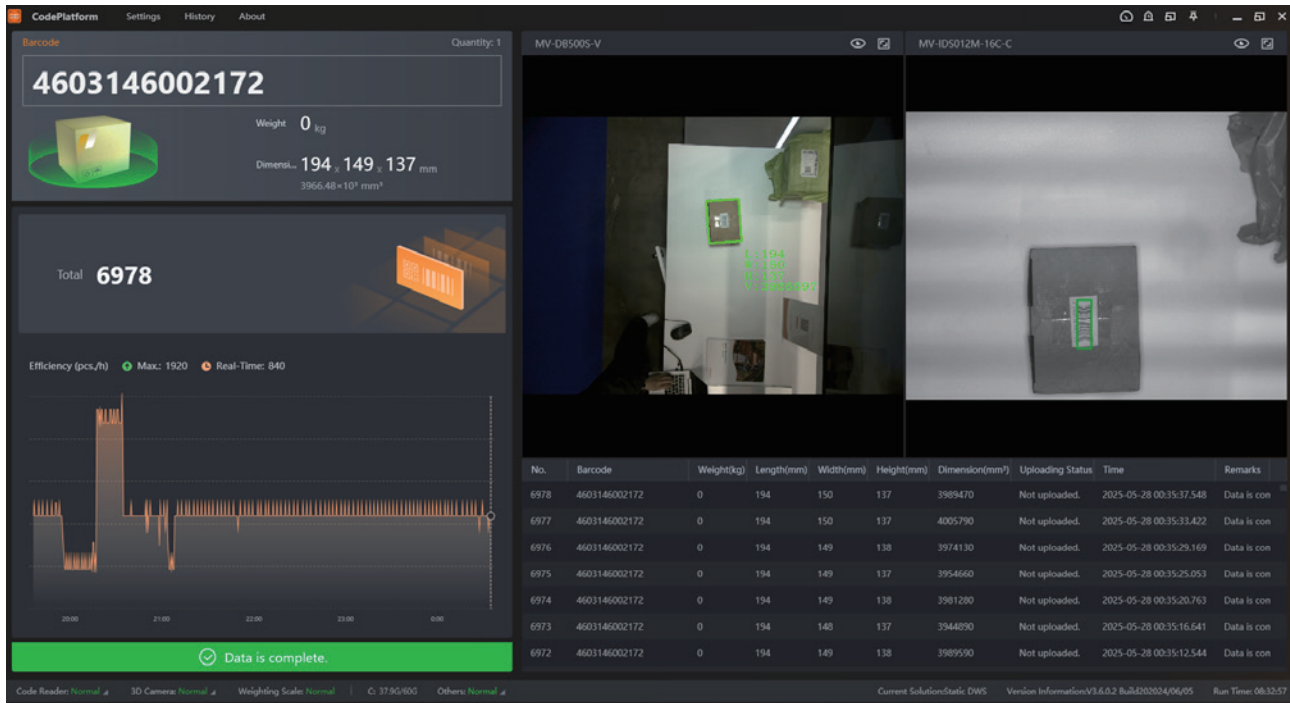

- **Multi-business scenarios:** Modular software design, high expansion, suitable for multi-business scenarios such as express logistics, pallet access door code reading, and on-site logistics workstations
- **Rich interface information:** Including real-time information area, picture display area, history record area, menu configuration area, running status display, quick function area, user rights management, etc., rich in information
- **Multi-business scenarios:** Modular software design, high expansion, suitable for multi-business scenarios such as express logistics, pallet access door code reading, and on-site logistics workstations
- **Rich interface information:** Including real-time information area, picture display area, history record area, menu configuration area, running status display, quick function area, user rights management, etc., rich in information
- **Product access:** Can access all series cameras such as code reading cameras, volume cameras, panoramic industrial cameras, and support multi-camera combination applications
- **Convenient data connection:** Supports the upgrade of a separate protocol gateway plug-in, and supports highly customized business output



Download All
Product Catalogs



Follow Hikrobot
on LinkedIn

HIKROBOT

China Headquarters:

No. 630, Qizhi Street, Binjiang District, Hangzhou,
Zhejiang Province, China

South Korea Headquarters:

F4, Pangyo Yemiji Building, 14-1, Pangyoyeok-ro
192 Beon-gil, Bundang-gu, Seongnam-si,
Gyeonggi-do, Republic of Korea

Pan-Asia-Pacific Headquarters:

2 Venture Drive, Vision Exchange, #07-22, 608526,
Singapore

Europe Headquarters:

Dirk Storklaan 3, 2132 PX Hoofddorp, Netherlands

Website: Hikrobotics.com

Email: Info@hikrobotics.com

Copyright Hikrobot

Hangzhou Hikrobot Co., Ltd. All Rights Reserved. Hangzhou Hikrobot does not tolerate any infringement. Any organization or individual may not imitate or reproduce in whole or in part of the content. The data herein is based on Hikrobot's internal evaluation. Actual data may vary depending on specific configuration and operating condition. The information herein is subject to change without notice All the content has been checked conscientiously. Nevertheless, Hikrobot shall not be liable to damages resulting from errors, inconsistencies or omissions.