

# SLOOP

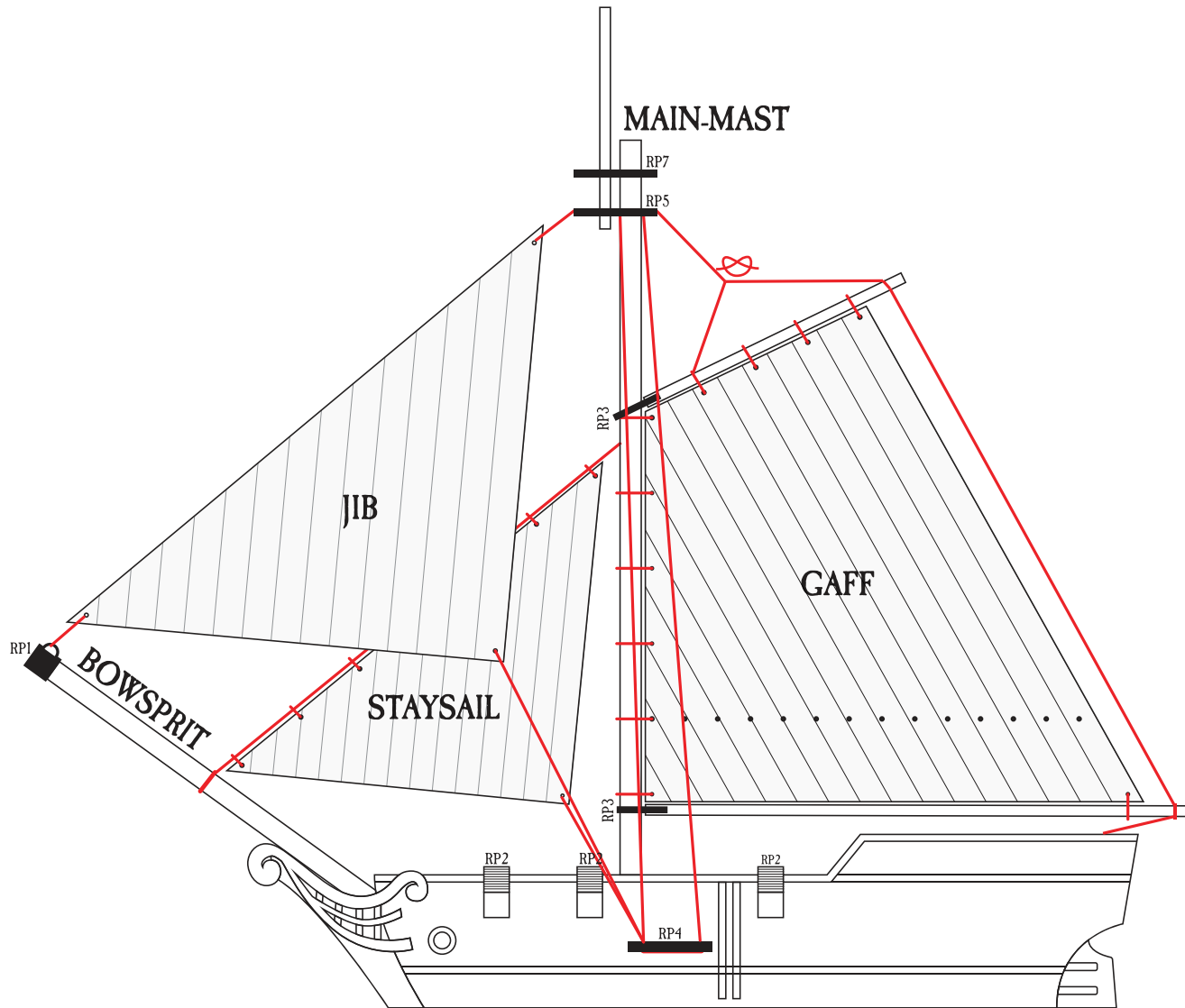





## SHIP KIT GUIDE



 KNOT   
  STRING   
  GUN PORT COVER   
  RIGGING PART

### RIGGING PARTS

QTY.

	RP1	1
	RP2	6
	RP3	2
	RP4	2
	RP5	1
	RP7	1

*Blood & Plunder*



FIRELOCKGAMES.COM

## JIB - FRONT

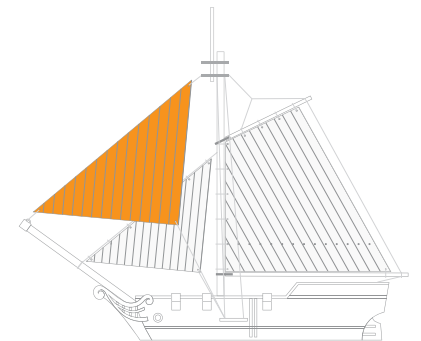
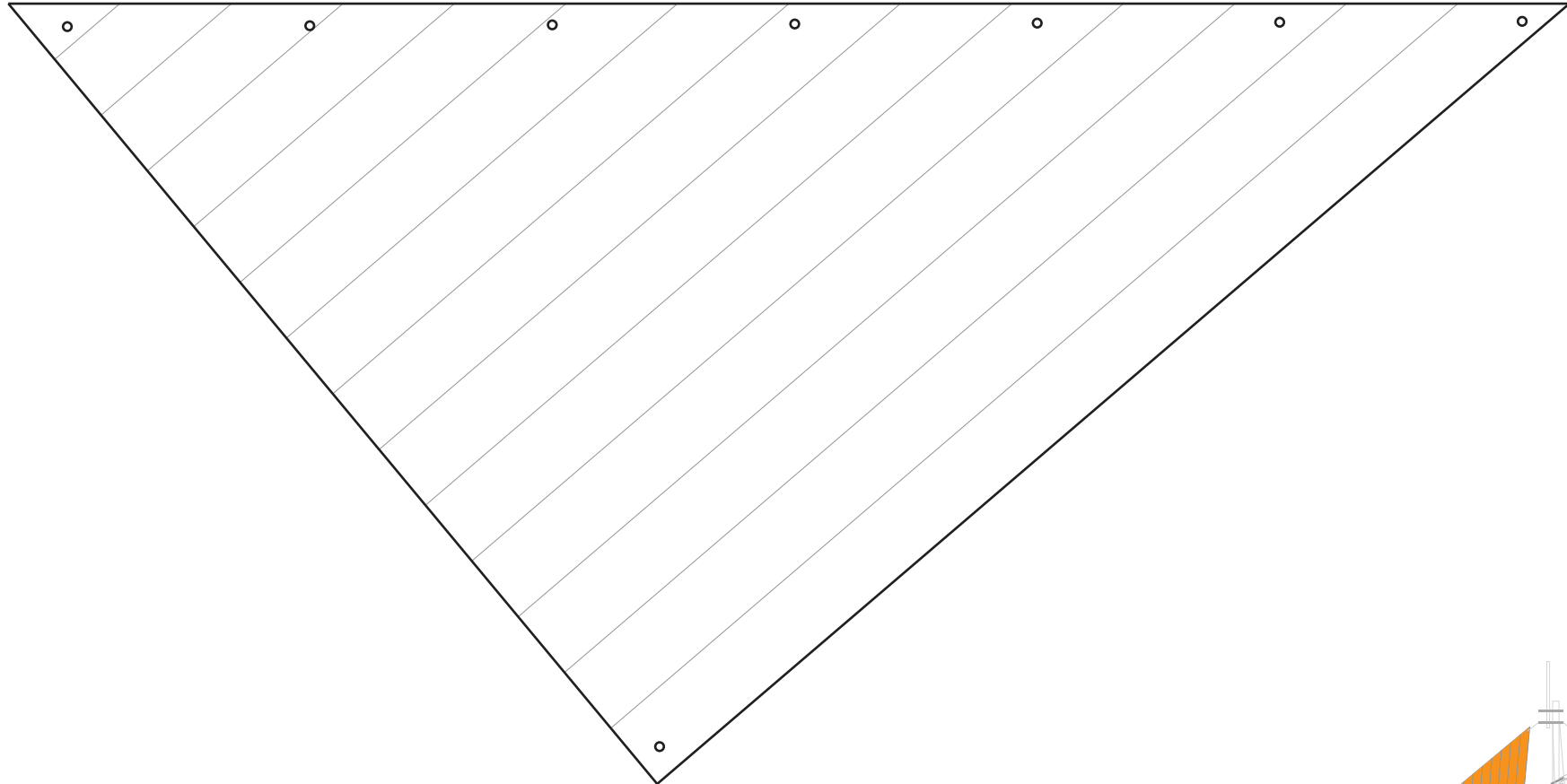

**SLOOP**  
SAILS CUT-OUT

JIB - BACK

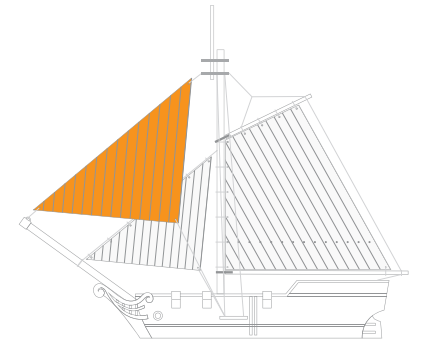
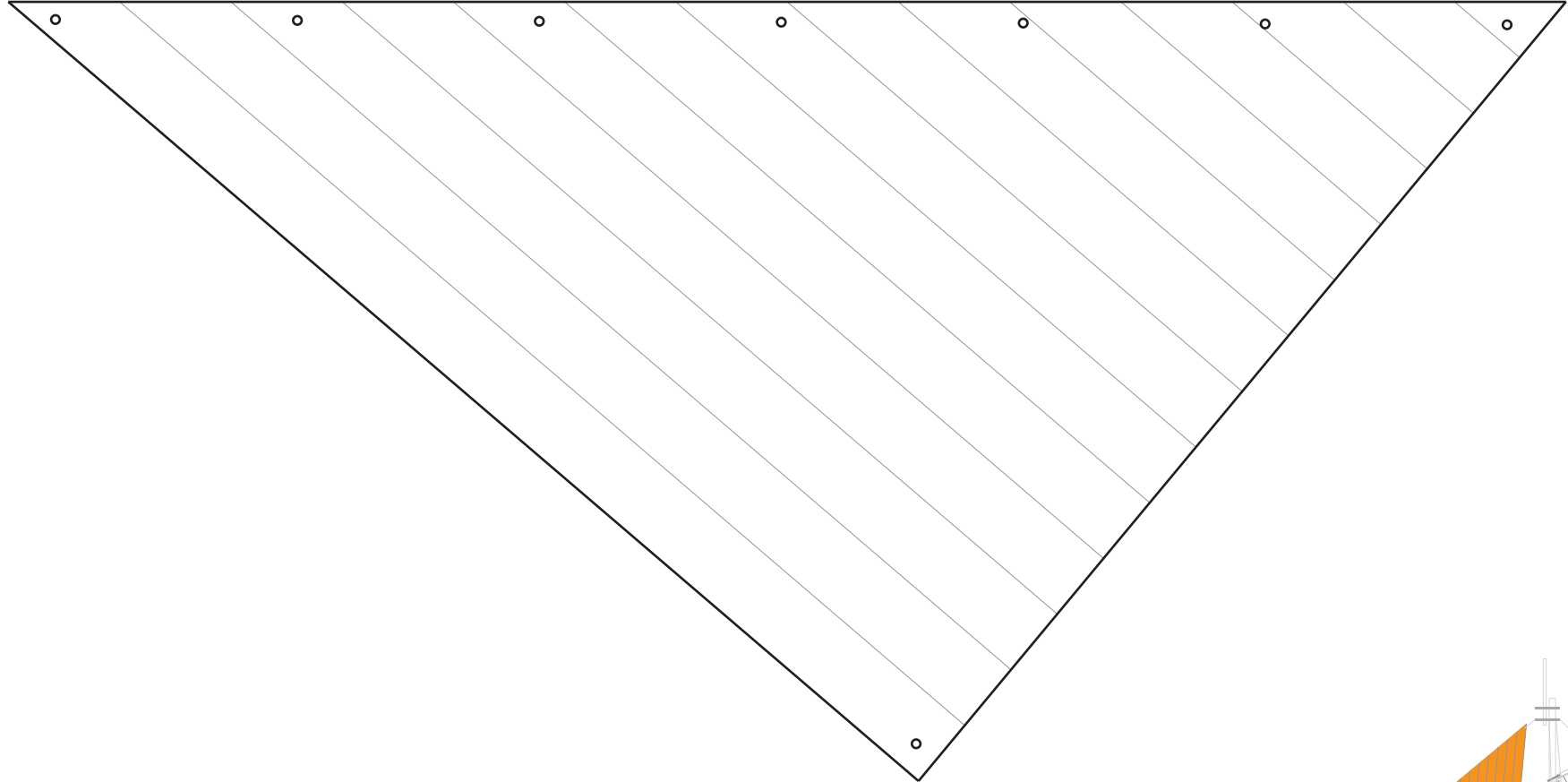

**SLOOP**  
SAILS CUT-OUT

**STAYSAIL - FRONT**

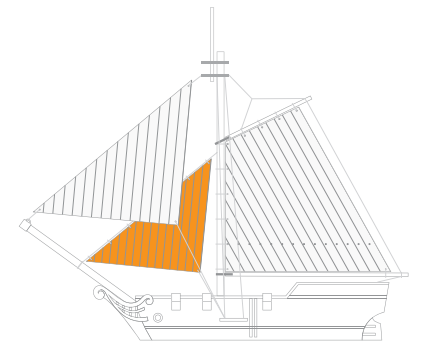
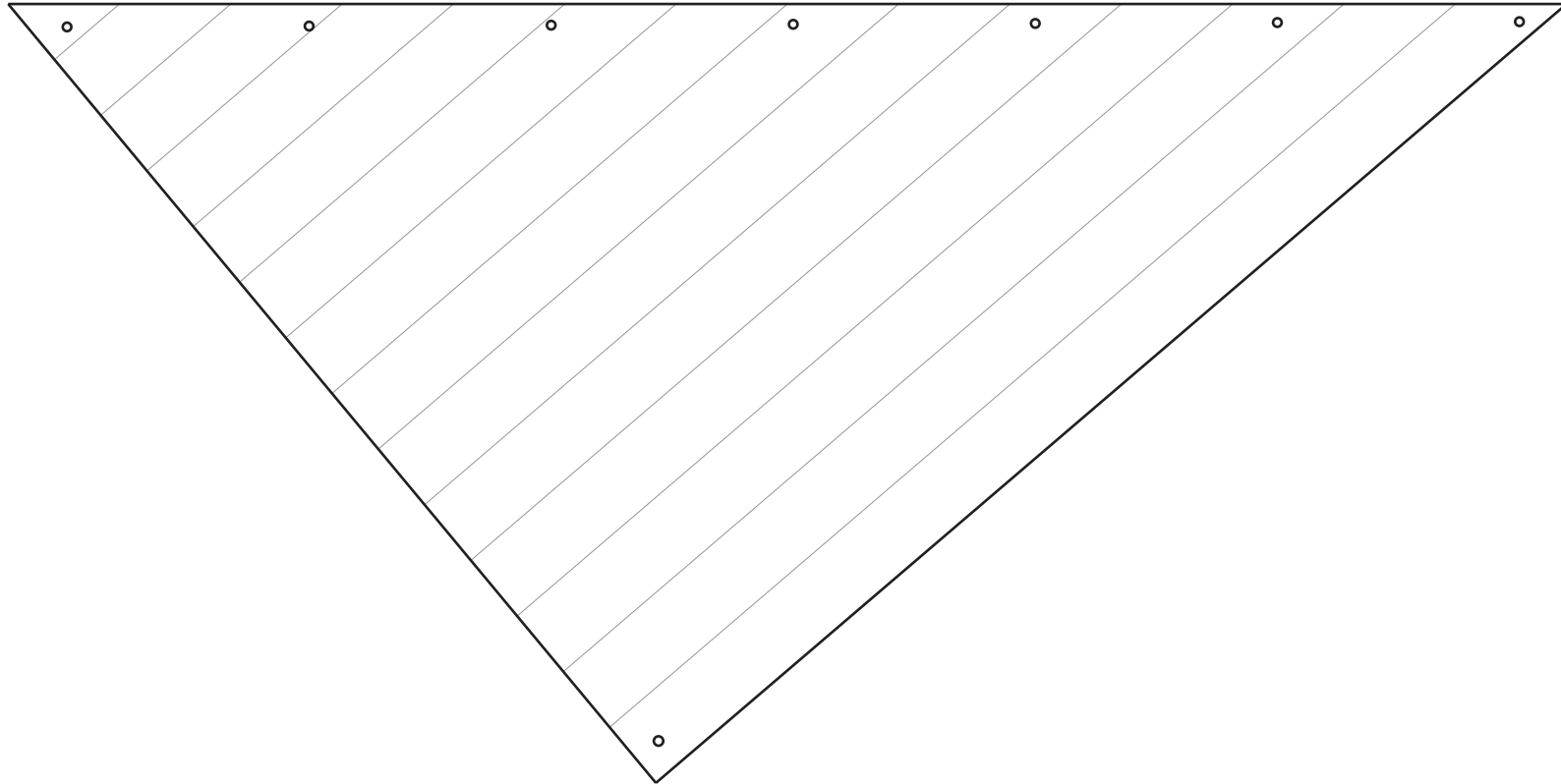

**SLOOP**  
SAILS CUT-OUT

**STAYSAIL - BACK**

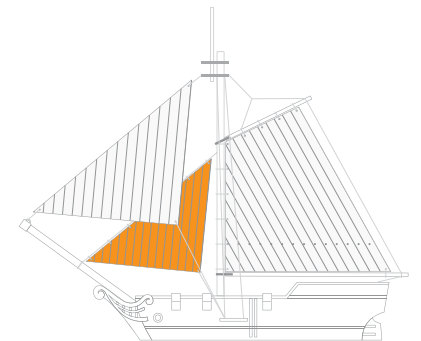
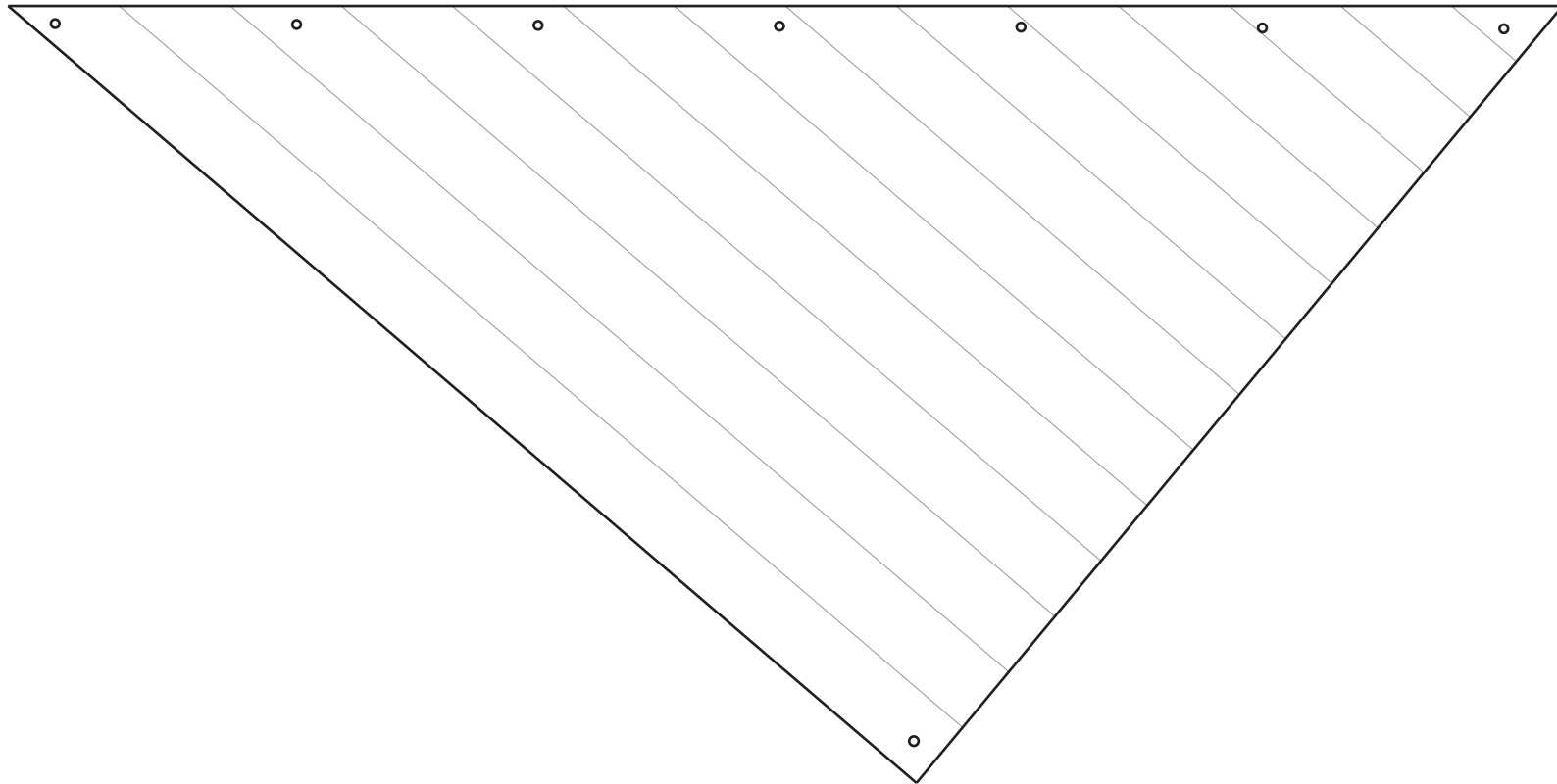

**SLOOP**  
SAILS CUT-OUT

# Blood & Plunder



Print Gaff's front and back pages with the double sided settings from your printer.

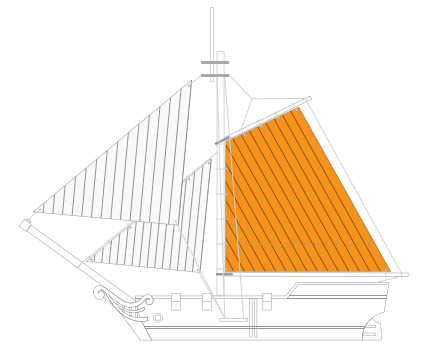
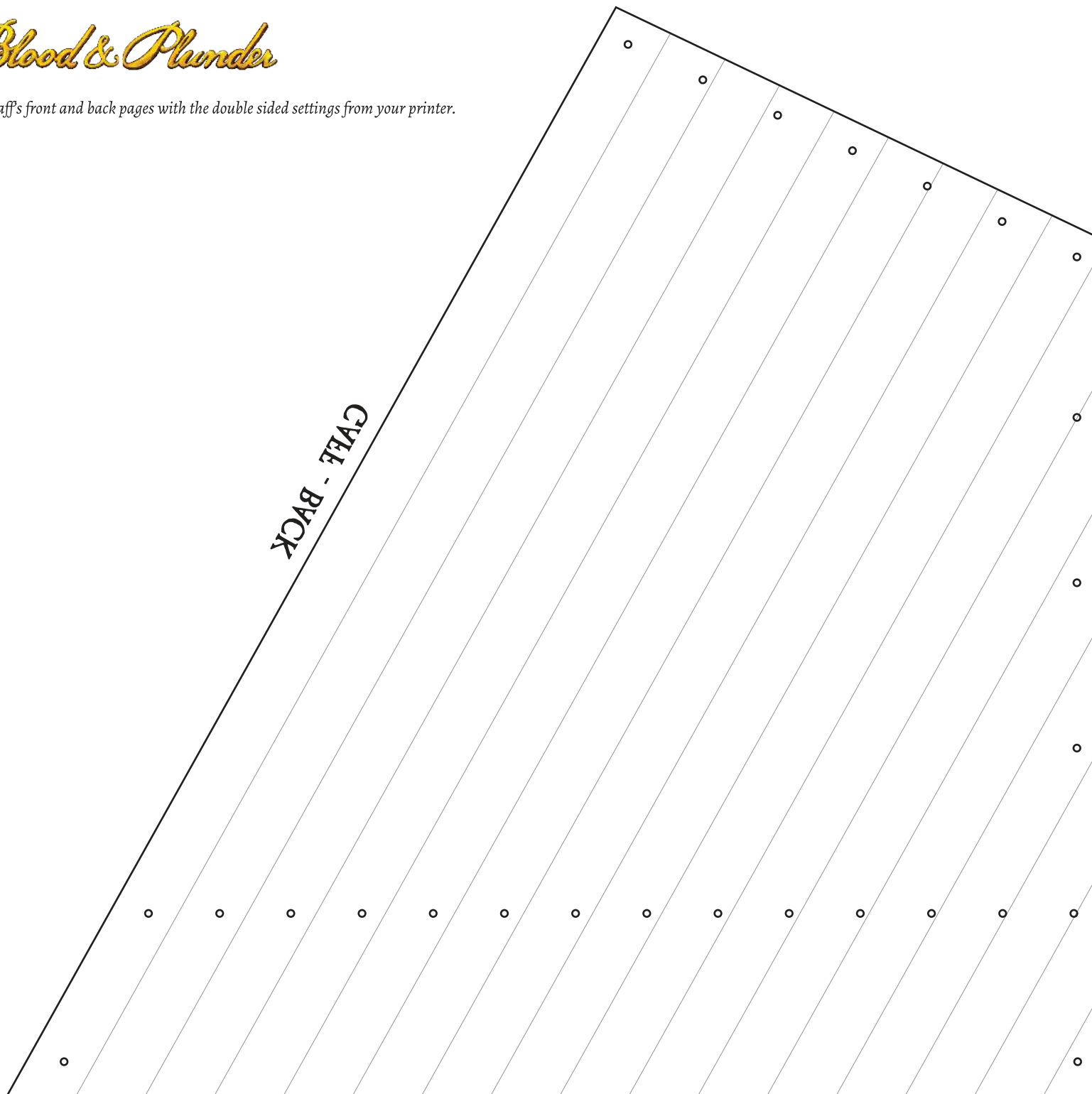

**SLOOP**  
SAILS CUT-OUT

# Blood & Plunder



Print Gaff's front and back pages with the double sided settings from your printer.

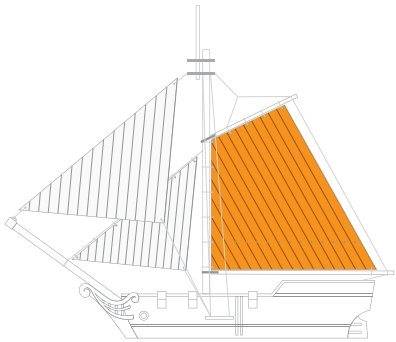
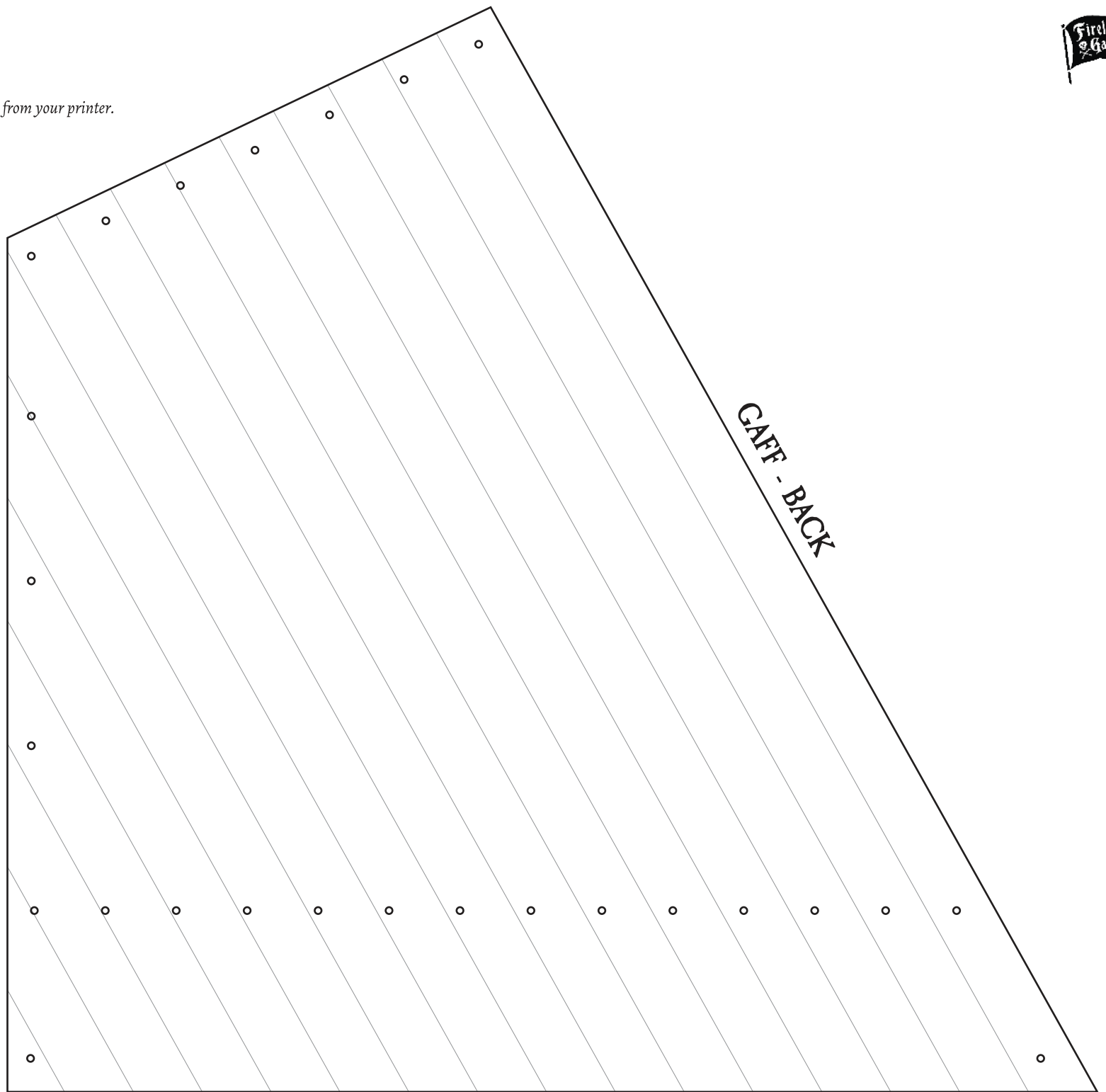

**SLOOP**  
SAILS CUT-OUT