

## Symbols Used in This Manual



### **DANGER**

Failure to follow these instructions identified by this symbol could result in death or serious injury to you and/or other people.



### **WARNING**

Failure to follow these instructions identified by this symbol could result in a fire inside your vehicle in addition to death or serious injury to you and/or other people.



### **CAUTION**

Failure to follow these instructions identified by this symbol could result in injuries or an accident.



### **ADVICE**

Failure to follow these instructions identified by this symbol could cause malfunction or damage to your vehicle.



### **NOTE**

This symbol identifies information that you need to know.

## Abbreviations

This manual uses the following abbreviations, as interpreted below.

Abbreviations	Description
ABS	Anti-lock Brake System
ACC	Adaptive Cruise Control
ACEA	Association des Constructeurs Européens d'Automobiles (Association of European Automobile Constructors)
AEB	Autonomous Emergency Braking
AHB	Automatic High Beam
API	American Petroleum Institute
ASTM	American Society for Testing and Materials
BOS	Brake Override System
BS	British Standards
BSM	Blind Spot Monitor
CONATEL	Comisión Nacional de Telecomunicaciones (National Telecommunications Commission)
CRS	Child Restraint System
DIN	Deutsche Industrie Normen
EBD	Electronic Braking force Distribution
ECE	Economic Commission for Europe
EGR	Exhaust Gas Recirculation
ELK	Emergency Lane Keeping
ELR	Emergency Locking Retractor
EPS	Electric Power Steering
ESC	Electronic Stability Control
ESS	Emergency Stop Signal
FMVSS	Federal Motor Vehicle Safety Standards
GAW	Gross Axle Weight
GSI	Gear Shift Indicator
GTW	Gross Trailer Weight
GVW	Gross Vehicle Weight
HPS	Hydraulic Power Steering
IBS	Intelligent Battery System
JASO	Japanese Automobile Standards Organization
JIS	Japanese Industrial Standards

Abbreviations	Description
LCD	Liquid Crystal Display
LDP	Lane Departure Prevention
LDW	Lane Departure Warning
LKAS	Lane Keep Assist System
LLC	Long Life Coolant
LSD	Limited Slip Differential
LSS	Lane Support System
MID	Multi-Information Display
MSL	Manual Speed Limiter
MIL	Malfunction Indicator Light
PM	Particulate Matter
RCTA	Rear Cross Traffic Alert
r/min	revolutions per minute
SAE	Society of Automotive Engineers
SRS	Supplemental Restraint System
SVS	Service Vehicle Soon
TCS	Traction Control System
TPMS	Tire Pressure Monitoring System
UN	United Nations
UNECE	United Nations Economic Commission for Europe
VIN	Vehicle Identification Number
WMI	World Manufacturer Identifier
2WD	Two Wheel Drive
4WD	Four Wheel Drive



# HOW TO USE THIS MANUAL AND HOW TO FIND A SPECIFIC TOPIC

# 0

• HOW TO USE THIS MANUAL	0-2
• HOW TO FIND A SPECIFIC TOPIC	0-3
• CHAPTER DESCRIPTION	0-5
• PICTORIAL INDEX	0-6
• WARNING/INDICATOR LIGHT INDEX	0-19
• WARNING/CAUTION LABELS	0-32

**Chapter/section titles**

These titles are useful for getting the gist of the content at a glance.

**Chapter index tab**

Use this for quick access to your desired chapter.

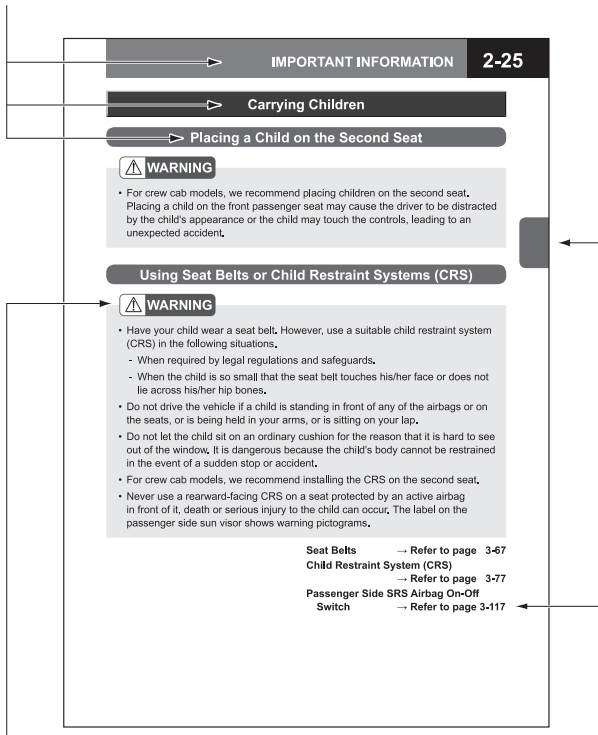

DANGER

WARNING CAUTION

ADVICE NOTE

**Symbols**

See the preceding page for the meanings of these symbols.

**Reference page**

Refers you to a page (or pages) of this manual that concerns the present topic and that you should also read.

All values in this manual are indicated primarily according to the International System of Units (or in SI units) with the conventional metric values and American units indicated in parentheses.

Note: This page is shown only as an example. It is not intended to give you information on your particular vehicle.

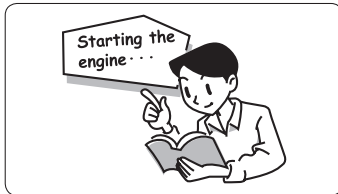

### Use chapter/section titles as keys ➔ Page 0-5

Search for the page describing the specific topic by using the general table of contents under CHAPTER DESCRIPTION, the CHAPTER INDEX, and/or the TABLE OF CONTENTS on the first page of each chapter.

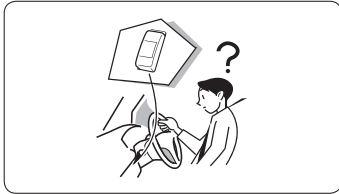

### Use the pictorial indexes ➔ Pages 0-6 to 0-18

If you do not know the name of the switch or other device for which you need information, locate the page describing it by using the pictorial indexes.



### Use device names as keys ➔ Pages 9-1 to 9-4

If you know the name of the switch or other device for which you need information, locate the page describing it by using the index at the end of this manual.

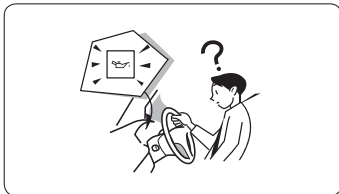

### Use the Warning/Indicator Light Index ➔ Pages 0-19 to 0-31

If a warning or indicator light is illuminated, you can use the WARNING/INDICATOR LIGHT INDEX to find the page that provides information on the light.

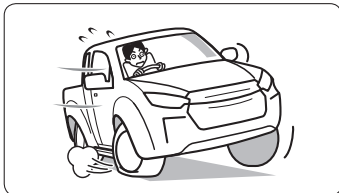

### If you have a problem with your vehicle ➔ Pages 7-2 to 7-35

Refer to IN CASE OF EMERGENCY to find measures to take.

0-4



**PICTORIAL INDEX ..... 0-6****VEHICLE INFORMATION..... 1****IMPORTANT INFORMATION ..... 2**

Describes what you should know before you can operate the vehicle safely and smoothly.

**PRE-DRIVING OPERATIONS AND ADJUSTMENTS .. 3**

Shows the proper way to open/close the doors, windows and fuel tank filler cap. Also explains how to adjust the mirrors, seats and steering including how to correctly fasten the seat belts.

**CONTROLS AND INSTRUMENTS ..... 4**

Explains how to start and stop the engine. Also describes various controls and instruments.

**COMFORT AND CONVENIENCE ..... 5**

Contains information on the air conditioning system, and other comfort and convenience features.

**SERVICE AND MAINTENANCE ..... 6**

Describes daily and periodic inspections and other vehicle care and maintenance information necessary to keep your vehicle in good condition.

**IN CASE OF EMERGENCY ..... 7**

Enumerates possible emergency situations and describes the actions you should take to deal with any one of them.

**MAIN DATA ..... 8****INDEX ..... 9**

Interior

Right-hand Drive

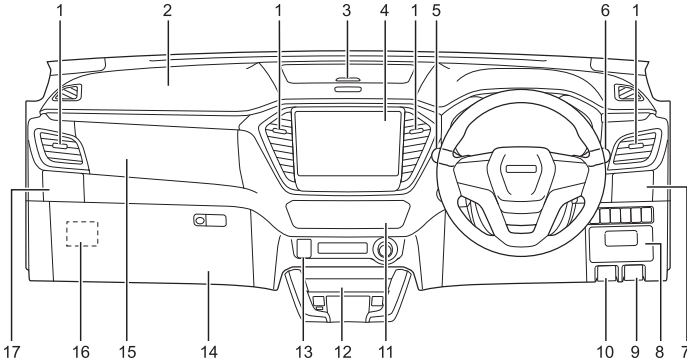

No.	Equipment	Page
1	Air flow direction control tab	5-4
2	Passenger's SRS airbag	3-96
3	Small article storage pocket (upper side of dashboard)	5-37
	Dashboard tray	5-37
4	Small article storage pocket (center of instrument panel)	5-34
	Audio system	
5	Windshield wiper and windshield washer switch	4-131

No.	Equipment	Page
6	Combination light control switch	4-117
7	Cup holder and small article storage pocket (driver's side)	5-41
8	Small article storage pocket (driver's side)	5-38
	Fuse box	7-24
9	Fuel lid opener	3-51
10	Engine hood release lever	6-12

No.	Equipment	Page
11	Automatic air conditioner	5-5
	Manual air conditioner	5-15
12	Small article storage pocket (lower part of center of instrument panel)	5-34
13	Accessory socket	5-31
14	Glove compartment	5-36

No.	Equipment	Page
15	Small article storage pocket (passenger's side)	5-35
16	Passenger side SRS airbag on-off switch	3-117
17	Cup holder and small article storage pocket (passenger's side)	5-41



## Left-hand Drive

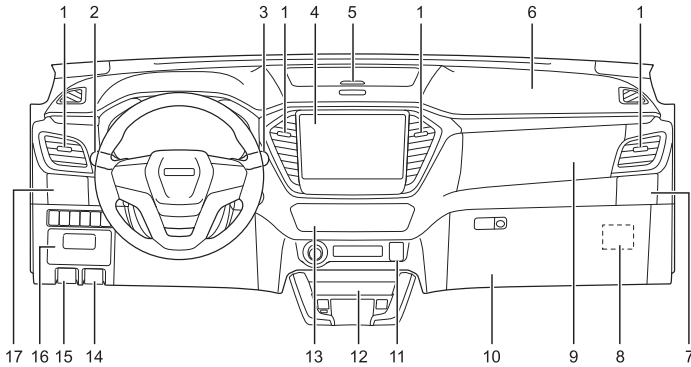

No.	Equipment	Page
1	Air flow direction control tab	5-4
2	Combination light control switch	4-117
3	Windshield wiper and windshield washer switch	4-131
4	Small article storage pocket (center of instrument panel)	5-34
	Audio system	
5	Small article storage pocket (upper side of dashboard)	5-37
	Dashboard tray	5-37

No.	Equipment	Page
6	Passenger's SRS airbag	3-96
7	Cup holder and small article storage pocket (passenger's side)	5-41
8	Passenger side SRS airbag on-off switch	3-117
9	Small article storage pocket (passenger's side)	5-35
10	Glove compartment	5-36
11	Accessory socket	5-31
12	Small article storage pocket (lower part of center of instrument panel)	5-34

No.	Equipment	Page
13	Automatic air conditioner	5-5
	Manual air conditioner	5-15
14	Engine hood release lever	6-12
15	Fuel lid opener	3-51

No.	Equipment	Page
16	Small article storage pocket (driver's side)	5-38
	Fuse box	7-24
17	Cup holder and small article storage pocket (driver's side)	5-41



## Right-hand Drive

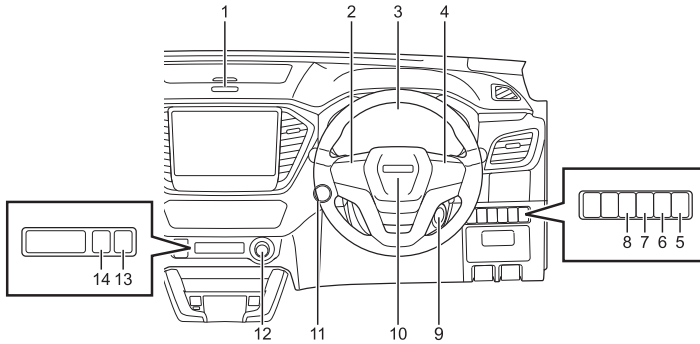

No.	Equipment	Page
1	Hazard warning flasher switch	4-127
2	Steering wheel remote control	5-47
3	Instruments, warning lights and indicator lights	4-14 4-21
4	Adaptive cruise control switch	4-245
	LSS switch	4-296
	Cruise control switch	4-151
	MID mode switch	4-28
5	Illumination control switch	4-140
6	Headlight leveling switch	4-125

No.	Equipment	Page
7	ESC OFF switch	4-164
8	TPMS load selector switch	4-322
9	Starter switch (models without passive entry and start system)	4-115
10	Horn button	4-137
	Driver's SRS airbag	3-96
11	Engine start/stop button (models with passive entry and start system)	4-112
12	4WD switch	4-311
13	Hill descent control switch	4-173
14	Rear differential lock switch	4-128

Left-hand Drive

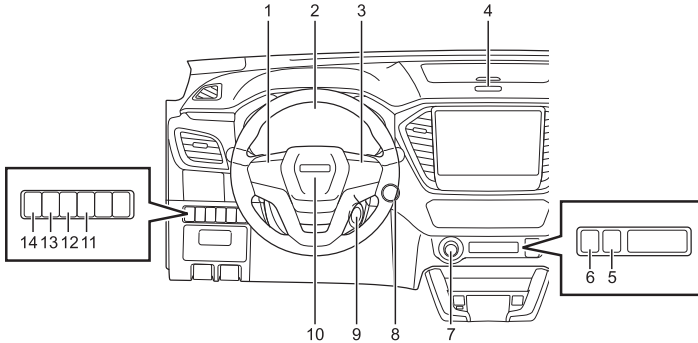

No.	Equipment	Page
1	Steering wheel remote control	5-47
2	Instruments, warning lights and indicator lights	4-14 4-21
3	Adaptive cruise control switch	4-245
	LSS switch	4-296
	Cruise control switch	4-151
	MID mode switch	4-28
4	Hazard warning flasher switch	4-127
5	Rear differential lock switch	4-128
6	Hill descent control switch	4-173

No.	Equipment	Page
7	4WD switch	4-311
8	Engine start/stop button (models with passive entry and start system)	4-112
9	Starter switch (models without passive entry and start system)	4-115
10	Horn button	4-137
	Driver's SRS airbag	3-96
11	TPMS load selector switch	4-322
12	ESC OFF switch	4-164
13	Headlight leveling switch	4-125
14	Illumination control switch	4-140

## Center Console (Right-hand Drive)

## Manual transmission model

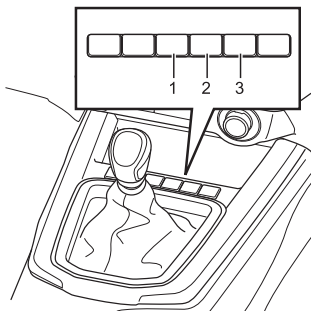

## Automatic transmission model

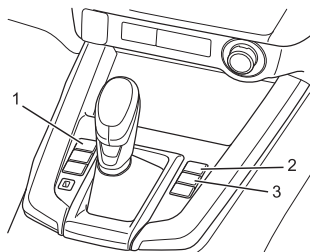

No.	Equipment	Page
1	Parking aid system OFF switch	4-209
2	Hill descent control switch	4-173
3	Rear differential lock switch	4-128

**Center Console (Left-hand Drive)**

**Manual transmission model**

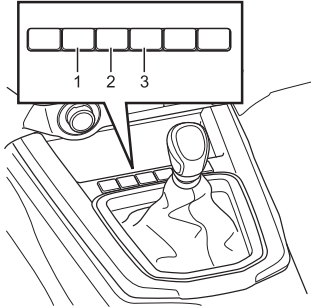

**Automatic transmission model**

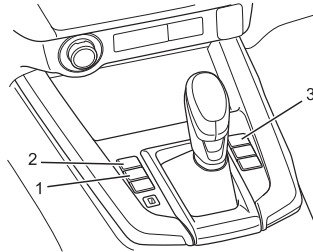

No.	Equipment	Page
1	Rear differential lock switch	4-128
2	Hill descent control switch	4-173
3	Parking aid system OFF switch	4-209

## Driver's Door (Right-hand Drive)

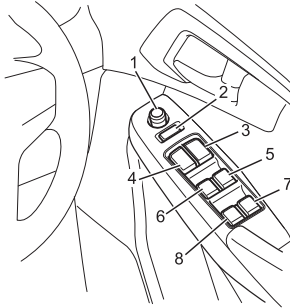

No.	Equipment	Page
1	Remote control mirror switch	4-138
2	Retractable power mirror switch	4-139
3	Power door lock switch	3-30
4	Power window lock switch	3-47
5	Power window switch (driver's side)	3-45

No.	Equipment	Page
6	Power window switch (passenger's side)	3-45
7	Power window switch (rear right side)	3-45
8	Power window switch (rear left side)	3-45

Driver's Door (Left-hand Drive)

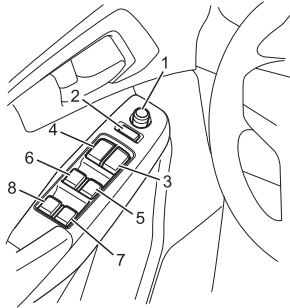

No.	Equipment	Page
1	Remote control mirror switch	4-138
2	Retractable power mirror switch	4-139
3	Power window lock switch	3-47
4	Power door lock switch	3-30
5	Power window switch (passenger's side)	3-45

No.	Equipment	Page
6	Power window switch (driver's side)	3-45
7	Power window switch (rear right side)	3-45
8	Power window switch (rear left side)	3-45

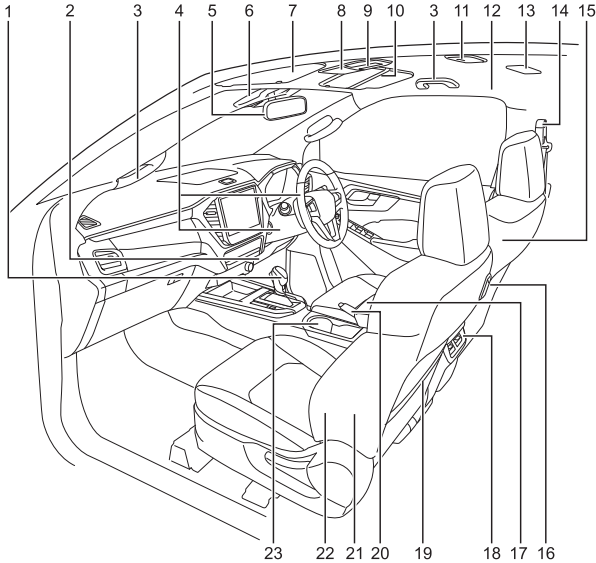

No.	Equipment	Page
1	Selector lever (automatic transmission model)	4-145
	Gearshift lever (manual transmission model)	4-144
2	Knee airbag	3-96
3	Grips	3-43
		5-44
4	Fully adjustable steering	3-63
5	Inside rearview mirror	3-64
6	Stereo camera	4-210

No.	Equipment	Page
7	Sun visor	5-30
8	Overhead console	5-29
9	Map lights	5-28
10	Ticket holder	5-30
11	Dome light	5-26
12	Curtain airbag	3-96
13	Roof speaker	
14	Seat belts	3-67
15	Far side airbag	3-96
16	Hook	5-45

No.	Equipment	Page
17	Center console box	5-39
18	USB power outlet	5-33
19	Small article storage pocket	5-34
20	Parking brake lever	4-143

No.	Equipment	Page
21	Side airbag	3-96
22	Seats	3-53
23	Cup holder	5-40



Exterior

LED Headlight Model

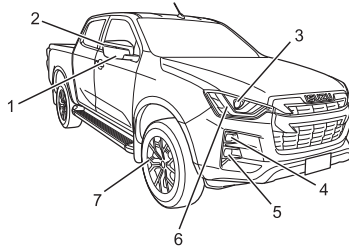

Halogen Headlight Model

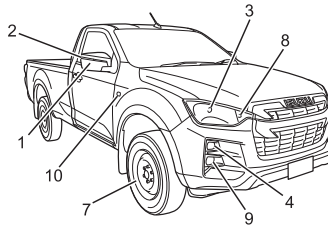













No.	Equipment	Page
1	Outside rearview mirrors	3-66
2	Turn signal light (outside rearview mirror mounted type)	6-102
3	Headlight	6-102
4	Turn signal light	6-102
5	Front fog light	6-102
6	Clearance light/daytime running light	6-102















No.	Equipment	Page
7	Tires	6-61
8	Clearance light	6-102
9	Front fog light/daytime running light	6-102
10	Turn signal light (front fender mounted type)	6-102

## Warning/Indicator Light Index















## Instrument Panel











## Warning Lights

Name	Symbol	Color	Page
Front seat belt warning light		Red	4-61
Second seat belt warning light (models with MID)		Red	4-62
Second seat belt warning light (models with LCD)		Red	4-63
SRS airbag warning light		Red	4-64
Brake system warning light		Red	4-65
Parking brake warning light		Red	4-66
ABS warning light		Yellow	4-67
ESC warning light		Yellow	4-68
Engine oil pressure warning light		Red	4-69
Engine overheat warning light (models with LCD)		Red	4-70
Generator warning light		Red	4-75
Check engine warning light/Malfunction indicator light (MIL)		Yellow	4-76

Name	Symbol	Color	Page
SVS indicator light (For models conforming to Euro 4 emission standards)		Yellow	4-77
Water separator warning light		Yellow	4-77
Fuel filter warning light		Yellow	4-77
Check trans warning light		Yellow	4-78
Automatic transmission fluid temperature warning light		Red	4-78
CHECK 4WD warning light		Red	4-79
Low fuel warning light		Yellow	4-80
LED headlight warning light		Yellow	4-81
Headlight automatic leveling warning light		Yellow	4-81
Master warning light		Yellow	4-83
Door open warning light		Red	4-84
Key monitor warning light		Red	4-85
Rear differential lock failure warning light		Yellow	4-85
Steering system failure warning light		Yellow	4-85
TPMS warning light		Yellow	4-86







**Indicator Lights**



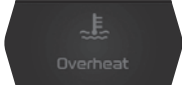
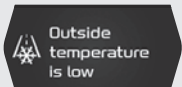

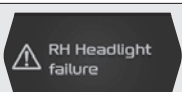
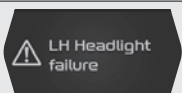





Name	Symbol	Color	Page
Turn signal indicator light – left		Green	4-87
Turn signal indicator light – right		Green	4-87
Light position indicator light		Green	4-88
High beam indicator light		Blue	4-88
Anti-theft system indicator light		Red	4-88
Front fog light indicator light		Green	4-88
Rear fog light indicator light		Yellow	4-88
Glow plug indicator light		Yellow	4-89
Rear differential lock indicator light		Green	4-89
TCS OFF indicator light		Yellow	4-90
ESC OFF indicator light		Yellow	4-91
BSM OFF indicator light		Yellow	4-92
Parking aid system OFF indicator light		Yellow	4-93
Cruise control indicator light		White/ Green	4-94





Name	Symbol	Color	Page
Adaptive cruise control indicator light		White/ Green	4-94
Manual speed limiter indicator light		White/ Green	4-94
4WD indicator light		Green	4-95
4WD low indicator light		Green	4-95
Hill descent control indicator light		Green	4-95
Automatic high beam indicator light		Green	4-95
Autonomous emergency braking OFF indicator light		Yellow	4-96
Lane departure warning OFF indicator light		Yellow	4-97
Emergency lane keeping OFF indicator light		Yellow	4-97
TPMS loading indicator light		Green	4-97

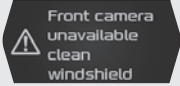
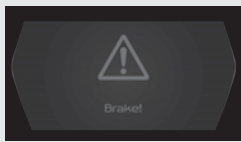

Multi-Information Display (MID)

Warning Lights

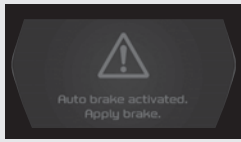
Message	Display indication	Page
Parking brake release		4-66
Overheat		4-70
Icy road		4-79
Low fuel		4-80
Headlight failure (models with LED headlight)		4-81
		
Taillight failure		4-82
		
Rear fog light failure		4-82

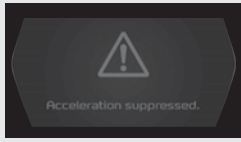
Message	Display indication	Page
Indicator light failure	 Indicator light failure	4-83
Door open		4-84
Radar unavailable	 Radar unavailable	4-92
Radar clean-up	 Radar clean-up	4-92
Radar failure	 Radar failure	4-92
Sonar unavailable	 Sonar unavailable	4-93
Sonar clean-up	 Sonar clean-up	4-93
Sonar failure	 Sonar failure	4-93
Front camera unavailable temperature	 Front camera unavailable temperature	4-219
Front camera unavailable	 Front camera unavailable	4-221

Message	Display indication	Page
Front camera unavailable clean windshield	 Front camera unavailable clean windshield	4-223
Front camera malfunction service required	 Front camera malfunction service required	4-225
Brake!	 Brake!	4-230 4-258
Auto braking	 Auto braking	4-230
Auto brake activated. Apply brake.	 Auto brake activated. Apply brake.	4-231
Accelerator pedal misapplication!	 Accelerator pedal misapplication!	4-241
Acceleration suppressed.	 Acceleration suppressed.	4-241

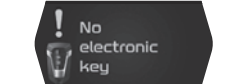
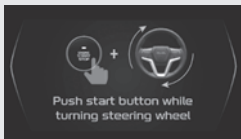





Message	Display indication	Page
Check engine hood	 A dark rectangular display showing a car with its hood open. Below the car, the text "Check engine hood" is displayed.	4-97
Switch off the lights	 A dark rectangular display showing a car with its headlights on. Below the car, the text "Switch off the lights" is displayed.	4-98
Key remain (models without passive entry and start system)	 A dark rectangular display showing a car key. Below the key, the text "Collect your key" is displayed.	4-98
No electronic key (models with passive entry and start system)	 A dark rectangular display showing a lightbulb icon with an exclamation mark above it. To the right, the text "No electronic key" is displayed.	4-99
Steering wheel lock not released (models with passive entry and start system)	 A dark rectangular display showing a hand icon pointing to a start button, a plus sign, and a steering wheel icon. Below the icons, the text "Push start button while turning steering wheel" is displayed.	4-100



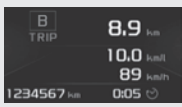

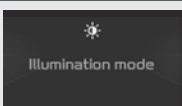

Message	Display indication	Page
<p>Shift position (models with passive entry and start system)</p>	 <p>Shift to neutral</p>	<p>4-101</p>
	 <p>Shift to P</p>	
	<p>To power off shift to P then push start button</p>	
<p>Turn off the power (models with passive entry and start system)</p>	 <p>Turn off the power</p>	<p>4-102</p>
<p>Low battery electronic key (models with passive entry and start system)</p>	 <p>Low battery electronic key</p>	<p>4-102</p>
<p>Check system (models with passive entry and start system)</p>	 <p>Check system</p>	<p>4-103</p>
<p>Power management system (models with passive entry and start system)</p>	 <p>Power management system error</p>	<p>4-104</p>

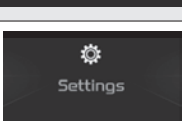
Message	Display indication	Page
Steering wheel lock system (models with passive entry and start system)		4-104
Lane support canceled.		4-283 4-292 4-301
Hold steering wheel! (Yellow)		4-301
Hold steering wheel! (Red)		4-301
Take a break?		4-305
TPMS		4-38



### Indicator Lights

Message	Display indication	Page
Remote engine start mode		3-123
Maintenance reminder		4-30
Trip meter A and operation-related information display		4-33



Message	Display indication	Page
Trip meter B and operation-related information display		4-33
Eco graph display		4-34
Illumination mode		4-37
2H (2WD)		4-39
4H (4WD)		4-39
4L (4WD low)		4-39
Rear differential lock		4-39
Settings		4-40

Message	Display indication	Page
Cruise control canceled.	 A black hexagonal display with a white icon of a crossed-out steering wheel and the text "Cruise control canceled." below it.	4-155 4-266
Accessory mode (models with passive entry and start system)	 A black rectangular display with white text: "Accessory mode" and "To start depress the clutch select neutral then push start button".	4-105
	 A black rectangular display with white text: "Accessory mode" and "To start depress the brake then push start button".	
Low battery engine starting (models with passive entry and start system)	 A black rectangular display with a white icon of a key and a start button, and the text "Put electronic key close to start button".	4-105
	 A black rectangular display with white text: "Information" and "To start depress the clutch select neutral then push start button".	
	 A black rectangular display with white text: "Information" and "To start depress the brake then push start button".	
Display of the detection status (models with parking aid system)	 A black rectangular display with a white top-down view of a car and its surroundings, with the text "Look your surroundings for safety." below it.	4-202

Lower Part of Center of Instrument Panel

Name	Symbol	Color	Page
Passenger side SRS airbag ON indicator light		Yellow	3-118
Passenger side SRS airbag OFF indicator light		Yellow	3-118

Outside Rearview Mirrors

Name	Symbol	Color	Page
Blind spot indicator - right		Yellow	4-184 4-193
Blind spot indicator - left		Yellow	4-184 4-193

Windshield

Name	Color	Page
Forward collision warning	Red	4-234

### Warning/Caution Labels in Your Vehicle

- The warning/caution labels in your vehicle indicate very important instructions and information that you should respect to ensure safe and proper use of the vehicle. Be sure to read them before using the vehicle.
- If any of these labels are peeling or illegible due to wear or scratches, please contact your Isuzu Dealer for a replacement.
- Some examples of warning/caution labels are indicated on the following pages, but there are many others not shown. Also, the contents of these labels may vary from model to model.
- The warning/caution labels indicated may be located differently in your vehicle.

### Warning/Caution Labels – Cab Interior

#### Driver's side

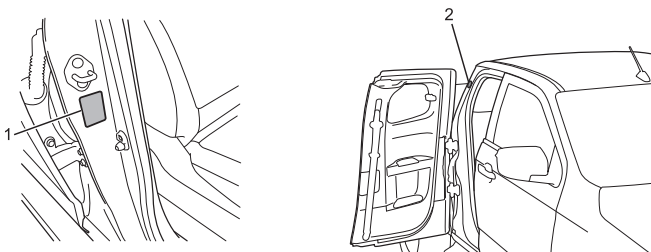

#### Passenger's side

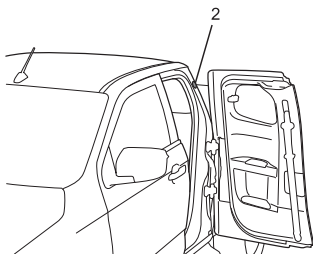

No.	Description
1	Tire air pressure
2	Warning to avoid trapped hands in side access panel (Extended cab model)

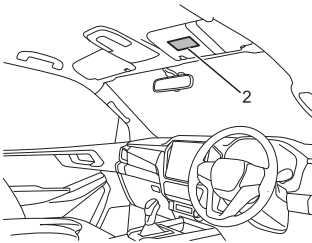
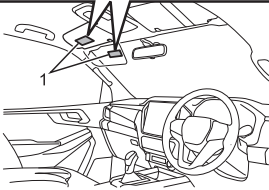

No.	Description
1	Passenger's SRS airbag

**WARNING**

- Never use a rearward-facing CRS on a seat protected by an active airbag in front of it, death or serious injury to the child can occur.

**Child Restraint System (CRS)**

→ Refer to page 3-77

**Passenger Side SRS Airbag On-Off Switch**

→ Refer to page 3-117

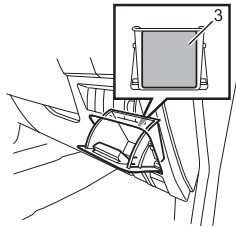

No.	Description
2	2WD - 4WD selection
3	Fuse

## Warning/Caution Labels – Engine Compartment

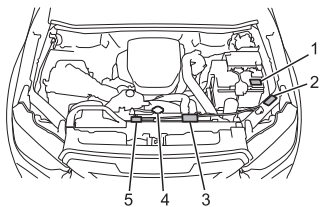

No.	Description
1	Battery
2	Vehicle warranty
3	Engine coolant (4JJ3 engine model)
4	Radiator cap
5	Engine coolant (RZ4E engine model)

# VEHICLE INFORMATION

# 1

- 
- **Vehicle Identification Number (VIN) and Engine Number** 1-2
-

**Vehicle Identification Number (VIN) and Engine Number**

The VIN and engine number are necessary for registering your vehicle. They are also necessary when your vehicle undergoes official inspections. Provide your Isuzu Dealer with these numbers when you are having the vehicle repaired or are ordering replacement parts. The Dealer will be able to do the requested jobs more competently and quickly.

**VIN****VIN Location on Frame**

The VIN is stamped on the right side center part of the frame.

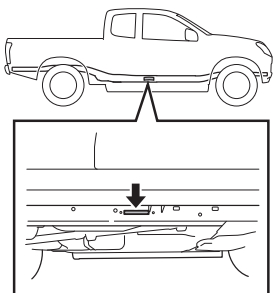
**VIN Label (Front Left Side of Windshield)**

The VIN label is located in the front left side of the windshield.

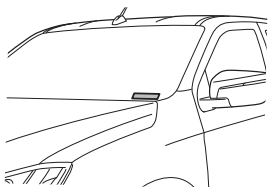

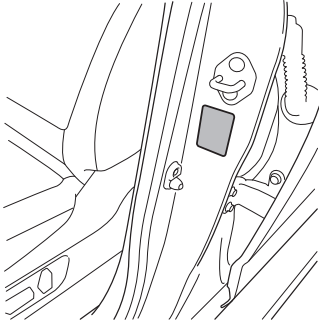
**Regular/crew cab models****Vehicle Certification Label**

The label located on the passenger's b-pillar indicates the VIN together with other information such as legal vehicle mass ratings.

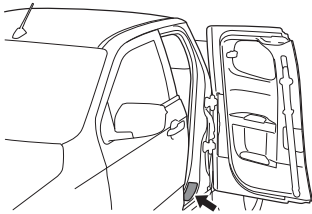
**Extended cab models**

# 1-4

## VEHICLE INFORMATION

The VIN contains multiple pieces of information including the vehicle and engine model codes as shown below.



### ADVICE

- Interpretation of the VIN may differ depending on the market. For further details, please ask your Isuzu Dealer.

M	P	A	T	F	R	8	7	J	N	T	0	0	0	0	0	1
1			2		3		4		5							

Section	Description
1	World Manufacturer Identifier (WMI)
2	Model code TFR40J: 4 2, Long wheel base, 4JJ3 engine model TFS40J: 4 4, Long wheel base, 4JJ3 engine model TFR87J: 4 2, Long wheel base, RZ4E engine model TFS87J: 4 4, Long wheel base, RZ4E engine model
3	Model year code M: 2021 model N: 2022 model P: 2023 model R: 2024 model S: 2025 model
4	Plant code
5	Production sequential number

### Option Codes

The ID plate also indicates option codes. These codes are three-digit, alphanumeric codes, each assigned to a particular component of the vehicle.

You will be able to use these codes to identify the model or type of engine, transmission or other components when your vehicle needs inspection and other services.

Option Codes	Engine	Option Codes	Suspension
LNG	4JJ3-TCX	7YC	2WD High-Ride
RDZ	RZ4E-TC	G50	Rear, heavy duty

Option Codes	Transmission	Option Codes	Other components
Y6A	AWR6B45	NW9	Electronic stability control
Y6P	MVL6Y	8CL	Differential lock
Y6S	MVL6S	K30	Cruise control
		K59	Adaptive cruise control



#### ADVICE

- There are more option codes than those indicated above. Depending on the market, an option code may not be shown. For detailed specifications of your vehicle, please ask your Isuzu Dealer.

## Engine Number

## 4JJ3 engine model

Front

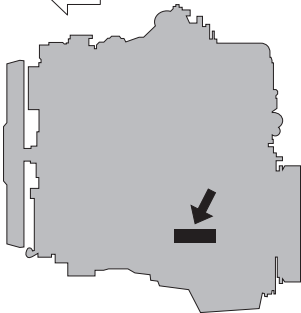

The engine number is stamped on the left side rear part of the engine block.

## RZ4E engine model

Front

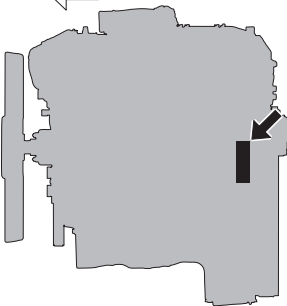

• Before Driving	2-2
• Seat Belt with Pretensioner and SRS Airbag System	2-20
• Carrying Children	2-25
• Driving	2-28
• Off-road Driving	2-46
• Trailer Towing	2-47
• Automatic Transmission Model	2-55
• Four Wheel Drive (4WD) Model	2-60
• Stopping and Parking	2-63
• Cautions for Driving in Hot Regions	2-70
• Cautions for Driving in Cold Regions	2-71
• Staying Safe	2-76
• Preventing Breakdowns	2-80
• When to Visit Your Isuzu Dealer	2-84
• Speed Limit Device	2-87
• Vehicle Data Collection	2-87

This chapter contains information and cautions that you should observe for safe and comfortable vehicle operation. Be sure to read it before using the vehicle.

## Before Driving

Proper care and driving is important not only in extended service life of your vehicle, but also in improved fuel and oil economy. Drive carefully and defensively.

### Perform Daily (Pre-operation) Inspections

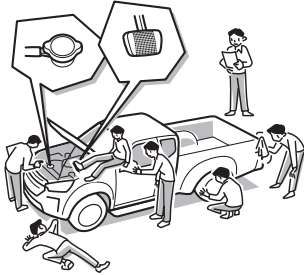

#### ADVICE

- For safe and comfortable driving, keep record of the distances driven and the condition of the vehicle during operation. Perform inspections at appropriate intervals, and perform maintenance in accordance with the findings of the inspections. If an inspection reveals an abnormality or there was an abnormality the previous time the vehicle was driven, have the vehicle repaired by the nearest Isuzu Dealer before it is driven again.

#### Daily Checks (Preoperational Checks)

→ Refer to page 6-16

Use the Specified Fuel

 **WARNING**

- Open the fuel tank filler cap slowly. If you open it quickly, the fuel tank pressure may cause fuel to spurt out.
- Use diesel fuel that is specified by the relevant vehicle emission standards. For specified diesel fuel, check "Recommended Fluids, Lubricants and Diesel Fuels".
- Do not add or mix in poor quality fuels, or gasoline, kerosene, alcohol-based fuels, or any fuels that are not diesel, or water removing agents or other fuel additives. Starting the engine with inappropriate fuel in the tank is very dangerous because it may adversely affect the fuel filter and cause poor movement of fuel-lubricated parts in the injectors, in addition to adversely affecting engine components, and could possibly result in a breakdown or even a fire.
- If inappropriate fuel is accidentally added to the tank, drain it out completely.

 **CAUTION**

- Using diesel fuel other than those specified by the relevant vehicle emission standards could prevent the vehicle from complying with local legal requirements.

 **ADVICE**

- Do not use diesel fuel with higher sulfur content than the diesel fuel that is specified by the relevant vehicle emission standards. Using high-sulfur diesel fuel may adversely affect the engine, exhaust emission reduction system, or EGR system, possibly resulting in a breakdown.



**Fuel Tank Filler Cap**

→ Refer to page 3-49

**Fuel**

→ Refer to page 2-72

**Recommended Fluids, Lubricants and Diesel Fuels**

→ Refer to page 6-144

## Using Self-service Filling Stations

 **WARNING**

[Be sure to obey the following instructions when refueling the vehicle]

- Stop the engine and close the vehicle's doors and windows.
- Keep cigarettes and other flames away from the vehicle.
- Before opening the fuel tank filler cap, touch a metallic object to discharge static electricity from your body. If you have a static charge buildup on your body while refueling the vehicle, a spark caused by its discharge could ignite the fuel, resulting in burns.
- When filling, insert the nozzle deeply into the fuel filler neck. If you try to fill more fuel by pulling out the nozzle from the fuel filler neck, fuel may spill out, causing danger.
- All parts of the refueling procedure (from opening the fuel tank filler cap to completing the refueling and closing the fuel tank filler cap) must be performed by the same person.  
Other people may be carrying static electricity. Do not allow them to approach the fuel filler.  
The person performing the refueling procedure must not return to the seat in the cab part-way through the procedure. He/she could pick up another charge of static electricity by doing so.
- Obey all cautions posted in filling stations.
- Be sure to wipe off the fuel that is spilled at refueling.

 **CAUTION**

[Caution when refueling the vehicle]

- Be careful not to inhale fuel vapor when refueling the vehicle.

**Fuel Tank Filler Cap**

→ Refer to page 3-49

## Economical Driving

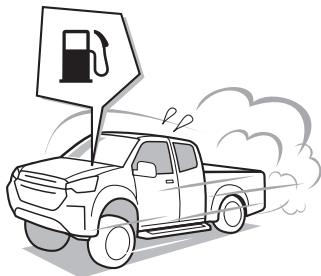

### **Avoid Unnecessary Engine Idling and Revving the Engine**

Idling the engine for longer than necessary is a waste of fuel. The engine is sufficiently warmed up when level of the engine coolant temperature gauge is indicated. Stop the engine when waiting for people or unloading cargo, etc., even if the vehicle is only parked for a short period of time. Revving the engine will not only waste fuel, but people nearby will also be inconvenienced due to noise and exhaust gases. Do not rev the engine.

### **Avoid Sudden Starts and Sudden Acceleration**

Sudden starting and acceleration cause the fuel consumption to increase significantly. Try to use smooth acceleration without depressing the accelerator pedal excessively.

### **Drive at an Economical Speed**

Driving too fast causes increased fuel consumption. Be sure to drive within the legal speed limit. In addition, repeated starting and stopping, acceleration and deceleration will significantly increase fuel consumption. Aim to drive at a constant speed as much as possible.

### **Drive in the Appropriate Gear**

Over-revving the engine when accelerating and driving at a low speed in a high gear will increase fuel consumption. Select the appropriate gear according to the traffic conditions and the load being carried.

### **Avoid Traffic Jams and Plan Your Journey in Advance**

Driving on traffic jams will increase fuel consumption. Avoid traffic jams and plan your journey in advance as much as possible.

### **Unload Any Unnecessary Cargo Before Driving**

The heavier the load being carried, the more that fuel consumption will increase. Unload any unnecessary cargo before driving. Mud and snow adhering to the vehicle body will also increase fuel consumption. Remove any mud or snow before driving.

### **Make Sure the Tire Air Pressure Is Correct**

Frequently inspect the tire air pressure and make sure it is always correct. Using the correct tire air pressure will help reduce fuel consumption.

**Use the Air Conditioner in Moderation**

Use of the air conditioner will impact fuel consumption. Try to keep the air conditioner at a suitable temperature and avoid setting the temperature too low. Also, turn the air conditioner off when it is not necessary.

**Avoid Rough Roads**

Driving on rough roads will lead to a greater loss of driving power transmission and increased fuel consumption.

**Be Sure to Perform Proper Maintenance**

Clogging up of the air cleaner element, deterioration of the engine oil and failure to adjust the engine etc. will reduce the performance of the engine and increase fuel consumption. Perform the necessary inspections, adjustments and replacements according to the Maintenance Schedule.

**Loading or Unloading Cargo****CAUTION**

- When you load or unload cargo at the roadside and the cargo, cover sheet, body parts and/or other things obscure the taillights, stop lights, hazard warning flashers, turn signal lights and/or reflectors, be sure to warn other drivers and passersby by placing signs or emergency warning triangles where they are easy to see.
- When you load or unload cargo at the roadside, select a place where stopping and parking are allowed and other drivers and passersby will not be inconvenienced.



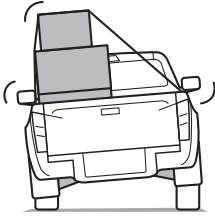



## Load Cargo Correctly

**⚠ WARNING**

- Do not move the vehicle when there is a person on the rear step bumper or cargo bed.
- Overloading can result in an accident because it places too much strain on the wheel bolts with the result that they break and the wheels come off.

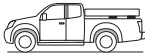
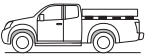
**⚠ CAUTION**

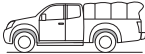
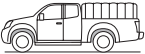
- The weight of the payload must be limited within the gross vehicle weight (GVW) rating and distributed over the front and rear axles so as not to exceed the axle capacities.
- It is extremely dangerous to overload the vehicle or to load the vehicle with the cargo positioned on one side. Load the vehicle correctly, observing the maximum loading capacity.
- Incorrect loading can make the cargo unstable. It can also cause an overload condition confined to a small area, resulting in damage to the cargo bed and frame.
- Overloading places undue strain on vehicle parts. It can shorten the vehicle's service life and cause an accident.

Cargo loading caution	Incorrect	Correct
Place cargo at the center of the cargo bed, not at the front or rear.		
When using supports under cargo, position them uniformly along the cargo.		
Do not allow long cargo to protrude beyond the rear edge of the cargo bed when transporting loads with a length longer than that of the vehicle bed. Rather, use supports to raise it at an angle. Avoid loading cargo using only 2 support points.		
Use ropes and tarpaulins to secure the cargo so it does not fall off the cargo bed. Use rubber bands or bungee cords to prevent the tarpaulins from flapping in the wind.		
Avoid loading cargo too high. It can cause the vehicle to tip sideways when it catches sidewinds and when turning the vehicle.		

**Gross Axle Weight (GAW) and Gross Vehicle Weight (GVW) Ratings**

→ Refer to page 8-5

Loading Heavy Cargo

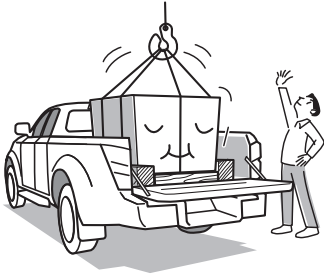

 CAUTION

- When the cargo is heavy, take steps to prevent it from slipping and secure it with wire cables.

Do Not Secure Cargo Too Tightly



 ADVICE

- To prevent cargo from falling off the cargo bed, it is essential to secure it with ropes and tarpaulins. However, securing it too tightly can damage the tailgate and cargo bed.

## Do Not Load Heavy Cargo on the Roof Rails

 **WARNING**

- For vehicles equipped with roof rails, adhere to the following cautionary notes and use the roof rails correctly.
  - When loading cargo on the roof rails, use the roof carrier.
  - When using the roof carrier, follow the roof carrier installation manual to properly secure cargo.
  - When loading cargo onto the roof carrier, make sure that it is firmly secured. Occasionally inspect the cargo to make sure it has not come loose during driving.
  - Do not load cargo that exceeds the total vehicle length, total vehicle width, and the total payload.
  - The roof rail maximum loading capacity is 100 kg (220 lb). Make sure that the total weight of the cargo and the roof carrier (including installation fittings) does not exceed the maximum loading capacity.
  - When cargo is loaded onto the roof rail and roof carrier, the vehicle's center of gravity will become higher, so be careful to drive the vehicle because there is a possibility that you may lose control of the vehicle and/or it may tip over during high speeds, sidewinds, acceleration, deceleration, sudden braking, cornering, lane changing, etc.

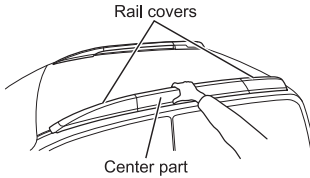
**⚠ CAUTION**

- Make sure to place your hands on the center part of the roof rails during operations such as washing of the vehicle. If the front or rear roof rail covers are forcefully pulled, the covers may come off and cause injury to the person pulling them.
- Do not forcefully pull the roof rails up or to the sides.

**Make Sure There Is No Flammable Material Between the Cab and Cargo Bed****⚠ WARNING**

- Be careful not to allow the ends of ropes or the edges of tarpaulins to come lower than between the cab and cargo bed. During vehicle operation, the engine's heat could set them on fire. Carefully secure the ends of ropes and edges of tarpaulins.

### Do Not Load Too Much Cargo onto the Front Passenger Seat and/or Second Seat



#### WARNING

- Load cargo so that it is flat. Do not load cargo so that it is higher than the seatback. Sudden braking or collisions could cause the cargo to fly forward, leading to an accident that results in damage and/or injury.
- Do not place cargo onto a reclined seatback. Sudden braking could cause the cargo to fly forward, leading to an accident.

### Do Not Carry Fuel and Spray Cans in the Cab



#### WARNING

- It is extremely dangerous to carry fuel and spray cans in the cab. If such a container were to ignite or rupture, it could cause a fire or explosion.

### Do Not Place Objects on the Instrument Panel or Dashboard



#### WARNING

- Placing objects on the instrument panel or dashboard could obscure the driver's view and interfere with driving, leading to an accident. Also, vehicle acceleration or turning could cause objects to move and injure passengers.

### Keep the Floor Around the Driver's Seat Clean and Tidy



#### WARNING

- It is extremely dangerous to have empty cans, empty bottles or other items rolling around on the floor because they could get trapped under the brake pedal and prevent brake application. For proper pedal operation, it is also essential to lay floor mats properly. Incorrectly installed floor mats would hinder free movement of the pedals.
- Do not use the top of the dashboard as a place to put items that could roll, which could interfere with your driving.

### Making Sure the Floor Mats Laid Out Correctly

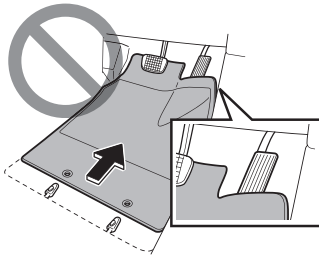
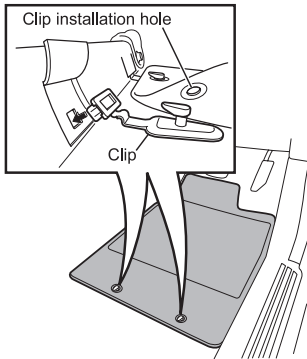

Make sure that floor mats designated for the vehicle model and model year are securely fastened on top of the floor carpet before use. When securing, make sure the clips included with the floor mats are properly installed.

#### **⚠ WARNING**

- Use the clips included with the floor mats to make sure the floor mats are kept securely fastened. Otherwise the floor mats may become misaligned and interfere with the pedals during driving, preventing accurate operation and causing a serious accident.
- Do not use floor mats that are meant for another vehicle model or model year, even if they are Isuzu genuine floor mats.
- When laying out a floor mat on the floor of the driver's seat, use the floor mat designated for the floor of the driver's seat.
- Do not use floor mats that are stacked, backwards, or flipped over.
- At regular intervals, check that the floor mats are securely fastened with the included clips. In particular, always check after the floor mats have been removed for washing of the vehicle, etc.
- Before driving and with the engine stopped, depress each pedal all the way to the floor to make sure the floor mat does not interfere with the pedals.

**Choose Your Footwear Suitable for Driving****CAUTION**

- Choose footwear that ensures proper operation of pedals when driving the vehicle. Use of footwear unsuitable for driving may cause an accident.

**Sit in the Seat Correctly****WARNING**

- Do not use the seatback as a seat when it is in a folded down position. If passengers are not sitting correctly in their seats during hard braking or a collision, it may result in fatal injuries or death.

## Correct Driving Posture

 **WARNING**

- Before driving, be sure to adjust the seat, headrest, steering wheel and mirrors to positions that give you a correct driving posture. Make sure the seat is securely retained by trying to rock it forward and backward, and put on the seat belt. All other passengers must wear seat belts.

**Power seat model****Seat Adjustment**

Adjusting the seat for a correct driving posture is a fundamental part of safe driving.

**Seats** → Refer to page 3-53

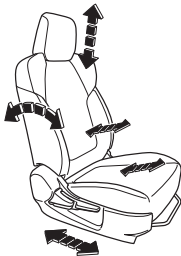
**Manual seat model**

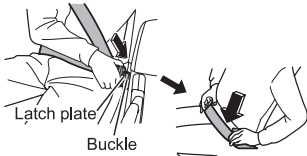

Keep as low on hip bone as possible

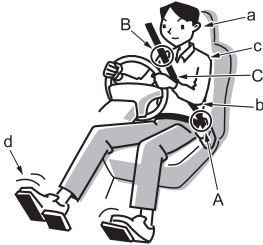

**Fastening Your Seat Belt**

Be sure to wear your seat belt. Sit up straight with your lower back pressed against the seat and the lap belt as low on your hip bone as possible.

**Seat Belts → Refer to page 3-67**

Seat adjustment recommendations	
a	Make adjustments that align the center of your head to the center of the headrest.
b	Make adjustments that allow you to easily turn the steering wheel with your elbows slightly bent.
c	Position the seatback so it is always touching your shoulders.
d	Make sure you can adequately depress each pedal.

Seat belt fastening cautions		Why?
A	Position the lap belt as low on your hip bone as possible.	The pressure applied by the seat belt in a collision would be dangerous if the belt is positioned incorrectly.
B	Position the shoulder belt so it is on your shoulder (not touching your neck, chin or face).	
C	Make sure the seat belt is not twisted when you put it on.	To ensure that the seat belt is fully effective.

### Passengers and Seat Belts

Only one person at a time should use each seat belt.

#### WARNING

- Be sure to adjust the seat before driving. Achieve the correct driving posture, gently rock the seat to make sure it is locked in place, and put on your seat belt before you start driving. All passengers must wear seat belts.
- Have your child wear a seat belt. However, use a suitable child restraint system (CRS) in the following situations.
  - When required by legal regulations and safeguards.
  - When the child is so small that the seat belt touches his/her face or does not lie across his/her hip bones.

Carrying Children → Refer to page 2-25

### Adjusting the Position of the Steering Wheel

You can adjust the position of the steering wheel in the up-down and fore-aft directions. After making an adjustment, make sure the steering wheel and lock lever are securely locked.

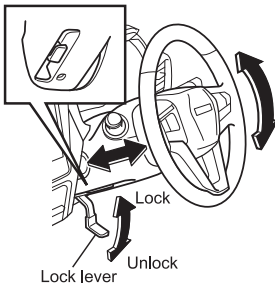

#### WARNING

- When you have adjusted the steering wheel, try shaking the steering wheel to check that it is securely locked in position before driving.
- Adjust the position of the steering wheel before you start driving. Adjusting the position of the steering wheel while driving would be extremely dangerous because the steering wheel becomes unstable and prevents precise steering.

### Fully Adjustable Steering

→ Refer to page 3-63

### Adjusting Mirrors

Check and adjust each mirror to ensure that it provides a proper view of the rear and the sides.

**Mirrors** → Refer to page 3-64

## Carrying an Expecting Mother or a Person Who Is Ill

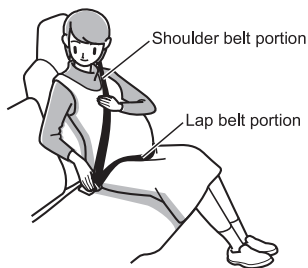

### WARNING

- An expecting mother or a person who is ill riding in the vehicle must also wear a seat belt. In light of the risk that the seat belt will apply pressure to the abdomen, chest and shoulders in the event of a collision, however, an expecting mother or person who is ill should get advice from a physician beforehand.
  - An expecting mother should use a three-point seat belt.
  - An expecting mother should position the lap belt snugly as low as possible on the hip bone (not across the abdomen). Also, she should fasten the shoulder belt so it rests on her chest, not on her abdomen.
  - Unless the seat belt is correctly worn, it may dig into the abdomen in the event of hard braking or a collision, harming not only the expecting mother but also the unborn child, putting them both in danger of serious injuries or death.

**Seat Belts** → Refer to page 3-67

**Seat Belt with Pretensioner and SRS Airbag System**

The seat belt with pretensioner and the supplemental restraint system (SRS) airbag system operate when the vehicle is subjected to an impact exceeding a certain level when a collision occurs.

Be sure to observe the following instructions to prevent you and your passenger from suffering a serious or fatal injury due to impacts resulting from the seat belt with pretensioner and airbag operation.

**Seat Belts** → Refer to page 3-67

**Seat Belt with Pretensioner and SRS**

**Airbag System** → Refer to page 3-96

**When and How the Seat Belt with Pretensioner and SRS Airbag System Operates** → Refer to page 3-104

 **WARNING**

- The SRS airbag system is most effective when used together with a seat belt with pretensioner.
- The seat belt with pretensioner and SRS airbag system may not work, depending on the situation at the time of collision. Refer to "When and How the Seat Belt with Pretensioner and SRS Airbag System Operates" for details.
- Before driving the vehicle, properly adjust your seat for proper driving position and wear the seat belt correctly. Do not sit closer than necessary to the steering wheel and do not lean over it. (Leave a space of 25 cm (10 in) or more between your chest and the center of the steering wheel.) Do not allow the passenger to put his/her hands or feet on the instrument panel and to sit with his/her face or chest close to it. When the airbags are activated, you or the passenger may suffer a burn on or serious injury to the arm or face.
- In models with side airbag and curtain airbag, do not lean against the door and roof side. When the airbags are activated, you may suffer a burn on or serious injury to the arm or face.
- In models with far side airbag, do not lean more than necessary on the part of the seat that is toward the inner-side of the vehicle. When the airbag operates, it can cause burns and serious injury to the arms and face.
- Do not drive the vehicle with something placed between you and airbag or held on your lap. If the airbag inflates, the objects may be thrown and hit your face. Doing so also hinders normal activation of the airbag, which is dangerous.
- Be sure to observe the following precautions when carrying a child in the vehicle. Otherwise the child may be fatally injured by the impact from an inflating airbag.
  - Do not drive with a child standing in front of any of the airbags, or sitting on your lap. Doing so is dangerous because the child would receive a very strong impact by an inflating airbag.
  - Never use a rearward-facing CRS on a seat protected by an active airbag in front of it, death or serious injury to the child can occur. The label on the passenger side sun visor shows warning pictograms.

WARNING (Continued)

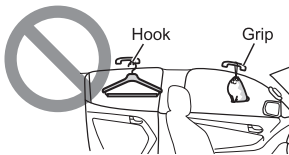
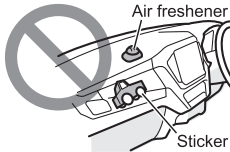

#### WARNING (Continued)

- If you make unauthorized modifications to the vehicle or install an unauthorized accessory, the seat belt with pretensioner and airbags may not operate correctly.
- If the steering wheel is changed to a non-standard one or a sticker is attached to the steering wheel pad, there could be a danger of system malfunction or the sticker flying off in the event of system activation. Attaching stickers or placing such things as accessories or air fresheners on the dashboard or around the instrument panel is also dangerous. They may prevent normal operation of the airbag or could fly off in the event of system activation.
- In models with the side airbag or the far side airbag, do not attach seat covers under any circumstances. If a seat cover is attached or objects are placed in the area in which the side airbag or far side airbag inflate, the airbags will not function correctly. Also, there could be a danger of objects flying off in the event of the system activation.
- In models with the curtain airbag, if hard objects such as hangers or accessories are attached to the grip or coat hook, they may prevent normal operation of the curtain airbag and could fly off in the event of system activation.

WARNING (Continued)

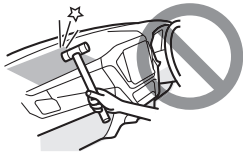
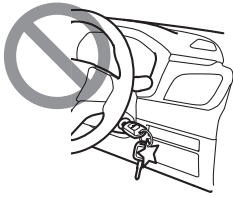

WARNING (Continued)

- In models with the knee airbag, except for models with passive entry and start system, do not attach any heavy or sharp objects to the key. Doing so is dangerous because they may prevent the knee airbag from operating normally or fly off when the airbag activates.
- Do not apply excessive force to nor strongly hit the airbag installation area, or the base of the b-pillar/c-pillar. Doing so may result in erroneous activation of the airbag or the seat belt with pretensioner.
- Doing any of the following may require special precautions. Be sure to consult your Isuzu Dealer before doing any of the following. Failure to do so may cause the seat belt with pretensioner and airbag to be unduly activated, causing the seat belt to be unexpectedly retracted or the airbag to be suddenly inflated, causing an injury to the occupant. Doing any of them improperly will adversely affect the operation of the system, causing a malfunction or failure.
  - Repair or replacement of the steering wheel, instrument panel, center console, parts around the accelerator pedal, front seat, parts around the roof side, or parts around the base of the b-pillar/c-pillar.
  - Repair, replacement or disposal of the seat belt with pretensioner and airbag, or scrapping of a model that has seat belt with pretensioner and airbag.

WARNING (Continued)

**WARNING (Continued)**

- When audio equipment and accessories are installed or modification such as body mounting is carried out.
- Making modifications to the front of the vehicle (bumper, frame, etc.), installing equipment (snow plows, etc.), making modifications to the frame, or making changes to the vehicle's height using unauthorized methods and/or materials.
- Repairing or painting of panels at the front of the vehicle or panels on the cab.

**Seats** → Refer to page 3-53

**Passenger Side SRS Airbag On-Off Switch** → Refer to page 3-117

**Carrying Children**

**Placing a Child on the Second Seat**

 **WARNING**

- For crew cab models, we recommend placing children on the second seat. Placing a child on the front passenger seat may cause the driver to be distracted by the child's appearance or the child may touch the controls, leading to an unexpected accident.

**Using Seat Belts or Child Restraint Systems (CRS)**

 **WARNING**

- Have your child wear a seat belt. However, use a suitable child restraint system (CRS) in the following situations.
  - When required by legal regulations and safeguards.
  - When the child is so small that the seat belt touches his/her face or does not lie across his/her hip bones.
- Do not drive the vehicle if a child is standing in front of any of the airbags or on the seats, or is being held in your arms, or is sitting on your lap.
- Do not let the child sit on an ordinary cushion for the reason that it is hard to see out of the window. It is dangerous because the child's body cannot be restrained in the event of a sudden stop or accident.
- For crew cab models, we recommend installing the CRS on the second seat.
- Never use a rearward-facing CRS on a seat protected by an active airbag in front of it, death or serious injury to the child can occur. The label on the passenger side sun visor shows warning pictograms.

**Seat Belts** → Refer to page 3-67

**Child Restraint System (CRS)**  
→ Refer to page 3-77

**Passenger Side SRS Airbag On-Off Switch** → Refer to page 3-117

### Pay Attention When Opening and Closing Doors and Windows



#### WARNING

- The door must be opened, closed, and locked by an adult. Be careful that the child's hands and feet are not caught when opening or closing the door. To be safe, use the child-proof door locks on crew cab models.
- Do not allow small children to operate the power window switches because there is a risk they could catch their hands or head in the power window. Use the power window lock switch when driving with a child in the vehicle.

**Child-proof Door Locks (Crew Cab Model)** → Refer to page 3-31  
**Power Window Lock Switch** → Refer to page 3-47

### Do Not Allow Children to Put Their Head or Hands Out the Windows

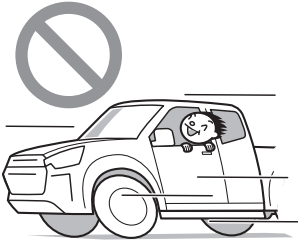

#### WARNING

- Do not allow children to put their head, hands, or other parts of their bodies out of windows, regardless of whether the vehicle is moving or stationary. Doing so is dangerous because child could be hit by other vehicles, etc. from outside the vehicle.

### Take Your Child with You When You Leave the Vehicle



#### WARNING

- Do not leave a child alone in a vehicle. Children could operate the vehicle's controls and cause an unexpected accident. Also, the interior of the vehicle could become dangerously hot when heated by the sun, possibly leading to serious health hazards, such as heatstroke and dehydration, and death in the worst case.

## Driving

Proper care and operation will not only extend the service life of your vehicle but also improve oil and fuel economy.

## Operation of New Vehicle

The subsequent performance and the service life of your vehicle are under the direct influence of the care and treatment that your vehicle will receive during the initial break-in period. It is therefore always recommended that during the initial 1,000 km (600 miles) break-in period, the following few simple precautions are carefully observed.

1. It is recommended that the engine speed is restricted to less than 3,000 r/min.
2. Avoid engine racing, abrupt starting and needless hard stops.
3. Always let the engine idle until it becomes thoroughly warmed up.

## Check Around the Vehicle Before Starting the Engine



Before pulling away, perform a thorough safety check, making sure there are no children or obstructions around the vehicle.



### WARNING

- Before starting the engine, make sure there is no flammable material under or around the vehicle. The presence of any such material could lead to a fire. If there is any wood within 50 cm (approximately 20 in) from the vehicle's heat source, it would represent a severe hazard as the wood could deform or discolor from the heat or it could catch fire.

Starting the Engine → Refer to page 4-4

**Be Careful About Exhaust Emissions** **WARNING**

- Exhaust emissions contain carbon monoxide, which is colorless, odorless and poisonous. If you inhale exhaust emissions, you may suffer carbon monoxide poisoning, resulting in death.
- Do not keep the engine running for any length of time in a place that is poorly ventilated. It is particularly dangerous to run the engine in a garage or other indoor place that could easily fill with exhaust gases because you could suffer carbon monoxide poisoning, resulting in death.
- Inspect the exhaust pipe from time to time. If you notice any defect (for example, a damaged joint, or a hole or crack caused by corrosion), have checks and maintenance performed by the nearest Isuzu Dealer. Continuing to use the vehicle without having the defect repaired would be dangerous because exhaust gases could get into the cab and cause carbon monoxide poisoning, resulting in death.
- If leaves, snow, etc. are on the air inlet grille of the vehicle's ventilation system, the ventilation system will not function properly. Remove any obstructions such as leaves or snow. Continuing to use the vehicle without removing obstructions would be dangerous because exhaust gases could get into the cab, resulting in carbon monoxide poisoning or death.
- If exhaust gases enter the cab through the vehicle's windows or doors when driving, carbon monoxide poisoning or death could result.
- If exhaust gases get into the cab, completely open all of the windows, and set the inside/outside air selector to outside air. Promptly have checks and maintenance performed by the nearest Isuzu Dealer. Continuing to use the vehicle without having the defect repaired would be dangerous because exhaust gases could get into the cab and cause carbon monoxide poisoning, resulting in death.

**If the Vehicle Has Not Been Used for a Long Period****ADVICE**

- Before using a vehicle that has not been driven for a long period, check the engine, transmission and transfer case for oil leakage, and make sure the oil is at the required levels. If there is insufficient oil, it will not adequately reach and lubricate components, and a breakdown will result.
- Start the engine and allow it to idle for at least 5 minutes. Check for abnormal noises.
- For instructions on warming up the engine, refer to "Starting the Engine".

**Starting the Engine**

→ Refer to page 4-4

**Do Not Run the Engine in a Garage****WARNING**

- Running the engine in a poorly ventilated place can lead to carbon monoxide poisoning, resulting in death. Choose a well ventilated place when starting, warming-up or idling the engine.

Starting the Engine

Manual transmission model

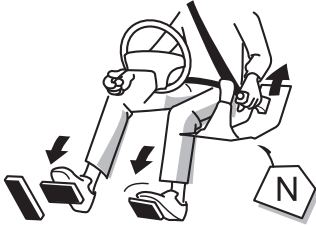

Automatic transmission model

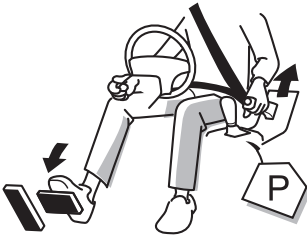

**CAUTION**

- Make sure that the parking brake lever is securely pulled. On a manual transmission model, make sure the gearshift lever is in the "N" position, and then fully depress and hold the clutch pedal and brake pedal before starting the engine. On an automatic transmission model, make sure the selector lever is in the "P" position, and then fully depress and hold the brake pedal before starting the engine.
- Be sure to sit in the driver's seat to start the engine. If you are not sitting in the driver's seat (if, for example, you reach through the window or through the door opening), you cannot confirm the position of the gearshift lever/selector lever. If you start the engine of a manual transmission model with the gearshift lever in a position other than "N", the vehicle could move.

Starting the Engine

→ Refer to page 4-4

## Never Stop the Engine While Driving

**WARNING**

- While the vehicle is being driven, do not switch the power mode to any mode other than "ON" (models with passive entry and start system) or turn the starter switch to any position other than "ON" (models without passive entry and start system). If the engine stops while the vehicle is moving, the brakes would not work properly, and the steering wheel will become extremely stiff and hard to operate. The engine could also be damaged.
- Stopping the engine while driving would be extremely dangerous because the power steering would stop working, making the steering wheel extremely hard to turn.
- Stopping the engine while driving would be extremely dangerous because the warning lights, indicator lights and other electrical circuitry would completely stop working.
- In models without passive entry and start system, placing the starter switch in the "LOCK" position while driving would be extremely dangerous because the key could come out, causing the steering wheel to lock so that it could not be turned.

**Engine Start/Stop Button (Models with Passive Entry and Start System)**

→ Refer to page 4-112

**Starter Switch (Models without Passive Entry and Start System)**

→ Refer to page 4-115

**Do Not Forget to Release the Parking Brake**



**ADVICE**

- Pulling away with the parking brake still applied can damage the brake system.
- Before pulling away, make sure the parking brake is not set by checking that the parking brake warning light is not on.

**Parking Brake Warning Light**

→ Refer to page 4-66

**Parking Brake**

→ Refer to page 4-143

**Pulling Away in a Manual Transmission Model**



**ADVICE**

- Pull away gently in 1st gear. Pulling away in a high gear, pulling away rapidly or slipping the clutch for a long time while pulling away would damage the clutch.

**Reversing**

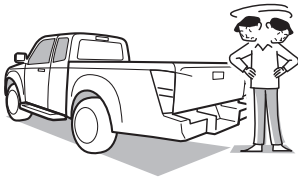

If you cannot see the area behind your vehicle well enough to confirm it is safe to back up, get out of the vehicle and check behind it.

## Appropriate Gearshifts

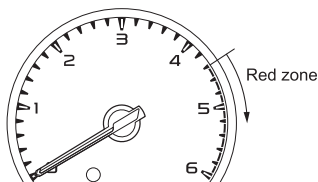

Red zone (r/min)
4,400 and above

Drive at a speed that does not cause the tachometer pointer to enter the red zone.

**ADVICE**

- Downshifts are performed for two main purposes:
  - For engine braking on a steep and/or long downward slope
  - For responsiveness and economy on an uphill slope

## [Cautions for downshifts]

- Allowing the engine to overrun can result in engine damage. Do not allow the engine to overrun when downshifting.
- Driving uphill  
Downshift early to avoid heavy engine load.
- Driving downhill  
In principle, you should use the same gear(s) that you used to drive up the hill. Drive at a speed that does not cause the engine to overrun (exceed its r/min limit) and the tachometer pointer to enter the red zone.

**Tachometer** → Refer to page 4-16

**Manual Transmission**

→ Refer to page 4-144

**Automatic Transmission**

→ Refer to page 4-145

Cautions for Driving

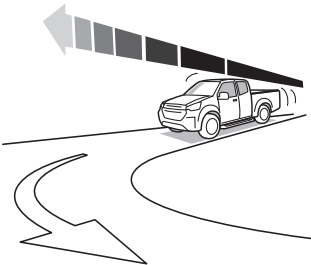

- Concentrate on driving safely, obeying all legally designated speed limits, road signs and traffic signals.
- While the vehicle is being driven, do not switch the power mode to any mode other than "ON" (models with passive entry and start system) or turn the starter switch to any position other than "ON" (models without passive entry and start system). The power steering would stop working, making steering extremely difficult. Also, the brakes would not work well, putting you in extreme danger.
- If you notice any abnormal noise, abnormal smell or abnormal vibration from any part of the vehicle, immediately stop the vehicle in a safe place and perform checks.
- If a warning light comes on while you are driving, immediately stop the vehicle in a safe place and perform checks.
- On a manual transmission model, do not put your foot on the clutch pedal except when using the gearshift lever. Doing so would cause premature clutch wear.
- Slow down sufficiently when approaching a curve. Applying the brakes or sharply turning the steering wheel while turning the curve could cause the cargo to shift, the tires to slip and the vehicle to tip onto its side.
- While driving, do not place your hand on the gearshift lever/selector lever except when changing gears. Doing so could cause the transmission to fail.

- Avoid scraping the tire sidewalls against curbstones or driving over dips and protrusions in the road surface. You could damage the wheels or tires, resulting in a blowout or flat tire.
- When going down on a steep slope, avoid driving the vehicle backward as much as possible. Drive it forward slowly on the down slope.
- Compared with forward movement, the braking distance of backward movement is longer, and the steering response of that is worse.
- If you must drive the vehicle backward, drive it very carefully and gradually by moving and stopping repeatedly in order to stop it any time.
- The brakes give strong braking force with only light pressure on the pedal. Do not depress the brake pedal too strongly except in the event of an emergency.
- Nighttime driving is more dangerous than daytime driving because the field of view is narrower. Keep your speed down, and maintain an ample headway distance.
- When driving in fog, turn on the front fog lights (if equipped), rear fog light (if equipped), and drive slowly, using the road's center line as a guide. It is dangerous only to follow the lights of the preceding vehicle because they can cause optical illusions. Drive with caution.
- Speeds on highways are higher than those on regular roads, so there is more danger. Also, a breakdown on a highway represents a hazard to other vehicles and can cause an accident. Concentrate on safe driving. Remember to perform daily pre-operation inspections and use highway driving techniques.
- Your sense of how fast you are traveling becomes distorted on long highway drives. Constantly keep an eye on the speedometer, and maintain a suitable headway distance.
- During high-speed driving, even a little turn of the steering wheel causes a big movement of the vehicle. Turn the steering wheel slowly.

### Driving Down a Long Slope

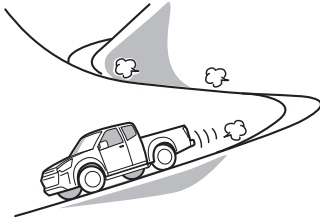

When driving down a long slope, use engine brake together with the foot brakes. Using the low-gear engine brake reduces the work load on the foot brakes and yields greater braking force. In automatic transmission models, do not use the auto mode, as it does not provide engine efficiency. Use only the manual mode for engine braking.



#### CAUTION

- Frequent use of the foot brakes can cause vapor lock and brake fade, resulting in reduced brake effectiveness.
- Be very careful when using engine braking in a low gear because the engine is likely to over-rev.



#### NOTE

[What is vapor lock?]

- If the brakes overheat due to frequent use, the heat can cause the brake fluid to boil so that air bubbles are created in the brake fluid. Depressing the brake pedal simply compresses the air bubbles; pressure is not transmitted to the wheel cylinders, so the brakes' effectiveness sharply deteriorates. This phenomenon is called vapor lock.

[What is brake fade?]

- Frequent use of the brakes can cause the brakes to overheat so that the frictional force of the friction surface decreases and the brakes become less effective than normal. This phenomenon is called brake fade.

### Driving in Bad Weather (Rain, Icy Roads, Snowy Roads, etc.)



#### CAUTION

- In bad weather, visibility is reduced and slippery road surfaces increase stopping distances. Drive more slowly than you would in good weather. Also, avoid sharp turns of the steering wheel and hard braking. Use engine brakes together with the foot brakes to decelerate.



#### ADVICE

- There is a risk of hydroplaning, particularly where water tends to collect on the road surface. Drive at speeds that allow you to stay in complete control.
- If you cannot avoid driving on a flooded road, first check the depth of the water and then drive through the water at a slow, constant speed. There is a risk that water will get into the engine's cylinders and cause engine damage (water hammering). Keep your speed down, and drive with great care.



#### NOTE

[What is hydroplaning?]

- If a vehicle is driven at high speed on a road that is covered with water, a layer of water can form between the tires and road surface, causing the tires to lose their grip and slide across the water. This phenomenon is called hydroplaning. It is dangerous because it makes the steering wheel and brakes useless.

**Driving on Snowy or Icy Roads****Caution on Slippery Roads****CAUTION**

- On slippery roads, never accelerate rapidly, brake hard, decelerate rapidly or make sharp turns of the steering wheel.
- There is a risk of reduced grip between the tires and road surface and of increased braking distances. The danger of icy road surfaces is particularly great on bridges, in shady places and where there are puddles. Keep your speed down and be sure to use tire chains or winter tires on snowy or icy road surfaces.
- Use lower gears to overcome the retardation effect of the engine. Apply the foot brakes lightly.

**NOTE**

- On a snowy or icy road with an automatic transmission model, by depressing the brake pedal you can make a standing start in the manual mode 2nd gear and move the selector lever to the "+" (upshift) position.
- For models that are equipped with electronic stability control (ESC), when you want to free the vehicle from snow where the tires may slip slightly by increasing the engine speed, you can press the ESC OFF switch to disable just the traction control system (TCS).
- For models that are equipped with differential locks, use the differential lock when you want to free the vehicle from snow.

**Tire Chains** → Refer to page 2-74

**Rear Differential Lock Switch**  
→ Refer to page 4-128

**Automatic Transmission**  
→ Refer to page 4-145

**Electronic Stability Control (ESC)**  
→ Refer to page 4-162



### Pay Attention to the Way the Steering Wheel Turns and Feels

#### CAUTION

- On snowy roads, water and snow splashed up by the tires can freeze and accumulate inside the fenders, making the steering wheel hard to turn. From time to time, get out of the vehicle and remove any accumulated snow. Do not use a sharp implement to remove the snow. Sharp edges could damage rubber parts.

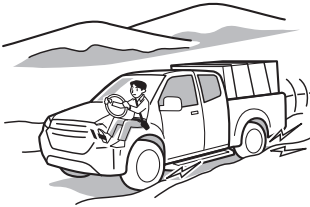

### Check the Brakes from Time to Time

#### CAUTION

- When the vehicle is driven or parked on a snowy surface, ice can form on the brakes, decreasing their effectiveness. From time to time while you are driving, depress the brake pedal lightly and check the brake's effectiveness. Pay attention to vehicles both ahead and behind you when checking the brakes in this way.
- Also, check the brake's effectiveness as soon as possible when starting to drive the vehicle after it has been parked. If the brakes do not work well, drive slowly and gently depress the brake pedal several times until the brakes dry out and start working normally.

### Removing Snow from the Underbody

Look under the vehicle and remove any lumps of ice that are stuck to the underbody. Be careful not to damage components.



#### ADVICE

- Do not use a sharp implement to remove snow. Sharp edges could damage rubber parts.

### Driving on Poor Road Surfaces (Sand or Mud)

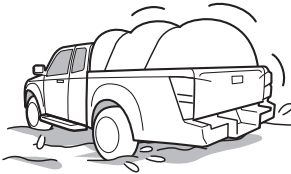

When you cannot avoid driving through deep mud, using tire chains is an effective way to avoid getting stuck.



#### ADVICE

- When driving in sand or mud, avoid hard braking, sudden acceleration and sharp turns of the steering wheel. Such actions could get the vehicle stuck and make it impossible to extricate.
- After driving through deep mud, any mud stuck to the vehicle can harm the steering, brakes and powertrain. Wash the vehicle and remove all mud and other incrustation.
- In models with automatic transmission, shift the transmission to the manual mode and then shift to 2nd or 1st gear to avoid overheating the transmission when towing or when driving slowly in mud, sand, on snowy roads or steep inclines.
- On anti-lock brake system (ABS) equipped models, the vehicle speed sensors are fitted on the wheels. When removing mud and other incrustation, take great care not to damage the components.
- Do not use a sharp implement to remove mud. Sharp edges could damage rubber parts.

**NOTE**

- On a muddy road with an automatic transmission model, by depressing the brake pedal you can make a standing start in the manual mode 2nd gear and move the selector lever to the "+" (upshift) position. This provides better traction and safer vehicle operation.
- For models that are equipped with electronic stability control (ESC), when you want to free the vehicle from mud where the tires may slip slightly by increasing the engine speed, you can press the ESC OFF switch to disable just the traction control system (TCS).
- For models that are equipped with differential locks, use the differential lock when you want to free the vehicle from mud.

**Exterior Maintenance**

→ Refer to page 6-126

**Automatic Transmission**

→ Refer to page 4-145

**Rear Differential Lock Switch**

→ Refer to page 4-128

**Anti-lock Brake System (ABS)**

→ Refer to page 4-157

**Electronic Stability Control (ESC)**

→ Refer to page 4-162

**When Driving on Bad Roads**

→ Refer to page 7-28

## When the Vehicle Has Been Driven on a Flooded Road or Washed

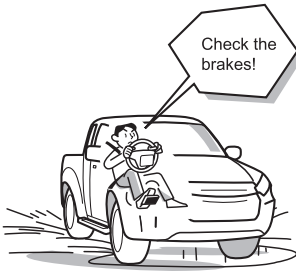

### CAUTION

- If the vehicle must be driven on a flooded road, is washed, or is parked in an area that becomes flooded, water can get into the brakes and reduce their effectiveness. If the brakes do not work well afterward, drive slowly and gently depress the brake pedal until the brakes dry out and start working normally.



### ADVICE

- If the vehicle must be driven on a flooded road or is parked in an area that becomes flooded, promptly have your Isuzu Dealer perform a check for the following points:
  - Effectiveness of the brakes
  - Water-ingress, or damage to drum brakes or disc brakes
  - Engine damage due to water-ingress
  - Shorting of electrical components
  - Oil levels and oil conditions of the engine, transmission, differential, and transfer case (If any oil is cloudy, the oil must be changed because it is contaminated with water.)
  - Greasing of each components (lubrication)

## Sidewinds



## ADVICE

- If the vehicle catches a sidewind and drifts sideways, firmly grip the steering wheel, decelerate to a speed that allows you to stay completely in control and make a directional correction. The vehicle may catch strong sidewinds in the following situations:
  - Emerging from a tunnel; Driving over a bridge, driving on an embankment or driving through a cutting
  - Being overtaken by a large truck or bus
  - Overtaking a large truck or bus

## Dealing with a Blowout or Flat Tire While Driving



## WARNING

- If you feel any abnormality in a tire while driving, immediately stop in a safe place. If you continue to drive on a flat tire, undue force would be applied to the wheel bolts, possibly causing the bolts to break and the wheel to come off.



## ADVICE

- If a blowout or flat tire occurs while you are driving, calmly grip the steering wheel and gradually apply the brakes to decelerate. (Hard braking would be dangerous because it could cause the steering wheel to be pulled to one side.) Stop the vehicle in a safe place, and change the tire.

<b>Tools</b>	→ Refer to page	6-8
<b>Spare Tire</b>	→ Refer to page	6-68
<b>Handling the Jack</b>	→ Refer to page	6-73
<b>Changing Tires</b>	→ Refer to page	6-78

**If the Underside of the Vehicle Receives a Hard Bump****ADVICE**

- If the underside of the vehicle receives a hard bump, stop in a safe place where the vehicle will not obstruct traffic and check for brake fluid leakage, fuel leakage and component damage. If any part of the vehicle is damaged or broken, promptly have the vehicle inspected and repaired by the nearest Isuzu Dealer.

**If a Warning Light Comes On or Flashes****ADVICE**

- If a warning light comes on or flashes, do not ignore it, and do not keep driving. Be sure to take corrective action referring to the explanation of the meters and warning lights.

**How to Read the Instruments  
(Instruments Layout)**

→ Refer to page 4-14

**Warning and Indicator Lights Layout**

→ Refer to page 4-21

## Off-road Driving



During off-road driving, carefully confirm the road condition, incline and other factors, and drive at a reduced speed.

### **WARNING**

- When driving off-road or on extremely uneven road surfaces, drive at a reduced speed. Avoid making jumps, making sharp turns, and striking objects with the vehicle. Failure to observe these cautions may result in loss of control or overturning of the vehicle. In addition, damage to the vehicle may also result.
- Do not place your hands in the steering wheel spokes when driving off-road. If the vehicle's wheels suddenly change direction, the steering wheel may turn, resulting in injury to your hands. Do not place your thumbs inside the rim when gripping the steering wheel.
- On inclined surfaces, drive straight, at right angles to the incline. Driving parallel to the incline (as with other, similar vehicles) may result in overturning of the vehicle.
- After driving in mud, sand or flooded roads, be sure to confirm that the brakes function correctly.

**Trailer Towing**

The vehicle is designed for passenger and cargo transportation, however, when using the appropriate equipment, you can tow a trailer under certain conditions.

Towing a trailer has a significant influence on handling, performance, braking, durability and fuel consumption.

For your safety and that of others too, use equipment specifically designed for your vehicle. Improper equipment or installation can cause damage to your vehicle and possibly personal injury. Additional care and cautious driving habits are essential when towing a trailer.

Damage or malfunction caused by towing a trailer for commercial purposes are not covered by Isuzu warranties.

**⚠ WARNING**

- Follow the recommendations in this manual before towing a trailer. Failure to do so could result death or serious injury. For further details, contact the nearest Isuzu Dealer.

**Weight Limits**

The loading and weight limitations shown below must be followed for your continued driving satisfaction.

**⚠ WARNING**

- Never exceed the weight limits indicated below. Exceeding the weight limits is dangerous. It will cause damage to your vehicle and possibly result in personal injury. Check weights and loading at a commercial scale or highway patrol office that is equipped with scales.

Gross combined weight (GCW)

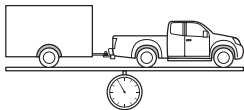

**Gross Combined Weight (GCW)**

The gross combined weight (GCW) rating equals the combined weight including passengers and cargo weight of your vehicle (including all vehicle accessories) plus the total trailer load.

Engine model	Gross combined weight
RZ4E	5,000 kg (11,025 lb)
4JJ3	6,000 kg (13,230 lb)

Gross vehicle weight (GVW)

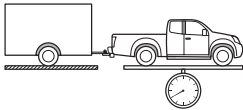
**Gross Vehicle Weight (GVW)**

The gross vehicle weight (GVW) rating equals the combined weight of an unloaded vehicle (including all vehicle accessories), passengers, cargo, trailer hitch, trailer tongue load and optional equipment. This value is indicated on the vehicle identification number (VIN) plate attached to the left front end of the engine compartment.

**Gross Axle Weight (GAW) and Gross Vehicle Weight (GVW) Ratings**

→ Refer to page 8-5

**Vehicle Identification Number (VIN) and Engine Number**

→ Refer to page 1-2

Front gross axle weight (GAW)

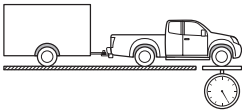

Rear gross axle weight (GAW)

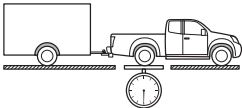
**Gross Axle Weight (GAW)**

The gross axle weight (GAW) rating equals the weight on the front axle or rear axle (including all vehicle accessories).

Measure the weight when the trailer is connected. This value is indicated on the vehicle identification number (VIN) plate attached to the left front end of the engine compartment.

**Gross Axle Weight (GAW) and Gross Vehicle Weight (GVW) Ratings**

→ Refer to page 8-5

**Vehicle Identification Number (VIN) and Engine Number**

→ Refer to page 1-2

Gross trailer weight (GTW)

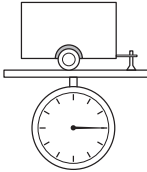

**Gross Trailer Weight (GTW)**

The gross trailer weight (GTW) rating equals the sum of the trailer weight and the cargo weight.



**NOTE**

- The maximum allowable trailer weight when driving on public loads is governed by regional laws. Please refer to the tow bar data label for the limits that are applicable to your vehicle.

Engine model	Gross trailer weight
RZ4E	2,100 kg (4,631 lb)
4JJ3	3,500 kg (7,718 lb)

Tongue load

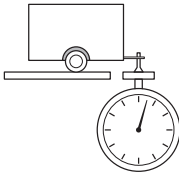

**Tongue Load**

The tongue load equals the weight on the trailer connection.



**CAUTION**

- Adjust the trailer weight so that the tongue load is greater than 25 kg or 4% of the towing capacity. Tongue load does not exceed the weight limits for the vehicle/tow bar design. Refer to the tow bar data label for details.

## Equipment

**WARNING**

- Do not use axle-mounted hitches or equipment not designed for your vehicle. Improper equipment or installation can cause damage to your vehicle and possible personal injury.

**Trailer Hitch Kit**

The trailer hitch kit is available from your Isuzu Dealer. The kit includes all the necessary hardware and instructions for proper installation.

Check with your recreational vehicle dealer for additional required equipment. Only a trained mechanic should install your vehicle towing equipment.

**WARNING**

- Do not modify the electrical systems of the vehicle to accommodate towing a trailer other than those specified in the instructions contained in the Isuzu trailer hitch kit. Improper modifications can affect vehicle durability.

**ADVICE**

- After installation of the Isuzu trailer hitch kit is complete, periodic inspections of the equipment are necessary to assure continued safe operation.

### Safety Chain

Always use a safety chain that is suitable for your vehicle and trailer. Check with your trailer manufacturer regarding the required equipment. Cross the safety chain under the hitch and attach it to the trailer hitch connections.

The safety chain will prevent the trailer from dropping to the ground in the event that the hitch disengages. For proper use and installation, consult the trailer manufacturer.

### Trailer Lights

Trailer lights and equipment should comply with local legal requirements. Check with your recreational vehicle dealer for the specific requirements. Use only equipment that is designed for your vehicle. Improper equipment or installation can cause damage to the electrical system of your vehicle and affect your vehicle warranty. Consult your Isuzu Dealer for installation.

### Tires

Always check the condition of the tires of the vehicle and trailer before operation. Replace worn or damaged tires before operation.

Inflate tire pressure to the recommended cold tire pressure indicated on the tire pressure label on the driver's door opening frame and according to the values recommended by the manufacturer of your trailer.

### Trailer Brakes

Trailers with a gross weight of 750 kg (1,654 lb) or more require trailer brakes. If your trailer is equipped with a brake system, make sure it conforms to local legal requirements.

Consult your trailer manufacturer and an Isuzu Dealer for proper installation and use of trailer brakes.



#### WARNING

- Never connect a trailer brake system to your vehicle hydraulic brake system. Braking efficiency and operation will be seriously affected.

### Maintenance

Towing a trailer will affect vehicle maintenance requirements due to the additional load. More frequent maintenance intervals will be required to assure continued satisfaction with the vehicle. Regarding the recommended maintenance and service, contact the nearest Isuzu Dealer.

#### Maintenance Schedule for Severe-condition Operations

→ Refer to page 6-143

**Before Trailer Towing****Equipment Check**

Before operating your vehicle, check all safety equipment to ensure safe operation. Be sure your vehicle is properly serviced to avoid a mechanical malfunction.

Be sure trailer cargo is securely loaded. Check that your rear view mirrors conform to local legal requirements.

Perform an equipment check of all braking, lighting and safety equipment to ensure they are working properly.

Your safety depends on proper operation and installation of equipment. Never operate a vehicle with malfunctioning equipment.

Supplementary exterior rear view mirrors should be added to the vehicle if the traffic to the rear cannot be seen clearly with standard mirrors. Adjust the extending arms of these mirrors on both sides of the vehicle so that they always provide maximum visibility of the road behind.

## When Trailer Towing



### WARNING

- Avoid holding the brake pedal down too long or applying the brakes too frequently. This could cause the brakes to overheat and result in reduced braking effect.
- Do not use the cruise control function when towing a vehicle or trailer.
- Turn off the BSM, RCTA, LDP, ELK and LKAS (if equipped).
- Always park the trailer on a flat surface if possible.
- Be sure to use chock blocks for both the vehicle and trailer when parking.
- The speed limit of 90 km/h (56 MPH) is recommended when towing a trailer on a flat, straight, dry road. Do not exceed this limit, the posted towing speed limit, or the speed limit for your trailer as set forth in your trailer owner's manual, whichever is lowest. When towing, the instability (trailer sway) will increase as speed increases. Exceeding of the speed limit could result in loss of vehicle control and may lead to a vehicle accident.
- Turn off the BSM, RCTA, LDP, ELK and LKAS (if equipped). The system may not operate normally.

#### To Turn Off the BSM

→ Refer to page 4-187

#### To Turn Off the RCTA

→ Refer to page 4-196

#### To Turn Off the LDP

→ Refer to page 4-295

#### To Turn Off the ELK

→ Refer to page 4-295

#### To Turn Off the LKAS

→ Refer to page 4-303

When a new vehicle has been driven or when a vehicle that has had powertrain parts changed (engine, transmission and differential) to new parts, it is recommended to tow the vehicle until the driving distance reaches 800 km (497 miles).

- When towing a trailer during operation, check from time to time to confirm whether the cargo is secured and whether the lighting equipment and trailer brakes are working.
- Between the vehicle ahead and your vehicle, keep the interval twice as much as the interval for when driving without a trailer attached. This precaution will help prevent abrupt braking and sharp turns.
- Avoid sudden starting or sudden acceleration.
- Avoid jerky steering and sharp turns, and slow down before making a turn.
- Note that when making a turn, the trailer wheels will be closer than the wheels of the towing vehicle to the inside of the turn. Compensate by making a wider turning radius than normal.
- When towing a trailer, a distance longer than usual is required for overtaking other vehicles. Because the vehicle-trailer combination has a slower acceleration and is longer than normal, it requires returning to the original lane once it has gone considerably ahead of the overtaken vehicle.
- Slow down and shift to a lower gear before descending long or steep downhill grades. Vehicle-trailer instability is more likely on steep long downhills. Slow down and downshift before descending steep or long downhill grades.
- Do not make sudden downshifts while descending steep or long downhill grades.

### Trailer Sway

Multiple factors (crosswinds, passing vehicles, rough roads, etc.) can adversely affect the operation of the towing vehicle and trailer, causing instability.

#### WARNING

- When a trailer sway occurs, do not ever accelerate.
- When a trailer sway occurs, avoid applying strong brakes abruptly.
- When a trailer sway occurs, do not try to control the trailer sway by the steering operation.
- When a trailer sway occurs, firmly grip the steering wheel. Steer straight ahead. Begin releasing the accelerator pedal immediately but very gradually to reduce speed.

#### CAUTION

- After the trailer swaying has stopped, check for the following:
  - Stop in a safe place.
  - Get all occupants out of the vehicle.
  - Check the tires of the towing vehicle and trailer.
  - Check the cargo in the trailer.
  - Make sure the cargo has not shifted.
  - Make sure the tongue weight is appropriate, if possible.
  - Check the cargo weight in the towing vehicle.
  - Make sure the vehicle is not overloaded after occupants get in.
- When driving is continued because there were no problems with the vehicle and trailer after trailer sways occurred, drive with a speed lower than the speed at the time the trailer sways occurred.

**Automatic Transmission Model**

On an automatic transmission model, there is no need to use a clutch pedal; you can pull away, change gears and stop the vehicle by only using the selector lever, accelerator pedal, and brake pedal. Be sure to learn the characteristics of the automatic transmission model and how to correctly operate it. When the vehicle is stationary, remember to keep the brake pedal firmly depressed and, if necessary, place the selector lever in "P" or "N" position and apply the parking brake.

Immediately after engine startup, while the air conditioner is running, the engine speed automatically rises. As this makes creep stronger than it is at other times, be sure to keep the brake pedal firmly depressed.

**Automatic Transmission**

→ Refer to page 4-145

**NOTE**

[Creep]

- With the engine running and the selector lever in a position other than "P" or "N" selected, power is transmitted to the wheels even when the accelerator pedal is not depressed, causing the vehicle to tend to move. This phenomenon is called creep. The higher the engine speed, the stronger the creep and the greater the vehicle's tendency to move.

### Operate the Brakes with Your Right Foot



#### ADVICE

- Sit in the correct driving position, and use your right foot to operate the brake and accelerator pedals. To avoid depressing the wrong pedal by mistake, check the pedal positions and practice putting your foot on the desired pedal.
- To ensure reliable brake application, be sure to use your right foot to depress the brake pedal.

### Basic Driving Operations

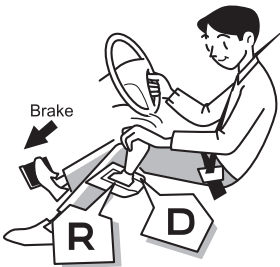

#### Pulling Away

1. Sitting in the correct driving position, firmly depress the brake pedal with your right foot and place the selector lever in the "D" position (auto mode or manual mode) for forward movement or the "R" position for backward movement.
2. Check to be sure that the area around the vehicle is clear and check the selector lever position and shift indicator, and then release the parking brake lever.
3. Take your foot off the brake pedal, then gradually depress the accelerator pedal to pull away.



#### CAUTION

- When pulling away on a steep slope, place the selector lever in the "D" or "R" position, pull on the parking brake lever and hold it as you depress the accelerator pedal. After you feel the vehicle start moving, slowly release the parking brake lever and pull away.

### Running

The vehicle's speed is adjusted by carefully operating the accelerator pedal. Furthermore, the vehicle's speed is reduced as needed by operating the brake pedal.

### Stopping Temporarily

1. When stopping the vehicle temporarily, firmly depress the brake pedal with the selector lever in the "D" (auto mode or manual mode) position.
2. When starting the vehicle after stopping, visually check the selector lever position and the shift indicator and start the vehicle by slowly depressing the accelerator pedal.

### Parking

1. Set the parking brake while depressing the brake pedal.
2. Place the selector lever into the "P" position, make sure that the shift indicator displays "P", and then slowly ease off the brake pedal.
3. In models with passive entry and start system, stop the engine and switch the power mode to "OFF". In models without passive entry and start system, stop the engine and remove the key.



### WARNING

- Immediately after engine startup, while the air conditioner is running, the engine speed automatically rises, making creep stronger than it is at other times. Firmly depress and hold the brake pedal.
- When you move the selector lever to a position other than "P" or "N", creep will cause the vehicle to move. When pulling away, be sure to depress and hold the brake pedal as you operate the selector lever.
- Do not operate the selector lever while depressing the accelerator pedal. Doing so is dangerous because the vehicle will suddenly move.
- When pulling away, be sure to visually check the selector lever position and the shift indicator for safety reasons.
- Carefully operate the accelerator pedal because the speed is controlled only using the accelerator pedal when starting or accelerating the vehicle.

**CAUTION**

- Do not race the engine while the vehicle is stopped. If the selector lever is placed in any position other than "P" or "N", the vehicle will suddenly move and it may cause an accident.
- Do not place the selector lever into the "N" position while driving. The engine brake does not work at all, possibly causing an accident. Doing so may also cause a failure in the automatic transmission.
- Do not leave the driver's seat with the selector lever placed in "D" (auto mode or manual mode) or "R" while the engine is running. The vehicle may start moving. When leaving the driver seat, be sure to place the selector lever into "P" and securely set the parking brake.

[Essential points for safety]

- Even if you plan to drive only a short distance, adopt the correct driving position and make sure that the brake and accelerator pedals can be depressed firmly.
- When backing up the vehicle, you twist to look rearward so pedal operation becomes difficult. Firmly depress the brake pedal while twisting your body. Also, get in the habit of immediately returning the selector lever to the "N" position after backing up. When pulling away, visually check the selector lever position and the shift indicator.
- When repeatedly shifting the selector lever between forward and reverse gears for a multiple point turn or a K-turn, firmly depress the brake pedal and confirm that the vehicle is completely stopped before shifting the selector lever.

**NOTE**

- After the vehicle has been left for a week or more it may not start at once, even when the accelerator pedal is depressed. In such cases, shift the selector lever to the "P" position and wait for several seconds with the engine idling.

**Shift Indicator** → Refer to page 4-74  
**Automatic Transmission**

→ Refer to page 4-145

**Actions that Can Lead to a Breakdown with an Automatic Transmission Vehicle**

Action that can lead to a breakdown	Breakdown symptom
<ul style="list-style-type: none"> <li>• Stopping the vehicle on an uphill road with the selector lever in a position other than "P" or "N", with the engine gunned, and the brakes not applied.</li> <li>• Depressing the accelerator pedal and brake pedal at the same time while the selector lever is in the "D" or "R" position.</li> <li>• Stopping the vehicle by depressing the brake pedal for a long time while the selector lever is in the "D" position.</li> </ul>	<ul style="list-style-type: none"> <li>• Automatic transmission fluid overheats.</li> </ul>
<ul style="list-style-type: none"> <li>• Operating the selector lever with the engine gunned and the engine speed high.</li> </ul>	<ul style="list-style-type: none"> <li>• The automatic transmission gears or clutch are overloaded.</li> </ul>
<ul style="list-style-type: none"> <li>• Operating the selector lever to the "P" position before the wheels are completely stopped.</li> </ul>	<ul style="list-style-type: none"> <li>• The parking mechanism is damaged.</li> </ul>
<ul style="list-style-type: none"> <li>• Switching the power mode to "ACC" (models with passive entry and start system) or turning the starter switch to the "ACC" or "LOCK" positions (models without passive entry and start system) while the vehicle is being driven.</li> <li>• Keeping the selector lever in the "N" position on a long downward slope. (This is dangerous due to the lack of engine brake.)</li> </ul>	<ul style="list-style-type: none"> <li>• The automatic transmission is not properly lubricated.</li> </ul>

### Four Wheel Drive (4WD) Model

Four-wheel drive does not make it possible to drive a vehicle absolutely everywhere. Exercise caution when using the accelerator pedal, steering wheel and brake pedal. Concentrate on driving safely, paying attention to the condition and slope angle of the road surface.

#### Four Wheel Drive (4WD) Model

→ Refer to page 4-310

### Driving on Snow-covered or Icy Roads

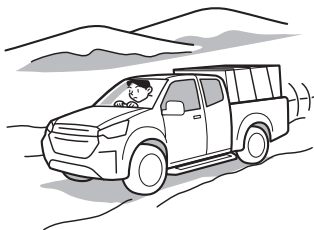

On a snow-covered or icy road, drive at a constant speed and keep your speed low enough to stay completely in control.

When applying the brakes, depress the pedal gently several times instead of depressing it strongly. It is dangerous to depress the pedal strongly at once because it could cause the vehicle to slip, making the steering wheel useless.



#### ADVICE

- Use tire chains and winter tires on snow-covered or icy roads.

**Winter Tires** → Refer to page 2-73

**Tire Chains** → Refer to page 2-74

### Driving in Sand or Mud

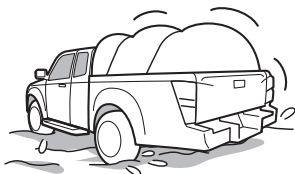

When driving in sand or mud, go as slowly as possible, avoiding hard braking, sudden acceleration and sharp turns of the steering wheel.

It is difficult to ascertain the condition of the road surface when you are driving on sand or mud, so there is a risk of getting stuck. When necessary, get out of the vehicle and check the condition of the road surface.

### Driving Through Water



The vehicle is not completely impervious to water. Avoid driving through water.



#### ADVICE



- If you cannot avoid driving through water, first check the depth of the water and then drive through the water at a slow, constant speed. There is a risk that water will get into the engine's cylinders and cause engine damage (water hammering).
- If the vehicle must be driven through water, promptly have your Isuzu Dealer perform a check for the following points:
  - Effectiveness of the brakes
  - Water-ingress, or damage to drum brakes or disc brakes
  - Engine damage due to water-ingress
  - Shorting of electrical components
  - Oil level and degradation (cloudiness) of the engine, transmission, differential and transfer case
  - Greasing of each components (lubrication)

### U-turn on Sharp Slopes

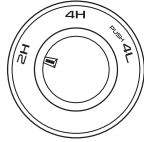
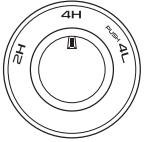
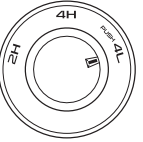

When making a U-turn on a sharp slope, the vehicle is in danger of turning over the moment it crosses the slope. Drive carefully selecting the road surfaces so that the tires on the higher side of the slope may not run on any convex part of the slope surface.

### Guidelines for Switching Between 2WD (Rear-Wheel Drive) and 4WD (Four-Wheel Drive)

Drive type	2WD	4WD	
	2H	4H (4WD high)	4L (4WD low)
4WD switch			
Indicator light	OFF		
Driving conditions	During normal driving on an ordinary road or highway.	Wet roads, snow-covered roads, icy roads, and other roads where the vehicle needs more traction than 2WD.	Steep slopes, rough roads, sand, mud or deep snow, and other roads where the vehicle needs significant traction.



#### ADVICE

- Do not set the 4WD switch midway between the "2H" and "4H" positions or the "4H" and "4L" positions. Doing so could cause a malfunction.

## Stopping and Parking

### Pulling Away After a Temporary Stop

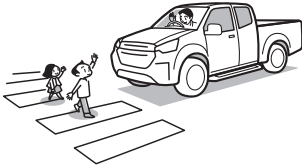

#### CAUTION

- Make it a habit to look around and confirm that it is safe to pull away after a temporary stop (at traffic lights, for example).

### Parking



#### CAUTION

- Choose a flat place where stopping and parking are permitted and where the vehicle will not obstruct traffic.
- When parking the vehicle, be sure to shift the gearshift lever to the "N" position (manual transmission models) or the selector lever to the "P" position (automatic transmission models). In addition, apply the parking brake and make sure that the vehicle does not move.
- Remove all dirt from the vehicle's light lenses and reflectors to ensure that the vehicle can be seen from other vehicles.



#### ADVICE

- Except in an emergency, do not apply the parking brake until the vehicle has come to a complete stop. Applying the parking brake before the vehicle has stopped can cause a breakdown.
- Avoid parking for long periods with cargo on the vehicle.

**Parking Brake** → Refer to page 4-143

## Parking Safely on a Slope

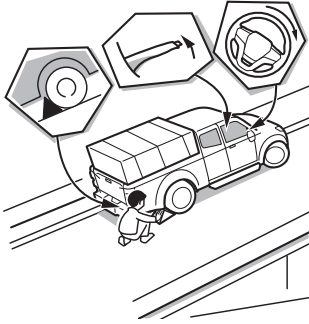
**CAUTION**

- Avoid parking your vehicle on a slope as much as possible and choose a level and flat place. If it is unavoidable to park your vehicle on a slope, be sure to set the parking brake fully, make sure that the vehicle does not move. Isuzu would recommend enhancing safety by chocking the wheels.
- In manual transmission models, if the vehicle is parked facing up a hill, place the gearshift lever in the "1 (1st)" gear, and if parked facing down a hill, place the lever in the "R (reverse)" gear.
- Leave the steering wheel turned such that the vehicle will be stopped by an obstruction (for example, the curb) in the unlikely event that it moves.

## Parking in Cold Regions

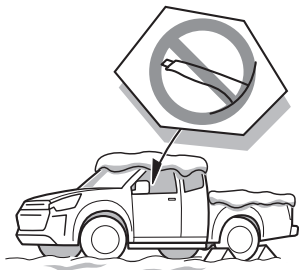

When snow collects around the wheels and lights, try to remove it before night falls.

Do not apply the parking brake in cold regions. If you leave the parking brake applied, the wires and brake shoes could freeze up, making it impossible for you to release the parking brake. Be sure to park the vehicle in gear.

For manual transmission models, be sure to park the vehicle by shifting the gearshift lever into the "1 (1st gear)" or "R (reverse)" position when in a flat location. For automatic transmission models, shift the selector lever into the "P" position, check whether "P" is indicated on the shift indicator, park the vehicle in a flat location and then stop the engine.

Be sure to put chocks against the tires.

### WARNING

- If you park in a place where there is a lot of snowfall, snow accumulating around the vehicle could limit ventilation. Running the engine with the vehicle in these conditions could cause exhaust gases to enter the cab, resulting in carbon-monoxide poisoning. Take preventive action by, for example, clearing the snow around the vehicle.

### ADVICE

- The wiper blades may freeze in very low temperatures. To prevent them from freezing, stand the wiper arms up.
- For flat blade types, the wipers are stored under the engine hood. Do not forcibly pull them out from under the hood manually. If you do, the wipers could be damaged. To stand the wiper arms up, first switch them to the service position.

#### Switching to the Service Position

→ Refer to page 6-98

#### Switching to the Normal Position

→ Refer to page 6-100

## Napping in the Vehicle

 **WARNING**

- Before taking a nap in the vehicle, switch the power mode to "OFF" (models with passive entry and start system) or turn the starter switch to the "LOCK" position (models without passive entry and start system). Also, check that the engine is stopped. Otherwise, any unintended contact with the gearshift lever/ selector lever or accelerator pedal while you are asleep could cause the vehicle to move, resulting in an accident.
  - If you leave the engine running and unintentionally keep the accelerator pedal pressed while asleep, the engine, muffler, and exhaust pipe could become abnormally hot, resulting in a fire.
  - If you leave the engine running while taking a nap with the vehicle parked in a place where exhaust gases could get into the cab (for example, a place that is poorly ventilated), you could suffer carbon monoxide poisoning, resulting in death.

### Keep Flammable Material Away from the Vehicle

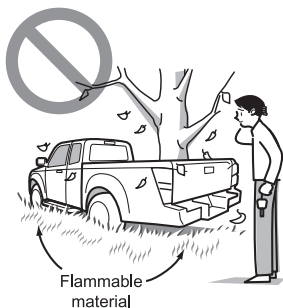

#### WARNING

- After driving through tall grass, mud, rocks, sand, water, etc., check that there is no grass, branches, paper, rags, stones, sand, etc., adhering to or trapped under the vehicle body. If the vehicle is operated with these materials trapped or adhering to the underbody, a failure or fire could occur. Clear off any such matter from the underbody.
- The muffler and exhaust pipe are extremely hot while the engine is idling, or immediately after vehicle operation. In order to prevent fires, make sure the surrounding area is free of flammable material (for example, grass, waste paper, oil or old tires). Take particular care when parking in a garage.
- Use caution concerning hot exhaust gases while the engine is idling, or immediately after the engine has been stopped. Otherwise, you could be burned.

### Stopping and Parking with the Engine Running

#### WARNING

- When stopping and parking with the engine running: If your vehicle is the manual transmission model, be sure to place the gearshift lever in the "N" position. If your vehicle is the automatic transmission model, be sure to place the selector lever in the "P" position and check that "P" is indicated in the shift indicator. Then, firmly apply the parking brake. Unless you take these steps, any unintended pressure on the accelerator pedal could cause an accident.

### Do Not Touch the Gearshift Lever/Selector Lever While the Vehicle Is Stationary with the Engine Idling

#### WARNING

- Do not touch the gearshift lever/selector lever while the vehicle is stationary with the engine idling. If you touch the gearshift lever/selector lever at this time, a gear could be selected and the vehicle could move even with the parking brake applied. The risk of knocking against the gearshift lever/selector lever and causing an accident is particularly great when you move in or out of your seat.

### Look Around Before Opening a Door

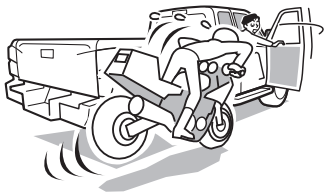

#### CAUTION

- Before opening a door, check the area around the vehicle by looking forward, rearward and to the sides. If you suddenly open a door without checking the surrounding area, the door could be hit by a vehicle behind you or a pedestrian.

## Leaving the Vehicle

### WARNING

- When leaving the vehicle, be sure to apply the parking brake, stop the engine and lock the doors. Do not leave valuables where they can be seen from outside the vehicle.
- If you are traveling with a child, do not leave the child alone in the vehicle. If the child touches the controls or equipment, an accident could occur. (For example, the vehicle could move or a fire could start.) Also, the cab inside could become dangerously hot in hot weather.
- Do not leave eyeglasses or a lighter in the vehicle. If the cab inside becomes hot, a lighter left there could explode and plastic eyeglass lenses or frames could deform or crack.
- Do not leave your vehicle unattended with the engine running. If the engine should overheat, you would not be there to react to the engine overheat warning light, engine overheat warning buzzer, or engine coolant temperature gauge. This could result in costly damage to your vehicle and its contents.

## Starting to Drive When the Vehicle Has Been Parked



Before pulling away, perform a thorough safety check, making sure there are no children or obstructions around the vehicle.

### Cautions for Driving in Hot Regions

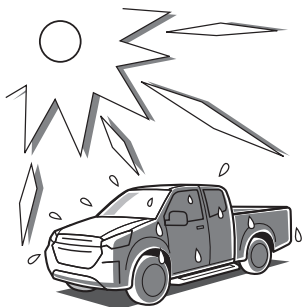

The engine will be prone to overheating in an environment where the ambient temperature is high. To prevent the engine from overheating, pay attention to the following points:

#### CAUTION

- Do not put well water, river water or other hard water in the engine cooling system. It would hasten the formation of rust and scale.

If foreign matter (insects, mud, etc.) gets stuck in the air passages of the radiator, the performance of the cooling system decreases. Check the air passages for clogging, and remove any foreign matter using tap water.

#### Handling the Radiator and Intercooler

→ Refer to page 6-44

#### ADVICE

- When the ambient temperature is high, evaporation of battery fluid will become quicker. Frequently check the battery fluid level and, when necessary, add more fluid.

#### Checking the Battery Fluid Level

→ Refer to page 6-122

**Cautions for Driving in Cold Regions**

The following cautions apply to snowbound regions and to mountainous regions, ski resorts and other areas of extreme cold and/or snowfall. Please use them also for reference in winter in other regions.

For the sake of your vehicle, have your Isuzu Dealer make the winter preparations described hereafter. Also have these preparations made before driving to a cold region.

**Engine Oil** → Refer to page 6-22

**Engine Coolant** → Refer to page 6-39

**Windshield Washer Fluid**  
→ Refer to page 6-94

**Handling the Battery**  
→ Refer to page 6-115

**Recommended Fluids, Lubricants and Diesel Fuels** → Refer to page 6-144

**Engine Oil and Gear Oil Viscosity Charts** → Refer to page 6-148

**Fuel** → Refer to page 2-72

**Winter Tires** → Refer to page 2-73

**Tire Chains** → Refer to page 2-74

**⚠ WARNING**

- Snow or obstructions surrounding the vehicle could limit ventilation. Running the engine with the vehicle in such a situation could cause exhaust gases to enter the cab, resulting in carbon monoxide poisoning or death. Take preventive action, for example, by clearing any snow or obstructions around the vehicle.

**⚠ CAUTION**

- Do not cover the front of the radiator with newspapers, cardboard or any other flammable material to raise the engine coolant temperature.
- If you allow the engine to warm up but the engine coolant temperature does not rise, have the nearest Isuzu Dealer inspect the thermostat.

### Protection of Engine Against Overcooling

Overcooling of the engine not only accelerates wear of the vital engine parts but also deteriorates fuel economy.

### Engine Coolant



To prevent the engine damage due to freezing of the engine coolant and to protect the cooling system from corrosion, mix the coolant and water to be an appropriate concentration.

### Engine Oil

The engine oil tends to harden with lowering temperatures. Use engine oil with a viscosity suited to ambient temperature.

### Fuel

If you drive to a cold region in winter while using diesel fuel for warmer regions that freezes at a relatively high temperature, the fuel may freeze. As the ambient temperature decreases, the fuel in the fuel tank and pipes may freeze like slush, making the engine hard to start.



#### NOTE

- The specifications of diesel fuel differ according to the season and region.

### When Ice Prevents You from Putting the Key in the Door or Opening the Door



If you try to force the key into the door, you could bend it. And if you try to pull the door open with undue force, the rubber seal around the door could come unstuck or become damaged. Use warm water to melt the ice, then quickly wipe it away and open the door.

If the wipers, electric door mirrors, or power windows freeze up, also use warm water to melt the ice and then operate the system. Otherwise, you could damage the mechanism and drain the battery. After that, wipe the water away.

### Winter Tires

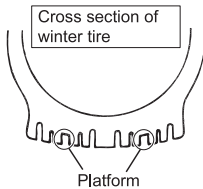

Use winter tires of the same sizes as the standard tires. Also, use wheels of the same size as those with the standard tires. A winter tire has reached its wear limit when the tread grooves have worn to half of the depth of the new tire. At this time, platforms indicating that the tire can no longer give adequate performance on snow become visible in the grooves. Replace the tire with a new one.

#### CAUTION

- Avoid sharp turns of the steering wheel and hard braking. Use the engine brake to decelerate. When applying the brakes on snowy or icy road, lightly depress the brake pedal several times rather than giving it one hard depress. A single hard depress of the pedal would be dangerous because it could cause the vehicle to slip or skid.
- Avoid driving at high speeds on a dry road with winter tires.
- Comply with local legal requirements when using winter tires.

### Tire Chains

When handling, installing and uninstalling tire chains, refer to the instruction manual that is supplied with the tire chains and perform (un)installation following the instructions provided by the manufacturer.

**Handling the Jack** → Refer to page 6-73



#### CAUTION

- Fit the tire chains securely without looseness. If the vehicle is driven with the loosened tire chains, they may interfere with other components or come off, leading to an unexpected accident.
- Do not exceed 30 km/h (19 MPH) or exceed the tire chain manufacturer's suggested speed limit if it is lower than 30 km/h (19 MPH).
- If an abnormal sound is heard, it may indicate a possibility that a tire chain was cut or came off partially. Immediately pull off to a safe place, and check the fitting condition of the tire chains.
- The muffler and exhaust pipe are extremely hot when the engine is running or immediately after the vehicle is driven, so be careful not to touch them.
- Be careful not to hurt yourself on the edges of the vehicle while working with the tire chains.



#### ADVICE

- Do not install tire chains on the front tires. Make sure to fit the tire chains suitable for the tire size on the rear wheels.
- If your vehicle has 265/60R18 size tires, use tire chains that conform to the following specifications:
  - Radial thickness 13 mm (0.5 in) Max
  - Axial thickness 13 mm (0.5 in) Max
- When purchasing tire chains, fit them on the tires once and, if they are too long, adjust them to suit the tires.
- Retighten chains after driving 0.4 to 0.8 km (0.25 to 0.5 miles).
- In models with the tire pressure monitoring system (TPMS), the system may not operate properly if tire chains are installed.

**Tire Pressure Monitoring System (TPMS)**

→ Refer to page 4-319

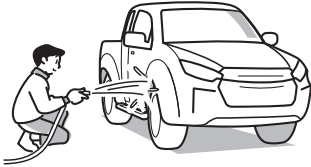
**Cleaning the Vehicle After Driving on Snowy Roads****CAUTION**

- Remove snow that has stuck to the inside of the fenders and to the brake hoses. Otherwise, it may damage components. After driving on a salted road, wash the underside of the vehicle as soon as possible to prevent the salt from causing rust. Spraying water under high pressure is an effective way to get the salt off.
- After washing the vehicle, wipe the door openings dry.

**ADVICE**

- The vehicle speed sensors are fitted on the wheels. When removing snow, ice and other incrustation, take great care not to damage the components.
- Do not use a sharp implement to remove snow. Sharp edges could damage rubber parts.

**Anti-lock Brake System (ABS)**

→ Refer to page 4-157

**Staying Safe****When the Engine Coolant Is Hot****⚠ WARNING**

- Do not loosen or remove the radiator cap while the engine coolant is hot. Doing so would be dangerous because steam and hot air would shoot out.

**When the Engine Overheats**

→ Refer to page 7-22

**When the Muffler and Exhaust Pipe Are Hot****⚠ CAUTION**

- The muffler and exhaust pipe are extremely hot while the engine is running, and immediately after vehicle operation. Be careful not to inadvertently touch them. Otherwise, you could be burned.

**Do Not Allow Your Hands to Become Trapped in the Side Access Panel (Extended Cab Model)****⚠ WARNING**

- When riding in the cargo bed, do not place your hands near the side access panels since there is a risk of injury when the side access panels close.

**Do Not Attach Accessories to the Windshield or Windows****⚠ WARNING**

- Do not attach ornaments, films or other accessories to the windshield or windows. They would impair visibility. Also, any plastic suction cups used to attach accessories could cause a fire or other accident by acting as lenses.

**Do Not Use a Mobile Telephone While Driving****⚠ CAUTION**

- Drivers should never use mobile telephones or car phones in any mode other than hands free while driving. Doing so is dangerous.
- Using a mobile telephone while driving could result in an accident because you would not be paying full attention to your surroundings.
- If you are driving and you wish to use a mobile telephone, first stop the vehicle in a safe place.

## Using the Jack

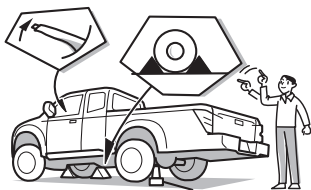
 **WARNING**

- Jacking up a vehicle on slope or soft ground is extremely dangerous. Be sure to jack up the vehicle on a firm, level surface.
- Set the jack in the correct position. Do not forget to first apply the parking brake and place chocks around the wheels.
- When a rear wheel is jacked up, the parking brake has no effect. Failing to first put chocks in the correct places would be dangerous because the vehicle could move.
- It might start moving when the engine power is transmitted to the rear axle even when one of the wheels on the axle is raised clear of the ground. Do not start the engine with any rear wheel in contact with the ground.
- Do not get under a vehicle and no person should place any portion of their body under a vehicle that supported by a jack. Failure to observe this precaution could lead to an accident if the jack were to slip.
- When jacking up a rear differential lock model, be sure to switch off all of the differential locks. Models with rear differential lock, any transmission of torque to the rear wheels can make the vehicle move even if one rear wheel is off the ground. If any rear wheel is on the ground, do not apply torque to the rear wheels.

**Tools** → Refer to page 6-8  
**Handling the Jack** → Refer to page 6-73

## If the Battery Goes Flat

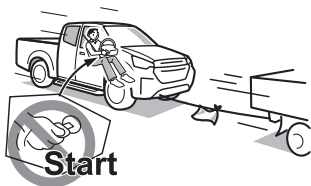
**CAUTION**

- Do not try to start the engine by pushing or towing the vehicle. You could damage the engine.

**When the Battery Goes Flat**

→ Refer to page 7-16

## Preventing Breakdowns

### Handling the Turbocharged Engine

The turbocharged engine should be started in a way which ensures the bearings supporting the rotating parts of the turbocharger are sufficiently lubricated. Do not race a cold engine.



#### ADVICE

- After driving with a heavy load, or after driving on a highway, let the engine idle for at least 3 minutes to cool it down. This allows the turbocharger to return to idle speed. Engine oil pressure is available for lubrication at this time and will prolong the life of the turbocharger bearings.

### For Manual Transmission Model, Do Not Rest Your Foot on the Clutch Pedal While Driving



#### ADVICE

- If you rest your foot on the clutch pedal while driving, the clutch could partially disengage without you realizing it, causing the clutch plates to wear and the clutch to slip. Also, do not slip the clutch as a way to hold the vehicle in position (instead of using the brakes) on, for example, an uphill road.

**Do Not Ride on the Side Steps While the Vehicle Is in Motion**



**WARNING**

- Do not ride on the side steps while the vehicle is in motion.

**ADVICE**

- Do not jump up and down on the side steps. Doing so may place unnecessary force onto the side steps, resulting in damage.

**Is the Engine Oil Dirty?**



**ADVICE**

- The engine oil performs the following important functions:
  - It prevents engine parts from becoming worn.
  - It cools engine parts.
  - It cleans engine parts.
  - It seals the combustion chambers and prevents rust.
- Replace the engine oil at regular intervals.

**Daily Checks (Preoperational Checks)**

→ Refer to page 6-16

**Engine Oil** → Refer to page 6-22

**Maintenance Schedule**

→ Refer to page 6-136

### Do Not Leave the Steering Wheel Fully Turned for a Long Time



#### WARNING

- While the engine is running, if you leave the steering wheel fully turned for a long time or if you repeatedly operate the steering wheel when parking your vehicle or when your vehicle is stopped, the steering wheel may gradually become hard to turn. This occurs to prevent the power steering unit from becoming extremely hot. This is not a malfunction. After a while, when the unit is cooled down, it returns to normal. However, repeating such steering operations may cause a malfunction.

### Cautions for Short Distance Driving

The combustion gases of clean diesel engines contain a large amount of water. Therefore, if you repeatedly drive short-distances (for example: driving 8 km (5 miles) or less for 30% of the total number of trips), the engine does not warm up sufficiently and the water generated in the engine is not discharged. If this happens, corrosion (rust) may occur in parts of the engine and the engine oil may deteriorate. If you repeatedly turn off the key while the engine coolant temperature is low, such as in the case of repeatedly driving short-distances, you should drive the vehicle for 20 km (12 miles) or more at least once a week.

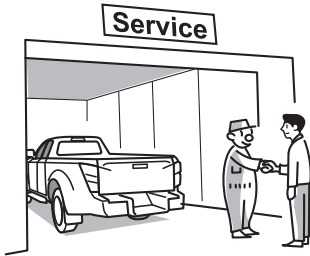
**Make Sure the Vehicle Is Inspected at Regular Intervals****ADVICE**

- Inspections and maintenance enable you to use the vehicle with peace of mind. They also extend the vehicle's service life.

**Daily Checks (Preoperational Checks)**

→ Refer to page 6-16

**Engine Oil**

→ Refer to page 6-22

**Maintenance Schedule**

→ Refer to page 6-136

**When to Visit Your Isuzu Dealer****Do Not Modify the Vehicle****⚠ WARNING**

- Modification of the suspension/chassis with lift kits, spacers, springs, etc. can cause interference with the steering wheel operation and/or vehicle performance, leading to an accident.

**⚠ CAUTION**

- Attaching parts that are not suitable for the vehicle's performance and functions could lead to a breakdown or accident. For adjustments (for example, engine adjustments) and equipment installation, consult your Isuzu Dealer.
- If you wish to attach accessories to the vehicle, consult your Isuzu Dealer.

**Have Engine Adjustments Made by Your Isuzu Dealer****⚠ CAUTION**

- Do not make engine adjustments yourself.  
Be sure to consult your Isuzu Dealer.

## Electric Welding



## ADVICE

- Careless electric welding of vehicle parts can cause welding current to flow back through the vehicle's ground circuit and damage electrical and electronic parts so that they do not function normally. Whenever electric welding is necessary, consult your Isuzu Dealer.

## Replacing Tires and Wheels

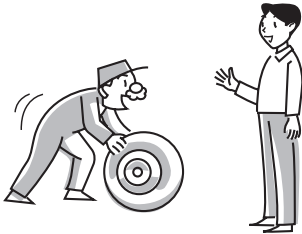

## CAUTION

- Consult your Isuzu Dealer before replacing tires or wheels. Never use wheels that are not designed for the vehicle, tires of different types at the same time or tires that are not the specified size. Doing so would impede safe vehicle operation.



## ADVICE

- In models with the tire pressure monitoring system (TPMS), replacing tire related parts (tire, wheel, wheel nuts, etc.) may affect the operation of the TPMS.

**Wheels and Tires** → Refer to page 6-61

**Tire Pressure Monitoring System (TPMS)**

→ Refer to page 4-319

**Changing Tires** → Refer to page 6-78

## Installing Electrical Equipment

**CAUTION**

- Inappropriate installation or removal of audio, radio or other electrical equipment can adversely affect other electrical equipment and cause a breakdown or fire. It can also cause unexpected, dangerous airbag deployment. Be sure to have electrical equipment installed or removed by your Isuzu Dealer.

**ADVICE**

[Installation of radio equipment]

- Do not install any unauthorized radio set, or any radio set or antenna that does not comply with relevant standards. Noise from the radio set could cause electromagnetic interference with the vehicle's electronic equipment and other systems, resulting in a vehicle breakdown or in a malfunction of electronic equipment. Consult your Isuzu Dealer if you wish to install radio equipment.

## Speed Limit Device

### Characteristics of the Speed Limit Device

The speed limit device restricts excessive speed to prevent a serious accident.

Engine model	Set speed
4JJ3-TCX	180 km/h (112 MPH)
RZ4E-TC	180 km/h (112 MPH)



#### CAUTION

- The speed limit device does not control braking, so it is possible for the vehicle to exceed the set speed on downhill slopes.



#### NOTE

- The speed limit device restricts the vehicle's speed by controlling the fuel injection volume. It prevents the speed from exceeding a certain, predetermined level regardless of the pressure on the accelerator pedal.
- If you want to change the set speed, contact your Isuzu Dealer.

## Vehicle Data Collection

Your vehicle, like other modern motor vehicles, has a number of sophisticated computer systems that monitor and control several aspects of the vehicle's performance. Your vehicle uses on-board vehicle computers to monitor emission control components to optimize fuel economy, to monitor conditions for airbag deployment and, to provide anti-lock braking and to help the driver control the vehicle in difficult driving situations. Some information may be stored during regular operations to facilitate repair of detected malfunctions.

Isuzu may download and retrieve stored information for the purpose of diagnosing, servicing, or repairing your motor vehicle or improvement to future Isuzu motor vehicles.



# PRE-DRIVING OPERATIONS AND ADJUSTMENTS

# 3

• Key	3-2
• Key with Immobilizer Transponder Chip	3-5
• Anti-theft System	3-8
• Keyless Entry System	3-11
• Passive Entry and Start System	3-17
• Doors	3-25
• Side Access Panel (Extended Cab Model)	3-38
• Tailgate	3-40
• Getting In and Out of the Vehicle	3-43
• Power Windows	3-44
• Manually Operated Windows	3-48
• Fuel Tank Filler Cap	3-49
• Seats	3-53
• Fully Adjustable Steering	3-63
• Mirrors	3-64
• Seat Belts	3-67
• Child Restraint System (CRS)	3-77
• Seat Belt with Pretensioner and SRS Airbag System	3-96
• Passenger Side SRS Airbag On-Off Switch	3-117

## Key

## Type 1

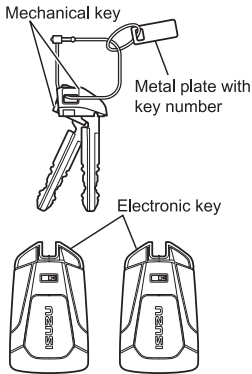

## Type 2

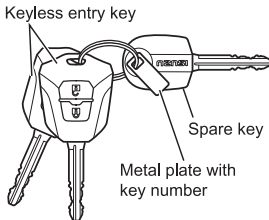

## Type 3

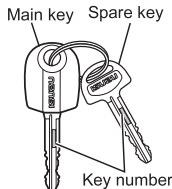

Both sides of the key are identical, so you can insert the key in the key cylinder without worrying about which way you insert it.

The key number is indicated on a separate metal plate or engraved directly onto the key in order to prevent it from being acquired by an unauthorized person.

 **WARNING**

[Models with passive entry and start system and keyless entry system]

- No alterations or additions should be made to the passive entry and start system or keyless entry system, as such alterations or additions would automatically invalidate the certificate of installation.
- When taking the electronic key or keyless entry key on airplanes, do not press the key buttons while in the cabin of the plane. Also, when storing the key in bags, etc., store so that the key buttons are not easily pressed. Radio waves will be emitted should the buttons be pressed, possibly interfering with the operation of the plane.

 **ADVICE**

- Should you lose the key, please give the key number and all remaining keys supplied with the vehicle to the nearest Isuzu Dealer. The Isuzu Dealer will be able to duplicate your key.

**NOTE**

- If the key number is indicated on the metal plate, store it in a safe place other than the vehicle to prevent theft.
- If the key number is engraved on the key, make a note of the key number and keep in a safe place such as your wallet and not in the vehicle.
- If you resell the vehicle, be sure to hand over the plate with key number to the new owner together with the vehicle.
- Electronic key and keyless entry key conform to the stipulations of the radio law. Please refrain from doing the following:
  - Do not open the key except for when replacing the battery.
  - Do not use keys that have been modified.
- In models with a passive entry and start system, the mechanical key is stored in the electronic key.
- The number of keys and their combinations depend on the model of vehicle.  
[Models with passive entry and start system and keyless entry system]
- Passive entry and start system consists of FOB (IK4310E) and ECU (IM1135AA).
- Keyless entry and immobilizer system consists of TX (IK3600F) and ECU (IM2035BB).
- Immobilizer system consists of ECU (IM2005BB).

**Passive Entry and Start System**

→ Refer to page 3-17

## Where Is the Key Used?

Where	For what
Starter switch (models without passive entry and start system)	Starting and stopping the engine
Driver side door	Locking and unlocking the door
Passenger side door (with key cylinder)	Locking and unlocking the door
Tailgate (with key lock)	Locking and unlocking the tailgate
Fuel tank filler cap (with key lock)	Locking and unlocking the filler cap
Glove compartment (with key lock)	Locking and unlocking the glove compartment
Passenger side SRS airbag on-off switch	Switching the passenger side SRS airbag to enabled or disabled

**ADVICE**

- Wipe off the key to remove any dirt or dust, etc. before using it.

**Key with Immobilizer Transponder Chip** **WARNING**

- No alterations or additions should be made to the immobilizer system, as such alterations or additions would automatically invalidate the certificate of installation.

The immobilizer key and electronic key contain an immobilizer transponder chip. The immobilizer anti-theft system allows the engine to be started only when it receives signals from the transponder of the pre-registered key.

 **NOTE**

- In models with passive entry and start system, the electronic key contains a transponder chip, and when the electronic key battery goes flat, the power mode can be changed and the engine can be started through verification of the transponder chip. Refer to "When the Electronic Key Battery Goes Flat" for details.
- In models without passive entry and start system, when the starter switch is turned to the "ON" position, verification of the transponder chip will be performed. If the verification is successful, it will become possible to start the engine. Also, after the starter switch is turned from the "ON" position to the "ACC" or "LOCK" position and a maximum of approximately 30 seconds has passed, it will be necessary to perform verification again in order to start the engine.

**Engine Start/Stop Button (Models with Passive Entry and Start System)**

→ Refer to page 4-112

**Starter Switch (Models without Passive Entry and Start System)**

→ Refer to page 4-115

**When the Electronic Key Battery Goes Flat**

→ Refer to page 7-7

However, even when using the pre-registered key, you might not be able to start the engine in the cases listed below. If the engine fails to start due to a metal key holder, remove the key holder and then try again.

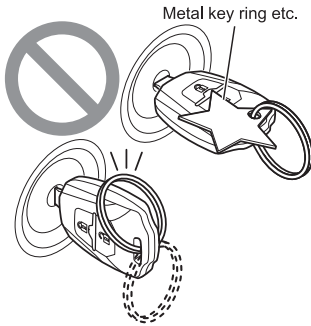

- There is a facility nearby that is emitting strong radio waves.
- A metallic object is touching or covering the handle of the key.
- Placing items which interfere with the immobilizer signal onto the key grip. (E.g. key ring, key number plate, metal items, magnetic items)

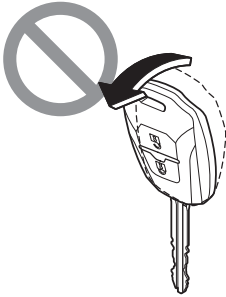

- Another vehicle's transponder key is near your key (includes an Isuzu spare key and other keys).

**ADVICE**

- Do not leave the transponder key on the dashboard or any other surface where the key might be exposed to high temperatures (exceeding 60 C /140 F).
- Do not place a magnetic object close to the transponder key.
- For starting the engine, use only the Isuzu immobilizer keys which are registered to the immobilizer system in your vehicle. Do not use copied keys or any other keys.
- Do not break the key.
- Do not try to open the key grip (except replacing the battery in remote control unit).
- Do not dip the key into water or any other liquid.
- Do not wash the key with an ultrasonic cleaner.

**NOTE**

- The immobilizer system does not lock the doors, so please do not forget to lock the doors when you get out of the vehicle.
- If the starter will not turn even though key usage is correct and the condition of the battery is normal, there may be a failure of the immobilizer system. If this occurs, contact the nearest Isuzu Dealer.

## Anti-theft System

### WARNING

- No alterations or additions should be made to the anti-theft system, as such alterations or additions would automatically invalidate the certificate of installation.

When the vehicle doors and engine hood are locked, the anti-theft system is designed to protect your vehicle and valuables from theft.

Any attempt to forcibly open any door or the engine hood without using the passive entry and start system or keyless entry system will cause the hazard warning flasher to flash on and off and the horn to sound intermittently. Once the system starts operating, the horn shuts off after 30 seconds and the hazard warning flashers shut off after 5 minutes automatically.

### Activating the Anti-theft System

1. In models with passive entry and start system, switch the power mode to "OFF".  
In models with keyless entry system, turn the starter switch to the "LOCK" position and remove the key.
2. Make sure that all doors and the engine hood are closed, that all windows are closed, and that nobody is in the vehicle.
3. Lock the door by using the passive entry and start system or keyless entry system. Locking the door turns on the anti-theft system indicator light.
4. If an ultrasonic alarm is not installed, approximately 10 seconds after the anti-theft system indicator light comes on, the anti-theft system is activated. At this time, the anti-theft system indicator light starts flashing.

In models equipped with an ultrasonic alarm, the system monitors for 10 seconds after the anti-theft system indicator light turns on to detect whether a pet or person is inside the vehicle. At this time, if no pet or person is detected, the anti-theft system activates, but if a pet or person is detected the anti-theft system is canceled. The doors remain locked even if the anti-theft system is canceled.

Indicator Light

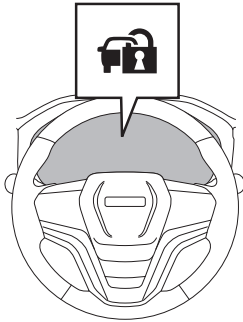

During the first 10 seconds	
Lights up	System in preparation
Flashes	Door, engine hood open or system fault

After approximately 10 seconds	
Flashes	System on
Goes off	System off

 **CAUTION**

- If a door is not closed completely, the map light or dome light will remain on. The anti-theft system is not engaged at this time.
- If the indicator light is not functioning, have Isuzu Dealer correct the problem as soon as possible.

**Deactivating the Anti-theft System**

When the door is unlocked using the passive entry and start system or keyless entry system, the anti-theft system will be deactivated.

 **NOTE**

- In models with passive entry and start system, when the electronic key cannot be used due to its battery being discharged, touch the button with the electronic key after pushing the engine start/stop button, then push the button and switch the power mode to "ON" to stop the alarm.

**When the Electronic Key Battery Goes**

Flat

→ Refer to page 7-7

### Anti-theft System Alarm Operating Conditions

When the anti-theft system is engaged, the alarm will operate under the following conditions:

- When someone forcibly attempts to open the door or engine hood without using the passive entry and start system or keyless entry system.
- When a key or other tool is inserted into the door key cylinder and a door is unlocked.
- When someone unlocks a door with the door lock knob or power door lock (central door lock) switch.
- When the engine hood release lever is operated.
- When the key is inserted into the starter switch.
- When the windshield or door windows are broken, and someone is detected entering the vehicle (models equipped with ultrasonic alarm).



#### NOTE

- When the engine hood or doors are operated from an open window, or by someone inside the vehicle, the anti-theft alarm may start operating.

### Stopping the Anti-theft System Alarm

To stop the anti-theft system alarm (horn and hazard warning flasher), perform either of the following operations:

- Push the engine start/stop button to switch the power mode to "ON" (models with passive entry and start system).
- Insert the key into the starter switch and turn it to the "ON" position (models with keyless entry system).
- Operate the remote control unit.

## Keyless Entry System

### Operation Range of Remote Control Unit

Remote control unit operating range

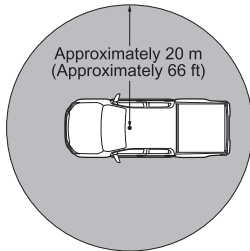

The passive entry and start system and keyless entry system allow you to lock or unlock the doors by simply pressing the button on the remote control unit without inserting the key into the lock.

The remote control unit works within approximately 20 m (66 ft) radius of the vehicle center as indicated in the figure.



#### ADVICE

- Avoid getting water on the remote control unit, dropping it, hitting it against another object, or stepping on it; otherwise, the remote control unit could malfunction.
- The remote control unit is comprised of precision components. Do not disassemble or subject the remote control unit to electrical shock.
- Do not leave the remote control unit on the dashboard or any other surface where the unit might be exposed to high temperatures (exceeding 60 C/140 F). Doing so may result in shorter battery life or malfunction of the remote control unit.



#### NOTE

- In areas near a TV tower, electric power plant, radio station, etc. or under any conditions involving strong electrical disturbances, the remote control operating range might change or the function might not work.

### Replacing the Battery in the Remote Control Unit

Replace the battery as soon as the range of the remote control starts to become reduced.

#### WARNING

- Do not ingest the battery. Doing so may cause physical impairment due to the chemical reaction.  
This product (the remote control unit that comes with this product) has a lithium coin/button cell battery inside. If a lithium coin/button cell battery is ingested, it may cause severe internal damage within 2 hours and may result in death. If the battery is ingested or is suspected of being ingested, seek immediate medical attention.
- Keep the new or used batteries out of reach of children.  
If the battery compartment does not close securely, stop using the product and keep it out of reach of children.

#### CAUTION

- When changing the battery, use only a battery of the same type as the original battery, or an equivalent. Otherwise, there is a risk of explosion.
- Do not place the battery in direct sunlight, or near a fire or other sources of heat.
- Be sure to install the battery with the "+" side and the "-" sides correctly oriented. Incorrect installation will result in leakage of chemicals from inside the battery or other operational problems.

**NOTE**

- The battery life varies depending on how the remote control unit is used. As a guide, in models with passive entry and start system, battery life is approximately 1 to 2 years. Also, significant wasting may occur if strong radio waves are continually received. Do not place the remote control unit near appliances such as televisions or computers.
- The battery has reached its end of life when the remote control unit works intermittently or does not work at all. Replace the battery as soon as this happens.
- The warning mark (an exclamation mark in an equilateral triangle) printed on the remote control unit or indicated on the label attached to the remote control unit is intended to alert the user to the presence of important instructions in the owner's manual or workshop manual.
- Please comply with the collection system available in your country for the disposal of old batteries. In addition, take special care to prevent any danger to children.

This symbol [crossed-out wheeled bin] provided in Directive 2006/66/EC of the European Parliament and of the Council indicates separate collection of waste batteries in the European Union countries.



**Electronic Key**

Battery used	Number of batteries
Lithium battery Model number: CR2032 Voltage: DC3V	1

1. Pull out the mechanical key while pressing the button on the electronic key.

**Passive Entry and Start System**

→ Refer to page 3-17

2. Open the cover by inserting a flat-head screwdriver. Wrap a piece of cloth or tape around the tip of the screwdriver so as not to damage the cover.
3. Remove the battery.
4. Insert a new battery and close the cover.

**ADVICE**

- Be careful not to bend the electrode when placing a new battery.
- When closing the cover, check that there is no dust or hair or anything else caught underneath it. A poorly sealed remote control unit could become deteriorated.

**NOTE**

- The QR code on the label shows the serial number of the key.

5. Store the mechanical key in the electronic key.

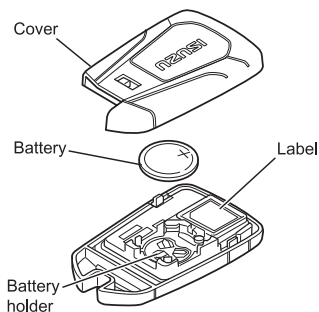
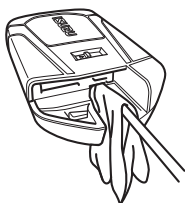

## Keyless Entry Key

Battery used	Number of batteries
Lithium battery Model number: CR1620 Voltage: DC3V	1

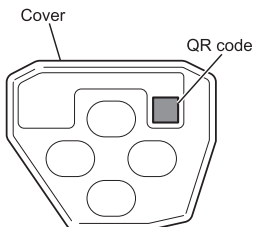
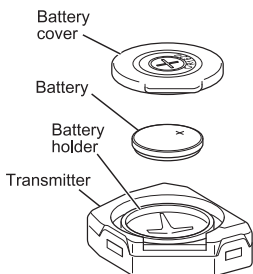
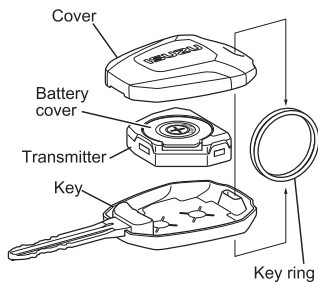

1. Remove the key ring and pry open the cover by inserting a flat-head screwdriver. Wrap a piece of cloth or tape around the tip of the screwdriver so as not to damage the cover. Remove the transmitter.

2. Open the battery cover and remove the battery.
3. Insert a new battery and close the battery cover.



## ADVICE

- Be careful not to bend the electrode when placing a new battery.
- When closing the battery cover and key cover, check that there is no dust, hair or anything else caught underneath it. A poorly sealed remote control unit could become deteriorated.



## NOTE

- The QR code on the label shows the serial number of the key.

4. Place the transmitter in the key and close the cover.

### Regarding Customizing Function of the Keyless Entry System

The settings of the keyless entry system can be changed by using the user customization function on the MJD. The settings of the keyless entry system can be changed by an Isuzu Dealer. For further details, please contact your Isuzu Dealer.

#### Settings (User Customization Function)

→ Refer to page 4-47

Display indication		Description	
Light	Interior light linked RKE	Enable	When the door is unlocked with the remote control unit, the dome light comes on.
		Disable	When the door is unlocked with the remote control unit, the dome light does not come on.

## Passive Entry and Start System

The passive entry and start system is a system that enables doors to be locked and unlocked by carrying the electronic key in your pocket. The electronic key can also be used as a remote control unit of the keyless entry system.

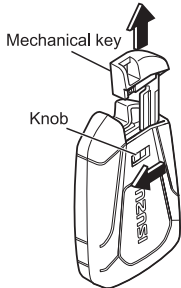

### Mechanical Key

Use the mechanical key to lock/unlock the doors when either the battery for the electronic key or that of the vehicle goes flat.

To take the mechanical key out, slide the knob and pull out the mechanical key.

When storing the mechanical key in the electronic key, insert until a clicking sound is heard.



### NOTE

- Keep the mechanical key stored in the electronic key for use in such cases as when electronic key battery goes flat or is broken.
- When the vehicle battery is weak or the voltage is low, the passive entry and start system function may not be possible. In this case, use the mechanical key to unlock the doors, and check the battery of the vehicle.

**Doors** → Refer to page 3-25

**When the Electronic Key Battery Goes**

**Flat** → Refer to page 7-7

**Handling the Battery**

→ Refer to page 6-115

**Anti-relay-attack Function**

To protect the vehicle from theft by devious means using a relay attack, you can turn off the function to unlock doors by the passive entry and start system of the electronic key.

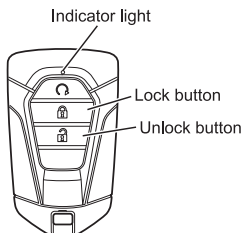

1. Press and hold the lock button, and then press the unlock button and hold them both for approximately 5 seconds.
2. The indicator light flashes two times and the function to unlock doors by the passive entry and start system of the electronic key is stopped.

Press one of the buttons on the electronic key to reactivate the function.

### Weak Radio Waves Emitted from Passive Entry and Start System

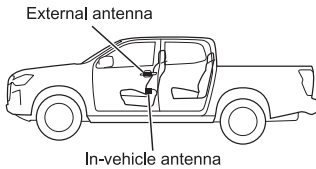
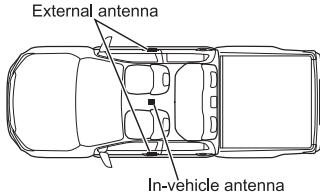

When using the passive entry and start system to lock/unlock the doors or to start the engine, radio waves will be transmitted from the vehicle's antenna in order to perform electronic verification.

Because of that, the passive entry and start system may not operate properly or consistently due to the following causes:

- When there is a facility nearby that is emitting strong radio waves.
- When communication devices such as mobile phones, two-way radios, or laptops are within the vicinity of the electronic key.
- When other metallic objects are touching or covering the electronic key.

#### **WARNING**

- Individuals with implanted cardiac pacemakers or implanted defibrillators should keep a distance of at least 22 cm (8.7 in) from any antennas installed to the vehicle. Radio waves emitted from passive entry and start system may affect the operation of such devices. Individuals using electronic medical devices should consult with the manufacturer of the device or with their doctor before use.

### Operating Range of Passive Entry and Start System

Operating range for locking and unlocking the doors

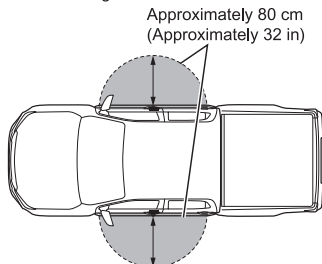

#### Locking and Unlocking the Door

By carrying the electronic key, it is possible to lock or unlock the doors by operating the request switches on the driver side door and passenger side door. The key must be within approximately 80 cm (32 in) of the door handle on the driver side door and passenger side door, in order to lock or unlock the doors.



#### NOTE

- Even when the electronic key is within approximately 80 cm (32 in) of the door handle on the driver side door, it may not operate if it is too close to the ground or high in the air.
- The electronic key may not operate if it is too close to the door or glass.

Operating range for starting the engine

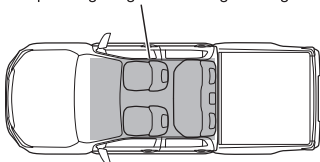

#### Starting the Engine

By carrying the electronic key, it is possible to start the engine by pushing the engine start/stop button.

The operating range for starting the engine is within the vehicle, excluding above the instrument panel, in storage areas such as the glove box or door pocket, as well as under the seat or on the floor in front of the driver and passenger seats.



#### NOTE

- It may still possible to start the engine when the electronic key is outside the vehicle and near to the doors or windows.

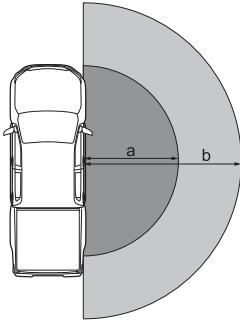
**Welcome Light and Walk Away Lock**

By carrying the electronic key, you can have the welcome lights turn on when you approach and have the walk away function lock the doors when you leave.

	Description
a	Operation range of welcome light (approximately 2 m (7 ft))
b	Operation range of walk away door lock (approximately 3 m (10 ft))

**Warning Buzzer of the Passive Entry and Start System**

If the system does not recognize the electronic key properly, the warning buzzer may beep.

Warning	Display indication
Lockout prevention	
No electronic key	"NO ELECTRONIC KEY" will be displayed in the multi-information display (MID).
Low battery electronic key	"LOW BATTERY ELECTRONIC KEY" will be displayed in the multi-information display (MID).

**NOTE**

- The warning buzzer may not beep properly because of the position of the electronic key or poor radio wave conditions.
- The warning buzzer may not sound if the electronic key battery voltage is low.
- The warning buzzer may not sound due to radio wave conditions when the electronic key is placed on the instrument panel and dashboard, in storage areas such as the glove box or door pocket, or when under the seat or on the floor in front of the driver and passenger seats, etc.
- Even when the electronic key is within the operating range for locking and unlocking the doors or the operating range for starting the engine, the warning buzzer may sound due to radio wave conditions. In this case, change the location of the electronic key.

**Warning Buzzer → Refer to page 4-106**

### Regarding Customizing Function of the Passive Entry and Start System

The settings of the passive entry and start system can be changed by using the user customization function on the MJD. The settings of the passive entry and start system can be changed by an Isuzu Dealer. For further details, please contact your Isuzu Dealer.

#### Settings (User Customization Function)

→ Refer to page 4-47

Display indication		Description	
Passive entry and start system	Communication mode	Radio ON	Turn on the radio waves of the passive entry and start system.
		Radio OFF	Turn off the radio waves of the passive entry and start system.
	Walk away lock	Enable	Turns on the walk away door lock.
		Disable	Turns off the walk away door lock.
	Answerback chime	Disable	Turns off the answerback buzzer.
		Min.	The answerback buzzer volume is low.
		Mid.	The answerback buzzer volume is middle.
	Walk away lock chime	Max.	The answerback buzzer volume is max.
		Enable	Turns on the walk away door lock chime.
		Disable	Turns off the walk away door lock chime.

## Welcome Light

The welcome light is a function to turn the dome light on when you approach the vehicle while carrying the electronic key.

### Conditions for Welcome Light Standby Operation

The welcome light becomes operable when the following conditions are satisfied.

- Lock the doors by using the passive entry and start system or keyless entry system.
- When the driver moves a certain distance away from the vehicle while carrying the electronic key.

### Conditions That Stop Welcome Light Operation

The welcome light does not come on if the following conditions are satisfied.

- When unlocking the doors by using the remote control unit.
- When starting the engine by using the remote engine start system.
- When the driver unlocks the doors with a mechanical key while not carrying the electronic key.
- When 5 days have passed while the welcome light is in operation standby.
- When you have been within about 5 m (16 ft) from the vehicle for more than 5 minutes.



### ADVICE

- To prevent battery discharge, this function is automatically turned off if more than 5 days have passed since the vehicle was last locked.
- Using this function consumes the vehicle battery more rapidly than normal.

The settings of the welcome light can be changed by using the user customization function on the MID.

### Settings (User Customization Function)

→ Refer to page 4-47

Display indication		Description
Welcome light	Enable	Turns on the welcome light function.
	Disable	Turns off the welcome light function.

## Doors



### CAUTION

- Before opening the door, carefully check all areas around the vehicle for safety, especially the area at the rear of the vehicle. If you abruptly open the door, it may be struck by a vehicle, etc. coming from behind.
- Exercise caution when opening or closing doors, as strong winds or steep slopes may cause doors to open or close suddenly.
- When you close the door from inside the vehicle, check that the door is fully closed. If the door is not properly closed, it may open while the vehicle is in motion.
- Before leaving the vehicle, be sure to stop the engine and lock the doors. Never leave the key in the vehicle.
- Do not pull on the inside door handles while the vehicle is moving. Be especially careful because the driver side door can be opened, even if the lock knob is in the lock position.

### Locking and Unlocking the Doors from Outside

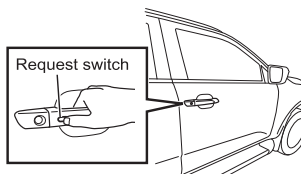

#### Using the Passive Entry and Start System

While carrying the electronic key, press the request switch on the driver side door and passenger side door to lock all the doors. Press it again to unlock all the doors.

#### Selectable Door Unlock

Press the request switch on the driver side door one time to unlock the driver side door. Press the switch two times to unlock all the doors.

Press the request switch on the passenger side door one time to unlock all the doors.

The selectable door unlock can be turned on or off by customizing function of the passive entry and start system on the MID.

#### Regarding Customizing Function of the Passive Entry and Start System

— Refer to page 3-23



#### NOTE

- When locking, the answerback buzzer sounds once, and the hazard warning lights flash once. If the dome light switch or map light switch is in the door position, the dome light or map light goes out.
- When unlocking, the answerback buzzer sounds twice and the hazard warning lights flash twice. If the dome light switch or map light switch is in the door position, the dome light or map light comes on for approximately 30 seconds.
- If the person with the electronic key is within operating range for locking and unlocking the doors, other people may also lock or unlock the doors by operating the request switch.
- The passive entry and start system will not lock the doors in the following cases:
  - The power mode is other than "OFF".
  - The electronic key is within operating range for starting the engine.
  - One of the doors is open.
- When leaving the vehicle, be sure to check that the doors are locked.
- If the function fails to operate normally, lock and unlock the doors using the key and have the system inspected by your Isuzu Dealer.

#### Passive Entry and Start System

— Refer to page 3-17

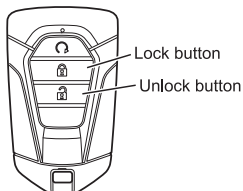
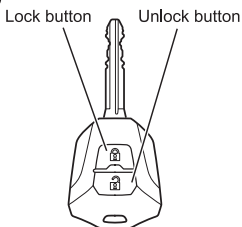
**Remote control unit (electronic key)****Remote control unit (keyless entry key)****Using the Remote Control Unit**

Pressing the lock button on the remote control unit locks all doors.

Pressing the unlock button unlocks all doors.

**Selectable Door Unlock**

Press the unlock button on the remote control unit one time to unlock the driver side door. Press the unlock button two times to unlock all the doors.

The selectable door unlock can be turned on or off by customizing function of the passive entry and start system on the MID.

**Regarding Customizing Function of the Passive Entry and Start System**

→ Refer to page 3-23

**Relock System**

After unlocking the doors using the remote control unit, the door will automatically relock in the following situations.

- The door is not opened within 30 seconds.
- The engine start/stop button is not pushed within 30 seconds (in models with passive entry and start system).
- The key is not inserted into the starter switch within 30 seconds (in models with keyless entry system and anti-theft system).

After unlocking the doors using the remote control unit, the door will not automatically relock in the following case.

- If your vehicle is not equipped with anti-theft system (in models with keyless entry system).

**NOTE**

- When locking, in models with passive entry and start system, the answerback buzzer sounds once. If the dome light switch or map light switch is in the door position, the dome light or map light goes out. At this time, in models with passive entry and start system, the hazard warning lights flash once.
- When unlocking, in models with passive entry and start system, the answerback buzzer sounds twice. If the dome light switch or map light switch is in the door position, the dome light or map light comes on for approximately 30 seconds. At this time, in models with passive entry and start system, the hazard warning lights flash twice.
- The function does not operate in the following cases:
  - One of the doors is open.
  - The power mode is in a mode other than "OFF" in models with passive entry and start system.
  - The key is inserted in the starter switch in models with keyless entry system.
- Repeatedly locking and unlocking the doors using the remote control unit in succession may trigger the protection circuit in the system, preventing the unit from working. If this happens, wait for a while. The system will then work normally.
- When leaving the vehicle, be sure to check that the doors are locked.
- If the function fails to operate normally, lock and unlock the doors using the key and have the system inspected by your Isuzu Dealer.

**Keyless Entry System**

→ Refer to page 3-11

**Using the Key**

Turn the key toward the front of the vehicle to lock the door and turn it toward the rear of the vehicle to unlock it.

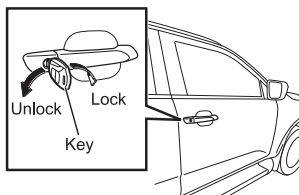

**NOTE**

- In models with a power door lock, all the doors will lock/unlock when the key is used to lock/unlock the doors. However, even in models with a power door lock, only the driver side door will lock/unlock in the case of models with a passive entry and start system and models with keyless entry system.
- In models with a passive entry and start system, use the mechanical key stored in the electronic key.
- After locking the doors, be sure to check that they are locked by pulling the door handles.

**Passive Entry and Start System**

→ Refer to page 3-17

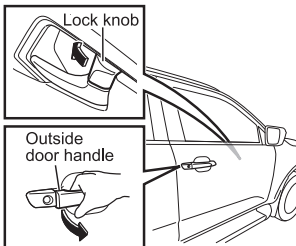
**Locking the Door from Outside without Using the Key**

First, push the lock knob forward to the lock position, then close the door while keeping the outside door handle raised.

**CAUTION**

- Before locking the door, be sure to check that you have the key with you. If you try to lock all the doors while the key is inside the vehicle, a buzzer sounds to prevent the key from being locked inside (models with passive entry and start system), and then all the doors unlock.

**NOTE**

- After locking the doors, be sure to check that they are locked by pulling the door handles.

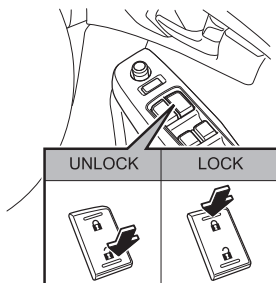
**Locking and Unlocking the Doors from Inside****Using the Power Door Lock Switch**

When the switch on the driver's door is operated, the power door lock system will automatically lock or unlock all the doors simultaneously.

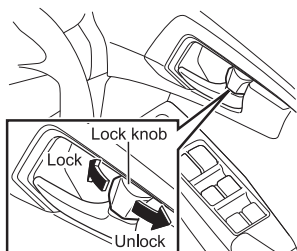
**Using the Lock Knob**

Push the lock knob forward for lock and pull the lock knob backward for unlock.

The driver side door can be unlocked by pulling on the inside door handle, even if the lock knob is in the lock position.

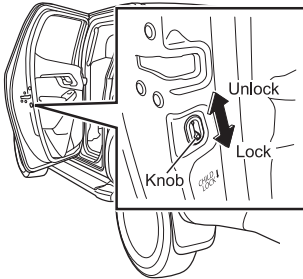
**Child-proof Door Locks (Crew Cab Model)**

If you place the knob in the lock position and close the door, it will be impossible to open the rear door from inside the vehicle.

**WARNING**

- Use the child-proof door lock when driving with children in the vehicle. Lock the rear doors on both sides with the child-proof door lock.

**NOTE**

- To open the rear door, unlock the door and pull the outside door handle. If you need to open the door from inside the vehicle, open the window, put your arm out, and pull the outside door handle.

### Locking and Unlocking the Doors by Vehicle System

#### Walk Away Door Lock (Models with Passive Entry and Start System)

When you move a certain distance away from the vehicle while carrying the electronic key, the doors are automatically locked. When the driver moves a certain distance away from the vehicle while carrying the electronic key, the buzzer sounds once and the hazard warning flashers flash once. When the driver moves further away from the vehicle, the doors are automatically locked.



#### NOTE

- The walk away door lock function operates when the following conditions are satisfied;
  - When the engine is stopped.
  - When the engine hood and doors are all closed.
  - When the electronic key is not in the vehicle.
- The walk away door lock function stops when the following actions are taken;
  - When a door is opened.
  - When the doors are locked with the lock button on the remote control unit.
  - When the doors are locked by the passive entry and start system.
  - When the system cannot recognize the electronic key.
  - When the electronic key is put in the vehicle, such as by throwing a bag, with the electronic key inside it, into the vehicle through a window, after the doors are locked.
  - When the driver stays near the vehicle for 30 seconds or more.
- If the walk away door lock function did not operate properly, the buzzer outside the vehicle sounds ten times to alert you. If this happens, be sure to lock the door with a method other than the walk away door lock.

The settings of the walk away door lock can be changed by using the user customization function on the MID.

#### Settings (User Customization Function)

→ Refer to page 4-47

Display indication		Description
Walk away lock	Enable	Turns on the walk away door lock.
	Disable	Turns off the walk away door lock.
Walk away lock chime	Enable	Turns on the walk away door lock chime.
	Disable	Turns off the walk away door lock chime.

### Auto Door Lock (Models with Passive Entry and Start System and Keyless Entry System)

This function automatically locks all doors depending on vehicle conditions.

Lock type	Description
Speed linked door lock	When the vehicle accelerates from a full stop and the vehicle speed reaches the set speed, all doors are locked.
Shifter linked door lock*	When the selector lever is placed in a position other than the "P" position, all doors are locked.

\*: Models with automatic transmission



#### NOTE

- The factory default setting is the speed linked door lock, which operates when the speed reaches 20 km/h (13 MPH) and reactivates after a door is opened and closed.

#### Automatic Transmission

→ Refer to page 4-145

The settings of the auto door lock can be changed by using the user customization function on the MID.

#### Settings (User Customization Function)

→ Refer to page 4-47

Display indication		Description
Auto lock type	Disable	Disables the auto door lock.
	Speed	Activates the speed linked door lock.
	Except Shift-P *1	Activates the shifter linked door lock.
Auto lock speed	20 km/h (13 MPH)	Sets the speed linked door lock to operate when the vehicle speed reaches 20 km/h (13 MPH).
	12 km/h (8 MPH)	Sets the speed linked door lock to operate when the vehicle speed reaches 12 km/h (8 MPH).
Auto lock enable by door *2	Enable	Enables the auto door lock to relock doors after they are opened and closed.
	Disable	Disables the auto door lock from relocking doors after they are opened and closed.

\*1: Models with automatic transmission

\*2: You can set the auto door lock function to reactivate or not reactivate when a door is opened and closed after the doors were locked by the auto door lock function.

**NOTE**

- If "Auto lock enable by door" is set to "Disable", the auto door lock function is canceled when a door is opened and closed after the doors were locked by the auto door lock function. However, under the following conditions, the auto door lock function is reactivated.
  - When the power mode is set to "ON" from "OFF" again (models with passive entry and start system).
  - When the starter switch is turned to the "ON" position from the "LOCK" position again (models with keyless entry system).

### Auto Door Unlock (Models with Passive Entry and Start System and Keyless Entry System)

This function automatically unlocks all doors depending on vehicle conditions.

Unlock type	Description
Key linked door unlock *1	When the key is pulled out from the starter switch, all doors are unlocked.
Ignition linked door unlock	When the power mode is set to "OFF" (models with passive entry and start system) or the starter switch is turned to the "LOCK" position (models with keyless entry system), all doors are unlocked.
Shifter linked door unlock *2	When the selector lever is placed in the "P" position, all doors are unlocked.

\*1: Models with keyless entry system

\*2: Models with automatic transmission

**NOTE**

- The following are set at the factory.
  - Key linked door unlock (models with keyless entry system)
  - Ignition linked door unlock (models with passive entry and start system)
- When approximately 60 minutes have passed since the power mode was set to "ACC" (models with passive entry and start system), all doors are unlocked.

**Automatic Transmission**

→ Refer to page 4-145

**Engine Start/Stop Button (Models with Passive Entry and Start System)**

→ Refer to page 4-112

**Starter Switch (Models without Passive Entry and Start System)**

→ Refer to page 4-115

The settings of the auto door unlock can be changed by using the user customization function on the MID.

**Settings (User Customization Function)**

→ Refer to page 4-47

Display indication	Description	
Auto unlock type	Disable	Disables the auto door unlock
	KEY *1	Activates the key linked door unlock
	IGN	Activates the ignition linked door unlock
	Shift-P *2	Activates the shifter linked door unlock

\*1: Models with keyless entry system

\*2: Models with automatic transmission

**Impact Sensing Door Unlock (Models with Passive Entry and Start System and Keyless Entry System)**

If the vehicle receives a strong impact from the front, left, or right side when the power mode is "ON" (models with passive entry and start system) or when the starter switch is in the "ON" position (models with keyless entry system), all the doors will be unlocked.

**NOTE**

- When the impact sensing door unlocking function activates, the hazard warning flasher will flash to alert the driver of an abnormality at the same time. In order to stop the hazard warning flasher, switch the power mode to "OFF" once before switching the power mode back to "ON" (models with passive entry and start system), or turn the starter switch to the "LOCK" position once before turning the starter switch back to the "ON" position (models with keyless entry system).
- However, depending on the manner in which the impact is applied, this function may not activate.

### Opening and Closing the Doors from Outside

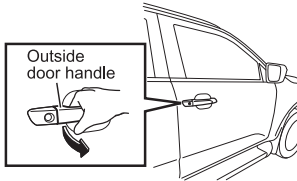

To open the door, pull the outside door handle.

To close the door, push the outside door handle.

### Opening and Closing the Doors from Inside

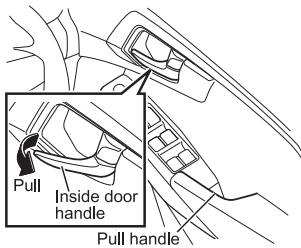

To open the door, pull the inside door handle.

To close the door, pull the pull handle.



#### NOTE

[ACC mode reminder buzzer]

- In models with passive entry and start system, if the driver's door is opened when the power mode is "ACC", a buzzer will sound to warn that the power mode is not switched to "OFF". When the power mode is switched to "OFF", the warning buzzer will stop sounding.

[Key reminder buzzer]

- In models without passive entry and start system, if the driver's door is opened when the starter switch is in the "ACC" or "LOCK" position, a buzzer will sound to warn that the key has not been removed. When the key is removed, the warning buzzer will stop sounding.

**Side Access Panel (Extended Cab Model)****CAUTION**

- Before opening the side access panel, check that the passenger in the front seat has removed his/her seat belt. If the side access panel is opened while the seat belt is worn, the seat belt will lock and it will not be possible to pull it out. The passenger in the front seat may become trapped and could be injured.
- Exercise caution when opening or closing doors, as strong winds or steep slopes may cause doors to open or close suddenly.
- When operating the inside door handle on the side access panel, be careful not to get your hand caught in the gap between the inside door handle and the inside door handle cover. If this happens, your hands or fingers could be injured.
- Because it will not be possible to close the front door securely when the side access panel is half-open, it may open while the vehicle is in motion.

**ADVICE**

- Do not open or close the side access panel while the front door is not completely open. Otherwise, the side access panel may contact the front door and could be damaged.
- Do not open or close the front door and side access panel at the same time. Otherwise, the side access panel may contact the front door and could be damaged.
- After closing the front door, do not close the side access panel. Otherwise, the side access panel may contact the front door and could be damaged. Always close the front door after first closing the side access panel.

**NOTE**

- The side access panel cannot be opened when the front door is closed.

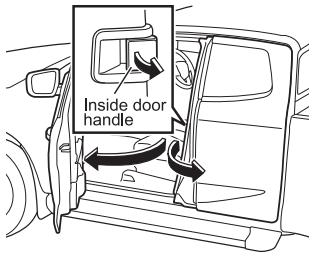
**Opening and Closing the Side Access Panel from Outside**

To open the door, after first opening the front door, pull the inside door handle and open the side access panel.

To close the door, after closing the side access panel, push the outside door handle of the front door and close the door.

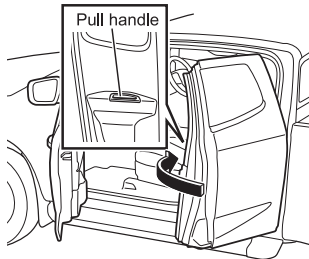
**Opening and Closing the Side Access Panel from Inside**

To open the door, push the inside door handle while the front door is open.

To close the door, pull the pull handle while the front door is open.

## Tailgate



### CAUTION

- Do not drive the vehicle with the tailgate open.



### NOTE

- The support stays will hold the tailgate open level.

## Opening and Closing the Tailgate

### To Open

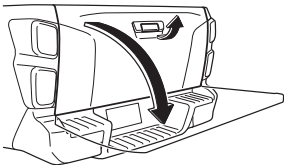

### Center Handle Model

Pull the handle in the center of the tailgate to release the lock, and then open the tailgate slowly.

Close the tailgate slowly. Move the tailgate back and forth to check that it is securely locked.

### To Close

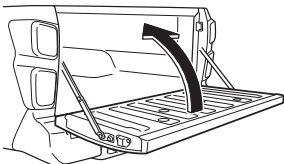

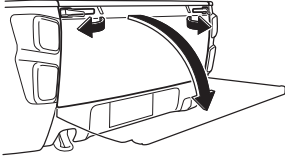
**To Open****Side Handle Model**

Pull the handle on both sides of the tailgate to release the lock, and then open the tailgate slowly.

To close the tailgate, use the opening procedure in reverse. Check that the lock is applied securely.

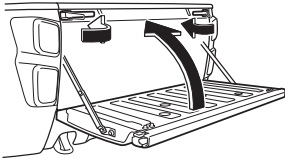
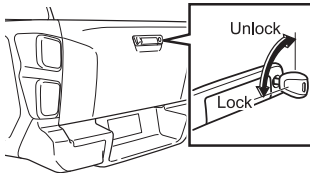
**To Close****Tailgate Lock (with Key Lock)**

Firmly insert the key.

Turn it to the left to lock the tailgate. Turn it to the right to unlock the tailgate.

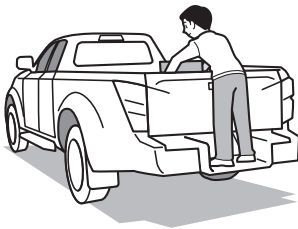
**Rear Step Bumper**

Use the rear step bumper for easy loading and unloading of cargo.

**WARNING**

- Do not allow more than one person at a time to step on the rear step bumper. The rear step bumper may be damaged.
- Do not move the vehicle when there is a person on the rear step bumper.
- Do not stand on the rear step bumper when the vehicle is moving.

### Guard Frame Stopper

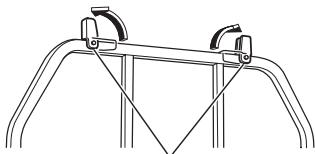

Guard frame stopper

When securing cargo to the guard frame, use the guard frame stopper to prevent these cargo from shifting. When using the guard frame stopper, lift it up to the outside of the vehicle.



#### CAUTION

- When securing cargo using the guard frame, do not apply excessive force.

## Getting In and Out of the Vehicle

When getting in or out of the vehicle, carefully check that the area around the vehicle is safe, hold the grip (if equipped), and place your foot on the side step (if equipped).

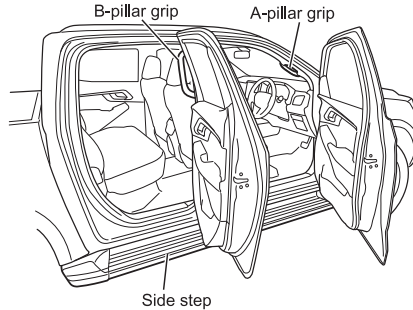

### CAUTION

- When getting in or out of the vehicle, make sure you use the grip and step, etc. to always support yourself from at least three points. Furthermore, do not try to jump in or out of the vehicle, as doing so could cause unexpected accidents or injuries.
- In models with side steps, to avoid slipping over, do not step on the non-grooved area of the steps.
- In models with side steps, rain and snow can cause the side step to become very slippery. Therefore, always remove snow and ice from your shoes and the side step, and be careful not to slip when getting in and out of the vehicle.
- Getting in or out of the vehicle with oily or greasy hands or shoes could cause you to slip. Always thoroughly clean grease etc. from your hands and shoes before getting in or out of the vehicle.



### ADVICE

- Do not hold parts other than the grip when getting in or out of the vehicle. Doing so may cause damage to the vehicle or injuries to yourself or others.

## Coming Home Light Function

This function turns on the headlights (low beam) and clearance lights to enhance safety after leaving the vehicle.

### Models with Coming Home Light

→ Refer to page 4-123

## Power Windows

Operate the switch to open or close the window. The power windows operate only when the power mode is "ON" (models with passive entry and start system) or when the starter switch is in the "ON" position (models without passive entry and start system).

### WARNING

- Before closing the windows, make sure that there is no risk of a hand, head or anything else being trapped in the moving window. Failure to do so could result in serious injury. This is especially true when a child is with you.
- Do not allow children to operate the power window. A child may become trapped or stuck in the window and this could result in serious injury.
- Do not attempt to insert hand or place your head between the window and the window frame in order to ensure that the jam protection function operates properly. Failure to do so could result in serious injury.
- In models that can close the driver's window in automatic mode, the jam protection function may not operate if an object becomes trapped just before the window fully closes. Also, the function will not operate if the window switch is continuously raised. Pay attention that your fingers do not become trapped. Failure to do so could result in serious injury.

### ADVICE

- When opening or closing the window, do not operate the driver side window switch and the window switch of another door in the opposite direction at the same time.
- After the window is fully open or closed, do not continue to operate the window switch in the same direction.

### NOTE

- In models that can close the driver's window in automatic mode, when the battery has been reconnected, perform the following initialization settings in order to operate the driver's power window properly.
  - Open the driver's window halfway. Pull up the driver's window switch to fully close the driver's window and then keep the switch in this position for 2 seconds.

## Opening and Closing the Windows

## Driver's side

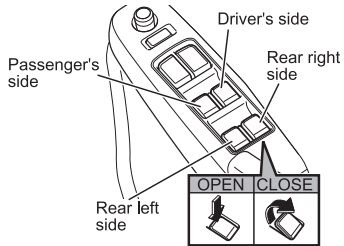

Operate the switch to open or close the window.

**NOTE**

- All the windows can be opened or closed using the switch on the driver's side.
- Crew cab models have a switch with the same function on the rear door as well.

## Passenger's side

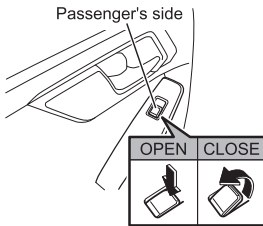

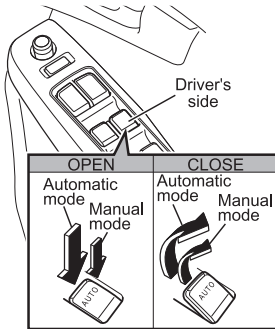

### Automatic Mode (Driver's Side)

When you firmly operate the switch to open the window, the window opens in the automatic mode.

When you operate the switch lightly, the window opens or closes in the manual mode. The window opens or closes only when the switch is operated.

In models with the automatic closing function, firmly operating the switch to close the window causes the window to close in the automatic mode.



### NOTE

- To stop the window while it is opening or closing in the automatic mode, lightly move the switch to the other side.

[Jam protection function]

- In models with the automatic close window function, to prevent any foreign objects inserted between the window frame and the window from getting trapped when a window is closed by the automatic mode, a jam protection function stops operation and opens the window slightly.

[Operations after stopping the engine]

- In models with an automatic close window function, the driver's window can be opened or closed using the window switches on the driver's door for approximately 40 seconds after the power mode is switched to a mode other than "ON" (models with passive entry and start system) or the starter switch is turned to a position other than the "ON" position (models without passive entry and start system). However, if the doors are opened, the window cannot be opened or closed, even within this 40-second period.

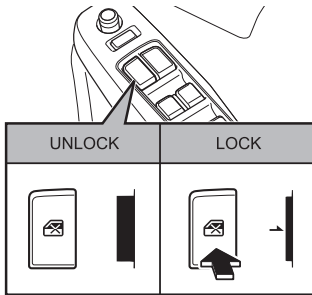

### Power Window Lock Switch

If you push the power window lock switch, only the driver's window will be operable. To cancel the passenger's window and rear power windows (crew cab model) lock, push the switch again.

#### WARNING

- Use the power window lock switch to lock the passenger's window and rear power windows (crew cab model) when carrying a child in the vehicle. By doing so, you can prevent the child from operating the passenger's window and rear power windows (crew cab model) and causing an accident.

### Manually Operated Windows



#### CAUTION

- Be sure that you and the passenger are at no risk of having any part of the body become trapped in the window. You should be especially careful if a child is with you.

### Window Regulator Handle

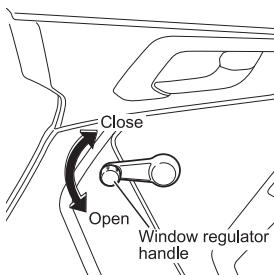

Turn the window regulator handle to open or close the window.

### Quarter Window Opener (Extended Cab Model)

Quarter window opener

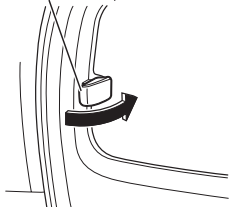

The quarter window on each side can be opened and closed by operating the quarter window opener.

## Fuel Tank Filler Cap

### WARNING

- Be sure to switch the power mode to "ACC" or "OFF" (models with passive entry and start system) or to turn the starter switch to the "ACC" or "LOCK" position (models without passive entry and start system) to stop the engine before refueling the vehicle. Refueling while the engine is running could cause a fire in your vehicle.
- Open the fuel tank filler cap slowly. If you open it quickly, the fuel tank pressure may cause fuel to spurt out.
- When refueling, never smoke or place any ignition source nearby. There is a risk of fire.
- After refueling, make sure that the fuel tank filler cap is tightly closed.
- Do not use any fuel tank filler cap that is not an Isuzu genuine part. The use of an improper fuel tank filler cap could cause fuel spillage in the event of an accident. The use of an improper fuel tank filler cap could also affect the fuel system and the emission control system.
- Be sure to wipe off the fuel that is spilled at refueling.
- Use diesel fuel that is specified by the relevant vehicle emission standards. For specified diesel fuel, check "Recommended Fluids, Lubricants and Diesel Fuels".
- Do not add or mix in poor quality fuels, or gasoline, kerosene, alcohol-based fuels, or any fuels that are not diesel, or water removing agents or other fuel additives. Starting the engine with inappropriate fuel in the tank is very dangerous because it may adversely affect the fuel filter and cause poor movement of fuel-lubricated parts in the injectors, in addition to adversely affecting engine components, and could possibly result in a breakdown or even a fire.
- If inappropriate fuel is accidentally added to the tank, drain it out completely.

**CAUTION**

- Using diesel fuel other than those specified by the relevant vehicle emission standards could prevent the vehicle from complying with local legal requirements.

**ADVICE**

- Do not use diesel fuel with higher sulfur content than the diesel fuel that is specified by the relevant vehicle emission standards. Using high-sulfur diesel fuel may adversely affect the engine, exhaust emission reduction system, or EGR system, possibly resulting in a breakdown.

**Using Self-service Filling Stations**

→ Refer to page 2-4

**Recommended Fluids, Lubricants and**

**Diesel Fuels** → Refer to page 6-144

## Opening and Closing the Fuel Tank Filler Cap

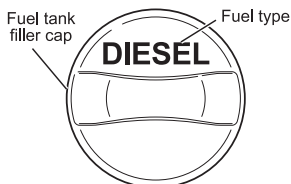
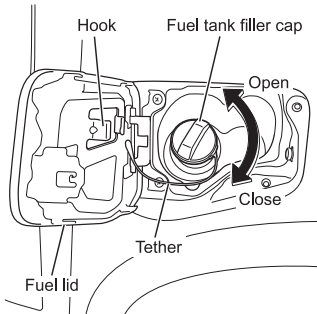
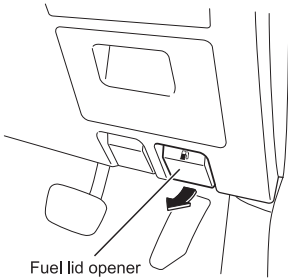
**Fuel Tank Filler Cap without Key Lock**

1. To open the fuel lid on the cargo side, pull the fuel lid opener toward you.
2. Eliminate static electricity from your body before opening the fuel tank filler cap.
3. Slowly turn the cap counterclockwise to open it.
4. After removing the fuel tank filler cap, hang it on the hook.
5. Refill the fuel tank.
6. Turn the fuel tank filler cap clockwise until it clicks more than three times to install it securely.
7. Close the fuel lid on the cargo side.

**ADVICE**

- If the fuel tank filler cap is not hung on the hook, the fuel tank filler cap may hit the body panel and the remaining fuel on the fuel tank filler cap may damage the body paint.
- Closing the fuel lid while the tether is twisted abnormally may cause the tether to be damaged.

**NOTE**

- Allowable fuel type ("DIESEL") is shown at the fuel tank filler cap.

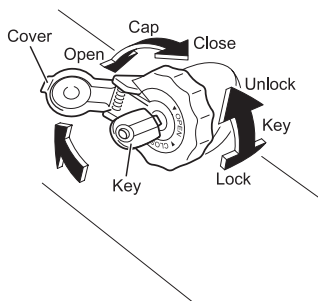

### Fuel Tank Filler Cap with Key Lock

1. Eliminate static electricity from your body before opening the fuel tank filler cap.
2. Open the cover, then firmly insert the key and turn it to the "OPEN" position.
3. Slowly turn the cap counterclockwise to open it.
4. Refill the fuel tank.
5. Securely screw the fuel tank filler cap onto the fuel filler neck.
6. Turn the key to the "CLOSE" position to lock the fuel tank filler cap.
7. Pull the key out, then make sure the fuel tank filler cap is securely closed.

### WARNING

- If the fuel tank filler cap is not tightly closed, leaking fuel could start a fire while driving.

### ADVICE

- When opening or closing the fuel tank filler cap, be sure to grasp the fuel tank filler cap itself, not the key. If you try to turn the fuel tank filler cap using the key, you could damage the key.
- Wipe off the key to remove any dirt or dust, etc. after pulling it out.

### NOTE

- Allowable fuel type ("DIESEL") is shown at the fuel tank filler cap.

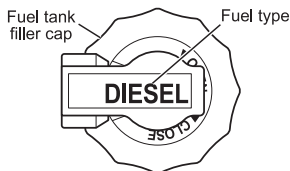

## Seats

The driver's seat must be adjusted so that when you sit well back in the seat, you can fully depress the pedals without moving your back from the seatback, and you can operate the steering wheel easily and freely. After making adjustments, check that the seat is completely locked.

Adjusting the seat for a correct driving posture is a fundamental part of safe driving.

Make sure you can turn the steering wheel easily.

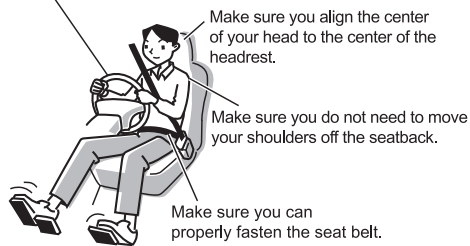

Make sure you can adequately depress the pedals.

### **WARNING**

- Use caution when adjusting the seat, as failure to do so could cause injury.
- Never allow children to adjust their seats themselves; an adult should adjust the seat for occupants who are children.
- Adjust the seat only before you start driving. Adjusting the seat while the vehicle is in motion must be avoided not only because the unlocked seat will move back and forth unstably, preventing you from taking the correct position, but might also cause you to lose control of the vehicle, possibly resulting in an accident.
- Try to move the seat without unlatching it after making adjustments to check that it is completely locked. A loosely locked seat may move unexpectedly and your position might then become unstable; this could lead to an accident. Take the vehicle to your Isuzu Dealer for service if you find that your seat adjusters do not latch. In addition, the seat belt will not operate properly if the seatback is not completely locked.
- Driving with the seat excessively reclined could be very dangerous in a collision or sudden stop. Raise the seatback, and wear the seat belt correctly while sitting well back and straight up in the seat.

WARNING (Continued)

## WARNING (Continued)

- Do not place a cushion or similar object between your back and the seatback. Doing so not only affects the stability of your driving position but also prevents the seat belt from working effectively in the event of a collision.
- Do not place any objects under the seat. If there are any objects under the seat, the seat could be locked in an improper position.
- Before making adjustments, check that the seat rails are free of anything that could obstruct the locking of the seat. Be careful that hands and feet do not become trapped in the seat or rails when adjusting the seat and that the seat does not hit any objects or passengers while it is being adjusted.
- When you adjust the seat, be careful that the seat does not hit passengers or objects. Doing so could cause injury to passengers, or damage objects.



## ADVICE

- In models with leather seat, to avoid damage and wear to leather sections, refer to the following items:
  - Remove dust and sand as soon as possible.
  - Wipe as soon as possible when wet with water, etc.
  - Avoid prolonged exposure to direct sunlight. Store the vehicle in the shade, especially in summer.
  - Do not place vinyl or plastic products, or those containing wax, onto the leather because such products may stick to the leather.

Adjusting the Driver Seat

Adjust the seats according to the table.

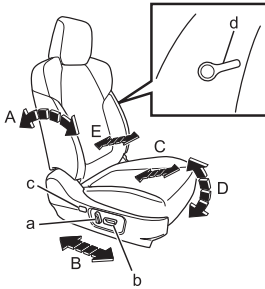

Power Seat

	Adjustment	Switch	How to operate
A	Reclining	a	
B	Forward/Backward	b	
C	Seat height	b	
D	Height of the front edge of the seat cushion	b	
E	Lumbar support (if equipped)	c	
		d	

CAUTION



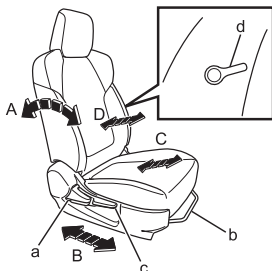

- When adjusting the seat, pay attention so that your fingers or other parts of your body do not become trapped in the seat. Failure to do so could result in serious injury.

ADVICE

- The seat can be adjusted regardless of the power mode (models with passive entry and start system) or the position of the starter switch (models without passive entry and start system). However, adjusting it consumes a lot of electricity and could discharge the battery completely.



## Manual Seat

	Adjustment	Lever	How to operate
A	Reclining	a	
B	Forward/Backward	b	
C	Seat height (if equipped)	c	
D	Lumbar support (If equipped)	d	

**CAUTION**

- When adjusting the seat, pay attention so that your fingers or other parts of your body do not become trapped in the seat. Failure to do so could result in serious injury.
- When reclining the seatback, hold the seatback with your hand while raising the seatback tilt lever. The seatback may suddenly move forward if it is not held with your hand, causing an injury. Once the seatback has returned to its original position, check that the seatback is fully locked by trying to rock it forward and backward.

Adjusting the Front Passenger Seat



Adjust the seats according to the table.

 CAUTION

- When adjusting the seat, pay attention so that your fingers or other parts of your body do not become trapped in the seat. Failure to do so could result in serious injury.
- When reclining the seatback, hold the seatback with your hand while raising the seatback tilt lever. The seatback may suddenly move forward if it is not held with your hand, causing an injury. Once the seatback has returned to its original position, check that the seatback is fully locked by trying to rock it forward and backward.

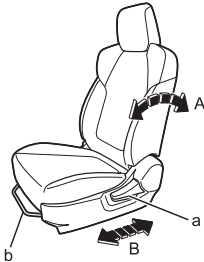
Bucket Seat



	Adjustment	Lever	How to operate
A	Reclining	a	
B	Forward/Backward	b	

Bench Seat

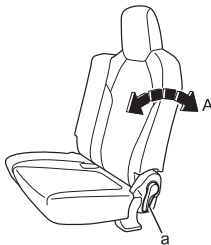

	Adjustment	Lever	How to operate
A	Reclining	a	

### Second Seat (Crew Cab Model)

#### WARNING

- Do not move the second seat while driving.
- Do not place cargo higher than the seatback. Doing so may block the rear view and cargo may fly forward when suddenly applying the brakes.
- Do not use the seat belt if the seat belt guide is not installed. If the seat belt guide is not installed, the seat belt will not be properly retracted.

Seat Belts → Refer to page 3-67

#### Folding the Seatback

It is possible to fold the seatback forward by pulling the strap.

Before folding the seatback forward, adjust the headrest to the storage position. In addition, remove the seat belt guides from the seats on both sides and move the seat belt outward.

After returning the seatback to its original position, pass the seat belts on both sides through the seat belt guides, and then attach the seat belt guides to the headrest supports.

#### Adjusting the Headrest

→ Refer to page 3-61

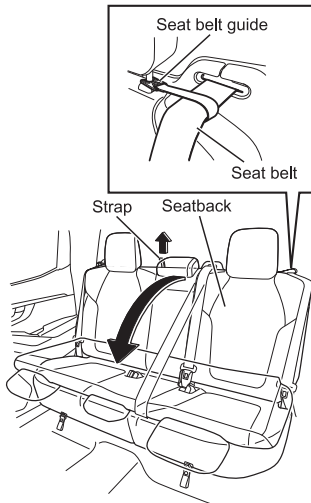

#### WARNING

- Do not sit on a folded seatback or place objects on it while driving.
- When you return the seatback to the original position, try to move the seatback to check that it is completely locked. In addition, the seat belt will not operate properly if the seatback is not completely locked.

**⚠ CAUTION**

- When you fold the seatback forward or return it to the original position, be careful not to trap a hand or foot.
- When folding the seatback forward, hold the seatback with your hand while pulling the strap up. The seatback may suddenly move forward if it is not held with your hand, causing an injury.
- When you fold the seatback forward, be careful that the seatback does not hit passengers or objects.

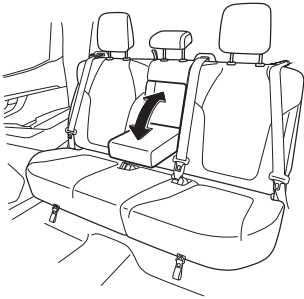
**Center Armrest**

In models with a center armrest, pull the armrest out from the seatback, then push it forward to use.

**⚠ WARNING**

- Do not sit on the center armrest or place heavy objects on it.

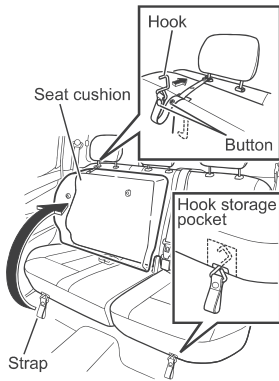

### Raising the Rear Seat Cushion (Crew Cab)

Pull the strap forward to raise the seat cushion. Remove the hook of the strap edge from the strap button and secure the hook to the headrest stay.

#### **WARNING**

- When raising the seat cushion, the hook of seat cushion strap must be secured to the headrest stay to keep the seat cushion locked safely in the storage position.
- When returning the seat cushion to its original position, hold the seat cushion and slowly lay it down. Be careful not to crush the seat cushion against the seat belt buckles. (Push the seat belt buckles to lay in horizontal flat position to avoid crushing against seat cushion). Finally, try to move the seat cushion to check that it is completely locked.
- After returning the seat cushion to its original position, do not forget to return the hook to the hook storage pocket.

## Adjusting the Headrest

 **WARNING**

- Do not drive with a headrest removed. There is a chance that impacts to the head area would not be prevented and this could result in serious injury.
- Be sure to adjust the headrest before driving. If you adjust the headrest while the vehicle is in motion, you will be unable to maintain the correct driving posture. This may cause an accident.
- After making adjustments, try to move the headrest to check that it is completely locked.
- Use the appropriate headrest for each seat.

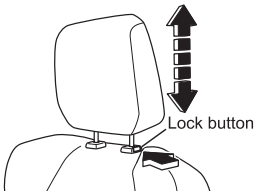
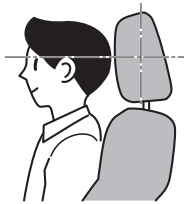
**Driver and Front Passenger Seat**

Make adjustments that align the center of your head to the center of the headrest. When raising it, lift it up in this position. When lowering it, push the lock button while pushing the headrest down.

**NOTE**

- The headrest has 5 adjustment levels.

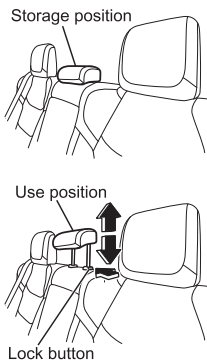

### Second Seat (Crew Cab Model)

Always select the use position when sitting in the center seat.

When selecting the use position, move the headrest to the securely locked position in which a clicking sound can be heard.

When selecting the storage position, push the lock button while pushing the headrest down.



#### NOTE

- The second seat headrest can only be changed between the use position and storage position.

### Installation and Removal

When pulling out or inserting a headrest, press the lock button.

## Fully Adjustable Steering

The steering wheel is adjustable up and down as well as forward and backward.

### WARNING

- When you have adjusted the steering wheel, try shaking the steering wheel to check that it is securely locked in position before driving.
- Adjust the position of the steering wheel before you start driving. Adjusting the position of the steering wheel while driving would be extremely dangerous because the steering wheel becomes unstable and prevents precise steering.

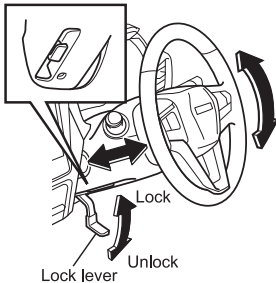

### Adjustment

1. While holding the steering wheel, lower the lock lever downward to unlock the steering column.
2. Sit in the correct driving position, and then move the steering wheel up and down, and forward and backward to select the optimum steering wheel position.
3. Firmly lock the steering wheel at the selected position by moving the lock lever to the lock position.

## Mirrors

Sit in the correct driving position on the properly adjusted seat, and then check each mirror to ensure that it provides a proper view of the rear and the sides. Make adjustments if necessary and clean any dirty mirrors.

### Inside Rearview Mirror

#### WARNING

- Adjust the mirror when the vehicle is stationary, not while the vehicle is in motion.

#### ADVICE

- Do not clean the rearview mirror glass with a cleaner containing ammonia or acetic acid. Doing so may result in damage to the mirror's coating.

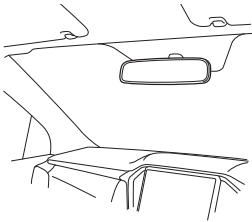

Move the mirror to a position where it provides a proper rear view.

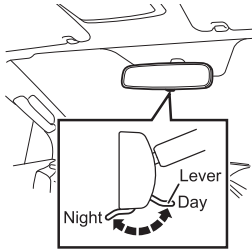

### Rearview Mirror with Manual Anti-glare Function

Normally, keep the lever directed forward (Day). When the headlights of vehicles behind you are reflected and dazzle you while driving at night, pull the lever toward you (Night). You can reduce the dazzle by doing this.



#### NOTE

- Adjustment of the mirror should be performed while the lever is directed forward (Day).

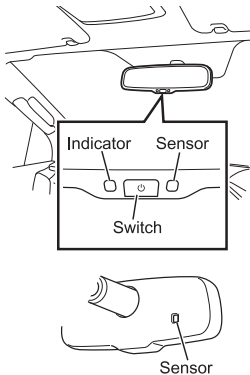

### Rearview Mirror with Automatic Anti-glare Function

The rearview mirror with the automatic anti-glare function automatically reduces reflected light according to the glare of the headlights of the vehicle behind. When the function is on, the indicator on the mirror comes on. Switching the function to off by pressing the switch turns off the indicator.



#### NOTE

- When the engine is started, the function is on.
- To prevent erroneous operations, do not cover the sensor on the mirror with anything or touch it with your hands.
- When the gearshift lever (manual transmission models) or selector lever (automatic transmission models) is in the "R" position, the anti-glare function is automatically turned off.

### Outside Rearview Mirrors

After properly adjusting your seat for proper driving position, adjust the mirrors indicated below so that they provide adequate views for checking the rear and the side by moving each of the mirrors.

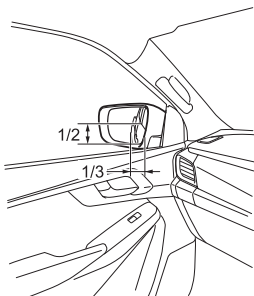

#### Lateral-direction

Adjust the mirror so that you can see the vehicle's side including the inner one-third of the mirror.

#### Vertical-direction

Adjust the mirror so that you see the rear bottom corner of the vehicle halfway up the height of the mirror.

#### WARNING

- Adjust the mirrors when the vehicle is stationary, not while the vehicle is in motion.
- Do not drive with the mirrors folded.

#### CAUTION

- When checking the rear of the vehicle with mirrors, be careful that this does not distract your attention from the traffic ahead.
- Rearview mirrors may make the vehicle behind you appear farther away than it really is. Use these mirrors very carefully until you are able to correctly determine distances from the images.
- Keep the mirrors in mind when passing another vehicle on a narrow road, moving the vehicle into a garage or driving near pedestrians.

#### Remote Control Mirror Switch

→ Refer to page 4-138

## Seat Belts



Seat belts must be worn not only by the driver but also by the passenger(s) before the vehicle starts moving. You should be fully acquainted with the proper use of seat belts and important points to be respected as described in the following pages.

Familiarizing yourself with the correct use of seat belts is essential for your safety.

### WARNING

- Wearing seat belts is a legal requirement. The driver is responsible not only for wearing a seat belt himself/herself but also for prompting all passengers to wear their seat belts. However, for expectant mothers and passengers who have chest/abdominal conditions, it is necessary to check with a doctor about the appropriateness of seat belts as well as for specific recommendations about wearing seat belts.
- Seat belts must always be fastened before starting to drive.
- Have your child wear a seat belt. However, use a suitable child restraint system (CRS) in the following situations.
  - When required by legal regulations and safeguards.
  - When the child is so small that the seat belt touches his/her face or does not lie across his/her hip bones.
- Do not let children play with seat belts. Playing by twisting seat belts around a child's body in particular may cause serious injury, such as suffocation. If a seat belt is twisted and gets stuck around a child's body, cut the belt using scissors, etc.
- Do not disassemble the seat belts or modify the system.
- Be careful to keep the buckles and retractors free of dust and other foreign matter (such as coins and paper clips).
- Do not place objects near the seat belts if the objects could damage the seat belts.
- Regularly inspect to see if the seat belts, buckles, latch plates, retractors, and anchors function properly.
- Have seat belts inspected and, if necessary, replaced by the nearest Isuzu Dealer when the webbing becomes frayed or worn and/or when the buckle or other mechanical parts fail to work properly. You, your passengers and especially your child are at risk of death or serious injury when using a seat with a defective seat belt.

WARNING (Continued)

## WARNING (Continued)

- If your vehicle has been involved in a collision, the seat belts worn at the time may have lost their original strength due to impact even if they appear intact. These seat belts must be inspected and, if necessary, replaced by the nearest Isuzu Dealer.
- When replacing the seat belts, use genuine Isuzu seat belts intended for each seat and install them in the correct positions.



## NOTE

- The driver's seat belt and the passenger's seat belt feature pretensioner and load limiter functions.
- The three-point seat belts are provided with an emergency locking retractor (ELR) function.

[Load limiter function]

- The load limiter allows the seat belt to extend while maintaining the load working on the belt at a constant level. This helps alleviate the shock applied on the occupant's chest.

[ELR function]

- The ELR normally allows the seat belt to move in and out freely as the occupant moves. However, it locks the seat belt to restrain the occupant when a forward force resulting from a collision or sudden stop acts on the occupant.
- The ELR also locks the seat belt when the belt is pulled out quickly. If this happens, allow it to retract once and then pull it out slowly.
- You can check that the ELR locks the belt by pulling out the belt quickly.

[Center seat belt design to prevent incorrect fastening]

- The center seat belt is designed so that it cannot be connected with any of the window side seat belts.

**Seats** → Refer to page 3-53

**Seat Belt with Pretensioner**

→ Refer to page 3-99

**Child Restraint System (CRS)**

→ Refer to page 3-77

**Front Seat Belt Warning Light**

→ Refer to page 4-61

**Seat Belt Care** → Refer to page 6-132

### To Fasten/Unfasten the Seat Belts

The protection provided by seat belts might be significantly reduced if they are not fastened properly; in certain cases, improperly fastened seat belts can even play a role in causing injury to the wearer.

Position the shoulder belt so it is on your shoulder (not touching your neck, chin or face).

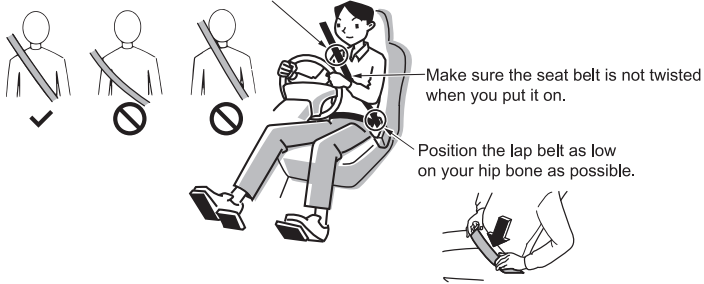

#### **WARNING**

- Have your child wear a seat belt. However, use a suitable child restraint system (CRS) in the following situations.
  - When required by legal regulations and safeguards.
  - When the child is so small that the seat belt touches his/her face or does not lie across his/her hip bones.
- Do not use one seat belt for more than one person. If worn by more than one person, the seat belt would not work effectively in a collision or sudden stop. If you hold your child in your arms or on your knees, you will not be able to keep holding the child during sudden braking or a collision and the child will be thrown from you or crushed. This may result in serious injury.
- Seat belts provide full protection only when the driver and passenger(s) fasten them while sitting upright and fully back on the seat.
- Wearing a seat belt with the seatback excessively reclined could be very dangerous in a collision or sudden stop since the occupant may slide under the belt and be seriously injured. Seat belts work best only when the occupant is sitting well back and straight up in the seat.
- The shoulder belt should be adequately positioned on your shoulder but should not touch your face, chin or neck. The shoulder belt could harm you in a collision or sudden stop if it is in contact with your face, chin or neck.

WARNING (Continued)

## WARNING (Continued)

- Wear the seat belt as low as possible around the hips, not around the waist. A seat belt running over the waist would press the abdomen with a strong force and could increase the likelihood of injuries in a collision or sudden stop.
- Remove any twists in the seat belt before fastening it. A seat belt with twists will not provide full protection because it cannot disperse shocks efficiently in the event of a collision or sudden stop.
- Be sure to insert the latch plate into the buckle until a click is heard. An incompletely inserted latch plate is dangerous in the event of a collision or sudden stop.
- Too much slack could increase the amount of injury because the belt would not be able to properly restrain you in an accident.
- Never place your child's armpit over the shoulder belt.
- When using the second seat center seat belt, make sure that each latch plate and buckle are securely locked.

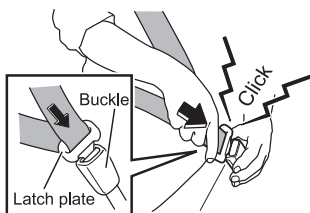
**To Fasten the Three-Point Seat Belts**

1. Sit on the seat in the correct position.
2. Pull out the seat belt holding the latch plate. After checking that there are no twists in the belt, insert the latch plate into the buckle until it clicks.

**ADVICE**

- If you cannot pull out the seat belt, let it go loose, and then slowly pull it out again. If you still cannot pull it out, give the seat belt one strong pull, let it go loose, and then slowly pull it out again.

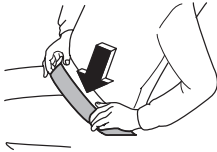

Keep as low on hip bone  
as possible

3. Position the belt across your lap as low on your hips as possible and adjust it to a snug fit by pulling the shoulder portion upward through the latch plate.
4. Adjust the driver's and passenger's shoulder belts for proper position by means of the shoulder anchor.
5. Pull on the belt and confirm that the buckle is fastened.

#### Shoulder Anchor Adjustment

→ Refer to page 3-76

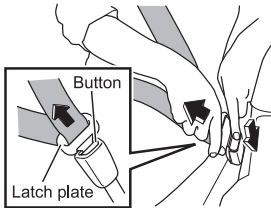

#### To Unfasten the Three-Point Seat Belts

Push the button on the buckle. As the belt automatically retracts, let it be taken up slowly by holding on to the latch plate until the belt is fully retracted.



#### ADVICE

- While being automatically retracted, the seat belt could damage a nearby window or interior trim unless the latch plate is properly held. Hold the latch plate to ensure that the belt is taken up slowly.
- Before closing the door, make sure that the seat belt is fully retracted. (It should not be left unretracted and slack.) A slack belt could become trapped in the door or seat rail.
- If the belt is not fully retracted, pull out the belt again. After that, while holding the tongue with your hand, allow the belt to be retracted slowly until it is fully retracted.

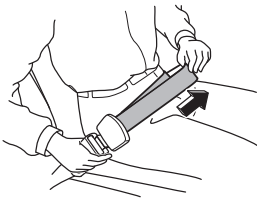
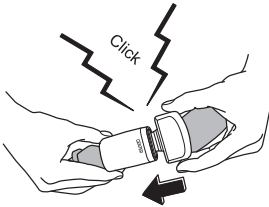
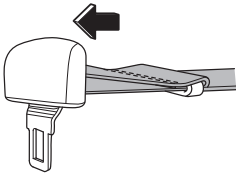

Keep as low on hip bone as possible

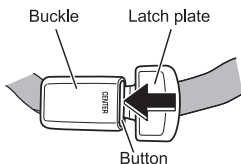

### To Fasten the Two-Point Seat Belts

1. Sit on the seat in the correct position.
2. Pull out the latch plate side of the belt a little longer than necessary.

3. After checking that there are no twists in the belt, insert the latch plate into the buckle until it clicks.

4. Position the seat belt across the lap as low as possible on the hips. Pull the fold-back end of the belt (upper side) until the belt is adjusted to a snug fit.

### To Unfasten the Two-Point Seat Belts

Push the button on the buckle to unfasten the belt.

### Second Seat Center Seat Belt

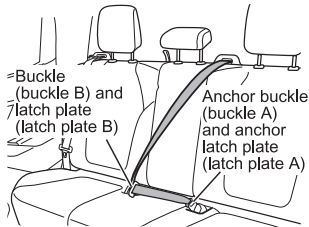

#### WARNING

- When using the second seat center seat belt, make sure that each latch plate and buckle are securely locked.

#### Removing Second Seat Center Seat Belt

#### WARNING

- Do not remove the second seat center seat belt during normal use.
- If latch plate A of the second seat center seat belt is removed, be sure to return the second seat center seat belt to its original state, before driving, by following the procedure for attaching the second seat center seat belt.
- While being automatically retracted, the seat belt could damage a nearby window or interior trim unless the latch plate is properly held. Hold the latch plate to ensure that the belt is taken up slowly.

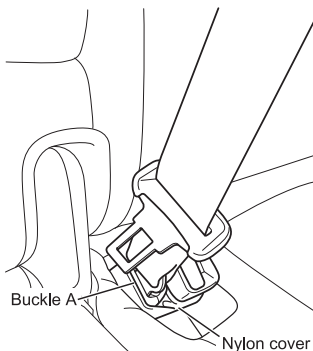

1. Move the nylon cover of buckle A down.

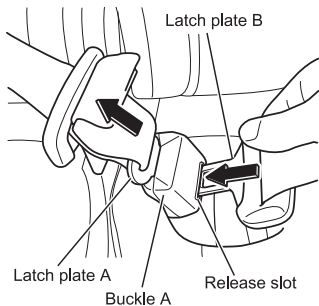

2. Insert latch plate B into the release slot of buckle A.

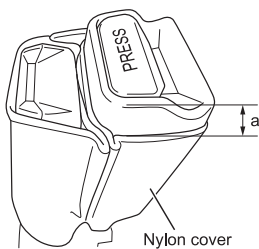

3. Return the nylon cover to its original position.

a: 10 mm (0.39 in)

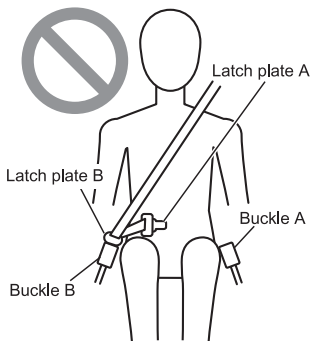

### Attaching Second Seat Center Seat Belt

#### WARNING

- When using the second seat center seat belt, check that latch plate A is properly fixed to buckle A and latch plate B is properly fixed to buckle B. If the seat belt is used in a state where they are not fixed properly, the seat belt may not be sufficiently effective. This may result in serious life-threatening injuries.

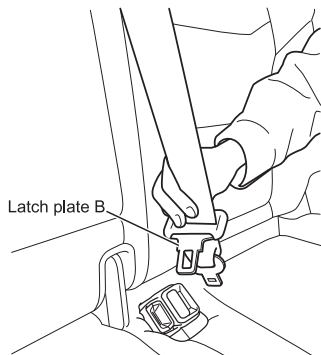

1. Pull out the seat belt so that latch plate B faces the vehicle center. Do not let the seat belt twist as you pull it out.

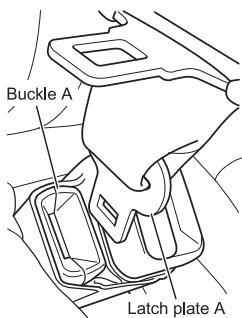

2. Insert latch plate A into buckle A until a clicking sound is heard.

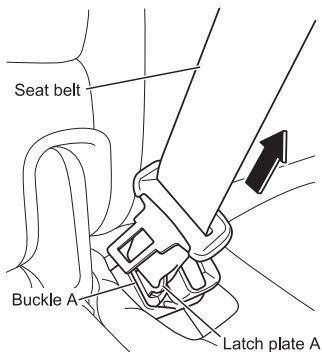

3. Pull the seat belt in the direction of the arrow and check that latch plate A and buckle A are securely fixed.

### Shoulder Anchor Adjustment

Adjust the height of the shoulder anchor on the driver's door side and passenger's door side according to your body size.

#### **WARNING**

- Never adjust the shoulder anchor height while the vehicle is in motion. Doing this is very dangerous.
- The effectiveness of the seat belt will be reduced if it is not properly fastened. The shoulder anchor should be adjusted to a position as high as possible where the belt fits right on the shoulder but does not come in contact with your neck or face.
- After making adjustments, check that the shoulder anchor is completely locked.

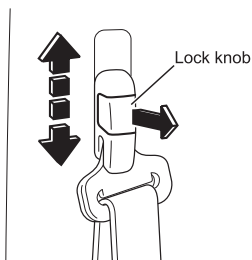

To adjust the anchor height, move the shoulder anchor up or down with the lock knob pulled toward you.

When the desired height is achieved, release the lock knob to lock it.



#### **NOTE**

- The shoulder anchor has 4 adjustment levels.

## Child Restraint System (CRS)

Always restrain children with seat belts or CRS before driving the vehicle. Use a suitable CRS for small children who cannot wear seat belts properly.

### WARNING

- For your child's safety, give priority to the legal requirements and precautions related to CRS.
- Use a CRS that is suitable for the child's age, weight, and body size.
- Use a CRS until the child grows up and is able to wear the seat belt properly.
- Do not use a CRS that has been subjected to strong impact, such as a traffic accident.

## Types of Restraint System

A typical restraint system is shown below.

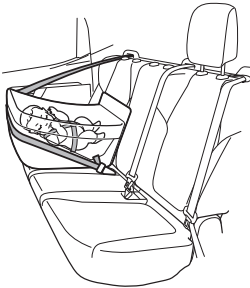

### For Infants

This type of CRS is designed so that in the event of a collision, impact forces will be evenly spread over the baby's back, with minimal jarring to the vulnerable head and neck area.

This complies with groups 0 and 0+ of the UN (ECE) R44 regulation.

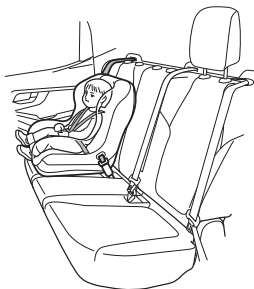

### For Young Children

This type of CRS is designed for use when the child is able to sit and easily hold his or her head upright. It is also possible to purchase convertible seats which can be used as a rearward-facing infant restraint or converted to a forward-facing CRS.

This complies with groups 0+ and I of the UN (ECE) R44 regulation.



Use this type of restraint system when children outgrow a typical forward-facing CRS but they are still too small for lap/shoulder seat belts. A booster seat raises the child so that the knees bend comfortably, the lap/shoulder seat belt is correctly positioned and the child can see out the window. A rigid booster seat with a back, side wings and sash guide gives the best protection. In assessing the range of children who would benefit from booster seats, height is a better indicator than age or weight.

This complies with groups II and III of the UN (ECE) R44 regulation.

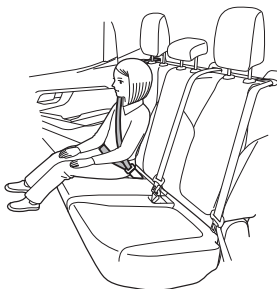

### Older Children

A child should use a normal seat belt without a CRS, only when all of the following conditions are met:

- If not required by legal requirements and precautions.
- He/she can sit against the back of the second seat with knees bent comfortably at the edge of the seat.
- Lap belt rests low and snug across the hips - not across the stomach. Sash belt is centered on shoulder and chest.
- He/she is able to stay seated like this for the entire trip.

**CRS Compatibility for Each Seating Position**

All CRS may not be compatible with all seat positions in the vehicle. When using a CRS, refer to the following pages in advance to check the seat position where the CRS can be installed and to check the compatibility of the CRS with the seat position.

**Standards and Categories of CRS**

→ Refer to page 3-80

**Compatibility of Each Seating Position  
with CRS**

→ Refer to page 3-81

**Recommended CRS and Compatibility  
Table**

→ Refer to page 3-86



Standards and Categories of CRS

Verify the standard and the category of the CRS based on the information on the label attached to the CRS.



NOTE

- The attached mark may differ depending on the product.
- UN (ECE) R44 and UN (ECE) R129 are UNECE regulations for CRS.

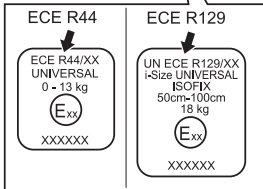

Standards of CRS

Use a CRS that conforms to UN (ECE) R44 or UN (ECE) R129.

Check for an approval mark attached to the CRS. An approval mark is attached to compliant CRS.

- UN (ECE) R44 approval mark:  
Indicates the appropriate weight range for children.
- UN (ECE) R129 approval mark:  
Indicates the appropriate height range and allowable weight for children.

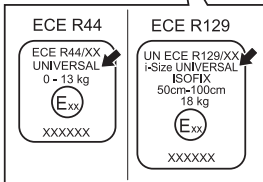







Categories of CRS

Check the approval mark on the CRS to determine which of the following categories applies to that CRS. Also, if there are any uncertainties, check the user's manual included with the CRS or contact the manufacturer of the CRS.

- Universal
- Semi-universal
- Restricted
- Vehicle specific

### Compatibility of Each Seating Position with CRS

The following symbols and seating positions indicate the types of CRS that can be used and the seating positions in which they can be installed.

Symbol	Description
	Suitable for all mass and size groups of universal category CRS fixed with vehicle seat belt.
	Suitable for CRS in "Recommended CRS and Compatibility Table".
	Not suitable for CRS installation.
	Suitable for i-Size and ISOFIX CRS.
	Seat equipped with a top tether anchorage.
	Vehicle without passenger side SRS airbag on-off switch: Never use a rearward-facing CRS. Vehicle with passenger side SRS airbag on-off switch: Never use a rearward-facing CRS when the passenger side SRS airbag on-off switch is "ON" position.
*1	If the seat can be moved back and forth, slide the passenger seat all the way backward.
*2	Raise the seatback so it is fully upright. If there is a gap between the seatback and the CRS, adjust the seat to reduce the gap.
*3	Before installing the CRS, remove the headrest. When using only a booster cushion, put it in the use position without removing the headrest.
*4	Vehicle without passenger side SRS airbag on-off switch: Use only a forward-facing CRS. Vehicle with passenger side SRS airbag on-off switch: Use only a forward-facing CRS when the passenger side SRS airbag on-off switch is "ON" position.
*5	Not suitable for the CRS with a support leg.

**Recommended CRS and Compatibility Table** → Refer to page 3-86  
**Passenger Side SRS Airbag On-Off Switch** → Refer to page 3-117

## Right-hand Drive Models

Vehicle model	Seat type	
	Bucket seat	Bench seat
Regular cab model		
Extended cab model		
Crew cab model		

Seating position	Description
①	U L  *1, *2, *3, *4
②	U L   *3
③	U L *3, *5
④	U L   *3

**Left-hand Drive Models**

Vehicle model	Seat type	
	Bucket seat	Bench seat
Regular cab model		
Extended cab model		
Crew cab model		

Seating position	Description
①	U L  *1, *2, *3, *4
②	U L   *3
③	U L *3, *5
④	U L   *3

## Detail Information for CRS Installation

## Regular Cab/Extended Cab Models

Seating position	Vehicle without passenger side SRS airbag on-off switch	①	
		Vehicle with passenger side SRS airbag on-off switch	
		Passenger side SRS airbag on-off switch	
		ON	OFF
Seating position suitable for universal belted (Yes/No) *1	Yes Forward-facing only	Yes Forward-facing only	Yes
i-Size seating position (Yes/No)	No	No	No
Seating position suitable for lateral fixture (L1/L2/No)	No	No	No
Suitable rearward-facing fixture (R1/R2X/R2/R3/No)	No	No	No
Suitable forward-facing fixture (F2X/F2/F3/No)	No	No	No
Suitable junior seat fixture (B2/B3/No)	No	No	No

\*1: Suitable for all mass and size groups in universal category.

## Crew Cab Model

Seating position	①			②, ④	③
	Vehicle without passenger side SRS airbag on-off switch	Vehicle with passenger side SRS airbag on-off switch			
		Passenger side SRS airbag on-off switch			
		ON	OFF		
Seating position suitable for universal belted (Yes/No) *1	Yes Forward-facing only	Yes Forward-facing only	Yes	Yes	Yes *2
i-Size seating position (Yes/No)	No	No	No	Yes	No
Seating position suitable for lateral fixture (L1/L2/No)	No	No	No	No	No
Suitable rearward-facing fixture (R1/R2X/R2/R3/No)	No	No	No	R1/R2X/R2/R3	No
Suitable forward-facing fixture (F2X/F2/F3/No)	No	No	No	F2X/F2/F3	No
Suitable junior seat fixture (B2/B3/No)	No	No	No	B2/B3	No

\*1: Suitable for all mass and size groups in universal category.

\*2: Not suitable for the CRS with a support leg.

ISOFIX CRS are divided according to their different fixtures. The CRS can be used in the seating positions for the fixtures mentioned above.

For the types of fixtures, refer to the following table. If the type of fixture on your CRS is not listed (or if the information you need is not in the table), please refer to the user's manual included with the CRS or contact the manufacturer of the CRS.

Fixture type	Description
F3	Full-height forward-facing toddler CRS
F2	Reduced-height forward-facing toddler CRS
F2X	Reduced-height forward-facing toddler CRS
R3	Full-size rearward-facing toddler CRS
R2	Reduced-size rearward-facing toddler CRS
R2X	Reduced-size rearward-facing toddler CRS
R1	Rearward-facing infant CRS
L1	Left lateral facing position CRS (carry-cot)
L2	Right lateral facing position CRS (carry-cot)
B2	Junior seat
B3	Junior seat

### Recommended CRS and Compatibility Table

**For ASEAN (Singapore, Malaysia, Thailand, Indonesia, Philippines, Vietnam, Laos, Cambodia, Myanmar)**

Mass group		Recommended CRS	Seating position		
			①	②, ④	③
0+	Up to 13 kg / 28.7 lb	Britax BABY-SAFE Plus ISOFIX BASE (Yes/No)	No	Yes	No
I	9 to 18 kg / 19.8 to 39.7 lb	Maxi-Cosi 2way Pearl & 2way Fix (Yes/No)	No	Yes	No

**For EU**

**[When using an ISOFIX lower anchorage]**

Mass group		Recommended CRS	Seating position			
			①		②, ④	③
			Passenger side SRS airbag on-off switch			
			ON	OFF		
0+	Up to 13 kg / 28.7 lb	BeSafe iZi Combi X4 ISOfix (Yes/No)	No	No	Yes	No
I	9 to 18 kg / 19.8 to 39.7 lb	BeSafe iZi Combi X4 ISOfix (Yes/No)	No	No	Yes	No
II	15 to 25 kg / 33.1 to 55.1 lb	Römer KIDFIX XP *1 Römer KIDFIX <sup>2</sup> R *1 *2 (Yes/No)	No	No	Yes	No
III	22 to 36 kg / 48.5 to 79.4 lb	Römer KIDFIX XP *1 Römer KIDFIX <sup>2</sup> R *1 *2 (Yes/No)	No	No	Yes	No

\*1: Belted with ISOFIX attachment.

\*2: Use the lap belt guide. Refer to the owner's manual of the CRS for details.

**[When using only a seatbelt]**

Mass group		Recommended CRS	Seating position			
			①		②, ④	③
			Passenger side SRS airbag on-off switch			
			ON	OFF		
0+	Up to 13kg / 28.7lb	Maxi-Cosi CabrioFix (Yes/No)	No	Yes	Yes	Yes
I	9 to 18kg / 19.8 to 39.7lb	Römer KING II (Yes/No)	Yes	Yes	Yes	Yes
II	15 to 25kg / 33.1 to 55.1lb	Römer KIDFIX XP Römer KIDFIX R *1 (Yes/No)	Yes	Yes	Yes	Yes
III	22 to 36kg / 48.5 to 79.4lb	Römer KIDFIX XP Römer KIDFIX R *1 Graco Junior (Yes/No)	Yes	Yes	Yes	Yes

\*1: Use the lap belt guide. Refer to the owner's manual of the CRS for details.

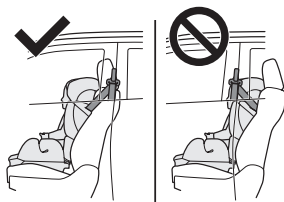
**⚠ WARNING**

[For front bucket seat models]

- When the front seat belt shoulder anchor is in front of the CRS belt guide, move the front passenger seat forward.

[For crew cab models]

- When installing a CRS in the second seat, adjust the front seat so that it does not interfere with the child or CRS.
- If the CRS cannot be installed properly due to interference by the driver's seat, install it to the second seat on the side behind the front passenger seat. Also, adjust the front passenger seat so that it does not interfere with the CRS.
- With some types of CRSs, it may not be possible to properly fasten your seat belt in a position next to a CRS because the CRS interferes with your body or the seat belt, which may reduce your seat belt's effectiveness. In this case, move the different position. When using a seat in a position next to a CRS, be sure your seat belt fits snugly across your shoulder and low on your hips. Failure to do so may result in serious injury or, in the worst case, death.
- Installing two CRSs at the same time in adjacent second seats may not be possible. In this case, install the CRSs in seats that are not adjacent.

## Lower and Top Tether Anchorages for ISOFIX CRS (Crew Cab Model)

The second outboard seats are equipped with anchorages for securing the ISOFIX CRS.

### WARNING

- Child restraint anchorages are designed to withstand only those loads imposed by correctly fitted child restraints. Under no circumstances are they to be used for adult seat belts, harnesses or for attaching other items or equipment to the vehicle.

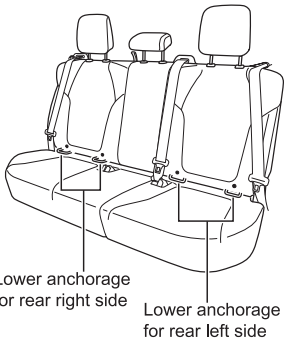

### Lower Anchorages

CRS lower anchorages are located to the second outboard seats.

### NOTE

- To assist you in locating the lower anchorages for CRS, each seating position with the anchorage has a button on the seatback at each lower anchorage location.

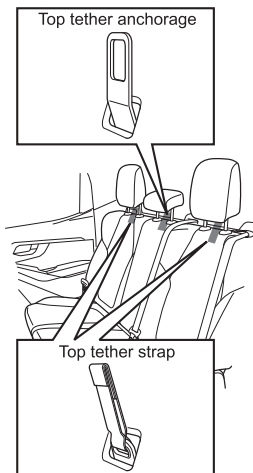

### Top Tether Anchorages

The strap and anchorage to secure the top tether belt of the CRS are located behind the second seats.



#### CAUTION

- Do not attach the top tether hook directly through the anchorage.
- The top tether strap and anchorage are for installing the CRS. Do not hook other things on them.
- Do not install the CRS to the center seat.



#### NOTE

- When the strap is hidden behind the seatback, pull it out.

### Folding the Seatback

→ Refer to page 3-58

### Installing a CRS

For crew cab models, we recommend installing the CRS on the second seat.

Before you install a CRS on the front passenger seat, raise the seatback so it is fully upright and slide the passenger seat all the way backward. At this time, if there is a gap between the seatback and the CRS, adjust the front passenger seat to reduce the gap. Also, if you install a rearward-facing CRS on the front passenger seat, always place the passenger side SRS airbag on-off switch in the "OFF" position (models with passenger side SRS airbag on-off switch).

**Passenger Side SRS Airbag On-Off Switch** → Refer to page 3-117

#### **WARNING**

- Carefully follow the instructions in the CRS manufacturer's instruction manual to install the CRS.
- The seat belt cannot protect your child from death or serious injuries when it is defective. Immediately contact your Isuzu Dealer and repair the seat belt that does not function normally. Never use the CRS with the defective seat belt until it is fixed.
- Make sure that installation is performed in compliance with all installation instructions provided by the CRS manufacturer and make sure that the system is secured properly. Improper installation may result in death or serious injuries to the child in event of sudden stopping or accidents.
- When CRS is not in use, make sure that the CRS is properly secured to the seat when it is not in use. Do not simply place a CRS on the seat without it being secured to the seat.
- Never use a rearward-facing CRS on a seat protected by an active airbag in front of it, death or serious injury to the child can occur.

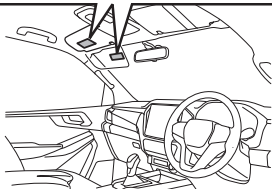

#### **NOTE**

- The label on the passenger side sun visor shows warning pictograms. Details of the label are shown in the figure.

**Installation Procedure**

CRS with ISOFIX top tether anchorage

Procedure No. 1) 5)

CRS without ISOFIX top tether anchorage

Procedure No. 1) 2)

**⚠ WARNING**

- When using an ISOFIX lower anchorage/ISOFIX top tether anchorage, check whether your i-Size/ISOFIX CRS is a product that has received UN (ECE) R44 or UN (ECE) R129 certification.
- When using the CRS with the top tether belt, be sure to fix a top tether belt to the top tether anchorage.
- Before installing the CRS, remove the headrest. When using only a booster cushion, put it in the use position without removing the headrest.
- When using the ISOFIX lower anchorage, make sure that there are no obstructions in the surrounding area and that the seat belt is not trapped.
- Do not adjust the seat after you have fixed the CRS.

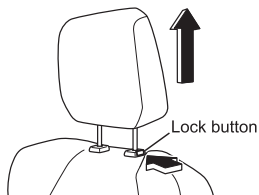

1. Remove the headrest.

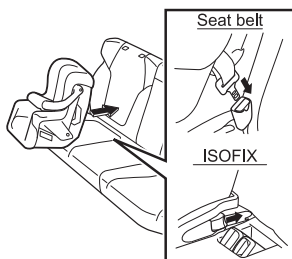

2. Attach the CRS by using the seat belt or the ISOFIX anchorages. Refer to the instruction manual of the CRS.

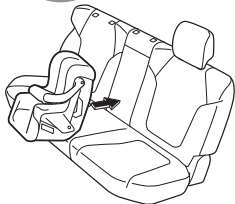
**CAUTION**

- Do not install the CRS except for the universal belted CRS to the center seat.

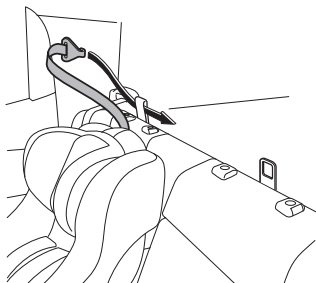

3. Pass the top tether belt from the outboard side through the strap toward the inboard side.

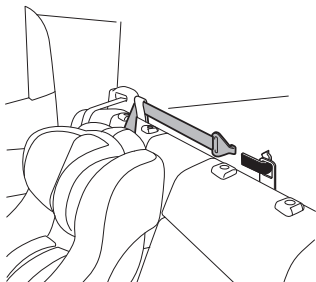

4. Attach the hook to the anchorage behind the center seat.
5. Adjust the length of the top tether belt until the CRS is tightly attached to the seat.

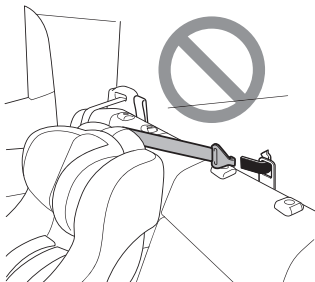
**CAUTION**

- Do not attach the top tether hook directly through the anchorage.
- The top tether strap and anchorage are for installing the CRS. Do not hook other things on them.

**Removal Procedure**

CRS with ISOFIX top tether anchorage
--------------------------------------

Procedure No. 1) 4)
---------------------

CRS without ISOFIX top tether anchorage
---

Procedure No. 3) 4)
---------------------

**WARNING**

- After removing the CRS, be sure to reattach the headrest.

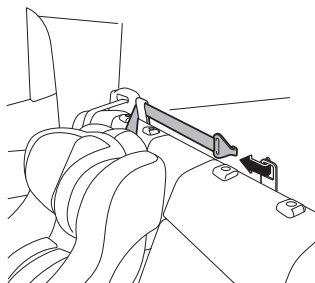

1. Loosen the top tether belt.
2. Remove the hook from the anchorage behind the center seat and pull out the top tether belt.

Seat belt



ISOFIX

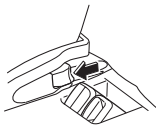

3. Unfasten the seat belt or the ISOFIX anchorages to remove the CRS.

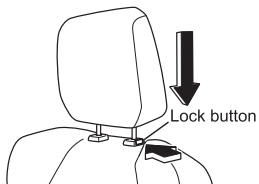

4. Install the headrest.



### Seat Belt with Pretensioner and SRS Airbag System

The seat belt with pretensioner and the supplemental restraint system (SRS) airbag system operate when the vehicle is subjected to an impact exceeding a certain level when a collision occurs.

Be sure to observe the following instructions to prevent you and your passenger from suffering a serious or fatal injury due to impacts resulting from the seat belt with pretensioner and airbag operation.

#### WARNING

- The SRS airbag system is most effective when used together with a seat belt with pretensioner.
- The seat belt with pretensioner and SRS airbag system may not work, depending on the situation at the time of collision. Refer to "When and How the Seat Belt with Pretensioner and SRS Airbag System Operates" for details.

**When and How the Seat Belt with Pretensioner and SRS Airbag System Operates** → Refer to page 3-104

### Operation Check

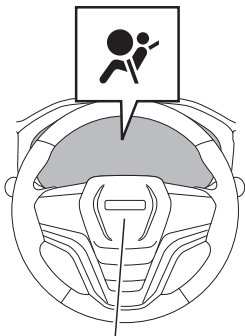

Airbag assembly for driver seat

The SRS airbag warning light checks and alerts the conditions of the SRS airbag system.

This warning light comes on when the power mode is switched to "ON" (models with passive entry and start system) or the starter switch is turned to the "ON" position (models without passive entry and start system), and then goes out after approximately 6 seconds.

If this warning light stays on, the airbag(s) may not function properly when needed. Drive the vehicle after the warning light goes out.

 **WARNING**

- If you encounter any of the following conditions, system errors have occurred. Have your vehicle inspected/serviced at your Isuzu Dealer as soon as possible.
  - If the SRS airbag warning light does not come on when the power mode is switched to "ON" (models with passive entry and start system) or when the starter switch is turned to the "ON" position (models without passive entry and start system).
  - If the SRS airbag warning light does not go out.
  - If the SRS airbag warning light comes on while driving the vehicle.
- If you make unauthorized modifications to the vehicle or install an unauthorized accessory, the seat belt with pretensioner and airbag may not operate correctly.
- If the steering wheel is changed to a non-standard one or a sticker is attached to the steering wheel pad, there could be a danger of system malfunction or the sticker flying off in the event of system activation. Attaching stickers or placing such things as accessories or air fresheners on the top surface of the instrument panel is also dangerous. They may prevent normal operation of the airbag or could fly off in the event of system activation.
- In models with side airbag or far side airbag, do not attach seat covers under any circumstances. If a seat cover is attached or objects are placed in the area in which the side airbag or far side airbag inflate, the airbags will not function correctly. Also, there could be a danger of objects flying off in the event of the system activation.
- In models with curtain airbag, if hard objects such as hangers or accessories are attached to the grip or coat hook, they may prevent normal operation of the curtain airbag and could fly off in the event of system activation.
- Do not apply excessive force to nor strongly hit the airbag installation area, or the base of the b-pillar. Doing so may result in erroneous activation of the airbag or the seat belt with pretensioner.

WARNING (Continued)

**WARNING (Continued)**

- Doing any of the following may require special precautions. Be sure to consult your Isuzu Dealer before doing any of the following. Failure to do so may cause the seat belt with pretensioner and airbag to be unduly activated, causing the seat belt to be unexpectedly retracted or the airbag to be suddenly inflated, causing an injury to the occupant. Doing any of them improperly will adversely affect the operation of the system, causing a malfunction or failure.
  - Repair or replacement of the steering wheel, instrument panel, center console, parts around the accelerator pedal, front seat, parts around the roof side, or parts around the base of the b-pillar.
  - Repair, replacement or disposal of the seat belt with pretensioner and airbag, or scrapping of a model that has seat belt with pretensioner and airbag.
  - When audio equipment and accessories are installed or modification such as body mounting is carried out.
  - Making modifications to the front of the vehicle (bumper, frame, etc.), installing equipment (snow plows, etc.), making modifications to the frame, or making changes to the vehicle's height using unauthorized methods and/or materials.
  - Repairing or painting of panels at the front of the vehicle or panels on the cab.

**CAUTION**

- Have your vehicle inspected at the nearest Isuzu Dealer promptly if you encounter any of the following conditions.
  - The SRS airbag warning light shows an abnormality.
  - The seat belt with pretensioner and airbag are activated by an impact. (The SRS airbag warning light comes on.)
  - Your vehicle has received a certain level of frontal impact, or lateral impact, even when the impact has not activated the seat belt with pretensioner and airbag.
  - The seat belt is frayed or worn out.
  - The steering pad surface and instrument panel surface is cracked or otherwise damaged, or it receives an impact.
  - When the surface of the airbag installation area is cracked or otherwise damaged, or it receives an impact.

**SRS Airbag Warning Light**

→ Refer to page 4-64

### Seat Belt with Pretensioner

When the vehicle receives an impact exceeding a certain level during a frontal collision or lateral collision, the fastened seat belt is retracted instantly and the slack in the seat belt gets taut, thus enhancing the seat belt's restraining effect.

**Seat Belts → Refer to page 3-67**

#### Front Seat Belts with Pretensioners

These operate to restrain the body of the driver and passenger to their seats.

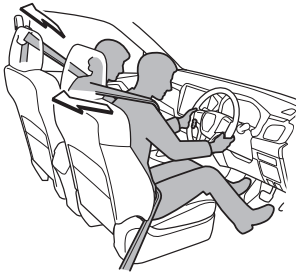

#### **WARNING**

- The seat belt with pretensioner helps reduce the risk of a serious injury to the driver and the passenger should the vehicle receive a frontal impact, or lateral impact, exceeding a certain level. The maximum effect is achieved only if the seat belt is correctly worn.
- The seat belt with pretensioner takes up the slack in the seat belt instantly to help reduce the risk of a serious injury. If the seat belt with pretensioner activates, you may suffer scratches or a slight bruise or burn due to heat generated by rubbing.

#### **CAUTION**

- Do not remove or disassemble the seat belt. Accidental activation of the system may cause parts to fly off, causing an injury to you; or causing malfunction.

#### **ADVICE**

- Once activated during a collision, the seat belt with pretensioner cannot be reused. The seat belt must be replaced immediately at the nearest Isuzu Dealer.

**NOTE**

- Even if the pretensioner function fails, the seat belt still operate as a regular seat belt (with ELR) and the seat belt function is ensured.
- The pretensioner generates a sound at the moment it retracts the seat belt.
- When the seat belt with pretensioner and airbag system are activated by an impact, the SRS airbag warning light comes on.

**Seat Belts → Refer to page 3-67**

## Supplemental Restraint System (SRS) Airbag

When the vehicle receives an impact exceeding a certain level during a frontal collision or lateral collision, the airbags activate. They help to disperse and reduce the impact on the body of the driver and the passenger as a supplement to the front seat belt with pretensioner.

### Frontal Airbags

These operate mainly when the conditions are met at the time of a frontal collision.

- Front airbags (if equipped):  
These operate to reduce the impact on the driver's and front passenger's heads.
- Knee airbag (if equipped):  
This operates to reduce the impact on the driver's legs.

### Lateral Airbags

These operate mainly when the conditions are met at the time of a lateral collision.

- Side airbags (if equipped):  
These operate to reduce the impact on the driver's and front passenger's chests.
- Curtain airbags (if equipped):  
These operate to reduce the impact on the driver's and front passenger's heads. For vehicles with second seats, they operate to reduce the impact on the heads of the passengers in the outboard seats.
- Far side airbag (if equipped):  
This operates to prevent the driver and the front passenger from colliding.

## Deployment of SRS airbag

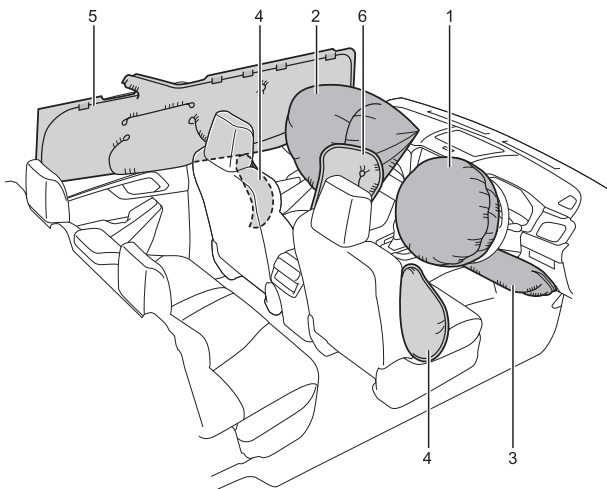

No.	Description
1	Front airbag (driver's side) (if equipped)
2	Front airbag (passenger's side) (if equipped)
3	Knee airbag (driver's side) (if equipped)
4	Side airbag (if equipped)
5	Curtain airbag (if equipped)
6	Far side airbag (if equipped)

 **WARNING**

- The SRS airbag system is most effective when used together with a seat belt with pretensioner.
- The airbags do not replace the seat belt. Be sure to wear the seat belt.
- The airbags are inflated instantaneously with considerable force to reduce serious injury. If the airbags inflate, you may suffer scratches or a slight bruise or burn due to heat generated by rubbing.
- When the vehicle receives an impact exceeding a certain level, resulting in the deployment of the airbags, deformation of the vehicle may cause the windshield to break.
- The operation of the front airbags may cause damage to the windshield.
- The airbags cannot be reused once they are inflated. Immediately replace them at the nearest Isuzu Dealer.

 **ADVICE**

- When the airbags are inflated, sounds and white smoke are produced, but this is not the result of a fire. This white smoke is not detrimental to your health. However, if residue (gas and so on) adheres to your eyes and skin, rinse them with water as soon as possible. Although it is rare, a person with delicate skin may suffer from irritation.
- Immediately after the airbags are inflated, the metal portion that inflates the airbags gets hot. Do not touch it.

 **NOTE**

- The front airbags are quickly deflated after deployment and do not hinder visibility.
- When the seat belt with pretensioner and airbags operate due to an impact, the SRS airbag warning light comes on.
- The lateral airbags operate independently from the frontal airbags. When the lateral airbags operate, the seat belt with the pretensioner also operates at the same time.

### When and How the Seat Belt with Pretensioner and SRS Airbag System Operates

The seat belt with pretensioner and airbag system are activated when the vehicle receives an impact exceeding a certain level in the event of a frontal collision, or lateral collision. Because the vehicle body absorbs part of impact energy, the system may not be activated due to reduction in the force of the impact or the intensity or direction of the impact received. However, even if the front of the vehicle is largely deformed by the collision, in some cases the impact on the seat is not severe. Therefore, the severity of deformation of and damage to the vehicle do not necessarily coincide with the activation of the airbag.

#### When Are the Seat Belt with Pretensioner and Frontal Airbags Activated?

When the vehicle collides head-on against a parked/stopped vehicle or a moving vehicle with an impact of a certain level or higher



When the vehicle collides head-on against a solid wall with an impact of a certain level or higher



#### WARNING

- Immediately after the frontal airbags are inflated, the metal portion that inflates the airbags gets hot. Do not touch it. Doing so may cause a serious injury such as a burn.

#### NOTE

- The passenger side front airbag may activate even if a passenger is not present.

When the vehicle is hit from the side with an impact of a certain level or higher

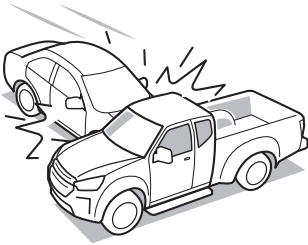

When Are the Seat Belt with Pretensioner and Lateral Airbags Activated?

**WARNING**

- Immediately after the lateral airbags are inflated, the metal portion that inflates the airbags gets hot. Do not touch it. Doing so may cause a serious injury such as a burn.

**NOTE**

- The passenger side lateral airbags may activate even if a passenger is not present.
- If the vehicle has an offset collision (one-sided collision), the lateral airbags may activate.

**When Are the Seat Belt with Pretensioner and Frontal Airbags Not Likely to Be Activated?**

In the following cases, the seat belt with pretensioner and frontal airbags are less likely to be activated even if they are working properly.

**When the vehicle collides against a utility pole or standing tree**

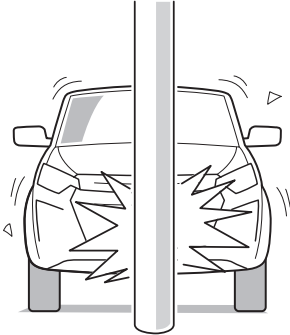

**When the vehicle gets under a vehicle or obstacle**

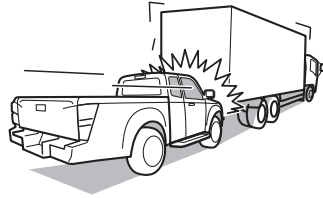

**When the vehicle has an offset collision (one-sided collision)**

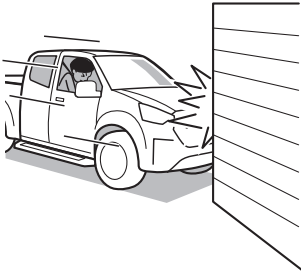

**When the vehicle has a frontal angle collision**

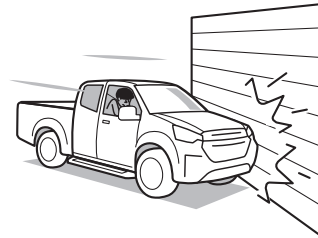

**When Are the Seat Belt with Pretensioner and Lateral Airbags Not Likely to Be Activated?**

In the following cases, the seat belt with pretensioner and lateral airbags are less likely to be activated even if they are working properly.

**When the vehicle collides against a utility pole or standing tree from the side**

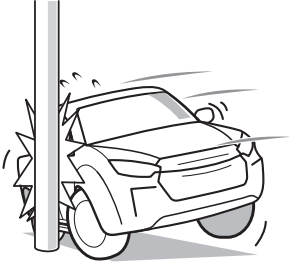

**When the vehicle is hit at the engine compartment or cargo bed from the side**

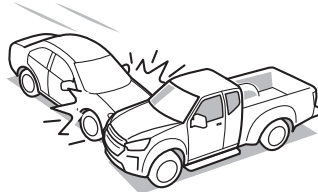

**When the vehicle is hit to the side from a frontal angle**



**When the vehicle has a frontal angle collision**

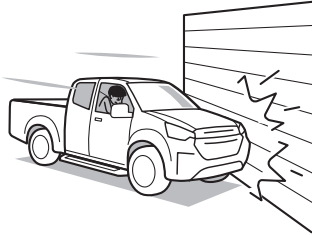



### When Are the Seat Belt with Pretensioner and Frontal Airbags Activated Other than in a Collision?

- When the vehicle falls into a pothole or groove in the road
- When the vehicle strongly collides against an obstacle such as a protruding object on the road
- When the vehicle collides against a curb at high speed
- When the vehicle becomes airborne and hits the ground, receiving a strong impact on the bottom of the vehicle

#### WARNING

- Immediately after the frontal airbags are inflated, the metal portion that inflates the airbags gets hot. Do not touch it. Doing so may cause a serious injury such as a burn.

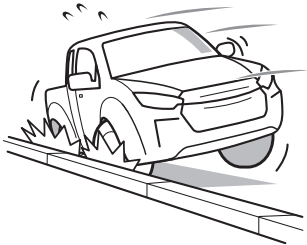

### When Are the Seat Belt with Pretensioner and Lateral Airbags Activated Other than in a Collision?

- When the vehicle skids and collides against a curb

#### WARNING

- Immediately after the lateral airbags are inflated, the metal portion that inflates the airbags gets hot. Do not touch it. Doing so may cause a serious injury such as a burn.

**When Are the Seat Belt with Pretensioner and Frontal Airbags Not Activated?**

In the following cases, the seat belt with pretensioner and frontal airbags are not activated even if they are working properly.

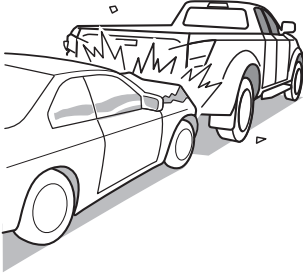
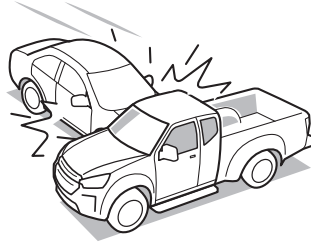
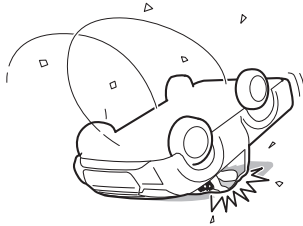
**When the vehicle is hit from the rear****When the vehicle is hit from the side****When the vehicle rolls onto its side or upside down**

**When Are the Seat Belt with Pretensioner and Lateral Airbags Not Activated?**

In the following cases, the seat belt with pretensioner and lateral airbags are not activated even if they are working properly.

**When the vehicle collides head-on against a parked/stopped vehicle or a moving vehicle with an impact of a certain level or higher**



**When the vehicle is hit from the rear**

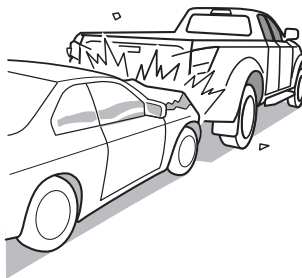

**When the vehicle rolls onto its side or upside down**

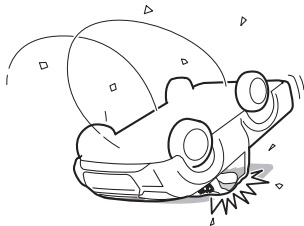

 **WARNING**

- Repainting of the cab panels, repair around the side panel, steering wheel, instrument panel, center console, roof side, and the front seat, installation of accessories such as audio equipment and repair around the dashboard may adversely affect the SRS airbag system or cause a fatal or serious injury due to the impact of the airbag when it unexpectedly inflates. Never make these repairs by yourself, but be sure to consult your Isuzu Dealer.
- If you make modifications to the front of the vehicle (bumper, frame, etc.), install equipment (snow plow, for example), make modifications to the frame, or make a change to the vehicle's height using unauthorized methods and/or materials, the SRS airbag system may fail to operate normally. Be sure to consult your Isuzu Dealer.
- Special treatment is required when an airbag is disposed of. When discarding a vehicle equipped with an SRS airbag system, consult your Isuzu Dealer.

 **CAUTION**

- Have your vehicle inspected at the nearest Isuzu Dealer at once in the following cases.
  - When the SRS airbag warning light does not go out or comes on during driving.
  - When the airbag is inflated.
  - When the frontal airbags were not inflated although the vehicle received a certain level of impact at the front.
  - When the lateral airbags were not inflated although the vehicle received a certain level of impact at the side.
  - When the steering pad surface or instrument panel surface is cracked or otherwise damaged or it receives an impact.
  - When the surface of the airbag installation area is cracked or otherwise damaged, or it receives an impact.

**NOTE**

- When the airbags are inflated, gases like white smoke are produced but this is not a fire. This white smoke is not detrimental to your health. However, if residue (gas and so on) adheres to your eyes and skin, rinse them with water as soon as possible. Although it is rare, a person with delicate skin may suffer from irritation.
- The airbags cannot be reused once it is inflated. Replace it at your Isuzu Dealer.

**When Does an SRS Airbag System Develop Its Full Effect?****WARNING**

- Before driving the vehicle, properly adjust your seat for proper driving position and wear the seat belt correctly. Do not sit closer than necessary to the steering wheel and do not lean over it. (Leave a space of 25 cm (10 in) or more between your chest and the center of the steering wheel.) Do not allow the passenger to put his/her hands or feet on the instrument panel and to sit with his/her face or chest close to it. When the airbags are activated, you or the passenger may suffer a burn on or serious injury to the arm or face.
- Do not lean against the door and roof side. When the side airbag and curtain airbags are activated, you may suffer a burn on or serious injury to the arm or face.
- In models with side airbag and curtain airbag, do not lean against the door and roof side. When the airbags are activated, you may suffer a burn on or serious injury to the arm or face.

WARNING (Continued)



Sticker

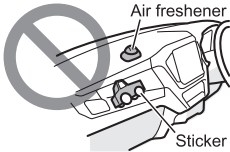

Air freshener

Sticker

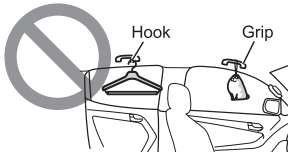

Hook

Grip

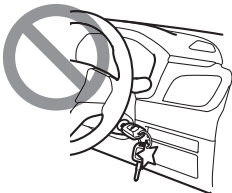
**WARNING (Continued)**

- If the steering wheel is changed to a non-standard one or a sticker is attached to the steering wheel pad, there could be a danger of system malfunction or the sticker flying off in the event of system activation. Attaching stickers or placing such things as accessories or air fresheners on the dashboard or around the instrument panel is also dangerous. They may prevent normal operation of the airbag or could fly off in the event of system activation.
- In models with the side airbag or the far side airbag, do not attach seat covers under any circumstances. If a seat cover is attached or objects are placed in the area in which the side airbag or far side airbag inflate, the airbags will not function correctly. Also, there could be a danger of objects flying off in the event of the system activation.
- In models with the curtain airbag, if hard objects such as hangers or accessories are attached to the grip or coat hook, they may prevent normal operation of the curtain airbag and could fly off in the event of system activation.
- In models with the knee airbag, except for models with passive entry and start system, do not attach any heavy or sharp objects to the key. Doing so is dangerous because they may prevent the knee airbag from operating normally or fly off when the airbag activates.

**When Carrying a Child in the Vehicle****WARNING**

- Be sure to observe the following precautions when carrying a child in the vehicle. Otherwise the child may be fatally injured by the impact from an inflating airbag.
  - Do not drive with a child standing in front of any of the airbags, or sitting on your lap. Doing so is dangerous because the child would receive a very strong impact by an inflating airbag.
  - Never use a rearward-facing CRS on a seat protected by an active airbag in front of it, death or serious injury to the child can occur. The label on the passenger side sun visor shows warning pictograms.
- For crew cab models, we recommend placing children on the second seat.

**Passenger Side SRS Airbag On-Off  
Switch** → Refer to page 3-117

## Handling of SRS Airbag System

 **WARNING**

- Do not remove or disassemble the airbag. Doing so may cause a malfunction or inadvertent activation.
- Do not place anything near the airbag. You may suffer an injury when an object is thrown by the inflation force of the airbag.
- Do not take a rest using the steering wheel as a pillow or with your arms or legs resting on it. If the vehicle is stopped with the power mode in "ON" (models with passive entry and start system) or the starter switch in the "ON" position (models without passive entry and start system) and an impact exceeding a certain level occurs to the front of the vehicle, the airbag will inflate and may injure you due to the strong impact.
- Do not drive the vehicle with something placed between you and airbag or held on your lap. If the airbag inflates, the objects may be thrown and hit your face. Doing so also hinders normal activation of the airbag, which is dangerous.
- Do not wet the airbag sensor with water or subject it to an impact. The system may malfunction; this is very dangerous.



### Passenger Side SRS Airbag On-Off Switch

Using the passenger side SRS airbag on-off switch can disable the passenger side front SRS airbag and the side SRS airbag (models with side airbag). The passenger side SRS airbag on-off switch should only be placed in the "OFF" position when a rearward-facing CRS is used on the front passenger seat.

#### WARNING

- Do not unnecessarily place the passenger side SRS airbag on-off switch in the "OFF" position. Make sure that the passenger side SRS airbag on-off switch is always placed in the "ON" position, except when a rearward-facing CRS is used on the front passenger seat.
- When the passenger side SRS airbag on-off switch is in the "ON" position, never use a rearward-facing CRS on the front passenger seat. Death or serious injury to the child can be caused by an impact occurring at the time of the passenger airbag deployment.
- When the passenger side SRS airbag on-off switch is in the "OFF" position, do not allow passengers to sit on the front passenger seat. Otherwise, the passenger will not be adequately protected in the event of a frontal collision, or lateral collision (in models with side airbag) and death or serious injury can occur.

#### NOTE

- Even when the passenger side SRS airbag on-off switch is in the "OFF" position, the pretensioner function of the passenger seat belt operates.

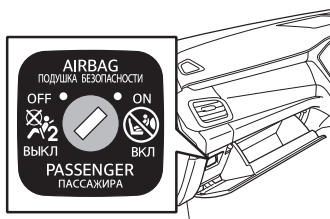

The passenger side SRS airbag on-off switch is positioned below the instrument panel on the passenger side. Open the glove compartment to check the switch. Always ensure that the passenger side SRS airbag on-off switch is in the proper position before driving.

### Passenger Side SRS Airbag ON Indicator Light/ Passenger Side SRS Airbag OFF Indicator Light

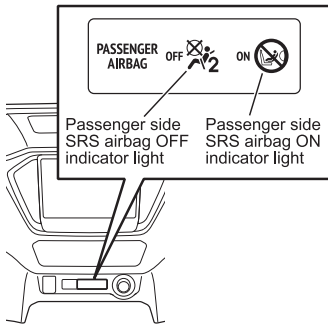

**Passenger side SRS airbag ON  
indicator light**





**Passenger side SRS airbag OFF  
indicator light**



The passenger side SRS airbag ON indicator light and the passenger side SRS airbag OFF indicator light are positioned below the center of the instrument panel. When the power mode is switched to "ON" (models with passive entry and start system) or when the starter switch is turned to the "ON" position (models without passive entry and start system), both the passenger side SRS airbag ON indicator light and the passenger side SRS airbag OFF indicator light come on. The indicator lights are on for approximately 4 seconds, and then go out. Approximately 2 seconds after they go out, one of the indicator lights comes on depending on the position of the passenger side SRS airbag on-off switch.

The status of the passenger side SRS airbag shown in the following table can be checked by looking at which indicator light comes on.

If the passenger side SRS airbag ON indicator light or the passenger side SRS airbag OFF indicator light does not operate properly, immediately contact the nearest Isuzu Dealer.

Indicator light that comes on	Status of the passenger side SRS airbag	Position of the passenger side SRS airbag on-off switch
Passenger side SRS airbag ON indicator light	Enabled	"ON" position 
Passenger side SRS airbag OFF indicator light	Disabled	"OFF" position 

### To Disable the Passenger Side SRS Airbag



#### NOTE

- Operate the switch when the power mode is "OFF" (models with passive entry and start system) or the starter switch is in the "LOCK" position (models without passive entry and start system).



1. Insert the key into the passenger side SRS airbag on-off switch and turn it to the "OFF" position.



#### NOTE

- In models with a passive entry and start system, use the mechanical key stored in the electronic key.

2. Leave it in the "OFF" position and remove the key.



#### NOTE

- If the key is left inserted, the switch returns to the "ON" position.

#### Passenger side SRS airbag OFF indicator light



3. When the power mode is switched to "ON" (models with passive entry and start system) or the starter switch is turned to the "ON" position (models without passive entry and start system), ensure that the passenger side SRS airbag OFF indicator light comes on. While the switch is in the "OFF" position, the passenger side SRS airbag OFF indicator light stays lit.

**To Enable the Passenger Side SRS Airbag****NOTE**

- Operate the switch when the power mode is "OFF" (models with passive entry and start system) or the starter switch is in the "LOCK" position (models without passive entry and start system).

**Passenger side SRS airbag ON indicator light**

1. Insert the key into the passenger side SRS airbag on-off switch and turn it to the "ON" position.

**NOTE**

- In models with a passive entry and start system, use the mechanical key stored in the electronic key.
2. Leave it in the "ON" position and remove the key.
  3. When the power mode is switched to "ON" (models with passive entry and start system) or the starter switch is turned to the "ON" position (models without passive entry and start system), ensure that the passenger side SRS airbag ON indicator light comes on. While the switch is in the "ON" position, the passenger side SRS airbag ON indicator light stays lit.

### Remote Engine Start System

The remote engine start system is a system to start the engine from outside the vehicle. Operating the electronic key can start the engine remotely.

#### WARNING

- Some local laws may restrict the use of the remote engine start system. Be sure to check the local laws before using the remote engine start system.
- Do not use the remote engine start system in a poorly ventilated place. It is particularly dangerous to use the remote engine start system in a garage or other indoor place that could easily fill with exhaust gases and result in death by carbon monoxide poisoning.

#### NOTE

- The operating range of the remote engine start system is the same as that of the remote control unit for the keyless entry system.
- When using the remote engine start system, we recommend using it in a place where you can visually check the vehicle.

Be Careful about Exhaust Emissions  
→ Refer to page 2-29

Do not Run the Engine in a Garage  
→ Refer to page 2-30

#### Operating the Remote Engine Start System

To start the engine using the remote engine start system, follow the procedure below.

1. Within 5 seconds after pressing the lock button on the electronic key, press and hold the remote engine start button for approximately 1 second.
2. The engine starts after the buzzer sounds once and the hazard warning flashers flash once.

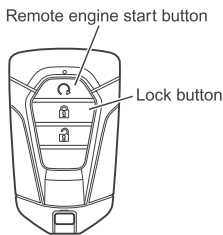

## English



3. After the engine starts, the buzzer sounds three times and the hazard warning flashers flash three times. At this time, the message "Remote engine start mode" is displayed on the MID.

**NOTE**

- The engine cannot be started using the remote engine start system unless all of the following conditions are satisfied.
  - The electronic key is not in the vehicle.
  - When the total number of times that the remote engine start system has been used and that the remote engine start system has been extended does not exceed more than the set number of times.
- To have the automatic air conditioner turn on when the engine is started by the remote engine start system, turn the automatic air conditioner on in advance.

### Stopping the Engine Idling

When the following conditions are satisfied after the engine is started using the remote engine start system, the engine stops.

- When the accelerator pedal is depressed and the engine speed exceeds 1,500 r/min.
- When the brake pedal is depressed.
- When the engine start/stop button is pressed.
- When the time set by "Remote start idle time" on the MID has elapsed. (Default: 10 minutes)
- When the selector lever is shifted in a position other than "P".
- When the engine hood is opened.
- When a door is unlocked.
- When a door is opened.
- When the remote engine start button is pressed and held.

### Extending the Engine Idling Time

After the engine is started using the remote engine start system, the engine idling time can be extended.

1. While the engine is idling after being started with the remote engine start system, press and hold the remote engine start button for approximately 1 second within 5 seconds after pressing the lock button on the electronic key.
2. The buzzer sounds three times, the hazard warning flashers flash three times, and the engine idling time is extended.



#### NOTE

- The number of times you can extend the engine idling time by using the remote engine start system is 3.

### Regarding Customizing Function

The settings of the remote engine start system can be changed by using the user customization function on the MID.

Settings (User Customization Function)

→ Refer to page 4-46

Display indication		Description
Remote start idle time	Disable	Turns off the remote engine start system.
	Min.	The engine idles for approximately 3 minutes.
	Mid.	The engine idles for approximately 5 minutes.
	Max.	The engine idles for approximately 10 minutes.

# CONTROLS AND INSTRUMENTS

# 4

**STARTING AND STOPPING THE ENGINE**

**4-3**

**INSTRUMENTS, WARNING LIGHTS AND  
INDICATOR LIGHTS**

**4-13**

**SWITCHES**

**4-111**

**DRIVING CONTROLS**

**4-141**



**STARTING AND STOPPING THE ENGINE**

• Starting the Engine	4-4
• Stopping the Engine	4-10

### Starting the Engine

Make sure that the switches, including those for the windshield wiper, light control and air conditioner, are in the off position.

Switch the power mode to "ON" (models with passive entry and start system) or turn the starter switch to the "ON" position (models without passive entry and start system) to check that the warning and indicator lights turn on normally and the fuel level is proper.



#### ADVICE

- Using a dirty or dusty key may possibly damage the starter switch. Make sure to wipe off any dirt or dust, etc., before inserting the key (models without passive entry and start system).
- Do not use starting aids such as ether in the air intake system. Such aids can cause immediate engine damage.
- When the engine does not start, wait for 1 minute or more before pushing the engine start/stop button (models with passive entry and start system) or turning the starter switch (models without passive entry and start system) again.
- Do not rev the engine when it is still cold immediately after having been started.

#### Engine Start/Stop Button (Models with Passive Entry and Start System)

→ Refer to page 4-112

#### Starter Switch (Models without Passive Entry and Start System)

→ Refer to page 4-115

### Starting the Engine



#### WARNING

- Do not keep the starter switch in the "START" position for more than approximately 10 seconds (models without passive entry and start system). Operating the starter for too long might cause battery failure or might result in overheating and even a fire.

**CAUTION**

[Manual transmission models]

- Firmly engage the parking brake when you sit in the driver's seat before starting the engine. Also, be sure to depress and hold the clutch pedal while starting the engine after making sure that the gearshift lever is in the "N" position.
- If you start the engine from outside the vehicle when the gearshift lever is in a position other than "N", the vehicle may start moving. This is very dangerous. Never start the engine from outside the vehicle.

[Automatic transmission models]

- Firmly engage the parking brake when you sit in the driver's seat before starting the engine. Also, be sure to depress and hold the brake pedal while starting the engine after making sure that the selector lever is in the "P" position.
- Although starting of the engine can be attempted in the "N" position, for safety reasons, it is recommended that starting be performed in the "P" position.

**ADVICE**

- Do not depress the accelerator pedal before starting. When the accelerator pedal is depressed before the power mode is switched to "ON" (models with passive entry and start system) or the starter switch is turned to "ON" (models without passive entry and start system), the start fuel enrich system may not function correctly. Accordingly, starting becomes substantially more difficult.
- At low ambient temperatures, a cold engine may emit more smoke (white smoke) than usual.

**NOTE**

[Preheating]

- Diesel engines are compression ignited, which makes them difficult to start when they are cold because the compression alone cannot create a temperature high enough for fuel to ignite. "Preheating" means warming the compressed air inside the combustion chambers to facilitate engine starting. Be sure to start the engine after the glow plug indicator light has gone out.

**Engine Start/Stop Button (Models with Passive Entry and Start System)**

→ Refer to page 4-112

**Starter Switch (Models without Passive Entry and Start System)**

→ Refer to page 4-115

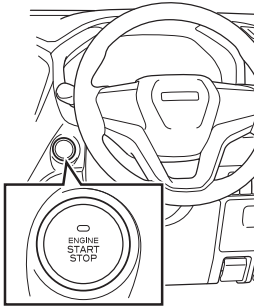

Glow plug indicator light

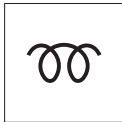

### Models with Passive Entry and Start System

1. Make sure that the parking brake lever is fully pulled.  
If your vehicle is a manual transmission model, make sure that the gearshift lever is in the "N" position and then depress the clutch pedal and brake pedal fully.  
In an automatic transmission model, make sure that the selector lever is in the "P" position and then depress the brake pedal fully.
2. With the pedal(s) depressed, push the engine start/stop button. When the engine start/stop button is pushed, the glow plug indicator light comes on and will then go out in approximately 0.5 seconds if the engine is warm.  
If the engine is cold, it will go out after remaining on for a maximum of approximately 7 seconds.
3. The starter will then automatically start the engine.



#### NOTE

- By using the passive entry and start system to verify the electronic key, the engine can be started and the power mode can be switched.
- The engine can be started when the power mode is either "OFF", "ACC", or "ON".
- When the engine is cold and glow plug warming is necessary, the accessory power will turn off and the audio system will remain off while the engine is waiting to be started.
- To stop the engine while it is being started, push the engine start/stop button and switch the power mode to "ACC" or "OFF".

NOTE (Continued)

## NOTE (Continued)

- When attempting to start the engine, the starter will crank for a maximum of 20 seconds.
- The power mode will switch to "ON" when the engine starts.

## [Engine starting is delayed]

- When attempting to start the engine, the glow plug indicator light will come on if the engine is cold. In such cases, engine starting will be delayed until the glow plugs have sufficiently warmed. Continue depressing the clutch pedal (manual transmission models) or the brake pedal (automatic transmission models) until the engine starts.

## [The engine will not start]

- If your vehicle is a manual transmission model, the engine cannot be started unless the gearshift lever is in the "N" position and the clutch pedal is depressed. If your vehicle is an automatic transmission model, the engine cannot be started unless the selector lever is in the "P" or "N" position and the brake pedal is depressed.
- When the engine does not start, check that the gearshift lever is in the "N" position (manual transmission models) or that the selector lever is in the "P" position (automatic transmission models), then switch the power mode to "OFF". Then attempt to start the engine using the correct procedure.

NOTE (Continued)

**NOTE (Continued)**

- The engine may not start or stop if the engine start/stop button is only pushed for a brief moment.
- The engine may not be able to be started immediately after it has been repeatedly started and stopped within a short period of time. In such a case, wait approximately 10 seconds or more before attempting to start the engine again.
- When the engine start/stop button indicator light flashes in green after an attempt to start the engine has been made, the engine will not be able to be started due to the steering wheel lock not being unlocked. Try starting the engine again while turning the steering wheel to the right and left. The steering wheel lock will not unlock if the vehicle battery has gone flat.
- In order to prevent the battery from becoming discharged, starting operations may be terminated during operation.
- If the engine cannot be started, please refer to "Emergency Engine Starting (Models with Passive Entry and Start System)". It may be possible to start the engine using the procedure shown on that page.

**Engine Start/Stop Button (Models with Passive Entry and Start System)**

→ Refer to page 4-112

**Emergency Engine Starting (Models with Passive Entry and Start System)**

→ Refer to page 7-11

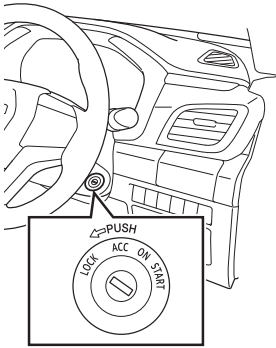

**Glow plug indicator light**

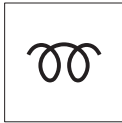

### **Models without Passive Entry and Start System**

1. Make sure that the parking brake lever is fully pulled.  
If your vehicle is a manual transmission model, make sure that the gearshift lever is in the "N" position and then depress the clutch pedal and brake pedal fully.  
In an automatic transmission model, make sure that the selector lever is in the "P" position and then depress the brake pedal fully.
2. When the starter switch is turned to the "ON" position, the glow plug indicator light comes on and will then go out in approximately 0.5 seconds if the engine is warm. If the engine is cold, it will go out after remaining on for a maximum of approximately 7 seconds.
3. After confirming that the glow plug indicator light has gone out, turn the starter switch to the "START" position to start the engine.

## Stopping the Engine

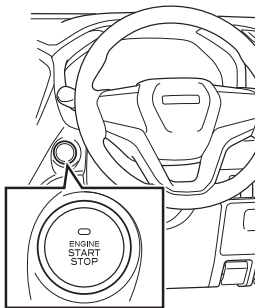

### Models with Passive Entry and Start System

1. Bring the vehicle to a complete stop and firmly apply the parking brake. In manual transmission models, place the gearshift lever in the "N" position. In automatic transmission models, place the selector lever in the "P" position.
2. Push the engine start/stop button once and the engine will stop.

### WARNING

- In the case of an emergency, the engine can be stopped while the vehicle is in motion by performing the following:
  - Continue pushing the engine start/stop button for 3 seconds or more.
  - Push the engine start/stop button three times or more within 2 seconds.
- For details on stopping the engine in the case of an emergency, please refer to "Emergency Engine Stopping (Models with Passive Entry and Start System)".

### ADVICE

- The power mode will switch to "OFF" when the engine stops. In automatic transmission models, the power mode will switch to "ACC" when the selector lever is placed in any position other than "P". To prevent the battery from going flat, switch the power mode to "OFF" after stopping the engine.

### Engine Start/Stop Button (Models with Passive Entry and Start System)

→ Refer to page 4-112

### Emergency Engine Stopping (Models with Passive Entry and Start System)

→ Refer to page 7-10

**Models without Passive Entry and Start System**

1. Bring the vehicle to a complete stop and firmly apply the parking brake. In manual transmission models, place the gearshift lever in the "N" position. In automatic transmission models, place the selector lever in the "P" position.
2. Turn the starter switch to the "ACC" or "LOCK" position.

**ADVICE**

- To prevent the battery from going flat, turn the starter switch to the "ACC" or "LOCK" position after stopping the engine. If you leave the vehicle for an extended period of time, place the starter switch in the "LOCK" position.



**INSTRUMENTS, WARNING LIGHTS AND  
INDICATOR LIGHTS**

• How to Read the Instruments (Instruments Layout)	4-14
• Tachometer	4-16
• Speedometer	4-16
• Odometer and Trip Meter	4-17
• Engine Coolant Temperature Gauge	4-18
• Fuel Gauge	4-19
• Warning and Indicator Lights Layout	4-21
• Illumination of Center Display	4-27
• Multi-Information Display (MID)	4-28
• Liquid Crystal Display (LCD)	4-50
• Head Up Display	4-60
• Warning and Indicator Lights	4-61
• Warning Buzzer	4-106

## How to Read the Instruments (Instruments Layout)

### Models with MID

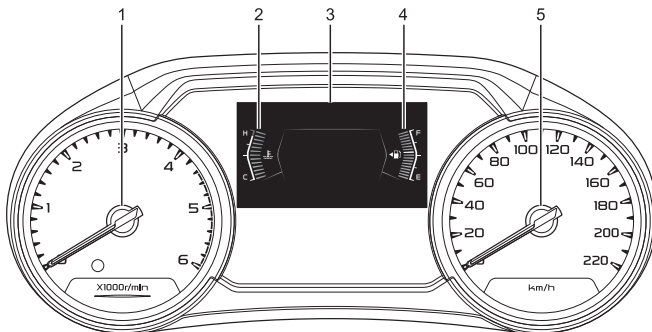

### Models with LCD

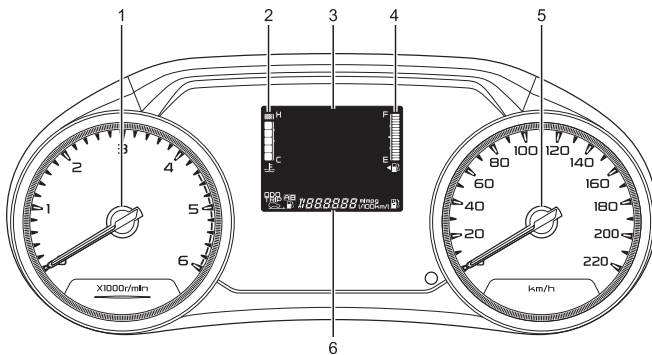

No.	Name	Reference page
1	Tachometer	4-16
2	Engine coolant temperature gauge	4-18
3	Multi-information display (MID)	4-28
	Liquid crystal display (LCD)	4-50

No.	Name	Reference page
4	Fuel gauge	4-19
5	Speedometer	4-16
6	Odometer	4-17
	Trip meter	4-17

## Tachometer



The tachometer indicates the engine speed in revolutions per minute (r/min). (Graduation "1" on the scale indicates 1,000 r/min.) The red zone indicates a range of dangerous engine speeds beyond permissible levels.

Do not drive your vehicle with the pointer of the tachometer in the red zone.

The graduation and the red zone of tachometer are various depending on the models fitted.



### ADVICE

- Exercise extreme caution when shifting down on a steep downslope. The engine speed may easily exceed the critical speed, which can seriously damage the engine.

### Appropriate Gearshifts

→ Refer to page 2-34

### Manual Transmission

→ Refer to page 4-144

## Speedometer

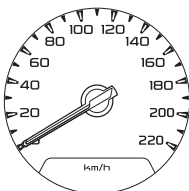

The speedometer indicates the vehicle speed in km/h.

## Odometer and Trip Meter

## Odometer

## Models with MID



Odometer

The total distance traveled by your vehicle is indicated in km.

**Multi-Information Display (MID)**

→ Refer to page 4-28

**Liquid Crystal Display (LCD)**

→ Refer to page 4-50

## Models with LCD



## Models with MID

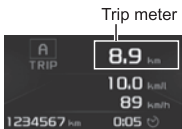

Trip meter

Use the trip meter to learn the distance between the specific points or the distance traveled during a specific period of time. The value to the right of the decimal point indicates 100-m units.

**Multi-Information Display (MID)**

→ Refer to page 4-28

**Liquid Crystal Display (LCD)**

→ Refer to page 4-50

## Models with LCD



## Engine Coolant Temperature Gauge

### Models with MID



### Models with LCD

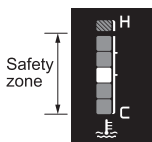

### Engine overheat warning light (models with MID)

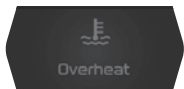

### Engine overheat warning light (models with LCD)



With the power mode in "ON" (models with passive entry and start system) or the starter switch in the "ON" position (models without passive entry and start system), this gauge indicates the temperature of the engine coolant. "C" means cold while "H" means hot. If the engine overheats, the engine coolant temperature gauge will indicate "H" zone and flash, the engine overheat warning light will come on, and the engine overheat warning buzzer will sound. During operation, the gauge should normally indicate within the safety zone.



### ADVICE

- If the gauge goes up above the upper limit of the safety zone and enters the "H" zone while you are driving, the engine is likely to overheat. Immediately pull safely off the road out of the way of any traffic and take necessary actions to deal with engine overheating.
- If the gauge is near the "H" zone but is still in the safety zone, this is not a malfunction. However, check the coolant level in the reserve tank. Add coolant as required.
- The engine can seize up if it is stopped immediately after driving. Take appropriate actions for engine overheating.

**Warning Buzzer** → Refer to page 4-106

**Engine Coolant** → Refer to page 6-39

**When the Engine Overheats**

→ Refer to page 7-22

## Fuel Gauge

### Models with MID



### Models with LCD



With the power mode in "ON" (models with passive entry and start system) or the starter switch in the "ON" position (models without passive entry and start system), this gauge indicates the quantity of fuel remaining in the fuel tank. "F" means the tank is full while "E" means the tank is almost empty.



### NOTE

- When the remaining fuel level has become low, the gauge will reach the bottom level and will flash.
- After filling up the fuel tank, it takes a while for the gauge to stabilize after the power mode is switched to "ON" (models with passive entry and start system) or the starter switch is turned to the "ON" position (models without passive entry and start system).
- If the fuel tank is filled with the engine off, but the power mode in "ON" (models with passive entry and start system) or the starter switch in the "ON" position (models without passive entry and start system), the fuel gauge takes a while to show the correct reading. In such a case, switch the power mode to "OFF" or "ACC" and then to "ON" (models with passive entry and start system), or turn the starter switch to the "LOCK" or "ACC" positions and then to "ON" again (models without passive entry and start system).

**Low fuel warning light****Warning message (models with MID)**

In models with an MID, when the vehicle is running out of fuel, the low fuel warning light comes on after the warning message is displayed on the MID for approximately 5 seconds and then goes out.

In models with an LCD, when the vehicle is running out of fuel, the low fuel warning light comes on.

**ADVICE**

- If your vehicle has run out of fuel, air bleeding procedure must be performed.

**Low Fuel Warning Light**

→ Refer to page 4-80

**When the Fuel Runs Out**

→ Refer to page 7-18

Warning and Indicator Lights Layout

Models with MID

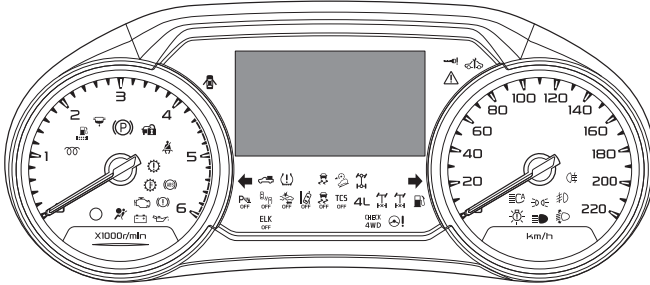



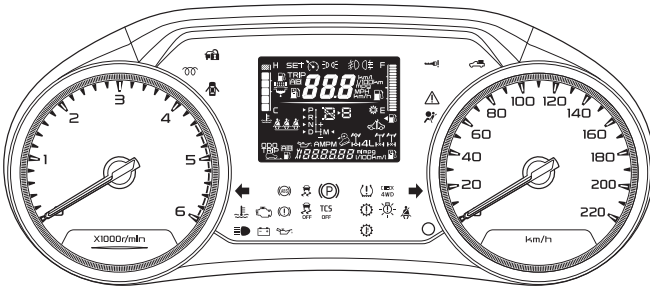







Models with LCD



















### Warning Lights

When the power mode is switched to "ON" (models with passive entry and start system) or the starter switch is turned to the "ON" position (models without passive entry and start system) for the operation check, the warning light comes on. The light turns off within a few seconds or when the engine is started.

If the light does not come on or does not turn off, there may be a problem with the system. Have the vehicle inspected at the nearest Isuzu Dealer.

Symbol	Name	Operation check	Reference page
	Front seat belt warning light	●	4-61
	Second seat belt warning light (models with LCD)	●	4-63
	SRS airbag warning light	●	4-64
	Brake system warning light	●	4-65
	Parking brake warning light		4-66
	ABS warning light	●	4-67
	ESC warning light	●	4-68
	Engine oil pressure warning light	●	4-69
	Engine overheat warning light (models with LCD)	●	4-70
	Generator warning light	●	4-75











Symbol	Name	Operation check	Reference page
	Check engine warning light/Malfunction indicator light (MIL)	●	4-76
	SVS indicator light	●	4-77
	Water separator warning light	●	4-77
	Fuel filter warning light	●	4-77
	Check trans warning light	●	4-78
	Automatic transmission fluid temperature warning light	●	4-78
	CHECK 4WD warning light	●	4-79
	Low fuel warning light	●	4-80
	LED headlight warning light	●	4-81
	Headlight automatic leveling warning light	●	4-81
	Master warning light	●	4-83
	Door open warning light		4-84
	Key monitor warning light		4-85











Symbol	Name	Operation check	Reference page
	Rear differential lock failure warning light (yellow)	●	4-85
	Steering system failure warning light	●	4-85
	TPMS warning light	●	4-86

### Indicator Lights

When the power mode is switched to "ON" (models with passive entry and start system) or the starter switch is turned to the "ON" position (models without passive entry and start system) for the operation check, the indicator light comes on. The light turns off within a few seconds or when the engine is started.

If the light does not come on or does not turn off, there may be a problem with the system. Have the vehicle inspected at the nearest Isuzu Dealer.

Symbol	Name	Operation check	Reference page
	Turn signal indicator light – left	●	4-87
	Turn signal indicator light – right	●	4-87
	Light position indicator light	●	4-88
	High beam indicator light	●	4-88
	Anti-theft system indicator light		4-88
	Front fog light indicator light	●	4-88
	Rear fog light indicator light	●	4-88
	Glow plug indicator light		4-89
	Rear differential lock indicator light (green)	●	4-89
	TCS OFF indicator light	●	4-90

Symbol	Name	Operation check	Reference page
	ESC OFF indicator light	●	4-91
	BSM OFF indicator light	●	4-92
	Parking aid system OFF indicator light	●	4-93
	4WD indicator light	●	4-95
	4WD low indicator light	●	4-95
	Hill descent control indicator light	●	4-95
	Automatic high beam indicator light	●	4-95
	Autonomous emergency braking OFF indicator light	●	4-96
	Lane departure warning OFF indicator light	●	4-97
	Emergency lane keeping OFF indicator light	●	4-97
	TPMS loading indicator light	●	4-97

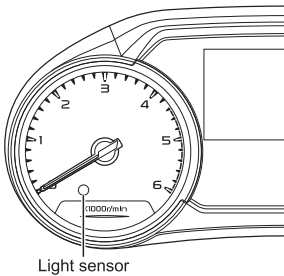
**Illumination of Center Display****Models with MID**

When the power mode is "ON" (models with passive entry and start system) or the starter switch is in the "ON" position (models without passive entry and start system), the illumination brightness is automatically adjusted according to the brightness inside the vehicle. The initial setting is "Automatic". By changing to "Manual", the illumination brightness of both the meter and MID can be individually set.

Perform "Manual" setting at "Illumination mode" displayed in the MID main routine, after changing from "Automatic" to "Manual" in "Illumination mode".

**Multi-Information Display (MID)**

→ Refer to page 4-28

**CAUTION**

- Do not place any objects in front of the sensor. Doing so will reduce the sensitivity of the sensor, and will not operate properly.

**Multi-Information Display (MID)**

Multi-information display (MID)

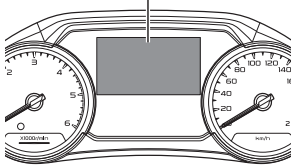

Display area 1      Display area 2

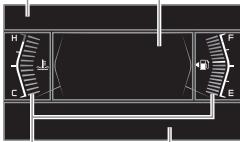

Display area 3      Display area 4

The MID in the instrument panel can display the following information.

Full screen display:

- Warning-related information
- Operation-related information
- Setting screen

Display area 1:

- Clock
- Calendar
- Outside temperature
- Vehicle speed
- Range
- Odometer
- Second seat belt warning light
- Navigation bar

Display area 2:

- Warning-related information
- Operation-related information

Display area 3:

- Engine coolant temperature gauge
- Fuel gauge

Display area 4:

- Operation-related information

**MID Mode Switch**

No.	Description
1	MID mode L switch
2	MID mode confirm switch
3	MID mode R switch

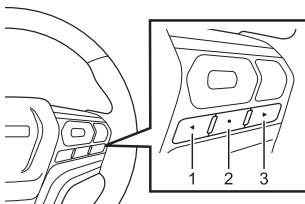

Opening Screen and Maintenance Reminder



When the power mode is "ON" (models with passive entry and start system) or when the starter switch is in the "ON" position (models without passive entry and start system), the animation screen is displayed on the MID and the opening checks are done. The opening checks confirm that the vehicle is not malfunctioning in regard to the following items.

- Parking aid system
- Blind spot monitor (BSM)/Rear cross traffic alert (RCTA)
- Stereo camera



NOTE

- The animation screen is displayed only in models equipped with the stereo camera system, parking aid system, blind spot monitor (BSM), or rear cross traffic alert (RCTA).

Icon	Color	Description
	Green	When the parking aid system is on
	Yellow	When the parking aid system is off
	Gray	During operation status check
	Green	When the BSM and RCTA are on
	Yellow	When the BSM or RCTA are off
	Gray	During operation status check
	Yellow	When part of the equipment using the stereo camera system is off
	Gray	During operation status check
	Green	When tire air pressure is appropriate
	Yellow	When tire air pressure is abnormal
	Gray	When the device is not installed

Vehicle maintenance	
Engine oil	: 10000km
Air cleaner element	: 10000km
Tire	: 10000km
Wash	: 10000km







If the vehicle is about to reach the maintenance reminder distances, the maintenance reminder displays appear on the MID.

Navigation Bar



Basic operation and the screens of the navigation bar display are shown.

When an icon on the navigation bar is selected using the MID mode R switch and the MID mode L switch, the information in the table below is displayed on the MID screen for each icon.

Icon	Description	Page
	Trip meter A and operation-related information display	4-33
	Trip meter B and operation-related information display	4-33
	Eco graph display	4-34
	Driving support system information display	4-35
	Illumination mode display	4-37
	Vehicle drive status display	4-38
	Settings display	4-40

**NOTE**

- The icon for "Settings" is displayed only when the vehicle is stopped.
- A navigation bar appears whenever the MID mode R switch or MID mode L switch is pressed. The icon shown on the current display is brightly lit on the navigation bar.
- If the "Automatic" mode is selected as the setting for the "Illumination mode" in the "Settings", "Illumi level" is not displayed on the navigation bar.

Operation-Related Information Display (Trip Meter A/B)



**NOTE**

- The displayed values for "Operation-Related Information Display" can be reset by pressing and holding the MID mode confirm switch.

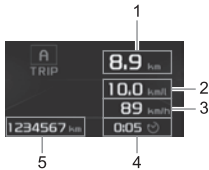

No.	Display	Description
1	Trip meter	Use the trip meter to learn the distance between the specific points or the distance traveled during a specific period of time. The value to the right of the decimal point indicates 100-m units.
2	Trip meter average fuel economy	Average fuel economy of the trip meter (A or B) section is displayed.
3	Average vehicle speed	Average vehicle speed from when the values were last reset until when they are next reset is displayed.
4	Elapsed time	Elapsed time from when the values were last reset until when they are next reset is displayed.
5	Odometer	The total distance traveled by your vehicle is indicated in km.

## Eco Graph Display

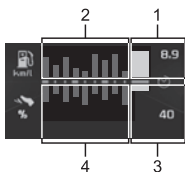

Displays the fuel consumption and the accelerator opening position while driving the vehicle.

No.	Display	Description
1	Instantaneous fuel consumption display	Instantaneous fuel consumption is displayed.
2	Average fuel consumption history display	Displays a history of the average fuel consumption per 10 minutes.
3	Instantaneous accelerator opening position display	Instantaneous accelerator opening position is displayed.
4	Average accelerator opening position history display	Displays a history of the average accelerator opening position per 10 minutes.

**Driving Support System Information Display**

Information of the preceding vehicle and lanes recognized by the stereo camera is displayed.

The ELK warning display is displayed.

**Adaptive Cruise Control (ACC)**

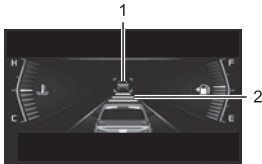

No.	Display	Description
1	Preceding vehicle indicator	This is displayed when the preceding vehicle is recognized.
2	Inter-vehicular distance display	This displays the inter-vehicular distance with the preceding vehicle in 3 levels.

**Lane Departure Warning (LDW), Lane Departure Prevention (LDP), Lane Keep Assist System (LKAS)**

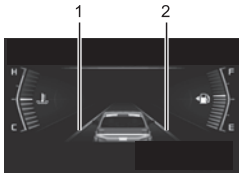

No.	Display	Description
1	Left lane marker	This displays information of the recognized lanes.
2	Right lane marker	This displays the operating state of each system.

## Emergency Lane Keeping (ELK)



Display	Description
ELK warning display	This displays the operating state of ELK.

**Illumination Mode**

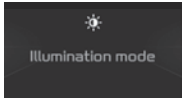

When the illumi level display icon is selected on the navigation bar, "Illumination mode" is displayed on the MID screen. The "Illumination mode" can be set by pressing the MID mode confirm switch. The meter and MID can be individually set to six brightness levels. Adjust the brightness as desired by pressing the MID mode R switch or MID mode L switch.

- : MID mode confirm switch - press once
- > : MID mode confirm switch - press and hold

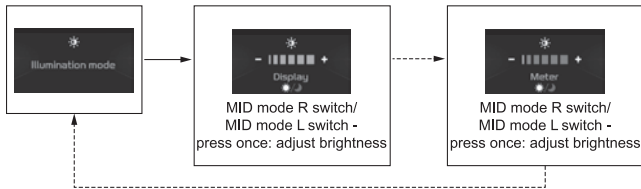

**CAUTION**

- When the headlights are turned on during daytime driving with the "Manual" mode setting, the MID may be dark and difficult to see.

**NOTE**

- When the headlight is set to OFF, the "☀️" mark comes on.
- When the headlight is set to ON, the "🚗" mark comes on.

### Vehicle Drive Status Display

Displays the vehicle drive status.



#### NOTE

- In models with tire pressure monitoring system (TPMS), the vehicle drive status display can be switched between the tire air pressure display and the drive mode display by pressing the MID mode confirm switch.

### Tire Air Pressure Display (Models with TPMS)

The tire condition and the current air pressure are displayed for each position where a tire is installed.





Display indication	Description
	When a tire's air pressure is normal, the tire is displayed in gray.
	When a tire's air pressure is low, the tire is displayed in yellow.
	When a tire's air pressure is excessively low, the tire is displayed in red.



#### NOTE

- The spare tire's air pressure is not displayed.
- Tire air pressure changes depending on the outside air temperature. Also, the displayed air pressure may differ from the value measured with an air pressure gauge.

## Drive Mode Display

Display indication	Description
 <p>2H</p>	When the 4WD switch is used to select "2H (2WD)", the "2H" is displayed on the MID.
 <p>4H</p>	When the 4WD switch is used to select "4H (4WD high)" the "4H" is displayed on the MID.
 <p>4L</p>	When the 4WD switch is used to select "4L (4WD low)", the "4L" is displayed on the MID.
 <p>4L</p>	When the rear differential lock is engaged, the "⊗" mark is displayed on the vehicle image on the MID.

## Settings (Meter Settings)

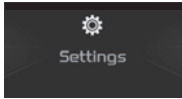

When the settings icon is selected on the navigation bar, "Settings" is displayed on the MID screen. The "Settings" can be set by pressing the MID mode confirm switch. The settings of the instrument panel cluster can be changed.

When an item is confirmed or "END" is selected, the previous display returns.

Display indication		Purpose	Reference page
Language		Display language can be changed.	4-41
Maintenance settings		The maintenance reminder can be set.	4-42
Meter settings	Unit	The units displayed on the MID can be changed.	4-43
	Customize	The items displayed on the MID can be changed.	4-43
	Optional display settings	The items displayed on the MID can be changed.	4-44
	Clock	The clock display time can be set.	4-44
	Calendar	The calendar display date can be set.	4-45
	Illumination mode	The adjustment method for MID illumination brightness can be changed.	4-46
Body electrical settings		The settings of the electrical components on the vehicle can be changed.	4-47
Driving support settings		The settings of the driving support functions of the vehicle can be changed.	4-49

**NOTE**

- Setting items for equipment and functions that are not installed on the vehicle are not displayed on the MID.

**Language**

The following languages can be selected.

Display indication
English
Thai
Turkish
Spanish
Arabic
Portuguese
German
French
Russian
Italian

### Maintenance Settings

The items for which a maintenance reminder can be set and the distances at which to be reminded that can be set are as follows.

The reminder setting for the maintenance reminder distance can be set by 1,000 km (600 miles).



#### NOTE

- Maintenance reminders for "Engine oil" and "Air cleaner element" are set at the factory.

Display indication		
Engine oil	OFF	—
	ON	From 1,000 km (600 miles) to 20,000 km (12,000 miles)
Air cleaner element	OFF	—
	ON	From 1,000 km (600 miles) to 40,000 km (24,000 miles)
Tire	OFF	—
	ON	From 1,000 km (600 miles) to 50,000 km (30,000 miles)
User	OFF	—
	ON	From 1,000 km (600 miles) to 50,000 km (30,000 miles)



#### NOTE

- When you select "OFF" in the maintenance reminder distance setting screen, no reminder messages will be displayed.
- Once 1,000 km (600 miles) remain until the maintenance reminder distance, when the power mode is switched to "ON" (models with passive entry and start system) or the starter switch is turned to the "ON" position (models without passive entry and start system), the maintenance reminder screen will be displayed for approximately 3 seconds.

**Meter Settings (Unit)**

The following items can be set in the "Unit".

Display indication	
Fuel economy display	km/l
	l/100km
	mpg
Outside temperature	C
	F
Speed	Km/h
	MPH
Pressure unit	kPa
	PSI
	Bar

**Meter Settings (Customize)**

The following items can be set in the "Customize".

Display indication		
Animation screen	Stand by animation	Enable
		Disable
Top screen items	Left	Clock
		Calendar
		Outside temperature
		Speedometer
		Range
		Odometer
	Center	Clock
		Calendar
		Outside temperature
		Speedometer
		Range
		Odometer
	Right	Clock
		Calendar
		Outside temperature
		Speedometer
		Range
		Odometer

**Meter Settings (Optional Display Settings)**

The settings of the "Gear position indicator" and "Phone call" can be changed.

Display indication		
Optional display settings	Gear position indicator	Current and recommend
		Current only
		OFF
	Phone call	Enable
		Disable

**Meter Settings (Clock)**

The clock display time and the time format can be set. To set the clock, follow the procedure below.

1. Set the time format 12H or 24H.
2. The units that can be set flash. Use the MID mode R switch and MID mode L switch, and then press the MID mode confirm switch to confirm. Press the MID mode confirm switch to confirm and move to the next item.

**NOTE**

- In this order, set the hours, the tens of minutes, and then single minutes.

3. Setting is complete when the single minutes are confirmed.

Display indication
12 hour AM-PM
24 hour

**Meter Settings (Calendar)**

The calendar display date and the calendar format can be set. To set the calendar, follow the procedure below.

1. Set the calendar format YY-MM-DD (Year-Month-Day), DD-MM-YY (Day-Month-Year), or MM-DD-YY (Month-Day-Year).
2. The units that can be set flash. Use the MID mode R switch and MID mode L switch, and then press the MID mode confirm switch to confirm. Press the MID mode confirm switch to confirm and move to the next item.

**NOTE**

- The year, month, date, hour, tens of minutes, and single minutes can be set in this order.

3. Setting is complete when the single minutes are confirmed. The calendar display returns.

Display indication	
YY-MM-DD	Edit Year
	Edit Month
	Edit Day (tens of minutes)
	Edit Day (single minutes)
DD-MM-YY	Edit Year
	Edit Month
	Edit Day (tens of minutes)
	Edit Day (single minutes)
MM-DD-YY	Edit Year
	Edit Month
	Edit Day (tens of minutes)
	Edit Day (single minutes)

### Illumination Mode

The following items can be set in the illumination mode.

Display indication	
Automatic	High
	Normal
	Low
Manual	—



#### NOTE

- The factory default setting is "Normal" under "Automatic".
- In the "High" setting of the "Automatic" mode, the illumination brightness changes with high sensitivity. The sensitivity of "Normal" is between "High" and "Low". "Low" changes with low sensitivity. The factory default setting is "Normal".
- When "Automatic" mode is used after the brightness has been adjusted in "Manual" mode, the illumination will be automatically adjusted based on the brightest state with the headlight switch in the off position setting for the "Manual" mode and the darkest state with the headlight switch in the on position setting.

Settings (User Customization Function)

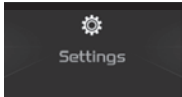

When the settings icon is selected on the navigation bar, "Settings" is displayed on the MID screen. The "Settings" can be set by pressing the MID mode confirm switch. The settings of the user customization function can be changed.

When an item is confirmed or "END" is selected, the previous display returns.

**Body Electrical Settings**

The items that can be changed are as follows.

Display indication		Page
Door lock	Auto unlock type	Disable
		KEY*1
		IGN
		Shift-P*2
	Auto lock type	Disable
		Speed
		Except Shift-P*2
	Auto lock speed	20 km/h (13 mph)
		12 km/h (8 mph)
	Auto lock enable by door*3	Enable
Disable		
		3-35
		3-33
		3-33
		3-33

\*1: Models with keyless entry system

\*2: Models with automatic transmission

\*3: You can set the auto door lock function to reactivate or not reactivate when a door is opened and closed after the doors were locked by the auto door lock function.

Display indication		Page	
Passive entry and start system	Communication mode	Radio ON	3-23
		Radio OFF	
	Walk away lock	Enable	3-32
		Disable	
	Answerback chime	Disable	3-23
		Min.	
		Mid.	
	Walk away lock chime	Enable	3-32
		Disable	
	Welcome light	Enable	3-24
Disable			
Light	Auto light sensitivity	0	4-119
		1	
		2	
		3	
	Headlight battery saver	Enable	4-121
		Disable	
	Coming home light	Enable	4-123
		Disable	
	Interior light linked RKE	Enable	3-16
		Disable	
Comfort turn signal	Enable	4-124	
	Disable		
Wiper	Automatic wiper	Enable	4-133
		Disable	
Remote engine start	Remote start idle time	Disable	3-124
		Min.	
		Mid.	
		Max.	

**Driving Support Settings**

The items that can be changed are as follows.

Display indication		Page
Automatic high beam	Mode	Enable
		Disable
Automatic emergency braking	Brake and warning intervention	Enable
		Disable
	Warning sensitivity	Far
		Normal
	Near	
Lane support settings	Lane departure prevention	Assist and warning
		Warning only
		Off
	Emergency lane keeping	Enable
		Disable
	Attention assist	Enable
Disable		
Lane departure warning	Lane departure warning	Enable
		Disable
Blind spot monitor	Warning	Enable
		Disable
Rear cross traffic alert	Warning	Enable
		Disable
Parking aid settings	Trailer mode	Off
		Trailer hitch only
	Bull bar mode	Without bull bar
		With bull bar



**NOTE**

- Make sure that the vehicle is stopped to operate settings.
- The settings are reset if the vehicle is driven during this operation.
- The items for "Driving support settings" are displayed even though the stereo camera system, parking aid system, blind spot monitor (BSM), or rear cross traffic alert (RCTA) is not installed on your vehicle.

## Liquid Crystal Display (LCD)

Liquid crystal display (LCD)

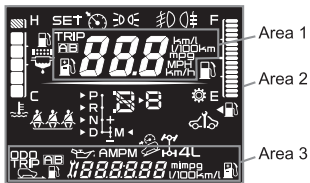
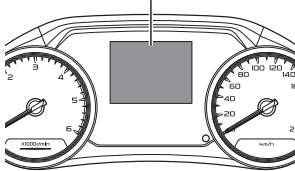

The LCD in the instrument panel can display the following information.

## Display area 1

- Fuel economy
- Vehicle speed

## Display area 2

- Engine coolant temperature gauge
- Fuel gauge
- Warning light
- Indicator light
- Gear shift indicator (GSI)

## Display area 3

- Odometer
- Trip meter
- Fuel economy
- Range (possible driving range)
- Calendar
- Clock
- Maintenance reminder for engine oil

Display Area 1 Setting

The display area 1 settings can be displayed by pressing and holding the trip knob while the odometer is shown.

Each time the trip knob is pressed once, the information in display area 1 changes.

Pressing and holding the trip knob completes the settings and the LCD returns to its main routine. While setting the display area 1 settings screen, the "TRIP" mark is on and the display being set flashes.

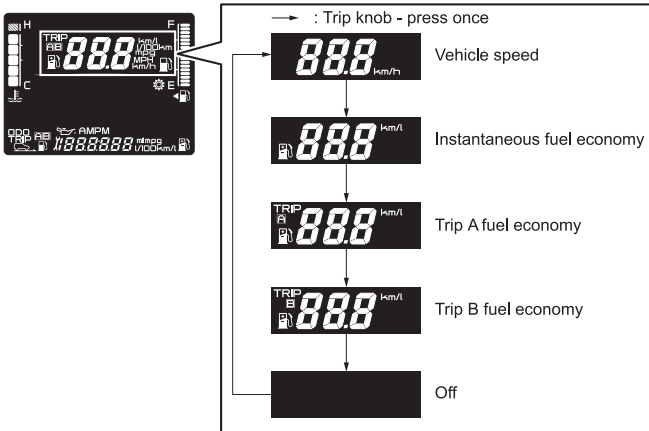

## Maintenance Reminder for Engine Oil



The maintenance reminder for engine oil is displayed for approximately 5 seconds after a door is opened and then closed while the starter switch is in the "OFF" position. When the distances reach 1,000 km (600 miles) remaining until they reach the maintenance reminder distances set, the maintenance reminder display appears on the LCD.

**NOTE**

- The maintenance reminder for engine oil is set at the factory. The factory set distance is 20,000 km (12,000 miles).
- The maintenance reminder for engine oil distance can be set by 1,000 km (600 miles) from 1,000 km (600 miles) to 20,000 km (12,000 miles).
- Until the reminder distance of the maintenance reminder is reached, the odometer is displayed instead of the maintenance reminder display. Pressing the trip knob once while the odometer is displayed switches to the maintenance reminder display.

LCD Main Routine

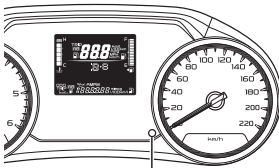

Trip knob

Basic operation and the screens of the LCD are shown.

Use the trip knob to select the desired display or function. Each time the trip knob is pressed once, the information in display area 3 changes.

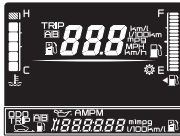
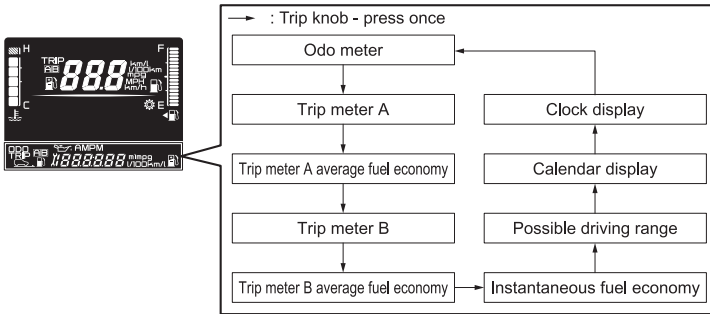

**Odometer**

If you select the odometer display when the starter switch is in the "ON" position, the odometer ("ODO") will be displayed on the LCD.

The total distance traveled by your vehicle is indicated.

The information shown in display area 1 can be set by pressing and holding the trip knob while this display is shown.



### Trip Meter (A or B)

If you select the trip meter display when the starter switch is in the "ON" position, trip meter will be displayed on the LCD. In addition, two separate distances can be associated with trip meter A ("TRIP A") and trip meter B ("TRIP B").

Use the trip meter to learn the distance between the specific points or the distance traveled during a specific period of time.

The value to the right of the decimal point indicates 100-m units.

The displayed values for "Trip Meter" can be reset by pressing and holding the trip knob.



#### NOTE

- At this time, the section average fuel consumption display of trip meter A or B displayed in display area 1 is reset as well.



### Trip Meter (A or B) Average Fuel Economy

If you select the trip meter average fuel economy display when the starter switch is in the "ON" position, trip meter average fuel economy distance will be displayed on the LCD.

The displayed values for "Trip Meter Average Fuel Economy" can be reset by pressing and holding the trip knob.



#### NOTE

- At this time, the section average fuel consumption display of trip meter A or B displayed in display area 1 is reset as well.



### Instantaneous Fuel Economy

If you select the instantaneous fuel economy display when the starter switch is in the "ON" position, instantaneous fuel economy is indicated in figures.

The "Units of Measurement Setting" can be set by pressing and holding the trip knob while this display is shown.



### Possible Driving Range

If you select the possible driving range display when the starter switch is in the "ON" position, displays the estimated maximum distance that can be driven with the remaining fuel quantity.



#### NOTE

- It may not always be possible to actually drive the displayed distance because it is calculated based on the past fuel economy (average fuel economy).
- Since the fuel in the fuel tank moves when going uphill and downhill, the accuracy of the displayed distance may decrease greatly.
- The display may not be updated when only a small amount of fuel is added to the tank.

The "Gear Shift Indicator" can be set by pressing and holding the trip knob while this display is shown.



250 120

### Calendar Display

If you select the calendar display when the starter switch is in the "ON" position, the calendar can be displayed on the LCD. While setting the calendar screen, the "🔧" mark is on and the display being set flashes.

To set the calendar, follow the procedure below.



#### NOTE

- When you set the calendar, you need to set the clock at the same time.

1. To access the calendar settings, press and hold the trip knob while the calendar is displayed.
2. The item that is flashing can be set. Press the trip knob once to select and press and hold to confirm. Press and hold to confirm and move to the next item.



#### NOTE

- The year, month, date, hour, tens of minutes, and single minutes can be set in this order.
3. Setting is complete when the single minutes are confirmed. The calendar display returns.



### Clock Display

If you select the clock display when the starter switch is in the "ON" position the clock can be displayed on the LCD. While setting the clock screen, the "⊗" mark is on and the display being set flashes.

To set the clock, follow the procedure below.

1. The clock can be set by pressing and holding the trip knob while the clock is displayed.
2. The units that can be set flash. Press the trip knob once to select and press and hold to confirm. Press and hold to confirm and move to the next item.



#### NOTE

- In this order, set the time format (12H or 24H), the hours, the tens of minutes, and then single minutes.
3. Setting is complete when the single minutes are confirmed. The clock display returns.

Units of Measurement Setting

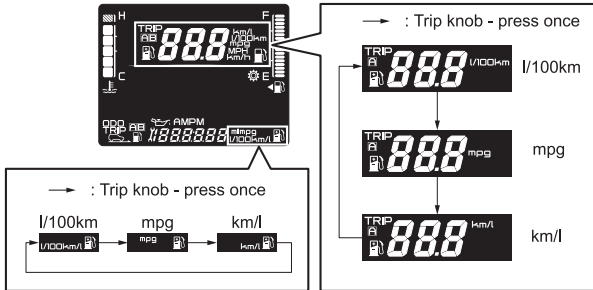

The units displayed for the instantaneous fuel economy can be changed by pressing and holding the trip knob while the "Instantaneous Fuel Economy" is displayed.

Each time the trip knob is pressed once, the units of measurement changes.

While setting the "Units of Measurement Setting", the "⚙️" mark is on and the display being set flashes.

Pressing and holding the trip knob completes the settings and the LCD returns to its main routine.

## Gear Shift Indicator (GSI)

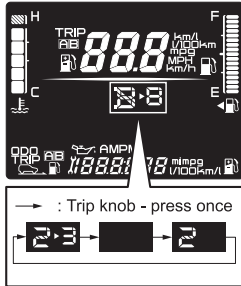
**Manual Transmission Model**

The gear shift indicator (GSI) display can be changed by pressing and holding the trip knob while "Possible Driving Range" is displayed.

Each time the trip knob is pressed once, the gear shift indicator (GSI) display changes.

Pressing and holding the trip knob completes the settings and the LCD returns to its main routine. While setting the gear shift indicator screen, the "⚙️" mark is on and the display being set flashes.

The GSI display can be switched between the following 3 patterns.

- The current gear position and recommended gear position are displayed. (GSI on)
- The current gear position and the recommended gear position are not displayed. (GSI off)
- Only the current gear position is displayed.

## Head Up Display

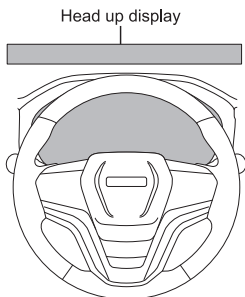

The head up display projects LED light onto the windshield to alert the driver.

When the power mode is switched to "ON" (models with passive entry and start system) or the starter switch is turned to the "ON" position (models without passive entry and start system) for the operation check, the LED light comes on. The light turns off within a few seconds.

If the light does not come on or does not turn off, there may be a problem with the system. Have the vehicle inspected at the nearest Isuzu Dealer.



### ADVICE

- Do not place drinks near the head up display. If water or other liquids spill on the head up display, it could cause the head up display to malfunction.
- Do not place objects near or attach stickers to the head up display. Doing so could obstruct the display so it cannot operate normally.

## Warning and Indicator Lights

### Front Seat Belt Warning Light



This warning light comes on when the driver or front passenger is not wearing their seat belt while the power mode is "ON" (models with passive entry and start system) or the starter switch is in the "ON" position (models without passive entry and start system).

When the vehicle speed exceeds approximately 20 km/h (12 MPH), this warning light flashes. At this time, the warning buzzer sounds for approximately 90 seconds.



#### NOTE

- The warning light will go out and the buzzer will stop sounding as soon as the driver has buckled the seat belt.
- The front seat belt warning operates when a passenger is in the passenger seat. However, when there is luggage on the passenger seat, the warning may operate even if there is no passenger.

## Second Seat Belt Warning Light

**Models with Far Side Airbag**

This warning light comes on when the passenger is not wearing his/her seat belt while the power mode is "ON" (models with passive entry and start system) or the starter switch is in the "ON" position (models without passive entry and start system).

When the vehicle speed exceeds approximately 20 km/h (12 MPH), this warning light flashes. At this time, the warning buzzer sounds for approximately 90 seconds.

**NOTE**

- The warning light will go out and the buzzer will stop sounding as soon as the passenger has buckled the seat belt.
- The second seat belt warning operates when a passenger is in the passenger seat. However, when there is luggage on the passenger seat, the warning may operate even if there is no passenger.

**Models with MID****Models with LCD****Models without Far Side Airbag**

If one of the seat belts for the second seats is not being used when the power mode is switched to "ON" (models with passive entry and start system) or the starter switch is turned to the "ON" position (models without passive entry and start system), the second seat belt warning light comes on. It remains on for approximately 60 seconds. If a seat belt is unbuckled after the second seat belt warning light turns off, the second seat belt warning light comes on. It remains on for approximately 30 seconds and then turns off. If a seat belt is unbuckled while the vehicle speed exceeds approximately 20 km/h (12 MPH), the warning light flashes and the warning buzzer sounds for approximately 30 seconds. The light goes out after a certain period of time.

**NOTE**

- The warning light will go out and the buzzer will stop sounding as soon as the passenger has buckled the seat belt.
- When the power mode is switched to "ON" (models with passive entry and start system) or the starter switch is turned to the "ON" position (models without passive entry and start system), this warning light comes on even if there are no passengers on the second seat.

## SRS Airbag Warning Light



This warning light comes on when the power mode is switched to "ON" (models with passive entry and start system) or the starter switch is turned to the "ON" position (models without passive entry and start system), and then goes out after approximately 6 seconds.

If this warning light comes on, seat belt with pretensioner and airbag may not function properly in the event of a collision.

 **WARNING**

- If you encounter any of the following conditions, system errors have occurred. Have your vehicle inspected/serviced at your Isuzu Dealer as soon as possible.
  - If the SRS airbag warning light does not come on when the power mode is switched to "ON" (models with passive entry and start system) or the starter switch is turned to the "ON" position (models without passive entry and start system).
  - If the SRS airbag warning light does not go out.
  - If the SRS airbag warning light comes on while driving the vehicle.

 **NOTE**

- It is normal for the warning light to come on approximately 6 seconds, and then go out when the power mode is switched to "ON" (models with passive entry and start system) or the starter switch is turned to the "ON" position (models without passive entry and start system). The SRS airbag warning light may come on again immediately after the engine is started, but it is normal if it goes out after coming on a few seconds.
- The SRS airbag warning light may come on suddenly if the power mode is switched to "ACC" (models with passive entry and start system), the starter switch is turned to the "ACC" position (models without passive entry and start system), or electrical equipment is operated, but this is not abnormal.

**Brake System Warning Light**

This warning light comes on while the engine is running (after startup) in the following situations:

- Drop in the level of brake fluid (due to brake wear or fluid leakage, etc.)
- On an anti-lock brake system (ABS) model, abnormality in the EBD (the ABS warning light will also come on.)

**ABS Warning Light**

→ Refer to page 4-67

**CAUTION**

- If the brake system warning light comes on while the engine is running, immediately stop your vehicle at a safe place well clear of traffic and promptly contact the nearest Isuzu Dealer for inspection.
- Immediately stop your vehicle at a safe place and contact your Isuzu Dealer when the ABS warning light and brake system warning light both remain on. The indications mean that the ABS will fail and vehicle will become extremely unstable during braking. Also the rear brakes may lock up more easily than usual in emergency braking. This could result in an accident.

### Parking Brake Warning Light



This warning light comes on when the parking brake lever is pulled up.

#### CAUTION

- The illumination of the warning light does not necessarily ensure firm application of the parking brake. The parking brake lever must be sufficiently pulled up and locked.
- Be careful not to drive the vehicle with the parking brake lever still pulled up.

### Parking Brake Release Warning Light



#### Models with MID

If the vehicle is driven without releasing the parking brake and the speed reaches approximately 5 km/h (3.1 MPH), this message appears on the display while a buzzer sounds. When the parking brake release warning light is indicated, release the parking brake.

**Warning Buzzer** → Refer to page 4-106

**ABS Warning Light**

This warning light comes on whenever there is a problem in the anti-lock brake system (ABS). In this case, the ABS stops working but the brakes still function as ordinary service brakes.

This warning light also comes on when the rear differential lock switch is "ON" (models with rear differential lock).

**CAUTION**

- If the ABS warning light comes on while driving, immediately stop your vehicle at a safe place well clear of traffic and take the following actions.
  - Stop the engine.
  - Restart the engine. Check if the ABS warning light comes on and then goes out. If it does, there is no problem. The ABS operates normally.
  - Move the vehicle slowly forward. Gradually increase the speed to 15 km/h (9 MPH). If the light goes off, the ABS is normal.
- Immediately stop your vehicle at a safe place and contact your Isuzu Dealer when the ABS warning light and brake system warning light both remain on. The indications mean that the ABS will fail and vehicle will become extremely unstable during braking. Also the rear brakes may lock up more easily than usual in emergency braking. This could result in an accident.
- If the ABS warning light does not go out, or comes on repeatedly, have the vehicle inspected/serviced at the nearest Isuzu Dealer as soon as possible.
- Even if a problem has occurred in the ABS, the brakes will still work as normal brakes. In this case, the ABS has no influence on the operation of the brake system.

**Anti-lock Brake System (ABS)**

→ Refer to page 4-157

## ESC Warning Light



This warning light comes on whenever there is a problem in the electronic stability control (ESC) and/or hill descent control. When the ESC is operating, this warning light flashes.

This warning light also comes on when the 4WD switch is set to 4L (4WD low).

This warning light will also flash when only the traction control system (TCS) function is operating inside the ESC system.

When the ESC warning light does any of the following, the ESC may be faulty. Please contact the nearest Isuzu Dealer.

- When the ESC warning light remains on while driving.
- The ESC warning light does not come on when the power mode is switched to "ON" (models with passive entry and start system) or the starter switch is turned to the "ON" position (models without passive entry and start system).

**NOTE**

- When the ESC warning light is on, the TCS/ESC will not operate, but this has no effect on normal driving.
- The ESC warning light may come on when the battery cables are disconnected or the battery voltage is low. The ESC function turns off while the ESC warning light is on, but the ESC warning light will turn off by driving the vehicle normally for a while, then the ESC function will resume. If the ESC warning light remains on even after driving for a while, contact the nearest Isuzu Dealer.

**Electronic Stability Control (ESC)**

→ Refer to page 4-162

**Hill Descent Control**

→ Refer to page 4-172

**Engine Oil Pressure Warning Light**

While the engine is running, this warning light comes on if the engine oil pressure, which lubricates the engine components, is abnormal.

**ADVICE**

- If the engine oil pressure warning light comes on while the engine is running, immediately pull off to a safe place well clear of traffic. Stop the engine immediately and check the engine oil level.
- If the engine oil pressure warning light comes on while the engine is running, the lubrication system may be faulty. Promptly have your vehicle inspected at the nearest Isuzu Dealer.

**Engine Oil** → Refer to page 6-22

## Engine Overheat Warning Light

## Models with MID

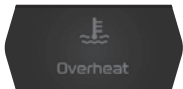

## Models with LCD



This warning light comes on when the engine overheats. When the engine overheats, the engine coolant temperature gauge will indicate "H" zone and flash, the engine overheat warning light will come on, and the engine overheat warning buzzer will sound. Immediately pull off the road in a safe place, check the vehicle and take necessary actions.

 **WARNING**

- When the engine coolant is still hot, do not remove the radiator cap. Hot vapor will come out and you may be scalded. Add engine coolant only when the engine coolant temperature has dropped.

 **CAUTION**

- If you continue to drive the vehicle with the engine overheat warning light on steady, the engine may seize up.

 **ADVICE**

- Do not shut down an overheating engine immediately. Otherwise, the engine may seize up. Take appropriate actions for engine overheating.

**Warning Buzzer** → Refer to page 4-106

**Adding the Engine Coolant**

→ Refer to page 6-43

**When the Engine Overheats**

→ Refer to page 7-22

## Maintenance Reminder Display



Vehicle maintenance	
Engine oil	1 : 10000km
Air cleaner element	1 : 40000km
Tire	1 : *****
Lube	1 : *****

**Models with MID**

If the vehicle is about to reach the maintenance reminder distances set by the user, the maintenance reminder displays appear on the MID when the power mode is switched to "ON" (models with passive entry and start system) or the starter switch is turned to the "ON" position (models without passive entry and start system).

**NOTE**

- The maintenance reminders for "Engine oil" and "Air cleaner element" are set at the factory. The factory set distance of maintenance reminder for "Engine oil" is 20,000 km (12,000 miles). The factory set distance of maintenance reminder for "Air cleaner element" is 40,000 km (24,000 miles).

**Multi-Information Display (MID)**

→ Refer to page 4-28

**Engine Oil** → Refer to page 6-22

**Air Cleaner** → Refer to page 6-49

**Wheels and Tires** → Refer to page 6-61



### Models with LCD

The maintenance reminder for engine oil is displayed for approximately 5 seconds after a door is opened and then closed while the starter switch is in the "OFF" position.



### NOTE

- The maintenance reminder for Engine oil is set at the factory. The factory set distance is 20,000 km (12,000 miles).

### Liquid Crystal Display (LCD)

→ Refer to page 4-50

### Engine Oil

→ Refer to page 6-22

## Gear Shift Indicator (GSI)

### Models with MID



Gear shift indicator (GSI)

### Manual Transmission Model

The GSI assists in gear selection to enable improved fuel economy when driving. In addition to displaying the current gear position on the instrument panel, it also displays the recommended gear position when there is a gear in which fuel economy would be improved.

### Models with LCD



Gear shift indicator (GSI)



### CAUTION

- The recommended gear position displayed on the GSI is only a recommendation. It may be necessary to select a gear different than that displayed. Make sure to determine the shift position according to the actual road condition and surrounding situation.

**NOTE**

- The current gear position and the recommended gear position will not be displayed in the following conditions:
  - When the vehicle is stopped
  - When 4L (4WD low) is selected (models with 4WD)
  - When the gearshift lever is in the "N (neutral)" or "R (reverse)" position
- The current gear position may not be displayed correctly or the display may be delayed in the following conditions:
  - When the clutch is slipping
  - When the tires are slipping
  - When the tires installed are not of the specified size
  - When the tire pressure is insufficient
  - When accelerating suddenly or excessively

## Shift Indicator

## Models with MID

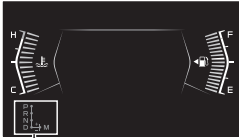

Shift indicator

## Models with LCD

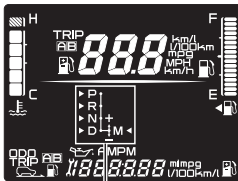

Shift indicator

## Automatic Transmission Model

The shift indicator indicates the location of the selector lever or the gear position (in manual mode).

Display	Description
P	Park
R	Reverse
N	Neutral
D	Drive (auto mode)
M1 - M6	Drive (manual mode)
No display	Shifting
-	Malfunction



## ADVICE

- If "-" is displayed intermittently, have the vehicle inspected/serviced at the nearest Isuzu Dealer as soon as possible.

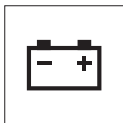
**Generator Warning Light**

This warning light comes on when, while the engine is running, there is a problem with the charging system (such as a loose or broken fan belt).

**ADVICE**

- If this warning light comes on while the engine is running, immediately pull off to a safe place well clear of traffic and promptly contact the nearest Isuzu Dealer for inspection.

**Fan Belt/Air Conditioning Compressor Belt/Accessory Belt**

→ Refer to page 6-46

**Handling the Battery**

→ Refer to page 6-115

**When the Battery Goes Flat**

→ Refer to page 7-16

### Check Engine Warning Light/ Malfunction Indicator Light (MIL)

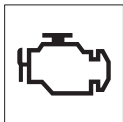

For models other than those conforming to Euro 4 emission standards, a check engine warning light is equipped.

For models conforming to Euro 4 emission standards, a malfunction indicator light (MIL) is equipped.

If this light comes on while the engine is running, this alerts you to a problem with the engine electronic control system. In addition, if this light does not turn on when the power mode is switched to "ON" (models with passive entry and start system) or the starter switch is turned to the "ON" position (models without passive entry and start system), an abnormality, etc., in the engine electronic control system is possible. Please contact the nearest Isuzu Dealer.



#### CAUTION

- If the light comes on and the engine stops, it is possible that the engine has entered protection mode. Switch the power mode to "OFF" (models with passive entry and start system) or turn the starter switch to the "LOCK" position (models without passive entry and start system) and wait at least 15 seconds before proceeding to start the engine again. Even if the vehicle is drivable, see the nearest Isuzu Dealer as soon as possible for service of the system.



#### ADVICE

- If this light comes on while the engine is running, avoid driving at high speeds and promptly have the vehicle inspected at the nearest Isuzu Dealer.
- If this light comes on either intermittently or continuously while driving, service is required. Even if the vehicle is drivable, and does not require towing, see your Isuzu Dealer as soon as possible for service of the system. Continued driving without having the system serviced could cause damage to the emission control system. It could also affect fuel economy and drivability.

**Service Vehicle Soon (SVS) Indicator Light**

For models conforming to Euro 4 emission standards, a service vehicle soon (SVS) indicator light is equipped.

If this indicator light comes on during operation, immediately contact the nearest Isuzu Dealer for inspection.

**Water Separator Warning Light**

When water in the water separator needs draining, the water separator warning light comes on.

Drain water following the instructions in the "Draining Water from the Fuel Filter" and make sure the warning light goes out.

**CAUTION**

- If the water separator warning light comes on while the engine is running, immediately drain water from the fuel filter. If you still continue driving with the warning light on, the fuel injection system may fail.

**Draining Water from the Fuel Filter**

→ Refer to page 6-51

**Bleeding the Fuel System**

→ Refer to page 7-19

**Fuel Filter Warning Light**

This warning light comes on when the fuel filter element clogged with dust and others.

If this warning light comes on, have the vehicle inspected/serviced at your Isuzu Dealer as soon as possible.

### Check Trans Warning Light



#### Automatic Transmission Model

If this light flashes after the engine has started, there is something wrong with the transmission electronic control system.



#### ADVICE

- If the check trans warning light flashes, have the automatic transmission inspected at the nearest Isuzu Dealer as soon as possible.
- While the check trans warning light is flashing, the computer may put the transmission into emergency mode.

### Automatic Transmission Fluid Temperature Warning Light

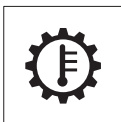

#### Automatic Transmission Model

This warning light comes on when the temperature of the automatic transmission becomes high while driving.



#### ADVICE

- If the automatic transmission fluid temperature warning light comes on while driving, the automatic transmission fluid is abnormally hot. Immediately pull safely off the road out of the way of any traffic, place the selector lever in the "P" position and run the engine at idling speed. Do not start driving again until the warning light goes out.
- If the automatic transmission fluid temperature warning light does not go off, have the automatic transmission lubricating system inspected at the nearest Isuzu Dealer as soon as possible.

## CHECK 4WD Warning Light

**4WD Model**

When this warning light stays on, the 4WD system has a malfunction. Please contact the nearest Isuzu Dealer.

**CAUTION**

- If the CHECK 4WD warning light does not go out, or comes on repeatedly, have the inspected/serviced at the nearest Isuzu Dealer as soon as possible.

## Icy Road Warning Light

**Models with MID**

This warning light comes on when the outside temperature is low and the road surface may be frozen. At this time, warning message is displayed on the MID for approximately 5 seconds.

Since this is based on the outside temperature detected by the outside air temperature sensor and not the actual road surface temperature, it does not accurately display frozen road surface conditions.

**CAUTION**

- When the outside temperature is low, the road surface may be frozen even if the icy road warning light does not illuminate. Concentrate on driving safely, paying attention to the condition of the road surface.

## Low Fuel Warning Light



## Warning message (models with MID)



In models with an MID, when the fuel level in the tank becomes low while the engine is running, this warning light comes on after the warning message is displayed on the MID for approximately 5 seconds.

In models with an LCD, when the fuel level in the tank becomes low while the engine is running, this warning light comes on.



## ADVICE

- If the low fuel warning light comes on, add fuel at the earliest possible time.
- If the vehicle runs out of fuel, air bleeding procedure must be performed.

**Fuel Gauge** → Refer to page 4-19  
**When the Fuel Runs Out**

→ Refer to page 7-18

## LED Headlight Warning Light



## Warning message

RH Headlight failure

LH Headlight failure



## NOTE

- The LED headlight warning light comes on when there is a failure in the LED headlight system while the LED headlights are on. The warning light goes out if the LED headlights are turned off, even when there is a failure.
- The LED headlight warning light may not come on even when there is a failure in the LED headlight system if the amount of time that the LED headlights are on is short, such as when using the headlights for a flash-to-pass signal.

## LED Headlight Model

When there is an abnormality in the LED headlight system, the LED headlight warning light comes on after the warning message is displayed on the MID for approximately 5 seconds.

Have your vehicle inspected at the nearest Suzuki Dealer.

## Headlight Automatic Leveling Warning Light

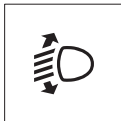

This warning light comes on when there is an abnormality in the headlight automatic leveling.

Have your vehicle inspected at the nearest Suzuki Dealer.

**Taillight Failure Warning Light****Warning message**

When there is an abnormality in the taillight, the warning message is displayed on the MID for approximately 5 seconds. Have your vehicle inspected at the nearest Isuzu Dealer.

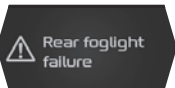
**Rear Fog Light Failure Warning Light****Warning message**

When there is an abnormality in the rear fog light, the warning message is displayed on the MID for approximately 5 seconds. Have your vehicle inspected at the nearest Isuzu Dealer.

**Master Warning Light**

**Warning message (models with MID)  
(warning light and indicator light)**



This warning light comes on when the warning light and indicator light on the instrument panel is abnormal. At this time, warning message is displayed on the MID for approximately 5 seconds.

If this warning light comes on, contact the nearest Isuzu Dealer.

This warning light comes on together with following indicator lights to alert you that there is a problem with the vehicle.

- BSM OFF indicator light
- Parking aid system OFF indicator light
- Autonomous emergency braking OFF indicator light
- Lane departure warning OFF indicator light

**BSM OFF Indicator Light**

→ Refer to page 4-92

**Parking Aid System OFF Indicator Light**

→ Refer to page 4-93

**Autonomous Emergency Braking OFF**

**Indicator Light** → Refer to page 4-96

**Lane Departure Warning OFF Indicator**

**Light** → Refer to page 4-97

## Door Open Warning Light



Warning message



The door open warning light comes on if any door is not fully closed when the power mode is switched to "ON" (models with passive entry and start system) or the starter switch is turned to the "ON" position (models without passive entry and start system).

For models with MID, this message appears on the display at the same time.

This warning light also comes on if the driver's door is opened while driving. In models with an MID, the warning message is also displayed on the MID at the same time.

At this time, the warning buzzer sounds.

### Models with Passive Entry and Start System

The warning buzzer will sound if door locking is attempted by pressing the request switch on the door handle or the lock button on the electronic key when the doors are open. If this warning light is displayed, the doors will not lock even if the request switch on the door handle or the lock button on the electronic key is pressed.

### Passive Entry and Start System

→ Refer to page 3-17

Warning Buzzer → Refer to page 4-106

**Key Monitor Warning Light**

This warning light comes on when there are abnormalities in the passive entry and start system, power management system, or steering wheel lock system.

**ADVICE**

- If the warning light comes on repeatedly or remains on, have the vehicle inspected/serviced at the nearest Isuzu Dealer as soon as possible.

**Passive Entry and Start System**

→ Refer to page 3-17

**Rear Differential Lock Failure Warning Light**

This warning light comes on when there are abnormalities in the rear differential lock system.

**Rear Differential Lock Switch**

→ Refer to page 4-128

**Steering System Failure Warning Light**

This warning light comes on when there is an abnormality in the electric power steering system.

If this warning light comes on, stop the vehicle in a safe place and restart the engine. If the warning light still comes on, have your vehicle inspected at the nearest Isuzu Dealer as soon as possible.

**CAUTION**

- When this warning light is on, the electric power steering system is stopped and the steering wheel becomes hard to turn.

## TPMS Warning Light



This warning light comes on when tire air pressure decreases by more than a certain value.

When the warning light does any of the following, the tire pressure monitoring system (TPMS) may be faulty. Have the vehicle inspected at the nearest Isuzu Dealer.

- If the warning light does not go out even after driving for approximately 10 minutes after the air pressure adjustment.
- If the warning light flashes for approximately 1 minute and then comes on.

**ADVICE**

- If the warning light comes on while driving, the tire air pressure decreases. In this case, check the tire air pressure and adjust to the specified value.

**Tire Pressure Monitoring System (TPMS)**

→ Refer to page 4-319

**Wheels and Tires** → Refer to page 6-61

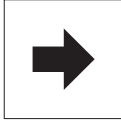
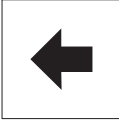
**Turn Signal Indicator Light**

Either of these indicator lights flashes when the turn signal switch is operated with the power mode in "ON" (models with passive entry and start system) or the starter switch in the "ON" position (models without passive entry and start system).

Both indicator lights flash when the hazard warning flasher switch is operated irrespective of the power mode (models with passive entry and start system) or the position of the starter switch (models without passive entry and start system).

For models with the emergency stop signal (ESS), both indicator lights flash while the ESS is operating.

**Turn Signal Switch**

→ Refer to page 4-124

**Hazard Warning Flasher Switch**

→ Refer to page 4-127

**Emergency Stop Signal (ESS)**

→ Refer to page 4-170

**ADVICE**

- These indicator lights will not flash if the bulbs are blown, or may flash abnormally if bulbs of incorrect wattage are used.

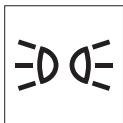
**Light Position Indicator Light**

This indicator light comes on when the light control switch is in the "AUTO" (with the headlights or taillights "ON"), "☰☺☻" or "☰☺" position.

**Light Control Switch**

→ Refer to page 4-117

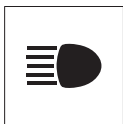
**High Beam Indicator Light**

This indicator light comes on when high beam is selected or the headlights are cycled between high and low beams (passing signal).

**Light Control Switch**

→ Refer to page 4-117

**Anti-Theft System Indicator Light**

This indicator light comes on or flashes when the anti-theft system starts operating.

**Anti-theft System** → Refer to page 3-8

**Front Fog Light Indicator Light**

This indicator light remains on while the front fog lights are on.

**Front Fog Light Switch**

→ Refer to page 4-126

**Rear Fog Light Indicator Light**

This indicator light stays on while the rear fog light is on.

**Rear Fog Light Switch**

→ Refer to page 4-126

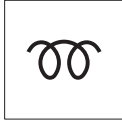
**Glow Plug Indicator Light**

This indicator light comes on in the following cases and goes out when the preheating of the glow plug is completed:

- If the power mode is switched to "ON" (models with passive entry and start system).
- If starting of the engine is attempted (models with passive entry and start system).
- If the starter switch is turned to the "ON" position (models without passive entry and start system).

**Starting the Engine**

→ Refer to page 4-4

**Rear Differential Lock Indicator Light**

This indicator light flashes when the rear differential lock switch "ON" and comes on when the rear differential lock is engaged. When the rear differential lock switch is turned off while this indicator light is on, the rear differential lock is disengaged and the indicator light turns off.

**Rear Differential Lock Switch**

→ Refer to page 4-128

## TCS OFF Indicator Light

A square icon with a thin black border containing the text "TCS OFF" in a bold, sans-serif font, stacked vertically.

When the TCS is canceled by pressing the ESC OFF switch, the TCS OFF indicator light on the instrument panel comes on. This indicator light also comes on when the 4WD switch is set to 4L (4WD low). When this indicator light does any of the following, the TCS function may be faulty. Please contact the nearest Isuzu Dealer.

- When the TCS OFF indicator light comes on during driving (when the ESC OFF switch is not operated).
- The TCS OFF indicator light does not turn on when the power mode is switched to "ON" (models with passive entry and start system) or the starter switch is turned to the "ON" position (models without passive entry and start system).

**Electronic Stability Control (ESC)**

→ Refer to page 4-162

**Four Wheel Drive (4WD) Model**

→ Refer to page 4-310

## ESC OFF Indicator Light



When the ESC is canceled by pressing the ESC OFF switch, the ESC OFF indicator light on the instrument panel comes on. This indicator light also comes on when the 4WD switch is set to 4L (4WD low). When the ESC OFF indicator light does any of the following, the function may be faulty. Please contact the nearest Isuzu Dealer.

- When the ESC OFF indicator light comes on during driving (when the ESC OFF switch is not operated).
- The ESC OFF indicator light does not turn on when the power mode is switched to "ON" (models with passive entry and start system) or the starter switch is turned to the "ON" position (models without passive entry and start system).

**Electronic Stability Control (ESC)**

→ Refer to page 4-162

**Four Wheel Drive (4WD) Model**

→ Refer to page 4-310

## BSM OFF Indicator Light

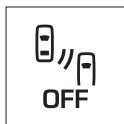

When the blind spot monitor (BSM) is turned off by using the user customization function on the MID, the BSM OFF indicator light on the instrument panel comes on.

This indicator light also comes on in the following cases.

- When the BSM or RCTA is not available due to an abnormality in another device or system in the vehicle.
- When the BSM or RCTA temporarily stops because the temperature of the radar sensors is extremely high or low, the warning message ("Radar unavailable") is displayed on the MID for approximately 5 seconds, and then this indicator light comes on.
- When the BSM or RCTA temporarily stops due to dirt on the radar sensors or other factors, the warning message ("Radar clean-up") is displayed on the MID for approximately 5 seconds, and then this indicator light comes on.
- When the BSM or the RCTA has malfunctioned, the warning message ("Radar failure") is displayed on the MID for approximately 5 seconds, and then this indicator light and the master warning light come on at the same time. In this case, contact the nearest Isuzu Dealer.

## Warning message

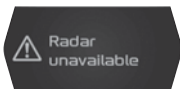

## Warning message

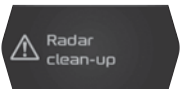

## Master warning light



## Warning message

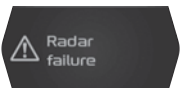

## Blind Spot Monitor (BSM)

→ Refer to page 4-179

## Rear Cross Traffic Alert (RCTA)

→ Refer to page 4-188

## Parking Aid System OFF Indicator Light



When the parking aid system is turned off by pressing the parking aid system OFF switch, the parking aid system OFF indicator light on the instrument panel comes on.

This indicator light also comes on in the following cases.

- When the parking aid system is not available due to an abnormality in another device or system in the vehicle.
- When the sonar sensor cannot operate normally due to noise or other factors and the parking aid system temporarily stops, the warning message ("Sonar unavailable") is displayed on the MID for approximately 5 seconds, and then this indicator light comes on.
- When the parking aid system temporarily stops due to dirt on the sonar sensors or other factors, the warning message ("Sonar clean-up") is displayed on the MID for approximately 5 seconds, and then this indicator light comes on.
- When the parking aid system has malfunctioned, the warning message ("Sonar failure") is displayed on the MID for approximately 5 seconds, and then this indicator light and the master warning light come on at the same time. In this case, contact the nearest Isuzu Dealer.

### Warning message

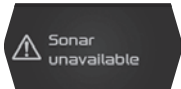

### Warning message



### Master warning light



### Warning message



### Parking Aid System

→ Refer to page 4-197

### Cruise Control Indicator Light

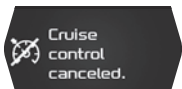

This indicator light comes on white when the cruise control main switch is pressed. This indicator light comes on green when the cruise control set switch is pressed. For models with the stereo camera, when the cruise control is canceled automatically by the system, this indicator light changes from green to white after "Cruise control canceled." is displayed on the MID for approximately 5 seconds. For models without the stereo camera, when the cruise control is canceled, this indicator light goes out after the "Cruise control canceled." is displayed on the MID for approximately 5 seconds.

**Cruise Control** → Refer to page 4-151

### Adaptive Cruise Control Indicator Light

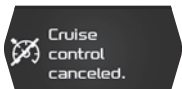

This indicator light comes on white when the adaptive cruise control is set. This indicator light comes on green when the adaptive cruise control activates. When the adaptive cruise control is canceled automatically by the system, this indicator light changes from green to white after "Cruise control canceled." is displayed on the MID for approximately 5 seconds.

**Adaptive Cruise Control (ACC)**

→ Refer to page 4-245

### Manual Speed Limiter Indicator Light



This indicator light comes on white when the manual speed limiter is set. This indicator light comes on green when the manual speed limiter activates.

**Manual Speed Limiter (MSL)**

→ Refer to page 4-270

**4WD Indicator Light**

When the 4WD switch is used to select "4H (4WD high)" or "4L (4WD low)", this indicator light comes on.

Whenever you use the 4WD switch, check that the 4WD indicator light has come on or gone out as expected before driving.

**4WD Switch** → Refer to page 4-311

**4WD Low Indicator Light**

When the 4WD switch is used to select "4L (4WD low)", this indicator light comes on.

Whenever you use the 4WD switch, check that the 4WD low indicator light has come on or gone out as expected before driving.

**4WD Switch** → Refer to page 4-311

**Hill Descent Control Indicator Light**

When the hill descent control switch is pressed and the hill descent control is activated, this indicator light will come on. When the hill descent control is operating, this indicator light flashes.

**Hill Descent Control**

→ Refer to page 4-172

**Automatic High Beam Indicator Light**

This indicator light comes on when the automatic high beam (AHB) activates.

**Automatic High Beam (AHB)**

→ Refer to page 4-306

**Autonomous Emergency Braking OFF Indicator Light**

This indicator light comes on when the autonomous emergency braking (AEB) is off.

This indicator light also comes on in the following cases.

- When the stereo camera system has malfunctioned
- When the stereo camera has been temporarily stopped

**NOTE**

- Even though the AEB is turned off, the AEB will be turned on after the engine start/stop button (models with passive entry and start system) or the starter switch (models without passive entry and start system) is set to "OFF" to stop the engine, and then set to "ON" again.
- While this indicator light is on, the AEB and pedal misapplication mitigation do not operate.

**Autonomous Emergency Braking (AEB)**

→ Refer to page 4-226

**Pedal Misapplication Mitigation**

→ Refer to page 4-239

**Lane Departure Warning OFF Indicator Light**

This indicator light comes on when the lane departure warning (LDW) system is off.

**Lane Departure Warning (LDW)**

→ Refer to page 4-273

**Emergency Lane Keeping OFF Indicator Light**

This indicator light comes on when the emergency lane keeping (ELK) system is off.

**Emergency Lane Keeping (ELK)**

→ Refer to page 4-287

**TPMS Loading Indicator Light**

This indicator comes on when the TPMS load selector switch is pressed and the standard tire air pressure is changed to that for a loaded vehicle. Press the switch again to turn it off and change to the standard tire air pressure for an unloaded vehicle.

**Tire Pressure Monitoring System (TPMS)**

→ Refer to page 4-319

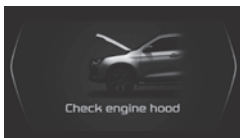
**Engine Hood Open Warning Light****Models with MID**

When the engine hood is open or not completely closed, this message is displayed.

## Light Control OFF Warning Light

**Models with MID**

This message appears on the display when the lights are on while all the following conditions are met.

- The light control switch is placed in the "OFF" or "LOCK" position.
- The power mode is "OFF" (models with passive entry and start system) or the starter switch is in the "LOCK" position (models without passive entry and start system).
- The driver side door is open.

A warning buzzer sounds at the same time. When the light control switch is placed in the "OFF" position, the warning light will go out and the warning buzzer will stop sounding.

**Warning Buzzer** → Refer to page 4-106

## Key Remain Warning Light

**Models with MID**

In models without a passive entry and start system, this message appears on the display when the starter switch is placed in the "ACC" or "LOCK" position and the driver's door is opened when the key has not been removed. A warning buzzer will sound at the same time. When the key is removed, the warning light will go out and the warning buzzer will stop sounding.

**Warning Buzzer** → Refer to page 4-106

**No Electronic Key Warning Light****Models with Passive Entry and Start System**

This message appears on the display in the following cases:

- If locking of an unlocked door is attempted with the electronic key not within operating range for locking and unlocking the doors.
- If the electronic key is carried outside the vehicle and then the doors are closed with the power mode in "ACC" or "ON".
- If the power mode is "OFF" and the engine start/stop button is pushed with the electronic key not within operating range for starting the engine.

At this time, the warning buzzer will sound.

**NOTE**

- Even when the electronic key is within the operating range for locking and unlocking the doors, this warning light may be displayed due to radio wave conditions. Also, even when the electronic key is within the operating range for starting the engine, this warning light may be displayed if the key is located above the instrument panel, in storage areas such as the glove box or door pocket, as well as under the seat or on the floor in front of the driver and passenger seats.
- If the vehicle battery is weak or the voltage is low, this warning light may be displayed when the request switch on the door handle is pressed, or when the engine start/stop button is pushed. In this case, check the vehicle's battery.
- If the electronic key is passed through an open window and carried outside of the vehicle, this warning light will not be displayed.

**Passive Entry and Start System**

→ Refer to page 3-17

**Warning Buzzer** → Refer to page 4-106

**Handling the Battery**

→ Refer to page 6-115

**Steering Wheel Lock Not Released Warning Light****Models with Passive Entry and Start System**

This message appears on the display if the steering wheel lock is not released even though the engine start/stop button is pushed.

At this time, the warning buzzer will sound and the engine start/stop button indicator light will flash in green.

**Passive Entry and Start System**

→ Refer to page 3-17

**Warning Buzzer** → Refer to page 4-106

**Engine Start/Stop Button (Models with Passive Entry and Start System)**

→ Refer to page 4-112

## Shift Position Warning Light

### Manual transmission model



### Automatic transmission model



### Models with Passive Entry and Start System

This message appears on the display in the following cases:

- If the electronic key is carried outside the vehicle and then the doors are closed with the power mode in "OFF" and the selector lever in a position other than "P" (automatic transmission model).
- If the selector lever is moved to a position other than "P" with the driver side door open (automatic transmission model).
- If starting of the engine is attempted by pushing the engine start/stop button with the selector lever in a position other than "P" or "N" (automatic transmission model).
- If starting of the engine is attempted by pushing the engine start/stop button with the gearshift lever in a position other than "N" (manual transmission model).
- If an attempt to switch the power mode from "ON" to "OFF" is made with the selector lever in a position other than "P" (automatic transmission model).

At this time, the warning buzzer will sound.

### Passive Entry and Start System

→ Refer to page 3-17

Warning Buzzer → Refer to page 4-106

### Turn Off the Power Warning Light



#### Models with Passive Entry and Start System

This message appears on the display if door locking is attempted by pressing the request switch on the door handle or the lock button on the electronic key while the power mode is in "ON" or "ACC". In this case, the doors will not lock.

At this time, the warning buzzer will sound.

#### Passive Entry and Start System

→ Refer to page 3-17

Warning Buzzer → Refer to page 4-106

#### Engine Start/Stop Button (Models with Passive Entry and Start System)

→ Refer to page 4-112

### Low Battery Electronic Key Warning Light

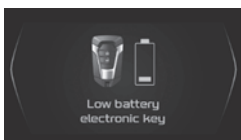

#### Models with Passive Entry and Start System

This message appears on the display if the battery voltage of the electronic key is low when the power mode is switched from "ON" to "OFF" (or "ACC").

At this time, the warning buzzer will sound.



#### NOTE

- If this warning light is displayed, the passive entry and start system may not function. Replace the electronic key battery as soon as possible. If the passive entry and start system does not function, use the mechanical key for locking and unlocking the doors and use the electronic key for starting the engine (refer to "When the Electronic Key Battery Goes Flat").

#### Passive Entry and Start System

→ Refer to page 3-17

#### Replacing the Battery in the Remote Control Unit

→ Refer to page 3-12

Warning Buzzer → Refer to page 4-106

#### When the Electronic Key Battery Goes Flat

→ Refer to page 7-7

## Check System Warning Light



### Models with Passive Entry and Start System

This message appears on the display if an error occurs to the passive entry and start system when door locking is attempted by pressing the request switch on the door handle or by pushing the engine start/stop button.

At this time, the following may occur:

- The warning buzzer will sound.
- The key monitor warning light may come on.
- The engine start/stop button indicator light may flash.



### ADVICE

- If the warning light comes on repeatedly or remains on, have the vehicle inspected/serviced at the nearest Isuzu Dealer as soon as possible.



### NOTE

- If this warning light is displayed, the passive entry and start system function cannot be used.
- This warning light may also be displayed if the fuse is blown.

### Passive Entry and Start System

→ Refer to page 3-17

### Key Monitor Warning Light

→ Refer to page 4-85

### Engine Start/Stop Button (Models with Passive Entry and Start System)

→ Refer to page 4-112

### Warning Buzzer → Refer to page 4-106

### Emergency Engine Starting (Models with Passive Entry and Start System)

→ Refer to page 7-11

### Replacing the Fuses and Relays

→ Refer to page 7-24

### Power Management System Warning Light



#### Models with Passive Entry and Start System

This message appears on the display if an error occurs to the power management system when the engine start/stop button is pushed. At this time, the warning buzzer will sound and the key monitor warning light will come on.



#### ADVICE

- If the warning light comes on repeatedly or remains on, have the vehicle inspected/serviced at the nearest Isuzu Dealer as soon as possible.

#### Passive Entry and Start System

→ Refer to page 3-17

#### Key Monitor Warning Light

→ Refer to page 4-85

Warning Buzzer → Refer to page 4-106

### Steering Wheel Lock System Warning Light

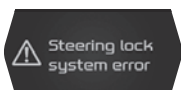

#### Models with Passive Entry and Start System

This message appears on the display if an error occurs to the steering wheel lock system when the engine start/stop button is pushed. At this time, the warning buzzer will sound and the key monitor warning light will come on.



#### ADVICE

- If the warning light comes on repeatedly or remains on, have the vehicle inspected/serviced at the nearest Isuzu Dealer as soon as possible.

#### Passive Entry and Start System

→ Refer to page 3-17

#### Key Monitor Warning Light

→ Refer to page 4-85

Warning Buzzer → Refer to page 4-106

### Accessory Mode Indicator Light

#### Manual transmission model



#### Automatic transmission model



#### Models with Passive Entry and Start System

This message appears on the display when the power mode is in "ACC". If the driver side door is opened with the power mode in "ACC", the warning buzzer will sound.

#### Passive Entry and Start System

→ Refer to page 3-17

Warning Buzzer → Refer to page 4-106

### Low Battery Engine Starting Indicator Light



#### Manual transmission model

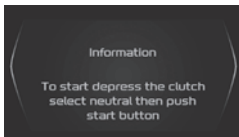

#### Automatic transmission model



#### Models with Passive Entry and Start System

This message appears on the display when the electronic key battery goes flat.

#### Passive Entry and Start System

→ Refer to page 3-17

#### When the Electronic Key Battery Goes Flat

→ Refer to page 7-7

## Warning Buzzer

A warning buzzer sounds under the following conditions.

Warning	Buzzer pattern	Condition
Engine overheat	Continuous beep	When the engine overheats.
Key remain (models without passive entry and start system)	Short repeated beeps	When the driver's door is opened if the key has not been removed and the starter switch is in the "ACC" or "LOCK" position.
Light control OFF	Short repeated beeps (models with MID)	When the lights are on while all the following conditions are met. <ul style="list-style-type: none"> <li>• The light control switch is placed in the "OFF" or "LOCK" position.</li> <li>• The power mode is "OFF" (models with passive entry and start system) or the starter switch is in the "LOCK" position (models without passive entry and start system).</li> <li>• The driver side door is open.</li> </ul>
	Continuous beep (models with LCD)	
Parking brake release	Short repeated beeps	When the vehicle speed exceeds approximately 5 km/h (3.1 MPH) during driving with the parking brake engaged.
Front seat belt (Driver seat)*	Short repeated beeps	When the vehicle speed exceeds approximately 20 km/h (12 MPH) during driving with the seat belt unfastened.
Front seat belt (Front passenger seat)*	Short repeated beeps	When the vehicle speed exceeds approximately 20 km/h (12 MPH) during driving with the seat belt unfastened.
Second seat belt	Short repeated beeps	When the vehicle speed exceeds approximately 20 km/h (12 MPH) during driving with the second seat belt unfastened.
Automatic transmission	Three repeated beeps	When the transmission is shifted to a low gear while the vehicle speed is too fast. When the transmission is shifted to a high gear while the vehicle speed is too slow.
Reverse shift	Three repeated beeps	When the gearshift lever is placed in the "R (reverse)" position.

\* : Models with lateral airbags.

Warning	Buzzer pattern	Condition
4WD	Short repeated beeps	When the vehicle speed, engine speed, gearshift lever (manual transmission models) or the selector lever (automatic transmission models) position, or clutch pedal operating condition (manual transmission models) conflict with the changing conditions or when changing is not possible due to a 4WD system abnormality.
Door open while driving	Continuous beep	If the doors open while the vehicle is being driven at speeds of 5 km/h (3 MPH) or more.
No electronic key (models with passive entry and start system)	Short repeated beeps (external buzzer)	If locking of an unlocked door is attempted with the electronic key not within operating range for locking and unlocking the doors.
	Short repeated beeps (in-vehicle buzzer)	If the electronic key is carried outside the vehicle and then the doors are closed with the power mode in "ACC" or "ON".
	Short repeated beeps (external buzzer)	
Shift position (models with passive entry and start system)	Three repeated beeps (in-vehicle buzzer)	If the power mode is "OFF" and the engine start/stop button is pushed with the electronic key not within operating range for starting the engine.
	Continuous beep (external buzzer)	If the electronic key is carried outside the vehicle and then the doors are closed with the power mode in the "OFF" and the selector lever in a position other than "P" (automatic transmission model).
	Short repeated beeps (in-vehicle buzzer)	If the selector lever is moved to a position other than "P" with the driver side door open (automatic transmission model).
	Three repeated beeps (in-vehicle buzzer)	If starting of the engine is attempted by pushing the engine start/stop button with the selector lever in a position other than "P" or "N" (automatic transmission model).
	Three repeated beeps (in-vehicle buzzer)	If starting of the engine is attempted by pushing the engine start/stop button with the gearshift lever in a position other than "N" (manual transmission model).
Steering wheel lock not released (models with passive entry and start system)	Three repeated beeps (in-vehicle buzzer)	If an attempt to switch the power mode from "ON" to "OFF" is made with the selector lever in a position other than "P" (automatic transmission model).
	Three repeated beeps (in-vehicle buzzer)	If the steering wheel lock is not released even though the engine start/stop button is pushed.

Warning	Buzzer pattern	Condition
Door open (models with passive entry and start system)	Short repeated beeps (external buzzer)	If door locking is attempted by pressing the request switch on the door handle or the lock button on the electronic key when the doors are open.
Turn off the power (models with passive entry and start system)	Short beep (external buzzer)	If door locking is attempted by pressing the request switch on the door handle or the lock button on the electronic key with the power mode is in "ON" or "ACC".
Low battery electronic key (models with passive entry and start system)	Three repeated beeps (in-vehicle buzzer)	If the battery voltage of the electronic key is low when the power mode is switched from "ON" to "OFF" (or "ACC").
Check system (models with passive entry and start system)	Three repeated beeps (in-vehicle buzzer) Continuous beep (in-vehicle buzzer)	If an error occurs to the passive entry and start system when door locking is attempted by pressing the request switch on the door handle or by pushing the engine start/stop button.
	Short beep (external buzzer) Continuous beep (external buzzer)	
Power management system (models with passive entry and start system)	Three repeated beeps (in-vehicle buzzer)	If an error occurs to the power management system when the engine start/stop button is pushed.
Steering wheel lock system (models with passive entry and start system)	Three repeated beeps (in-vehicle buzzer)	If an error occurs to the steering wheel lock system when the engine start/stop button is pushed.
Accessory mode (models with passive entry and start system)	Short repeated beeps (in-vehicle buzzer)	If the driver side door is opened with the power mode in "ACC".
Lockout prevention (models with passive entry and start system)	Short repeated beeps (external buzzer)	If door locking is attempted by pressing the request switch on the door handle when the electronic key is within operating range for starting the engine.
Key left prevention (models with passive entry and start system)	Short repeated beeps (external buzzer)	When a door handle is used to do a lock operation while the key is inside the vehicle.

Warning	Buzzer pattern	Condition
Rear cross traffic alert (RCTA)	Short repeated beeps	When the vehicle is being reversed and approaches another vehicle to the rear right or rear left (When the RCTA is on).
Parking aid system	Short repeated beeps	When the obstacle is close to the vehicle while parking (When the parking aid system is on). As the distance between the vehicle and the obstacle decreases, the interval between beeps gradually becomes shorter until the beeping becomes continuous when the obstacle is too close.
	Continuous beep	
Autonomous emergency braking (AEB)	Short repeated beeps	When the system determines that the front obstacle may collide with your vehicle.
	Continuous beep	When the system determines that there is a high possibility of a collision with the front obstacle while driving.
Pedal misapplication mitigation	Short repeated beeps	When the system determines that the accelerator pedal is depressed more than needed, while the vehicle is stopped or moving slowly and the camera recognizes an obstacle in front of the vehicle.
Adaptive cruise control (ACC)	Two repeated beeps	When the ACC is canceled automatically by the system.
	Short repeated beeps	When the system determines that the vehicle speed needs to be reduced manually by the driver.
Lane departure warning (LDW)	Short repeated beeps	When the system determines that your vehicle seems to be departing from its lane.
Attention assist	Short repeated beeps	When the system detects that the vehicle is weaving.
Lane keep assist system (LKAS)	Short repeated beeps	When the steering wheel is not operated for more than 20 seconds while the lane keep assist system is operating.
	Continuous beep	When the steering wheel is not operated for more than 25 seconds while the lane keep assist system is operating.
Emergency lane keeping (ELK)	Short repeated beeps	When the ELK is supporting the prevention of collisions by assisting steering operations.
Speed limiter (MSL)	Short repeated beeps	When the vehicle speed exceeds the set speed by approximately 5 km/h (3 MPH).

**ADVICE**

- The warning buzzer may not sound if there is a problem with the system. If this occurs, the system needs to be inspected. Please contact the nearest Isuzu Dealer.

## SWITCHES

• Engine Start/Stop Button (Models with Passive Entry and Start System)	4-112
• Starter Switch (Models without Passive Entry and Start System)	4-115
• Combination Light Control Switch	4-117
• Headlight Leveling Switch	4-125
• Front Fog Light Switch	4-126
• Rear Fog Light Switch	4-126
• Hazard Warning Flasher Switch	4-127
• Rear Differential Lock Switch	4-128
• Windshield Wiper and Windshield Washer Switch	4-131
• Horn Button	4-137
• Remote Control Mirror Switch	4-138
• Retractable Power Mirror Switch	4-139
• Illumination Control Switch	4-140
• Rear Window Defogger Switch	4-140

### Engine Start/Stop Button (Models with Passive Entry and Start System)

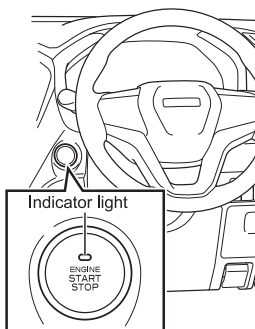

This button is used to start/stop the engine and switch the power mode.

To change the power mode, push the engine start/stop button when the brake pedal (models with automatic transmission) or clutch pedal (models with manual transmission) is not depressed and while the electronic key is on your person. The power mode will switch from "OFF" to "ACC" to "ON" in that order each time the button is pushed.

- OFF : In this mode, the steering wheel will be locked to help prevent theft.
- ACC : In this mode, the audio and other accessories can be used with the engine stopped.
- ON : The power mode stays in this mode while the engine is running.  
All electrical components can be used.

→ : Push the engine start/stop button

➡ : Push the engine start/stop button (selector lever is in "P")

••▶ : Push the engine start/stop button (selector lever is other than "P")

Power mode	Manual transmission model (clutch pedal is not depressed)	Automatic transmission model (brake pedal is not depressed)
OFF		
ACC		
ON		



**ADVICE**

- Do not touch the engine start/stop button with hands dirtied with oil, etc.
- Take care not to spill drinks, etc., on the button. If such spillages should occur, immediately contact your nearest Isuzu Dealer.
- When the engine start/stop button is stuck, do not attempt to operate the button, but instead immediately contact your nearest Isuzu Dealer.

**NOTE**

- By using the passive entry and start system to verify the electronic key, the engine can be started and the power mode can be switched.
- The power mode may not change if the engine start/stop button is pressed rapidly. Push the button carefully until the desired power mode is reached.
- In automatic transmission models, the power mode cannot be switched to "OFF" unless the selector lever is placed in the "P" position.
- The engine start/stop button indicator light will turn on in yellow if the power mode is in "ACC" or "ON".
- When the power mode is "ACC", "Accessory mode" will be displayed in the MID.
- The battery power saving function will operate and the power mode will switch to "OFF" when 60 minutes have passed with the power mode in "ACC". When this happens, the doors will unlock. The settings for the battery power saving function and the unlock function can be changed. To change the settings, please contact your Isuzu Dealer.
- When the power mode is "ON", the instrument panel will be illuminated.
- If the power mode is switched from "ON" to "OFF" and the driver side door is opened or closed while the vehicle is stopped, the steering wheel lock will activate.
- If the engine start/stop button is pushed while the vehicle is stopped and the power mode is "OFF", the steering wheel lock will be deactivated.
- If the engine start/stop button illumination does not come on even though the light control switch is operates, contact your nearest Isuzu Dealer.
- When the engine start/stop button indicator light flashes in green after an attempt to start the engine has been made, the engine will not be able to be started due to the steering wheel lock not be unlocked. Try starting the engine again while turning the steering wheel to the right and left.

### Starter Switch (Models without Passive Entry and Start System)

#### WARNING

- While driving, never turn the starter switch to the "LOCK" position. The key could be removed from the switch, which then locks the steering wheel. This is extremely dangerous.

#### ADVICE

- Using a key sticking with dirt or dust, etc. may possibly damage the starter switch. Make sure to wipe off any dirt or dust, etc. before inserting the key.
- After starting the engine, do not turn the starter switch to the "START" position. Otherwise, the starter motor may be damaged.
- Using electrical devices such as the audio system for an extended time period with the engine stopped can completely discharge the battery.

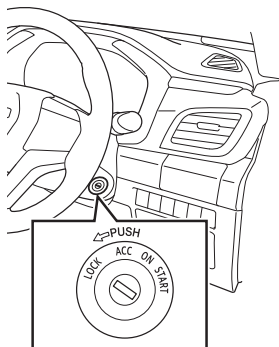

- LOCK** : In this position, the key can be inserted or removed.  
Remove the key and turn the steering wheel until it locks. The steering wheel will be locked to help prevent theft. To place the starter switch in the "LOCK" position, press and hold the key in the "ACC" position and then turn it to the "LOCK" position.
- ACC** : In this position, the audio and other accessories can be used with the engine stopped.
- ON** : The key stays in this position while the engine is running. All electrical components can be used.  
This position is also used for preheating before starting the engine.
- START** : The engine is started in this position. Release the key as soon as the engine has started. The key automatically returns to the "ON" position.

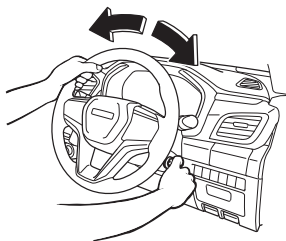
**NOTE**

- If the key cannot be turned from the "LOCK" position to the "ON" position, lightly move the steering wheel clockwise and counterclockwise while trying to turn the key.
- In automatic transmission models, the key cannot be removed from the starter switch unless the selector lever is placed in the "P" position.

## Combination Light Control Switch

Combination light control switch

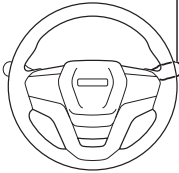

The combination light control switch is located at the position shown in the diagram.

## Light Control Switch

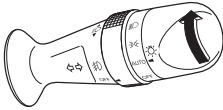

Light position indicator light

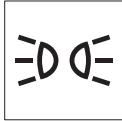

Turning the light control switch to the position indicated in the table causes the relevant lights to illuminate.

When lights come on, the light position indicator light located on the instrument panel comes on.





### ADVICE

- Each light will come on regardless of the power mode (models with passive entry and start system) or position of the starter switch (models without passive entry and start system). Do not operate the combination lights for an extended time period with the engine stopped. Otherwise, the battery may go flat, making it impossible to restart the engine.



### NOTE

- When repeatedly turning the headlight bulbs on and off frequently, the service life of the headlight bulbs will be reduced.
- For models with LED headlight, the clearance light also functions as the daytime running light. The way they function depends on the driving situation.

Name	Position			
	OFF	AUTO		
Headlight	Off	On/Off *2	Off	On
Clearance light (halogen headlight model)			On	
Taillight				
License plate light				
Illumination light control				
Clearance light/daytime running light (LED headlight model)	On *1	On *1 *3	On *1	On *5
Daytime running light (halogen headlight model)	On *1	On/Off *1 *4	On *1	Off

- \*1: The lights function as daytime running lights when the following conditions are met.  
 1) The engine has been started. 2) The selector lever is placed in any position other than the "P" position (only for automatic transmission models). 3) The parking brake has been released.
- \*2: When the power mode is "ON" (models with passive entry and start system) or the starter switch is in the "ON" position (models without passive entry and start system), the lights come on or go out automatically depending on the brightness outside the vehicle.
- \*3: When the light control switch is in the "AUTO" position and the headlights are off, the lights function as the daytime running lights. When the headlights are on, the lights function as clearance lights and dim more than when functioning as the daytime running lights.
- \*4: When the light control switch is in the "AUTO" position and the clearance lights are off, the daytime running lights come on. When the clearance lights are on, the daytime running lights go out.
- \*5: When the light control switch is in the  position, the lights will become dimmer than when the switch is in the "OFF" position and function as clearance lights.

**Models with Automatic Headlight**

Automatic headlight can be used when the power mode is "ON" (models with passive entry and start system) or the starter switch is in the "ON" position (models without passive entry and start system). When the light control switch is in the "AUTO" position, the lights come on or go out automatically depending on the brightness outside the vehicle.

Name	Brightness outside the vehicle		
	Bright	Dim	Dark
Headlight	Off	Off	On
Clearance light/taillight/license plate light	Off	On	On

The settings of the automatic headlight can be changed by using the user customization function on the MID.

**Settings (User Customization Function)**

→ Refer to page 4-47

Display indication		Description
Light	Auto light sensitivity	0
		1
		2
		3
		The sensitivity of the automatic headlight can be set to 4 levels: 0 (low) - 3 (High)



**NOTE**

- When the light control switch is in the "AUTO" position, if the outside of the vehicle is dark (inside a long tunnel, congestion in a tunnel, indoor parking lot etc.), the lights may not go out immediately even after the outside of the vehicle becomes brighter. In this case, the lights will go out when the light control switch is turned to the "OFF" position.

NOTE (Continued)

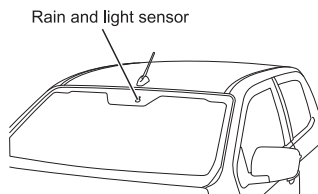
**NOTE (Continued)**

- Even when the visibility is poor due to fog, snow, etc., if the outside of the vehicle is bright with the daylight or due to other conditions, the lights may not come on even when the light control switch is in the "AUTO" position. If the lights do not come on, turn on the lights manually for safety.
- Do not put stickers or labels etc. on the windshield in such a way that they cover the rain and light sensor. Otherwise, the sensor cannot accurately sense the brightness outside the vehicle. The sensor is at the top of the windshield.
- If an abnormality occurs in the rain and light sensor and the light control switch is set to the "AUTO" position, the headlights will automatically come on regardless of the brightness of the outside. In this case, contact the nearest Isuzu Dealer.
- When the temperature of the rain and light sensor is extremely high or low, the automatic headlight may not operate properly.

### Models with Headlight Battery Saver

This is a function to turn off the lights automatically to prevent the battery from going flat. When the power mode is "OFF" (models with passive entry and start system) or the starter switch is in the "LOCK" position (models without passive entry and start system) and the lights are on (the light control switch is in the "OFF" or "LOCK" position), then the lights go out automatically when any of the following conditions are met.

- When the driver side door is opened.
- When all of the doors are locked using the passive entry and start system or remote control unit (models with passive entry and start system and keyless entry system).

The settings of the headlight battery saver can be changed. Contact the nearest Isuzu Dealer for details.

In models with an MID, the settings of the headlight battery saver can be changed by using the user customization function on the MID.

#### Settings (User Customization Function)

→ Refer to page 4-47

Display indication		Description	
Light	Headlight battery saver	Enable	Turns on the headlight battery saver.
		Disable	Turns off the headlight battery saver.



#### NOTE

- When the light switch is in the "AUTO" position, if the power mode is switched to "OFF" (models with passive entry and start system) or the starter switch is turned to the "LOCK" position (models without passive entry and start system), the lights go out automatically.
- Do one of the following operations to turn on the lights again.
  - Switch the power mode to "ON" (models with passive entry and start system) or turn the starter switch to the "ON" position (models without passive entry and start system). For models with the remote engine start system, when the engine is started by the remote engine start system, the lights do not come on again.
  - Set the light control switch to the "OFF" position, and then set it to the "OFF" or "LOCK" position again.

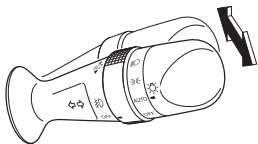

High beam indicator light

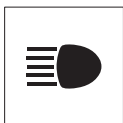

### Switching between High Beam and Low Beam

With the headlights on, move the light control switch lever forward and backward to switch between the high beam and low beam.

Moving the lever forward selects high beam; moving the lever backward selects low beam.

While the headlights are on high beam, the high beam indicator light on the instrument panel remains on.

### When the Light Does Not Come On

→ Refer to page 7-24

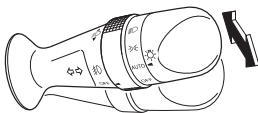

High beam indicator light

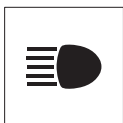

### Switching between High and Low Beams (Flash-to-Pass Signal)

By lightly pulling the light control switch lever and releasing it, the high beam comes on and off. At the same time, the high beam indicator light on the instrument panel comes on and off. Use this function as a signal for flash-to-pass a vehicle or other purposes.

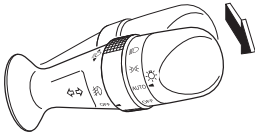

Light position indicator light

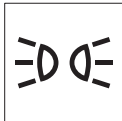

High beam indicator light

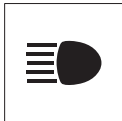

**Models with Coming Home Light**

This function turns on the headlights (low beam) and clearance lights to enhance safety after leaving the vehicle.

When the power mode is "OFF" (models with passive entry and start system) or the starter switch is in the "LOCK" position (models without passive entry and start system) and the light control switch is set to the "OFF" or "AUTO" position, the headlights and clearance lights turn on for approximately 30 seconds if the light control switch lever is pulled lightly.

When lights come on, the light position indicator light and the high beam indicator light located on the instrument panel come on.

The settings of the coming home light can be changed. Contact the nearest Isuzu Dealer for details.

In models with an MID, the settings of the coming home light can be changed by using the user customization function on the MID.

**Settings (User Customization Function)**

→ Refer to page 4-47

Display indication		Description	
Light	Coming home light	Enable	Turns on the coming home light.
		Disable	Turns off the coming home light.



**NOTE**

- Do one of the following operations while the lights are on to turn off the lights.
  - Move the lever forward again.
  - Switch the power mode to "ON" (models with passive entry and start system) or turn the starter switch to the "ON" position (models without passive entry and start system). For models with the remote engine start system, when the engine is started by the remote engine start system, the lights do not go out.

## Turn Signal Switch

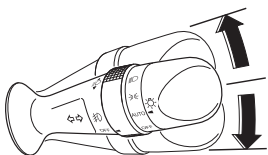

Turn signal indicator light

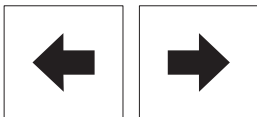

When turning left or right, move the light control switch lever up or down to flash the turn signal light.

The turn signal indicator light on the instrument panel flashes while the turn signal lights are flashing.



## ADVICE

- The turn signal lights come on when the power mode is "ON" (models with passive entry and start system) or the starter switch is in the "ON" position (models without passive entry and start system). Do not operate the turn signal lights for an extended time period with the engine stopped. Otherwise, the battery may go flat, making it impossible to start the engine.



## NOTE

- If the steering wheel is only turned a small amount, turn off the signal manually.
- Lightly press and hold the lever up or down when overtaking or changing lanes.

## Models with Comfort Turn Signal Light

This is a function to flash the turn signal light three times. Moving the light control switch lever slightly up or down and releasing it immediately flashes the turn signal light three times.

The settings of the comfort turn signal light can be changed. Contact the nearest Isuzu Dealer for details.

In models with an MID, the settings of the comfort turn signal light can be changed by using the user customization function on the MID.

## Settings (User Customization Function)

→ Refer to page 4-47

Display indication		Description
Light	Comfort turn signal	Enable
		Disable

**NOTE**

- To turn off the turn signal light while it is flashing, move the lever slightly up or down again.

## Headlight Leveling Switch

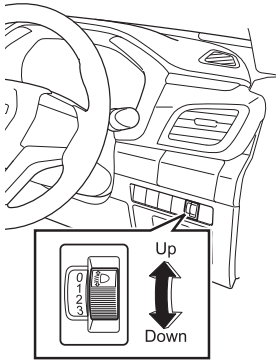

The headlight aim can be adjusted at four different angles. When the cargo load causes the headlights to aim upwards, this feature can be used to lower the aiming angle.

When your vehicle is not loaded with cargo, the switch should be set at the uppermost position. ("0" position)

Make adjustments in accordance with the following table.

**CAUTION**

- Do not lower the aiming angle too much. Otherwise, the illuminated range may be so reduced that you may be involved in an accident.

Position	Load
0	No Load.
1	When loaded to about 300 kg (660 lb).
2	When loaded to about 650 kg (1,430 lb).
3	When loaded up to the maximum.

### Front Fog Light Switch

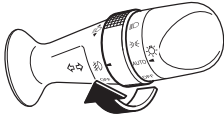

Front fog light indicator light



When the light control switch is placed in the "AUTO" (with the taillights "ON"), "☰☐", or "☷☐" position, turning this switch to the "☷" position turns on the front fog lights. Also, the front fog light indicator light comes on. To turn off the lights, place the switch in the "OFF" position. When the taillights are automatically turned off while the light control switch is in the "AUTO" position, the front fog lights turn off at the same time. The front fog lights are useful when forward visibility is poor such as in fog.

### Rear Fog Light Switch

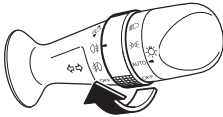

Rear fog light indicator light



When the light control switch is placed in the "AUTO" (with the headlights "ON") or "☷☐" position, turning this switch to the "☷" position turns on the rear fog lights. Also, the rear fog light indicator light comes on. When this switch is turned to the "☷" position again, the rear fog lights turn off. When the headlights are automatically turned off while the light control switch is in the "AUTO" position, the rear fog light turns off at the same time. Use this light in low visibility such as in fog.



#### CAUTION

- When this switch is turned to the "☷☐" position while the rear fog lights are on, the lights turn off. Turn on the lights again as necessary.

## Hazard Warning Flasher Switch

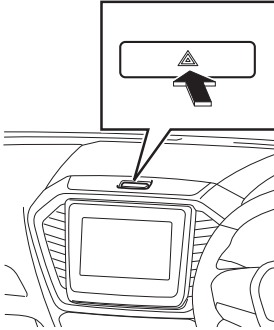

Turn signal indicator light

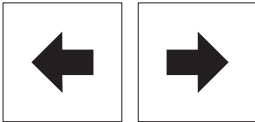

The hazard warning flasher is used to signal other vehicles that your vehicle is stationary on the road because of an accident or component failure.

With the power mode in any mode (models with passive entry and start system) or the starter switch in any position (models without passive entry and start system), when this switch is pressed, all of the turn signal lights and the turn signal indicator lights flash to signal an emergency. To turn off the hazard lights, press the switch again.



### ADVICE

- Do not leave the hazard warning flasher operating for an extended time period with the engine stopped. Otherwise, the battery may go flat, making it impossible to restart the engine.



### NOTE

- If you operate the hazard warning flasher switch while the emergency stop signal (ESS) is operating, the ESS stops operating and the hazard warning flashers flash normally.

## Rear Differential Lock Switch

### Manual transmission model

#### Type 1

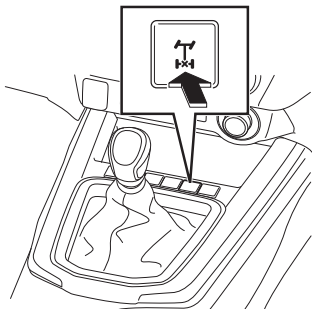

To engage the differential lock, press the rear differential lock switch.

The rear differential lock indicator light comes on.

To disengage the differential lock, press the rear differential lock switch.

The rear differential lock indicator light goes out.

#### Type 2

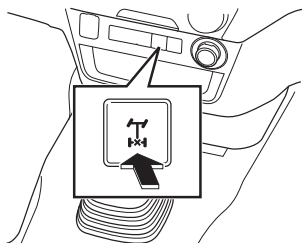

### Automatic transmission model

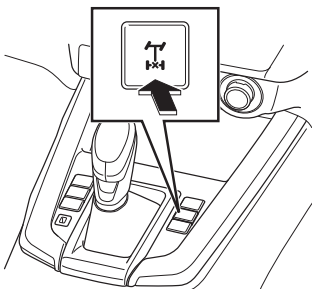

**Rear differential lock indicator light (Green)****Rear differential lock failure warning light (Yellow)****⚠ WARNING**

- Use the rear differential lock only in case of emergency, such as when the wheels on one or both sides of the rear axle are on a muddy or sandy surface, an icy slope, or some other kind of slippery road.

**⚠ CAUTION**

- The differential may develop a problem if the rear wheels are allowed to spin repeatedly without using the differential lock.
- With the differential lock engaged, the turning radius of the vehicle increases.
- Do not engage the differential lock unless needed. Use of differential lock on dry pavement hastens tire wear, increases noise and vibration, and can cause damage to the differential lock system.
- Driving on paved roads while the differential lock is engaged could result in damage. The differential lock is automatically re-engaged when the vehicle speed drops after the differential lock is disengaged. Do not forget to disengage the differential lock when driving on paved roads.

**ADVICE**

- Even if the rear differential lock switch is pressed, the differential lock may not engage/disengage immediately. If this happens, move the vehicle forward and backward and turn the steering wheel to the left and right.
- If the rear differential lock switch has some problems, the rear differential lock failure indicator light comes on. If the rear differential lock failure warning light comes on, contact the nearest Isuzu Dealer.

**NOTE**

- The differential lock is not engaged when the vehicle speed is more than 30 km/h (19 MPH). In this case, the rear differential lock indicator light flashes 3 times and goes out.
- Once the differential lock is engaged, the following should be noted.
  - The differential lock is disengaged when the vehicle speed is above 40 km/h (25 MPH), but the differential lock request remains active until the vehicle speed is up to 60 km/h (37 MPH). At this time, the rear differential lock indicator light flashes.
  - If the vehicle speed reduces before reaching 60 km/h (37 MPH), the differential lock is automatically engaged again when the vehicle speed is below 30 km/h (19 MPH).
  - If the vehicle speed exceeds 60 km/h (37 MPH), the differential lock request becomes inactive. To reactive the differential lock, press the rear differential lock switch.
- The differential lock is disengaged when the power mode is changed from "OFF" to "ON" (models with passive entry and start system) or the starter switch is changed from "OFF" to the "ON" position (models without passive entry and start system).
- The differential lock is not engaged if there is a large wheel speed difference between rear wheels (for example, one wheel is standing still and the other is turning at high speed). This is designed to protect the locking mechanism. Take your foot off the accelerator pedal to engage the differential lock.

NOTE (Continued)

## NOTE (Continued)

- The following functions do not operate when the rear differential lock switch is on.
  - Anti-lock brake system (ABS)
  - Electronic stability control (ESC)
  - Emergency stop signal (ESS)
  - Traction control system
  - Trailer sway control
  - Brake assist function
  - Hill start assist
  - Hill descent control
- In addition, the following warning lights or indicator lights come on at this time.
  - ABS warning light
  - ESC warning light
  - TCS OFF indicator light
  - ESC OFF indicator light
- If the rear differential lock indicator light remains on after the rear differential lock switch is pushed to disengage, it means that the differential lock is still engaged. To correct this condition, drive the vehicle in reverse for a short distance. Then go forward until the rear differential lock indicator light goes out. The vehicle can be driven as normal. If the rear differential lock indicator light is still on, consult your Isuzu Dealer as soon as possible.

**Windshield Wiper and Windshield Washer Switch**

Windshield wiper and windshield washer switch

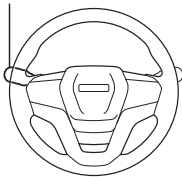

The windshield wiper and windshield washer switch is located at the position shown in the diagram.

To use the windshield wiper and washer switches, the power mode must be "ON" (models with passive entry and start system) or the starter switch must be in the "ON" position (models without passive entry and start system).



## ADVICE

- Clear ice or packed snow from the wiper blades before using the wipers.
- Before operating the wiper, ensure that the wiper rubber is not stuck on to the windshield. If the wiper rubber is stuck to the windshield and you still operate the wiper, the wiper may break or the wiper motor may fail.
- Do not operate the wiper on a dry windshield surface. Otherwise, the windshield surface may sustain damage. Always use the windshield washer when wiping a dry glass surface.
- The safety system may work to stop the wiper when excessive load is applied on the motor. In this case, turn the switch to the "OFF" position and, a few minutes later, check to see if the wiper is back to normal operation. If the wiper frequently stops operation, refrain from using it and contact the nearest Isuzu Dealer.
- For flat blade types, the wipers are stored under the engine hood. Do not forcibly pull them out from under the hood manually. If you do, the wipers could be damaged. To stand the wiper arms up, first switch them to the service position.

## Switching to the Service Position

→ Refer to page 6-98

## Switching to the Normal Position

→ Refer to page 6-100

## Windshield Wiper Switch

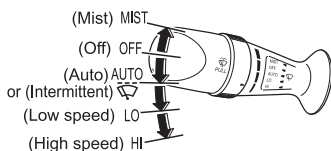

The windshield wiper switch has the following positions, which correspond to the states of the wiper.

Lever position	Wiper state
MIST	Operates when the lever is held upward
OFF	Stopped
AUTO*1/ ⏸*2	AUTO: Automatic operation depending on rainfall (If equipped) ⏸: Intermittent (Light rain) (If equipped)
LO	Low speed (Moderate rain)
HI	High speed (Heavy rain)

\*1: Models with automatic windshield wiper

\*2: Models with intermittent windshield wiper

**Automatic Windshield Wiper**

When the windshield wiper switch is in the "AUTO" position, the wiper operates automatically according to rainfall as follows.

Rainfall	Wiper state
No rain	Stopped
Light rain	Intermittent*
Moderate rain	Low speed
Heavy rain	High speed

\*: The interval between wiper sweeps changes according to the rainfall.

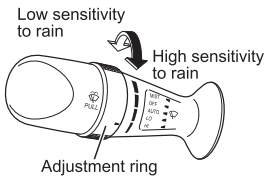

The sensitivity of the sensor to rain can be adjusted to 4 levels by turning the adjustment ring.

The settings of the automatic windshield wiper can be changed by using the user customization function on the MID.

When the automatic windshield wiper is off and the windshield wiper switch is set to the "AUTO" position, the wiper functions as a variable intermittent windshield wiper.

**Settings (User Customization Function)**

→ Refer to page 4-47

Display indication		Description	
Wiper	Automatic wiper	Enable	Turns on the automatic windshield wiper.
		Disable	Turns off the automatic windshield wiper.

**CAUTION**

- When not using the wiper, set the windshield wiper switch to the "OFF" position. When the engine is started, if something touches the rain and light sensor, or the windshield vibrates, the wipers may operate unexpectedly. Be careful that your fingers etc. are not pinched by the wipers.

Rain and light sensor

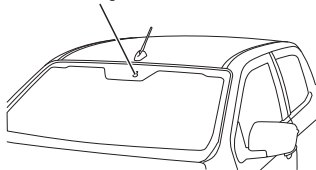
**NOTE**

- Do not put stickers or labels etc. on the windshield in such a way that they cover the rain and light sensor. Otherwise, the sensor will not be able to accurately sense rain. The sensor is at the top of the windshield.
- Do not replace the windshield with anything other than a genuine Isuzu windshield. Replacing the windshield with anything other than a genuine Isuzu windshield may prevent the rain and light sensor from being able to accurately sense rain. To replace the windshield, contact the nearest Isuzu Dealer.
- Do not use any water repellent coating agents on the windshield. Otherwise, the rain and light sensor may not be able to accurately sense rain.
- Replace the wiper blades if any poorly wiped areas are found when inspecting the operating condition of the wiper. If there are any poorly wiped areas, the rain and light sensor may not be able to accurately sense rain.
- If an abnormality occurs in the rain and light sensor and the windshield wiper switch is set to the "AUTO" position, the wipers start operating even when it is not raining. In this case, contact the nearest Isuzu Dealer.
- When the temperature of the rain and light sensor is extremely high or low, the automatic windshield wiper may not operate properly.

NOTE (Continued)

**NOTE (Continued)**

- Since the rain and light sensor uses an optical sensor, when the windshield wiper switch is in the "AUTO" position, the wiper may be activated due to direct sunlight, infrared rays, etc. We recommend setting the windshield wiper switch to the "OFF" position when it is not raining.

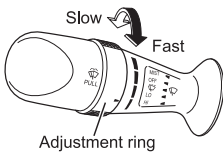
**Variable Intermittent Windshield Wiper**

The wipers will operate intermittently when the windshield wiper switch is rotated to the "⚡" position. The interval between wiper sweeps can be adjusted within a range of approximately 1.5 to 15 seconds by turning the adjustment ring.

**NOTE**

- For models with the automatic windshield wiper, when the automatic windshield wiper is off and the windshield wiper switch is set to the "AUTO" position, the wiper functions as a variable intermittent windshield wiper.

### Windshield Washer Switch

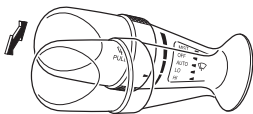

Windshield washer fluid is sprayed over the windshield when this switch is pulled. In models with the intermittent windshield wiper function ("⏏" or "AUTO" position), the windshield wiper operates at the same time as the windshield washer fluid is sprayed. The windshield washer is used when the windshield is being wiped during clean.



#### CAUTION

- At extremely low temperatures, washer fluid may freeze on the windshield after being sprayed, obstructing your forward view. In such a case, warm up the windshield before using the windshield washer.



#### ADVICE

- In models with the intermittent windshield wiper function ("⏏" or "AUTO" position), if windshield washer fluid does not come out in sufficient quantity, immediately release the switch. Otherwise, the windshield surface may sustain damage.
- Do not hold the switch pressed for more than 30 seconds. Otherwise, the washer pump may sustain damage.
- If windshield washer fluid does not come out, release the windshield washer switch immediately. Otherwise the motor may seize up.
- When the vehicle is used in a cold-climate region, use washer fluid with appropriate concentration for the season to prevent frozen fluid.

#### Windshield Washer Fluid

→ Refer to page 6-94

## Horn Button

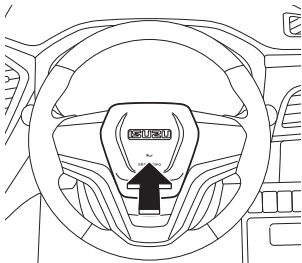

To sound the horn, press the pad with a horn symbol on the steering wheel.



## Remote Control Mirror Switch

The remote control mirror switch is active only when the power mode is "ACC" or "ON" (models with passive entry and start system) or the starter switch is in the "ACC" or "ON" position (models without passive entry and start system).

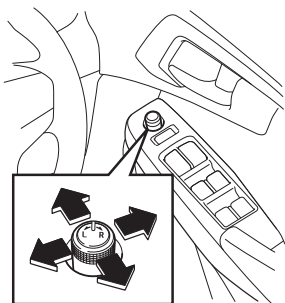
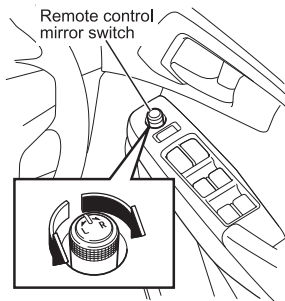

### Adjust

1. Turn the remote control mirror switch to the side you want to adjust, "L" or "R".
2. Operate the switch to adjust the angle of the mirror.



### WARNING

- Adjust the mirrors when the vehicle is stationary, not while the vehicle is in motion.



### ADVICE

- Do not try to forcefully move the mirror surface by hand. Otherwise, the mirror motor may sustain damage.

## Retractable Power Mirror Switch

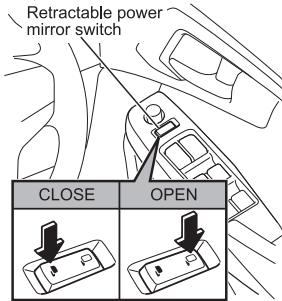

The retractable power mirror switch is active only when the power mode is "ACC" or "ON" (models with passive entry and start system) or the starter switch is in the "ACC" or "ON" position (models without passive entry and start system).

To retract the mirrors on both sides, press the "L" side of the switch. To extend the mirrors, press the "R" side of the switch.

### WARNING

- Do not operate the retractable power mirrors while driving as this is dangerous and could cause an accident.
- Do not drive with the mirrors folded in. Before driving, be sure to adjust both the driver's side mirror and passenger's side mirror to their original positions.

### CAUTION

- Do not touch the mirrors with a hand while the mirrors are moving. It could cause your hands to be pinched or a mirror malfunction.

### ADVICE

- When moving the mirror manually, do not use more force than necessary.
- Although the retractable power mirror can be moved manually as well, we recommend that you electrically move the mirror to prevent malfunction.

### Illumination Control Switch

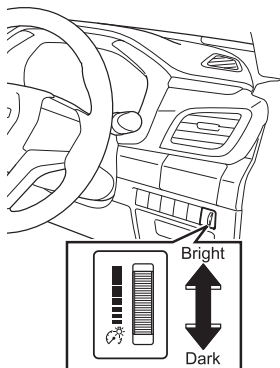

This switch is used to adjust the brightness of the illumination in the instrument panel. Turning the switch up brightens the lights, and turning the switch down darkens them. The brightness can be adjusted with the light control switch in the "AUTO" (with the taillights "ON"), "☰" or "☷" position.



#### NOTE

- In models with an MID, meter brightness is not adjusted in coordination with illumination control switch operation.
- In models with an LCD, the brightness of meter dials and needles is adjusted in coordination with illumination control switch operation.

### Rear Window Defogger Switch

#### Automatic Air Conditioner

→ Refer to page 5-5

#### Manual Air Conditioner

→ Refer to page 5-15

## DRIVING CONTROLS

• Pedals	4-142	• Autonomous Emergency Braking (AEB)	4-226
• Parking Brake	4-143	• Pedal Misapplication Mitigation	4-239
• Manual Transmission	4-144	• Adaptive Cruise Control (ACC)	4-245
• Automatic Transmission	4-145	• Manual Speed Limiter (MSL)	4-270
• Cruise Control	4-151	• Lane Departure Warning (LDW)	4-273
• Anti-lock Brake System (ABS)	4-157	• Lane Departure Prevention (LDP)	4-278
• Electronic Braking force Distribution (EBD)	4-161	• Emergency Lane Keeping (ELK)	4-287
• Electronic Stability Control (ESC)	4-162	• Lane Keep Assist System (LKAS)	4-296
• Brake Assist Function	4-169	• Attention Assist	4-304
• Emergency Stop Signal (ESS)	4-170	• Automatic High Beam (AHB)	4-306
• Hill Start Assist	4-171	• Four Wheel Drive (4WD) Model	4-310
• Hill Descent Control	4-172	• Tire Pressure Monitoring System (TPMS)	4-319
• Trailer Sway Control	4-176		
• Multi-Collision Brake (MCB)	4-178		
• Blind Spot Monitor (BSM)	4-179		
• Rear Cross Traffic Alert (RCTA)	4-188		
• Parking Aid System	4-197		
• Stereo Camera	4-210		

## Pedals

### Manual transmission model

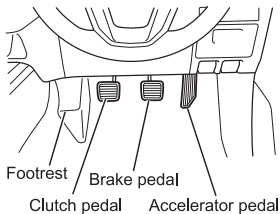

### Automatic transmission model

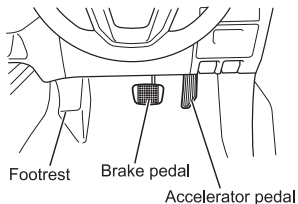

Sit in a correct driving position on the seat and operate the brake pedal and accelerator pedal with your right foot. To avoid depressing the wrong pedal by mistake, check the pedal positions and practice putting your foot on the desired pedal.

### WARNING

- A can or bottle rolling on the floor may prevent brake pedal operation if it is caught under the pedal. This is very dangerous. A floor mat must be placed correctly. An incorrectly installed floor mat may hinder the free movement of each pedal.

**Keep the Floor Around the Driver's Seat Clean and Tidy** → Refer to page 2-13  
**Making Sure the Floor Mats Laid Out Correctly** → Refer to page 2-14

### ADVICE

- Do not race the engine; engine components as well as fuel economy may be badly affected.
- If your vehicle has a manual transmission, do not drive with your foot resting on the clutch pedal. Doing so may damage the clutch.

### Brake Override System (BOS)

When the accelerator pedal and brake pedal are depressed at the same time, the engine power may be reduced.

## Parking Brake

### Operation of Parking Brake Lever

#### CAUTION

- Although the parking brake warning light will come on if the parking brake is engaged, this does not mean the parking brake is fully engaged, so always make sure the lever is fully pulled up.
- Simply pressing the release button does not return the lever to its original position. You should always press the release button while pulling the parking brake lever up slightly.
- If the parking brake lever is not completely returned to its original position during driving, it may cause damage or a fire.

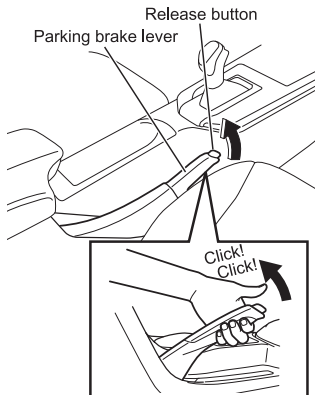

Parking brake warning light



When parking the vehicle, fully apply the parking brake lever without pressing the release button. The parking brake warning light in the instrument panel will come on when the lever is pulled up.

To release the parking brake, press the release button while raising the lever a little and then lower the lever. The parking brake warning light in the instrument panel will go out.

#### CAUTION

- Always apply the parking brake lever fully without pressing the release button.

## Manual Transmission

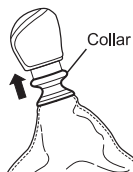
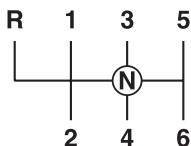

When making a gearshift, depress the clutch pedal fully.

To shift the gearshift lever to "R", pull up the ring while shifting. When the gearshift lever is placed into "R (reverse)", the back up lights come on and a buzzer sounds.



## ADVICE

- Make a shift into the reverse gear from a forward gear or into a forward gear from the reverse gear only when the vehicle has come to a complete stop. In addition, do not shift gears without fully depressing the clutch pedal. Otherwise, the transmission may be damaged.
- Do not pull up the ring except when shifting the gearshift lever to "R".
- If you encounter any of the following conditions, the vehicle may be malfunctioning. Have your vehicle inspected/serviced at the nearest Isuzu Dealer as soon as possible.
  - The collar cannot be pulled up.
  - Even while the collar is pulled up, the gearshift lever cannot be shifted into the "R" position.
  - Even after returning the gearshift lever to the "N" position, the collar does not return to its original position.

**Automatic Transmission**

Move the selector lever to shift into each gear position. When moving the selector lever from "P" into any other position, be sure to depress the brake pedal.

Regarding fundamental precautions on automatic transmissions, refer to "Automatic Transmission Model".



**NOTE**

- The shift pattern is on the selector lever knob.
- The shift pattern and the gear position are displayed on the MID.

**Automatic Transmission Model**

→ Refer to page 2-55

**Shift Indicator**

→ Refer to page 4-74

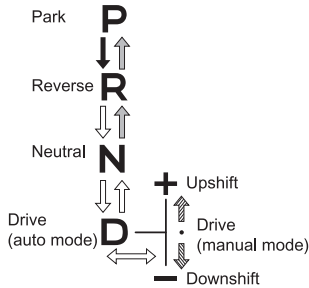
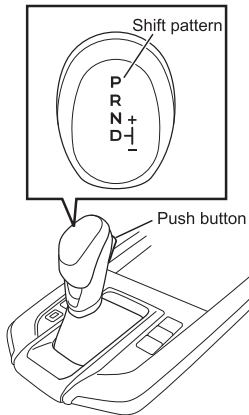

- ➡ : Operate the selector lever while pressing the push button with the brake pedal depressed.
- ➡ : Operate the selector lever while pressing the push button.
- ⇔ : Operate the selector lever without pressing the push button.
- ⇔ : Operate the selector lever without pressing the push button. The selector lever will return to the manual mode position when you release your hand after operating the lever in the direction of the arrow.

Selector lever position	Shift indication in the instrument panel	Gear position
P	P	Park: Used when parking and starting the engine.
R	R	Reverse: Used when backing up the vehicle.
N	N	Neutral: The engine can be started in this position but for safety reasons get in the habit of starting the engine with the selector lever in the "P" position.
D	D	Drive (auto mode): The system automatically selects an optimum gear (1st to 6th gear) according to the vehicle speed.
+, -	M1 - M6	Drive (manual mode): Manually selecting the "+" (upshift) or the "-" (downshift) position allows the driver to select the desired gear (1st to 6th gear).

**WARNING**

- If you always operate the selector lever while pressing the push button, it is possible to accidentally shift the lever to the "P" or "R" position in some cases.
- Get in the habit of shifting the selector lever from the "N" to "D" or "D" to "N" position without pressing the push button. Incorrect operation may cause a serious accident.

**ADVICE**

- Driving using an inappropriate gear in the manual mode will result in a failure of the transmission system. In particular, avoid selecting higher gears when driving uphill or towing. Doing so will cause overheating.
- If "-" is intermittently displayed on the shift indicator in the instrument panel, have the vehicle inspected/repared at the nearest Isuzu Dealer as soon as possible.

**NOTE**

- For safety reasons, the shift lock system operates to prevent shifting of the selector lever to any position other than "P" unless the brake pedal is depressed, the power mode is "ON" (models with passive entry and start system) or the starter switch is in the "ON" position (models without passive entry and start system). When pulling away, be sure to keep the brake pedal depressed as you operate the selector lever.

**Shift Lock System**

→ Refer to page 4-150

**Shift Indicator**

→ Refer to page 4-74

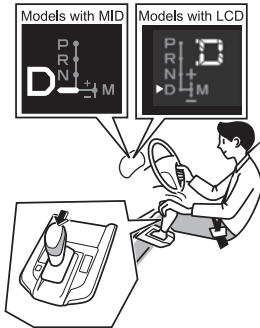
**Drive (Auto Mode)**

Gears are automatically shifted.

**NOTE**

- When you depress the accelerator fully, the transmission automatically shifts to a lower speed gear according to the vehicle speed and the engine speed rises to enable sufficient acceleration.
- On steep uphill grades or when towing a heavy load, the system senses a lack of engine torque in the upper gears and prevents upshifting or forces downshifting. On steep downhill grades, the system automatically downshifts when the service brake is applied as a trigger.

## Drive (Manual Mode)

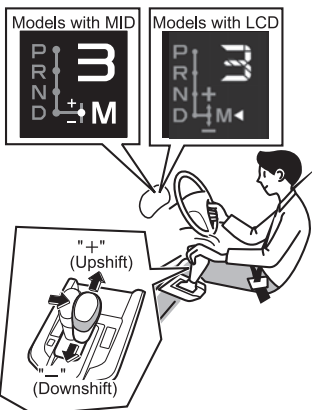

When the selector lever is shifted from the "D" position to the right, the transmission is switched from auto mode to manual mode. In manual mode, the gears can be selected by operating the selector lever to "+" (upshift) or "-" (downshift).

**NOTE**

- Each time you operate the selector lever to "+" (upshift) or "-" (downshift), the gears shift one gear at a time.
- Shift into the gear that is appropriate for the vehicle speed. If an inappropriate gear shift position is selected, a warning buzzer will sound and the shift will not occur.
- The gear is automatically shifted down to the 1st gear when the vehicle is stopped.
- To return to the auto mode, place the selector lever into the "D" (auto mode) position.
- On a snowy or icy road, you can pull away in the manual mode 2nd gear (2nd start mode).

**2nd Start Mode** → Refer to page 4-149

## 2nd Start Mode

Use 2nd start mode only when driving on slippery road conditions due to snow, ice, etc.

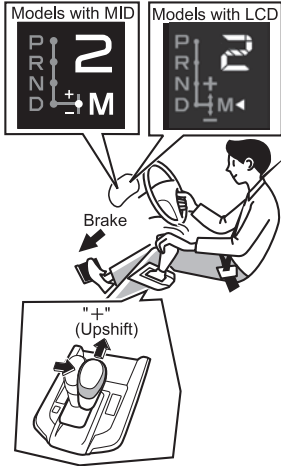

1. Depress the brake pedal and stop the vehicle.
2. Shift the selector lever from the "D" (auto mode) position to the manual mode position (shifted to the right side). Press the selector lever forward to "+" (upshift).
3. Make sure that the shift indicator display changes from "1" to "2".



### ADVICE

- Driving during normal road conditions using 2nd start mode will cause the automatic transmission fluid temperature to rise, leading to breakdown.



### NOTE

- To disengage the 2nd start mode, shift the selector lever to the "D" (auto mode) position or select a gear other than "2".

### Shift Lock System

The selector lever cannot be operated from the "P" position to any other position when the brake pedal is not depressed. Be sure to operate the selector lever while depressing the brake pedal.



#### NOTE

- The shift lock system is a system for safety to prevent incorrect operation of the automatic transmission model.

### Deactivating the Shift Lock

If the selector lever cannot be operated from the "P" position to any other position while depressing the brake pedal, perform the following as a temporary measure to operate the selector lever.



#### WARNING

- When the selector lever cannot be operated from the "P" position to any other position even after performing the operation below repeatedly, the shift lock system may have a failure. Have your vehicle inspected at the nearest Isuzu Dealer as soon as possible.

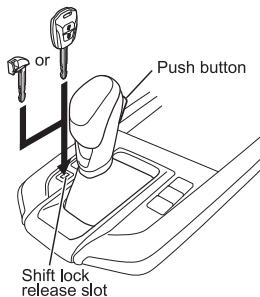

1. Fully depress the brake pedal and securely set the parking brake.
2. Insert the key into the shift lock release slot.



#### ADVICE

- To prevent damage, apply a cloth etc. when inserting it.
3. Press the push button on the selector lever and move the selector lever while pushing the key into the slot.

## Cruise Control

The cruise control function allows you to drive the vehicle at a constant speed without operating the accelerator pedal. Cruise control can be used at vehicle speeds from approximately 30 km/h (20 MPH) to 160 km/h (100 MPH) (type 1) or at those of approximately 40 km/h (25 MPH) or more (type 2). This function should only be used when driving without frequent starting and stopping, such as when driving on an expressway.

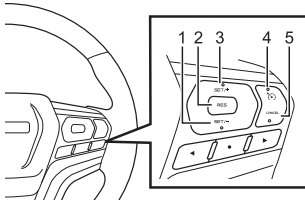

### Cruise Control Switch (Type 1)

No.	Description
1	SET switch/- switch
2	RES switch
3	SET switch/+ switch
4	Main switch
5	CANCEL switch

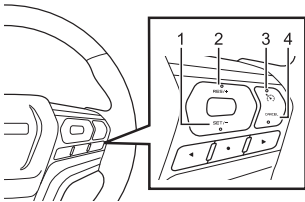

### Cruise Control Switch (Type 2)

No.	Description
1	SET switch/- switch
2	RES switch/+ switch
3	Main switch
4	CANCEL switch

### WARNING

- Do not use the cruise control function on the following roads, where using it could be dangerous.
  - A road with a heavy traffic, such as an urban road
  - A road that includes sharp curves and steep downhill slopes
  - An icy, snowy or otherwise slippery road
- Do not use the cruise control function when towing a vehicle.

**CAUTION**

- Remember that taking your foot off the accelerator when the cruise control is engaged will not reduce vehicle speed. When going up or down hills, it is possible for the vehicle to gain or lose speed, even though the cruise control is engaged. If this happens while going up a hill, depress the accelerator pedal to maintain the desired speed. If going down a hill, depress the brake pedal, which will both disengage the cruise control and slow down the vehicle.
- Set the vehicle speed within an appropriate speed range for road conditions, environment, and to observe the speed limit.
- While the cruise control is operating, the acceleration and brake control according to the preceding vehicle is not performed. Depress the accelerator pedal or brake pedal as necessary.
- If you feel any abnormality when using cruise control, cancel cruise control with the main switch and have your vehicle inspected as soon as possible at your Isuzu Dealer.
- When using cruise control in models with the adaptive cruise control, check the display area to see which mode, the adaptive cruise control or regular cruise control, is selected.
  - When the adaptive cruise control is selected, the adaptive cruise control indicator light comes on.
  - When the cruise control is selected, the cruise control indicator light comes on.

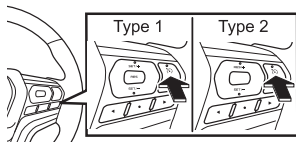
**Setting to Your Desired Vehicle Speed****Main switch**

1. Press the main switch to set it to "ON". The cruise control indicator light comes on white.

**Cruise control indicator light (White)**

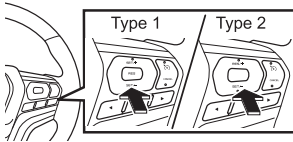
**SET switch****Cruise control indicator light (Green)**

- Use the accelerator pedal to adjust the vehicle speed to the desired speed of approximately 30 km/h (20 MPH) or more (type 1) or approximately 40 km/h (25 MPH) or more (type 2). Upon reaching the desired speed, operate the "SET" switch. The vehicle speed at the moment you operate the switch is set in the system, enabling you to drive with the set speed automatically maintained without using the accelerator pedal. At the same time the cruise control indicator light comes on green.

### Accelerating during Cruise Control Driving

If you want to accelerate temporarily to pass another vehicle while driving using the cruise control, depress the accelerator pedal. When you release the accelerator pedal, the speed returns to the original set vehicle speed.

### Changing the Cruise Control Speed Setting

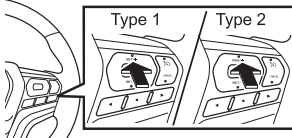
**+ switch****When Increasing Vehicle Speed**

When the "+" switch is operated, the speed increases while the switch is held.

After the speed is increased to the desired vehicle speed, and the "+" switch is released, the speed is set at the increased vehicle speed. If you want to increase the speed quickly, depress the accelerator pedal and accelerate to the desired vehicle speed. Then, operate the "SET" switch.

### When Increasing Vehicle Speed Slightly

In models with the cruise control switch (type 1), if the "+" switch is operated and released immediately, the set vehicle speed increases 1 km/h (1 MPH) per operation. By pressing and holding the switch, the vehicle speed increases in 5 km/h (5 MPH) increments.

In models with the cruise control switch (type 2), if the cruise control set switch is operated and released immediately, the set vehicle speed increases 1 km/h (0.6 MPH) per operation.

- switch

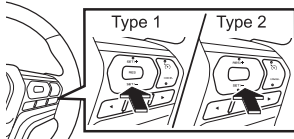

### When Decreasing Vehicle Speed

When the "-" switch is operated, the speed decreases while the switch is held.

After the speed is decreased to the desired vehicle speed, and the "-" switch is released, the speed is set at the decreased vehicle speed. If you want to decrease the speed quickly, depress the brake pedal to cancel cruise control and decelerate to the desired vehicle speed. Then, operate the "SET" switch.

### When Decreasing Vehicle Speed Slightly

In models with the cruise control switch (type 1), if the "-" switch is operated and released immediately, the set vehicle speed decreases 1 km/h (1 MPH) per operation. By pressing and holding the switch, the vehicle speed decreases in 5 km/h (5 MPH) increments.

In models with the cruise control switch (type 2), if the cruise control set switch is operated and released immediately, the set vehicle speed decreases 1 km/h (0.6 MPH) per operation.

## When Canceling Cruise Control

### Main switch

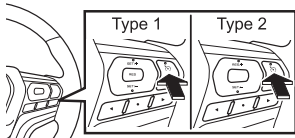

### CANCEL switch

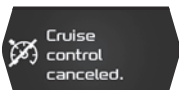
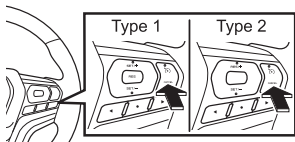

Press the main switch again to set it to "OFF". The cruise control indicator light will go out.

If the cruise control is canceled automatically by the system, "Cruise control canceled." is displayed on the MID for approximately 5 seconds. After that, the cruise control indicator light goes out.

The cruise control is canceled in the following cases.

- When the brake pedal is depressed.
- When depressing the clutch pedal (manual transmission model).
- When the vehicle speed decreases to approximately 30 km/h (20 MPH) or less (type 1) or approximately 40 km/h (25 MPH) or less (type 2)
- When there is an abnormality in the engine control system.
- When shifting gears.
- When operating the "CANCEL" switch.
- When the vehicle has been temporarily stopped and the selector lever has been placed in the "N" position (automatic transmission model).
- When the electronic stability control (ESC) or traction control system (TCS) is activated.



### ADVICE

- When not using the cruise control, be sure to turn it off.

### When Returning to Cruise Control Driving

If you have canceled cruise control under the following conditions, you can return to the cruise control driving condition before cancellation when you press the "RES" switch. Then, the cruise control indicator light comes on green.

- When depressing the brake pedal.
- When shifting gears.
- When operating the "CANCEL" switch.

## Anti-lock Brake System (ABS)

Wheels may be locked and slip during sudden braking or braking on a slippery road surface such as a snowy road. ABS is a device to prevent the wheels from locking by detecting a slippery condition during braking and to secure directional stability and handling stability of the vehicle. ABS is only to assist in slippery conditions and will not prevent an accident if you exceed safe driving speeds for road conditions. Always drive safely.



### CAUTION

- When the rear differential lock is operating (models with rear differential lock), the ABS does not operate.
- The braking distance on slippery road surfaces is longer than that on a normal dry paved road even with an ABS-equipped vehicle. In addition the braking distance can be slightly longer in deep snow and on a gravel road when ABS is operated. Therefore, always keep in mind the road condition and tire condition (type of tires and worn condition), observe safe driving habits and drive the vehicle while keeping a proper distance between vehicles.
- ABS does not prevent accidents if you do not drive safely. Drive the vehicle at a safe speed.
- Install tires of the specified size, same brand and same tread design (including winter tires) on all wheels. If different tires are installed, the braking distance becomes longer and directional control stability of the vehicle decreases. This is very dangerous.
- Steering during sudden braking (when the ABS is working) will feel slightly different than it does when the brakes are not applied. Operate the steering wheel carefully keeping this in mind.



### ADVICE

- Driving in sand or on a muddy road may adversely affect the brakes and ABS sensors. Wash the vehicle to remove sand and mud after operating the vehicle in sandy or muddy conditions.
- Before washing the vehicle, provide necessary protection to prevent water from being splashed on the ABS components (sensors and actuators). Especially when using high-pressure washing, be careful not to allow water to be directly sprayed onto the ABS components and their harness connectors.

**NOTE**

[These are not signs of ABS malfunction]

- Immediately after the engine is started, a motor sound may be heard from the engine compartment. This sound is from a self-check by the ABS. In addition, vibration may occur when the brake pedal is depressed at this time.
- When ABS is operating, vibration is felt on the brake pedal and steering wheel and you may hear the system operating. This is normal when ABS is properly operating.
- ABS is more likely to be operated when the brake is applied during cornering or driving over a bump. This is because inside wheels or wheels that have gone over a bump tend to lock.
- ABS is not operated immediately after starting the vehicle. Although the ABS operates when the vehicle drives at more than or equal to a specified low speed, it is canceled when the vehicle decelerates.

## ABS Operation Signs and Errors

## ABS warning light

**Operation Signs of ABS**

When ABS is operated, slight vibration is generated on the brake pedal and steering wheel, and an operating sound can be heard from the ABS equipment.

**ABS Faulty**

When the ABS warning light does any of the following, the ABS may be faulty. Please contact the nearest Isuzu Dealer.

- If the ABS warning light comes on during driving.
- The light does not come on when the power mode is switched to "ON" (models with passive entry and start system) or the starter switch is turned to the "ON" position (models without passive entry and start system).

**NOTE**

- Even if a problem has occurred with the ABS, the regular brakes will still work normally. However, ABS will not operate.

**ABS Warning Light**

→ Refer to page 4-67

### Precautions for Driving an ABS-Equipped Vehicle

ABS is not a device that enables driving and stopping under conditions exceeding safe driving limits. Always drive safely.



#### CAUTION

- When braking suddenly, depress and hold the brake pedal strongly so that the ABS can take effect.
- When braking suddenly, do not pump the brakes (pushing and releasing the brake pedal little by little). Pumping brakes will increase the braking distance.
- The braking distance on slippery road surfaces is longer than that on a normal dry paved road even with an ABS-equipped vehicle. When ABS is operated in the following road surface conditions, the braking distance may be slightly longer compared to that of vehicles not equipped with an ABS. Therefore, always be aware of the road and tire condition (tire type and wear condition), observe safe driving habits and drive the vehicle while keeping a safe following distance.
  - When driving on a gravel road, or a road with a deep snow covering.
  - When tire chains are used.
  - When driving over road joints or bumps such as light reflectors on the road.
  - When driving on a bumpy road, stone-paved road or track.
  - When driving over an iron plate or manhole lid.
- ABS does not work for wheel skid during a standing start, acceleration and cornering which do not involve braking. On a very slippery icy road, tires may lose grip and steering wheel operation may not be able to control the vehicle's direction, resulting in very unstable driving. Always drive the vehicle observing a safe speed well matched with both road surface and tire conditions, and avoid sudden braking.
- If powerful engine braking is applied on a very slippery icy road, the drive wheels may be locked (the ABS then does not work), resulting in loss of vehicle control. If this happens with a manual transmission vehicle, disengage the clutch or place the gearshift lever into the "N" position to prevent engine braking from acting on the drive wheels. Then, drive the vehicle with the gearshift lever placed in an appropriate gear.
- When ABS is operated, a slight vibration (especially when the road surface is different between right and left wheels) and pulling may be felt on the brake pedal and steering wheel. In addition, an operating sound is produced from the ABS actuators. This does not indicate any abnormal condition. Stay calm and operate the steering wheel properly.

### Electronic Braking force Distribution (EBD)

EBD is a function that uses the ABS to distribute braking force ideally between the front and rear wheels in order to compensate for changes in load conditions or any shift of the load due to acceleration or deceleration, thus preventing premature locking of the rear wheels.



#### CAUTION

- If a problem should occur with the EBD function, the ABS warning light and the brake system warning light will come on simultaneously.
- The rear wheels will lock more easily if there is a problem with the EBD function. Have it checked and serviced at the nearest Isuzu Dealer as soon as possible.



#### NOTE

- When the EBD operates, the brake pedal may push back slightly or you may hear a sound similar to that generated by the ABS when operational. Neither of them indicate any abnormal condition.

### Electronic Stability Control (ESC)

The ESC improves safety and a vehicle's stability. The ESC controls engine power and applies the brakes to the wheels that need it in order to suppress wheelspin when starting or accelerating on slippery road surfaces, maintain drive power, prevent skidding to the side, and improve vehicle stability. The ESC has various sensors that detect rapid changes in the vehicle conditions while driving. The traction control system (TCS) controls engine power and applies the brakes to the wheels that need it in order to suppress wheelspin when starting or accelerating.

Normally, both the ESC and TCS activate automatically when the engine is started. By using the ESC OFF switch, the ESC can be canceled (operation stopped status) or only the function of the TCS can be canceled (operation stopped status).



#### CAUTION

- When the 4WD switch is set to 4L (4WD low) (models with 4WD), the ESC warning light, ESC OFF indicator light, and TCS OFF indicator light come on, and the ESC and TCS engine power control function will not activate. However, in this case TCS brake control function will still activate.
- When the rear differential lock is operating (models with rear differential lock), the ESC and TCS does not activate.
- When the ESC is operated, the ESC warning light flashes.
- The ESC warning light will also flash when only the TCS function is operating.
- When the ESC warning light is flashing, the road surface is slippery or acceleration is too fast. Loosen pressure on the accelerator pedal and drive conservatively.
- The ESC warning light may also flash when fully depressing the accelerator pedal on roads that are not slippery such as dry asphalt roads. This is a normal condition that predicts slipping and operates control.
- Even with an ESC-equipped model, when driving on a snowy or icy road, install tire chains or winter tires, and carefully drive the vehicle. The ESC is not a device for drastically improving the vehicle stability when driving or starting performance, so drive carefully on snowy or icy roads.
- When tire chains are installed, it may be easier for you to start the vehicle to move on an icy slope if just the TCS is canceled. Be aware, however, that TCS deactivation will result in reduced vehicle stability.
- Install tires of the specified size, same brand, same type and same tread design (including winter tires) on all wheels. In addition, do not install or use tires with significantly varying degrees of wear. If tires other than the specified size, different types, or tires with significantly varying degrees of wear are used, the ESC may not operate properly.

CAUTION (Continued)

**CAUTION** (Continued)

- If the tire diameter is different such as when installing tire chains or a spare tire, the ESC may not operate properly.
- If suspension-related parts, brake-related parts, or engine-related parts are replaced with parts other than Isuzu genuine parts or modified, the ESC may not operate properly.
- Do not install a limited slip differential (LSD). The ESC may not operate properly.
- Be sure to consult with your Isuzu Dealer for replacement or repair of the steering wheel or steering-related parts. There is a sensor on the steering wheel that detects driving operation conditions, and the ESC may not operate properly if the steering wheel center position is misaligned.
- Do not tow the vehicle with the power mode in "ON" (models with passive entry and start system) or the starter switch in the "ON" position (models without passive entry and start system) with just the front wheels or rear wheels raised. The ESC may operate and cause an accident.

**NOTE**

[These are not signs of ESC malfunction]

- Immediately after the engine is started, a motor sound may be heard from the engine compartment. This sound is from a self-check by the ESC. In addition, vibration may occur when the brake pedal is depressed at this time.
- When the ESC is operating, the brake pedal movement may wiggle or feel tight. In addition, the vehicle body may vibrate or you may hear operating sounds. This is normal for ESC operation.
- The ESC will not operate immediately after starting the vehicle. The ESC operates when the vehicle drives at more than or equal to a specified low speed.

### ESC OFF Switch

When getting unstuck from mud or fresh snow with the ESC and TCS operating, the engine output may not rise even when the accelerator pedal is depressed, making getting unstuck difficult. In times like this, pressing the ESC OFF switch will make getting unstuck easier. The ESC can be turned off using the ESC OFF switch, or just the TCS (function for suppressing tire spinning when starting or accelerating) in the ESC system can be turned off.

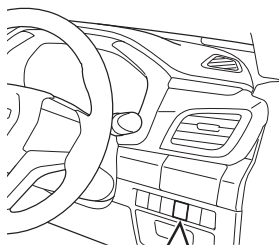

TCS OFF indicator light

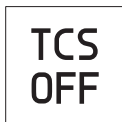

### When Canceling the TCS

When the ESC is active after the engine is started, press the ESC OFF switch for approximately 1 second to cancel the TCS and cause the TCS OFF indicator light in the instrument panel to turn on. When the switch is pressed again for approximately 1 second, the TCS function turns back on. When the 4WD switch is set to 4L (4WD low) (models with 4WD), cause the TCS OFF indicator light in the instrument panel to turn on and cancel the TCS. When the switch is pressed again for approximately 1 second, the TCS function turns back on.



### CAUTION

- When you turn off the TCS, it will not be available to assist you in slippery driving conditions. Always use caution when driving on slippery roads.
- Be sure to enable the TCS during normal driving.
- The ESC will activate even if the TCS is off. However, when the 4WD switch is set to 4L (4WD low) (models with 4WD), the ESC will not activate.

**NOTE**

- If the engine is turned off and then restarted again while the TCS is off, the TCS will be automatically reactivated.

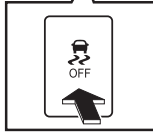
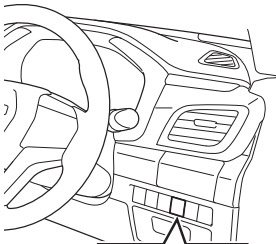

ESC OFF indicator light

**When Canceling the ESC**

When the ESC is active after the engine is started, press the ESC OFF switch for approximately 5 seconds to cancel the ESC and cause the ESC OFF indicator light in the instrument panel to turn on. When the switch is pressed again for approximately 1 second, the ESC function turns back on.

**CAUTION**

- When you turn off the ESC, it will not be available to assist you in slippery driving conditions. Always use caution when driving on slippery roads.
- Be sure to enable the ESC during normal driving.
- When the ESC is turned off, the TCS will also be turned off, thus be careful when driving on slippery roads.

**NOTE**

- If the engine is turned off and then restarted again while the ESC is off, the ESC will be automatically reactivated.
- When the 4WD switch is set to 4L (4WD low) (models with 4WD), the ESC will be canceled automatically.

## ESC Operation Signs and Errors

## ESC warning light



## TCS OFF indicator light



## ESC OFF indicator light



## Operation Signs of ESC

When the ESC is operating, the ESC warning light flashes.

## ESC Faulty

When the ESC warning light does any of the following, the ESC may be faulty. Please contact the nearest Isuzu Dealer.

- The ESC warning light remains on while driving.
- The TCS OFF indicator light and ESC OFF indicator light turn on while driving (when the ESC OFF switch is not operated).
- The ESC warning light, TCS OFF indicator light, and ESC OFF indicator light do not turn on when the power mode is switched to "ON" (models with passive entry and start system) or the starter switch is turned to the "ON" position (models without passive entry and start system).



## NOTE

- If the ESC is faulty, it does not interfere with normal driving. However, the ESC will not function.

**Precautions for Driving an ESC - Equipped Vehicle****CAUTION**

- The ESC is not a device that enables driving under conditions exceeding safe limits. Always drive safely.
- Always concentrate on driving safely and do not be overconfident just because the vehicle is equipped with the ESC, so do not drive too fast and turn the steering wheel too sharply.
- The ESC does not increase the road grip of tires although it controls slipping and sliding of vehicles and improves the vehicle stability on a slippery road surface during starting and acceleration when compared to a model without ESC. On an icy or otherwise slippery road, the grip of the tires decreases which also reduces steering control, resulting in unstable vehicle behavior. Always drive the vehicle observing a safe speed well matched to the road surface and tire conditions, and also avoid speeding.
- The ESC is a system for maintaining drive power and vehicle stability. Turn the system on even when it is not needed. When the system is turned off, drive carefully at a safe speed well matched to the road surface.
- Even if ESC is equipped, avoid sudden operation of the accelerator pedal, clutch pedal (manual transmission models) and steering wheel. Especially when starting the vehicle on a slippery road, start up slowly as you would in a vehicle without ESC.
- When the ESC is operated, the ESC warning light flashes.
- The ESC warning light will also flash when only the TCS function is operating.
- When the ESC warning light is flashing, the road surface is slippery or acceleration is too fast. Loosen pressure on the accelerator pedal and drive conservatively.
- The ESC warning light may also flash when fully depressing the accelerator pedal on roads that are not slippery such as dry asphalt roads. This is a normal condition that predicts slipping and operates control.
- Even with an ESC-equipped model, when driving on a snowy or icy road, carefully drive the vehicle, and install tire chains or winter tires.
- When tire chains are installed, it may be easier for you to start the vehicle to move on an icy slope if just the TCS is canceled. Be aware, however, that TCS deactivation will result in reduced vehicle stability.

**NOTE**

- When the ESC is operating, the brake pedal movement may wiggle or feel tight. In addition, the vehicle body may vibrate or you may hear operating sounds. This is normal for ESC operation.
- If there is significant wear or degradation on parts related to the suspension, tires, brakes, etc., the ESC warning light may turn on. In such cases, the ESC may not function properly.
- The ESC warning light may turn on when the vehicle is on a turntable at the entrance of a parking garage or on a moving object, etc. In such cases, re-start the engine after the vehicle has left the turntable.
- The ESC warning light may turn on when driving on roads with extreme inclines (the banks seen on race tracks, etc.). In such cases, the ESC may not function properly, so do not drive on such roads.
- The ESC warning light may turn on when the battery cables are disconnected or the battery voltage is low. The ESC function turns off while the ESC warning light is on, but the ESC warning light will turn off by driving the vehicle normally for a while, then the ESC function will resume. If the ESC warning light remains on even after driving for a while, contact the nearest Isuzu Dealer.

## Brake Assist Function

### Models with Electronic Stability Control (ESC)

This function generates greater braking force by increasing the force that the driver applies to the brake pedal when braking suddenly, such as for emergency stops.

Also, this function activates when the autonomous emergency brake (AEB) activates or when the brake is applied during the forward collision warning.

#### WARNING

- The brake assist function is not an automatic brake. This function operates when braking suddenly, but it does not enable stopping under conditions exceeding safe limits. Moreover, this function may not operate in some situations. Always drive safely.

#### CAUTION

- When the rear differential lock is operating (models with rear differential lock), the brake assist function does not operate.
- If the ESC warning light is on, the brake assist function does not operate.

#### NOTE

- When the brake assist function is operating, the following occurs, but this does not indicate a failure. Continue depressing the brake pedal.
  - Motor sound is heard.
  - The brake pedal vibrates.
  - The feeling of depressing the brake pedal changes.
- Releasing the brake pedal while brake assist is operating may cancel the brake assist function.
- The feeling of depressing the brake pedal changes. For example, the brake pedal may feel stiff or as though it is being pulled downward.
- If the brake pedal is depressed again after the brake assist function was terminated, the brake can be applied normally.

### Emergency Stop Signal (ESS)

The emergency stop signal (ESS) is a function that alerts the vehicle behind by automatically flashing all of the turn signal lights at high frequency when your vehicle brakes suddenly while driving at approximately 60 km/h (37 MPH) or more, to reduce the possibility of collisions.

#### Turn signal indicator light

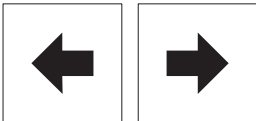

When the ESS is operating, both turn signal indicator lights on the instrument panel flash.



#### NOTE

- When braking on a slippery road causes the ABS to operate, the ESS may operate.
- The ESS stops operating and all turn signal lights go out in the following situations.
  - When the sudden deceleration stops.
  - When the brake pedal is released.
  - When the ABS stops operating.
  - When the hazard warning flasher switch is pressed.
- When the hazard warning flasher switch is pressed and all of the turn signal lights are flashing, the ESS does not operate.
- When the rear differential lock is operating (models with rear differential lock), the ESS does not operate.

## Hill Start Assist

The hill start assist works to assist the driver by lessening the vehicle roll-back that occurs when the vehicle pulls away on steep slopes. When the driver's foot is moved from the brake pedal to the accelerator pedal, the brakes are held in place for a maximum of approximately 2 seconds.

The hill start assist will operate when all the following conditions are met:

- When the vehicle pulls away in the forward or reverse directions on a slope
- When the vehicle is stopped with the brake pedal firmly depressed
- When the parking brake is released

### WARNING

- The hill start assist is not for stopping the vehicle on slopes. The vehicle may start moving if the pressure applied to the brake pedal is decreased when the vehicle is stopped on a slope, even if the system is operating normally. Because of this, it is necessary to continue to firmly depress the brake pedal when the vehicle is stopped.
- Do not overestimate the effectiveness of the hill start assist. Doing so may result in sudden vehicle movement when pulling away, possibly leading to an accident. Pull away only after checking the vehicle's surroundings and with the proper procedure.
- Pull away immediately after removing your foot from the brake pedal. If the vehicle were to begin rolling back due to inertia on slopes, etc., the engine may stall, brake effectiveness will decrease, and the steering wheel will become heavy, possibly leading to an accident.

### CAUTION

- When the rear differential lock is operating (models with rear differential lock), the hill start assist does not operate.
- The hill start assist may not operate when the ESC warning light comes on. Be especially careful if the ESC warning light is on when pulling away.
- The vehicle may roll-back due to the vehicle load when driving on extremely sharp slopes or poor road surfaces (such as those that are icy or muddy).
- The hill start assist may not operate if the brake pedal is not sufficiently depressed when the vehicle is stopped, or depending on the number of passengers or cargo weight.
- The hill start assist cannot lessen vehicle roll-back for more than 2 seconds.

**NOTE**

- The following will occur when the hill start assist operates and do not indicate a malfunction:
  - The feeling of the brake pedal when depressed will change.
  - The brake pedal will vibrate.
  - Sounds will be generated from the brake pedal.

**Hill Descent Control**

Hill descent control is a system that assists in driving stability by controlling the brakes to maintain a consistently low speed when descending down steep slopes or on slippery off-road surfaces in which only the engine brake itself is insufficient. When the hill descent control is in operation, it is possible to adjust vehicle speed by depressing the accelerator pedal or the brake pedal.

**CAUTION**

- When the rear differential lock is operating (models with rear differential lock), the hill descent control does not operate.
- Do not overly rely on the hill descent control system. When descending on extremely steep slopes, frozen road surfaces, or muddy roads, or depending on cargo load, it may be difficult to maintain a constant speed. Because an accident may unexpectedly occur in such situations, depress the brake pedal as necessary.
- The temperature of the brake system may rise when used repeatedly for extended periods of time, resulting in the hill descent control being deactivated.

**NOTE**

- The following may occur during hill descent control operation, but do not indicate an abnormality.
  - Motor operation sounds, etc. can be heard from the engine room during operation
  - When the brake pedal is depressed, there is more resistance than normal or pedal feeling is strange

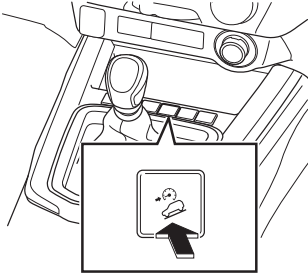
**Operating the Hill Descent Control****Manual transmission model****Type 1**

1. The hill descent control will be activated when the hill descent control switch is pressed. When the hill descent control is activated, the hill descent control indicator light located in the instrument panel will come on.
2. In manual transmission models, place the gearshift lever in a position other than "N" and drive the vehicle. In automatic transmission models, place the selector lever in a position other than "P" or "N" and drive the vehicle.

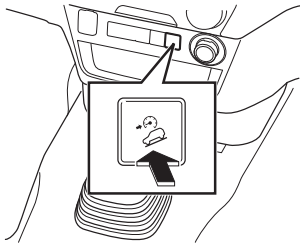
**Type 2****NOTE**

- In manual transmission models, gearshift lever positions "1", "2" or "R" are recommended. In automatic transmission models, selector lever positions "D" or "R" are recommended.

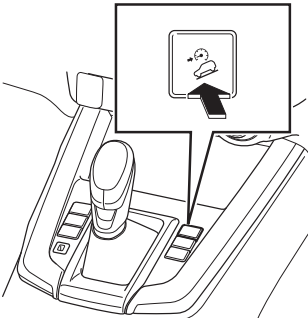
**Automatic transmission model**

**Hill descent control indicator light**

3. When driving, the hill descent control will operate when all of the following conditions are met. When the hill descent control is in operation, the hill descent control indicator light will flash.

- Steep slope
- Vehicle speed is between a very low speed and approximately 30 km/h (19 MPH)
- Accelerator pedal is not depressed

**NOTE**

- The system will automatically control the brakes to prevent the vehicle speed at the time of hill descent control operation from being exceeded.
- When the hill descent control is in operation, the stop lights will operate.
- When the hill descent control is in operation, it is possible to depress the brake pedal to decrease speed or to depress the accelerator to increase to a vehicle speed of 30 km/h (19 MPH) or less.
- When the hill descent control is activated, the hill descent control may also operate when traveling on a flat road or making a U-turn.

**Deactivating the Hill Descent Control****CAUTION**

- When the ESC or TCS are in operation, the hill descent control will be deactivated. When this happens, adjust the vehicle speed by depressing the brake pedal.
- When the temperature of the brake system rises, the hill descent control may be deactivated.

**Hill descent control indicator light**

When the hill descent control is in operation, hill descent control will return to the activated state and the hill descent control indicator light will come on when any of the following conditions are met:

- When the selector lever is placed in the "P" or "N" position (automatic transmission model)
- When the slope gradient becomes less steep
- When the vehicle speed exceeds approximately 30 km/h (19 MPH)
- When the vehicle stops

When the hill descent control is in operation or activated state, hill descent control will be deactivated and the hill descent control indicator light will go out when any of the following conditions are met:

- When the hill descent control switch is pressed
- When the vehicle speed exceeds approximately 50 km/h (31 MPH)
- When there is an abnormality in the hill descent control related systems or the brake system

**ESC warning light****NOTE**

- When there is an abnormality in the hill descent control related systems or the brake system, the ESC warning light will come on.

## Trailer Sway Control

### Models with Electronic Stability Control (ESC)

Trailer sway control is a system that helps stabilize the vehicle by controlling the engine power and applying the wheel brakes when trailer sways occur.

When a trailer sway occurs, keep the vehicle heading straight forward and gradually release the accelerator pedal to reduce speed.

#### WARNING

- The trailer sway control is not a system that operates every time a trailer sway occurs. The trailer sway control may not operate depending on the vehicle, trailer, driving operation, road condition, weather, and other conditions and environments. Do not overly rely on the trailer sway control system and always drive safely.
- When a trailer sway occurs, do not ever accelerate.
- When a trailer sway occurs, avoid applying strong brakes abruptly.
- When a trailer sway occurs, do not try to control the trailer sway by the steering operation.

#### CAUTION

- When the rear differential lock is operating (models with rear differential lock), the trailer sway control does not operate.
- If trailer sways occur when driving at a higher speed, trailer sway control may start operating.
- When a trailer sway occurs, check the condition of the vehicle and trailer.
- When driving is continued because there were no problems with the vehicle and trailer after trailer sways occurred, drive with a speed lower than the speed at the time the trailer sways occurred.

**NOTE**

- When the trailer sway control is in operation, the ESC warning light will flash.
- Under the following situations, the trailer sway control may activate even though the vehicle is not towing another vehicle.
  - When the vehicle is overloaded or loads are piled very high
  - When the vehicle is driving at high speeds on a curvy road
  - When the vehicle is continuously weaving
- When the trailer sway control activates, the braking force is automatically applied alternately to the right and left side. Therefore, the vehicle slows down, swaying slightly.

**ESC warning light****NOTE**

- When the ESC is turned off, the trailer sway control will also be turned off. Be careful when towing the trailer.
- When the trailer sway control is in operation, the stop lights will operate.
- When the 4WD switch is set to 4L (4WD low) (models with 4WD), the trailer sway control will not activate.
- Even when driving uncoupled, trailer sway control may operate depending on the driving condition.
- When there is an abnormality in the trailer sway control related systems or the brake system, the ESC warning light will come on.

**Trailer Towing → Refer to page 2-47**

### Multi-Collision Brake (MCB)

#### Models with the stereo camera and the side airbag

The multi-collision brake is a function that lowers the vehicle speed by automatically applying brakes at the same time the airbag activates when a collision occurs. This function contributes to the mitigation of secondary collision damage and the prevention of the vehicle entering the opposite lane or going off the road.

When any of the airbags is deployed due to a collision, the brake is automatically applied and the stop lights come on.



#### NOTE

- The multi-collision brake operates when the following conditions are met.
  - When the airbag system is operating normally
  - When the brake system is operating normally
  - When the electronic stability control function is on
- The multi-collision brake does not operate when the following conditions are met.
  - When the airbags do not deploy even though a collision occurs (e.g. a light collision or a collision against the rear of the vehicle)
  - When the system components are damaged by a collision
  - When the accelerator pedal is depressed while the multi-collision brake is operating

## Blind Spot Monitor (BSM)

The blind spot monitor (BSM) is a system that assists the driver to confirm areas to the rear on the sides when changing lanes. This system uses radar sensors to detect the existence of vehicles following in adjacent lanes and informs the driver with the blind spot indicator on the outside rearview mirror.

### WARNING

- The driver is responsible for safe driving. Always visually check the surrounding area to be safe when driving the vehicle.
- The BSM is a system that assists the driver to confirm areas to the rear on the sides when changing lanes. To rely entirely on the system may cause a serious accident. Because the system may not operate depending on the situation, always visually check areas to the rear on the sides and other surrounding areas for safety when driving the vehicle.
- The sensors may not detect or may find it difficult to detect the following objects.
  - Small-sized motorcycles, bicycles, and pedestrians
  - Vehicles whose shapes do not effectively reflect the radar waves (sports cars etc.)
  - Stationary objects on roads or the sides of roads
  - Oncoming vehicles
  - Vehicles following in the same lane as your vehicle
  - Vehicles driving 2 lanes away
  - Vehicles in the adjacent lane while your vehicle is about to overtake
  - Vehicles driving at a very different speed than your vehicle
  - Vehicles that are a short distance from your vehicle
  - Vehicles that are in the detection area (proximity area), but do not approach your vehicle (the system judges that a vehicle is approaching based on the detection data of the sensors)
  - Vehicles in the detection area (blind spot area) that are driving at approximately the same speed as your vehicle for a long time
  - Vehicles that remain in the detection area when your vehicle starts from a full stop

WARNING (Continued)

## WARNING (Continued)

- In the following situations, the detection function of the sensors may decrease and the BSM may not operate properly.
  - When a strong impact applied to the sensors or around the sensors misaligns the position or direction of the sensors.
  - When any part of the rear bumper near the sensors is deformed or damaged.
  - When mud, snow, ice, and/or other similar substances are on the sensors or around the sensors.
  - When weather conditions are bad.
  - When the temperature around the sensors becomes extremely high or low.
  - When the vehicle is steeply inclined.
  - When multiple vehicles approach your vehicle continuously with little space between them.
  - When vehicles in the adjacent lane are too far away from your vehicle, such as when driving in wide lanes or on the side of a lane, etc.
  - When there is variation in the difference in the speed of your vehicle and the vehicle in the adjacent lane.
  - When there is a height difference between your vehicle and vehicles in the detection area.
  - When driving on a steep slope.
  - When driving continuously up and down steep slopes.
  - When driving on undulating roads.
  - When driving on a sharp curve or continuous curves.
  - When driving on snow covered roads for a long time.
- When towing another vehicle, turn off the BSM because the system may not operate normally.
- When the vehicle lane is very narrow and other vehicles are driving on the side of the road, vehicles driving 2 lanes away may be detected.

WARNING (Continued)

**WARNING (Continued)**

- The blind spot indicator may come on when stationary objects are on the road or the side of the road as follows.
  - Road signs
  - Parked vehicles
  - Guardrail or concrete wall that is close to your vehicle
  - Entrances of tunnels and turnouts
- The blind spot indicator may come on in the following situations.
  - When a tire is slipping (spinning).
  - When turning at an intersection in an urban area or an intersection with multiple lanes.

## Sensor Position

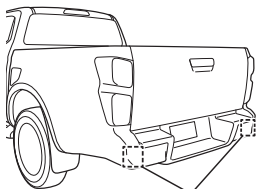

Radar sensors

Radar sensors are installed on the inner right and inner left sides of the rear bumper.

**ADVICE**

- Always keep the areas around the sensors on the rear bumper clean. If there is dirt around the sensors, the system may not operate properly.
- Do not subject the sensors or anything around the sensors to strong impact. If an impact misaligns the position or direction of the sensors, the system may not operate correctly. If a strong impact has occurred, be sure to contact the nearest Isuzu Dealer.
- Do not install any accessories or apply any stickers to areas around the sensors on the rear bumper. Doing so may result in an erroneous operation. Before installing accessories to the rear bumper, contact the nearest Isuzu Dealer.
- Do not do anything described below, because doing so may cause a malfunction.
  - Disassembly of the sensors
  - Modifying the sensors or any part of the rear bumper near the sensors
  - Painting the sensors or any part of the rear bumper near the sensors
- If the rear bumper needs to be replaced or removed, contact the nearest Isuzu Dealer.

### Operating Conditions of the BSM

The BSM operates when all of the following conditions are met.

- When the power mode is "ON" (models with passive entry and start system) or the starter switch is in the "ON" position (models without passive entry and start system).
- When the BSM is on.
- When your vehicle is moving at approximately 15 km/h (9 MPH) or more.
- When the gearshift lever is not in the "R" position (manual transmission model), or the selector lever is not in the "R" position (automatic transmission model).

### Detection Area of the Sensors

The sensors detect vehicles in the areas shown in the following figure.

- Detection area A (blind spot area): an area approximately 1 m (3 ft) ahead of the rear bumper to approximately 7 m (23 ft) behind the rear bumper
- Detection area B (proximity area): an area approximately 7 to 55 m (23 to 180 ft) behind the rear bumper

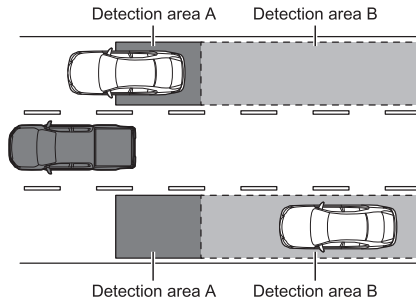

### NOTE

- In the case of detection area B, the greater the difference in the speed of your vehicle and the vehicle approaching from the rear is, the further away the approaching vehicle is when the blind spot indicators come on.

### Blind Spot Indicator

When the sensors detect vehicles in the detection area, the blind spot indicators come on. When the turn signal switch is operated to the side where the detected vehicle is while the blind spot indicator is on, the blind spot indicator flashes to alert the driver to the danger.

#### Right side

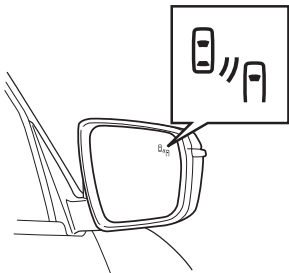

#### Left side

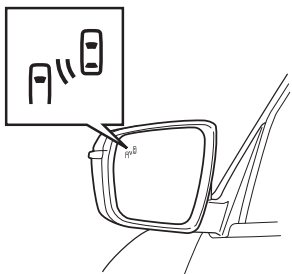

The blind spot indicators are on the face of the outside rearview mirrors on both sides.



#### NOTE

- The blind spot indicators may be difficult to see in the following cases.
  - In strong sunlight.
  - When the following vehicle's headlights shine on the indicators.
  - When mud, snow, ice, and/or other similar substances are on the outside rearview mirror.
  - When the front door windows are foggy, or when mud, snow, ice, and/or other similar substances are on them.
- When the light control switch is in the "AUTO" (with the taillights "ON"), "☞☞☞" or "☞☞☞" position, the blind spot indicators dim.

## When the System Is Unavailable

### BSM OFF indicator light

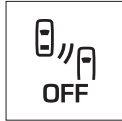

#### Warning message

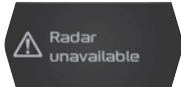

### BSM OFF indicator light

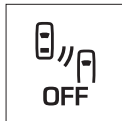

#### Warning message



### When the Sensor Temperature Is Extremely High or Low

When the system is used while the sensor temperature is extremely high or low, the system temporarily stops operating. At this time, the warning message is displayed on the MID for approximately 5 seconds, and then the BSM OFF indicator light comes on.

Check the condition of the sensor. When the condition of the sensor improves, the system recovers from the suspended state, and the BSM OFF indicator light turns off. If the indicator light remains on for a long time, contact the nearest Isuzu Dealer.

### When the Sensor Is Dirty

When mud, snow, and/or other similar substances are on the sensors or around the sensors, the system temporarily stops operating. At this time, the warning message is displayed on the MID for approximately 5 seconds, and then the BSM OFF indicator light comes on.

Check the condition of the sensor. Remove any mud, snow, and/or other similar substances that are on the sensors or around the sensors. When the condition of the sensor improves, the system recovers from the suspended state, and the BSM OFF indicator light turns off.

If the indicator light remains on for a long time, contact the nearest Isuzu Dealer.



## NOTE

- Even though the sensors are not dirty, while driving for a long time on a snow covered road or in an environment where there is nothing around, the warning message may appear on the MID and the BSM OFF indicator light may come on. The indicator light turns off when the driving environment improves.

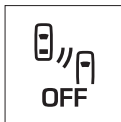
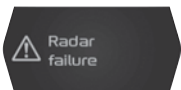
**Master warning light****BSM OFF indicator light****Warning message****When the System Has Malfunctioned**

When the system has malfunctioned, the warning message is displayed on the MID for approximately 5 seconds, and then the master warning light and the BSM OFF indicator light come on at the same time.

In this case, contact the nearest Isuzu Dealer.

**NOTE**

- If the BSM stops due to an abnormality in another system or device in the vehicle, the BSM OFF indicator light comes on. When the condition of the other system or device improves, the system recovers from the suspended state, and the indicator light turns off. If the indicator light remains on for a long time, contact the nearest Isuzu Dealer.

### To Turn Off the BSM

If you do not want the BSM to operate, it is possible to turn off the system.

The settings of the BSM can be changed by using the user customization function on the MID.

#### Settings (User Customization Function)

→ Refer to page 4-47

	Display indication		Description
Blind spot monitor	Warning	Enable	Turns on the BSM
		Disable	Turns off the BSM

#### BSM OFF indicator light

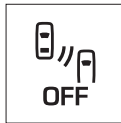

When the BSM is off, the BSM OFF indicator light comes on.



#### NOTE

- When the engine is restarted after it is stopped, the system keeps the state prior to the engine being stopped.
- The BSM is a system that assists the driver to confirm areas to the rear on the sides when changing lanes. Therefore, do not turn off the BSM except when necessary.
- When connecting a trailer, use a genuine Isuzu trailer harness. The BSM is automatically set to off. When a trailer is disconnected, the mode automatically switches to the registered status. It is not necessary to perform the setting on the user customization menu. Contact the nearest Isuzu Dealer for details.
- If the non-genuine Isuzu trailer harness is connected, turn off BSM by using the user customization function on the MID.

### Rear Cross Traffic Alert (RCTA)

The rear cross traffic alert (RCTA) is a system that assists the driver when checking the rear of the vehicle while driving the vehicle in reverse. This system uses radar sensors to detect the existence of vehicles approaching from the rear right or rear left while driving the vehicle in reverse and informs the driver of the danger with the blind spot indicators on the outside rearview mirrors and a buzzer.

#### **WARNING**

- The driver is responsible for safe driving. Always visually check the surrounding area to be safe when driving the vehicle.
- The RCTA is a system that assists the driver when checking the rear of the vehicle while driving the vehicle in reverse. To rely entirely on the system may cause a serious accident. Because the system may not operate depending on the situation, always visually check the rear and surrounding area to be safe when driving the vehicle in reverse.
- The sensors may not detect or may find it difficult to detect the following objects.
  - Small-sized motorcycles, bicycles, and pedestrians
  - Stationary objects on roads or the sides of roads
  - Vehicles whose shapes do not effectively reflect the radar waves (sports cars etc.)
  - A vehicle moving backward in the parking space next to your vehicle
  - A vehicle approaching from the parking space next to your vehicle
  - A vehicle approaching from behind your vehicle
  - A vehicle moving away from your vehicle
- In the following situations, the detection function of the radar sensors may decrease and the RCTA may not operate properly.
  - When a strong impact applied to the sensors or around the sensors misaligns the position or direction of the sensors.
  - When mud, snow, ice, and/or other similar substances are on the sensors or around the sensors.
  - When weather conditions are bad.
  - When multiple vehicles approach your vehicle continuously with little space between them.
  - When the temperature around the sensors becomes extremely high or low.
  - When the vehicle is steeply inclined.

WARNING (Continued)

**WARNING (Continued)**

- When the detection area of the sensors is blocked by adjacent walls, parked vehicles, etc.
- When the vehicle is parked at an angle.
- When a tow hook is mounted to the back of the vehicle.
- When a vehicle approaches your vehicle at high speed.
- When driving the vehicle in reverse to exit from an inclined parking space.
- When the gearshift lever (manual transmission model) or selector lever (automatic transmission model) has just been placed into the "R" position.
- When towing another vehicle, turn off the RCTA because the system may not operate normally.
- Do not place anything around the sensors. Doing so may obstruct the sensor detection and the system may not operate properly.
- In the following cases, the blind spot indicator may flash and a buzzer may sound.
  - When a vehicle passes by your vehicle.
  - When another vehicle is driving on a road adjacent to the parking lot.
  - When there are stationary objects (guard rails, walls, road signs, parked vehicles, etc.) behind the vehicle.

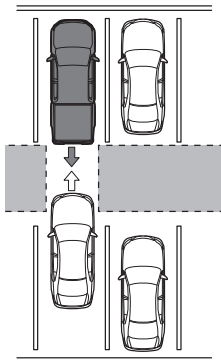
**A vehicle approaching from behind your vehicle**

When the detection area of the sensors is blocked by adjacent walls, parked vehicles, etc.

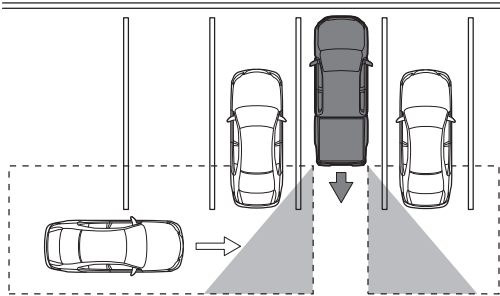

When the vehicle is parked at an angle

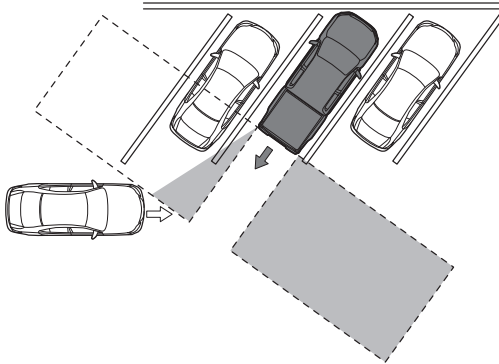

## Sensor Position

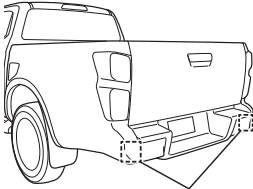

Radar sensors

Radar sensors are installed on the inner right and inner left sides of the rear bumper.

**ADVICE**

- Always keep the areas around the sensors on the rear bumper clean. If there is dirt around the sensors, the system may not operate properly.
- Do not subject the sensors or anything around the sensors to strong impact. If an impact misaligns the position or direction of the sensors, the system may not operate correctly. If a strong impact has occurred, be sure to contact the nearest Isuzu Dealer.
- Do not install any accessories or apply any stickers to areas around the sensors on the rear bumper. Doing so may result in an erroneous operation. Before installing accessories to the rear bumper, contact the nearest Isuzu Dealer.
- Do not do anything described below, because doing so may cause a malfunction.
  - Disassembly of the sensors
  - Modifying the sensors or any part of the rear bumper near the sensors
  - Painting the sensors or any part of the rear bumper near the sensors
- If the rear bumper needs to be replaced or removed, contact the nearest Isuzu Dealer.

### Operating Conditions of the RCTA

The RCTA operates when all the following conditions are met.

- When the power mode is "ON" (models with passive entry and start system) or the starter switch is in the "ON" position (models without passive entry and start system).
- When the RCTA is on.
- When the speed of your vehicle is approximately 10 km/h (6 MPH) or less.
- When the gearshift lever (manual transmission model) or selector lever (automatic transmission model) is placed in the "R" position.

### Detection Area of the Sensors

The sensors detect vehicles in the areas shown in the following figure.

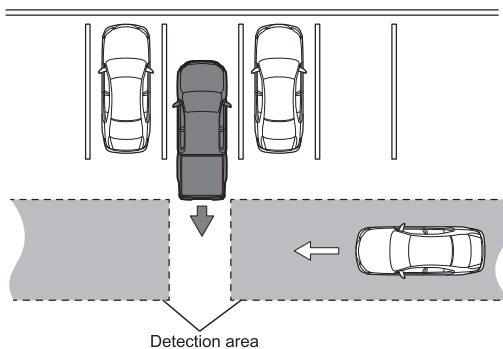

#### NOTE

- The higher the speed of the vehicle approaching from the rear right or rear left is, the farther away the vehicle is when the blind spot indicator flashes and a buzzer sounds.

**Blind Spot Indicator/Buzzer**

When the sensors detect vehicles in the detection area, the blind spot indicator flashes and a buzzer sounds to inform the driver of the danger.

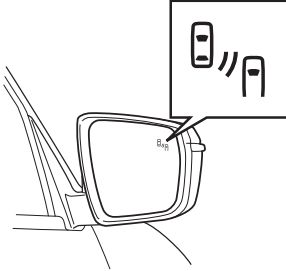
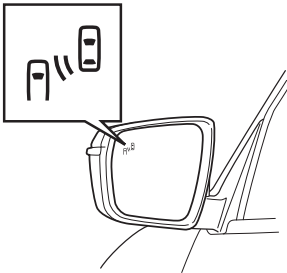
**Right side****Left side**

The blind spot indicators are on the face of the outside rearview mirrors on both sides.

**NOTE**

- The blind spot indicators may be difficult to see in the following cases.
  - In strong sunlight.
  - When the following vehicle's headlights shine on the indicators.
  - When mud, snow, ice, and/or other similar substances are on the outside rearview mirror.
  - When the front door windows are foggy, or when mud, snow, ice, and/or other similar substances are on them.
- When the light control switch is in the "AUTO" (with the taillights "ON"), "☰" or "☷" position, the blind spot indicators dim.

### When the System Is Unavailable

#### BSM OFF indicator light

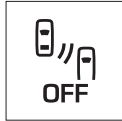

#### Warning message

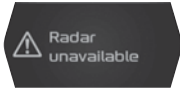

#### When the Sensor Temperature Is Extremely High or Low

When the system is used while the sensor temperature is extremely high or low, the system temporarily stops operating. At this time, the warning message is displayed on the MID for approximately 5 seconds, and then the BSM OFF indicator light comes on.

Check the condition of the sensor. When the condition of the sensor improves, the system recovers from the suspended state, and the BSM OFF indicator light turns off. If the indicator light remains on for a long time, contact the nearest Isuzu Dealer.

#### BSM OFF indicator light



#### Warning message

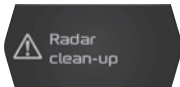

#### When the Sensor Is Dirty

When mud, snow, and/or other similar substances are on the sensors or around the sensors, the system temporarily stops operating. At this time, the warning message is displayed on the MID for approximately 5 seconds, and then the BSM OFF indicator light comes on.

Check the condition of the sensor. Remove any mud, snow, and/or other similar substances that are on the sensors or around the sensors. When the condition of the sensor improves, the system recovers from the suspended state, and the BSM OFF indicator light turns off.

If the indicator light remains on for a long time, contact the nearest Isuzu Dealer.

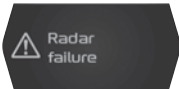
**Master warning light****BSM OFF indicator light****Warning message****When the System Has Malfunctioned**

When the system has malfunctioned, the warning message is displayed on the MID for approximately 5 seconds, and then the master warning light and the BSM OFF indicator light come on at the same time.

In this case, contact the nearest Isuzu Dealer.

**NOTE**

- If the RCTA stops due to an abnormality in another system or device in the vehicle, the BSM OFF indicator light comes on. When the condition of the other system or device improves, the system recovers from the suspended state, and the indicator light turns off. If the indicator light remains on for a long time, contact the nearest Isuzu Dealer.

### To Turn Off the RCTA

If you do not want the RCTA to operate, it is possible to turn off the system.

The settings of the RCTA can be changed by using the user customization function on the MID.

#### Settings (User Customization Function)

→ Refer to page 4-47

Display indication		Description	
Rear cross traffic alert	Warning	Enable	Turns on the RCTA
		Disable	Turns off the RCTA



#### NOTE

- When the engine is restarted after it is stopped, the system keeps the state prior to engine being stopped.
- It takes some time for the RCTA to operate normally after the RCTA is turned on after being off.
- The RCTA is a system that assists the driver when checking the rear of the vehicle. Therefore, do not turn off the RCTA except when necessary.
- When connecting a trailer, use a genuine Isuzu trailer harness. The RCTA is automatically set to off. When a trailer is disconnected, the mode automatically switches to the registered status. It is not necessary to perform the setting on the user customization menu. Contact the nearest Isuzu Dealer for details.
- If the non-genuine Isuzu trailer harness is connected, turn off RCTA by using the user customization function on the MID.

## Parking Aid System

The parking aid system is a system that assists the driver to park the vehicle. This system uses ultrasonic sensors to detect obstacles around the vehicle and informs the driver of the presence of obstacles by displays on the MID and a buzzer.

### WARNING

- The driver is responsible for safe driving. Always visually check the surrounding area to be safe when driving the vehicle.
- The parking aid system is a system that assists the driver to park the vehicle. To rely entirely on the system may cause a serious accident. Because the system may not operate depending on the situation, always visually check the rear and surrounding area to be safe when parking the vehicle.
- The sensors may not detect or may find it difficult to detect the following objects.
  - Pedestrians
  - Moving objects such as vehicles and animals
  - Objects directly below the bumper
  - Thin or low objects
  - Stringy objects, such as wires, fence, and ropes
  - Objects made of materials that are likely to absorb sound, such as snow, clothes, and sponges
  - Sharp objects
  - Objects with angled surfaces
  - Objects in high places, such as suspended objects
  - Objects that already existed near the sensor before the system was started
- In the following situations, the detection function of the sensors may be reduced and the system may not operate properly.
  - When the temperature around the sensors becomes extremely high or low.
  - When weather conditions are bad.
  - When a large amount of water splashes over the sensors due to heavy rain or other such situations.
  - When the sensors are exposed to water while driving on a flooded road.
  - When the vehicle is steeply inclined.
  - When objects or walls are close to the vehicle, such as when the vehicle is in a narrow tunnel, on a narrow bridge or narrow road, or in a small garage.
  - When driving on a steep slope.
  - When there is a steep slope in the direction the vehicle is moving.

WARNING (Continued)

## WARNING (Continued)

- When there are curbstones in the direction the vehicle is moving.
  - When driving on an uneven road.
  - When mud, snow, ice, and/or other similar substances are on the sensors or around the sensors.
  - When the sensors or areas around the sensors are blocked.
  - When a strong impact applied to the sensors or around the sensors misaligns the position or direction of the sensors.
  - When the vehicle is on an undulating, inclined, gravel, or rough road, or in bushes.
  - When something that generates high-frequency sounds, such as the horn sound of another vehicle, the engine sound of a motorbike, the air brake noise of a large-sized vehicle, or something that generates ultrasonic waves, such as the sensor of another vehicle, is nearby.
  - When an obstacle is too close to the sensors.
- There is a delay after an obstacle is detected before the buzzer sounds and the detection status is displayed on the MID. Even when the vehicle speed is extremely low, the vehicle may approach the obstacle before the buzzer sounds and the detection status is displayed on the MID.
  - Depending on the shape and/or conditions of the obstacle, even after an obstacle has been detected once, the system may not detect the obstacle after approaching it.
  - When you drive your vehicle in reverse while your vehicle is towing another vehicle, the rear sensors may react to the vehicle being towed, causing the warning to remain on. Therefore, set the parking aid system mode as follows before towing another vehicle.
    - When only a trailer hitch is mounted: Trailer hitch only
    - When towing another vehicle: Off

**Trailer Mode/Bull Bar Mode**

→ Refer to page 4-205

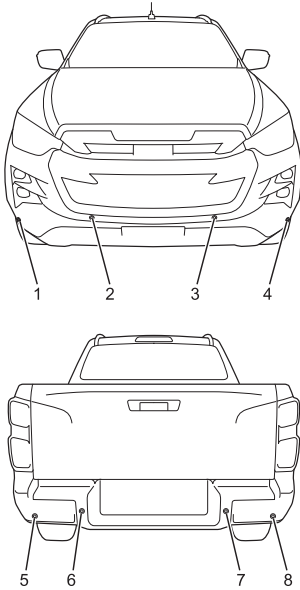
**Sensor Position and Detection Range****Sensor Position**

The ultrasonic sensors are installed in 4 places at the front of the vehicle (in models with front sensors) and in 4 places at the rear of the vehicle.

No.	Description
1	Front outer sensor (right side)
2	Front inner sensor (right side)
3	Front inner sensor (left side)
4	Front outer sensor (left side)
5	Rear outer sensor (left side)
6	Rear inner sensor (left side)
7	Rear inner sensor (right side)
8	Rear outer sensor (right side)

**ADVICE**

- Always keep the areas around the sensors clean. If there is dirt around the sensors, the system may not operate properly.
- Do not subject the sensors or anything around the sensors to strong impact. If an impact misaligns the position or direction of the sensors, the system may not operate correctly. If a strong impact has occurred, be sure to contact the nearest Isuzu Dealer.
- Do not install any accessories or apply any stickers to the sensors or within the range of the sensors. Doing so may result in an erroneous operation. Before installing accessories to areas around the sensors, contact the nearest Isuzu Dealer.
- Do not do anything described below, because doing so may cause a malfunction.
  - Disassembly of the sensors
  - Modification of the sensors or anything near the sensors
  - Painting the sensors or anything near the sensors
- If the sensors or anything around the sensors need to be repaired, replaced, removed, or installed, contact the nearest Isuzu Dealer.
- When washing the vehicle, do not spray water directly on the sensors or around the sensors with a high-pressure washer. Due to the strong impact of high-pressure water, the sensor may not work properly.

**Detection Range**

The sensors detect obstacles in the areas shown in the following figure.

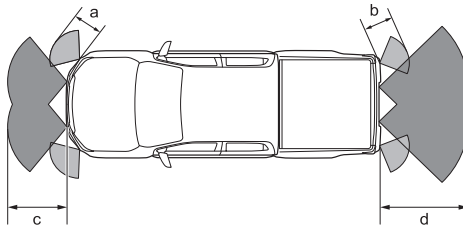

No.	Description
a	Approximately 60 cm (24 in) (front outer sensor)
b	Approximately 60 cm (24 in) (rear outer sensor)
c	Approximately 100 cm (39 in) (front inner sensor)
d	Approximately 150 cm (59 in) (rear inner sensor)

 **WARNING**

- The sensor detection range and operating speed have limits. To rely entirely on the system may cause a serious accident. Because the system may not activate depending on the situation, always visually check the rear and surrounding area to be safe when parking the vehicle.

### Parking Aid System Operation

The parking aid system operates when all the following conditions are met.

- When the power mode is "ON" (models with passive entry and start system) or the starter switch is in the "ON" position (models without passive entry and start system).
- When the parking aid system is on.
- When the speed of your vehicle is approximately 10 km/h (6 MPH) or less.

#### When the Vehicle Is Moving Backward

When the gearshift lever (manual transmission model) or selector lever (automatic transmission model) is in the "R" position, the parking aid system operates.

While the system is operating, the detection statuses of the front sensors (models with front sensors) and the rear sensors are displayed on the MID.

When the sensors detect an obstacle, the distance between the vehicle and the obstacle is displayed on the MID and a buzzer sounds corresponding to the distance.

 **NOTE**

- The front inner sensors do not detect obstacles.

#### When the Vehicle Is Moving Forward (Models with Front Sensors)

In manual transmission models, when the gearshift lever is placed in any position other than the "R" position or "N" position, the parking aid system operates.

In automatic transmission models, when the selector lever is placed in the "D" position, the parking aid system operates.

While the system is operating, the detection status of the front sensors is displayed on the MID.

When the sensors detect an obstacle, the distance between the vehicle and the obstacle is displayed on the MID and a buzzer sounds corresponding to the distance.

 **NOTE**

- None of the rear sensors detect obstacles.

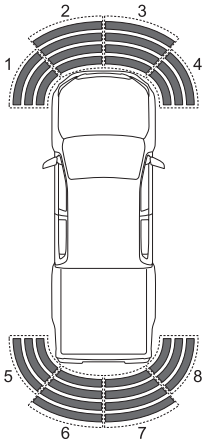

## Display of the Detection Status



The detection status is displayed on the MID. When the sensors detect an obstacle, the display that indicates the distance between the vehicle and the obstacle comes on red. The distance to the obstacle is indicated separately for each sensor.

No.	Description
1	Front outer sensor (left side)
2	Front inner sensor (left side)
3	Front inner sensor (right side)
4	Front outer sensor (right side)
5	Rear outer sensor (left side)
6	Rear inner sensor (left side)
7	Rear inner sensor (right side)
8	Rear outer sensor (right side)

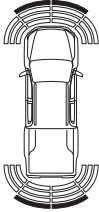
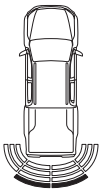
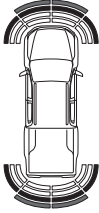
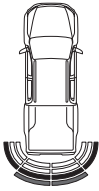
The display of the detection status and the distance to the obstacle is explained in the following table.

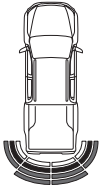
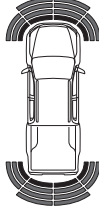
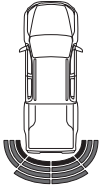
Display		Distance between the vehicle and an obstacle (Distance is approximate)			
Models with front and rear sensors	Models with rear sensors	Front		Rear	
		Inner sensor	Outer sensor	Inner sensor	Outer sensor
		75 - 100 cm (30 - 39 in)	—	75 - 150 cm (30 - 59 in) *80 - 150 cm (31 - 59 in)	—
		60 - 75 cm (24 - 30 in)	50 - 60 cm (20 - 24 in)	60 - 75 cm (24 - 30 in) *70 - 80 cm (28 - 31 in)	50 - 60 cm (20 - 24 in)
		45 - 60 cm (18 - 24 in)	40 - 50 cm (16 - 20 in)	45 - 60 cm (18 - 24 in) *60 - 70 cm (24 - 28 in)	40 - 50 cm (16 - 20 in)
		Within 45 cm (18 in)	Within 40 cm (16 in)	Within 45 cm (18 in) *Within 60 cm (24 in)	Within 40 cm (16 in)

\*: When the trailer hitch mode is selected.

**Buzzer**

When the sensors detect an obstacle, the buzzer sounds at one of 4 levels, depending on the distance between the vehicle and the obstacle.

As the distance between the vehicle and the obstacle decreases, the interval between beeps gradually becomes shorter until the beeping becomes continuous when the obstacle is too close.

When multiple sensors simultaneously detect obstacles, a buzzer corresponding to the distance between the closest obstacle and the vehicle sounds.

**NOTE**

- When the outer sensors detect an obstacle, the buzzer sounds at one of 3 levels.

**Trailer Mode/Bull Bar Mode**

**Trailer Mode**

When a trailer hitch is attached and a trailer is being towed, change the parking aid system settings.



**CAUTION**

- Before mounting a trailer hitch, contact the nearest Isuzu Dealer.

The settings of the parking aid system can be changed by using the user customization function on the MID.

**Settings (User Customization Function)**

→ Refer to page 4-47

Display indication		Description
Parking aid settings	Trailer mode	Off Select to cancel trailer mode.
		Trailer hitch only Select when a trailer hitch is mounted but a trailer is not being towed. When this mode is selected, the detection distance of the rear inner sensor changes.



**NOTE**

- When connecting a trailer, use a genuine Isuzu trailer hitch and trailer harness. The rear parking aid system is automatically set to off, and the warning buzzer does not sound. When a trailer is disconnected, the mode automatically switches to "Trailer hitch only" and the rear parking aid system is set to on. It is not necessary to perform the setting on the user customization menu. Consult the nearest Isuzu Dealer for details.
- If the non-genuine Isuzu trailer hitch and/or trailer harness are connected, turn off trailer mode by using the parking aid system OFF switch.

**Parking Aid System OFF Switch**

→ Refer to page 4-209

**Bull Bar Mode**

When a bull bar is mounted, change the parking aid system settings.

**CAUTION**

- Before mounting a bull bar, contact the nearest Isuzu Dealer.

The settings of the parking aid system can be changed by using the user customization function on the MID.

**Settings (User Customization Function)**

→ Refer to page 4-47

Display indication		Description	
Parking aid settings	Bull bar mode	Without bull bar	Select to cancel the bull bar mode.
		With bull bar	Select when a bull bar is mounted. When this mode is selected, none of the front sensors detect obstacles.

**NOTE**

- When a genuine Isuzu bull bar is installed, the front sonar can be used as it is. In this case, select "Without bull bar". Contact the nearest Isuzu Dealer for details.

## When the System Is Unavailable

### Parking aid system OFF indicator light



#### Warning message

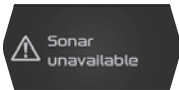

### Parking aid system OFF indicator light



#### Warning message

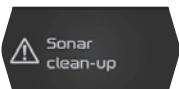

### When the Sensor Is in a Condition Where It Cannot Detect Normally

When the system is used while the sensor is in a condition where it cannot detect normally, such as being affected by noise, the system temporarily stops operating. At this time, the warning message is displayed on the MID for approximately 5 seconds, and then the parking aid system OFF indicator light comes on. Check the condition of the sensor. When the condition of the sensor improves, the system recovers from the suspended state, and the parking aid system OFF indicator light turns off.

If the indicator light remains on for a long time, contact the nearest Isuzu Dealer.

### When the Sensor Is Dirty

When mud, snow, and/or other similar substances are on the sensors or around the sensors, the system temporarily stops operating. At this time, the warning message is displayed on the MID for approximately 5 seconds, and then the parking aid system OFF indicator light comes on. Check the condition of the sensor. Remove any mud, snow, and/or other similar substances that are on the sensors or around the sensors. When the condition of the sensor improves, the system recovers from the suspended state, and the parking aid system OFF indicator light turns off.

If the indicator light remains on for a long time, contact the nearest Isuzu Dealer.

**Master warning light****Parking aid system OFF indicator light****Warning message****When the System Has Malfunctioned**

When the system has malfunctioned, the warning message is displayed on the MID for approximately 5 seconds, and then the master warning light and the parking aid system OFF indicator light come on at the same time.

In this case, contact the nearest Isuzu Dealer.

**NOTE**

- If the parking aid system stops due to an abnormality in another system or device in the vehicle, the parking aid system OFF indicator light comes on. When the condition of the other system or device improves, the system recovers from the suspended state, and the indicator light turns off. If the indicator light remains on for a long time, contact the nearest Isuzu Dealer.

## Parking Aid System OFF Switch

### Manual transmission model

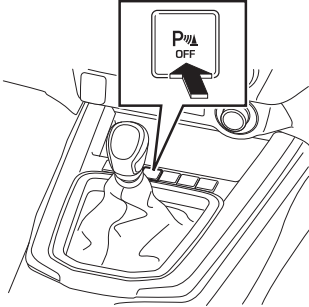

### Automatic transmission model

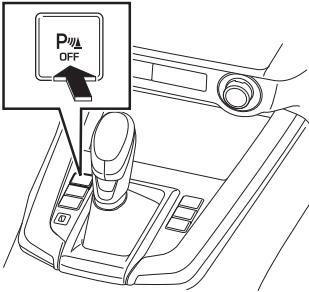

### Parking aid system OFF indicator light



If you do not want the parking aid system to operate, it is possible to turn off the system. When the parking aid system OFF switch is pressed while the parking aid system is on, the parking aid system OFF indicator light comes on and the system is turned off.

To return the system to on, press the parking aid system OFF switch again. The parking aid system OFF indicator light turns off and the system is turned on.



### NOTE

- Even after the parking aid system has been turned off by pressing the parking aid system OFF switch, restarting the engine turns on the system again.
- It takes some time for the system to operate normally after the parking aid system is turned on after being off.
- The parking aid system is a system that assists the driver to park the vehicle. Therefore, do not turn off the system except when necessary.

## Stereo Camera

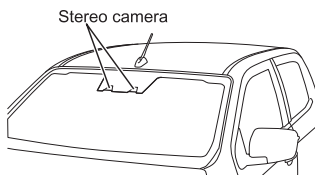

The stereo camera detects objects (vehicles, obstacles, lanes, road signs, or pedestrians) in front of the vehicle.

The stereo camera is installed at the top of the windshield.

The following systems use the stereo camera.

- Autonomous emergency braking (AEB)
- Pedal misapplication mitigation
- Adaptive cruise control (ACC)
- Manual speed limiter (MSL)
- Lane departure warning (LDW)
- Lane departure prevention (LDP)
- Attention assist
- Lane keep assist system (LKAS)
- Emergency lane keeping (ELK)
- Automatic high beam (AHB)

### **WARNING**

- The stereo camera cannot detect all objects (vehicles, obstacles, lanes, road signs, or pedestrians) because the detection function of the stereo camera has limits.
- While driving, always check the surrounding area yourself to be safe and operate the brake pedal or perform other appropriate operations as necessary.

WARNING (Continued)

**WARNING (Continued)**

- Do not rely only on the stereo camera system when driving. The purpose of the stereo camera system is to mitigate accident damage and driver's stress by assisting the driver's judgment. If a warning is activated, check the front and surroundings, and perform appropriate operations, such as depressing the brake pedal, according to the driver's judgment.
- The stereo camera system does not prevent you from being inattentive of the road in front of you, such as driving while looking away or being distracted, nor does it support driving while your view is impaired in bad weather. Also, it is not intended to be used for avoiding collisions under any circumstances. The stereo camera has limited capabilities to recognize objects and control the vehicle. Be sure to read the warnings on each page and use it correctly. If it is used incorrectly, it cannot execute controls appropriately, resulting in an unexpected accident.

### Handling the Stereo Camera

Observe the following for proper stereo camera operations. Mishandling it may lead to improper detection of objects or an unexpected accident.

- Do not touch the lens of the stereo camera.
- Do not clean the lens of the stereo camera.
- Do not change the mounting position of the stereo camera or modify any components around it.
- Do not subject the lens body of the stereo camera or the area around it to a strong impact or force.
- Do not remove or disassemble the stereo camera.
- Do not expose the stereo camera to water or any other liquids.
- Do not attach films, stickers, etc. to the lens of the stereo camera (including transparent ones).
- Do not use smoke-type deodorants, etc.
- Replace the wiper blades as needed, without delay. If there are any poorly wiped areas on the windshield, recognition by the stereo camera may become unstable and the system may not operate properly.
- Do not allow luggage on the roof to enter the field of view of the stereo camera. Doing so may affect the field of view of the stereo camera, and the system may not operate properly. For details, contact an Isuzu Dealer.
- Always keep the windshield (outside and inside) clean. If the windshield is foggy, dirty, oily, or frosty, recognition by the stereo camera may become unstable and the system may not operate properly. If the windshield is foggy, misty, or frosty, use the defroster to dry it. If dirt, oil, or anything else is on the windshield, wipe it off.
- If the windshield is scratched, cracked, etc., contact an Isuzu Dealer.
- If you are driving while the area around the stereo camera is deformed or damaged, such as due to an accidental collision, or while the windshield in front of the stereo camera is cracked or damaged, the stereo camera cannot correctly detect objects, which could cause an erroneous operation resulting in an unexpected accident.
- Do not install any non-genuine Isuzu accessories or attach films, stickers, etc. to the following areas. Doing so may affect the field of view of the stereo camera, so it cannot detect reliably, and the stereo camera and the systems using the stereo camera may not operate properly. You may need to move these items, even if they are in other locations, if their reflected light or reflections on the windshield cause the stereo camera to operate abnormally.
  - Prohibited area
- Do not install anything on the engine hood, radiator grill, or front bumper, except for genuine Isuzu accessories. Doing so may affect the field of view of the stereo camera, so it cannot detect reliably, and the stereo camera and the systems using the stereo camera may not operate properly.

- When replacing the windshield, consult with the nearest Isuzu Dealer to be sure steps are taken to ensure the proper operation of the camera. The use of a non-genuine windshield may affect the stereo camera operations. Please note that Isuzu cannot guarantee the performance of any non-genuine windshield glass.

### Windshield

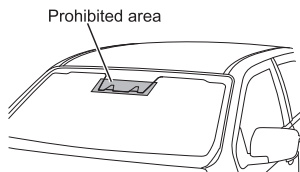

### Instrument panel

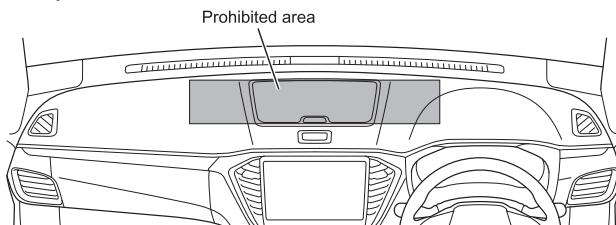

### ADVICE

- Do not touch or clean the lens of the stereo camera. If the lens becomes dirty, the stereo camera needs to be replaced.

### Stereo Camera Detection Function

The stereo camera can detect only objects within its field of view. In addition, after an object enters the stereo camera's field of view, it takes a few seconds to detect it. It is difficult for the stereo camera to detect objects when the front visibility is poor due to fog, heavy rain, etc.

The stereo camera has characteristics similar to the human eye. Therefore, when it is hard for the driver to see in front of the vehicle, the stereo camera has similar trouble recognizing vehicles, obstacles, and lanes around the front of your vehicle.



#### WARNING

- In the following situations, there is a high possibility that the stereo camera cannot detect the objects in front of the vehicle. Also, the systems that use the stereo camera may be temporarily stopped. The systems become operable again when the conditions are improved.
  - In bad weather (such as rainstorms, blizzards, or snow)
  - When the vehicle is subject to strong light from the forward direction (backlight, light of oncoming vehicle headlights, etc.)
  - When the surrounding area is all the same color, such as the area is completely covered with snow
  - When it is dark and there is nothing around
  - When the visibility in the forward direction is poor due to the front vehicle's exhaust gas, splashing water, or blowing snow, water vapor, sand, smoke, etc.
  - When approaching an object in a dark place, such as in the dim light of early evening or morning, in the dark of night, or in an indoor parking lot
  - When an object is outside the range of the headlights' illumination or in a dark place
  - When the windshield is foggy or dirty due to snow, ice, dust, and/or other substances
  - When the stereo camera's field of view is blocked due to fog, snow, dirt, frost, dust, or scratches on the windshield, or when light is reflected on these substances
  - When the windshield is not sufficiently wiped during or after using the front windshield washer
  - When there are poorly wiped areas
  - If a non-genuine Isuzu wiper blade is installed
  - After a glass coating agent has been applied

WARNING (Continued)

## WARNING (Continued)

- If using a non-genuine Isuzu windshield
  - If the top surface of the instrument panel is glossy due to being wiped with a chemical agent or other substance
  - When something reflects off the windshield
  - When the lens is blocked by someone's hand, etc.
  - When there are dirt, fingerprints, or scratches on the lens
  - If the stereo camera's field of view is blocked (if a sticker or film has been attached to the windshield, if the windshield is scratched, cracked, etc., if long objects, such as a roof carrier or skis, are loaded on the vehicle)
  - When the vehicle is extremely tilted as heavy cargo is loaded or unloaded
  - When tire air pressure is not adequate
  - When worn tires or tires with a significant difference in wear are installed
  - When tires that are not the designated size are installed
  - When tire chains are installed
  - When the wheel balance is abnormal (loss or misalignment, etc. of a balance weight)
  - When the wheel alignment is misaligned
  - After a temporary repair has been made for a flat tire
  - When the vehicle drives unstably due to a traffic accident or malfunction
  - After the suspension has been replaced (including replacement with genuine Isuzu parts)
  - When the brightness drastically changes, such as when entering or exiting a tunnel or when going under an overpass
  - When the vehicle passes through hanging banners/flags, pendulous branches, or bushes, etc.
  - When the stereo camera is misaligned or deformed due to an impact to it
  - When the vehicle is traveling at night or in a tunnel without the headlights on
  - When driving on steep slopes, sharp curves, or across joints in the road
  - When the shape of curves change rapidly
  - When the road surface is uneven, such as if it is bumpy or unpaved
  - When the headlight beams are misaligned
  - If the headlights and/or fog lights have been modified
  - When dirt, snow, mud, and/or other similar substances are on the headlights
- Under the following conditions, the systems using the stereo camera may temporarily stop. The systems reactivate when the conditions are improved.

WARNING (Continued)

## WARNING (Continued)

- When the vehicle attitude changes significantly as cargo is loaded or unloaded
- When the temperature inside the vehicle is high, such as after being left in the sun, or when the temperature inside the vehicle is low, such as after being left in an extremely cold environment
- Immediately after the engine has been started
- In the following situations or with the following objects, the stereo camera may not detect objects or it may take a longer time to detect them.
  - Front vehicles with a rear surface that is small (such as trailers), low, or uneven (such as trucks with no load, side gates, or rear gates, vehicles with a load sticking out from the end, vehicles with a special shape, such as car carriers and side cars, or vehicles with a low vehicle height, etc.)
  - The preceding vehicle is weaving
  - The preceding vehicle significantly reflects sunlight or other light
  - Oncoming vehicles or vehicles moving backward
  - Vehicles facing in a lateral direction
  - The preceding vehicle's taillights are not on at night or in a tunnel
  - There is a wall or other objects in front of the stopped vehicle
  - There is another obstacle near the vehicle
  - An obstacle, such as a fence, or a wall or a shutter with a uniform pattern (such as a striped brick pattern) or no pattern, etc.
  - An obstacle shaped like a pole, such as a road sign or street light
  - An obstacle that has a low height
  - An obstacle, such as a mirror wall or door, or glass
  - An object that has a low height, such as a small animal or an infant
  - Guardrail
  - Utility pole or tree
  - An object that is close to the bumper of your vehicle
  - Only a part of the front vehicle is within the detection range of the stereo camera
  - When an object is smaller than the stereo camera recognition limits for size
  - When an object is not laterally aligned with your vehicle
  - While driving on a curve, or for a while after turning a curve
  - When there is an extremely large difference in the speed of your vehicle and the front vehicle
  - When the vehicle is too close to the front vehicle

WARNING (Continued)

## WARNING (Continued)

- The front vehicle is suddenly steered, accelerated, or decelerated
- When an object is outside the range of the headlights' illumination
- An object has run out from the side just in front of your vehicle
- Your vehicle changes lanes and comes close to just behind the preceding vehicle
- In the following situations, the stereo camera may not detect lanes or it may take a longer time to detect them.
  - Lanes are too narrow or too wide
  - The width of the vehicle lane changes
  - The shape of lanes changes drastically (such as at the start or end of curves, at speed limiting systems, on continuously curving roads, or in branching lanes)
  - Lane markings do not exist or are fading
  - The lane marking colors are similar to the road color
  - Lane markings are drawn in yellow
  - Lane markings are drawn twice
  - Only one side of the lane marking is drawn
  - Multiple lane markings are adjacent
  - There are lines that are indistinguishable from lane markings, such as leftover lines from road construction
  - Driving astride a lane due to lane restrictions
  - Lane markings are blurred or dirty
  - The lane marking is impossible or difficult to see due to sand or dust
  - A wall or pole is adjacent to the lane
  - Shadows, such as of guardrails, cover the lane
  - There are embedded road reflectors, stones, etc.
  - Driving on a wet road, such as in rainy weather, after rain, or a road with puddles
  - Lane markings are drawn on a curbstone, etc. or outside the road
  - There are curbstones or side walls on the road shoulder
  - Driving on a road that is shiny due to reflections, etc.
  - Immediately after changing lanes or passing an intersection
  - Your vehicle is too close to the front vehicle

### Detection of Pedestrians and Bicycle Riders by the Stereo Camera

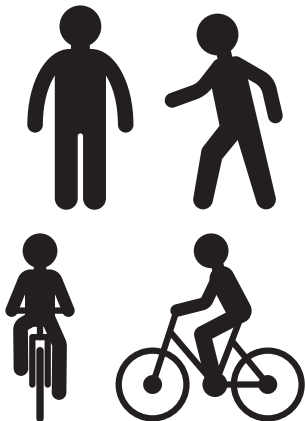

The stereo camera detects objects as pedestrians and bicycle riders based on their size, shape, and movement. It detects pedestrians when the outlines of their head and both shoulders are clear.

#### **WARNING**

- The stereo camera cannot always detect pedestrians/bicycle riders. In the following situations, it may not detect pedestrians/bicycle riders.
  - When pedestrians are walking in a group
  - When a pedestrian/bicycle rider is near a wall or an obstacle
  - When a pedestrian/bicycle rider is using an umbrella
  - When a pedestrian/bicycle rider is a similar color to the background and blends into the background
  - When a pedestrian/bicycle rider is carrying a large object
  - When a pedestrian/bicycle rider is bending forward, crouching, or lying down
  - When a pedestrian/bicycle rider is outside the range of the headlights' illumination or in a dark place
  - When a pedestrian/bicycle rider suddenly runs out from the side
  - When a pedestrian/bicycle rider is very close to your vehicle
  - When a pedestrian is riding on a bicycle for a child, a bicycle loaded with large objects, a bicycle with more than one passenger, or a bicycle with a special shape (e.g. a bicycle equipped with a CRS, a tandem bicycle)

WARNING (Continued)

## WARNING (Continued)

- When the height of a pedestrian/bicycle rider is approximately 1 m (3 ft) or less, or approximately 2 m (7 ft) or more
- When the outline of a pedestrian's/bicycle rider's body is vague, such as when the pedestrian/rider is wearing a raincoat or long skirt
- When a pedestrian/bicycle rider is moving fast
- When a pedestrian is pushing a stroller, wheelchair, bicycle, etc.

**When the Stereo Camera Is Unavailable**

In the following cases, the stereo camera is temporarily stopped or malfunctions.

 **WARNING**

- If the stereo camera is temporarily stopped or malfunctions, the systems that use the stereo camera are stopped.

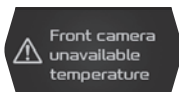
**Warning message****When the Temperature of the Stereo Camera Is Extremely Hot/Cold Temporarily**

When the stereo camera temperature is extremely high or low, the stereo camera temporarily stops.

At this time, the warning message is displayed on the MID for approximately 5 seconds, and then the following indicator lights come on.

- Autonomous emergency braking OFF indicator light
- Lane departure warning OFF indicator light

When the condition of the stereo camera improves, the stereo camera recovers from the suspended state, and the indicator lights turn off.

If the indicator light remains on for a long time, contact the nearest Isuzu Dealer.

**ADVICE**

- If the stereo camera is hot, such as after the vehicle has been parked in the sun, use the air conditioner to lower the temperature around the camera. In particular, using a sunshade that reflects sunlight when parked can increase the temperature of the stereo camera.
- If the temperature of the stereo camera is low, such as after the vehicle has been parked in an extremely cold environment, use the air conditioner to increase the temperature around the stereo camera.
- Even if the stereo camera system is temporarily stopped, it does not interfere with normal driving.

**NOTE**

- While there is a malfunction in the stereo camera, the warning message is displayed on the MID for approximately 5 seconds, approximately every 3 minutes.

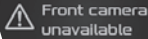
**Warning message****When the Stereo Camera Detects an Abnormality**

Under the following conditions, the stereo camera temporarily stops.

- When the stereo camera detects a potential misalignment condition because of how cargo is loaded or unloaded
- When the AEB has activated 3 times since the engine was started
- When the automatic adjustment of the stereo camera is insufficient
- When there is an abnormality in the systems related to the stereo camera system
- When the battery voltage becomes temporarily abnormal

At this time, the warning message is displayed on the MID for approximately 5 seconds, and then the following indicator lights come on.

- Autonomous emergency braking OFF indicator light
- Lane departure warning OFF indicator light

When the condition of the stereo camera improves, the stereo camera recovers from the suspended state, and the indicator lights turn off.

If the indicator light remains on for a long time, contact the nearest Isuzu Dealer.

**ADVICE**

- The stereo camera is automatically adjusted while driving. Once the automatic adjustment is completed, the system recovers from the suspended state. At this time, it may take a long time to recover.
- Even if the stereo camera system is temporarily stopped, it does not interfere with normal driving.

**NOTE**

- While there is a malfunction in the stereo camera, the warning message is displayed on the MID for approximately 5 seconds, approximately every 3 minutes.

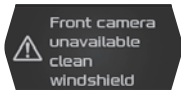
**Warning message****When the Visibility of the Stereo Camera Is Poor**

Because it is difficult to detect objects in front of the vehicle when the visibility of the stereo camera is poor, the system temporarily stops.

- When the area around the stereo camera is covered with dirt, water vapor, fog, water drops, ice, etc.
- In bad weather (such as heavy rain, snow, or fog)
- When there is strong sunlight or reflection from the road surface, or when the road surface is covered with ice or snow and sunlight is reflected on the stereo camera

At this time, the warning message is displayed on the MID for approximately 5 seconds, and then the following indicator lights come on.

- Autonomous emergency braking OFF indicator light
- Lane departure warning OFF indicator light

When the condition of the stereo camera improves, the stereo camera recovers from the suspended state, and the indicator lights turn off.

If the indicator light remains on for a long time, contact the nearest Isuzu Dealer.

**ADVICE**

- When the humidity inside the vehicle is high, or when the temperature difference between the inside and the outside of the vehicle is large, the windshield can become foggy. If the windshield is fogged up, use the defroster to dry it.
- If dirt has adhered to the area around the stereo camera, use the wipers to remove it.
- Even if the system is temporarily stopped due to bad weather or strong light from the forward direction, the system will recover by driving the vehicle for a while after the conditions have been removed.
- Even if the stereo camera system is temporarily stopped, it does not interfere with normal driving.

**NOTE**

- While there is a malfunction in the stereo camera, the warning message is displayed on the MID for approximately 5 seconds, approximately every 3 minutes.

**Master warning light****Warning message****When the Stereo Camera Has Malfunctioned**

The following are possible causes of stereo camera failure.

- When the stereo camera is in an abnormal condition
- When the temperature of the stereo camera is extremely high or low
- When the stereo camera is misaligned significantly
- When power supplied to the stereo camera is cut off

If the stereo camera malfunctions, the warning message is displayed on the MID for approximately 5 seconds, and then the master warning light and the following indicator lights come on.

- Autonomous emergency braking OFF indicator light
- Lane departure warning OFF indicator light

If there is a malfunction, the stereo camera stops until the engine is stopped. If the stereo camera conditions are not improved even though the engine is restarted, contact the nearest Isuzu Dealer.

**ADVICE**

- Although the stereo camera system is stopped, it does not interfere with normal driving.

**NOTE**

- While there is a malfunction in the stereo camera, the warning message is displayed on the MID for approximately 5 seconds, approximately every 3 minutes.

### Autonomous Emergency Braking (AEB)

When the stereo camera detects an object in front of your vehicle, usually another vehicle that could cause a collision, the AEB uses a display on the MID and a buzzer to notify you of the collision risk.

If the system determines that your vehicle cannot avoid a collision, it automatically activates the brake to mitigate the damage caused by the collision. In addition, when the driver takes actions to avoid a collision, the brake assist function helps the driver avoid the collision.

#### WARNING

- The driver is responsible for safe driving. Always check the surrounding area yourself to be safe when driving the vehicle.
- Do not rely entirely on the system. To rely entirely on the system may cause a serious accident. The AEB is not a system that can avoid a collision in all situations. Do not rely on the system when driving. Because the system may not operate depending on the situation, always visually check the surrounding area to be safe.
- Do not use the AEB to regularly stop the vehicle.
- If the AEB warning is activated, check the front and surroundings, and perform appropriate operations, such as depressing the brake pedal, according to the driver's judgment.
- Do not perform the operation check of the AEB by yourself. The system may not operate, depending on the surrounding situation, which may lead to an unexpected accident.
- Confirm that all passengers are wearing a seat belt properly before starting to drive, because when the AEB activates the automatic brake, the brakes are applied forcefully.
- When the following conditions are met, disable the AEB using the customization menu. Do not use the AEB.
  - When tire chains are installed
  - When the vehicle is being towed
  - When the vehicle is transported by a car carrier
  - When there are hanging banners/flags, pendulous branches, or bushes, etc. that brush against the vehicle as it passes through
  - Before using a car wash through which the vehicle moves
  - When your vehicle drives unstably due to a traffic accident or malfunction
  - After a temporary repair has been made using a repair kit for flat tires

WARNING (Continued)

**WARNING (Continued)**

- When using a chassis dynamometer or free roller
- When driving off-road or racing
- If the accelerator pedal is operated when the AEB is activated, the braking force of the automatic brake may not be fully effective.
- Depending on the operating conditions of the brake pedal, accelerator pedal, or steering wheel, the system determines that the driver is attempting to avoid a collision so the automatic brake may not operate.
- If the difference in the speeds of your vehicle and the vehicle ahead is too large, a collision cannot be avoided. In addition, even if the speed difference is small, the system may not activate if a vehicle suddenly cuts in or depending on other different conditions, such as visibility or the slipperiness of the road.
- In the following conditions or situations, your vehicle may not be able to decelerate enough even though the AEB operates.
  - Vehicle conditions (cargo weight, number of passengers, etc.)
  - Road surface conditions (gradient, slipperiness, shape, unevenness, etc.)
  - Vehicle maintenance status (brake related parts, tire wear, air pressure, etc.)
  - When the brakes are cold, such as when the outside air temperature is low or just after the vehicle has started driving
  - For a while after starting the engine and starting to drive the vehicle (for example, until the engine warms up completely)
  - When the effectiveness of braking is poor due to the brakes overheating while driving on a downhill slope, etc.
  - When the effectiveness of braking is poor, such as when the brakes are wet after driving the vehicle through puddles or washing the vehicle
- If the stereo camera cannot detect an object (another vehicle, obstacle, or pedestrian) or if the stereo camera temporarily stops or malfunctions, the AEB does not operate.

**Stereo Camera Detection Function**

→ Refer to page 4-214

**Detection of Pedestrians and Bicycle Riders by the Stereo Camera**

→ Refer to page 4-218

**CAUTION**

- If a warning is issued when you try to overtake the vehicle in front of you, you must not get any closer to that vehicle; otherwise, the emergency brakes may be applied.
- If installed accessories or loaded cargo protrudes beyond the edge of the front bumper, the front end of the vehicle is effectively longer, so avoiding collisions may be impossible.
- The brake pedal may feel stiff when you depress it while the automatic brake is being applied, but this is not abnormal. Further depressing the brake pedal can increase the brake force. Depress the brake pedal further, as necessary.

**NOTE**

- You may hear a noise when the automatic brake is applied. This is caused by controlling and does not indicate a malfunction.

## Operation of the AEB

When the stereo camera detects an obstacle in the forward direction while the vehicle is moving, it alerts the driver and applies the brake automatically. The system operates in 3 stages. When the automatic brake is activated, the stop lights come on.

### AEB OFF indicator light



The system operates when all the following conditions are met.

- When the power mode is "ON" (models with passive entry and start system) or the starter switch is in the "ON" position (models without passive entry and start system).
- The vehicle is traveling in the forward direction at a speed of approximately 10 km/h (6 MPH) or more.
- The AEB OFF indicator light is not come on.



### NOTE

- The AEB does not operate in the following conditions.
  - When your vehicle speed is approximately 8 km/h (5 MPH) or less or approximately 160 km/h (100 MPH) or more
  - When the ESC is operating
  - When the ESC warning light is on
  - When there is a large difference in the lateral direction between your vehicle and the preceding vehicle
  - When the ABS is operating
  - When the function is temporarily stopped due to poor visibility of the stereo camera

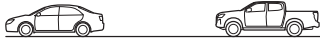

### Forward collision warning light

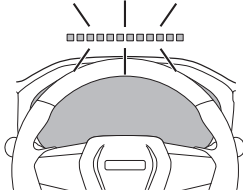

### Warning message

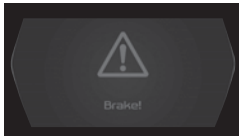

### Warning message

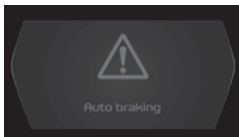

## 1. Forward Collision Warning

When the system determines that the front obstacle may collide with your vehicle, a warning is issued.

The warning message is displayed on the MID and a buzzer sounds. At the same time, the forward collision warning light flashes on the head-up display.

When the vehicle decelerates by the driver's brake pedal operation and the inter-vehicular distance becomes appropriate, the warning is canceled.



### NOTE

- The brake assist function activates when the brake is applied during the forward collision warning.

### Forward Collision Warning (FCW) Light

→ Refer to page 4-234

### Brake Assist Function

→ Refer to page 4-169

## 2. Auto Braking

When the system determines that there is a high possibility of a collision with the front obstacle while driving, the automatic brake operates. The warning message is displayed on the MID. At the same time, a buzzer sounds.

When the system determines that the possibility of collision is lessened by the driver's operations to avoid a collision (such as the brake pedal operation, accelerator pedal operation, or steering wheel operation), the automatic brake operation is canceled.

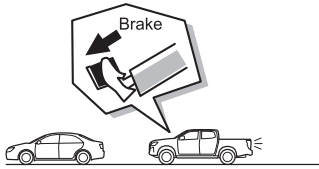

#### Warning message

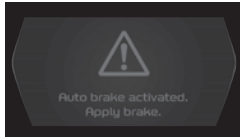

### 3. Cancellation of the Automatic Brake

After your vehicle is stopped by the automatic brake operation, the warning message is displayed on the MID and the automatic brake is released.



#### CAUTION

- The automatic brake is held for only 2 seconds. Therefore, apply the brake as soon as possible after the vehicle is stopped by the automatic brake. For automatic transmission models, when the automatic brake is released, creep phenomenon may cause the vehicle to start moving, resulting in an unexpected accident.

### Situations Where AEB Operates

In the following situations, the AEB may operate even when there is no possibility of collisions.

- When passing through a tollbooth gate at a speed exceeding the specified speed
- Before a parking lot or railway crossing barrier is completely raised up
- When driving close to a vehicle ahead
- When an object approaches rapidly
- When changing lanes to overtake an object
- When passing an object that is changing lanes or turning
- When passing an object that is waiting to turn
- When an object stops in front of your vehicle in your lane
- When driving in a place whose gradient changes drastically

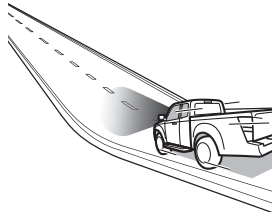

- When the visibility is not good due to splashing water, blowing snow or dust, swirling water vapor, sand, or smoke from the preceding vehicle or oncoming vehicle
- When passing through a cloud of water vapor or smoke

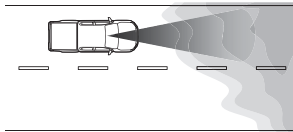

- In bad weather (such as rainstorms, blizzards, or snow)
- When exhaust gas emitted by the preceding vehicle is clearly visible, such as when driving in a cold area

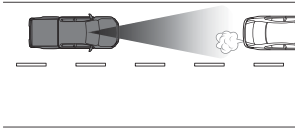

- When approaching an object or something (guardrail, utility pole, tree, wall, etc.) on the side of the road
- When there is an object on the side of the road at a curve or an entrance of an intersection

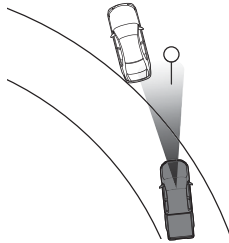

- When your vehicle passes an oncoming vehicle on a curve
- When passing close to a vehicle or an obstacle
- When stopping the vehicle very close to a vehicle or wall in front of you
- When passing through spraying water, such as water being sprayed from a pipe to melt snow or from a sprinkler truck
- When driving the vehicle onto a ferry or on a ship
- When there are hanging banners/flags, pendulous branches, or bushes, etc. that brush against the vehicle as it passes through
- When using a car wash through which the vehicle moves

### Forward Collision Warning (FCW) Light

#### Forward collision warning light

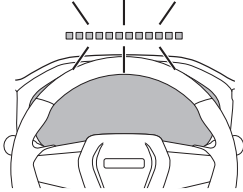

The forward collision warning (FCW) light is a warning light that flashes just before the automatic brake is activated to alert the driver to a risk of a collision with a pedestrian, bicycle rider, vehicle, or obstacle in the forward direction.

The warning light is displayed and projected on the windshield by the head up display.

**Head Up Display → Refer to page 4-60**

### Buzzer

When the AEB operates, buzzers sound as follows.

Warning	Buzzer pattern	Condition
Forward collision warning	Short repeated beeps	When the system determines that the front obstacle may collide with your vehicle
Auto braking	Continuous beep	When the system determines that there is a high possibility of a collision with the front obstacle while driving

### Brake Assist Operation

The brake assist function activates when the autonomous emergency brake (AEB) activates or when the brake is applied during the forward collision warning.

#### Brake Assist Function

→ Refer to page 4-169

### Turn Assist

The AEB assists the driver's brake operation to reduce the risk of collisions with oncoming vehicles when turning right or left at intersections.

It functions when turning right in a right-hand drive model or when turning left in a left-hand drive model.



#### WARNING

- AEB operates only in the following conditions.
  - When the turn signal is on and your vehicle speed is approximately 5 km/h (3 MPH) to 18 km/h (11 MPH)
  - When the speed of an oncoming vehicle is approximately 40 km/h (25 MPH) or more
- Depending on the shapes of intersections, it may not be able to assist the driver appropriately.

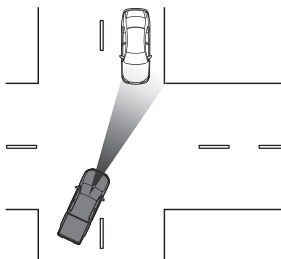

In the following situations, the AEB may activate even if the possibility of a collision is not high.

- When an oncoming vehicle passes in front of your vehicle while your vehicle is turning
- When your vehicle is turning and passing in front of an oncoming vehicle
- When an oncoming vehicle stops just before entering your vehicle's path while your vehicle is turning
- When an oncoming vehicle is turning right or left while your vehicle is turning at an intersection

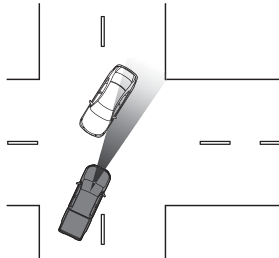

- When the steering wheel is operated to approach the oncoming vehicle's path

In the following situations, the AEB may not operate properly.

- When an oncoming vehicle is driving 2 or more lanes away from your vehicle's lane while your vehicle is turning
- When your vehicle's direction is significantly misaligned with the direction toward the opposite lane while your vehicle is turning

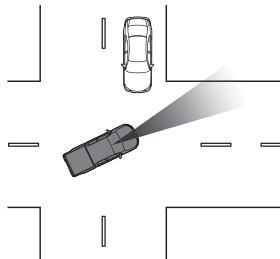

### When the AEB Is Unavailable

#### AEB OFF indicator light



If there is a problem with the AEB, the AEB OFF indicator light comes on. At this time, the AEB does not operate.

If there is a problem with the stereo camera and the brake system, the AEB cannot be used.

**Stereo Camera** → Refer to page 4-210

### Settings of the AEB

The AEB settings can be changed by using the user customization function on the MID.

#### Settings (User Customization Function)

→ Refer to page 4-47

Display indication		Description	
Automatic emergency braking	Warning sensitivity	Far	The system issues warnings of collision risks at an earlier time
		Normal	The system issues warnings of collision risks at the standard time
		Near	The system issues warnings of collision risks at a later time

### To Turn Off the AEB

If you do not want the AEB to operate, it is possible to turn off the system. The AEB settings can be changed by using the user customization function on the MID.

#### Settings (User Customization Function)

→ Refer to page 4-47

	Display indication		Description
Automatic emergency braking	Brake and warning intervention	Enable	Turns on the AEB
		Disable	Turns off the AEB

#### AEB OFF indicator light



When the system is set to "OFF", the AEB OFF indicator light comes on.



#### NOTE

- When the AEB is set to "OFF", the pedal misapplication mitigation is also set to "OFF".
- The AEB (including the brake assist) does not operate while the AEB OFF indicator light is on.
- Even if the AEB is turned off by using the user customization function, the system is turned on again when the engine is restarted.

#### Pedal Misapplication Mitigation

→ Refer to page 4-239

## Pedal Misapplication Mitigation

When the system determines the accelerator pedal is depressed more than needed, such as by accident, while the vehicle is stopped or moving slowly, and the camera recognizes an obstacle in front of the vehicle, the pedal misapplication mitigation restricts engine output so that the vehicle starts moving slowly, which mitigates collision damage. It operates when the vehicle is on a flat road, uphill slope, or downhill slope.

### WARNING

- The pedal misapplication mitigation has limits. Do not rely entirely on the pedal misapplication mitigation. When pulling away, check the positions of the selector lever and pedals and the surrounding safety before operating the vehicle.
- The pedal misapplication mitigation operates when an obstacle in the forward direction is recognized. It does not move the vehicle forward slowly when no object is visible, such as the edge of a cliff or other unseen obstacles.
- Do not intentionally depress the accelerator pedal more than needed when the vehicle is near objects.
- A collision may occur if you rely only on the pedal misapplication mitigation to adjust the acceleration.
- The pedal misapplication mitigation does not keep the vehicle stopped.
- The pedal misapplication mitigation does not enable the vehicle to start moving slowly in all situations. Also, it is not intended to be used for avoiding collisions.
- If the stereo camera cannot detect an object (another vehicle, obstacle, or pedestrian) or if the stereo camera temporarily stops or malfunctions, the pedal misapplication mitigation does not operate.
- If the vehicle is trapped within a railroad crossing, the stereo camera may recognize the boom barrier as an obstacle and the pedal misapplication mitigation may be activated. To push the boom barrier and go forward, stay calm, and continue depressing the accelerator pedal.
- Do not perform the operation test of the pedal misapplication mitigation by yourself. The pedal misapplication mitigation may not operate depending on the surrounding situation, which may lead to an unexpected accident.
- Depending on the distance, speed difference, or difference in the lateral direction between your vehicle and the obstacle (such as when the obstacle is not directly in front of your vehicle), the pedal misapplication mitigation may not operate.
- Depending on how the driver operates the steering wheel, the system determines that the driver is attempting to avoid a collision so the pedal misapplication mitigation may not operate.

WARNING (Continued)

**WARNING (Continued)**

- Be sure to turn off the pedal misapplication mitigation in the following cases.
  - When the vehicle is being towed
  - When the vehicle is transported by a car carrier
  - When the vehicle passes through hanging banners/flags, pendulous branches, bushes, or a vinyl curtain
  - Before using a car wash through which the vehicle moves
  - When using a chassis dynamometer or free roller
  - When starting the engine with the vehicle lifted up to spin the tires
  - When racing, such as driving on a track
- If the stereo camera cannot detect an object (another vehicle, obstacle, or pedestrian) or if the stereo camera temporarily stops or malfunctions, the pedal misapplication mitigation does not operate.

**Stereo Camera Detection Function**

→ Refer to page 4-214

**Detection of Pedestrians and Bicycle Riders by the Stereo Camera**

→ Refer to page 4-218

**NOTE**

- When the AEB is unavailable, the pedal misapplication mitigation does not operate.
- Even though the pedal misapplication mitigation is set to "OFF", it will be set to "ON" when the engine is restarted after the engine start/stop button (models with passive entry and start system) or the starter switch (models without passive entry and start system) is set to "OFF" to stop the engine.

**Autonomous Emergency Braking (AEB)**

→ Refer to page 4-226

## Operation of the Pedal Misapplication Mitigation

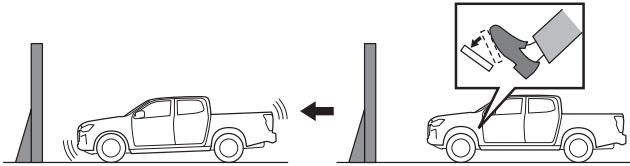
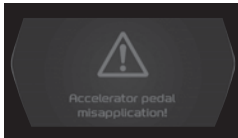
**Warning message****Warning message**

When the system determines that the accelerator pedal is depressed more than necessary to start up the vehicle from the stopped state while the stereo camera recognizes an obstacle in front of the vehicle, it restricts the engine output. At the same time, a buzzer sounds and the forward collision warning light flashes.

After the vehicle control is completed, the warning message is displayed on the MID.

The pedal misapplication mitigation does not operate or is automatically deactivated under the following conditions.

At this time, the pedal misapplication mitigation does not operate even when there is a collision risk.

- When the accelerator pedal is depressed for 3 seconds or more
- When the accelerator pedal is released
- When the steering wheel is operated suddenly or violently
- When the AEB OFF indicator light is on
- When the selector lever is in the "P", "R", or "N" position
- When the engine is not running

### Situations Where Pedal Misapplication Mitigation Operates

In the following situations, the pedal misapplication mitigation may operate even when there is no possibility of collisions.

- Before bars of a parking lot or boom barrier are completely raised up

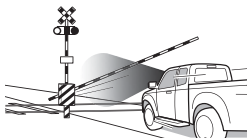

- When exhaust gas emitted by the preceding vehicle is clearly visible, such as when driving in a cold area

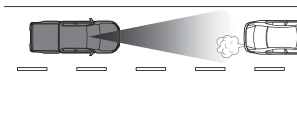

- When driving close to a vehicle ahead
- When driving in a place whose gradient changes drastically

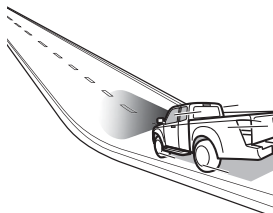

- When the vehicle passes through splashing water, blowing snow, water vapor, sand, smoke, etc., from the preceding vehicle.

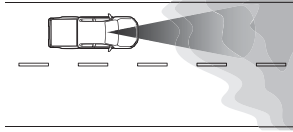

- When passing through spraying water, such as water being sprayed from a pipe to melt snow or from a sprinkler truck
- When driving in bad weather, such as heavy snowfall or a blizzard
- When there is an obstacle at a curve or intersection

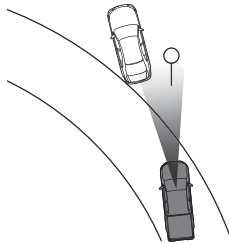

- When passing close to a vehicle or an obstacle
- When stopping the vehicle very close to a vehicle or wall in front of you
- When the vehicle is driven on a riverbed, in overgrown bushes, or in woods

### When the Pedal Misapplication Mitigation Is Unavailable

#### AEB OFF indicator light



If there is a problem with the pedal misapplication mitigation, the AEB OFF indicator light comes on. At this time, the pedal misapplication mitigation does not operate.

If there is a problem with the stereo camera, the system cannot be used.

**Stereo Camera** → Refer to page 4-210

### To Turn Off the Pedal Misapplication Mitigation

If you do not want the pedal misapplication mitigation to operate, it is possible to turn off the system. The pedal misapplication mitigation settings can be changed by using the user customization function on the MID.

#### Settings (User Customization Function)

→ Refer to page 4-47

Display indication		Description	
Automatic emergency braking	Brake and warning intervention	Enable	Turns on the pedal misapplication mitigation
		Disable	Turns off the pedal misapplication mitigation

#### AEB OFF indicator light



When the system is set to "OFF", the AEB OFF indicator light comes on.



#### NOTE

- When the AEB is set to "OFF", the pedal misapplication mitigation is also set to "OFF".
- The pedal misapplication mitigation does not operate while the AEB OFF indicator light is on.
- Even though the pedal misapplication mitigation is set to "OFF", it will be set to "ON" when the engine is restarted after the engine start/stop button (models with passive entry and start system) or the starter switch (models without passive entry and start system) is set to "OFF" to stop the engine.

#### Autonomous Emergency Braking (AEB)

→ Refer to page 4-226

## Adaptive Cruise Control (ACC)

The adaptive cruise control is a system that supports driving on an expressway or limited-access road. Your vehicle follows the preceding vehicle, which is detected by the stereo camera, driving at a speed up to the speed set by the driver. When the preceding vehicle stops, your vehicle also stops. However, your vehicle does not remain in the stopped state. Because the adaptive cruise control is canceled approximately 2 seconds after your vehicle is stopped, press the brake pedal to keep your vehicle stopped.

The vehicle speed for the adaptive cruise control can be set within the range of 30 km/h (20 MPH) to 130 km/h (80 MPH).

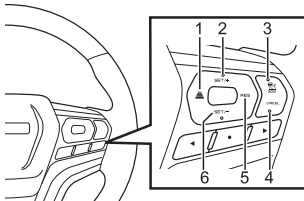

### Adaptive Cruise Control Switch

No.	Description
1	Inter-vehicular distance switch
2	SET/+ switch
3	Main switch
4	CANCEL switch
5	RES switch
6	SET/- switch

### WARNING

- The driver is responsible for safe driving. Always check the surrounding area yourself to be safe when driving the vehicle.
- Do not rely entirely on the system. The adaptive cruise control has performance limits. To rely entirely on the system may cause a serious accident. The system does not drive your vehicle autonomously by judging all possible driving conditions, such as when you are driving while looking away or distracted, while not paying attention to the road in front of you, or while your view is impaired. Also, the device is not intended to be used for preventing collisions.
- When driving, always pay attention to the distance to the preceding vehicle, surrounding conditions, and other driving conditions, and keep the inter-vehicular distance appropriate by depressing the brake pedal or performing other operations as necessary to drive safely.
- Set the set vehicle speed within an appropriate speed range for road conditions, environment, and to observe the speed limit.
- If the stereo camera cannot detect an object (another vehicle) or if the stereo camera temporarily stops or malfunctions, the adaptive cruise control does not operate.

WARNING (Continued)

## WARNING (Continued)

- Do not place the selector lever in the "N" position, except in the event of an emergency. When the selector lever is placed in the "N" position, the adaptive cruise control is automatically deactivated and the engine brake becomes ineffective. This may result in an unexpected accident.
- In a situation where it is difficult for the stereo camera to detect an object, depress the brake pedal or perform other operations as necessary.
- Be sure to set the adaptive cruise control to off when not using the adaptive cruise control. If the adaptive cruise control is kept on, it is unexpectedly set, which may result in an accident.
- Carefully check the passengers and surrounding area to be safe before using the adaptive cruise control. Do not operate it from outside the vehicle.
- The adaptive cruise control has limited capabilities to determine conditions. In the following situations, deceleration may not be enough. Depress the brake pedal as necessary to decelerate the vehicle.
  - When the preceding vehicle decelerates suddenly or is driving at an extremely different speed, even though it is recognized
  - When another vehicle suddenly cuts in front of your vehicle
  - When the distance from the preceding vehicle becomes short due to lane changes

 **CAUTION**

- After starting to follow a preceding vehicle, your vehicle is controlled according to the preceding vehicle's movement. When the preceding vehicle stops, your vehicle also stops. However, your vehicle does not remain in the stopped state. Because the adaptive cruise control is canceled approximately 2 seconds after your vehicle is stopped, press the brake pedal to keep your vehicle stopped. However, if the stereo camera has lost the preceding vehicle, your vehicle may not stop. Keep the inter-vehicular distance by depressing the brake pedal.
- If the preceding vehicle starts within 2 seconds after stopping, the adaptive cruise control continues operating and your vehicle automatically follows the preceding vehicle. If the adaptive cruise control is canceled, press the RES switch to restart the adaptive cruise control.
- The effectiveness of braking may decrease depending on the following conditions and situations. Depress the brake pedal as necessary to decelerate the vehicle.
  - Vehicle conditions (cargo weight, number of passengers, etc.)
  - Road surface conditions (gradient, slipperiness, shape, unevenness, etc.)
  - Vehicle maintenance status (brake related parts, tire wear, air pressure, etc.)
  - When the brakes are cold, such as when the outside air temperature is low or just after the vehicle has started driving
  - For a while after starting the engine and starting to drive the vehicle (for example, until the engine warm-up is completed)
  - When the effectiveness of braking is poor due to the brakes overheating while driving on a downhill slope, etc.
  - When the effectiveness of braking is poor, such as when the brakes are wet after driving the vehicle through puddles or washing the vehicle

### Situations Where Adaptive Cruise Control Does Not Operate Properly

Do not use the adaptive cruise control in the following situations. Doing so may lead to an unexpected accident.

- After a temporary repair has been made using a repair kit for flat tires
- When tire chains are installed
- When your vehicle drives unstably due to a traffic accident or malfunction
- When the brake system warning light is on
- On a slippery road
- When towing a vehicle, etc.

The adaptive cruise control is intended to be used when driving on a limited access road, such as an expressway or a tollway. Do not use the adaptive cruise control in a situation where the stereo camera cannot detect objects or in the following situations, because doing so may lead to an unexpected accident.

- When the visibility is poor due to fog or bad weather (such as rainstorms, blizzards, or snow)
- General roads (other than limited access roads); It may not be possible to drive according to traffic conditions due to the road environment (such as the case where a road is complicated), leading to an unexpected accident.
- When the vehicle enters a sharp curve, such as an interchange or junction, or it enters a merge point of a rest area, parking area, or tollbooth, etc.; it may be impossible to recognize the preceding vehicle.
- Slippery road surfaces, such as when the road is frozen or covered with snow; Tires may slip and the driver may lose control of the vehicle.
- Under traffic conditions where consecutive acceleration and deceleration make it difficult to keep the intervehicular distance; The driver may not be able to drive the vehicle appropriately for the traffic conditions.
- Steep downhill slopes; The set vehicle speed may be exceeded.
- When a steep downhill slope continues; The brakes may overheat.
- Roads or overpasses which have repeated steep uphill and downhill slopes; The system may not be able to recognize the preceding vehicle and may recognize road surfaces, resulting in inappropriate controls.
- Roads with continuous curves
- Front vehicles with a rear surface that is small (such as trailers), low, or uneven (such as trucks with no load, side gates, or rear gates, vehicles with a load sticking out from the end, vehicles with a special shape, such as car carriers and side cars, or vehicles with a low vehicle height, etc.)
- The preceding vehicle significantly reflects sunlight or other light.

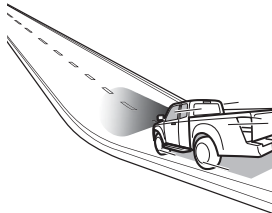

Under the following road conditions or conditions of your vehicle, the stereo camera may not be able to detect the preceding vehicle. Vehicles in neighboring traffic lanes or roadside objects may also be incorrectly detected. Under conditions such as these, do not use the adaptive cruise control. If cruise control is currently in use, operate the brake pedal and take other actions as necessary.

- When following begins from a short distance, such as when the vehicle in front is a vehicle that cut into your lane
- On curves, at the start or end of curves, and on roads with continuous curves
- On on/off-ramps for freeways, highways, or other restricted access roads (adaptive cruise control is not designed for use in these kinds of driving environments.)
- In urban or suburban environments (adaptive cruise control is not appropriate for driving in these areas. Use the adaptive cruise control only on limited-access highways.)
- When the vehicle in front has moved to the side and is no longer directly ahead of your vehicle
- When there is an obstacle on the side of the road

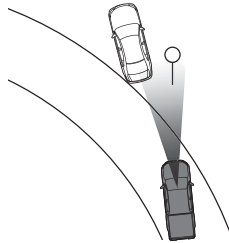

- When there is a large difference in relative speed compared to the preceding vehicle
- When a vehicle cuts into your lane in front of your vehicle
- When the distance between vehicles is extremely short
- When your vehicle is drifting in its lane
- On bumpy or unpaved road surfaces
- On roads with extremely narrow lanes, such as when traffic restrictions are in effect or in areas where construction work is taking place
- When normal driving is unstable due to an accident or malfunction
- When extremely heavy cargo is loaded in the cargo area or second seat

### Operating Conditions for the Adaptive Cruise Control

The adaptive cruise control becomes operable when all the following conditions are met.

- All the doors are closed
- Driver side seat belt is buckled
- The selector lever is in the "D" position
- The brake pedal is not depressed and the parking brake is not engaged
- The indicator light indicating a camera malfunction is not on
- The ABS warning light, ESC warning light, or TCS OFF indicator light is not on
- The vehicle is not driving on a steep slope
- The steering wheel is not turned sharply
- When the vehicle speed is 130 km/h (80 MPH) or less

### Setting to Your Desired Vehicle Speed

#### Main switch

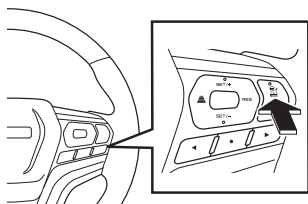

1. Press the main switch to set it to "ON".

The adaptive cruise control indicator light comes on white.

#### Adaptive cruise control indicator light (White)

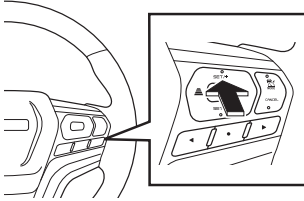

**SET/+ switch****Adaptive cruise control indicator light (Green)**

2. Set your desired vehicle speed. The initial value is 30 km/h (20 MPH), and the speed is changed by the SET switch.

Pressing the switch once can increase/decrease the set vehicle speed by 1 km/h (1 MPH), while pressing and holding the switch can increase/decrease the speed by 5 km/h (5 MPH). The speed where you stop operating the SET switch is set as the set vehicle speed.

The set vehicle speed is displayed on the MID.

At the same time the adaptive cruise control indicator light comes on green.

**WARNING**

- Set the set vehicle speed within an appropriate speed range for road conditions, environment, and to observe the speed limit.

**NOTE**

- You cannot follow the preceding vehicle at speeds of more than the set vehicle speed.
- While driving through a curve, the vehicle may not accelerate or may decelerate, even if the set vehicle speed is higher than your vehicle's current actual speed.

### Operation of the Adaptive Cruise Control

#### When the Preceding Vehicle Is Not Recognized (When There Is No Preceding Vehicle)

Your vehicle drives at the set vehicle speed constantly.

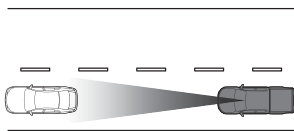

#### When the Preceding Vehicle Is Recognized

When the preceding vehicle is recognized, the preceding vehicle indicator is displayed on the MID.

Your vehicle drives at a speed up to the set vehicle speed and follows the preceding vehicle while keeping the inter-vehicular distance according to your vehicle speed.

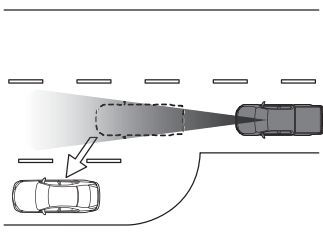

#### When the Preceding Vehicle Is No Longer Recognized

When the preceding vehicle is no longer recognized, the preceding vehicle indicator on the MID disappears.

Your vehicle slowly accelerates to the set vehicle speed and then drives at that speed constantly.

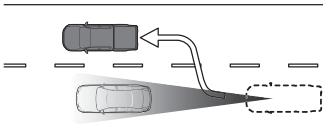

**CAUTION**

- The brake pedal may feel stiff when you depress it while the automatic brake is being applied, but this is not abnormal. Further depressing the brake pedal can increase the brake force. Once you take your foot off the brake pedal, it returns to its original state.

**NOTE**

- When the brake is applied by the adaptive cruise control, the stop lights come on.
- Even when the preceding vehicle is not recognized while driving on a downhill slope, the brake may be applied by the adaptive cruise control to keep your vehicle at the set speed.
- You may hear an operation sound when the automatic brake is applied. This is caused by system controls and is not abnormal.
- If you want to accelerate quickly, depress the accelerator pedal.
- When you want to change lanes to overtake the preceding vehicle while driving at lower speeds than the set vehicle speed while following the preceding vehicle, depress the accelerator pedal to accelerate your vehicle as necessary.
- A vehicle following another vehicle has the following characteristics.
  - If the speed of the preceding vehicle is lower than the set vehicle speed and the distance is long, your vehicle may accelerate more than expected to reduce the distance between the vehicles.
  - When the preceding vehicle brakes suddenly or another vehicle cuts in between your vehicle and the preceding vehicle while your vehicle is following the preceding vehicle, application of the brake may be delayed.

**To Accelerate or Decelerate Temporarily****NOTE**

- Normally, while following the preceding vehicle, your vehicle automatically accelerates or decelerates according to the vehicle speed of the preceding vehicle. However, you should operate the accelerator pedal and brake pedal to accelerate or decelerate appropriately according to your surroundings, such as to accelerate to change lanes, or to decelerate if you come too close to the preceding vehicle because it suddenly decelerates when another vehicle cuts in.

**To Accelerate Temporarily**

When you want to accelerate temporarily, depress the accelerator pedal.

Once the accelerator pedal is released, the vehicle restarts driving at a constant speed or following the preceding vehicle according to the originally set vehicle speed.

**To Decelerate Temporarily**

When you want to decelerate temporarily, depress the brake pedal. The adaptive cruise control temporarily stops its control, and the adaptive cruise control indicator light comes on white.

When the brake pedal is released and the SET switch or RES switch is pressed, the vehicle restarts driving at a constant speed or following the preceding vehicle according to the originally set vehicle speed.

The adaptive cruise control indicator light comes on green.

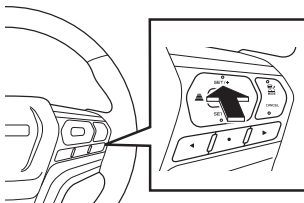
**SET/+ switch**

## Setting the Inter-Vehicular Distance

### Inter-vehicular distance switch

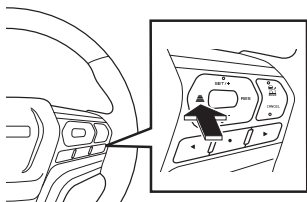

The inter-vehicular distance with the preceding vehicle when following it can be set to 3 ranges.

Press the inter-vehicular distance switch while following a preceding vehicle.

Every time the switch is pressed, it switches the inter-vehicular distance settings.

The inter-vehicular distance is indicated on the MID.

### Inter-vehicular distance display



MID Display Content

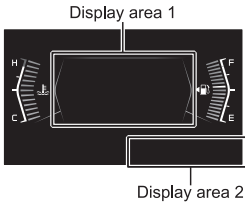

If the driving support system information display is selected while the adaptive cruise control is active, information other than the set vehicle speed is displayed in display area 1. On the other hand, if anything other than the driving support system information display is selected, information is displayed in display area 2. The set vehicle speed is always displayed in display area 2.

Display area 1

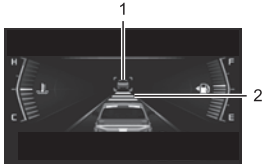



Display area 2



No.	Display	Description
1	Preceding vehicle indicator	This is displayed when the preceding vehicle is recognized.
2	Inter-vehicular distance display	This displays the inter-vehicular distance with the preceding vehicle: short/moderate/long

The inter-vehicular distance changes according to the vehicle speed, and it becomes longer as your vehicle speed becomes higher.

Inter-vehicular distance display	Inter-vehicular distance*	
	Short	approximately 30 m (98 ft)
	Moderate	approximately 45 m (148 ft)
	Long	approximately 60 m (197 ft)

\*: When your vehicle speed is approximately 100 km/h (62 MPH).

## Approach Warning

## Forward collision warning light

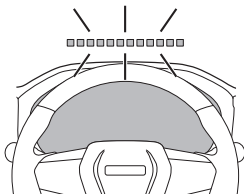

## Warning message

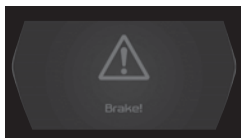

When the system determines that the driver needs to manually decelerate the vehicle while the adaptive cruise control is operating, the "Brake!" warning message is displayed on the multi-information display (MID) and a buzzer sounds. At the same time, the forward collision warning light flashes on the head-up display.

The approach warning activates when the system determines that the automatic brake cannot decelerate the vehicle sufficiently to maintain the appropriate inter-vehicular distance. Decelerate the vehicle by depressing the brake pedal to keep the appropriate inter-vehicular distance.

**Head Up Display → Refer to page 4-60**

 **WARNING**

- The "Brake!" warning message is not displayed in the following conditions.
  - When the accelerator pedal is depressed
  - When the brake pedal is depressed
- Even though the inter-vehicular distance is short, the "Brake!" warning message is not displayed in the following conditions.
  - When driving at a slightly different speed than the preceding vehicle (when driving at almost the same speed as the preceding vehicle)
  - When the preceding vehicle is driving faster than your vehicle (when the inter-vehicular distance is gradually increasing)
  - When another vehicle has cut just in front of your vehicle
  - When the preceding vehicle suddenly decelerates
  - When there are repeated uphill and downhill slopes
- When the preceding vehicle is stopped at the end of a line of cars at a tollbooth or traffic jam, or driving at much lower speeds than your vehicle's speed, the recognition of the preceding vehicle may be delayed and the "Brake!" warning message may be displayed.
- Under the following conditions, the approach warning may not operate even when the inter-vehicular distance is small.
  - When driving at a slightly different speed than the preceding vehicle (when driving at almost the same speed as the preceding vehicle)
  - When the preceding vehicle is driving faster than your vehicle (when the inter-vehicular distance is gradually increasing)
  - When another vehicle has cut just in front of your vehicle
  - When the preceding vehicle suddenly decelerates
  - When there are repeated uphill and downhill slopes
- In the following situations, an approach warning may be activated when the stereo camera detects a vehicle in the adjacent lane or a roadside object.
  - When the road is curved or the lane is narrow
  - When the position of your vehicle in the lane is unstable due to steering operation, etc.

### Setting the Set Vehicle Speed of the Adaptive Cruise Control to Higher/Lower

#### SET switch

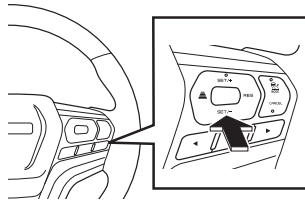
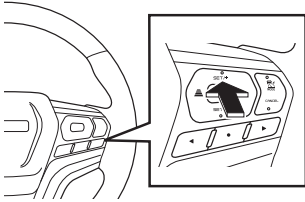

#### Adaptive cruise control indicator light



#### When Using the Switch

Press the SET switch to increase/decrease the set vehicle speed.

The vehicle speed increases/decreases while the switch is pressed and the vehicle speed display on the MID changes. When you release the switch at the desired vehicle speed, the vehicle speed is set.

Each time the switch is pressed and then immediately released, the vehicle speed increases/decreases by 1 km/h (1 MPH).

Pressing and holding the switch increases/decreases the speed by 5 km/h (5 MPH).

Each time the switch is operated, the vehicle speed display on the MID changes.

SET/+ switch

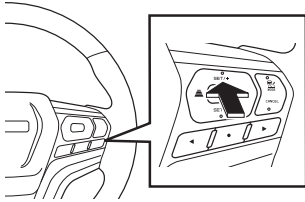

Adaptive cruise control indicator light

**When Using the Accelerator Pedal**

1. Depress the accelerator pedal to accelerate the vehicle.
2. When the accelerator pedal is released, your vehicle automatically decelerates to the set vehicle speed or the speed for following the preceding vehicle. Then, the control is continued. By depressing the accelerator pedal during the adaptive cruise control operation, the vehicle speed can be increased to more than or equal to the set vehicle speed. However, if the vehicle speed is increased to 150 km/h (93 MPH) or more, the adaptive cruise control is canceled and you need to drive the vehicle normally. At this time, a warning buzzer sounds and the adaptive cruise control indicator light comes on white.

To restart the adaptive cruise control, press the SET switch or RES switch at 130 km/h (80 MPH) or less. When the adaptive cruise control restarts, the adaptive cruise control indicator light comes on green.

**NOTE**

- When following the preceding vehicle, even if you push the switch to increase the set vehicle speed to go faster than the preceding vehicle, your vehicle cannot accelerate because it is controlled according to the speed of the preceding vehicle. However, because the set vehicle speed has been changed, your vehicle accelerates up to the newly set vehicle speed when the preceding vehicle is no longer recognized.
- Check the set vehicle speed display on the MID when changing the vehicle speed.
- When the accelerator pedal is depressed while the adaptive cruise control is set, the adaptive cruise control does not perform deceleration. However, if there is a high collision risk with a front obstacle at this time, the autonomous emergency braking (AEB) may issue a warning and operate the automatic brake.

**Autonomous Emergency Braking (AEB)**

→ Refer to page 4-226

SET/- switch

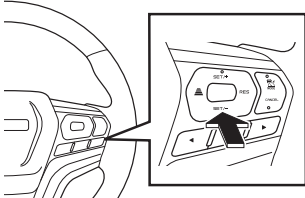

Adaptive cruise control indicator light

**When Using the Brake Pedal**

1. Depress the brake pedal to decrease the speed. The adaptive cruise control temporarily stops its control, and the adaptive cruise control indicator light comes on white.
2. Upon reaching the desired vehicle speed, press the SET switch to set a new vehicle speed. Also, when the RES switch is pressed while the adaptive cruise control is canceled, the adaptive cruise control restarts at the previously set vehicle speed. When the switch is pressed, the new set vehicle speed is displayed on the MID. The adaptive cruise control indicator light comes on green.

### Stay Stopped Function

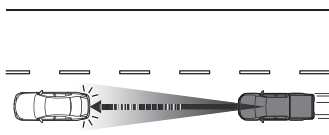

**Adaptive cruise control indicator light**



When the preceding vehicle stops while your vehicle is following it using the adaptive cruise control, your vehicle also stops.

However, when approximately 2 seconds have passed since your vehicle stopped, the adaptive cruise control is canceled with a warning buzzer sounding, and the stopped state is released. Be sure to depress the brake pedal to keep your vehicle stopped. When the adaptive cruise control is canceled, the adaptive cruise control indicator light comes on white. To restart the adaptive cruise control after the preceding vehicle restarts, release the brake pedal and press the RES switch. By doing so, your vehicle can restart following the preceding vehicle at the previously set vehicle speed. The adaptive cruise control indicator light comes on green.

On the other hand, when the preceding vehicle starts driving within approximately 2 seconds since it stopped, the adaptive cruise control is not canceled. Your vehicle automatically starts and continues following the preceding vehicle.

**WARNING**

- The adaptive cruise control is a function to maintain a constant speed while driving, and it is not a function to stop the vehicle. Do not rely on this function to drive your vehicle.
- The driver is responsible for stopping the vehicle, so always drive safely because this function may not always be able to stop the vehicle.
- When the vehicle automatically stops, the driver needs to depress the brake pedal to keep the vehicle stopped.

**CAUTION**

- The function is limited according to the road surface conditions, load conditions, and the inter-vehicular distance to the preceding vehicle and the difference in speeds of your vehicle and the preceding vehicle. Also, if the height of the preceding vehicle is extremely low or if the preceding vehicle is towing a trailer with a low height (e.g. a trailer with no load), the rear end of the preceding vehicle cannot be recognized and a collision may occur.

### When Canceling Adaptive Cruise Control

#### Main switch

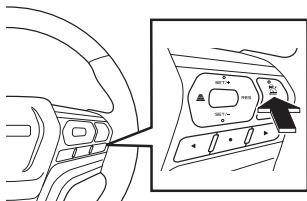

Press the adaptive cruise control main switch again to set it to "OFF". The adaptive cruise control indicator light will go out.

When the adaptive cruise control is canceled automatically by the system, this indicator light changes from green to white after "Cruise control canceled." is displayed on the MID for approximately 5 seconds.

The adaptive cruise control is canceled in the following cases.

#### CANCEL switch

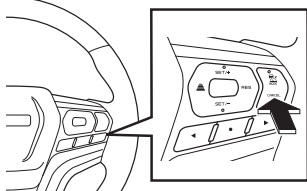

- Pressing the "CANCEL" switch
- When the road gradient is steep
- When the autonomous emergency braking (AEB), electronic stability control (ESC), traction control system (TCS), trailer sway control, or hill descent control is activated
- When your vehicle speed exceeds approximately 150 km/h (93 MPH) while driving by using the adaptive cruise control
- When the steering wheel is turned all the way
- When the selector lever is placed in any position other than the "D" position
- When either one of the driver side door, the passenger side door, or a rear door is opened
- When the driver side seat belt is unbuckled
- When the 4WD switch is set to 4L (models with 4WD)
- When the brake pedal is depressed
- When there is an abnormality in the engine control system
- When there is abnormality in the brake system
- When the ESC function is set to OFF by the ESC OFF switch

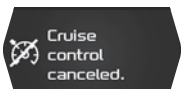

- When the parking brake is applied
- When the camera malfunctions or temporarily stops

**NOTE**

- When the adaptive cruise control is automatically deactivated, reset it after the conditions that deactivated it are removed. If it cannot be set even after the conditions are removed, there may be an abnormality in the camera system. Though it does not interfere with normal driving, contact the nearest Isuzu Dealer.

**When Returning to Adaptive Cruise Control Driving**

If you have canceled adaptive cruise control under the following conditions, you can return to the adaptive cruise control driving condition before cancellation when you press the "RES" switch. Then, the adaptive cruise control indicator light comes on green.

- When depressing the brake pedal.
- When shifting gears.
- When operating the "CANCEL" switch.

**When the Adaptive Cruise Control Is Unavailable**

If there is an abnormality with any one of the stereo camera, brake control system, or powertrain system, the adaptive cruise control cannot be used.

In this case, even if you try to set the adaptive cruise control, the adaptive cruise control indicator light does not come on.

If there is a problem with the camera, the system cannot be used.

**Stereo Camera → Refer to page 4-210**

### To Switch the Mode to the Cruise Control Function

It is possible to switch the mode from the adaptive cruise control to the cruise control by performing the following operations.

#### Main switch

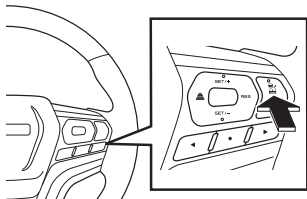

1. Press the main switch to turn on the adaptive cruise control. The adaptive cruise control indicator light comes on white.

#### Adaptive cruise control indicator light (White)



#### Inter-vehicular distance switch

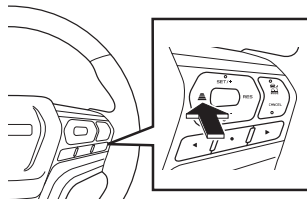

2. Press the inter-vehicular distance switch for 2 seconds or more.

**Cruise control indicator light (White)**

3. The mode is switched from the adaptive cruise control to the cruise control and the cruise control indicator light comes on white.

Press the inter-vehicular distance switch again for 2 seconds or more to return the mode from the cruise control to the adaptive cruise control. The adaptive cruise control mode is set after you use the main switch to cancel cruise control mode or after you restart the engine and press the main switch.

**NOTE**

- In the cruise control mode, the vehicle speed can be set within the range of 30 km/h (20 MPH) to 160 km/h (100 MPH).

**Cruise Control → Refer to page 4-151**

## Manual Speed Limiter (MSL)

The manual Speed Limiter (MSL) is a function that restricts driving beyond the set speed. The speed limit can be set between 30 km/h (20 MPH) and 160 km/h (100 MPH).

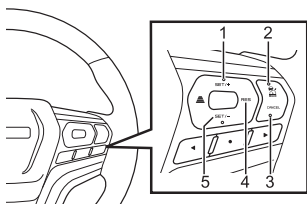

### MSL Switch (Type 1)

No.	Description
1	SET/+ switch
2	Main switch
3	CANCEL switch
4	RES switch
5	SET/- switch

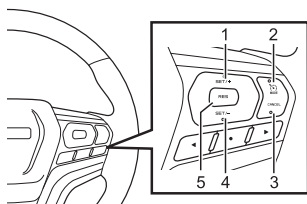

### MSL Switch (Type 2)

No.	Description
1	SET/+ switch
2	Main switch
3	CANCEL switch
4	SET/- switch
5	RES switch

### WARNING

- Be sure to turn off the system when the driver changes. If the driver changes and the new driver does not recognize the MSL set speed, the vehicle does not accelerate even when the accelerator pedal is depressed. Doing so is dangerous because an accident could occur.
- Set the set speed within an appropriate speed range for road conditions, environment, and to observe the speed limit.
- If a set speed lower than the vehicle speed while driving is set, the system decelerates the vehicle. Always check the surrounding area to be safe when using the system.

**NOTE**

- The system is temporarily overridden when the accelerator pedal is depressed strongly and the vehicle accelerates. When the vehicle speed falls to the set speed or less, the system reactivates.
- On a downhill slope, the vehicle speed may exceed the set speed.

## Setting the MSL

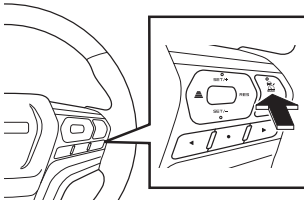
**Main switch****MSL indicator light**

1. Press the main switch to set it to "ON". The MSL indicator light comes on white.

**NOTE**

- If the cruise control or adaptive cruise control is set to on when the main switch is pressed, press the main switch again to switch to the MSL.

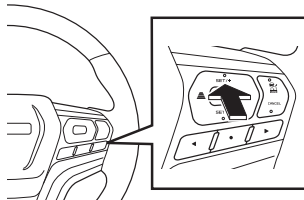
**SET switch**

2. Press the SET switch to set the speed.  
When the vehicle speed is 30 km/h (20 MPH) or more, the vehicle speed at that time is set as the set speed. When the vehicle speed is less than 30 km/h (20 MPH), the set speed is set to 30 km/h (20 MPH). The set speed is displayed on the MID. At the same time, the MSL indicator light comes on green. Each time the switch is pressed and then immediately released, the set speed increases by 1 km/h (1 MPH). By pressing and holding the switch, the set speed increases in 5 km/h (5 MPH) increments.

**NOTE**

- Check the set speed limit displayed on the MID when changing the vehicle speed limit.
- When the vehicle speed exceeds the set speed by approximately 5 km/h (3 MPH) or more, the MSL indicator light flashes. The indicator light continues flashing until the vehicle speed lowers to less than or equal to the set speed.

**Temporary Cancellation of the System**

The system is temporarily canceled when the following operations are performed.

- When the "CANCEL" switch is pressed

**NOTE**

- Press the SET switch to set the set speed.
- Even if the brake pedal is depressed, the MSL is not canceled.

**Warning of Exceeding the Set Speed**

When the vehicle speed exceeds the set speed by approximately 5 km/h (3 MPH) or more, the MSL indicator light flashes. The indicator light continues flashing until the vehicle speed lowers to less than or equal to the set speed.

### Lane Departure Warning (LDW)

The lane departure warning (LDW) is a system that informs you that your vehicle may deviate from the lane. If the system detects the lane with the camera while you are driving and determines that your vehicle may deviate from the lane, it informs you with the MID display. For models with electric power steering (EPS), the steering wheel vibrates at the same time. For models with hydraulic power steering (HPS), the buzzer sounds. Use it on a well-maintained road with lanes.

The lane departure warning (LDW), lane departure prevention (LDP), emergency lane keeping (ELK), and lane keep assist system (LKAS) that help prevent lane departure are collectively called the lane support system (LSS).

#### WARNING

- The LDW does not operate in all situations.
- The driver is responsible for safe driving. Always check the surrounding area yourself to be safe when driving the vehicle.
- The LDW is designed to support driving in a lane and is not a system that allows you to not look ahead carefully or to drive without your hands on the steering wheel. Also, the LDW is not a system that issues a warning by recognizing the edge of the road, such as the road shoulder or gutter. Make sure that you operate the steering wheel depending on the surrounding conditions and always drive safely.
- If the stereo camera cannot detect an object (lanes) or if the stereo camera temporarily stops or malfunctions, the LDW does not operate.

### Activating the LDW

#### LDW OFF indicator light



When all of the following conditions are met, the LDW becomes operable.

- When driving near the center of a road on which a lane is drawn on one or both sides
- When driving at a vehicle speed of approximately 60 km/h (37 MPH) to 130 km/h (80 MPH)
- When driving on a straight or gently curved road
- The LDW OFF indicator light is off



#### NOTE

- The LDW stays in standby until it detects either the left or the right lane.
- If only the right or left lane is detected, the LDW cannot be issued for the side that is not detected.

### Operation of the LDW

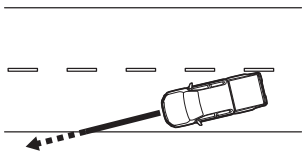

If the system determines that the vehicle may depart from the lane, a warning is issued.

A warning message is displayed on the MID. For models with electric power steering, the steering wheel vibrates at the same time. For models with hydraulic power steering, the buzzer sounds.

Details of MID Indication

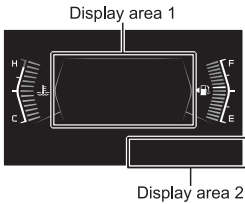

The following is shown on the MID depending on the conditions. If the driving support system information display is selected while the LDW is active, information is displayed in display area 1. On the other hand, if anything other than the driving support system information display is selected, information is displayed in display area 2.



**NOTE**

- When the white line of the lane is detected only on one side, only the detected line is displayed in the lane display of the MID.
- When the stereo camera detects that the vehicle has departed from its lane, information is displayed in display area 1 even though the driving support system information display is not selected.

Display area 1

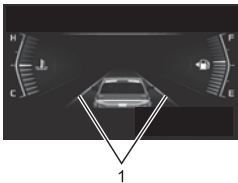

Display area 2

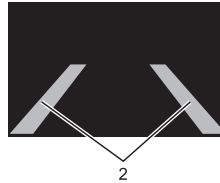

No.	Lane marker	Description
1	None	When the stereo camera does not detect lanes
	White	When the stereo camera detects lanes
	Yellow	When the stereo camera detects that the vehicle has departed from its lane
2	Gray	When the stereo camera does not detect lanes
	White	When the stereo camera detects lanes

### Automatic Stop of Warning

If the following operations are performed, the LDW automatically stops the warning. After the operations are performed, the LDW automatically reactivates.

- When the system cannot detect the lane
- When the vehicle speed is less than approximately 60 km/h (37 MPH)
- When driving on a sharp curve
- When driving on a curve at an inappropriate speed
- When turning the steering wheel sharply
- When braking
- When accelerating suddenly
- When the vehicle has not returned to the inside of the lane after the LDW is activated
- When the lane is narrow
- When it is difficult for the stereo camera to recognize the lanes due to the performance of its lane recognition function
- When lane markings do not exist or are fading
- When lane markings are difficult to distinguish because their color is similar to that of the road surface
- When the width of the lane markings is narrow
- In the following cases, the lane may be incorrectly recognized, and the LDW may be activated.
  - When there is a tire mark, etc. on a wet road or snowy road
  - When there is a boundary between snow and asphalt, a road repair mark, etc.
  - When there is a shadow of a guardrail, etc.
  - When the lane markings are drawn twice
  - When lines other than the lane markings are drawn on the road surface
- When operating the turn signal indicator lights

### When the LDW Is Unavailable

#### LDW OFF indicator light



If there is a problem with the LDW, the LDW OFF indicator light comes on. At this time, the LDW does not operate.

If there is a problem with the stereo camera, the LDW cannot be used.

**Stereo Camera → Refer to page 4-210**

**To Turn Off the LDW**

If you do not want the LDW to operate, it is possible to turn off the system. The settings of the LDW can be changed by using the user customization function on the MID.

**Settings (User Customization Function)**  
 → Refer to page 4-47

**Models with EPS**

Display indication		Description
Lane support settings	Lane departure prevention	Assist and warning
		Warning only
		Off
		Issues a warning and performs steering assist
		Only issues a warning
		Turns off the LDP (cancels a warning and steering assist)

**Models with HPS**

Display indication		Description
Lane departure warning	Lane departure warning	Turns off the LDW
		Enable
		Disable

**LDW OFF indicator light**



When the LDW is off, the LDW OFF indicator light comes on.



**NOTE**

[Models with EPS]

- When the engine is restarted after it is stopped, the system is turned on again.

[Models with HPS]

- When the engine is restarted after it is stopped, the system keeps the state prior to the engine being stopped.

**To Turn Off the LDW by LSS Switch (Models with EPS)**

→ Refer to page 4-295

### Lane Departure Prevention (LDP)

The lane departure prevention (LDP) is a system that supports avoiding deviation from the lane by assisting the steering wheel operation when your vehicle is about to deviate from the lane. If the system detects the lane with the stereo camera while you are driving and determines that your vehicle may deviate from the lane, it assists the driver's steering wheel operation. At the same time, it notifies the driver of the danger by the MID display and steering wheel vibration. Use it on a well-maintained roads with lanes, such as expressways and controlled-access highways.

The lane departure warning (LDW), lane departure prevention (LDP), emergency lane keeping (ELK), and lane keep assist system (LKAS) that help prevent lane departure are collectively called the lane support system (LSS).



#### WARNING

- The driver is responsible for safe driving. Always check the surrounding area yourself to be safe when driving the vehicle.
- Do not rely entirely on the LDP. The LDP is not an autonomous driving system. The system does not operate in all situations. Relying only on the system to keep the vehicle in the lane may lead to an accident, such as a collision with an obstacle on the side of the lane or a vehicle driving in the adjacent lane. The system does not allow you to drive while looking aside or to drive without your hands on the steering wheel, etc. Be sure to grip the steering wheel while driving the vehicle.
- If the amount and timing of the system's controls differ from your feeling of driving operations, do not use the system because it cannot support driving safely.
- Do not perform the operation test of the system by yourself.
- If the stereo camera cannot detect an object (lanes) or if the stereo camera temporarily stops or malfunctions, the LDP does not operate.
- Do not use the system in the following situations.
  - When emergency repairs using a puncture repair kit have been done
  - When tire chains are installed
  - When the vehicle drives unstably due to a traffic accident or malfunction
  - When the brake system warning light is on
  - When towing a vehicle, etc.

WARNING (Continued)

**WARNING (Continued)**

- In the following situations, do not use the system because an accident may unexpectedly occur. It may not be able to properly control the vehicle because the lane cannot be recognized.
  - General roads (other than limited access roads); It may not be possible to drive according to traffic conditions due to the road environment (such as the case where a road is complicated), leading to an unexpected accident.
  - Roads with curves (This function is enabled only on straight roads)
  - A lane restriction or a temporary lane due to construction, etc.
  - Old lane markings remain
  - Avoiding a stationary vehicle
  - Snow, puddles, or snow melting agent remains on the road surface
  - There is a crack or repair mark on the road surface
  - When driving on a slippery road, such as an icy road or snowy road; the tires may slip and control of the vehicle may be lost.
  - When the vehicle enters an interchange or junction, or it enters a rest area, parking area, tollbooth, etc.

**CAUTION**

- In the following situations, the LDP may not perform sufficiently, or the LDP may not operate or may be deactivated.
  - When the lane cannot be detected
  - When the vehicle speed is less than approximately 60 km/h (37 MPH)
  - When driving on curves
  - When turning the steering wheel sharply
  - When braking suddenly
  - Immediately after the vehicle weight changes drastically
  - Immediately after tires are changed or the tire air pressure is adjusted
  - Immediately after a camera-related parts are adjusted, repaired or replaced
  - Immediately after the suspension or steering system is repaired or replaced
  - When studless tires or non-genuine tires are installed
  - When subject to a crosswind
  - When the road surface gradient changes rapidly (uphill, downhill)
  - When the lateral gradient of the road is extreme or changes rapidly
  - Roughness, undulation or seams in the road surface

CAUTION (Continued)

## CAUTION (Continued)

- When acceleration/deceleration is extreme
- When the outside air temperature is high
- When the wipers are moving fast
- When the turn signals are operating
- When the hazard warning flashers are operating
- When the LKAS is operating
- When the operation time of the LDP is long
- When the ABS or TCS is operating
- When an object that blocks the stereo camera's field of view has been installed
- When the brightness of the headlights is insufficient because the headlights are dirty or the headlight beams are misaligned
- When headlights, fog lights, etc. have been modified
- When the brightness drastically changes, such as when entering or exiting a tunnel or when going under an overpass
- When water, snow or dust is thrown up by preceding vehicles or oncoming vehicles, or sand, smoke, or water vapor is carried by the wind in front of your vehicle
- When the windshield is foggy, or there is snow, dirt, frost, or dust on it, or it is scratched
- When raindrops, water drops, or dirt on the windshield is not wiped away completely
- When the field of view of the stereo camera is obstructed by a canoe, etc. loaded on the roof
- When the headlights are not on at night or in a tunnel
- When it is dim in the early evening or morning
- When weather conditions are bad (rain, snow, etc.)
- When light is reflected off a wet road surface
- When the distance between vehicles is short and it is difficult to see the lane markings
- When shadows, such as of guardrails, cover the lane markings
- When the vehicle is subject to strong light from the forward direction (backlight from sunlight, light from headlights, etc.)
- When the vehicle lane is too narrow or too wide

CAUTION (Continued)

**CAUTION** (Continued)

- When the width of the vehicle lane changes
- When lane markings do not exist or are fading
- When lane markings are difficult to see because their color is similar to that of the road surface
- When the lane markings are drawn twice
- When the width of the lane markings is narrow
- When lines other than the lane markings are drawn on the road surface
- When a wall or pole is adjacent to the lane markings
- When the shape of lane markings changes drastically (such as at the start or end of curves, at speed limiting systems, or on continuously curving roads)
- When reaching branching lanes at expressway interchanges, junctions, rest areas, parking area entrances, etc.
- When there are curbstones or side walls on the road shoulder
- If the LDP is not used, be sure to turn off the system. If the system is left on, it may operate in an unexpected situation, leading to an accident.
- When the system is turned on, the operating force of the electric power steering may change.

**NOTE**

- When the LDW is unavailable, the LDP does not operate.

**Lane Departure Warning (LDW)**

→ Refer to page 4-273

## Activating the LDP

## LDW OFF indicator light



When all of the following conditions are met, the LDP is activated.

- When driving at a speed of approximately 60 km/h (37 MPH) to 130 km/h (80 MPH)
- When the system detect the lane
- When the driver is holding and operating the steering wheel
- When the vehicle lane is not too wide or too narrow
- The LDW OFF indicator light is off

**NOTE**

- The timing of the warning by the LDW and the assisting of the steering wheel operation by the LDP differ.

### Operation of the LDP

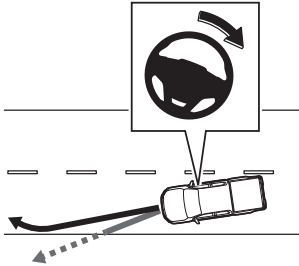

When the vehicle is about to depart from the lane while the LDW is issuing a warning, the system assists the steering wheel operation in the direction to avoid lane departure to control departure from the lane.

A warning message is displayed on the MID. At the same time, the steering wheel vibrates.

### When the LDP Does Not Operate



When the driver releases his or her hands from the steering wheel or is not gripping the steering wheel firmly for a while, a warning buzzer will sound. The system is temporarily canceled.



#### NOTE

- If you grip the steering wheel lightly, or depending on the road conditions, the system may determine that you have released your hands from the wheel (are not holding the wheel) even though you are gripping it.

Details of MID Indication

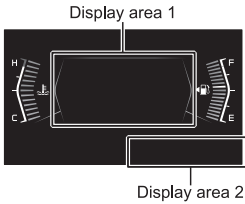

The following is shown on the MID depending on the conditions. If the driving support system information display is selected while the LDP is active, information is displayed in display area 1. On the other hand, if anything other than the driving support system information display is selected, information is displayed in display area 2.



**NOTE**

- When the white line of the lane is detected only on one side, only the detected line is displayed in the lane display of the MID.
- When the LDP is operating, information is displayed in display area 1 even though the driving support system information display is not selected.

**Display area 1**

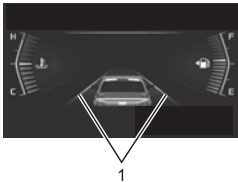

**Display area 2**

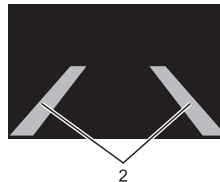

No.	Lane marker	Description
1	None	When the stereo camera does not detect lanes
	White	When the stereo camera detects lanes
	Yellow	When the LDP is operating
2	Gray	When the stereo camera does not detect lanes
	White	When the stereo camera detects lanes

### Operation of the LDW While the LDP Is Being Used

It is not possible to turn off the LDW while the LDP is operating.

#### LDW OFF indicator light



#### NOTE

- The LDP is not operating if the LDW OFF indicator light is on.

#### Lane Departure Warning (LDW)

→ Refer to page 4-273

### Automatic Stop of the Steering Assist by the LDP

If the following operations are performed, the LDP automatically stops the steering wheel assist. In this case, contact the nearest Isuzu Dealer.

- When there is an abnormality in the electric power steering
- When there is an abnormality in the brake system

### When the System Is Unavailable

#### LDW OFF indicator light



If there is a problem with the LDP, the LDW OFF indicator light comes on. At this time, the LDP does not operate.

If there is a problem with the camera, the system cannot be used.

**Stereo Camera** → Refer to page 4-210

## Settings of LDP

The LDP settings can be changed by using the user customization function on the MID.

## Settings (User Customization Function)

→ Refer to page 4-47

Display indication		Description	
Lane support settings	Lane departure prevention	Assist and warning	Issues a warning and performs steering assist
		Warning only	Only issues a warning
		Off	Turns off the LDP (cancels a warning and steering assist)



## NOTE

- When only a warning is issued, only the LDW operates and the steering assist does not operate.
- Even if the LDP is turned off by using the user customization function, the system is turned on again when the engine is restarted.

## To Turn Off the LDW by LSS Switch (Models with EPS)

→ Refer to page 4-295

## Emergency Lane Keeping (ELK)

The emergency lane keeping (ELK) is a system that supports the prevention of collisions by assisting steering operations when the system determines there is a possibility of colliding with a vehicle following on the left or right as you are changing lanes. Regardless of whether the driver operates the turn signal, when the vehicle starts to change lanes while the radar sensors detect another vehicle, and when the system determines that your vehicle may depart from its lane, the system assists the driver's steering wheel operation to return the vehicle to its lane. The system detects lanes with the stereo camera and determines that your vehicle may depart from its lane. At the same time, it notifies the driver of the danger by the MID display, buzzer, and steering wheel vibration. The same radar sensors as the blind spot monitor (BSM) are used (The operating range of the ELK is the same as the BSM).

The lane departure warning (LDW), lane departure prevention (LDP), emergency lane keeping (ELK), and lane keep assist system (LKAS) that help prevent lane departure are collectively called the lane support system (LSS).

### Blind Spot Monitor (BSM)

→ Refer to page 4-179

#### WARNING

- The driver is responsible for safe driving. Always check the surrounding area yourself to be safe when driving the vehicle.
- Do not rely entirely on the ELK. The ELK is not an autonomous driving system. The system does not operate in all situations. Relying only on the system to keep the vehicle in the lane may lead to an accident, such as a collision with an obstacle on the side of the lane or a vehicle driving in the adjacent lane. The system does not allow you to drive while looking aside or to drive without your hands on the steering wheel, etc. Be sure to grip the steering wheel while driving the vehicle.
- If the amount and timing of the system's controls differ from your feeling of driving operations, do not use the system because it cannot support driving safely.
- Do not perform the operation test of the system by yourself.
- If the stereo camera cannot detect an object (lanes) or if the stereo camera temporarily stops or malfunctions, the ELK does not operate.
- Do not use the system in the following situations.
  - When emergency repairs using a puncture repair kit have been done
  - When tire chains are installed
  - When the vehicle drives unstably due to a traffic accident or malfunction
  - When the brake system warning light is on
  - When towing a vehicle, etc.

WARNING (Continued)

## WARNING (Continued)

- In the following situations, do not use the system because an accident may unexpectedly occur. It may not be able to properly control the vehicle because the lane cannot be recognized.
  - General roads (other than limited access roads); It may not be possible to drive according to traffic conditions due to the road environment (such as the case where a road is complicated), leading to an unexpected accident.
  - Roads with curves (This function is enabled only on straight roads)
  - A lane restriction or a temporary lane due to construction, etc.
  - Old lane markings remain
  - Avoiding a stationary vehicle
  - Snow, puddles, or snow melting agent remains on the road surface
  - There is a crack or repair mark on the road surface
  - When driving on a slippery road, such as an icy road or snowy road; the tires may slip and control of the vehicle may be lost.
  - When the vehicle enters an interchange or junction, or it enters a rest area, parking area, tollbooth, etc.

**CAUTION**

- In the following situations, the ELK may not perform sufficiently, or the ELK may not operate or may be deactivated.
  - When the lane cannot be detected
  - When the vehicle speed is less than approximately 60 km/h (37 MPH)
  - When driving on curves
  - When turning the steering wheel sharply
  - When braking suddenly
  - Immediately after the vehicle weight changes drastically
  - Immediately after tires are changed or the tire air pressure is adjusted
  - Immediately after a camera-related parts are adjusted, repaired or replaced
  - Immediately after the suspension or steering system is repaired or replaced
  - When studless tires or non-genuine tires are installed
  - When subject to a crosswind
  - When the road surface gradient changes rapidly (uphill, downhill)
  - When the lateral gradient of the road is extreme or changes rapidly
  - Roughness, undulation or seams in the road surface

CAUTION (Continued)

## CAUTION (Continued)

- When acceleration/deceleration is extreme
- When the outside air temperature is high
- When the wipers are moving fast
- When the operation time of the ELK is long
- When the ABS or TCS is operating
- When an object that blocks the stereo camera's field of view has been installed
- When the brightness of the headlights is insufficient because the headlights are dirty or the headlight beams are misaligned
- When headlights, fog lights, etc. have been modified
- When the brightness drastically changes, such as when entering or exiting a tunnel or when going under an overpass
- When water, snow or dust is thrown up by preceding vehicles or oncoming vehicles, or sand, smoke, or water vapor is carried by the wind in front of your vehicle
- When the windshield is foggy, or there is snow, dirt, frost, or dust on it, or it is scratched
- When raindrops, water drops, or dirt on the windshield is not wiped away completely
- When the field of view of the stereo camera is obstructed by a canoe, etc. loaded on the roof
- When the headlights are not on at night or in a tunnel
- When it is dim in the early evening or morning
- When weather conditions are bad (rain, snow, etc.)
- When light is reflected off a wet road surface
- When the distance between vehicles is short and it is difficult to see the lane markings
- When shadows, such as of guardrails, cover the lane markings
- When the vehicle is subject to strong light from the forward direction (backlight from sunlight, light from headlights, etc.)
- When the vehicle lane is too narrow or too wide
- When the width of the vehicle lane changes
- When lane markings do not exist or are fading
- When lane markings are difficult to see because their color is similar to that of the road surface
- When the lane markings are drawn twice

CAUTION (Continued)

## CAUTION (Continued)

- When the width of the lane markings is narrow
- When lines other than the lane markings are drawn on the road surface
- When a wall or pole is adjacent to the lane markings
- When the shape of lane markings changes drastically (such as at the start or end of curves, at speed limiting systems, or on continuously curving roads)
- When reaching branching lanes at expressway interchanges, junctions, rest areas, parking area entrances, etc.
- When there are curbstones or side walls on the road shoulder
- If the ELK is not used, be sure to turn off the system. If the system is left on, it may operate in an unexpected situation, leading to an accident.
- When the system is turned on, the operating force of the electric power steering may change.

**Operating Conditions of the ELK**

The ELK operates when all the following conditions are met.

- When the power mode is "ON" (models with passive entry and start system) or the starter switch is in the "ON" position (models without passive entry and start system).
- When driving at a vehicle speed of approximately 60 km/h (37 MPH) to 130 km/h (80 MPH)
- When the gearshift lever is not in the "R" position (manual transmission model), or the selector lever is not in the "R" position (automatic transmission model).
- The ELK OFF indicator light is off

**ELK OFF indicator light**A rectangular box containing the text "ELK" on the top line and "OFF" on the bottom line, both in a bold, sans-serif font.

## Operation of the ELK

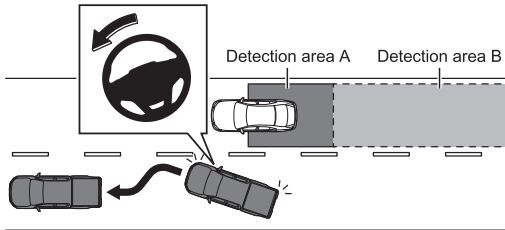

## Warning display



Regardless of whether the driver operates the turn signal, when the vehicle starts to change lanes during a BSM warning and a detected vehicle is in detection area A, and if the vehicle seems to be departing from the lane toward the detected vehicle, the system assists the driver's steering wheel operation to avoid lane departure.

A warning display is displayed on the MID. At the same time, a buzzer sounds.



## NOTE

- The ELK does not operate while your vehicle is being driven in its own lane, even if another vehicle enters the detection area.

### When the ELK Does Not Operate



When the driver releases his or her hands from the steering wheel or is not gripping the steering wheel firmly for a while, a warning buzzer will sound. The ELK is temporarily canceled.



#### NOTE

- If you grip the steering wheel lightly, or depending on the road conditions, the system may determine that you have released your hands from the wheel (are not holding the wheel) even though you are gripping it.

Details of MID Indication

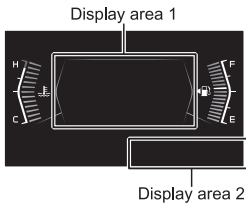

The following is shown on the MID depending on the conditions. If the driving support system information display is selected while the ELK is active, information is displayed in display area 1. On the other hand, if anything other than the driving support system information display is selected, information is displayed in display area 2.



**NOTE**

- When the white line of the lane is detected only on one side, only the detected line is displayed in the lane display of the MID.
- When the ELK is operating, information is displayed in display area 1 even though the driving support system information display is not selected.

**Display area 1**

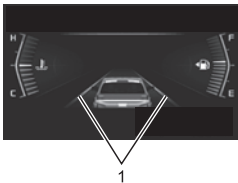

**Display area 2**

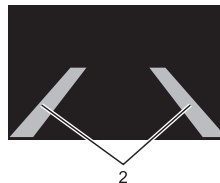

No.	Lane marker	Description
1	None	When the stereo camera does not detect lanes
	White	When the stereo camera detects lanes
	Red	When the ELK is operating
2	Gray	When the stereo camera does not detect lanes
	White	When the stereo camera detects lanes

### Automatic Stop of the Steering Assist by the ELK

If the following operations are performed, the ELK automatically stops the steering wheel assist. In this case, contact the nearest Isuzu Dealer.

- When there is an abnormality in the electric power steering
- When there is an abnormality in the brake system

### When the ELK Is Unavailable

#### ELK OFF indicator light



When either one of the following conditions is met, the ELK is unavailable.

- When the ELK OFF indicator light comes on
- When the stereo camera is unavailable
- When the radar sensors are unavailable

**Stereo Camera** → Refer to page 4-210

To Turn Off the ELK

If you do not want the ELK to operate, it is possible to turn off the system. The setting can be set by using the user customization function on the MID.

Settings (User Customization Function)

→ Refer to page 4-47

Display indication		Description	
Lane support settings	Emergency lane keeping	Enable	Turns on the ELK
		Disable	Turns off the ELK

ELK OFF indicator light



When the system is turned off, the ELK OFF indicator light comes on.



NOTE

- The system is turned on again when the engine is restarted.

To Turn Off the ELK, LDP and LDW by LSS Switch (Models with EPS) (Where Installed)

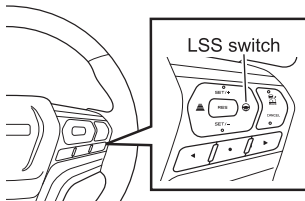

If you want to turn off ELK, LDP and LDW immediately press and hold the LSS switch.

When the ELK, LDP and LDW are off, the LDW OFF indicator light and the ELK OFF indicator light come on.

At this time, the LDP, ELK and LKAS are also turned off.

To turn on those systems, press and hold the LSS switch again.

LDW OFF indicator light



ELK OFF indicator light



NOTE

- When the engine is restarted after it is stopped, the system is turned on again.

## Lane Keep Assist System (LKAS)

The lane keep assist system (LKAS) is a function that assists the steering wheel operations to keep your vehicle driving in the center area of a lane by detecting white lines of the lane with a stereo camera while the vehicle is being driven on an expressway or a controlled-access road. This function is available when the adaptive cruise control is used.

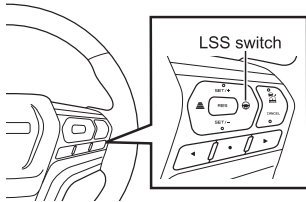

The lane departure warning (LDW), lane departure prevention (LDP), emergency lane keeping (ELK), and lane keep assist system (LKAS) that help prevent lane departure are collectively called the lane support system (LSS).

### WARNING

- The driver is responsible for safe driving. Always check the surrounding area to be safe when driving the vehicle.
- Do not rely entirely on the LKAS. The LKAS is not an autonomous driving system. The system does not operate in all situations. Relying only on the system to keep the vehicle in the lane may lead to an accident, such as a collision with an obstacle on the side of the lane or a vehicle driving in the adjacent lane. The system does not allow you to drive while looking aside or to drive without your hands on the steering wheel, etc. Be sure to grip the steering wheel while driving the vehicle.
- If the amount and timing of the system's controls differ from your feeling of driving operations, do not use the system because it cannot support driving safely.
- Do not perform the operation test of the system by yourself.
- If the stereo camera cannot detect lanes or if the stereo camera temporarily stops or malfunctions, the LKAS does not operate.
- Do not use the system in the following situations.
  - When emergency repairs using a puncture repair kit have been done
  - When tire chains are installed
  - When the vehicle drives unstably due to a traffic accident or malfunction
  - When the brake system warning light is on
  - When towing a vehicle, etc.

WARNING (Continued)

## WARNING (Continued)

- In the following situations, do not use the system because an accident may unexpectedly occur. It may not be able to properly control the vehicle because the lane cannot be recognized.
  - General roads (other than limited access roads); It may not be possible to drive according to traffic conditions due to the road environment (such as the case where a road is complicated), leading to an unexpected accident.
  - Roads with sharp curves
  - A lane restriction or a temporary lane due to construction, etc.
  - Old lane markings remain
  - Avoiding a stationary vehicle
  - Snow, puddles, or snow melting agent remains on the road surface
  - There is a crack or repair mark on the road surface
  - When driving on a slippery road, such as an icy road or snowy road; the tires may slip and control of the vehicle may be lost.
  - When the vehicle enters a sharp curve, such as an interchange or junction, or it enters a rest area, parking area, or tollbooth, etc.
  - When a vehicle in the adjacent lane cuts into your lane, or a vehicle ahead changes lanes
  - When the shape of curves change rapidly
  - When an object that blocks the stereo camera's field of view has been installed
  - When the brightness of the headlights is insufficient because the headlights are dirty or the headlight beams are misaligned
  - When headlights, fog lights, etc. have been modified
  - When water, snow or dust is thrown up by preceding vehicles or oncoming vehicles, or sand, smoke, or water vapor is carried by the wind in front of your vehicle
  - When the windshield is foggy, or there is snow, dirt, frost, or dust on it, or it is scratched
  - When raindrops, water drops, or dirt on the windshield is not wiped away completely
  - When the field of view of the stereo camera is obstructed by a canoe, etc. loaded on the roof
  - When the headlights are not on at night or in a tunnel
  - When it is dim in the early evening or morning
  - When weather conditions are bad (rain, snow, etc.)
  - When light is reflected off a wet road surface

WARNING (Continued)

## WARNING (Continued)

- When the distance between vehicles is short and it is difficult to see the lane markings
- When a vehicle in the adjacent lane cuts into your lane, or a vehicle ahead changes lanes
- When shadows, such as of guardrails, cover the lane markings
- When the vehicle is subject to strong light from the forward direction (backlight from sunlight, light from headlights, etc.)
- When the vehicle lane is too narrow or too wide
- When the width of the vehicle lane changes
- When lane markings do not exist or are fading
- When lane markings are difficult to see because their color is similar to that of the road surface
- When the lane markings are drawn twice
- When the width of the lane markings is narrow
- When lines other than the lane markings are drawn on the road surface
- When a wall or pole is adjacent to the lane markings
- When the shape of lane markings changes drastically (such as at the start or end of curves, at speed limiting systems, or on continuously curving roads)
- When reaching branching lanes at expressway interchanges, junctions, rest areas, parking area entrances, etc.
- When there are curbstones or side walls on the road shoulder
- When the brightness changes under an overpass, etc.

**CAUTION**

- In the following situations, the LKAS may not perform sufficiently, or the LKAS may not operate or may be deactivated.
  - Immediately after the vehicle weight changes drastically
  - Immediately after tires are changed or the tire air pressure is adjusted
  - Immediately after a camera-related parts are adjusted, repaired or replaced
  - Immediately after the suspension or steering system is repaired or replaced
  - When studless tires or non-genuine tires are installed
  - When subject to a crosswind
  - When the road surface gradient changes rapidly (uphill, downhill)
  - When the lateral gradient of the road is extreme or changes rapidly

CAUTION (Continued)

## CAUTION (Continued)

- Roughness, undulation or seams in the road surface
- When acceleration/deceleration is extreme
- When the outside air temperature is high
- When the hazard warning flashers are operating
- When the ABS or TCS is operating
- When braking suddenly
- When the lane is too narrow or too wide
- When the vehicle speed becomes less than approximately 60 km/h (37 MPH) or more than approximately 130 km/h (80 MPH)
- The LKAS is canceled in the following cases.
  - When the adaptive cruise control is deactivated
  - When the turn signal is operated
  - When the stereo camera cannot recognize lanes on both sides
  - When the front wipers are operating at a high speed
  - When it is determined that the driver is operating the steering wheel to deviate from a lane
  - When the driver turns the steering wheel sharply or quickly
  - When your vehicle speed becomes less than approximately 60 km/h (37 MPH) or more than approximately 130 km/h (80 MPH)
  - When the system cannot detect the driver's steering wheel operations for a certain time
  - When entering sharp curves
  - When driving on sharp curves
  - When the system determines that continuing to assist steering wheel operations is difficult because of problems in a system on the vehicle other than this function
- If the LKAS is not used, be sure to turn off the system. If the system is left on, it may operate in an unexpected situation, leading to an accident.
- When the system is turned on, the operating force of the electric power steering may change.

### Operation Conditions of the LKAS

The LKAS operates when all the following conditions are met.

- The adaptive cruise control is operating
- The vehicle is driving at a speed of approximately 60 to 130 km/h (37 to 80 MPH)
- The system recognizes lane markings on the both sides
- The driver is operating the steering wheel
- The vehicle is driving on a road with a lane width of approximately 3 to 4 m (10 to 13 ft)

### Operation of the LKAS

#### LSS switch

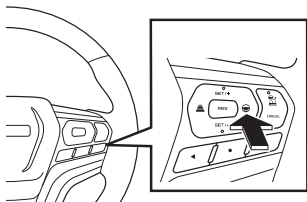

When the adaptive cruise control is set, press the LSS switch to set the LKAS to on. At this time, the LKAS indicator light comes on gray.

When the stereo camera recognizes both the left and right lanes, the indicator light comes on green.

#### LKAS indicator light (Gray/Green)

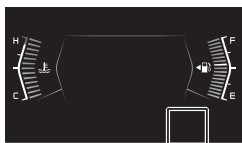

Display area

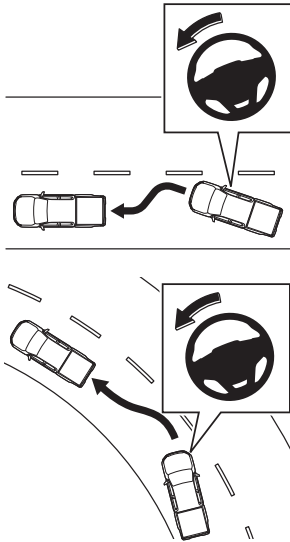

The system recognizes lanes and assists the steering wheel operations to keep the vehicle driving in the center area of the lane while driving at a speed of approximately 60 to 130 km/h (37 to 80 MPH) while the adaptive cruise control is set.

### When the LKAS Does Not Operate

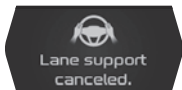
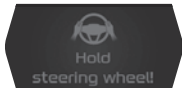

When the driver releases his or her hands from the steering wheel or is not gripping the steering wheel firmly for a while, the system sounds a warning buzzer. A warning message is displayed on the MID. The system is temporarily canceled.



#### NOTE

- If you grip the steering wheel lightly, or depending on the road conditions, the system may determine that you have released your hands from the wheel (are not holding the wheel) even though you are gripping it.

Details of MID Indications

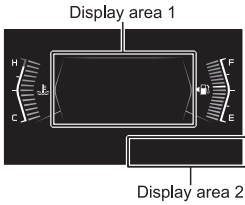

The following is shown on the MID depending on the conditions. If the driving support system information display is selected while the LKAS is active, information is displayed in display area 1. On the other hand, if anything other than the driving support system information display is selected, information is displayed in display area 2.

Display area 1

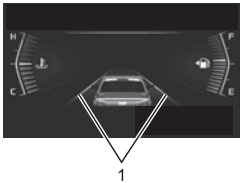

Display area 2

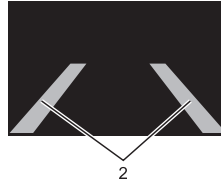

No.	Lane marker	Description
1	None	When the stereo camera does not detect lanes
	White	When the stereo camera detects lanes
	Green	When the LKAS is operating
2	Gray	When the stereo camera does not detect lanes
	White	When the stereo camera detects lanes
	Green	When the LKAS is operating

## To Turn Off the LKAS

### LSS switch

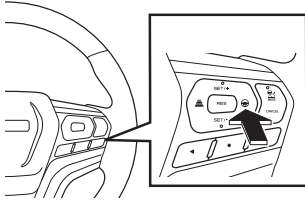

Press the LSS switch again to set it to off. The LKAS indicator light will go out.

To turn on the LKAS, push the LSS switch again.



### NOTE

- In the following situations, the system cannot detect the steering wheel operations and the system may be deactivated temporarily.
  - When driving with your hands lightly on the steering wheel
  - When the driver just slightly moves the steering wheel

### LDW OFF indicator light



### ELK OFF indicator light



If you want to turn off ELK, LDP and LDW immediately press and hold the LSS switch.

When the ELK, LDP and LDW are off, the LDW OFF indicator light and the ELK OFF indicator light come on.

At this time, the LDP, ELK and LKAS are also turned off.

To turn on those systems, press and hold the LSS switch again.

## When the LKAS Is Unavailable

When there is an abnormality in the LKAS, the LKAS does not operate.

If there is a problem with the camera, the system cannot be used.

**Stereo Camera** → Refer to page 4-210

### Attention Assist

The attention assist detects weaving based on the vehicle's meandering patterns in the lane and alerts the driver by a display on the MID and a buzzer.



#### WARNING

- The driver is responsible for safe driving. Always check the surrounding area yourself to be safe when driving the vehicle.
- The attention assist does not operate in all situations. Also, it is not intended to automatically correct the vehicle's weaving. Driving the vehicle by relying on the attention assist system may result in an unexpected accident.
- If the stereo camera cannot detect lanes or if the stereo camera temporarily stops or malfunctions, the attention assist does not operate.



#### CAUTION

- In the following cases, the attention assist may not operate normally.
  - When driving on continuous curves
  - When the vehicle speed changes significantly
  - Immediately after the vehicle changes lanes



#### NOTE

- Whether the vehicle is weaving or not is recognized based on the drive data in the past few minutes. Just after the vehicle starts weaving, it cannot be recognized. Also, there are some cases where the system continues operating even after the vehicle stops weaving.
- The attention assist is a function that alerts the driver. It is recommended to rest when your concentration for driving becomes poor, such as when you get tired or you do not pay attention to the road.

### Operation of the Attention Assist

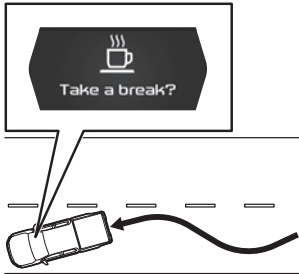

When the system detects that the vehicle is weaving while the vehicle is driving at approximately 60 km/h (37 MPH) or more, a warning is issued. A warning message is displayed on the MID. At the same time, a buzzer sounds.



#### NOTE

- When the vehicle speed falls below approximately 40 km/h (25 MPH), it stops operating. After that, when the vehicle speed exceeds approximately 60 km/h (37 MPH), it reactivates.

### When the Attention Assist Is Unavailable

If there is a problem with the stereo camera, the attention assist does not operate.

**Stereo Camera** → Refer to page 4-210

### Turning Off the Attention Assist

If you do not want the attention assist to operate, it is possible to turn off the system. The settings of the attention assist can be changed by using the user customization function on the MID.

**Settings (User Customization Function)**

→ Refer to page 4-47

	Display indication		Description
Lane support settings	Attention assist	Enable	Turns on the attention assist
		Disable	Turns off the attention assist



#### NOTE

- Even if the attention assist system is turned off by using the user customization function, the system is turned on again when the engine is restarted.

### Automatic High Beam (AHB)

While driving at night, automatic high beam (AHB) uses the stereo camera to determine the brightness of the oncoming vehicle's headlights, the preceding vehicle's taillights, and street lights, and automatically switches the headlights between high beam and low beam.



#### WARNING

- Do not rely entirely on the system. When driving, always pay attention to your surroundings and drive safely by manually switching the headlights between high beam and low beam as necessary.
- If the stereo camera cannot detect an object (another vehicle or light source) or if the stereo camera temporarily stops or malfunctions, the AHB does not operate.
- Do not modify the suspension or headlights, or remove the stereo camera. Doing so may prevent the AHB from operating properly.



#### NOTE

- In the following situations, the headlights may not switch from high beam to low beam automatically.
  - When your vehicle suddenly passes an oncoming vehicle on a curve with poor visibility
  - When another vehicle crosses in front of your vehicle
  - When an oncoming vehicle or the preceding vehicle appears and disappears due to continuous curves, a median strip, or roadside trees, etc.
  - When a vehicle in the forward direction approaches from a distant lane
  - When a vehicle in the forward direction is driving without lights on
- The headlights may switch from high beam to low beam due to the fog lights of an oncoming vehicle.
- The headlights may switch from high beam to low beam or the low beam lights may remain on due to reflective objects, such as street lights, lights of advertisements, road signs, or billboards.

NOTE (Continued)

## NOTE (Continued)

- Due to the following factors, the timing at which the headlights switch between high beam and low beam may change.
  - Brightness and colors of an oncoming or preceding vehicle's lights
  - Movement and direction of an oncoming or preceding vehicle
  - When only one headlight of an oncoming or preceding vehicle is on
  - When a motorcycle is oncoming or preceding
  - Road conditions (road gradients, curves, road surface conditions, etc.)
  - Number of passengers and amount of cargo
- During rapid acceleration, the AHB may not activate for several seconds even if the vehicle speed exceeds approximately 40 km/h (25 MPH).
- The AHB uses the stereo camera to recognize the brightness of the headlights of oncoming vehicles, the taillights or other lights of preceding vehicles, or street lights. Therefore, the headlights may not switch between high beam and low beam as expected by the driver.
- Lights of vehicles lacking a motor, such as bicycles, may not be detected.
- In the following situations, ambient brightness may not be detected accurately, and the high beam lights may disturb an oncoming vehicle and the preceding vehicle, or the low beam lights may remain on. In such a situation, manually switch the headlights between high beam and low beam.
  - In bad weather (such as heavy rain, snow, fog, or a sandstorm)
  - When there is a light similar to headlights or taillights around
  - When an oncoming vehicle or the preceding vehicle is driving without lights on (light bulbs have blown out, etc.), or when the lights of those vehicles are dirty or discolored or the headlight beams are misaligned
  - When there is something that significantly reflects light in front of the vehicle, such as a road sign and a mirror
  - When the rear part of the preceding vehicle significantly reflects light, such as if it is carrying a container
  - When the headlights of your vehicle are damaged or dirty
  - When sudden changes in brightness are continuous
  - When driving on an undulating road or a very uneven road
  - When driving on a road with many curves
  - When the vehicle is tilted, such as if a tire is flat or the vehicle is being towed

### To Use the AHB

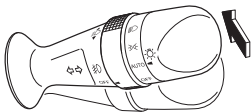

**AHB indicator light**



**High beam indicator light**

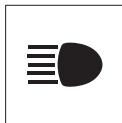

1. Set the light control switch to the "AUTO" position.
2. Move the light control switch lever forward to set it to the high beam position.

When the system determines that it is night based on the surrounding brightness, it activates the AHB. At this time, the AHB indicator light comes on.

When the AHB switches the headlight direction to upward, the high beam indicator light comes on.

### Conditions for Automatically Switching Between High Beam and Low Beam

When all the following conditions are met, the high beam lights come on.

- When the vehicle speed is approximately 40 km/h (25 MPH) or more
- When areas in front of the vehicle are dark, such as when there is no preceding vehicle or oncoming vehicle, or if the preceding vehicle or oncoming vehicle has no lights on

When either one of the following conditions is met, the low beam lights come on.

- When the vehicle speed is approximately 30 km/h (20 MPH) or less
- When areas in front of your vehicle are bright, such as if there are street lights in front of your vehicle or your vehicle is driving in an urban area
- An oncoming vehicle or the preceding vehicle turns on their lights

## Manually Switching the Headlights Between High Beam and Low Beam

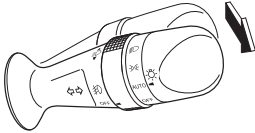

**AHB indicator light**



**High beam indicator light**

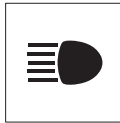

### Switching to Low Beam

Move the light control switch lever to its original position while the AHB is operating. The AHB indicator light turns off.

### Switching to High Beam

When the light control switch is set to the "☰" position while the AHB is operating, the headlights switch to the high beam.

The AHB operation light turns off, and the high beam indicator light comes on.

## Settings of the AHB

The AHB settings can be changed by using the user customization function on the MID.

### Settings (User Customization Function)

→ Refer to page 4-47

Display indication		Description	
Automatic high beam	Mode	Enable	Turns on the AHB
		Disable	Turns off the AHB

**Four Wheel Drive (4WD) Model**

2WD and 4WD ("4H (4WD high)" or "4L (4WD low)") operation can be selected using the 4WD switch. Change them according to the driving conditions.

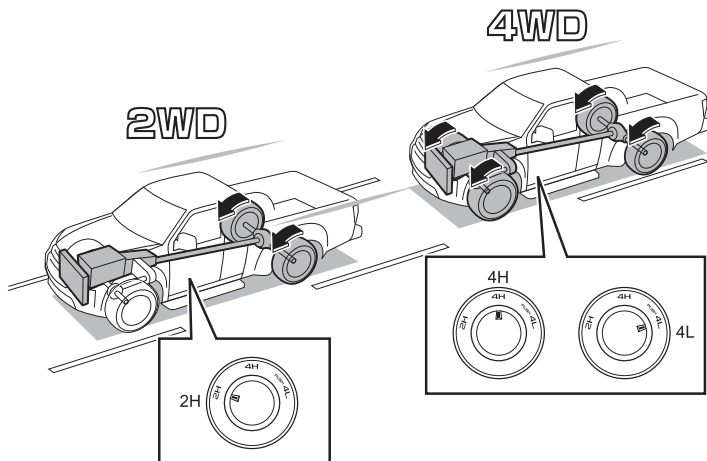
**CAUTION**

- Even a 4WD vehicle does not exempt you from safe driving practices. Operate the accelerator pedal, steering wheel and brake pedal with the same level of caution as when driving a standard rear-wheel drive vehicle.
- Install tires of the specified size, same brand and same tread design (including winter tires) on all wheels.

## 4WD Switch

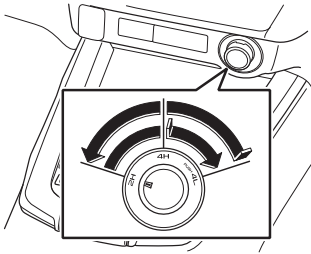

Use the 4WD switch to select 2WD or 4WD ("4H (4WD high)" or "4L (4WD low)").

**CAUTION**

- Driving in 4WD mode on dry, well-paved roads can accelerate wearing of the front tires and reduce fuel efficiency. As this action can also increase vehicle noise levels and lead to drive system damage, 2WD should always be used under these driving conditions.

**NOTE**

- When the vehicle speed, engine speed, gearshift lever (manual transmission models) or the selector lever (automatic transmission models) position, or clutch pedal operating condition (manual transmission models) conflict with the changing conditions and when there is an abnormality in 4WD system, a warning buzzer sounds to alert you that switching is not possible.
- In the event that the 4WD indicator light or 4WD low indicator light fail to either go off or come on even when the 4WD switch is operated, have the vehicle inspected and serviced at your Isuzu Dealer.
- When the CHECK 4WD warning light is on, have the vehicle inspected and serviced at your Isuzu Dealer.

**4WD Indicator Light**

→ Refer to page 4-95





**4WD Low Indicator Light**

→ Refer to page 4-95

**CHECK 4WD Warning Light**

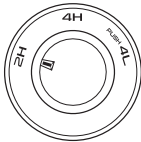
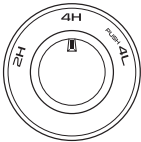
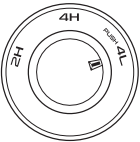
→ Refer to page 4-79

**Guidelines for 2WD to 4WD Switching**

Drive type	2WD	4WD	
	2H	4H (4WD high)	4L (4WD low)
4WD switch			
Indicator light	OFF		 
Driving conditions	During normal driving on an ordinary road or highway.	Wet roads, snow-covered roads, icy roads, and other roads where the vehicle needs more traction than 2WD.	Steep slopes, rough roads, sand, mud or deep snow, and other roads where the vehicle needs significant traction.

**ADVICE**

- Do not set the 4WD switch midway between the "2H" and "4H" positions or the "4H" and "4L" positions. Doing so could cause a malfunction.

### Switching from "2H" to "4H (4WD High)"



#### WARNING

- Do not operate the 4WD switch from "2H" to "4H" while the wheels are spinning. Stop the slipping or spinning first, and then operate the 4WD switch.

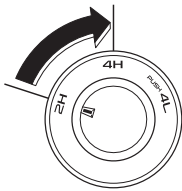

4WD indicator light



- Keep the vehicle moving straight and operate the 4WD switch to the "4H" position at a constant speed below 100 km/h (60 MPH).

- The 4WD indicator light comes on when "2H" is switched to "4H". The 4WD indicator light continues flashing until the operation is complete.



#### NOTE

- If the 4WD indicator light does not come on, move the vehicle slowly forward and backward.

### Switching from "4H (4WD High)" to "2H"

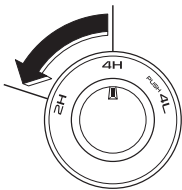

- Keep the vehicle moving straight and operate the 4WD switch to the "2H" position at a constant speed below 100 km/h (60 MPH).

2. The 4WD indicator light goes off when "4H" is switched to "2H".

The 4WD indicator light continues flashing until the operation is complete.

**NOTE**

- If the 4WD indicator light does not go off, move the vehicle slowly forward and backward.

**Switching between "4H (4WD High)" and "4L (4WD Low)"****NOTE**

- Operate the 4WD switch when all of the following conditions are fulfilled. If the 4WD switch is operated when the conditions are not fulfilled, a warning buzzer sounds while the 4WD indicator light and 4WD low indicator light flash to inform the driver that switching to "4H" or "4L" is not possible.

- The vehicle is stationary.
- The engine speed is less than 2,000 r/min.
- The clutch pedal is fully depressed, or the gearshift lever is placed in the "N" position (manual transmission model).
- The selector lever is placed in the "N" position (automatic transmission model).

- If the status before the 4WD switch operation is any of the following, a waiting time is needed before switching to "4H" or "4L" can be performed (waiting time: A maximum of approximately 3 minutes).

The 4WD indicator light and 4WD low indicator light flash until switching is complete.

In these cases, the waiting time can be reset by switching the power mode to "OFF" (models with passive entry and start system) or turning the starter switch to the "LOCK" position (models without passive entry and start system).

- The vehicle is stopped for an extended period of time with the gearshift lever in the "1 (1st)" position and the clutch pedal depressed (manual transmission model).
- The vehicle is stopped for an extended period of time with the selector lever in the "D" position and the brake pedal depressed (automatic transmission model).

1. Stop the vehicle.
2. On the manual transmission model, fully depress the clutch pedal or shift the gearshift lever to the "N" position. On the automatic transmission model, shift the selector lever to the "N" position and check that the shift indicator indicates "N".
3. Select "4H" or "4L" while pressing the 4WD switch.

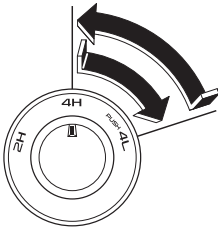

4WD low indicator light



ESC warning light



TCS OFF indicator light

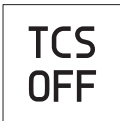

ESC OFF indicator light



4. When "4H" is switched to "4L", the 4WD low indicator light comes on, and when "4L" is switched to "4H", the 4WD low indicator light goes off.



**NOTE**

- If the 4WD low indicator light does not come on or go off, move the vehicle slowly forward and backward.
- ESC warning light, TCS OFF indicator light, and ESC OFF indicator light also come on when the 4WD switch is set to 4L (4WD low).

**Switching between "2H" and "4L (4WD Low)"****CAUTION**

- Do not operate the 4WD switch while the rear wheels are spinning on a snow-covered, frozen or slippery road.

**NOTE**

- Operate the 4WD switch when all of the following conditions are fulfilled. If the 4WD switch is operated when the conditions are not fulfilled, a warning buzzer sounds while the 4WD indicator light and 4WD low indicator light flash to inform the driver that switching to "2H" or "4L" is not possible.
  - The vehicle is stationary.
  - The engine speed is less than 2,000 r/min.
  - The clutch pedal is fully depressed, or the gearshift lever is placed in the "N" position (manual transmission model).
  - The selector lever is placed in the "N" position (automatic transmission model).
- If the status before the 4WD switch operation is any of the following, a waiting time is needed before switching to "2H" or "4L" can be performed (waiting time: A maximum of approximately 3 minutes).  
The 4WD indicator light and 4WD low indicator light flash until switching is complete.  
In these cases, the waiting time can be reset by switching the power mode to "OFF" (models with passive entry and start system) or turning the starter switch to the "LOCK" position (models without passive entry and start system).
  - The vehicle is stopped for an extended period of time with the gearshift lever in the "1 (1st)" position and the clutch pedal depressed (manual transmission model).
  - The vehicle is stopped for an extended period of time with the selector lever in the "D" position and the brake pedal depressed (automatic transmission model).

1. Stop the vehicle.
2. On the manual transmission model, fully depress the clutch pedal or shift the gearshift lever to the "N" position. On the automatic transmission model, shift the selector lever to the "N" position and check that the shift indicator indicates "N".
3. Operate the 4WD switch to "4L" or "2H".

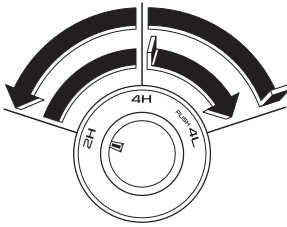

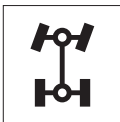
4WD indicator  
light4WD low indicator  
light

4. When "2H" is switched to "4L", the 4WD indicator light and 4WD low indicator light come on, and when "4L" is switched to "2H", the 4WD indicator light and 4WD low indicator light go off.

**NOTE**

- If the 4WD indicator light and 4WD low indicator light do not come on or go off, move the vehicle slowly forward and backward.
- ESC warning light, TCS OFF indicator light, and ESC OFF indicator light also come on when the 4WD switch is set to 4L (4WD low).

ESC warning light

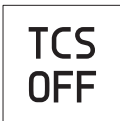
TCS OFF  
indicator lightESC OFF  
indicator light

### Tire Pressure Monitoring System (TPMS)

This system promptly alerts the driver about decreases in tire air pressure by monitoring each tire's air pressure at constant intervals with the air pressure sensors that are installed on the wheels.



#### CAUTION

- The TPMS is not a substitution for daily checks. Check the tire air pressure as a part of daily checks.



#### ADVICE

- When replacing tire related parts (tires, wheels, wheel nuts, etc.), consult your Isuzu Dealer.

**NOTE**

- The TPMS monitors air pressure through tire air pressure sensors installed to each tire (total 5 tires that include 4 tires attached on the vehicle and a spare tire) that communicate with the vehicle computer.
- Each tire air pressure sensor has a unique ID code, and registering the ID code in the vehicle computer enables the sensor to monitor the tire air pressure.
- Drive the vehicle for approximately 10 minutes at a speed of 30 km/h (19 MPH) or more to register the ID codes mounted on each tire to the vehicle computer.
- In the following cases, the TPMS does not operate:
  - When using tires that do not have tire air pressure sensors.
  - When the TPMS warning light flashes for approximately 1 minute and then comes on.
- In the following cases, the TPMS may not operate properly:
  - When using other than genuine wheels.
  - When changing to other than factory-equipped tires.
  - When tire chains are attached.
  - When a lot of snow, ice, etc. is attached to the vehicle (especially the areas around tires).
  - When electronic wave blocking film is applied to the windows.
  - When the tire air pressure suddenly and drastically decreases due to a burst tire, etc.
  - When a commercially available tire sealant is used.
  - When communication devices such as mobile phones, two-way radios, or laptops are in the vicinity.
  - When in areas where there is strong electrical disturbance, such as near a TV tower, electric power plant, or radio station.
  - When the tire air pressure drops below 150kPa (1.5bar / 21.76psi).

## Operation of the TPMS

## TPMS warning light

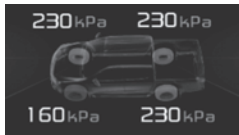
Tire air pressure display  
(models with MID)

When the tire air pressure drops below the standard value, the TPMS warning light comes on.

At this time, in models with MID, the tire air pressure display appears on the MID.

The minimum setting range for TPMS is 150kPa (1.5bar / 21.76psi) tire air pressure.



## NOTE

- In models with MID, it is possible to check the each tire air pressure detected by the TPMS.

## How to Change Standard Tire Air Pressure to That for a Loaded or Unloaded Vehicle

For vehicles equipped with tires of the sizes listed below, the standard tire air pressure values must be switched between an unloaded vehicle and a loaded vehicle.

- 205R16C
- 255/65R17
- 265/60R18

Follow the procedures below to switch the standard tire air pressure values.

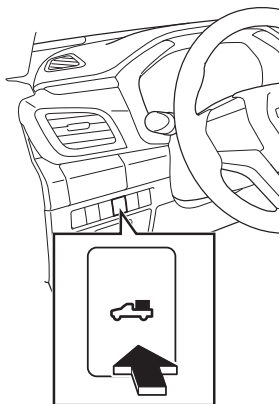

TPMS loading indicator light



TPMS warning light



1. Switch the power mode to "ON" (models with passive entry and start system), or turn the starter switch to the "ON" position (models without passive entry and start system).
2. Pressing the TPMS load selector switch changes the standard tire air pressure value to the value for a loaded vehicle. At the same time, the TPMS loading indicator light comes on. By pressing the switch again, the standard tire air pressure value will return to the value for an unloaded vehicle, and TPMS loading indicator light will turn off.

When the standard tire air pressure value is changed, the TPMS warning light flashes for approximately 6 seconds.



### ADVICE

- We strongly recommend that the vehicle is stopped when you press the switch to change the standard tire air pressure to that for a loaded or unloaded vehicle.

## Tire Air Refill Assist Function

### Models with Passive Entry and Start System

When you refill a tire with air, this function assists the work by notifying you of the air pressure condition with the hazard warning flashers and a buzzer.



#### NOTE

- The tire air refill assist function operates only when all of the following conditions are met:
  - The initial setting of the TPMS is completed.
  - The vehicle is completely stopped.
- The tire air refill assist function is just a supplemental function. Use an air pressure gauge when more accurate air pressure adjustment is required.

1. Make sure that the parking brake lever is fully pulled.
2. Switch the power mode to "ON".
3. Refill the tire with air. When the tire air refill assist function is activated, the hazard warning flashers flash at 2-second intervals.
4. When the tire is refilled with air and the appropriate tire air pressure is reached, the hazard warning flashers flash 3 times and a buzzer sounds 3 times.



#### NOTE

- If the tire air pressure exceeds the upper or lower limit of the appropriate air pressure, the hazard warning flashers flash 7 times and a buzzer sounds 7 times.
5. Wait approximately 30 seconds after refilling the tire with air. The tire air refill assist function is deactivated, and the hazard warning flashers stop flashing.
  6. If the other tires on the vehicle need to be refilled with air, repeat the procedure from step 3.

## TPMS Initialization

## TPMS warning light



When a tire is replaced or tire rotation is performed, initialization of the TPMS is not necessary. Drive the vehicle for approximately 10 minutes at a speed of 30 km/h (19 MPH) or more to automatically register the TPMS sensors. If the TPMS sensors fail to register, the TPMS warning light flashes.



## NOTE

- If a new ID is mounted on the tires, then displaying the standard tire air pressure may take some time.
- Depending on vehicle conditions and driving conditions, it may take a longer time to complete the initialization or initialization may not be performed correctly.
- If the initialization does not complete properly, or if the TPMS warning light flashes for approximately 1 minute and then illuminates after the initialization is complete, have the vehicle inspected at the nearest Isuzu Dealer.

• Air Outlets	5-2	• Small Article Storage Pocket (Driver's Side)	5-38
• Automatic Air Conditioner	5-5	• Center Console Box	5-39
• Manual Air Conditioner	5-15	• Cup Holder	5-40
• Interior Lights	5-26	• Cup Holder and Small Article Storage Pocket	5-41
• Overhead Console	5-29	• Bottle Holder and Small Article Storage Pocket (Front and Rear Doors)	5-43
• Sun Visor	5-30	• Grip	5-44
• Ticket Holder	5-30	• Coat Hook	5-45
• Vanity Mirror	5-31	• Hook	5-45
• Accessory Socket	5-31	• Antenna	5-46
• USB Power Outlet	5-33	• Steering Wheel Remote Control	5-47
• Small Article Storage Pocket	5-34	• Rear Vision Camera	5-48
• Small Article Storage Pocket (Passenger's Side)	5-35		
• Glove Compartment	5-36		
• Dashboard Tray	5-37		
• Small Article Storage Pocket (Upper Side of Dashboard)	5-37		

Air Outlets

Front outlets

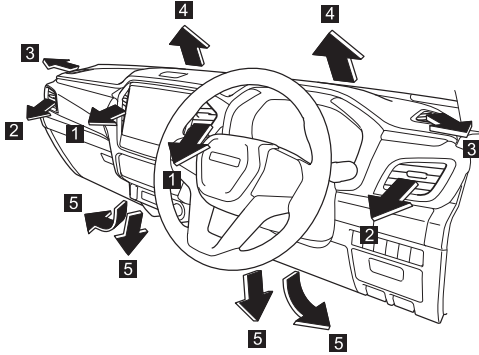

Second seat outlets

Type 1

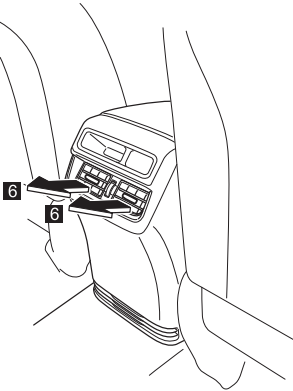

Type 2

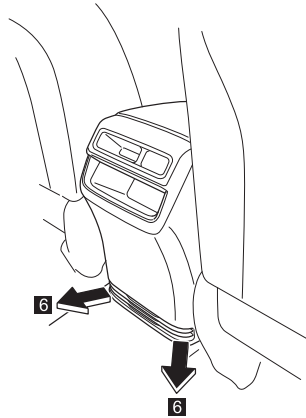

No.	Outlet	Features
1	Front center outlet	Air flow direction is adjustable with the tab.
2	Front side outlet	Air flow direction is adjustable with the tab.
3	Door windows outlet (If equipped)	Air is delivered towards the door windows.
4	Windshield outlet (If equipped)	Air is delivered towards the windshield.
5	Foot outlet (If equipped)	Air is delivered towards the feet.
6	Second seat outlet (If equipped)	Air is delivered towards the second seat.

**Air Flow Direction Control Tab**

Use the tab to control the air flow direction from the outlet.

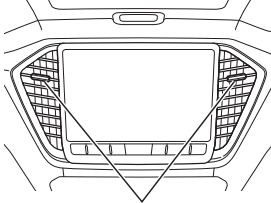
**Front center outlet**

Air flow direction  
control tab

To close the front center outlet, move the tab inward.

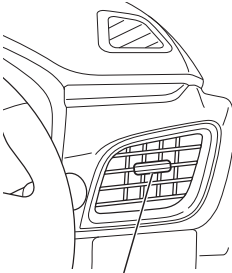
**Front side outlet**

Air flow direction control tab

To close the front side outlet, move the tab outward.

**Second seat outlet**

To close the second seat outlet, move the dial fully down.

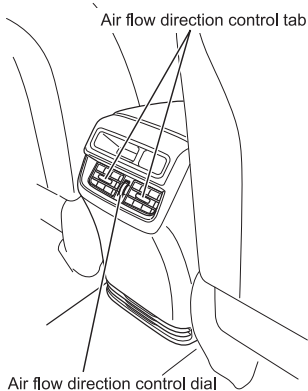
**Automatic Air Conditioner**

Use the automatic air conditioner only when the engine is running.

**ADVICE**

- Do not use the automatic air conditioner when the engine is not running. The automatic air conditioner consumes large amounts of electricity and could discharge the battery completely.

**NOTE**

- If airflow drops or the air conditioner does not work well, the air conditioning filter may be clogged. In this case, consult the nearest Isuzu Dealer.

## Switch and Display

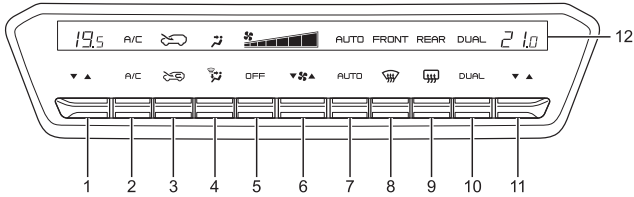

No.	Name	Function
1	Temperature control switch (left front seat)	Adjusts the temperature of the passenger side.
2	Air conditioning switch (A/C switch)	Switches the air conditioner on and off.
3	Inside/outside air selector switch	Switches between inside air recirculation and outside air ventilation.
4	Outlet selector switch	Switches the outlets.
5	Air conditioning off switch (OFF switch)	Turns off the air conditioner and the fan.
6	Fan speed control switch	Adjusts the airflow.
7	Automatic air conditioning switch (AUTO switch)	Sets the air conditioner to automatic control.
8	Windshield defroster switch	Defogs the windshield.
9	Rear window defogger switch	Defogs the rear window.
10	Dual switch	Sets the temperature of the driver side and passenger side individually.
11	Temperature control switch (right front seat)	Adjusts the temperature of the driver side.
12	Display area	The switch symbols come on in this area.

**NOTE**

- All switches can be operated up and down.

**Symbol in the Display Area**

When lights are turned on by operating the light control switch, the display area dims. At the same time, the switch symbol above the switch comes on.

### Using the Air Conditioner in Automatic Mode

1. Operate the AUTO switch (7).

The "AUTO" symbol comes on.

2. Set the temperature with the temperature control switch (1) (11).

When different temperatures are set on the driver and passenger sides, the "DUAL" symbol comes on.

When the AUTO switch is turned on, the following functions are automatically controlled according to the set temperature.

- Temperature control of blowing air
- Adjustment of the blowing airflow
- Switching of the outlet
- Switching between inside air recirculation/outside air ventilation

3. Operating the A/C switch (2) turns on the air conditioner.



#### NOTE

- While the "AUTO" symbol is turned on, one of the functions among the fan speed control switch, outlet selector switch, and windshield defroster switch can be manually operated by operating the respective switch.
- At this time, the "AUTO" symbol turns off, but functions other than the one operated manually remain in automatic control.

## How to Use Switches

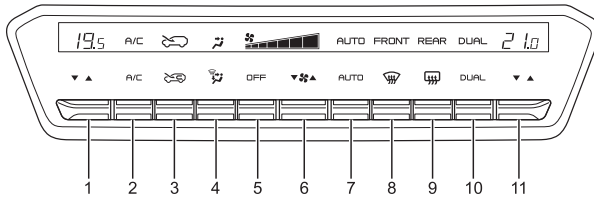
**Temperature Control Switch**

By operating the switch (1), the temperature of the left front seat can be adjusted. By operating the switch (11), the temperature of the right front seat can be adjusted. While the "DUAL" symbol is turned off, the temperature of the passenger side can be set the same as the driver side.

Operating the switch upward increases the temperature. Operating the switch down lowers the temperature.

The temperature can be adjusted in increments of 0.5 C (33 F). The set temperature is displayed in the display area.

The adjustable temperature range is between 18 C (64 F) and 32 C (90 F). If you set the temperature at 18 C (64 F), the system invariably sets the control for maximum cooling; if you set it at 32 C (90 F), the system sets the control for maximum heating.

**NOTE**

- By operating the temperature control switch on the passenger side while the "DUAL" symbol is turned off, the "DUAL" symbol comes on, and the temperatures on the passenger side and the driver side can be individually set.
- Because the heater uses the heat from the engine coolant, its heating effect is weak when the engine coolant temperature is low.
- After prolonged parking in direct sunlight, open the windows or doors to ventilate the interior of the cab and release the heat before turning the air conditioning system on.
- Prolonged use of the air conditioning system in the maximum cooling setting will make the interior air become stale. Occasionally operate the inside/outside air selector switch (3) to switch to the outside air ventilation mode or open the windows to allow fresh air into the cab.
- During the cooling operation, mist may come out of the air outlets. This results from sudden cooling of humid air, and it does not indicate any problem.

### Dual Switch

By operating the switch (10), the "DUAL" symbol in the display area is turned on. While the "DUAL" symbol is illuminated, different temperatures can be set for the driver side and passenger side.

When the DUAL switch is operated again, the "DUAL" symbol turns off and the set temperature on the passenger side becomes the same as the driver side.

By operating the temperature control switch on the passenger side while the "DUAL" symbol is turned off, the "DUAL" symbol comes on, and the temperatures on the passenger side and the driver side can be individually set.

### Air Conditioning Switch (A/C Switch)

Operating the switch (2) turns on the air conditioner and the A/C symbol in the display area comes on.

The air conditioning system can also be used for dehumidifying while the heater is being used.

To turn off the air conditioner, operate the A/C switch. The indicator will go out and the air conditioning system will turn off.



#### NOTE

- When the outside air temperature drops close to 0 C (32 F), the air conditioner may turn off.

### Inside/outside Air Selector Switch

Operating the switch (3) switches between the inside air recirculation mode and outside air ventilation mode.

In the inside air recirculation mode, "" illuminates in the display area, and in the outside air ventilation mode, "" illuminates.

Inside air recirculation mode: Use this mode to prevent dusty or otherwise polluted outside air from entering the cab (such as in a tunnel or in congested traffic).

Outside air ventilation mode: Use this mode to ventilate the interior of the cab.

When driving in dusty gravel roads often and for prolonged periods, it is recommended to use "Outside air ventilation" mode to prevent dust from being drawn into the cabin. In severe dusty conditions, such as when there is a vehicle driving in front of you on a gravel road, it is recommended to change to "Inside air recirculation" mode for only short period until the vehicle in front you has moved on or passed.







#### NOTE

- Extended use of the inside air recirculation position can cause the windshield and windows to fog up easily, which leads to poor visibility.
- If the air in the vehicle stagnates due to using the air conditioner for a long time, switch to the outside air ventilation mode.

**Outlet Selector Switch**

Operating the switch (4) switches the outlet.

Displayed symbol	Air delivery	Outlet
	Face	Air flows through outlets 1, 2 and 6 (if equipped).
	Bi-level	Air flows through outlets 1, 2, 5 and 6 (if equipped).
	Feet	Air flows through outlet 5, and a miniscule amount flows through outlets 2, 3 and 4.
	Feet and defroster	Air flows through outlet 5, and slightly through outlets 2, 3 and 4.

**NOTE**

- When you set to the "☞" position, the air sent to the feet and legs is comparatively less than the air sent to the upper body.

**Air Conditioning Off Switch (OFF Switch)**

Press this switch to stop both the fan and air conditioning system.

The outlet, inside/outside air switching, and rear defogger do not turn off.

**Fan Speed Control Switch**

Airflow can be adjusted by operating the switch (6) up or down. Operating the switch upwards increases the airflow. Operating the switch downward decreases the airflow.

The fan speed can be adjusted through 7 levels.

When the OFF switch is pressed, the fan turns off.

Fan speed	Low	Medium	Maximum
Displayed symbol (example)			

**NOTE**

- Even in seasons when the air conditioning system is not used, occasionally operate the system for a few minutes with the engine running at a low speed in order to keep the system's components lubricated.

**Automatic Air Conditioning Switch (AUTO Switch)**

Pressing the switch (7) turns on the "AUTO" symbol and starts automatic control of the air conditioner.

**Windshield Defroster Switch**

Use this switch for defogging or defrosting the windshield.

Operating the switch (8) causes the "FRONT" symbol to illuminate. The air conditioner automatically turns on and the A/C symbol comes on. The inlet allows in outside air and the "↔" symbol comes on.

When the switch is operated again, the "FRONT" symbol turns off and the defroster stops.

Displayed symbol	Purpose	Outlet
	Defrosting	Air flows through outlets 2, 3 and 4..

**Rear Window Defogger Switch**

Use this switch for defogging or defrosting the rear window glass. With the power mode in "ON" (models with passive entry and start system) or the starter switch in the "ON" position (models without passive entry and start system), press the switch (9) to turn on the rear window defogger. The "REAR" symbol comes on.

When the switch is operated again, the "REAR" symbol turns off and the defogger stops.

**ADVICE**

- Do not use the rear window defogger while the engine is not running. The rear window defogger consumes a lot of electricity and could discharge the battery completely.
- Turn the switch off promptly after the rear window is defogged or defrosted.

**NOTE**

- Since the rear window defogger function consumes a lot of electricity, operation will automatically turn off after approximately 10 minutes of operation.
- In models with a mirror heater, press the rear window defogger switch to activate the mirror heater at the same time and defog the mirror surface.

## Defogging and Defrosting the Windshield

### Defogging

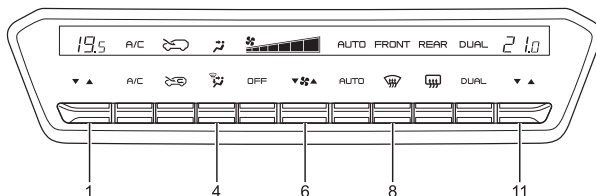

Operate the windshield defroster switch (8) to turn on the defroster. The display will show the "FRONT" symbol. The air conditioning system starts operating. The defroster is automatically set to the outside air ventilation mode.

Turn the temperature control switch (1) (11) to the preferred setting.

Turn the fan speed control switch (6) to the preferred setting. The efficiency of defogging will be lower when "↻" (inside air recirculation) is selected than when "↻" (outside air ventilation) is selected.

Press the switch (4) to select the preferred air outlets. If you press the switch so that the "↻" symbol appears on the display, the windshield can be defogged while warming your feet as well.



### NOTE

- Do not use the air conditioner at maximum cooling while the windshield defroster switch (8) is turned on. The outside surface of the windshield and windows will fog up, which leads to poor frontal visibility.
- To defog quickly, set the temperature to a high temperature position with a high fan speed.

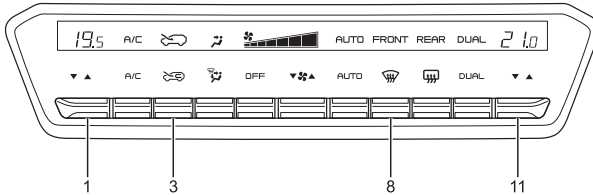
**Defrosting**

Operate the windshield defroster switch (8) and turn on the defroster. The display will show the "FRONT" symbol. The air conditioning system starts operating.

Turn the temperature control switch (1) (11) to the maximum temperature position (32 C (90 F)).

Operate the inside/outside air selector switch (3) to select the inside air recirculation mode. The "c" symbol illuminates.

**CAUTION**

- After defrosting, make sure to operate the inside/outside air selector switch (3) to switch to the outside air ventilation mode. Failure to do so will cause the windshield and windows to fog up, which leads to poor frontal visibility.

## Temperature Sensors

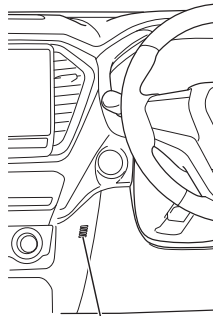
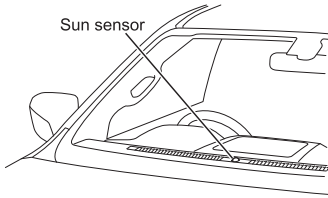

Interior temperature sensor

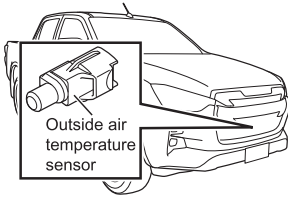

Outside air temperature sensor

The air conditioning system uses a sun sensor, interior temperature sensor and outside air temperature sensor to ensure effective and comfortable air conditioning. Do not place anything on the sensors or get them wet. Air conditioning control will become inaccurate.

## Manual Air Conditioner

Use the manual air conditioner only when the engine is running.



### ADVICE

- Do not use the manual air conditioner when the engine is not running. The manual air conditioner consume a lot of electricity and could discharge the battery completely.



### NOTE



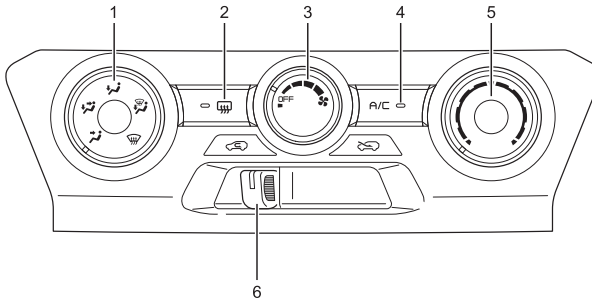

- If airflow drops or the air conditioner does not work well, the air conditioning filter may be clogged. In this case, consult the nearest Isuzu Dealer.

## How to Use the Controls



No.	Name	Function
1	Outlet selector dial	Switches the outlets.
2	Rear window defogger switch (if equipped)	Defogs the rear window.
3	Fan speed control dial	Adjusts the airflow.
4	Air conditioning switch (A/C switch) (if equipped)	Switches the air conditioner on and off.
5	Temperature control dial	Adjusts the temperature.
6	Air selector lever	Switches between inside air recirculation and outside air ventilation.

## 1. Outlet selector dial

Dial position	Air delivery	Outlet
	Face	Air flows through outlets 1, 2 and 6 (If equipped).
	Bi-level	Air flows through outlets 1, 2, 5 and 6 (If equipped).
	Feet	Air flows through outlet 5, 6 (if equipped), and a miniscule amount flows through outlets 2.
	Feet and defroster (models with defroster only)	Air flows through outlet 5, 6 (if equipped), and slightly through outlets 2, 3 and 4.
	Defroster (models with defroster only)	Air flows through outlets 3, 4, and a miniscule amount flows through outlets 2.

**NOTE**

- When you set to the " position, the air sent to the feet and legs is comparatively less than the air sent to the upper body.

## 2. Rear window defogger switch (if equipped)

Use this switch for defogging or defrosting the rear window glass. With the power mode in "ON" (models with passive entry and start system) or the starter switch in the "ON" position (models without passive entry and start system), press the rear window defogger switch to turn on the rear window defogger. The indicator light comes on. Press the switch again to turn it off. The indicator light will then go out.

**ADVICE**

- Do not use the rear window defogger while the engine is not running. The rear window defogger consumes a lot of electricity and could discharge the battery completely.
- Turn the switch off promptly after the rear window is defogged or defrosted.

**NOTE**

- Since the rear window defogger function consumes a lot of electricity, operation will automatically turn off after approximately 10 minutes of operation.
- In models with a mirror heater, press the rear window defogger switch to activate the mirror heater at the same time and defog the mirror surface.

## 3. Fan speed control dial

The fan speed can be adjusted to any of the 4 speeds that are available. To stop the air flow, return the fan speed control dial to the "OFF" position.

#### 4. Air conditioning switch (A/C switch) (if equipped)

Press the A/C switch to use the air conditioning system. The indicator light inside the switch will come on to show that the air conditioning system is in operation. The indicator light will go out when the air conditioning system is not operating. The air conditioning system can also be used for dehumidifying while the heater is being used.



#### NOTE

- Even if the A/C switch is turned on, the air conditioning system will not operate when the fan speed control dial is placed in the "OFF" position. Make sure that the fan speed control dial is in a position other than the "OFF" position.
- Even in seasons when the air conditioning system is not used, occasionally operate the system for a few minutes with the engine running at a low speed in order to keep the system's components lubricated.

#### 5. Temperature control dial

The interior temperature can be set as necessary.

The outlet temperature will be low when the temperature control dial is set to the leftmost position, and the outlet temperature will be high when the dial is set to the rightmost position.

#### 6. Air selector lever

Lever position	Purpose	
	Outside air ventilation	Use this position to ventilate the interior of the cab.
	Inside air recirculation	Use this position to prevent dusty or otherwise polluted outside air from entering the cab (such as in a tunnel or in congested traffic).

When driving in dusty gravel roads often and for prolonged periods, it is recommended to use "Outside air ventilation" mode to prevent dust from being drawn into the cabin. In severe dusty conditions, such as when there is a vehicle driving in front of you on a gravel road, it is recommended to change to "Inside air recirculation" mode for only short period until the vehicle in front you has moved on or passed.



#### NOTE

- Extended use of the inside air recirculation position can cause the windshield and windows to fog up easily, which leads to poor visibility.

## Ventilation

## Outside Air Ventilation

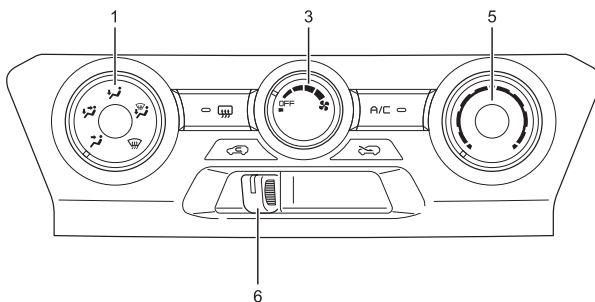

Turn the outlet selector dial (1) to the preferred position.

Move the air selector lever (6) to the "↔" position.

Set the temperature control dial (5) to the preferred position depending on the season and climate.

Adjust the fan speed control dial (3) to the preferred speed.

## How to Use the Heater

## Normal Heating

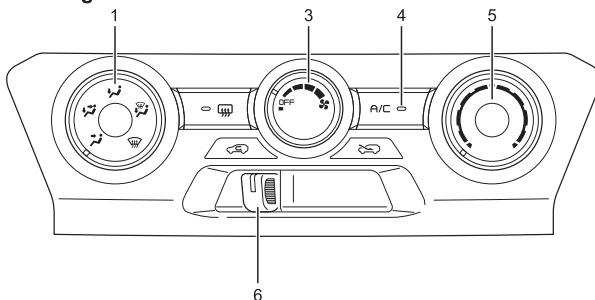

Set the outlet selector dial (1) to the "feet" or "windshield" position. Use the "windshield" position for warming your feet while defogging the windshield. Set the air selector lever (6) to the "feet" position.

Adjust the temperature control dial (5) and the fan speed control dial (3) to the preferred positions.

If your vehicle is equipped with an air conditioning system, to dehumidify the cab interior while heating, press the A/C switch (4) to turn it on.

**NOTE**

- Because the heater uses the heat from the engine coolant, its heating effect is weak when the engine coolant temperature is low.

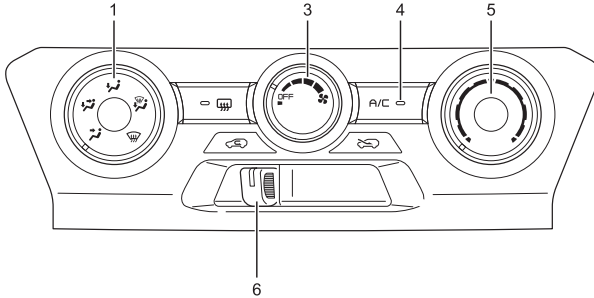
**Maximum Heating**

Turn the outlet selector dial (1) to the "FF" position, set the air selector lever (6) to the "FF" position, and turn the temperature control dial (5) fully towards the rightmost direction (high temperature direction).

Set the fan speed control dial (3) to the maximum speed position.

**NOTE**

- Extended use of the inside air recirculation position can cause the windshield and windows to fog up easily, which leads to poor visibility.

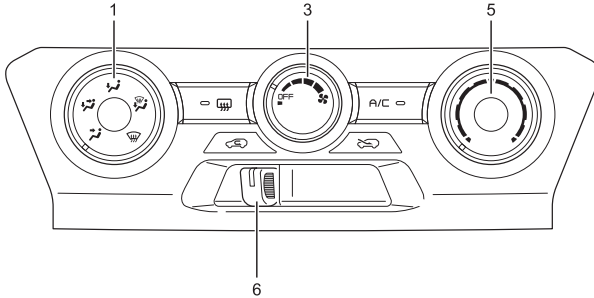
**Bi-level Heating**

- Set the outlet selector dial (1) to the "👤" position.  
Set the air selector lever (6) to the "👤" position.  
Set the temperature control dial (5) to the middle position.  
Adjust the fan speed control dial (3) as necessary.

**NOTE**

- When you set to the "👤" position, the air sent to the feet and legs is comparatively warmer than the air sent to the upper body.

## Defogging and Defrosting the Windshield

## Defogging

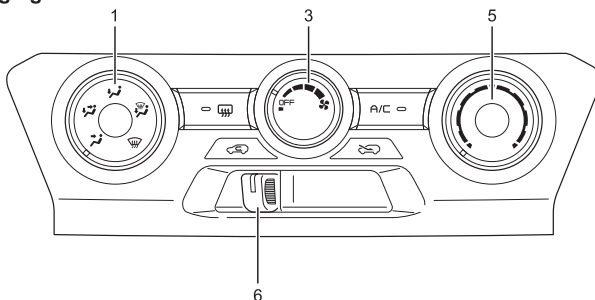

Set the outlet selector dial (1) to the "☂" position.

Set the air selector lever (6) to the "↔" position.

Turn the temperature control dial (5) to a right side position (high-temperature position) according to your preference. For defogging in the summer, set the temperature control dial (5) to any preferred position.

Adjust the fan speed control dial (3) as necessary.

If your vehicle is equipped with an air conditioning system, using the dehumidifying effect of the system is very effective for defogging.

**NOTE**

- Do not use the maximum cooling position when operating the air conditioning system with the outlet selector dial (1) set to the "☂" position. The outside surface of the windshield and windows will fog up, which leads to poor frontal visibility.

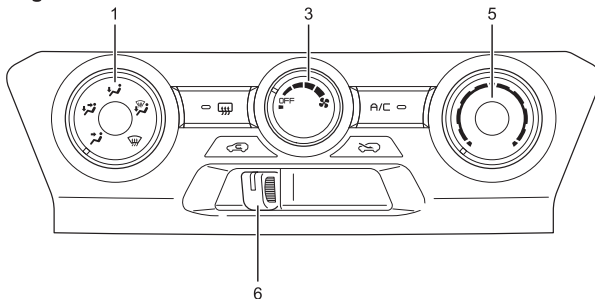
**Defrosting**

Set the outlet selector dial (1) to the "❄️" position.

Set the air selector lever (6) to the "🚗❄️" position.

Turn the temperature control dial (5) fully towards the rightmost direction (high-temperature direction).

Set the fan speed control dial (3) to the maximum speed position.

**NOTE**

- After defrosting, be certain to return the air selector lever (6) to the "🚗" position. Failure to do so will cause the windshield and windows to fog up, which leads to poor frontal visibility.

## Cooling

## Normal/Moderate Cooling

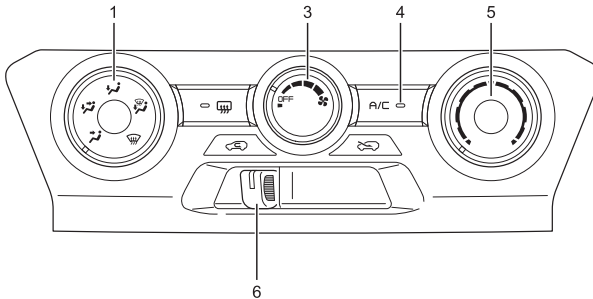

This setting is suitable for extended periods of cooling or moderate cooling.

Press the A/C switch (4) to turn it on.

Set the outlet selector dial (1) to the "↕" position for normal cooling (or set it to the "↙↘" position for moderate cooling).

Adjust the temperature control dial (5) to the preferred position depending on the season and climate.

Adjust the fan speed control dial (3) as necessary.

**NOTE**

- When using the air conditioning system with the engine idling in extremely hot weather, place the air selector lever (6) in the "↙↘" position.

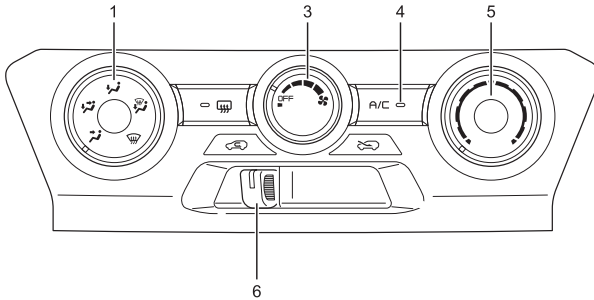
**Maximum Cooling**

Set the outlet selector dial (1) to the "↖↗" position.

Press the A/C switch (4) to turn it on.

Move the air selector lever (6) to the "↖" position.

Turn the temperature control dial (5) fully towards the leftmost direction (low-temperature direction).

Set the fan speed control dial (3) to the maximum speed position.

**NOTE**

- After prolonged parking in direct sunlight, open the windows or doors to ventilate the interior of the cab and release the heat before turning the air conditioning system on.
- Prolonged use of the air conditioning system in the maximum cooling setting will make the interior air become stale. Occasionally move the air selector lever (6) to the outside air introduction position or open the windows to allow fresh air into the cab.
- During the cooling operation, mist may come out of the air outlets. This results from sudden cooling of humid air, and it does not indicate any problem.

## Interior Lights

### Dome Light

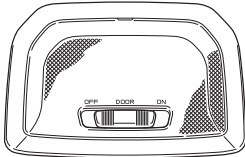

The dome light operates regardless of the power mode (models with passive entry and start system) or starter switch position (models without passive entry and start system).

**ON:**

The light stays on regardless of the doors being open or closed.



#### NOTE

- In models with a passive entry and start system or keyless entry system, the light will automatically turn off after approximately 20 minutes to prevent battery discharge when all doors are securely closed, the power mode is a mode other than "ON" (models with passive entry and start system) or the starter switch is in a position other than "ON" (models with keyless entry system), and the light switch is in the "ON" position.
- In models with passive entry and start system or keyless entry system, the light turns off in a different manner when the doors are locked depending on its switch position ("ON" or "DOOR").

**DOOR:**

The light turns on when a door is opened and turns off when the door is closed.

In addition, in models with passive entry and start system or keyless entry system, the light also turns on and off under the following conditions.

- When the power mode is switched to "OFF" (models with passive entry and start system) or the starter switch is turned to a position other than "ON" (models with keyless entry system) with a door open, closing the door will turn the light on for approximately 30 seconds, after which it will turn off automatically.
- When the power mode is switched to "ON" or "ACC" (models with passive entry and start system) or the starter switch is turned to the "ON" position (models with keyless entry system), opening and then closing a door will turn the light off.
- When the doors are closed, switching the power mode to "OFF" (models with passive entry and start system) or removing the key from the starter switch (models with keyless entry system) will turn the light on for approximately 30 seconds, after which it will then turn off automatically.
- When the doors are closed, switching the power mode to "ON" or "ACC" (models with passive entry and start system) or turning the starter switch to the "ON" position (models with keyless entry system) will turn off the light.

**OFF:**

The light stays off regardless of the doors being open or closed.

## Map Lights

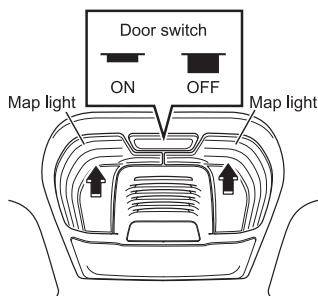

When the map light is pushed, the map light on the pushed side will come on. If it is pushed again, it will turn off.

The door switch function can be turned off or on by pressing the door switch.

When the door switch is "ON", they will come on in conjunction with opening/closing of the doors.

In addition, in models with a passive entry and start system or a keyless entry system, the light also turns on and off under the following conditions.

- When the power mode is switched to "OFF" (models with passive entry and start system) or the starter switch is turned to a position other than "ON" (models with keyless entry system) and a door is open, closing the door will turn the light on for approximately 30 seconds, after which it will turn off automatically.
- When the power mode is switched to "ON" or "ACC" (models with passive entry and start system) or the starter switch is turned to the "ON" position (models with keyless entry system), opening and then closing a door will turn the light off.
- When the doors are closed, switching the power mode to "OFF" (models with passive entry and start system) or removing the key from the starter switch (models with keyless entry system) will turn the light on for approximately 30 seconds, after which it will turn off automatically.
- When the doors are closed, switching the power mode to "ON" or "ACC" (models with passive entry and start system) or turning the starter switch to the "ON" position (models with keyless entry system) will turn off the light.

## Overhead Console

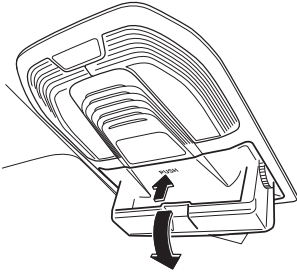

Use them for storing small articles. Press the indented portion of the overhead console to open it.

### WARNING

- For safety, close the overhead console lid during driving as there is a risk of injury from the open lid or from objects stored in the overhead console.
- Do not place heavy objects inside the overhead console. It is designed for storing light articles such as eyeglasses. The lid may open and objects may fall out, resulting in an accident.

### CAUTION

- Do not leave eyeglasses or lighters inside the cab. Lighters may explode and plastic lenses or frames may deform or crack if the interior temperature becomes very hot.

### Sun Visor

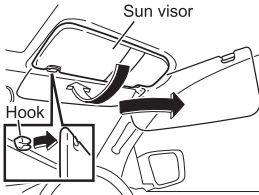

The sun visor protects your eyes in strong sunlight. Use it when sunlight is too bright. To reduce side glare, unhook the sun visor and swing it around to the side.



#### CAUTION

- For safety, make sure to fold up the sun visor after use.

### Ticket Holder

#### Driver's side

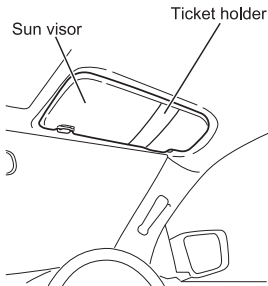

Use this to hold your tickets.

## Vanity Mirror

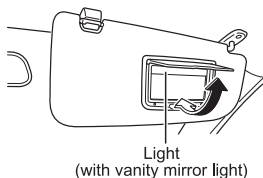

The vanity mirror is on the rear side of the front sun visor.

In models with the vanity mirror light, the light comes on when the cover of the vanity mirror is opened. It goes out when the cover is closed.

## Accessory Socket

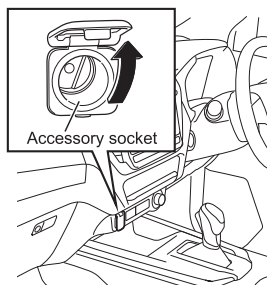

You can use this when the power mode is "ACC" or "ON" (models with passive entry and start system) or the starter switch is in the "ACC" or "ON" position (models without passive entry and start system).

Use it to supply power to commercially available vehicle accessories, etc. Open the cap to use. When using a commercially available electrical accessory, follow the instruction manual of the electrical accessory.

### WARNING

- The accessory socket has a maximum allowable load of 120 W (10 A). If you subject the socket to more than the allowable load, the wiring may overheat and cause a fire. Use the socket within the allowable load.
- The socket uses 12 V power. Connecting electrical accessories other than 12 V accessories could cause overheating and may result in a fire.
- Be sure to insert the plug of the electrical accessory all the way into the socket. Using an accessory when the plug is not completely inserted could cause abnormal heat generation and may result in the vehicle's fuses blowing.
- Do not insert the cigarette lighter into the socket. Doing so could generate heat.
- When not in use, be sure to attach the cap. If foreign matter enters the socket, or if water or drinks contact it, it could be damaged. Also, do not insert fingers or any metallic objects other than plugs into the socket.

**CAUTION**

- When using electrical accessories by plugging them into the accessory socket located at the lower part of center of instrument panel, make sure that they do not interfere with vehicle operation, such as when moving the gearshift lever/selector lever.

**ADVICE**

- When not in use, turn off electrical accessories.
- Using the socket for a long period of time while the engine is stopped will deplete the battery.
- As the internal part of the socket may become deformed depending on the size of the plug used, do not attempt to force the plug into the socket. In this case, replace the socket.
- When inserting or removing the plug of an electrical accessory, turn the electrical accessory off, or switch the power mode to "OFF" (models with passive entry and start system) or place the starter switch in the "LOCK" position (models without passive entry and start system).

## USB Power Outlet

### Rear part of center console box

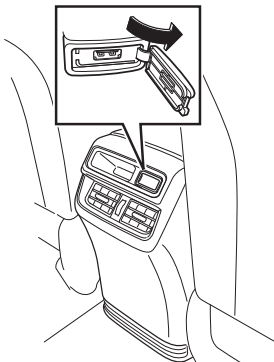

The USB power outlet can be used when the power mode is "ACC" or "ON" (models with passive entry and start system) or the starter switch is in the "ACC" or "ON" position (models without passive entry and start system).

The power outlet is to be used for operating or charging compatible mobile devices or electronics. Refer to the owner's manuals of those products before using. Open the cap to use. Close the cap when not in use.



### CAUTION

- Make sure that the connected USB cables, mobile devices, and electronics do not interfere with vehicle operation.



### ADVICE

- A-Type USB terminals can be used with the power outlet. Do not attempt to insert other types of USB terminals.
- The maximum rating for power outlet is 5.0 V/2.1 A. Before using, check that the equipment to be used is compatible by referring to its owner's manual, etc.
- It can only be used as a power output and not for transmitting data (including video and music data).
- After charging is complete, promptly disconnect all mobile devices and electronics.
- Do not connect USB hubs. Doing so could result in damage.
- Do not spill liquids on the power outlet, nor attempt to insert metals or other foreign objects. Doing so may result in an electric shock or damage.
- When using for extended periods with the engine stopped, take care as the battery may go flat.
- Do not connect damaged equipment or products.
- Damage to connected equipment or products, as well as any damage of or loss of data are not covered by warranty.
- When using USB cables, make sure that your legs do not get caught by the cables.

**Small Article Storage Pocket**

Use them for storing small articles.

**CAUTION**

- Do not leave eyeglasses or lighters inside the cab. Lighters may explode and plastic lenses or frames may deform or crack if the interior temperature becomes very hot.
- Do not place lidless containers such as paper cups containing drinks in the center console small article storage pocket. Liquid in the container could be spilled inside the vehicle.

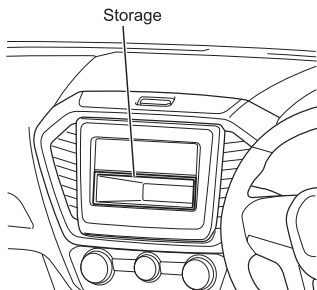
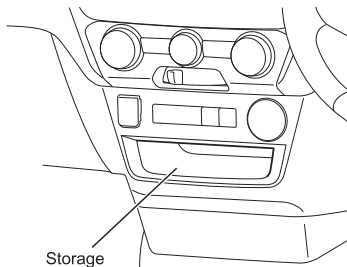
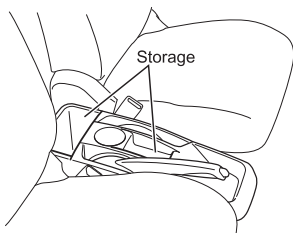
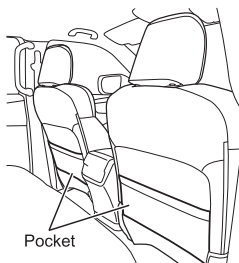
**Center of instrument panel****Lower part of center of instrument panel****Front center****Front seatback**

## Rear part of center console

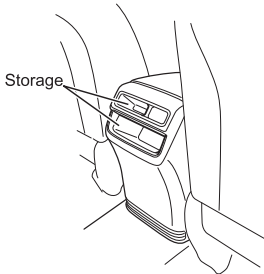

## Side access panel (Extended cab model)

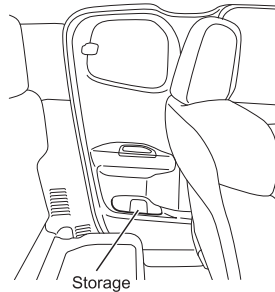

## Small Article Storage Pocket (Passenger's Side)

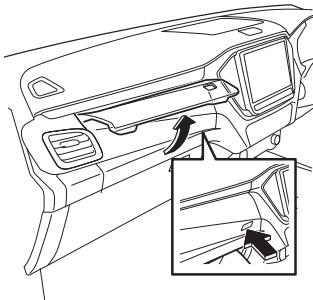

Press the button to open the lid.

 **CAUTION**

- For safety, close the small article storage pocket (passenger's side) during driving. There is a risk of injury from the open lid or items stored in the small article storage pocket (passenger's side).
- Do not leave eyeglasses or lighters inside the cab. Lighters may explode and plastic lenses or frames may deform or crack if the interior temperature becomes very hot.

**ADVICE**

- Do not place an object in the small article storage pocket (passenger's side) that is so large that the lid of the compartment cannot be closed. If you attempt to close the lid in this condition, you are likely to break the lid of the small article storage pocket (passenger's side).

## Glove Compartment

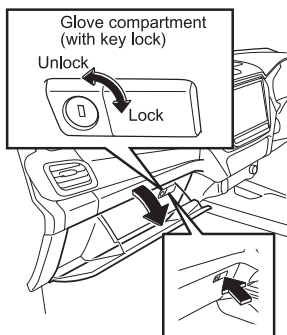

Press the button to open it.

Insert the key into the glove compartment key lock equipped with key lock and turn counterclockwise to unlock or clockwise to lock.



### CAUTION

- For safety, close the glove compartment during driving. There is a risk of injury from the open lid or items stored in the glove compartment.
- Do not leave eyeglasses or lighters inside the cab. Lighters may explode and plastic lenses or frames may deform or crack if the interior temperature becomes very hot.



### ADVICE

- Do not place an object in the glove compartment that is so large that the lid of the compartment cannot be closed. If you attempt to close the lid in this condition, you are likely to break the lid of the glove compartment.

### Dashboard Tray

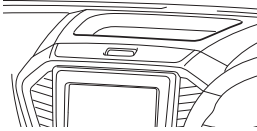

Use it for storing small articles.

#### CAUTION

- Do not leave eyeglasses or lighters inside the cab. Lighters may explode and plastic lenses or frames may deform or crack if the interior temperature becomes very hot.

### Small Article Storage Pocket (Upper Side of Dashboard)

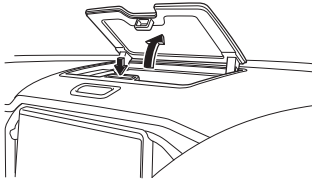

Press the button to open the lid.

#### CAUTION

- For safety, close the small article storage pocket (upper side of dashboard) during driving. There is a risk of injury from the open lid or items stored in the small article storage pocket (upper side of dashboard).
- Do not leave eyeglasses or lighters inside the cab. Lighters may explode and plastic lenses or frames may deform or crack if the interior temperature becomes very hot.



#### ADVICE

- Do not place an object in the small article storage pocket (upper side of dashboard) that is so large that the lid of the compartment cannot be closed. If you attempt to close the lid in this condition, you are likely to break the lid of the small article storage pocket (upper side of dashboard).

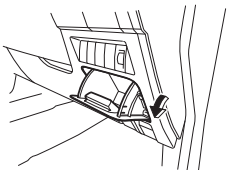
**Small Article Storage Pocket (Driver's Side)**

Pull towards you to open.

 **CAUTION**

- For safety, close the small article storage pocket (driver's side) during driving. There is a risk of injury from the open lid or items stored in the small article storage pocket (driver's side).
- Do not leave eyeglasses or lighters inside the cab. Lighters may explode and plastic lenses or frames may deform or crack if the interior temperature becomes very hot.

**ADVICE**

- Do not place an object in the small article storage pocket (driver's side) that is so large that the lid of the compartment cannot be closed. If you attempt to close the lid in this condition, you are likely to break the lid of the small article storage pocket (driver's side).

**Center Console Box**

Pull the knob to open the lid.

**WARNING**

- For safety, close the center console box while driving. There is a risk of injury from the open lid or items stored in the center console box. In addition, in models with far side airbag, if the open lid is within the area in which the far side airbag inflates, the far side airbag will not function correctly.

**CAUTION**

- Do not leave eyeglasses or lighters inside the cab. Lighters may explode and plastic lenses or frames may deform or crack if the interior temperature becomes very hot.

**ADVICE**

- Do not place an object in the center console box that is so large that the lid of the compartment cannot be closed. If you attempt to close the lid in this condition, you are likely to break the lid of the center console box.

## Cup Holder

 CAUTION

- Do not place objects in the cup holder if they have an improper size or shape. Sudden braking or pulling away could cause the object to fly out of the cup holder, leading to an injury.
- Do not place a cup that is too full in the cup holder. Spillages could cause damage to the other electrical circuits. If there is a spill, wipe it up immediately with a dry cloth.

## Front Side

## Type 1

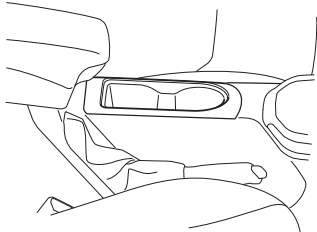

This can be used as a cup holder.

 CAUTION

- Placing a water bottle in the cup holder could interfere with driving, leading to an accident.

## Type 2

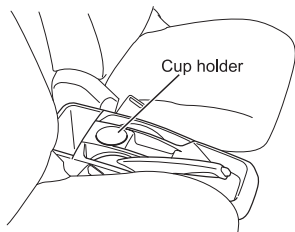

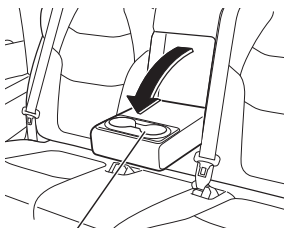
**Second Seat Armrest**

Cup holder

Pull the armrest out from the seatback, then push it forward to use.

**Cup Holder and Small Article Storage Pocket****⚠ WARNING**

- Do not use the small article storage pocket as an ashtray or place any ashtrays inside. Doing so is dangerous and could lead to a fire in the vehicle.

**⚠ CAUTION**

- Do not place objects in the cup holder if they have an improper size or shape. Sudden braking or pulling away could cause the object to fly out of the cup holder, leading to an injury.
- Placing a water bottle could obscure the driver's view and interfere with driving, and this could lead to an accident.
- Do not place a cup that is too full in the cup holder. Spillages could cause damage to the radio and other electrical circuits. If there is a spill, wipe it up immediately with a dry cloth.
- There may be a danger of the cup holder and small article storage pocket breaking if the weight on it exceeds 0.75 kg (26 oz).

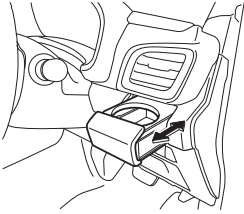
**Driver's side**

1. Push the cup holder to open.

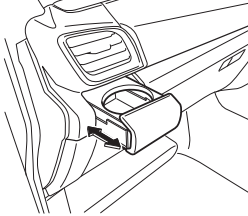
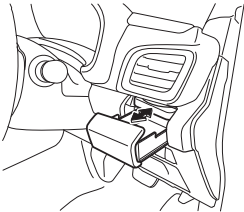
**Passenger's side****Driver's side**

2. If only the cup holder is returned to its original position it can be used as the small article storage pocket.

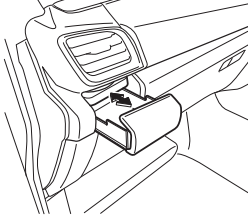
**Passenger's side**

### Bottle Holder and Small Article Storage Pocket (Front and Rear Doors)

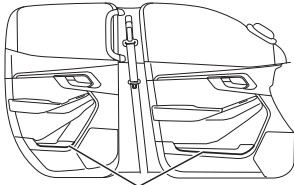

Bottle holder and small article storage pocket

Use as a bottle holder and small article storage pocket.



#### CAUTION

- Do not place lidless containers such as paper cups containing drinks in the bottle holder and small article storage pocket. Liquid in the container could be spilled inside the vehicle.

## Grip

 **WARNING**

- In models with curtain airbag, if hard objects such as hangers or accessories are attached to the grip or coat hook, they may prevent normal operation of the curtain airbag and could fly off in the event of system activation.

**Front Seat**

There are grips near the top of the windows.

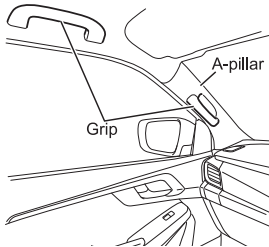
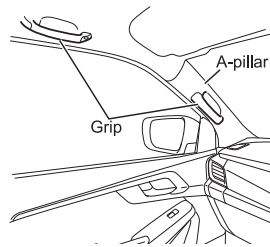
**Folding type****Fixed type****Second Seat (Crew Cab Model)**

There are grips above and in front of the rear door windows.

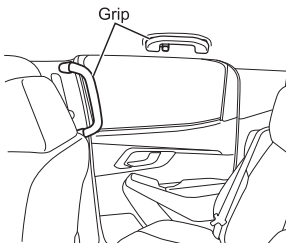

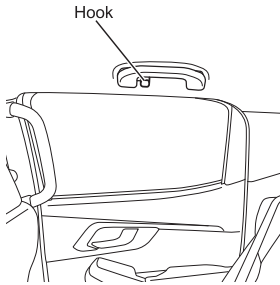
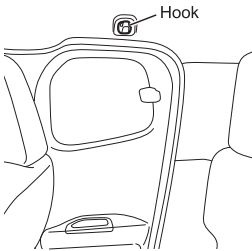
**Coat Hook****Crew cab model****Extended cab model**

Use this to hang clothing.

**WARNING**

- To prevent hook cracking or breakage, do not hang heavy or large objects in the coat hook.
- In models with curtain airbag, if hard objects such as hangers or accessories are attached to the grip or coat hook, they may prevent normal operation of the curtain airbag and could fly off in the event of system activation.

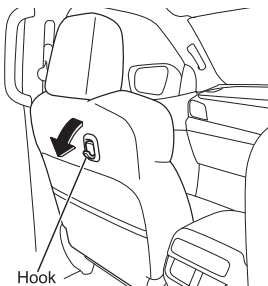
**Hook**

This can be used to hold plastic shopping bags.

**CAUTION**

- Do not hang anything weighing over 4 kg (141 oz) or that may fall off the hook while driving. Doing so may be dangerous.

## Antenna

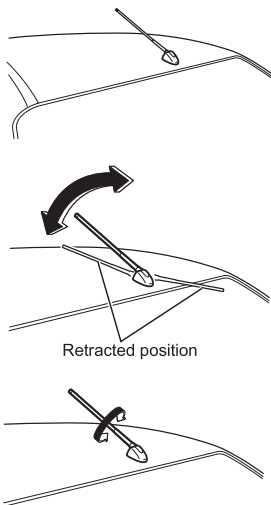

When receiving radio signals, adjust the angle of the antenna as appropriate. Turn the antenna rod counterclockwise to remove it.



### ADVICE

- To prevent breaking the antenna when in an automatic car wash, remove the antenna. When the antenna has been removed in order to wash the vehicle, be careful not to misplace the antenna and be sure to reinstall it before driving the vehicle again.
- To prevent breaking the antenna, retract it when passing through areas with low clearance or when attaching a vehicle cover.



### NOTE

- Radio reception may be affected by accessories or roof racks, etc., placed near the antenna.

## Steering Wheel Remote Control

You can use the steering wheel remote control to perform various audio operations. The operations differ depending on the type of audio system that you use.



### CAUTION

- While driving, be sure that audio control operations do not interfere with your driving.

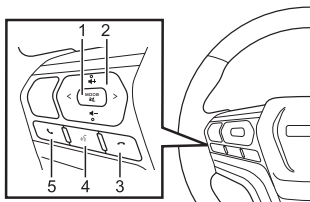

No.	Description
1	[MODE], [⊞] buttons
2	[⏪], [⏩], [<], [>] buttons
3	[↶] button
4	[⏸] button
5	[↷] button

## Rear Vision Camera

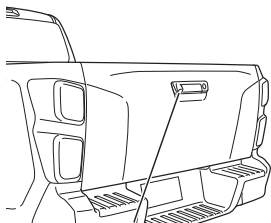

Rear vision camera

The rear vision camera is installed to the tailgate.



### CAUTION

- Do not look only at the screen when driving the vehicle in reverse. Always inspect your surroundings by looking at them directly, and slowly move the vehicle.



### ADVICE

- If the front cover of the lens is dirty, video will not be clear. If raindrops, snow, or dirt gets on the front cover of the lens, wipe it off with a soft cloth moistened with water. If you use a dry cloth to wipe the cover of the lens, it may be damaged.
- Do not subject the camera to strong shocks. It may break or become damaged, and a fire or electrocution may occur.
- Do not subject the camera to strong shocks from a high-pressure water stream, such as from a car wash. It may become damaged.
- Do not loosen the rear vision camera screws or disassemble the rear vision camera. The splash-proofing may be affected, and the camera may be damaged.



### NOTE

- Raindrops may get on the camera area and obscure video.
- The rear vision camera uses a wide-angle lens, so objects in the screen may appear closer or farther than they appear.
- Video from the rear vision camera may be difficult to see or impossible to see in dark places or at night.
- The lens features a splash-proof construction to prevent fogging.
- Do not damage the camera area. Video from the camera may be affected.

# SERVICE AND MAINTENANCE

# 6

**BEFORE SERVICE AND MAINTENANCE**

**6-3**

**DAILY CHECKS**

**6-15**

**ENGINE-RELATED SERVICE AND  
MAINTENANCE**

**6-19**

**CHASSIS-RELATED SERVICE AND  
MAINTENANCE**

**6-55**

**OTHER SERVICE AND MAINTENANCE**

**6-93**

**INTERIOR AND EXTERIOR  
MAINTENANCE**

**6-125**

**MAINTENANCE DATA**

**6-135**



**BEFORE SERVICE AND MAINTENANCE**

• Precautions for Checking and Adjustments	6-4
• Discarded Parts, Oils and Other Liquids	6-7
• Isuzu Genuine Oils and Grease	6-7
• Tools	6-8
• Engine Hood	6-11

### Precautions for Checking and Adjustments

Your Isuzu Dealer has factory trained technicians and Isuzu genuine parts to service your vehicle properly. For expert advice and quality service, see your Isuzu Dealer.



#### WARNING

- To help avoid personal injury, take care when doing any maintenance or making any check or repair. Follow the manufacturer's instructions for all materials used during service and maintenance of this vehicle. If used or handled improperly, they may be hazardous. Improper or incomplete service can also affect the vehicle and result in personal injury, or damage to the vehicle or its equipment. If you have any questions about carrying out some service, contact an Isuzu Dealer.
- Before performing any checks, in models with passive entry and start system, make sure to turn off the engine and switch the power mode to "OFF". In models without passive entry and start system, make sure to turn off the engine and remove the key from the starter switch.
- Pull firmly on the parking brake lever and put the transmission in neutral.
  - If your vehicle is equipped with a manual transmission, make sure the gearshift lever is in "N" position.
  - If your vehicle is equipped with an automatic transmission, place the selector lever in "P" position and make sure the shift indicator displays "P".
- Select a place with a solid and level surface to perform the checking and maintenance work. Make sure to chock the wheels. It would be very dangerous if the vehicle started to move.
- To prevent personal injury, keep hands, tools and clothing clear of the engine cooling fan when the engine is running.
- When raising the vehicle, use a suitable jack, not the one provided on the vehicle.
- After raising the vehicle and before going underneath to perform work, make sure the vehicle is supported with jack stands.
- When performing work on the electrical system, begin by switching the power mode to "OFF" (models with passive entry and start system) or turning the starter switch to the "LOCK" position (models without passive entry and start system), wait at least 3 minutes, and then disconnect the negative cable from the negative terminal on battery. If the negative cable is disconnected within 3 minutes, the electronic control system of the vehicle may malfunction.

WARNING (Continued)

**WARNING (Continued)**

- The engine, muffler, exhaust pipe, radiator and power steering fluid reserve tank will be hot immediately after the vehicle is driven. In addition, the oil and fluids will also be hot. Be careful around these parts to prevent burns. Perform all checks when the engine is cold.
- Do not perform work near an open flame or other heat sources.
- When working on the fuel line or fuel filter, remove the fuel tank filler cap. The fuel system is under pressure and the fuel will overspill unless the pressure is relieved, possibly leading to combustion or a fire.
- Do not let the engine run in poorly ventilated garages or sheds. This could cause carbon monoxide poisoning, resulting in death.
- Hands, tools, or clothing could become entangled in the belts while the engine is in operation. Do not allow them to come close to the engine (remove wristwatches, neckties, rings, etc.).
- Fuel and batteries generate flammable gas that could explode. Do not use fire and avoid creating sparks.
- Protect your eyes with protective goggles from oil, fluids, and falling objects.
- Use only Isuzu genuine parts for replacement parts.
- Do not leave tools used for inspection, removed parts, cloths used for cleaning, etc. in the engine compartment. They could cause a malfunction if caught in the moving components, such as belts, or they could cause a fire if they touch components that become very hot.

**CAUTION**

- Discarded parts, oil, grease and fluids could have an adverse effect on the environment. It is difficult to dispose of these, so have your Isuzu Dealer handle all checks and replacements.
- Oils, brake fluid, battery fluid and engine coolant have lubrication, cooling and rust prevention functions. If these liquids deteriorate through loss or contamination, it will cause a decline in the performance of the parts and such problems as seizure or malfunctioning. Replenish or change these liquids when performing the checks (daily and periodic checks) as required by the relevant regulations or in accordance with the Maintenance Schedule (when either the specified driving distance or period of time, whichever comes first, has expired).

**ADVICE**

- Use only appropriate tools.
- Confirm that all systems and components are normal after performing the work.
- Dirty water, dirt and other impurities seriously impair the effectiveness of the oil, grease and fluids, and damage the parts. Exercise all due caution to prevent waste or other refuse from coming in contact with parts or materials that have been removed when changing or replenishing them.

## Discarded Parts, Oils and Other Liquids

When changing oils, filters, engine coolant or other liquids, be sure to have a container ready in advance for their disposal.

Use methods conforming to legal requirements for discarding or disposing of parts, oils, filters or engine coolant after change or replacement.

## Isuzu Genuine Oils and Grease

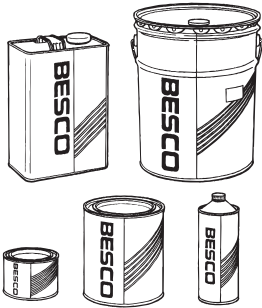

Periodically replenishing and changing the oil and grease is extremely important for maintaining your vehicle's performance and preventing malfunctions.

Isuzu Motors guarantees the quality and performance of the Isuzu genuine oils and grease. We recommend the use of Isuzu genuine oils and grease for maintenance and service of your vehicle.



### CAUTION

- Flames or other heat sources near spilled oil can cause a fire. Make sure to clean up all oil spills.

## Tools



## ADVICE

- It is recommended that you familiarize yourself with the contents and use of the various tools and the jack before using them.
- After finishing work with the tools, return them to the correct storage location and ensure that they will not move while the vehicle will be in motion.
- Store the jack in its original position and turn the jack socket clockwise so that it is secured (as a guide, with a force of **0.5 N·m** (0.05 kgf m/**0.36 lb·ft**)).

## Storage Location

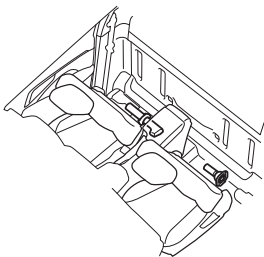
**Regular Cab Model**

The tools are positioned behind the right side seat, the jack is positioned behind the left side seat. Tilt the seatbacks forward to take out the jack and tools. To remove the jack, turn the jack socket counterclockwise so that the ram is lowered away from the holder. Remove the jack when the ram is fully lowered.

**Adjusting the Driver Seat**

→ Refer to page 3-55

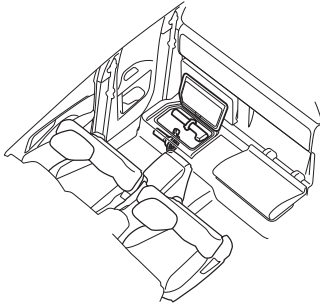

### Extended Cab Model

The jack and tools are positioned in the storage compartment behind the right front seat. Open the cover to take out the jack and tools. To remove the jack, turn the jack socket counterclockwise so that the ram is lowered away from the holder. Remove the jack when the ram is fully lowered.

### Second Seat (Extended Cab Model)

→ Refer to page 3-60



### CAUTION

- Be careful because the storage compartment becomes very hot under the following conditions.
  - Immediately after driving
  - When the engine is running, even though the vehicle is not being driven, or immediately after the engine has been stopped.

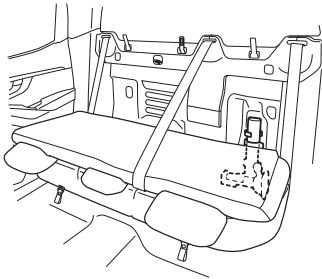

### Crew Cab Model

The jack and tools are positioned behind the rear left seat. Tilt the seatbacks forward to take out the jack and tools.

To remove the jack, turn the jack socket counterclockwise so that the ram is lowered away from the holder. Remove the jack when the ram is fully lowered.

### Folding the Seatback

→ Refer to page 3-58

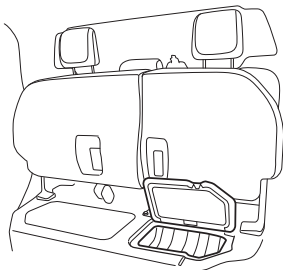

The storage compartment is under the rear seat.

### ⚠ CAUTION

- Be careful because the storage compartment becomes very hot under the following conditions.
  - Immediately after driving
  - When the engine is running, even though the vehicle is not being driven, or immediately after the engine has been stopped.

## Tools Carried in Your Vehicle

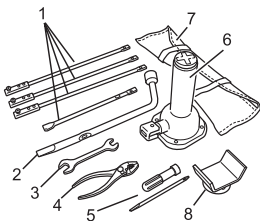

No.	Tool name
1	Jack bar/Spare tire removal bar
2	Wheel nut wrench (Jack handle)
3	Spanner
4	Pliers
5	Screwdriver (with switchable Phillips and flat heads)
6	Jack
7	Tool bag
8	Jack adaptor

### 🧑 ADVICE

- Be sure to carry all of the provided tools in the vehicle.

## Engine Hood



### WARNING

- Keep your hands and clothing away from the moving fan and engine drive belts when the engine is running.
- Upon inserting the support rod into the hood slot, make sure that the rod supports the hood securely to prevent injuries due to unexpected and sudden closing of the hood.
- Do not open the engine hood when steam is coming out of the engine compartment.



### ADVICE

- Do not open the engine hood with the wiper arms standing. The wiper arms and engine hood may be damaged.

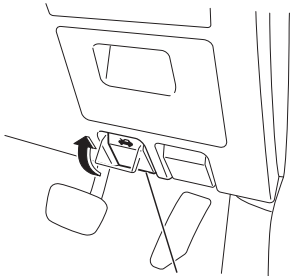

Engine hood release lever

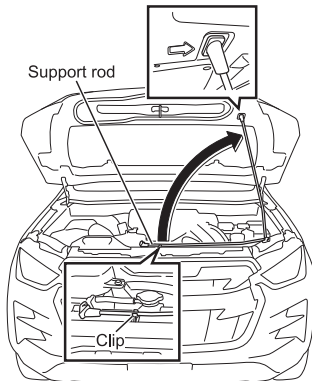
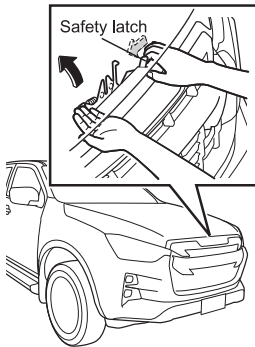
**To Open**

1. Pull the engine hood release lever.  
The lock is released, and the front edge of the engine hood will rise.
2. Insert a hand with its palm facing down into the space under the front edge of the engine hood, push the safety latch leftward to release the lock, and open the engine hood.
3. Remove the support rod from the clip, and then install the support rod edge hook into the groove of the engine hood.

**To Close** **WARNING**

- The engine hood is very heavy. When you close the engine hood, be careful not to trap your hands or anything else.

 **ADVICE**

- Do not drop the engine hood from a height of over 60 cm (23.6 in). The engine hood and radiator grille may be damaged by the impact.
- When closing the engine hood, do not press it strongly, such as by putting your weight on it. Doing so may bend the engine hood.

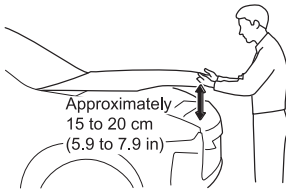

1. Remove the support rod from the groove of the engine hood and install it into the clip.
2. Lower the engine hood slowly, and release your hands at a height of approximately 15 to 20 cm (5.9 to 7.9 in).
3. Gently push and pull the edge of the engine hood to make sure that it has been securely locked in place.

 **WARNING**

- Do not drive unless the engine hood is complete closed. Driving with the engine hood open could lead to an accident. Before driving, confirm that the engine hood is securely locked.



DAILY CHECKS

---

• Daily Checks (Preoperational Checks)	6-16
• Checking Components that Showed Abnormalities during Previous Operation	6-18

---

### Daily Checks (Preoperational Checks)

Check your vehicle for the items listed below before starting the day's operation to ensure safe, trouble-free operation. Also, make note of the distance the vehicle has covered and the conditions under which the vehicle has been operated to be able to determine the inspection intervals most appropriate for your specific vehicle and adequately service it according to inspection results.

If the checks reveal an abnormality or if there are components that showed abnormalities during the previous operation, have the vehicle repaired by your Isuzu Dealer before using the vehicle.

### Daily Check (Preoperational Check) Items

#### [1. Checking components that showed abnormalities during the previous operation]

Check item	Reference page
Checking components that showed abnormalities during the previous operation	6-18

#### [2. Checks performed with the engine hood opened]

Check item	Reference page
Fan belt looseness and damage	6-46
Engine oil level	6-22
Engine coolant level and radiator cap looseness	6-42
Power steering fluid level (Hydraulic power steering models)	6-91
Brake fluid level (For a manual transmission model, brake fluid doubles as clutch fluid.)	6-57, 6-89
Windshield washer fluid level	6-94
Battery fluid level	6-122

**[3. Checks performed in the driver's seat]**

Check item	Reference page
Brake pedal free play	6-58
Operation of meters, gauges and warning/indicator lights	4-14, 4-21
Engine startability, abnormal noise and color of exhaust gases	6-20
Parking brake lever stroke	6-61
Windshield washer fluid spray condition and windshield wiper effectiveness	6-94, 6-95
Rearview mirror condition	3-64
Steering wheel free play and mounting condition	3-63, 6-90
Operation of horn and turn signal lights	4-137, 4-124
Fuel level	4-19
Operation of door locks	3-26

**[4. Checks performed during a walk around the vehicle]**

Check item	Reference page
Illumination, flashing or for stained or damaged lights	6-102
Suspension springs damage	
Leakage of oil, engine coolant, fuel, brake fluid, and power steering fluid	

**[5. Checking wheels and tires]**

Check item	Reference page
Air pressure	6-62
Cracks and other damage	6-64
Abnormal wear	6-64
Tread depth	6-64
Disc wheel mounting condition	6-65

**[6. Checks performed while driving the vehicle]**

Check item	Reference page
Brake effectiveness	6-60
Driving condition at low speeds and during acceleration	6-21

### Checking Components that Showed Abnormalities during Previous Operation

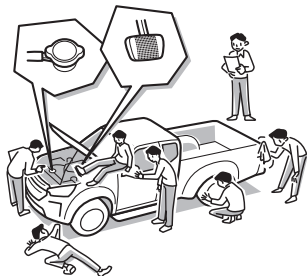

Check the components that showed abnormalities during the previous operation. Have any abnormalities repaired by your Isuzu Dealer before using the vehicle.

**ENGINE-RELATED SERVICE AND  
MAINTENANCE**

• Engine Conditions	6-20
• Engine Oil	6-22
• Engine Coolant	6-39
• Handling the Radiator and Intercooler	6-44
• Fan Belt/Air Conditioning Compressor Belt/Accessory Belt	6-46
• Air Cleaner	6-49
• Fuel Filter	6-51

## Engine Conditions

### Checking the Engine for Startability and Abnormal Conditions

1. Make sure the parking brake is securely engaged. Depress the brake pedal firmly.
2. If your vehicle is a manual transmission model, check that the gearshift lever is in the "N" position, and fully depress the clutch pedal.  
In an automatic transmission model, check that the selector lever is in the "P" position, and firmly depress the brake pedal.



#### CAUTION

- If your vehicle is equipped with the automatic transmission, the engine will not start unless the transmission is actually in "P" or "N" position.
- For safety, firmly depress the brake pedal before starting the engine.

3. Push the engine start/stop button (models with passive entry and start system) or turn the starter switch (models without passive entry and start system) to start the engine.  
Check that the engine starts quickly without any abnormal conditions (abnormal noises, vibration, etc.). If there are any abnormalities, stop the engine and contact your nearest Isuzu Dealer.

#### Starting the Engine

→ Refer to page 4-4

### Checking Condition of the Engine at Low Speeds and during Acceleration



1. Make sure that the parking brake lever is fully pulled.  
If your vehicle is a manual transmission model, make sure that the gearshift lever is in the "N" position and then depress the clutch pedal and brake pedal fully.  
In an automatic transmission model, make sure that the selector lever is in the "P" position and then depress the brake pedal fully.
2. Push the engine start/stop button (models with passive entry and start system) or turn the starter switch (models without passive entry and start system) to start the engine, and run it to warm up.

#### Starting the Engine

→ Refer to page 4-4

3. Check that the engine is running at a speed within the standard idle speed range.
4. Drive the vehicle, making sure the accelerator pedal does not stick when gradually accelerating, the engine speed rises smoothly and it does not knock. If there are any abnormalities (accelerator pedal sticking, rough engine acceleration, knocking, etc.), stop your vehicle at a safe place, stop the engine, and contact your nearest Isuzu Dealer.

## Engine Oil

Engine oil is an important factor in determining engine performance and longevity. Be sure to use only specified oil and oil filter. The engine oil level must be checked and the oil and oil filter should be regularly changed at the same time according to the Maintenance Schedule.

### Maintenance Schedule

→ Refer to page 6-136

### Recommended Fluids, Lubricants and

Diesel Fuels → Refer to page 6-137

## Checking the Engine Oil Level

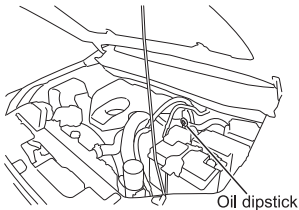

Perform the engine oil level check on a flat surface while the engine is cold before starting it. If the engine has already been started, stop it after it has sufficiently warmed and wait 30 minutes or more before performing.

Also, check if there are any oil leaks and the dirt level of the engine oil.

### 4JJ3 Engine Model

1. Remove the oil dipstick and wipe off any oil on the oil dipstick.
2. Reinsert the oil dipstick fully and then gently remove it.

If the oil surface is between the "MAX" and "MIN" marks (range 1), the oil is at the correct level.

3. If the oil surface is close to the "MIN" mark, add oil.
4. Install the oil dipstick into position after checking the oil level.

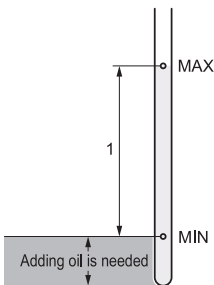

### ADVICE

- Adding too much oil could result in faulty engine operation. Be sure to check the oil level using the oil dipstick.

**RZ4E Engine Model**

1. Remove the oil dipstick and wipe off any oil on the oil dipstick.
2. Reinsert the oil dipstick fully and then gently remove it. Check the front and back of the oil dipstick. If the lowest position is between the "MAX" and "MIN" marks (range 1), the oil is at the correct level.
3. If the lowest position is close to the "MIN" mark, add oil.
4. Install the oil dipstick into position after checking the oil level.

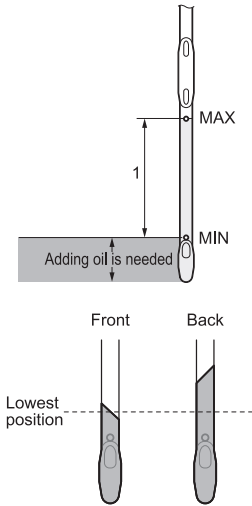
**ADVICE**

- Adding too much oil could result in faulty engine operation. Be sure to check the oil level using the oil dipstick.

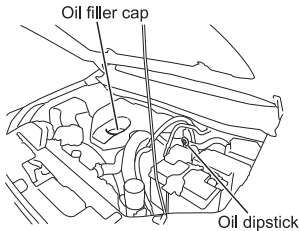
**Adding the Engine Oil**

When the engine oil level is near the "MIN" mark on the oil dipstick, remove the oil filler cap and add the oil. Use only the specified engine oil.

**WARNING**

- When adding oil, be careful not to spill any, but keep a workshop rag handy just in case there are any spills. If any oil should spill onto the engine, carefully wipe it away. If this precaution is not taken, the spilled oil could ignite and a fire could spread.
- Do not leave flammable items, such as rags or gloves, in the engine compartment. They could cause a fire.
- The engine oil and the area surrounding the engine are hot immediately after engine operation, so be careful of burns.

**ADVICE**

- Engine oil lubricates and cools the engine's internal components. The quality of the oil is degraded and the quantity of oil is reduced by evaporation, discharge and combustion during the engine's operation. Continually using the same oil without checking the level, or without replenishing and changing it could cause seizure or damage to the engine. Add or change the oil when the quality of the oil has been degraded or the quantity is reduced, even if this occurs before expiration of the specified intervals in the Maintenance Schedule, which will differ depending on the conditions of use.
- Prevent dirt from entering the oil filler when filling with oil. If foreign matter mixes with the oil, it could damage the engine.
- Adding oil above the "MAX" mark on the oil dipstick could result in faulty engine operation. Be sure to check the oil level by using the oil dipstick.

## Changing the Engine Oil and Oil Filter

Engine oil and the oil filter are important factors in determining engine performance and longevity. Be sure to use only specified oil and oil filter. The engine oil level must be checked and the oil and oil filter should be regularly changed at the same time according to the Maintenance Schedule.



### WARNING

- Hot engine oil can cause severe skin burns. Allow the engine to cool before draining the engine oil.



### ADVICE

- Use the oil quantities indicated below only as guidelines when changing the engine oil. After changing the oil, make sure the oil is at the required level.

### Quantity of engine oil to be changed

Engine model	Oil quantity [Reference value]
	When changing oil and filter
4JJ3 (2WD)	<b>7.0 liters</b> (1.85 US gal./ <b>1.54 Imp gal.</b> )
4JJ3 (4WD)	<b>7.5 liters</b> (1.98 US gal./ <b>1.65 Imp gal.</b> )
RZ4E (2WD/4WD)	<b>6.6 liters</b> (1.74 US gal./ <b>1.45 Imp gal.</b> )

### Maintenance Schedule

→ Refer to page 6-136

### Recommended Fluids, Lubricants and

Diesel Fuels → Refer to page 6-137

### Changing the Engine Oil and Oil Filter (4JJ3 Engine Model)

Change the engine oil and oil filter on a flat surface while the engine is cold before starting it. If the engine has already been started, stop it after it has sufficiently warmed, wait 30 minutes or more, and perform after confirming that the oil has sufficiently cooled.

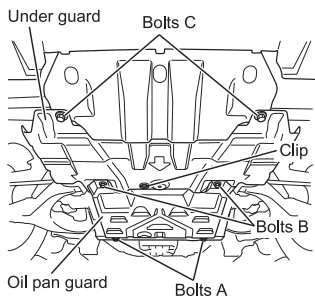

1. In models with an oil pan guard, remove the oil pan guard. While securely supporting the oil pan guard, loosen bolts A and B and remove the oil pan guard.
2. In models with an under guard, remove the under guard. Loosen the bolts C while securely supporting the under guard, remove the clip and then remove the under guard.

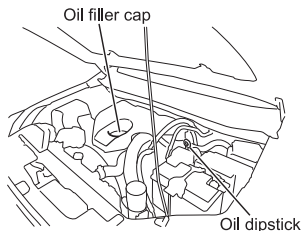

3. Clean around the oil filler cap so that foreign matter does not enter.
4. Remove the oil filler cap.

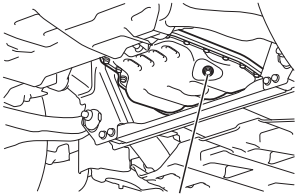
**2WD models**

Oil pan drain plug

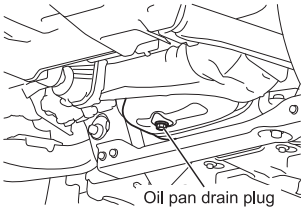
**4WD models**

Oil pan drain plug

5. Place a container for receiving the oil beneath the oil pan. Remove the oil pan drain plug to discharge the oil into the container.

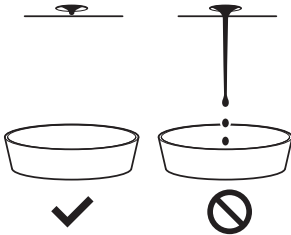

6. Wait until the flow of oil stops and the oil pools into a drop inside the oil pan drain hole.

**ADVICE**

- If the engine oil is not sufficiently drained from the oil pan, the oil level may be too high when oil is replenished.
- Drained oil must be disposed of in a method conforming to the regulatory requirements in your country.

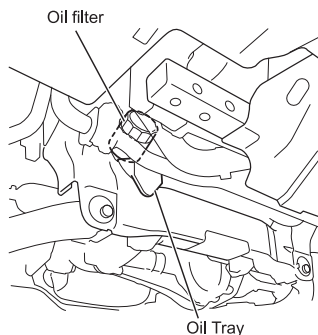

7. Place a container for receiving the oil beneath the oil tray.
8. Use the special oil filter wrench to remove the oil filter.

**ADVICE**

- Drained oil must be disposed of in a method conforming to the regulatory requirements in your country.

**NOTE**

- Engine oil will spill out from the removed oil filter, so catch the engine oil with a workshop rag, etc.

9. Lightly coat the gasket of the new oil filter with clean engine oil.
10. Wipe the attachment surface of the filter clean with a rag, etc.
11. Install the new oil filter. After the filter gasket comes in contact with the surface to which it will be attached, use the special oil filter wrench and tighten it by a 2/3 (two thirds) turn.

**ADVICE**

- When installing the oil filter, make sure the gasket is not caught in the screw threads. This could cause oil leaks.
12. Replace the oil pan drain plug gasket with a new one. Reinstall and tighten the oil pan drain plug.

Drain plug tightening torque

**44 N·m (4.5 kgf·m/33 lb·ft)**

**ADVICE**

- The dirt and oil on the following parts must be wiped off before reinstalling the oil pan drain plug.
  - Thread of the oil pan drain plug
  - Thread of the oil pan drain hole
  - Bolt seat surface of the oil pan

13. Fill the specified oil into the oil filler carefully.
14. Install the oil filler cap. Start the engine 5 minutes after refilling it with the new oil and let it idle. While the engine is idling, check to see if any oil leaks around the oil pan drain plug.

**ADVICE**

- Avoid revving up the engine, as it could damage the engine.

15. Shut off the engine. Then, after waiting at least 30 minutes, check the oil level using the oil dipstick.

**WARNING**

- Bringing flames or other heat sources near spilled engine oil could cause a fire. Make sure to wipe it all up.
- Do not leave flammable items, such as rags or gloves in the engine compartment. They could be the cause of a fire. Also, do not forget your tools.

**ADVICE**

- Do not fill the engine with oil above the "MAX" mark on the oil dipstick. Overfilling could damage the engine.

16. Reinstall the under guard (if equipped) and the oil pan guard (if equipped).

Under guard and oil pan guard tightening torque

**41 N·m (4.2 kgf m/30.2 lb·ft)**

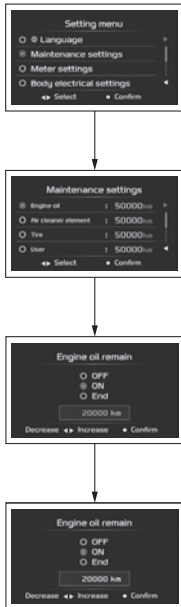

17. Set the maintenance reminder again.

[Models with MID]

Make sure that the engine is stopped when switching the power mode to "ON" (models with passive entry and start system) or turning the starter switch to the "ON" position (models without passive entry and start system).

Select "Maintenance settings" displayed on the MID screen. Then select "Engine oil". After selecting "ON", adjust the distance as desired by pressing the MID mode R switch or MID mode L switch. Then press the MID mode confirm switch to confirm. When an item is confirmed or "END" is selected, the previous display returns.

#### Settings (Meter Settings)

→ Refer to page 4-40

#### Engine Start/Stop Button (Models with Passive Entry and Start System)

→ Refer to page 4-112

#### Starter Switch (Models without Passive Entry and Start System)

→ Refer to page 4-115



#### ADVICE

- When changing the engine oil, be sure to set a maintenance reminder. If you do not set the maintenance reminder, the engine oil deterioration warning light may come on, even though the condition of the engine oil is normal.

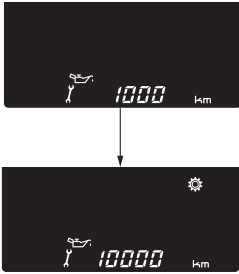

[Models with LCD]

Turn the starter switch to the "OFF" position, and then open and close a door. The maintenance reminder display appears for approximately 5 seconds.

When the trip knob is pressed and held while the maintenance reminder is displayed, the gear mark starts flashing.

Press the trip knob to select a distance. Press and hold the trip knob to confirm the distance.

### Changing the Engine Oil and Oil Filter (RZ4E Engine Model)

Change the engine oil and oil filter on a flat surface while the engine is cold before starting it. If the engine has already been started, stop it after it has sufficiently warmed, wait 30 minutes or more, and perform after confirming that the oil has sufficiently cooled.

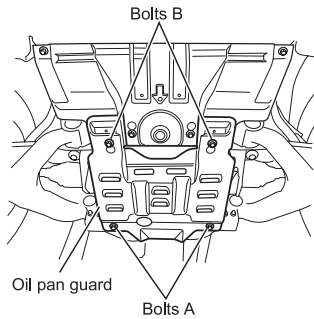

1. In models with an oil pan guard, remove the oil pan guard. While securely supporting the oil pan guard, loosen bolts A and B and remove the oil pan guard.

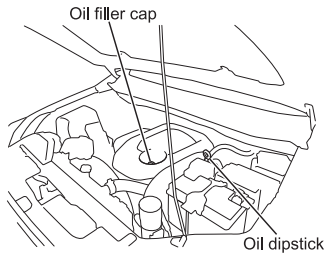

2. Clean around the oil filler cap so that foreign matter does not enter.
3. Remove the oil filler cap.

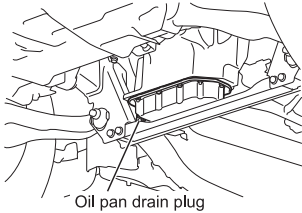

- Place a container for receiving the oil beneath the oil pan. Remove the oil pan drain plug to discharge the oil into the container.

**ADVICE**

- Drained oil must be disposed of in a method conforming to the regulatory requirements in your country.

- Pull the tab of clip A, and clip B in the direction of the arrow and remove clips from the stays while unlocking.

**ADVICE**

- When removing, do not apply excessive force to the tab of the clip and do not attempt to forcibly remove the clip while the lock is not released. Doing so may result in clip breakage.

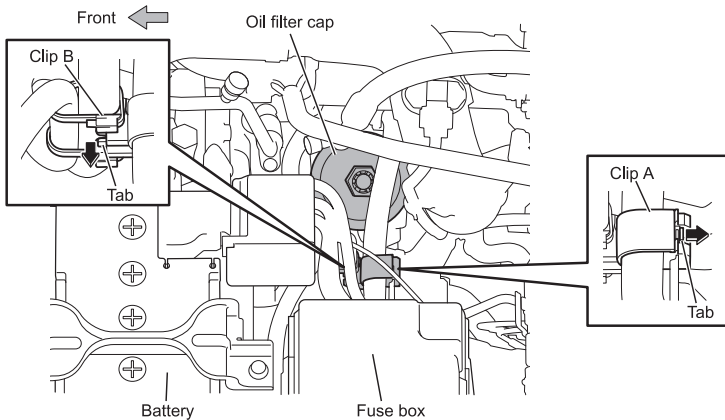

6. Move the wires in front of the oil filter cap aside, and ensure a space to remove the oil filter cap.

**ADVICE**

- Do not apply excessive force to the wires when moving them aside.

7. Using a socket wrench, loosen the oil filter cap.
8. Wait for approximately 30 seconds.
9. Remove the oil filter cap.

**ADVICE**

- If you remove the oil filter cap immediately after loosening, engine oil may overflow.

10. Remove the oil filter element from the oil filter cap.

**ADVICE**

- Drained oil must be disposed of in a method conforming to the regulatory requirements in your country.

**NOTE**

- Engine oil will drip from the removed oil filter. Catch the engine oil with a workshop rag, etc.

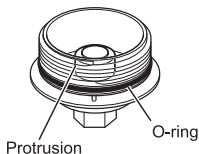
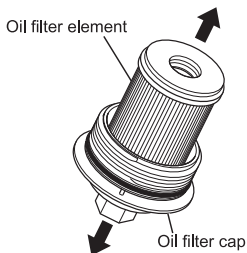

11. To ensure that the new oil filter element makes good contact, wipe the protrusion inside the oil filter cap using a clean workshop rag, etc.
12. Remove the O-ring from the oil filter cap and wipe the O-ring mounting surface using a clean workshop rag, etc.
13. Install a new O-ring to the oil filter cap.

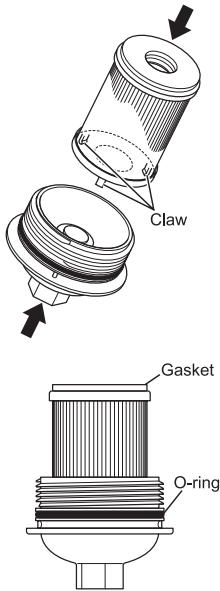

14. Face the claw side of the new oil filter element towards the oil filter cap, and install by firmly pushing it in until the claws latch on.
15. Make sure that the oil filter element and oil filter cap are installed straightly.

16. Lightly coat the gasket of the new oil filter element and the O-ring of the oil filter cap with clean engine oil.
17. Install and tighten the oil filter cap by hand. Finally, tighten the cap to the specified torque using a torque wrench.

Oil filter cap tightening torque

**25 N·m (2.5 kgf·m/18 lb·ft)**



#### ADVICE

- When installing, make sure the gasket and O-ring are not caught in other parts. This could cause oil leaks.

18. Install clips to the stays.
19. Replace the oil pan drain plug gasket with a new one. Reinstall and tighten the oil pan drain plug.

Drain plug tightening torque

**83 N·m (8.5 kgf·m/61 lb·ft)**

**ADVICE**

- The dirt and oil on the following parts must be wiped off before reinstalling the oil pan drain plug.
  - Thread of the oil pan drain plug
  - Thread of the oil pan drain hole
  - Bolt seat surface of the oil pan

20. Fill the specified oil into the oil filler carefully.
21. Install the oil filler cap. Start the engine 5 minutes after refilling it with the new oil and let it idle. While the engine is idling, check to see if any oil leaks around the oil pan drain plug.

**ADVICE**

- Avoid revving up the engine, as it could damage the engine.

22. Shut off the engine. Then, after waiting at least 30 minutes, check the oil level using the oil dipstick.

**WARNING**

- Bringing flames or other heat sources near spilled engine oil could cause a fire. Make sure to wipe it all up.
- Do not leave flammable items, such as rags or gloves in the engine compartment. They could be the cause of a fire. Also, do not forget your tools.



## ADVICE

- Do not fill the engine with oil above the "MAX" mark on the oil dipstick. Overfilling could damage the engine.

23. Reinstall the oil pan guard (if equipped).

Oil pan guard tightening torque

**41 N·m (4.2 kgf m/30.2 lb·ft)**

24. Set the maintenance reminder again.

[Models with MID]

Make sure that the engine is stopped when switching the power mode to "ON" (models with passive entry and start system) or turning the starter switch to the "ON" position (models without passive entry and start system).

Select "Maintenance settings" displayed on the MID screen. Then select "Engine oil". After selecting "ON", adjust the distance as desired by pressing the MID mode R switch or MID mode L switch. Then press the MID mode confirm switch to confirm. When an item is confirmed or "END" is selected, the previous display returns.

#### Settings (Meter Settings)

→ Refer to page 4-40

#### Engine Start/Stop Button (Models with Passive Entry and Start System)

→ Refer to page 4-112

#### Starter Switch (Models without Passive Entry and Start System)

→ Refer to page 4-115

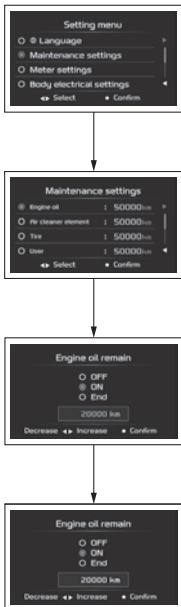



## ADVICE

- When changing the engine oil, be sure to set a maintenance reminder. If you do not set the maintenance reminder, the engine oil deterioration warning light may come on, even though the condition of the engine oil is normal.



[Models with LCD]

Turn the starter switch to the "OFF" position, and then open and close a door. The maintenance reminder display appears for approximately 5 seconds.

When the trip knob is pressed and held while the maintenance reminder is displayed, the gear mark starts flashing.

Press the trip knob to select a distance. Press and hold the trip knob to confirm the distance.

## Engine Coolant

The engine cooling system is a device for keeping the engine temperature at an appropriate level.

The engine coolant must be changed according to the Maintenance Schedule.

Have engine coolant replacement performed at an Isuzu Dealer.

### Maintenance Schedule

→ Refer to page 6-136

### Recommended Fluids, Lubricants and Diesel Fuels

→ Refer to page 6-137



### WARNING

- Check, replenish or change the engine coolant only after the engine has sufficiently cooled down.
- Do not loosen or remove the cap of the radiator or reserve tank cap when the engine coolant is still hot. Hot vapor or boiling water may burst out and cause a burn. Cover the cap with a cloth, etc. and remove it gradually after the engine is fully cooled down and the temperature of the engine coolant becomes low.
- When removing the radiator cap or reserve tank cap, use a thick cloth to cover the cap and turn it slowly.
- Engine coolant is toxic and must not be ingested. If the engine coolant is mistakenly ingested, immediately vomit it and seek prompt medical attention.
- If the engine coolant gets in your eyes, rinse it off immediately with a large amount of water for 15 minutes or longer. Also, if still abnormality such as irritation is felt, seek medical attention.
- If the engine coolant gets on your skin, rinse it off using a soap with a large amount of water. Also, if abnormality is seen, seek medical attention.
- Engine coolant is flammable, and therefore, it must be kept away from flames and other heat sources. Engine coolant also could ignite if it comes in contact with a hot surface, such as the exhaust manifold. Exercise caution to prevent this from happening.



### ADVICE

- Replace the engine coolant periodically.  
If the engine coolant is not replaced periodically, rust is generated due to degradation of the engine coolant, which may cause a failure such as water leakage or clogging of the radiator or heater core.

**NOTE**

- Engine coolant is fluid which is made by mixing coolant and water at an appropriate concentration.

**Preparing Engine Coolant**

To prevent the engine damage due to freezing of the engine coolant and to protect the cooling system from corrosion, mix the Isuzu recommended coolant and water at the ratio of 50/50.

Direct use of "50/50 Pre-diluted" product which is already diluted to 50% concentration is recommended.

**Recommended Fluids, Lubricants and Diesel Fuels** → Refer to page 6-137

**ADVICE**

- Isuzu does not guarantee the use of the engine or vehicle at the outside temperature of -30 C (-22 F) or below.
- If the engine or vehicle is used at the outside temperature of -30 C (-22 F) or below, the coolant concentration of 55% is recommended.
- If the concentration of engine coolant is less than 50%, the anti-rust performance of the engine coolant may decrease.

 **WARNING**

- Coolant is toxic and must not be ingested. If the coolant is mistakenly ingested, immediately vomit it and seek prompt medical attention.
- If the coolant gets in your eyes, rinse it off immediately with a large amount of water for 15 minutes or longer. Also, if still abnormality such as irritation is felt, seek medical attention.
- If the coolant gets on your skin, rinse it off using a soap with a large amount of water. Also, if abnormality is seen, seek medical attention.
- For storage, close the cap securely and keep it in a place inaccessible to children.
- Coolant is flammable, and therefore, it must be kept away from flames and other heat sources. Coolant also could ignite if it comes in contact with a hot surface, such as the exhaust manifold. Exercise caution to prevent this from happening.

 **CAUTION**

- Use only an Isuzu recommended coolant.
- Using any coolant other than that Isuzu recommended could cause damage to the engine, radiator, or heater core. In particular, use of coolants containing amines, borate salts, or silicates may result in engine or radiator corrosion, causing engine coolant leaks and other problems.
- Do not use water alone.

 **ADVICE**

- To dilute the coolant, use distilled water or deionized water.
- Do not use the coolant at any coolant concentration other than that specified. If the coolant concentration is 60% or higher, overheating is likely to occur, while if it is 50% or lower, anti-corrosion function is not provided sufficiently.
- Using coolant at any coolant concentration other than that specified may reduce anti-freezing performance, and engine coolant may freeze.
- If the engine coolant decreases rapidly, go immediately to the nearest Isuzu Dealer for a check or repair.
- Do not introduce additives to engine coolant other than coolant.

## Checking the Engine Coolant Level

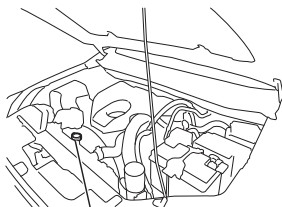
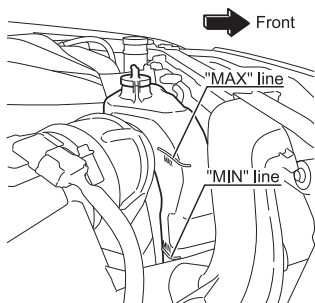

The reserve tank is located at the front right side of the engine compartment. When the engine has cooled down, make sure that the engine coolant level in the reserve tank is between the "MAX" and "MIN" line.

In addition, remove the radiator cap and check that the engine coolant is full to the filler neck. Check the engine coolant level only when it is cold.

**Engine Hood → Refer to page 6-11**

 **CAUTION**

- The radiator cap opens and closes in double action. When removing the radiator cap, take caution not to damage the cap and the filler neck.

Also, check to make sure there are no leaks from the radiator or radiator hose. Check for fluid or stains on the ground showing leaks where the vehicle is parked. Contact your Isuzu Dealer when you discover leaks.

 **CAUTION**

- Using the vehicle when there are leaks can lead to engine seizure.

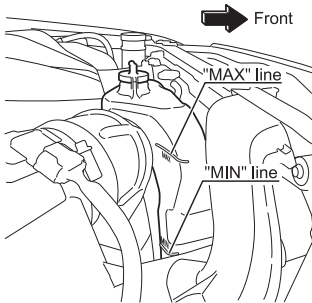
**Adding the Engine Coolant**

When the engine coolant level in the reserve tank is below the "MIN" line, open the tank cap and fill to near the "MAX" line with engine coolant. Tighten the cap securely after the engine coolant has been replenished.

**Engine Hood** → Refer to page 6-11

**WARNING**

- Check, replenish or change the engine coolant only after the engine has sufficiently cooled down.

**ADVICE**

- Do not overfill the reserve tank.
- Check the reserve tank to determine engine coolant level. In situations, however, where the level in the reserve tank rises or falls suddenly, open the radiator cap and check the level within the radiator itself.
- When the engine is still hot, take care to prevent engine coolant from contact with the exhaust manifold. Any such contact could result in exhaust manifold damage.
- If the level of engine coolant changes rapidly, have your vehicle inspected at your Isuzu Dealer.

## Handling the Radiator and Intercooler

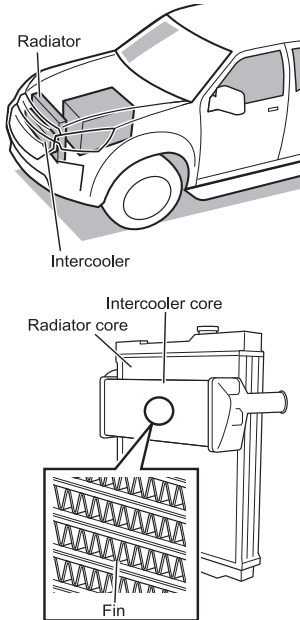

### Cleaning the Radiator Core and Intercooler Core

Cooling efficiency is compromised when there is dirt or dust plugging air passages in the radiator core and intercooler core.

This can also cause corrosion of these cores. Periodically wash the radiator core and intercooler core with tap water.

#### WARNING

- Before cleaning cores, in models with passive entry and start system, make sure to turn the engine off and switch the power mode to "OFF". In models without a passive entry and start system, make sure to turn the engine off and remove the key from the starter switch.
- The area around the engine is extremely hot immediately after vehicle operation, so wait until the vehicle has cooled down before cleaning. Otherwise, you could be burned.

#### CAUTION

- When washing the radiator core and intercooler core, make sure that they have sufficiently cooled. Otherwise, the cores could be damaged.
- Do not clean the radiator, intercooler and their surrounding areas using water that is supplied under high pressure. Doing so may cause damage.
- When cleaning the radiator core and intercooler core, do not crush or damage the fins.

CAUTION (Continued)

**CAUTION (Continued)**

- The fins are very fragile so be careful not to bend them out of shape. If they become deformed, their cooling efficiency will be impaired.
- Before cleaning, take steps to ensure that no water will splash onto the surrounding electrical components and wires.
- If stubborn dirt still remains even after the radiator core and intercooler core have been cleaned, have the vehicle inspected and serviced at your Isuzu Dealer.

### Fan Belt/Air Conditioning Compressor Belt/ Accessory Belt

**CAUTION**

- A V-ribbed belt is used for the fan belt. This type of belt requires the tension to be adjusted more accurately than is required with the conventional V belt. Inappropriate tension could cause the belt to make noise or break. When the fan belt is damaged, electricity is not properly generated or becomes a cause of engine overheating. You must check the tension of the fan belt carefully.
- Inappropriate tension could cause the belt to make noise or break. You must check the tension of the air conditioning compressor belt carefully.
- Use Isuzu genuine parts when changing the fan belt, air conditioning compressor belt, and accessory belt.

[Follow this to properly adjust belt tension]

- Adjust the belt using the following method after installing either a new or used belt.
  - Inspect the belt before starting the engine or 30 minutes after turning off the engine to cool down.
  - Align the belt and pulley grooves and adjust the belt tension using the indicated method.
  - Start the engine, and let it idle for about 1 minute to equalize the tension of the belt at all spans between the pulleys.
  - Stop the engine, and then check the belt tension. If the tension is inappropriate, readjust it to the specified standard value.
  - Use the new belt tension specification only after replacing the belt with a new one.

## Inspection

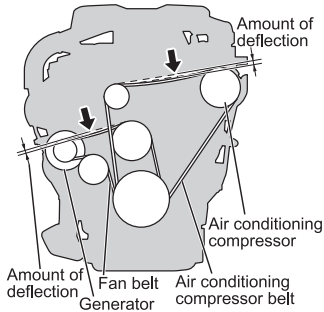
**4JJ3 Engine Model**

Press the center of the span between pulleys (see the figure) of the belt with a force of **98 N (10.0 kgf/22 lb)** and check the amount of deflection. The amount of deflection must fall within the standard value range indicated below. Otherwise, adjust the tension.

When inspecting by vibration frequency, place and hold the sensor mic surface parallel to the belt 10 mm (0.39 in) from the center of the span between pulleys (indicated by the arrow) and tap the belt with a handle of screwdriver etc. to make the belt vibrated and measure the value. Measure the value two or three times and calculate the average value. The average value must be within the standard value range indicated below. Otherwise, adjust the tension.

Also check the belt for cracks or other damage. If there are any cracks or damage, replace the belt.

Have adjustment and replacement of the fan belt or air conditioning compressor belt performed at an Isuzu Dealer.

Belt	Standard value [amount of deflection]	Standard value [vibration frequency]
Fan belt	7.0 - 7.8 mm/0.28 - 0.31 in (New belt: 5.0 - 6.0 mm/0.20 - 0.24 in)*	176 - 190 Hz (New belt: 207 - 231 Hz)*
Air conditioning compressor belt	16.5 - 19.1 mm/0.65 - 0.75 in (New belt: 12.5 - 16.5 mm/0.49 - 0.65 in)*	79 - 91 Hz (New belt: 92 - 112 Hz)*

\*: The values in parentheses are the adjusted values for replacement with a new belt.

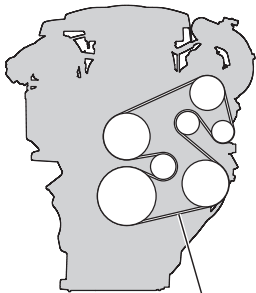

Accessory belt

**RZ4E Engine Model**

The tension of the accessory belt is automatically adjusted using an auto-tensioner.

Check the accessory belt for cracks or damage. Also, run the engine to check for belt squealing or looseness. If there are any cracks, damage, squealing, or looseness, replace the accessory belt. Have replacement performed at an Isuzu Dealer.

**WARNING**

- When performing checks with the engine running, take care to prevent hands, feet, clothing, or any accessories from coming into contact with moving parts, such as cooling fan or belts.

**Starting the Engine**

→ Refer to page 4-4

## Air Cleaner

Use of clogged air cleaner element not only causes a deterioration in the engine output but also increased fuel consumption. The air cleaner element should be serviced in the following manner.

The air cleaner element must be inspected and changed according to the Maintenance Schedule. Have air cleaner element replacement performed at an Isuzu Dealer.



### ADVICE

- Be sure to use an Isuzu genuine air cleaner element.
- The cover should be reinstalled after aligning correctly to prevent dust from entering. The engine air cleaner should be installed at all times unless temporary removal is necessary during repair or maintenance of the vehicle. Absence of the air cleaner could cause damage to the engine.

### Maintenance Schedule

→ Refer to page 6-136

## Inspection and Cleaning of the Air Cleaner

Remove the air cleaner element and check to see if it is blocked by dirt.

If air cleaner element is blocked by dirt, clean the air cleaner element.

1. Remove the wiring harness from the clamp. Unfasten the two clips and open the air cleaner cover.

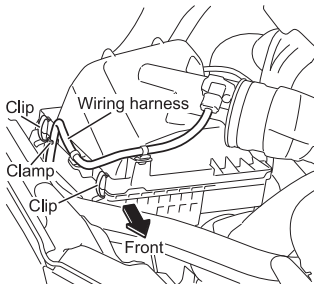

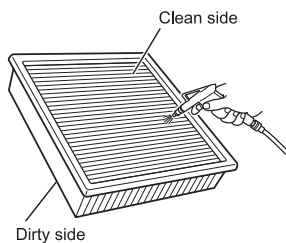
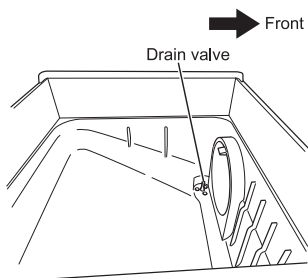
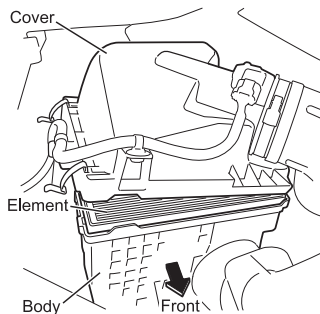

2. Remove the air cleaner element by pulling it out upward.
3. Remove any dirt that has accumulated on the inside of the air cleaner body.

4. Clean the drain valve at the bottom of the air cleaner.

5. Blow compressed air at a pressure of up to **690 kPa (7.0 kgf/cm /100 psi)** against the clean side of the element to remove the dust.

**ADVICE**

- Do not apply compressed air to the dirty side of the element as it causes dust to become lodged in the element.
6. Check to see if the element has been damaged or become thin in places.
  7. Reinstall the air cleaner element. Close the air cleaner cover and fasten the two clips of the air cleaner body. Attach the wiring harness to the clamp.

## Fuel Filter

Change the fuel filter in accordance with the Maintenance Schedule. Have fuel filter replacement performed at an Isuzu Dealer.

Drain the water when the water separator warning light comes on.



### CAUTION

- If the water separator warning light comes on while the engine is running, immediately drain water from the fuel filter. If you still continue driving with the warning light on, the fuel injection system may fail.



### ADVICE

- Water remaining that is not discharged from the water separator (fuel filter) could freeze and damage the vehicle.

#### Maintenance Schedule

→ Refer to page 6-136

#### Water Separator Warning Light

→ Refer to page 4-77

## Draining Water from the Fuel Filter

Have water separator (fuel filter) drain work performed at an Isuzu Dealer. If performing water separator (fuel filter) drain work yourself, dispose of the oil in a method conforming to the regulatory requirements in your country.

### Right-hand Drive

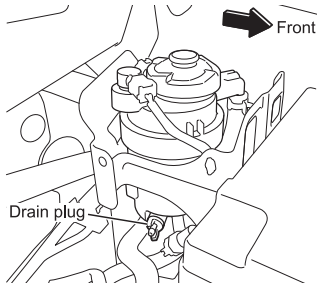

1. The fuel filter is located at the rear left side of the engine compartment. Connect one end of a plastic hose to the drain plug at the bottom of the fuel filter and place the other end of the hose inside a container to receive the drained fluid.



### WARNING

- Perform drain work in a location without any flammable material. Failure to do so could cause a fire.

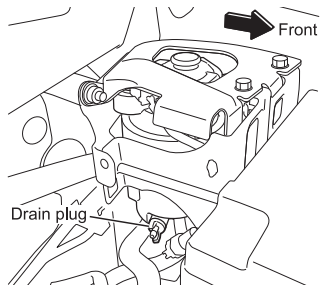
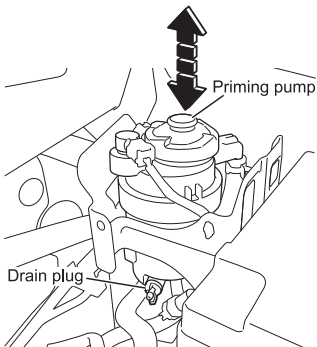
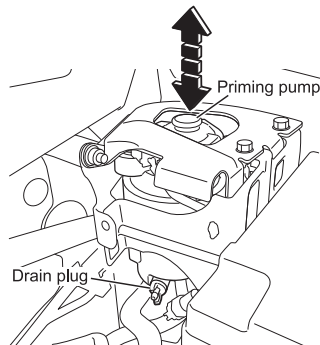
**Left-hand Drive****Right-hand Drive****Left-hand Drive**

2. Loosen the drain plug and move the priming pump up and down by hand between ten and twenty times.
3. Fully tighten the drain plug and move the priming pump several times.
4. Test run the engine and check that there are no fuel leaks from the drain plugs of the fuel filter. Also check that the water separator (fuel filter) warning light stays off.

**CAUTION**

- Be sure to stop the engine when draining water from the fuel filter.
- Clean off any fuel that has adhered to the vehicle body.
- Starting the engine immediately after draining the water from the fuel filter requires a little more time than usual. If the engine does not start in 10 seconds, wait for a while and try again.
- Fuel will be mixed in the drained water. Dispose of it in a method conforming to the regulatory requirements in your country.
- If the water separator (fuel filter) requires frequent draining, have the fuel tank drained at your Isuzu Dealer. It would be better not to use the water separator (fuel filter), since it may possibly exert a bad effect on the fuel system.



**CHASSIS-RELATED SERVICE AND  
MAINTENANCE**

• Brakes	6-56
• Parking Brake	6-61
• Wheels and Tires	6-61
• Tire Rotation	6-67
• Spare Tire	6-68
• Handling the Jack	6-73
• Changing Tires	6-78
• Clutch Fluid (Manual Transmission Model)	6-88
• Automatic Transmission Fluid (Automatic Transmission Model)	6-89
• Steering Wheel	6-90
• Power Steering Fluid (Hydraulic Power Steering Model)	6-91

## Brakes



### WARNING

- If there are abnormalities with the brake system, avoid driving the vehicle and contact the nearest Isuzu Dealer.

## Brake Fluid

For a manual transmission model, the tank of the brake fluid is common with a tank of the clutch fluid.



### WARNING

- If the brake fluid gets in your eyes, rinse it off immediately with a large amount of water for 15 minutes or longer. Also, if still abnormality such as irritation is felt, seek medical attention.



### CAUTION

- Before refilling the tank, clean the area around the cap and fill brake fluid from a clean container. Foreign objects getting in the tank will lead to a brake system failure.
- Inspect and change brake fluid according to the Maintenance Schedule.
- Use only the specified brake fluid.
- Be careful not to let brake fluid come in contact with skin. If fluid comes into contact with skin, wash away the fluid with water.
- Brake fluid melts paintwork and vehicle component materials such as plastic, vinyl and rubber. It is also highly corrosive on metals. If it is spilled, immediately wipe the area clean or wash away the fluid with water.
- If skin irritation persists, check with a doctor.
- Brake fluid readily absorbs moisture. Therefore, it is necessary to close the container tightly for storage.
- Do not mix brake fluid with fluids of a non-specified brand. Due to chemical reactions, any mixture of differently branded fluids will cause failure of the brake system.

CAUTION (Continued)

**CAUTION (Continued)**

- If the brake fluid level decreases rapidly, there may be a problem in the brake system or brake pads or shoe linings may have worn out. Have your vehicle inspected by the nearest Isuzu Dealer immediately.

**Maintenance Schedule**

→ Refer to page 6-136

**Recommended Fluids, Lubricants and****Diesel Fuels** → Refer to page 6-137**Checking the Brake Fluid Level**

Check that the fluid level in the reserve tank is between the "MAX" and "MIN" lines. Be sure to use the brake fluid compartment section when checking the "MIN" line section of the brake fluid level. The brake fluid level cannot be accurately checked if the brake fluid level is checked with a method other than the brake fluid compartment section.

If the fluid surface cannot easily be seen, rock the vehicle gently.

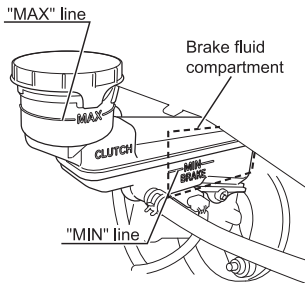
**CAUTION**

- Be sure to check the fluid level correctly. The clutch and brake fluid level varies when the brake pads are worn out.

**Adding Brake Fluid**

If the level of brake fluid has dropped below the "MIN" line, remove the cap and add fluid. Take care to avoid filling beyond the "MAX" line.

Tighten the cap securely after the fluid has been added.

**Changing Brake Fluid**

Change the brake fluid according to the Maintenance Schedule using the specified fluid. Since a brake fluid change requires disassembly of the related components, have this service performed by your Isuzu Dealer.

## Brake Pedal

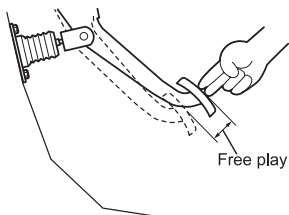

### Free Play

Shut off the engine and depress the brake pedal about ten times strongly, then check the brake pedal for free play by lightly pushing it by hand until you feel resistance. If the free play is not within the specified range, have your vehicle inspected and adjusted by an Isuzu Dealer.

Free play (measured at the tip of pedal)

6 - 10 mm (0.24 - 0.39 in)

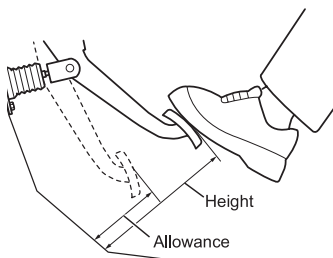

### Height and Allowance

Inspect the brake pedal height from the floor.

Next, start the engine, wait at least 1 minute and inspect the brake pedal allowance from the floor with the brake pedal in a depressed position.

If the height and allowance are not within the specified range, have your vehicle inspected and adjusted by an Isuzu Dealer.

Transmission model	Height	
	Right-hand drive models	Left-hand drive models
Manual transmission models	175.7 - 187.7 mm (6.92 - 7.39 in)	174.6 - 186.6 mm (6.87 - 7.35 in)
Automatic transmission models	177.8 - 189.8 mm (7.00 - 7.47 in)	176.8 - 188.8 mm (6.96 - 7.43 in)

Allowance (pressure of 490 N (50 kgf / 110 lb) applied to the brake pedal)

85 mm (3.35 in) or more

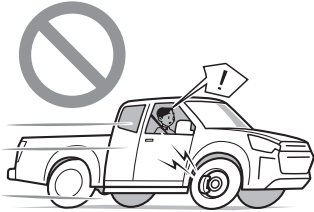
**ADVICE**

- If, after continued depressing of the brake pedal, the clearance slowly decreases or the pedal action feels spongy, air may be trapped in the brake hydraulic circuit. Have your vehicle inspected at the nearest Isuzu Dealer as soon as possible.
- If your vehicle's brakes squeak during normal driving or braking, the cause may be one of the following.
  - Brake pad wear  
Brake pads are about to wear out. If this happens, have your vehicle inspected at the nearest Isuzu Dealer as soon as possible.
  - Adherence of sand, grit or mud  
If sand, grit or mud adheres to the brakes, a screeching sound may be emitted upon contact with rotating components. If this happens, wash the vehicle to remove all such adhering matter. If cleaning alone does not eliminate the squeaking sound, have your vehicle inspected at the nearest Isuzu Dealer as soon as possible.

**NOTE**

- To check the clearance of the brake pedal from the floor, start the engine, and then depress the accelerator pedal several times. After that, measure the clearance of the brake pedal the first time it is depressed. The clearance cannot be correctly measured after the pedal is depressed two or more times.

**Brake Performance**

Run the vehicle slowly on a dry road and apply the brakes. Check that the brakes fully work and the vehicle does not pull on one side. If there are problems with brake performance, avoid driving the vehicle and contact the nearest Isuzu Dealer.

**CAUTION**

- A brake performance check should be performed on a wide road with good visibility while paying adequate attention to the traffic behind and the surroundings.

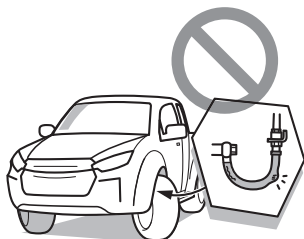
**Brake Hoses and Pipes**

With the steering wheel turned fully to the left, check the left front brake hose and pipe visually and by touch, making sure that they are free of scratches, cracks and bulging. Also make sure that the hose and pipe do not interfere with any chassis part or wheel, and that their joints are not leaking and free of any type of damage. Check the right front brake hose and pipe in the same way. The rear left and right brake hoses and pipes should also be checked. If there are abnormalities with the brake hoses or pipes (damage, scratches, cracks, bulging, leakage, etc.), avoid driving the vehicle and contact the nearest Isuzu Dealer.

## Parking Brake

### Inspection

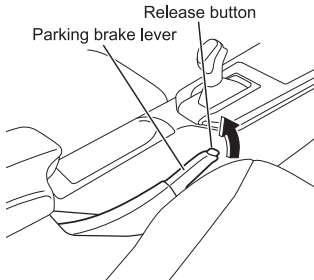

Pull the parking brake lever slowly from the fully released position while counting the clicks produced as the lever engages ratchet plate notches to check that it can be raised the proper amount and the lever is held firmly. If the number of notches is not within the standard value range below, adjust it to the standard value. Also, on a dry sloping road, check that the parking brake can hold the vehicle stationary.

Have adjustment of the parking brake and inspections for parking brake performance performed at an Isuzu Dealer.

Lever stroke*
6 to 9 notches

\*: Number of notches before parking brake is set when lever is pulled slowly from released position with pull force of about **294 N (30 kgf/66 lb)**.

## Wheels and Tires

The wheels have a major influence upon the safety and comfort of driving. Should any wheel fall off the vehicle, it not only causes the vehicle to breakdown on the road and block other traffic, but it may also lead to a serious accident. We strongly recommend that you check the wheels and tires daily and maintain them in satisfactory condition.

### WARNING

- Do not drive the vehicle unless the tires are properly inflated and in safe condition.
- If you find anything abnormal with wheel bolts, wheel nuts, disc wheels or tires when you check them, avoid driving the vehicle and contact the nearest Isuzu Dealer.
- If you find anything abnormal on the left wheels, check the right wheels carefully for similar defects. A defect on a wheel may be a sign of defects on other wheels.

## Checking Tires

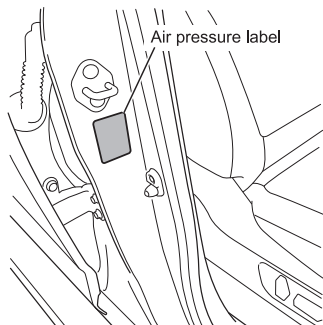
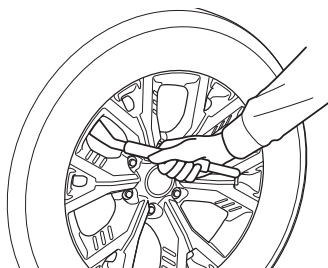

### Air Pressure

Too low or too high a tire air pressure not only affects the ride or causes damage to the cargo but also causes abnormal heat buildup, premature wear, a tire puncture, or may even cause the tire to burst.

- Use an appropriate tire air pressure gauge when measuring the air pressure of a tire. Tire air pressure should be measured when the tire is cold, or before the vehicle is driven. (After driving, tire air pressure increases by about 10%.)
- As the tire air pressure varies depending on the vehicle model and tire size, refer to the air pressure label on the driver's door opening frame if the air pressure label is attached or the tire air pressure tables on the following pages if the air pressure label is not attached.
- Also check the air pressure of the spare tire using a tire air pressure gauge at the intervals specified by the Maintenance Schedule.

Tire Size and Tire Air Pressure

Vehicle model	Tire size		Tire air pressure kPa (kgf/cm / psi)	
	Front	Rear	Front	Rear
2WD High-Ride/4WD	205R16C		Unloaded <b>220 (2.20/32)</b>	Unloaded <b>220 (2.20/32)</b>
			Loaded <b>260 (2.60/38)</b>	Loaded <b>400 (4.00/58)</b>
	255/65R17		Unloaded <b>220 (2.20/32)</b>	Unloaded <b>220 (2.20/32)</b>
			Loaded <b>260 (2.60/38)</b>	Loaded <b>320 (3.20/46)</b>
	265/60R18		Unloaded <b>220 (2.20/32)</b>	Unloaded <b>220 (2.20/32)</b>
			Loaded <b>260 (2.60/38)</b>	Loaded <b>320 (3.20/46)</b>
<b>Arctic 4WD</b> (*Dual valve system, use conventional valve [Black Cap] for inflating/deflating purpose.)	315/70R17 or 35/12.5R17		Unloaded <b>220 (2.20/32)</b>	Unloaded <b>220 (2.20/32)</b>
			Loaded <b>300 (3.0/43.5)</b>	Loaded <b>300 (3.0/43.5)</b>

 **WARNING**

- Insufficiently inflated or worn-out tires are highly dangerous as they easily skid and can even burst. Should they burst, the tires may burn and this could cause a fire in the vehicle.
- If you drive on under-inflated or flat tires, the wheel bolts will be placed under excessive stress. Under such conditions, the bolts may break and the wheel may detach from the vehicle, possibly causing an accident.

 **CAUTION**

- Over-inflated tires result in a harsh ride and are likely to cause damage to the cargo. Under-inflated tires build up heat and could burst. Always keep the tires of your vehicle adjusted at the standard air pressures.

### Cracks and Other Damage

Check the tread and sidewall surfaces of each tire for cracks or other damage. Especially check the tread for nails or other metal pieces embedded in grooves.

If you find anything abnormal with tires when you check them, avoid driving the vehicle and contact the nearest Isuzu Dealer.



#### ADVICE

- When checking tires, pay special attention to: low air pressure; pebbles or nails in tread grooves; cracks or other damage on tire surfaces; uneven wear.

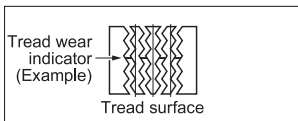
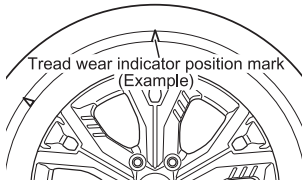

### Tread Depth and Abnormal Wear

Using worn-out tires is dangerous because they might have an increased chance of getting punctured or bursting while driving. Check all tires to see if tread wear indicators appear on their treads and also check their entire tread for its depth with a depth gauge to make sure that the grooves are deeper than the specified depth.

A tire with tread wear indicators appearing must be changed. Also, check the tires for uneven or otherwise abnormal wear.

If the tires are worn, contact your Isuzu Dealer as soon as possible.



#### CAUTION

- Tires with excessively shallow tread grooves will increase the chance of skidding and, when driving at high speeds, hydroplaning.

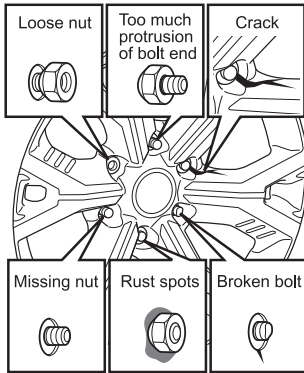

### Inspection of Installation and Conditions of Disc Wheels

Inspect the installation and conditions of the disc wheels.

1. Check that there are no missing wheel bolts and wheel nuts.
2. Check each disc wheel to see if there is any rust seepage from wheel bolts or nuts. Also check the disc wheel for cracks or other damage.
3. Check the end of each wheel bolt for proper length of protrusion from the wheel nut. The protrusion should be uniform among all bolts on a wheel and among all wheels. If you find anything abnormal with wheel bolts, wheel nuts or disc wheels when you check them, avoid driving the vehicle and contact the nearest Isuzu Dealer.



#### CAUTION

- Any abnormality in wheel installation is likely to lead to loose or missing wheel nuts and/or broken wheel bolts.

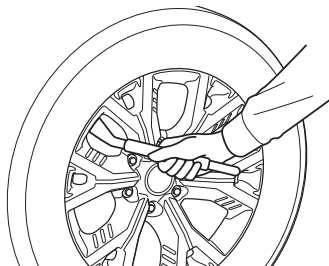

### Spare Tire Air Pressure

Keep the air pressure of the spare tire slightly higher than the standard pressure. Adjust the pressure correctly when you use it.

Tires heat up while driving, and their air pressures become higher accordingly. If you must wait until right after driving to adjust the air pressure, determine the target pressure for adjustment by adding about **20 kPa** (0.2 kgf/cm / **3 psi**) to the standard pressure.

**Spare Tire** → Refer to page **6-68**

### Tires Used for Long Term

Tires are made of rubber whose property changes gradually by aging as time goes on (even when it is stored fitted on the rim like a spare tire). Tires must receive an aging check after being used for up to 5 to 7 years if they are to be used continuously. For further details, please contact your Suzuki Dealer.

## Tire Rotation

**CAUTION**

- Be sure to check the wheel bolts, wheel nuts and disc wheel for any abnormality whenever the disc wheel is removed.
- If you find any abnormal condition on the wheel bolts, wheel nuts or disc wheel, do not continue to use the wheel. Contact the nearest Isuzu Dealer as soon as possible.

Tires at different locations wear differently. For uniform tire wear and longer tire life, you should rotate the tires on your vehicle regularly.

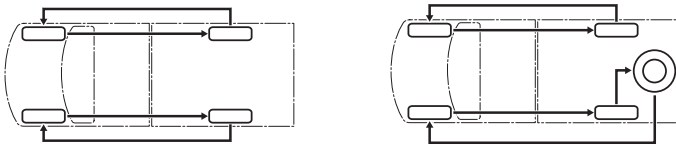

If one-sided tire wear appears on radial tires, rotate the wheels as shown in the below figure.

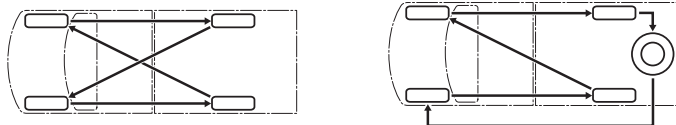

**Spare Tire** → Refer to page 6-68

**Handling the Jack**

→ Refer to page 6-73

**Changing Tires**

→ Refer to page 6-78

**ADVICE**

- The tightening torque of the wheel nuts may decrease after a tire change due to their initial settlement. Upon driving 50 to 100 km (31 to 62 miles) after a tire change, retighten the wheel nuts to the specified torques according to the instructions in the "Retightening Wheel Nuts" section in this chapter.
- If the spare tire disc wheel is steel (not aluminum), it is for emergency use only for vehicles that are equipped with an aluminum wheel (do not use in the rotation sequence).

**Retightening Wheel Nuts**

→ Refer to page 6-87

## Spare Tire

## Removal

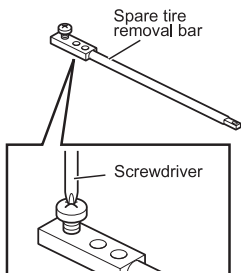
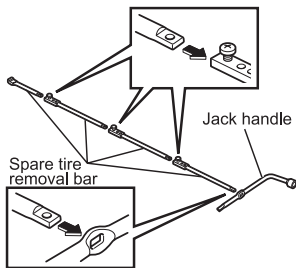

1. Assemble the spare tire removal bars and jack handle.

2. When assembling the spare tire removal bars to each other, tighten the joint bolts by hand or with a screwdriver (Phillips head). Make sure that the concave side is facing the bolt side of the other bar before tightening the bolt.

**CAUTION**

- Make sure that each screw joint is tightened properly.

**ADVICE**

- All the joint bolts should be tightened properly or the bars may become loose and hit the body panel, causing damage to the panel or paint.
- To prevent paint damage, place several pieces of paper above painted parts.

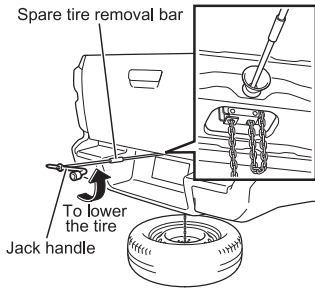

3. Insert the spare tire removal bar into the hole in the spare tire carrier, and turn the jack handle counterclockwise. Make sure that the spare tire rests on the ground completely and that there is enough clearance between the spare tire carrier plate and the spare tire.

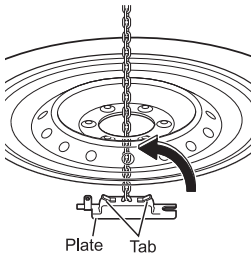

4. Place your fingers through the center of the disc wheel and hold the tabs on the spare tire carrier plate.

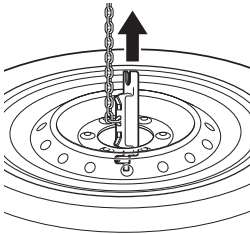

5. Stand the spare tire carrier plate so that it is perpendicular to the disc wheel, and remove the spare tire carrier plate through the center of the disc wheel.

## Storage

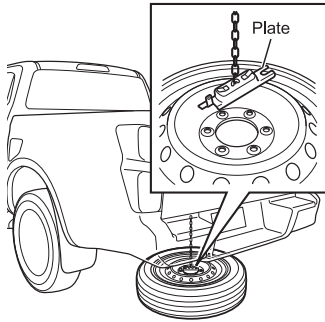

1. Set the disc wheel so that its outer surface faces up, and then insert the plate into the center of the disc wheel.

**NOTE**

- When storing aluminum wheels, make sure that the wheel cover is removed.

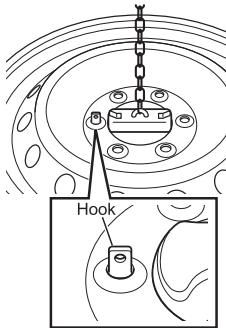

2. Insert the hook of the plate into the disc wheel nut hole and adjust its position for secure engagement with the spare tire before winding the chain up.

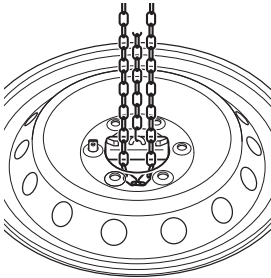
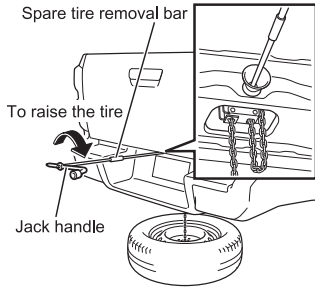

3. Let the chain rest in the center of the disc wheel while it is raised halfway. Then turn the jack handle to lift up the tire.

Turn the spare tire removal bar clockwise to fully wind up the chain, apply at least **196 N** (20 kgf/**44 lb**) of force to the jack handle by hand, and make sure that the spare tire is firmly secured in place.

**CAUTION**

- Do not remove the spare tire while the vehicle is jacked up.
- If the chain twisted when it is wound, it becomes loose while running due to vibrations or shocks and the tire might fall off; this is very dangerous.
- After storing the tire in the carrier, check that the tire is held firmly. If loosely retained, the tire becomes loose while running due to vibrations or shocks and the tire might fall off; this is very dangerous.

**ADVICE**

- After storing the spare tire, check that it is not loose by strongly pushing the tire with your foot. If the tire is loose, fasten it again after checking that there are no defects in the carrier such as a bent bracket or hanger plate. If you cannot retighten the tire in the carrier, avoid driving the vehicle and contact the nearest Isuzu Dealer.

**Air Pressure**

Check the air pressure of the spare tire using a tire air pressure gauge at the intervals specified in the Maintenance Schedule.

A spare tire inflated to a normal pressure may lose its pressure gradually over time due to leaks. You should therefore inflate it to a pressure a little higher than the normal over time pressure.

**Maintenance Schedule**

→ Refer to page 6-136

## Handling the Jack

### WARNING

- Raising the vehicle with a jack could lead to an accident when carried out on soft or inclined surfaces. Ensure that you always carry out this operation on flat, solid surfaces.
- Do not place any objects above or below the jack while performing the jacking operation.
- Always apply the parking brake fully and correctly chock the wheels with the gearshift lever in the "R (reverse)" position for manual transmission models and "P" for automatic transmission models before jacking the vehicle. A vehicle blocked only with the parking brake could move, creating a very dangerous situation when the rear wheels are jacked up.
- To lock the steering wheel, in models with passive entry and start system, place the front wheels in a straight position, switch the power mode to "OFF", then open or close the driver side door. In models without passive entry and start system, place the front wheels in a straight position and remove the key from the starter switch.
- Ensure that there are no people or objects present in the vehicle before it is jacked up.
- In order to ensure safety, doors should never be opened and the engine should never be started during a jack-up operation.
- The jack must only be used at one of the specified jacking points. In addition, you must confirm that it makes good contact with the specified point.
- In order to provide extra safety should the jack slip, once a spare tire has been removed, it should be placed under the vehicle near the jack.
- Before starting a jacking operation, ensure that the jack and the jacking point to be used are clear of dirt, oil and grease. Failure to observe this precaution could lead to an accident should the dirt or oil cause the jack to slip.
- It might start moving when the engine power is transmitted to the rear axle even when one of the wheels on the axle is raised clear of the ground. Do not start the engine with any rear wheel in contact with the ground.
- If your vehicle is equipped with a differential lock system, it might start moving when the engine power is transmitted to the rear axle even when one of the wheels on the axle is raised clear of the ground. Do not start the engine with any rear wheel in contact with the ground.
- The jack provided with your vehicle must be used only for changing defective tires and fitting or removing tire chains. In order to ensure safety, furthermore, only one wheel should be jacked up at a time.

WARNING (Continued)

## WARNING (Continued)

- Do not use more than one jack at any one time.
- Lifting up both wheels at the same time is very dangerous. Be sure to jack up one wheel at a time.
- The jack supplied with your vehicle is specifically for that vehicle. Do not use it on another vehicle and never use another vehicle's jack.
- Be sure that the jack bar is tightly inserted into the jack handle before turning the handle and bar. Serious personal injury can result if the bar slips from the handle during the jacking procedure.
- Do not get under a vehicle and no person should place any portion of their body under a vehicle that supported by a jack. Failure to observe this precaution could lead to an accident if the jack were to slip.
- If the underside of the vehicle is to be worked on after jacking up, jack stands must be used to support the vehicle.



## Operating the Jack

### Raising the Vehicle

1. Assemble the jack bars and jack handle.

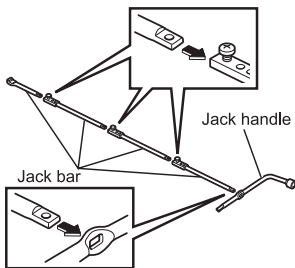

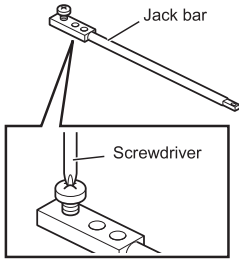

2. When assemble jack bars to each other, tighten joint bolt by hand or a screwdriver (Phillips side). Make sure that the concave side is facing the bolt side of the other bar before tighten the bolt.

**CAUTION**

- Make sure that each screw joint is tightened properly.

3. Insert the jack bar end into the jack socket.
4. Place the jack immediately below the jacking point and ensure that it is upright. The jack must be placed on a flat, solid surface.
5. Turn the jack handle, and check that the jack moves correctly.

**Front Wheel Jacking Points**

→ Refer to page 6-77

**Rear Wheel Jacking Points**

→ Refer to page 6-77

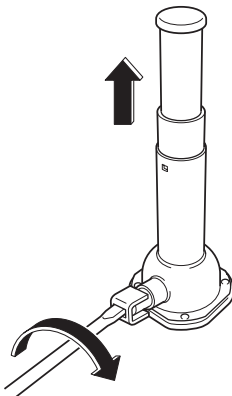

6. Raise the vehicle by turning the jack handle clockwise.
7. Confirm that the jack is in good contact with the jacking point, and then continue to raise the vehicle.

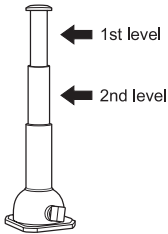
**⚠ WARNING**

- The jack has 2 levels. After completion of the 2nd level lifting, the handle becomes heavy to operate. At this time, stop lifting up with the jack. If lifting up is continued, the jack may be damaged. If the vehicle is lifted up with the jack excessively, the vehicle becomes unstable and very dangerous.

**Lowering the Vehicle**

Lower the vehicle by turning the jack handle counterclockwise to the ground.

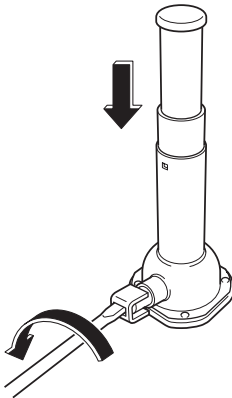

## Jacking Points

### WARNING

- Failure to position the jack as described could result in serious personal injury or vehicle damage caused by the vehicle slipping off the jack.

### Front Wheel Jacking Points

Apply the jack head to the flat part of the bracket on the frame side.

### Rear Wheel Jacking Points

Fit the jack adaptor to the top of the jack. Set the jack at a point within 90 mm (3.5 in) from the leaf spring under the axle tube. Align the recess on the jack adaptor to the curved surface of the axle tube center.

(For Arctic model)  
Front wheel jacking points

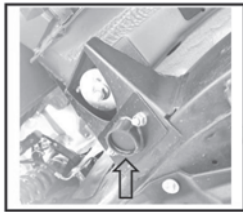

Front wheel jacking points

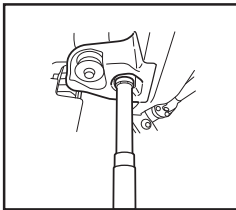

Rear wheel jacking points

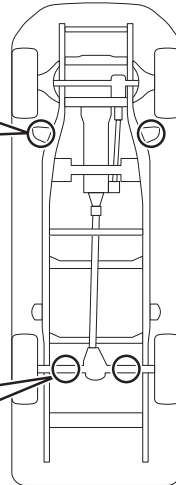
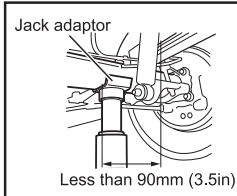

## Changing Tires

### Preparation

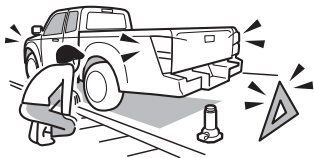

When you park the vehicle to change tires, choose a place listed below.

- Your vehicle does not hinder other traffic.
- The surface is level, flat and solid.
- You can change a tire safely.

When changing tires on a road, use the hazard warning flasher and triangle reflectors to alert other traffic to the presence of your vehicle.

Fully pull the parking brake lever, put the gearshift lever in the "R (reverse)" position for manual transmission models or put the selector lever in the "P" position for automatic transmission models. Chock both the front and back sides of the wheel diagonally opposite to the one to be changed with chocks (or stones, wood blocks, etc.). (Example: When changing the right rear wheel, chock the left front wheel.) Have the passengers get out of the vehicle.



### CAUTION

- Use a tire of the specified size and the same tread pattern as the one to be replaced.

## Removing a Wheel

 **WARNING**

- Always apply the parking brake fully and put the gearshift lever in the "R (reverse)" position for manual transmission models or put the selector lever in the "P" position for automatic transmission models and correctly chock the wheels before raising the vehicle. Applying only the parking brake is insufficient to prevent the vehicle from moving. When a rear wheel is jacked up, the vehicle blocked only by the parking brake would move, creating a very dangerous situation.
- Ensure that there are no people or objects present in the vehicle before it is jacked up.
- Never open doors or start the engine while jacking up the wheel. Do not try to look into the underside of the vehicle or get beneath the vehicle. This is very dangerous.
- To avoid danger in case of the jack slipping off, place the removed spare tire near the jack under the vehicle.
- Never apply oil or grease to the wheel bolts or nuts. Wheel nuts may loosen, causing the wheels to fall off and cause serious accidents.
- Never use heat to loosen tight wheel nuts. The application of heat to the hub can shorten the life of the wheel and may cause damage to wheel bearings.

 **CAUTION**

- The wheel is heavy. Carefully handle it to avoid getting hurt when removing and installing the wheel.
- Do not touch the engine, muffler, and exhaust pipe just after stopping the vehicle as they are very hot.
- Be careful for personal injuries when handling wheel ornaments.

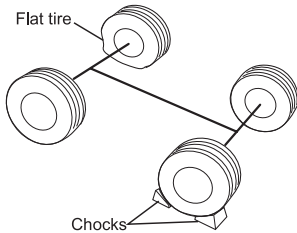

1. Firmly apply the parking brake and put the gearshift lever in the "R (reverse)" position for manual transmission models or put the selector lever in the "P" position for automatic transmission models. When changing a front wheel, chock the rear wheel diagonally opposite to the front wheel. When changing a rear wheel, chock the front wheel diagonally opposite to the rear wheel.
2. Firmly apply the head of the jack to the jacking point.

#### Handling the Jack

→ Refer to page 6-73

3. Raise the vehicle enough so that the tire not quite clear of the ground.
4. Using the wheel nut wrench, loosen the wheel nuts just enough so that the wheel remains stable in position. Do not remove the wheel nuts yet.



#### CAUTION

- Do not loosen the wheel nuts too much. The wheel bolts would be damaged.

5. Jack up the vehicle so that the tire is clear of the ground completely.
6. Remove all the wheel nuts that have been loosened, and then remove the wheel.



#### ADVICE

- Remove the wheel being careful not to damage the threads of the wheel bolts.
- Do not put the wheel with its design (outer) side down on the floor. It may cause scratch on the wheel surface.

7. For models with aluminum wheels, remove the wheel cover by pressing the wheel cover from the back side of the wheel.
8. Check the following parts: the disc wheel for deformation and damage such as cracks; the hub for excessive wear of the disc wheel fitting surface; and the wheel bolts and nuts for damage to the threads. If anything abnormal is found in the above parts, check other parts as well, and replace any defective part with a new one.

**Front Wheel Jacking Points**

→ Refer to page 6-77

**Rear Wheel Jacking Points**

→ Refer to page 6-77



## Installing a Wheel

 **WARNING**

- A disc wheel, wheel bolts or wheel nuts in any abnormal condition could break later, causing the wheel to be detached from the vehicle while driving.
- If you find anything abnormal with wheel bolts, wheel nuts or disc wheels when you check them, avoid driving the vehicle and contact the nearest Isuzu Dealer.
- Do not repaint any mating surfaces, wheel nut seating surfaces (tapered surfaces) and hub fitting surface of the disc wheel. Thick paint films would cause loosened or broken wheel bolts.
- Do not assemble the wheel in a slanted state or with the center of the wheel misaligned state.
- Never apply oil or grease to the wheel bolts or nuts. By applying them, nuts may become over-tightened and cause damage to the bolts. Wheel nuts or bolts may loosen, causing the wheels to fall off and cause serious accidents. If oil or grease is found on any bolt or nut, clean it off.

 **CAUTION**

- Change wheels only when the tire is clear of the ground. Otherwise, the wheel will be installed improperly and the operation of the vehicle will be affected adversely.
- Remove mud and rust from the hub fitting surface or wheel-to-wheel mating surfaces. Otherwise, the wheel might become loose while driving.

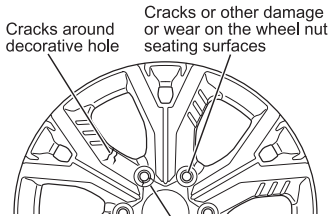
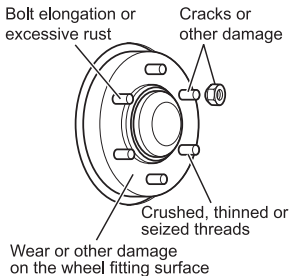
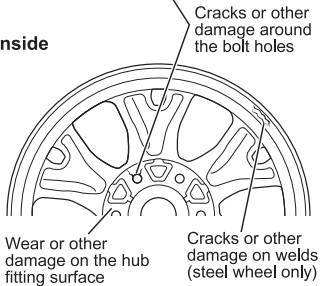
**Outside****Inside**

## 1. Check the disc wheel for the following:

- Cracks or other damage around the bolt holes and decorative holes
- Cracks or other damage or wear on the wheel nut seating surfaces (tapered surfaces)
- Cracks or other damage on welds (steel wheel only)
- Wear or other damage on the hub fitting surface

If you find anything abnormal with disc wheels when you check them, avoid driving the vehicle and contact the nearest Isuzu Dealer.

## 2. Check the parts on the vehicle side for the following points.

- Cracks or other damage on the wheel bolts and wheel nuts
- Wheel bolt elongation or excessive rust
- Crushed, thinned, or seized threads on the wheel bolts and the wheel nuts
- Wear or other damage on the wheel fitting surface

If you find anything abnormal with the parts on the vehicle side when you check them, avoid driving the vehicle and contact the nearest Isuzu Dealer.

 **CAUTION**

- Remove rust and dirt from a wheel bolt and nut, and turn the nut on the bolt. If the nut does not turn smoothly, the threads are defective.
- If the threads are defective, replace both wheel bolt and wheel nut as a set.
- If any wheel bolt is broken, change all the wheel bolts and wheel nuts on the wheel.

3. Remove rust, dust, and mud from the fitting surfaces of the disc wheels and hubs, the seating surfaces (tapered surfaces) of the wheel nuts, and the threads of the wheel bolts and nuts.

 **CAUTION**

- Clean the disc wheels to remove dirt and rust from the fitting surfaces of the disc wheels and hubs. Also clean the tapered portion of each nut. If you fasten the wheel nuts without removing dirt and rust, the wheel nuts would later loosen and the wheel might be detached from the vehicle while driving. This could be very dangerous.

4. For models with aluminum wheels, install the wheel cover by tapping the wheel cover into place with your hand after aligning the protrusions on the rear side of the wheel cover with the depressions on the wheel.
5. Install the wheel while aligning the bolt holes in the disc wheel with the wheel bolts.

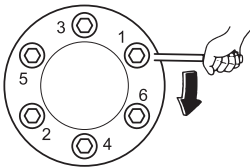
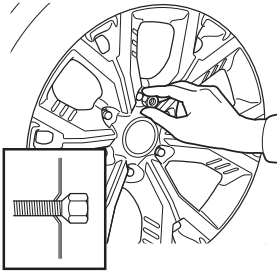

6. Screw in each wheel nut by hand until it touches the nut seating surface on the disc wheel, and then finger tighten all wheel nuts until the wheel is held in position without any looseness. Face the tapered end of wheel nuts inward.
7. Turn the bleeder screw of the jack counterclockwise to lower the vehicle slowly.
8. Tighten the wheel nuts in a diagonal sequence and in two or three passes.

**⚠ CAUTION**

- Some impact wrenches available in the market produce torques higher than the maximum torque specified for tightening the wheel nuts. If the wheel nuts are tightened with such an impact wrench, wheel bolts might be broken. Before using an impact wrench, check that the torque it produces conforms to the specification.
- When using an impact wrench, carefully adjust the air pressure regulator and select the tightening time. As a final step, tighten to the specified torque using a torque wrench.

9. Finally, tighten all wheel nuts using a torque wrench to the specified torque.

Tightening torque

**120 N·m (12 kgf m/87 lb·ft)**

**WARNING**

- Do not attach plastic wheel ornaments that are heavily damaged. These may fly off from the wheels of your vehicle and cause accidents when the vehicle is driven.
- Make sure to secure all tools, jacks and flat tires into their storage locations before driving in order to reduce the possibilities of personal injury due to a collision or sudden braking.

**ADVICE**

- After changing a tire, turn the steering wheel in both directions to make sure that the wheels do not interfere with the surrounding components. If you are unclear about any of this, please contact the nearest Isuzu Dealer.
- The tightening torque of the wheel nuts may decrease after tire replacement due to their initial settlement. Upon driving 50 to 100 km (31 to 62 miles) after a tire change, retighten the wheel nuts to the specified torque according to the instructions in the "Retightening Wheel Nuts" section in this chapter.

**Retightening Wheel Nuts**

→ Refer to page 6-87

## Retightening Wheel Nuts

Check the wheel nuts to make sure they are tightened to the specific torque by using a torque wrench.

Use the following methods to check loose wheel nuts. The tightening torque of the wheel nuts may decrease after a tire change or rotation due to their initial settlement. After driving 50 to 100 km (31 to 62 miles), be sure to retighten the wheel nuts to the specified torque.

### Tightening torque

**120 N·m (12 kgf m/87 lb·ft)**

Turn the wheel nuts in the tightening direction to the specified torque.

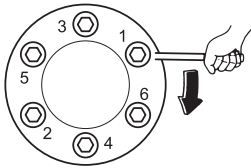

### WARNING

- If you find any abnormal conditions with the wheel nuts such as frequent loosening of retightened nuts, have your vehicle checked or serviced at the nearest Isuzu Dealer as soon as possible.

### CAUTION

- Fully engage the wheel wrench on a wheel nut in order to tighten the nut to the specified torque. However, do not use a pipe as a handle extension or your foot to apply force on the wrench. This would tighten the nut more than required and might damage components.
- Both under-tightening and over-tightening of wheel nuts may cause broken wheel bolts or cracked disc wheels and could lead to wheel detachment. Adhere to the specified tightening torques.
- When replacing a tire with a new one, use only a tire of the same type and size as the replaced tire; otherwise, driving safety could be affected. Avoid mixed use of different types or different size tires at all costs.

**Clutch Fluid (Manual Transmission Model)**

The tank of the clutch fluid is common with a tank of the brake fluid.

 **WARNING**

- If the clutch fluid gets in your eyes, rinse it off immediately with a large amount of water for 15 minutes or longer. Also, if still abnormality such as irritation is felt, seek medical attention.

 **CAUTION**

- Before refilling the tank, clean the area around the cap and fill clutch fluid from a clean container. Foreign objects getting in the tank will lead to a clutch system failure.
- Be careful not to let clutch fluid come in contact with skin. If fluid comes into contact with skin, wash away the fluid with water.
- Clutch fluid melts paintwork and vehicle component materials such as plastic, vinyl and rubber. It is also highly corrosive on metals. If it is spilled, immediately wipe the area clean or wash away the fluid with water.
- If skin irritation persists, check with a doctor.
- Inspect and change clutch fluid according to the Maintenance Schedule.
- Use only the specified clutch fluid.
- Clutch fluid readily absorbs moisture. Close the cap of the container tightly when storing it.
- Do not mix clutch fluid with fluids of a non-specified brand. Due to chemical reactions, any mixture of differently branded fluids will cause failure of the clutch system.
- If clutch fluid decreases too rapidly, there might be a problem in the clutch system or the brake system, or the brake pads or shoe linings may have worn out. Have your vehicle inspected by the nearest Isuzu Dealer immediately.

**Maintenance Schedule**

→ Refer to page 6-136

**Recommended Fluids, Lubricants and Diesel Fuels**

→ Refer to page 6-137

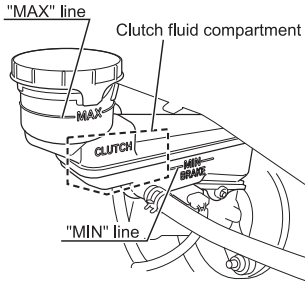

### Checking the Clutch Fluid Level

Confirm that the fluid level in the reserve tank is between the "MAX" and "MIN" lines. Be sure to use the clutch fluid compartment section when checking the "MIN" line section of the clutch fluid level. The clutch fluid level cannot be accurately checked if the clutch fluid level is checked with a method other than the clutch fluid compartment section.

If the fluid surface cannot easily be seen, rock the vehicle gently.

### Adding Clutch Fluid

If the level of clutch fluid has dropped below the "MIN" line, remove the clutch fluid tank cap and add fluid. Add the specified clutch fluid up to the "MAX" line.

Tighten the cap securely after the fluid has been added.

### Changing Clutch Fluid

Change the clutch fluid according to the Maintenance Schedule using the specified fluid. Since a clutch fluid change requires disassembly of the related components, have this service performed by your Isuzu Dealer.

## Automatic Transmission Fluid (Automatic Transmission Model)

Have inspection and replacement of the automatic transmission fluid performed at an Isuzu Dealer.

## Steering Wheel

## Checking the Steering Wheel

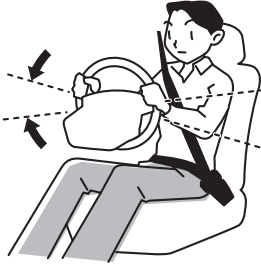

While the engine is idling, place the steering wheel in the straight forward position, then gently turn it to the left and right by hand, and check the play in the steering wheel as the peripheral distance to the point where the tires start moving.

Standard value  
(at the periphery of the steering wheel)

10 - 30 mm (0.39 - 1.18 in)



Grasp the steering wheel with both hands, and move it in the axial direction and also up and down, and left and right to see if there is any looseness.

Also, drive the vehicle and check for abnormal shaking of the steering wheel, steering pull, sluggish steering, or inability to return to the straight forward position.

**CAUTION**

- If the steering parts have excess play or looseness or if any abnormal condition is noted, have the steering system checked at the nearest Isuzu Dealer immediately.

## Power Steering Fluid (Hydraulic Power Steering Model)

The power steering fluid level must be checked and it must be changed according to the Maintenance Schedule.

Have replacement of the power steering fluid performed at an Isuzu Dealer.

### Maintenance Schedule

→ Refer to page 6-136

## Checking the Power Steering Fluid Level

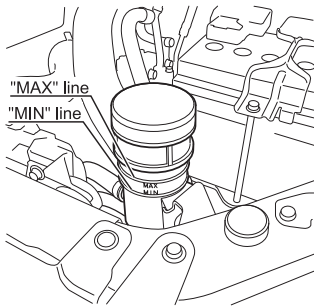

The reserve tank is located at the front of the engine compartment on the left. The fluid level is correct if it is between the "MAX" and "MIN" lines on the reserve tank. If the level is lower than the "MIN" line, add power steering fluid up to the "MAX" line. Furthermore, perform an inspection for power steering fluid leaks.

**Engine Hood** → Refer to page 6-11

## Adding Power Steering Fluid

### CAUTION

- Before adding fluid, clean the area around the cap and pour fluid from a clean jug or filler. Foreign matter getting in the tank will cause power steering system failure.
- Do not mix the recommended power steering fluid with fluids of other brands. Due to chemical reactions, any mixture of differently branded fluids will cause failure of the system.

Remove the reserve tank cap, and add power steering fluid up to the "MAX" line.



**OTHER SERVICE AND MAINTENANCE**

• Windshield Washer Fluid	6-94
• Windshield Wiper Blades	6-95
• Lights	6-102
• Handling the Battery	6-115
• Refrigerant	6-124

## Windshield Washer Fluid

### Windshield Wiper/Washer

Check the level of fluid in the windshield washer tank. In addition, spray windshield washer fluid and operate the windshield wipers to check for any areas that are not being properly wiped. At this time, also check the spraying condition of the washer fluid.

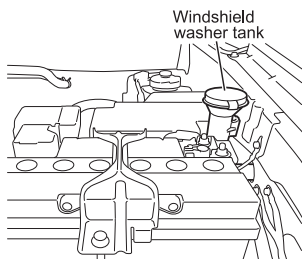

#### Refilling Windshield Washer Fluid

1. The windshield washer tank is located at the rear of the engine compartment on the left.
2. Open the cap and fill the tank with windshield washer fluid to the opening.



#### ADVICE

- Upon factory shipment, new vehicles contain only tap water in the washer fluid tank. Adjust the concentration of the fluid to suit your own usage.
- Follow the instructions provided with the windshield washer fluid regarding the ratio for mixing with tap water.
- Poor quality products, engine coolant, and soapy water must not be used. Failure to observe this precaution can result in nozzle blockage or damage to painted surfaces.
- The washer should never be used while the tank is empty. Operating the washer with the tank empty can result in motor damage.

## Windshield Wiper Blades

### Daily Checks

Spray windshield washer fluid and then operate the windshield wipers to check for any poorly wiped areas. In addition, confirm that the functions operate normally.



### NOTE

[For flat blade type]

- When the power mode is "OFF" (models with passive entry and start system) or the starter switch is in the "LOCK" position (models without passive entry and start system), the wipers may move slightly. This is caused by the vehicle's functions to protect the wiper blades from thermal degradation and is not a malfunction.
- When the power mode is switched to "ON" (models with passive entry and start system) or the starter switch is turned to the "ON" position (models without passive entry and start system), the wipers may move slightly. This is caused by the vehicle's functions to return the wipers to their normal home positions and is not a malfunction.

## Types of Wiper Blades

### Design blade type

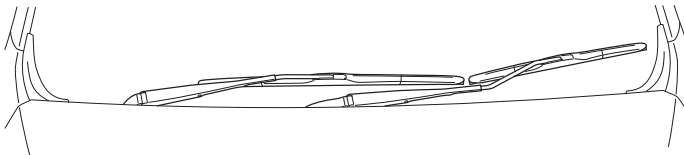

### Flat blade type

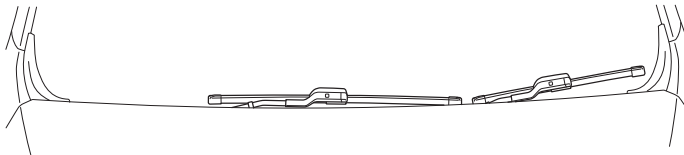

Depending on the type of wipers, how to replace the wiper blades and wiper rubber inserts differs. If you replace them incorrectly, the wipers, and surrounding parts, may be damaged. Before starting the replacement work, be sure to check the type of wipers.

**ADVICE**

[Flat blade types]

- The wipers are stored under the engine hood. Do not forcibly pull them out from under the hood manually. If you do, the wipers could be damaged. To stand the wiper arms up, first switch them to the service position.

**Switching to the Service Position**

→ Refer to page 6-98

**Switching to the Normal Position**

→ Refer to page 6-100

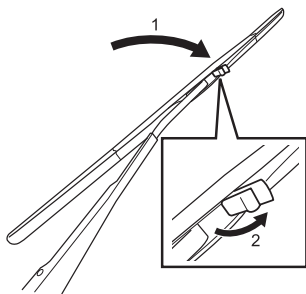
**Wiper Blade Replacement (Design Blade Type)****Removal**

1. Pull the wiper arm up to the vertical position.
2. Pull up the tab.

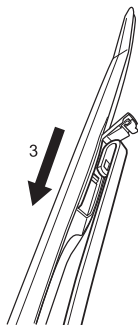

3. Slide the wiper blade in the direction of the arrow to remove it.

**Installation**

1. Attach the wiper blade to the arm.

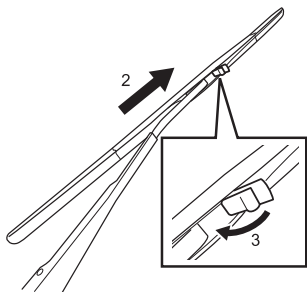
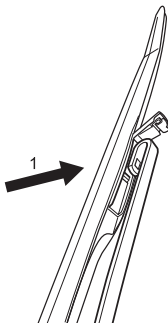

2. Slide the wiper blade in the direction of the arrow.
3. Push the tab in.

**ADVICE**

- Do not lower the wiper arm with its blade removed; the windshield glass may be scratched.
- Whenever a wiper blade has been attached, ensure that it is locked into place. Failure to observe this precaution can result in the wiper blade becoming dislocated when the windshield wiper switch is turned on.

### Wiper Blade Replacement (Flat Blade Type)

Service position

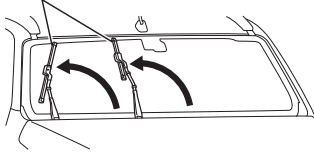

To replace the wiper blade, switch the wiper in the service position.



#### ADVICE

- Check that the engine hood is securely closed.

Engine Hood → Refer to page 6-11

#### Switching to the Service Position

1. Make sure that the windshield wiper switch is in the "OFF" position.
2. Switch the power mode to "ON", and to "OFF" (models with passive entry and start system), or turn the starter switch to the "ON" position, and to the "LOCK" position (models without passive entry and start system).
3. Pull the windshield washer switch toward you until the wiper arms move to the service position.

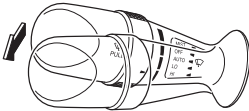
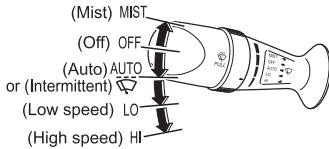

#### NOTE

- For approximately 1 minute after performing the operation in step 2, it is possible to switch the wiper position.

**Removal**

Raise the wiper arms up off the windshield. Press the lock button and slide the wiper blade in the direction of the arrow to remove it from the wiper arm.

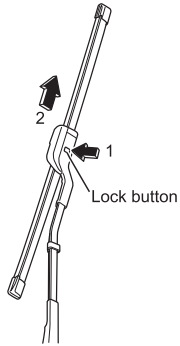
**Installation**

1. Slide the wiper blade in the direction of the arrow until you hear a clicking sound.

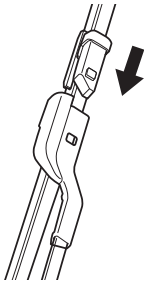

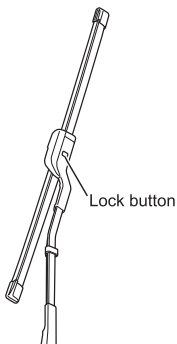

2. Confirm that the lock button is seated inside the hole position.

**ADVICE**

- Do not lower the wiper arm with its blade removed; the windshield glass may be scratched.
- Whenever a wiper blade has been attached, ensure that it is locked into place. Failure to observe this precaution can result in the wiper blade becoming dislocated when the windshield wiper switch is turned on.

**Switching to the Normal Position**

1. Return the wiper arms, which have been raised up, back to the windshield. Confirm that the wiper blades are in contact with the windshield.
2. The wiper arms automatically return to the normal position.

**ADVICE**

- Be sure to return the wiper arms to the windshield after they have been stood up. Moving the wiper arms while they are not in contact with the windshield could damage the wiper arms and the engine hood.

**NOTE**

- When the vehicle is driven with the wiper in the service position, the wiper is automatically switched from the service position to the normal position.

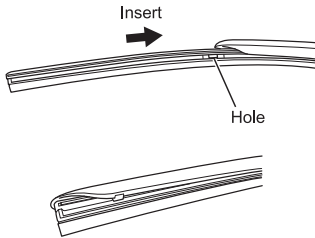
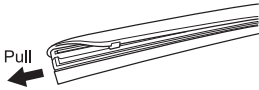
**Replacement of Wiper Rubber Insert (Design Blade Type)****Removal**

1. Remove the wiper blade from the wiper arm.
2. Pull the wiper rubber insert in the direction indicated by the arrow and extract it from the wiper blade.

**Installation**

1. Insert a new wiper rubber insert into the wiper blade.
2. Continue pushing in the wiper rubber insert until the wiper blade's hook engages with the hole in it, and then confirm that the rubber insert is securely held in place.
3. Attach the wiper blade to the wiper arm.

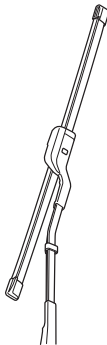
**Replacement of Wiper Rubber Insert (Flat Blade Type)****NOTE**

- On flat blade type, the wiper rubber cannot be replaced. When you replace the wiper rubber, replace the wiper blade as an assembly.

## Lights

### Inspecting Operation of Lights

Switch the power mode to "ON" (models with passive entry and start system) or turn the starter switch to the "ON" position (models without passive entry and start system), and then check the way in which the headlights, turn signal lights, other exterior lights, and interior lights come on or flash.

In addition, depress the brake pedal to confirm whether the stop lights come on, and shift the transmission to "R" position to confirm whether the back up lights come on. Also examine the lights for discoloration, damage, and looseness.

If the inspection finds any lights that do not come on, refer to "Before Replacing Lights" for an appropriate action.

#### **WARNING**

- Do not drive the vehicle with the exterior lights not working. This could result in an accident.

#### Before Replacing Lights

→ Refer to page 6-104

#### Front (LED headlight model)

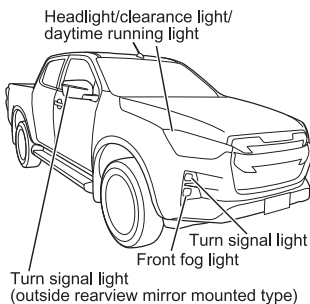

#### Front (Halogen headlight model)

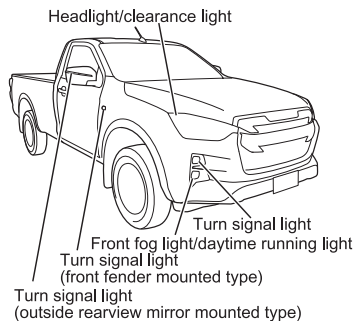

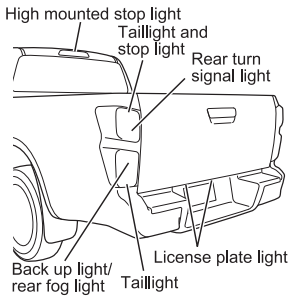
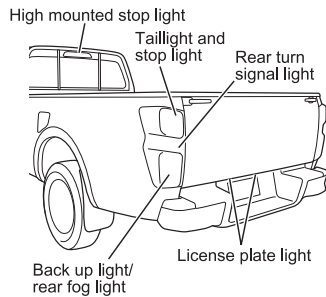
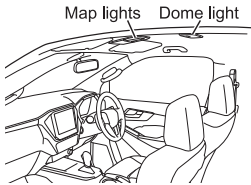
**Rear (LED stop/tail light model)****Rear (Except LED stop/tail light model)****Interior****NOTE**

- For the lights (lighting equipment) such as headlights, inside of the lens can mist up momentarily when driving in the rain or during the car wash. Also, the temperature difference between inside and outside of the lights can sometimes cause the water condensation inside the lens. This is not abnormal because this is the same phenomenon as the windshield or door glass fogs up when it rains. If it is demisted minutes after the light is turned on, things are normal.
- Be sure to adjust the headlight aim to prevent other drivers from becoming blinded. Have the headlight aim adjusted at the nearest Isuzu Dealer.

### Before Replacing Lights

If the inspection finds that a light needs to be replaced, check the following information.

#### Lights Requiring Replacement by Isuzu Dealer

The lights indicated below are difficult to replace, or their light unit assembly must be replaced. If replacement is necessary, contact the nearest Isuzu Dealer.

- LED headlights (High beam/low beam)
- Clearance lights/daytime running lights (LED headlight model)
- Clearance lights (Halogen headlight model)
- Front fog lights
- Daytime running lights (Front bumper mounted type)
- Turn signal lights (Front bumper mounted type)
- Turn signal lights (Outside rearview mirror mounted type)
- Taillights and stop lights (LED type)
- High mounted stop light
- Vanity mirror lights

#### Lights Which the User Can Replace

We recommend having an Isuzu Dealer replace bulbs because there is a risk of components being damaged. However, regarding the lights whose replacement procedures are described in the owner's manual, it is possible for the user to replace the bulbs. For the procedures to replace bulbs, refer to the following pages.



#### CAUTION

- Always switch the power mode to "OFF" (models with passive entry and start system) or turn the starter switch to the "LOCK" position (models without passive entry and start system) and place all the other switches to the off position before replacing the bulbs.
- Bulbs are hot immediately after they go out. When replacing the bulbs, avoid being burned by making sure they are fully cooled.
- Using bulbs with a wattage other than that specified could cause the bulb or the wiring to become hot. This could result in the warping of the lens and case, and it could also lead to the outbreak of fire. Refer to "Bulb Wattage" to prepare a new bulb.
- Halogen bulbs contain pressurized gas. Be careful when handling halogen bulbs as damaging or dropping them could cause an explosion.

**ADVICE**

- Do not touch the glass part of the bulb with your bare hands during replacement.
- If you feel uncertain during the procedure, stop performing the procedure and contact an Isuzu Dealer.
- When one bulb of a pair of lights, such as a headlight blows out, the other bulb is approaching the end of its useful life. We recommend that both be changed at the same time.

**NOTE**

- If the bulb has not blown out, the fault may be in the wiring. Have your vehicle inspected/serviced at your Isuzu Dealer as soon as possible.

**Bulb Wattage → Refer to page 6-106**

**Bulb Wattage**

Position	Lights		Bulb wattage
Front	Headlight	LED type	LED
		Halogen type (high beam/low beam)	60/55 W
	Clearance light/daytime running light *1		LED
	Clearance light *2		5 W
	Turn signal light		21 W (Amber)
	Fog light	LED type	LED
		Bulb type	55 W
	Daytime running light (front bumper mounted type) *2		13 W
Side	Turn signal light	Outside rearview mirror mounted type	LED
		Front fender mounted type	5 W
Rear	Taillight and stop light	LED type	LED
		Bulb type	5/21 W
	Turn signal light	Standard type	21 W (Amber)
		Horizontal type	21 W
	Back up light		21 W
	License plate light		5 W
	Rear fog light		21 W
High mounted stop light		LED	
Interior	Map lights		8 W
	Dome light		10 W
	Vanity mirror light		LED

\*1: LED headlight model.

\*2: Halogen headlight model.

**NOTE**

- Contact the nearest Isuzu Dealer when replacing lights that are not listed here.

## Replacing the Lights (Exterior Lights)

**Headlight Bulbs (Halogen Headlight Model)**

1. Open the engine hood and engage the support.

**Engine Hood** → Refer to page 6-11

2. Turn the cover counterclockwise to remove it.

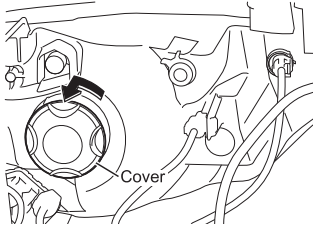

3. Disconnect the connector from the bulb. Remove the connector by pushing the tabs.

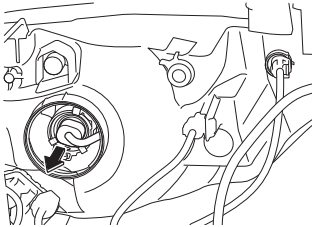

4. Release the bulb retaining clip. Remove the bulb.
5. Install a new bulb and secure it using the retaining clip.

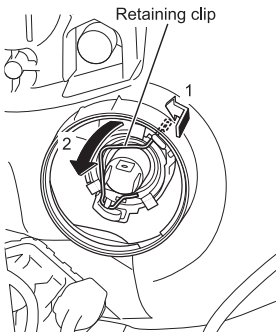
**ADVICE**

- Do not touch the glass of the bulb with your hand. Soiling the glass will cause the bulb to blow out.

6. Connect the connector. Attach a cover.

**ADVICE**

- If the cover is not firmly in place, water could get inside the headlight and lead to a malfunction.

### Turn Signal Light Bulbs (Front Fender Mounted Type)

1. While sliding the turn signal light (front fender mounted type) toward the front of the vehicle, slide and then pull it to expose the rear part of the light. Disengage the clip on the side of the rear of the light from the fender panel. When the clip has been removed, pull the light out while sliding it out toward the rear of the vehicle.

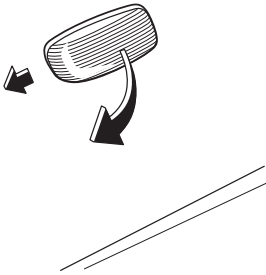

2. Loosen the socket by turning it counterclockwise.

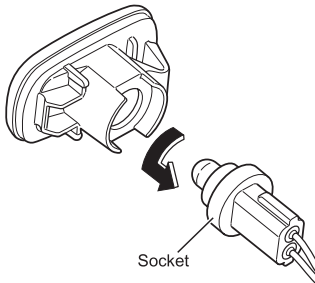

3. Pull out the bulb from the socket.
4. Insert a new bulb into the socket.
5. Insert the socket and turn it clockwise to lock it securely.
6. Insert the clip on the back of the rear part of the light into the fender panel. Push the front part of the light into the fender panel, and insert the clip on the back of the front part of the light in the fender panel.

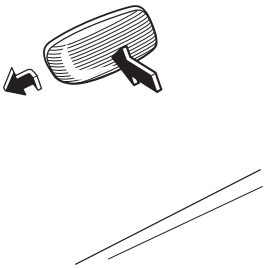

**Rear Combination Light Bulbs****NOTE**

- If the stop and tail light bulb is an LED specification, have the stop and tail light bulb replaced at an Isuzu Dealer.

1. Open the tailgate. Remove the 2 screws. Remove the rear combination lights.

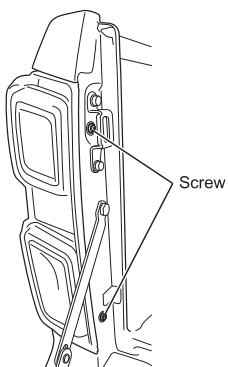
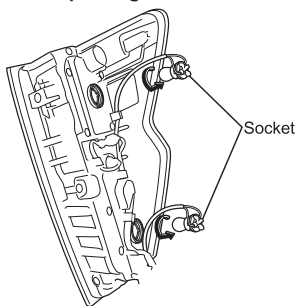
**LED stop/tail light model**

2. Turn the socket of the replacing bulb counterclockwise to remove it.

Except LED stop/tail light model

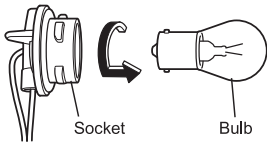
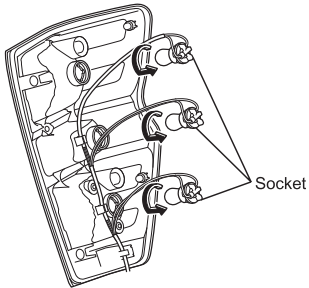

3. Pull out the bulb from the socket.

4. Insert a new bulb into the socket.

5. Insert the socket and turn it clockwise to lock it securely.



#### ADVICE

- If the socket is not locked securely, water could get inside the light and lead to a malfunction.

6. Install the rear combination lights, and then tighten the 2 screws to affix them.

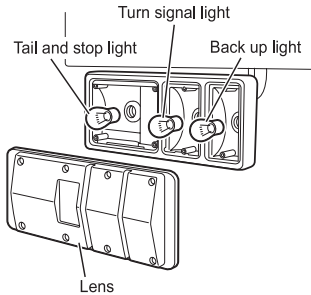

### Bulbs of Rear Turn Signal Lights, Taillights, Stop Lights, and Back Up Lights (Horizontal Type)

1. Loosen the screws and remove the lens.
2. Loosen the bulb by turning it counterclockwise while pressing on it.
3. To install the lights, perform the removal procedure in reverse.

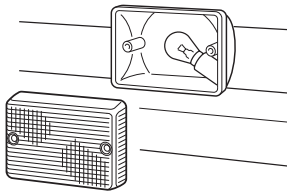

### Replacing the Rear Fog Light Bulb

1. Remove the screws retaining the lens and remove the lens.
2. Loosen the bulb by turning it counterclockwise while pressing on it.
3. To install the lights, perform the removal procedure in reverse.

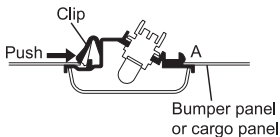

### License Plate Light Bulbs

1. Push the clip on the back of the license plate light towards "A" to release the lock.
2. When the clip lock has been released, push the clip to remove the license plate light.

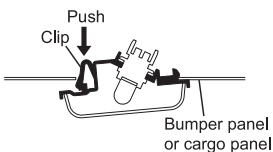

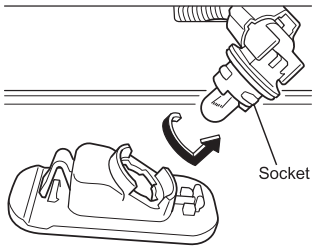

3. Loosen the socket by turning it counterclockwise.

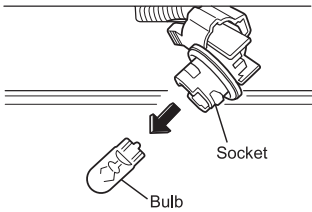

4. Pull out the bulb from the socket.

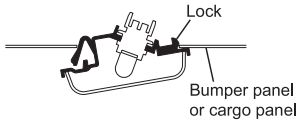

5. Insert a new bulb into the socket.
6. Insert the socket and turn it clockwise to lock it securely.
7. Insert the license plate light into the bumper panel or cargo panel.

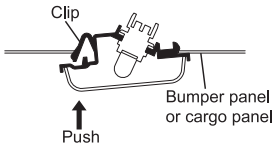

8. Push the license plate light at the clip into the bumper panel or cargo panel to install the clip.

## Replacing the Lights (Interior Lights)

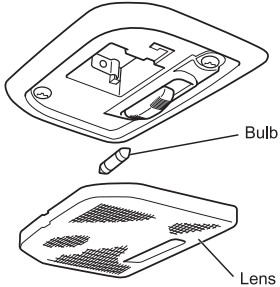
**Dome Light Bulb**

1. Use a flat-head screwdriver or similar tool to remove the lens. Remove the bulb.
2. To install the lights, follow the removal procedure in reverse.

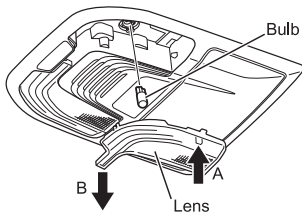
**Map Light Bulbs**

1. Pull out the "B" section while pressing the "A" section of the lens, and remove the lens.
2. Remove the bulb.
3. Install a new bulb, and then install the lens.

**ADVICE**

- When removing and installing the lens, do not apply excessive force to the lens.

## Handling the Battery

### DANGER

- Usage or charging of the battery when the battery fluid is below the lower level line can accelerate deterioration and give rise to dangerous situations such as the generation of heat and even explosion.
- If battery fluid should come in contact with an eye, immediately wash it out using a large amount of water and continue washing for at least 5 minutes. Following this, contact a doctor for a medical examination. If fluid adheres to any part of the body, wash it off using a large amount of water and contact a doctor for a medical examination.
- When using tools or other metal objects in the vicinity of the battery, take care to prevent them from coming into contact with the positive terminal. As the vehicle itself will conduct electricity, any such contact can result in a short-circuit and a highly dangerous electric shock.
- A vehicle battery generates extremely flammable hydrogen gas. For this reason, operations producing sparks or requiring the usage of an open flame must never be carried out near a vehicle battery. Failure to observe this precaution can result in explosion if the hydrogen gas ignites. Whenever wiping up battery fluid, a damp cloth should be used.

### WARNING

- Always stop the engine whenever the battery is to be inspected.
- Dilute sulfuric acid is used as the battery fluid. Wear protective goggles when handling the battery. Special care must be taken to ensure that this fluid does not come into contact with skin, clothing, or the vehicle body.
- Battery fluid should never be filled beyond the upper level line. Failure to observe this precaution can result in battery fluid spillage and corrosion of battery terminals and other components. Any spilled battery fluid should be immediately washed away with water.
- Do not allow your face or head to come close to the battery except when absolutely necessary.

WARNING (Continued)

**WARNING (Continued)**

- When disconnecting cables, switch the power mode to "OFF" (models with passive entry and start system) or turn the starter switch to the "LOCK" position (models without passive entry and start system), wait at least 3 minutes, and then disconnect the cables starting with the negative cable from the terminals. If the negative cable is disconnected within 3 minutes, the electronic control system of the vehicle may malfunction. When reconnecting them, the negative cable should be reconnected last.
- Be careful not to inhale the hydrogen gas that emits from the battery.
- Recharge the battery in a well-ventilated area. Do not recharge the battery in an enclosed room, etc.
- Wash your hands after handling battery posts, terminals and related accessories.
- Be sure to keep the battery away from children.

**ADVICE**

- Whenever battery fluid has been added, the battery should be recharged (by driving the vehicle). In winter months in particular, battery fluid can freeze and damage the battery case if you fail to recharge the battery.
- If the battery fluid level continues to drop at an unusually fast rate, have an inspection carried out immediately by the nearest Isuzu Dealer.

**NOTE**

- In models that can close the driver's window in automatic mode, when the battery has been reconnected, perform the following initialization settings in order to operate the driver's power window properly.
  - Open the driver's window halfway. Pull up the driver's window switch to fully close the driver's window and then keep the switch in this position for 2 seconds.

## Battery Handling Precautions

Keep the battery clean. If the battery is left in a dirty condition, contaminants can get mixed into the battery fluid, the battery plates can be damaged, short circuits can occur on the top surface of the battery and the battery's service life can be reduced.

### Models with passive entry and start system

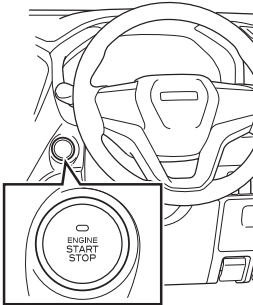

### Models without passive entry and start system

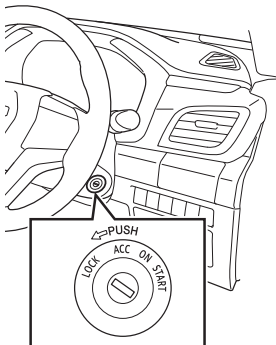

### When Performing Inspection or Maintenance

Before starting inspection and maintenance of the battery or other parts of the electrical system, switch the power mode to "OFF" (models with passive entry and start system) or turn the starter switch to the "LOCK" position (models without passive entry and start system), wait at least 3 minutes, and then disconnect the negative cable from the negative terminal. If the negative cable is disconnected within 3 minutes, the electronic control system of the vehicle may malfunction.

There is a danger that electrical components could be damaged if inspection or maintenance is carried out if the battery remains connected.

### Engine Start/Stop Button (Models with Passive Entry and Start System)

→ Refer to page 4-112

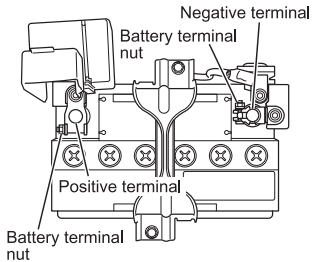

### Disconnecting the Battery Cables

When the battery is to be removed, disconnect the battery cables.

1. Switch the power mode to "OFF" (models with passive entry and start system) or turn the starter switch to the "LOCK" position (models without passive entry and start system).
2. Wait at least 3 minutes.
3. Loosen the battery terminal nut, and then disconnect the negative cable from the terminal.
4. Loosen the battery terminal nut, and then disconnect the positive cable from the terminal.

### WARNING

- If the battery cable remains connected to the negative terminal, any contact made by tools and the like between the positive terminal and the vehicle body could lead to a short-circuit and dangerous electrical shocks. The electrical system can also be damaged.
- Do not tilt the battery.

### CAUTION

- If the negative cable is disconnected from the negative terminal on the battery within 3 minutes after switching the power mode to "OFF" (models with passive entry and start system) or turning the starter switch to the "LOCK" position (models without passive entry and start system), the electronic control system of the vehicle may malfunction.

### ADVICE

- In models with negative terminal with intelligent battery sensor, when removing the negative terminal, loosen the battery terminal nut and remove the intelligent battery sensor while keeping the cable attached. (Do not loosen any nuts other than the battery terminal nut.)

### Removing the Battery

1. Remove the fixing bolts and holder that secure the battery in place.
2. Remove the battery from the vehicle.

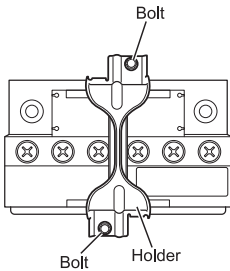

### Charging the Battery

1. Place the battery to a location with good ventilation and take off the battery caps.
2. Charge the battery using a battery charger.



### DANGER

- Do not use open flames in the vicinity of the battery when it is being charged. Hydrogen gas is generated by the battery during the charging process; accordingly, failure to observe this precaution can result in fire or explosion.



### ADVICE

- Be sure to disconnect the battery cables when charging. Failure to do so could result in vehicle breakdown.
- Whenever a charger is being connected to or disconnected from a battery, ensure that it is turned off.

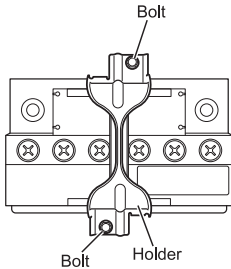

### Installing the Battery

1. Install the battery. Ensure that the battery is oriented correctly and placed so as to be seated correctly without any looseness.
2. Install the holder and fixing bolts.

### Positive terminal

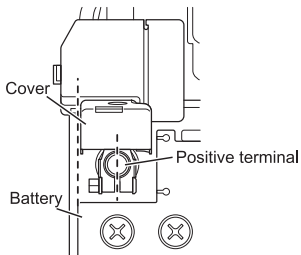

### Negative terminal

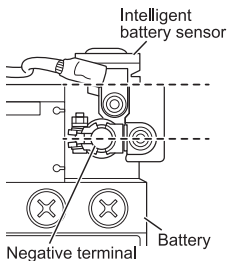

### Connecting the Battery Cables

When connecting the battery cables, start with the positive terminal and then connect the negative terminal.



### ADVICE

- When connecting the positive cable, install with the battery and terminal aligned side-by-side (as shown in the diagram). Also, return the positive terminal cover to its closed position after connecting the cable.
- When connecting the negative cable, install with the battery and terminal aligned side-by-side (as shown in the diagram). In addition, in models with intelligent battery sensor, check that the intelligent battery sensor is not in contact with any surrounding parts after connecting the cable.

Connect the cable to the terminal, and then tighten the battery terminal nut.

**CAUTION**

- Take care to avoid mixing up the positive and negative terminals when connecting battery cables. Incorrect connection to these terminals can result in flow of excessive current and burnout of the generator or vehicle wiring.
- In models with passive entry and start system, the power mode cannot be switched when the battery has been removed. The power mode that was being used before the battery was removed is stored in the passive entry and start system, so if the battery is reconnected, the power mode may be set to "ON". When the battery is to be removed, switch the power mode to "OFF", wait at least 1 minute, and then remove the battery.

**ADVICE**

- When installing the battery in your vehicle, ensure that it is oriented correctly and securely fastened without any looseness. If the battery is not installed correctly, the battery case and battery plates can be damaged as a result of vibrations during driving.

**NOTE**

- In models with passive entry and start system or keyless entry system, the map light and dome light may not illuminate if the battery terminal is connected with a door open. If this occurs, the lights can be illuminated by closing the doors once or by switching the power mode to "OFF" (models with passive entry and start system) or turning the starter switch to "LOCK" position from the "ACC" or "ON" position (models with keyless entry system).
- In models with electronic stability control (ESC), the ESC warning light may turn on when the battery cables are disconnected or the battery voltage is low. The ESC function turns off while the ESC warning light is on, but the ESC warning light will turn off by driving the vehicle normally for a while, then the ESC function will resume. If the ESC warning light remains on even after driving for a while, contact the nearest Isuzu Dealer.

**Using the Battery as a Direct Power Source**

The battery should not be used as a direct source of 12 V power.

If your battery must be used as a direct power source, please consult with your Isuzu Dealer.

## Checking the Battery Fluid Level

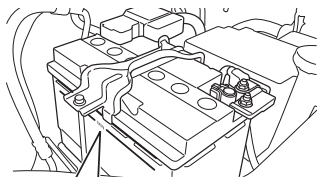

### Daily Check

Confirm whether the level of fluid inside the battery case is within the specified range.

The surface of the battery fluid should be between the upper level and lower level lines. If the surface of the fluid cannot easily be seen, rock the vehicle gently.

### Filling Battery Fluid

If the battery fluid level is below the lower level line, remove the cap and add distilled water up to the upper level line. After refilling, firmly attach the cap.



### WARNING

- Battery fluid should never be filled beyond the upper level line. Failure to observe this precaution can result in battery fluid spillage and corrosion of battery terminals and other components. Any spilled battery fluid should be immediately washed away with water.



### ADVICE

- Whenever battery fluid has been added, the battery should be recharged (by driving the vehicle). In winter months in particular, battery fluid can freeze and damage the battery case if you fail to recharge the battery.
- If the battery fluid level continues to drop at an unusually fast rate, have an inspection carried out immediately by the nearest Isuzu Dealer.

### Checking the Specific Gravity of Battery Fluid

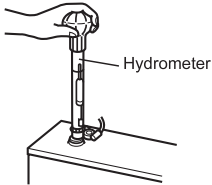

1. Check the specific gravity of the battery fluid using a hydrometer. If the specific gravity is too low, the battery should be charged.

Specific gravity at a fluid temperature of  
20 C (68 F)

1.27 - 1.29

### Checking the Battery Terminals

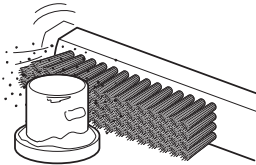

1. Check the terminals for looseness, cracks and corrosion. If there are cracks at the terminal, have inspection and replacement performed at an Isuzu Dealer.
2. If a terminal is found to be corroded and coated in white powder, wash this away with warm water and then wipe fully dry. Excessively corroded terminals should be polished using a wire brush or sandpaper.
3. When you have finished cleaning the terminals, apply a thin layer of grease and securely connect the battery cables, taking care to ensure that they are tight.  
See "When the Battery Goes Flat" regarding steps to be taken should the battery be completely discharged.

#### When the Battery Goes Flat

→ Refer to page 7-16

## Refrigerant

The air conditioning system will not be able to cool the cab interior effectively if the refrigerant level is low. Accordingly, the refrigerant level must be topped up whenever necessary.

Please contact your Isuzu Dealer whenever refrigerant must be added.



### ADVICE

- Operating the air conditioning while the refrigerant level is too low leads not only to poor cooling performance but also to air conditioning system damage.
- This vehicle uses the new refrigerant HFC-134a (R-134a) in the air conditioning system. No other type of refrigerant can be used. In order to protect the environment, care must be taken to ensure that refrigerant gas is never released into open air. When refrigerant must be replaced, therefore, please contact your Isuzu Dealer or other service facility equipped with a gas recovery installation system.

**INTERIOR AND EXTERIOR MAINTENANCE**

• Exterior Maintenance	6-126
• Interior Maintenance	6-130

## Exterior Maintenance

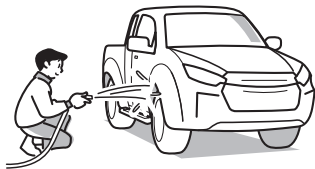

### Washing

If the vehicle is operated with foreign material adhering to the exterior, this material may react chemically with paint or plating, resulting in staining, discoloration, rusting or corrosion of components. Also, the material may become trapped within mechanical components, adversely affecting their functions or forming an aerodynamic resistance. In the following cases, therefore, the vehicle must be washed and all foreign matter removed.

- When soot, iron powder, dead bugs, bird droppings, pollen, tree sap or oily matter from coal tar and smoke has adhered to painted surfaces.
  - When the vehicle has been driven in coastal areas.
  - When the vehicle has been driven on roads where road chemicals have been applied.
  - When a large amount of mud or dirt has adhered to the exterior.
1. Fully turn on the tap, and wash out the undercarriage and suspension.
  2. Close all openings and wash the cab and cargo body panels using a neutral detergent.
  3. Clean wheels and tires using a brush and detergent.
  4. After washing away all remaining detergent, use a shammy or other clean cloth to fully remove all moisture and water droplets.

 **WARNING**

- When cleaning the bottom of the vehicle or chassis, be careful so as to prevent burns and injuries. The area around the engine, muffler, and exhaust pipe are extremely hot immediately after vehicle operation, so wait until the vehicle has cooled down before cleaning. Otherwise, you could be burned.

 **CAUTION**

- For models with the automatic windshield wiper, be sure to set the windshield wiper switch to the "OFF" position. When the windshield wiper switch is in the "AUTO" position, the wipers may operate unexpectedly and cause injury or damage the wipers.
- Do not apply water directly in order to clean the cab interior. Failure to observe this precaution can result in malfunction or breakdown of electronic control units and electrical components, or in rusting of the cab floor.
- Do not apply water from a high-pressure washer nozzle directly to the electric connectors. Failure to observe this precaution can lead to faulty operation of the electrical system.
- Do not point the car wash nozzle at the tail end of the exhaust pipe. Water splashing on the sensor in the exhaust pipe could cause a malfunction.

 **ADVICE**

- Do not use solvents, gasoline, kerosene, benzene, or thinner, etc., to clean the vehicle exterior.
- If an automatic car wash is used with vehicles having dark or metallic coating, the painted surfaces can be damaged by the brushes, lose their luster or be very noticeably scratched.
- Do not direct a large amount of water at the air inlet openings.
- Do not apply water to the engine compartment or at electrical components. Failure to observe this precaution can lead to a poorly starting and operating engine and problems in the electrical system.
- Ensure that mirrors and the antenna are retracted before washing the vehicle.
- If an automatic car wash must be used, avoid a high-temperature, high-pressure type machine. Failure to observe this precaution can lead to heat deformation and breakage of plastic components, or to water leaks into the cab.

ADVICE (Continued)

**ADVICE (Continued)**

- When using an automatic car wash, ensure that a distance of at least 0.4 m (15.75 in) is maintained between the nozzle and the vehicle, and when washing door windows, that the spray is perpendicular to the surface of the glass.
- Ensure that all detergent is fully washed and wiped away. Particularly in the case of strong alkaline detergents (typically those for industrial uses), there is a danger that hairline cracks can develop in lighting-cluster lenses if the vehicle is operated without detergent being fully wiped away. Always read the detergent manufacturer's instructions carefully before use.
- Airborne dirt that adheres to plastic front bumpers as a result of rain, for example, can be difficult to remove. In such a case, use a commercially-available cleaner to clean away the dirt, and then apply a wax for use with plastic components.
- For flat blade types, the wipers are stored under the engine hood. Do not forcibly pull them out from under the hood manually. If you do, the wipers could be damaged. To stand the wiper arms up, first switch them to the service position.

- Windshield Wiper and Windshield Washer Switch** → Refer to page 4-131
- Switching to the Service Position**  
→ Refer to page 6-98
- Switching to the Normal Position**  
→ Refer to page 6-100

**Vehicle Storage**

In order to maintain your vehicle's attractive appearance for as long as possible, special consideration must be given to its storage location.

If the vehicle is stored or kept for an extended period of time in any of the following locations, a chemical change may occur in the paintwork, resulting in staining, discoloration, rusting, and corrosion of components.

- Locations where a large amount of oily matter, soot, heavy smoke or metal powder can adhere to the vehicle.
- Areas around pharmaceutical plants and other facilities that discharge chemical matter.
- Coastal areas
- Locations where a large amount of dead bugs, bird droppings or tree sap can adhere to the vehicle.

### Waxing

Painted and chrome-plated surfaces should be waxed once or twice a month, or whenever water is being poorly repelled on the surfaces. Ensure that wax is not applied in direct sunlight, and that the temperature of the painted surface is no more than 40 C (104 F).

Always follow the instructions provided with your wax product.



#### CAUTION

- Wax must not be applied to the windshield. Failure to observe this precaution can result in irregular reflection of light, impairing your view.



#### ADVICE

- Do not use wax containing abrasive material. Failure to observe this precaution can lead to scratching of painted surfaces or plastic components.
- The application of wax to rubber component surfaces can result in permanent whitening.



### Windshield Care

If not fully cleaned by the windshield wipers, the windshield should be cleaned using Isuzu genuine glass cleaner.



#### CAUTION

- For models with the automatic windshield wiper, be sure to set the windshield wiper switch to the "OFF" position.  
When the windshield wiper switch is in the "AUTO" position, the wipers may operate unexpectedly and cause injury or damage the wipers.

**NOTE**

- For models with the automatic windshield wiper, do not use any water repellent coating agents on the windshield. Otherwise, the rain and light sensor cannot accurately sense rain and the automatic windshield wiper may not operate properly.

**Windshield Wiper and Windshield Washer Switch** → Refer to page 4-131

## Interior Maintenance

Remove dust and dirt from the interior of the cab using an automotive cleaner or vacuum cleaner, and gently wipe surfaces clean using a cloth wet with warm or cold water.

**WARNING**

- When cleaning the interior of the cab, water should never be sprayed directly. Failure to observe this precaution can lead to vehicle malfunction and possibly to fire if water should enter the audio system or other electrical components located underneath the floor carpet.
- Do not use organic solvents such as petroleum ether and gasoline or abrasive cleaners to clean the seat belts. In addition, seat belt webbing should be neither bleached nor redyed. Failure to observe these precautions can lead to the performance or strength of the seat belts being impaired. In the case of a collision, therefore, the belts could be insufficiently effective, and serious life-threatening injuries could result. When cleaning, use warm water in which a small amount of neutral detergent has been dissolved to gently wipe the seat belts.
- Keep the seat belts in a clean, dry condition.

**CAUTION**

- Do not use organic solvents such as mineral oil, benzene, thinner, or gasoline, nor acid or alkaline solvents or fatty acid ester. Failure to observe this precaution can result in discoloration, staining, or damage. It should be noted that certain types of cleaning products contain these compounds. Be sure to read cleaning product labels carefully.
- Do not let perfume, cosmetics or air fresheners (liquid, solid, gel or plate types) direct come into contact with or spill onto interior components such as the air conditioning or audio system. Compounds contained in these products can cause discoloration, staining, peeling of paint, or damage.
- Glass cleaners that contain these compounds must not be used to clean the inside of the windshield or window glass. To clean the glass, wipe using a cloth wet with warm or cold water.
- For models with a rear defogger, when cleaning the interior of the backlight glass, lightly wipe along the defogger wires using a wet cloth to avoid disconnecting the rear defogger. Use of glass cleaner, etc. may cause the defogger to become inoperative.

**ADVICE**

- Do not apply a silicon-based spray to electrical components such as the audio system or switches. It may cause faults with the points of contact.

### Seat Belt Care

A dirty seat belt can develop retracting problems, and for this reason, regular inspection and upkeep are required.



#### CAUTION

- Seat belt webbing can lose its strength when bleached or redyed, or when cleaned using gasoline, paint thinners or other volatile substances.
- Do not disassemble the seat belt mechanism in order to remove any foreign material or objects that may have entered the buckle. Instead, arrange for inspection and maintenance to be carried out by your Isuzu Dealer.

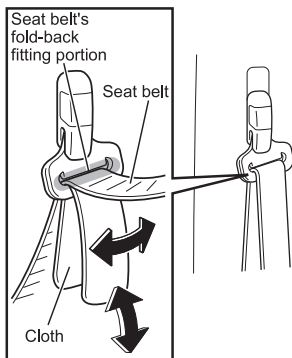

#### Cleaning a Seat Belt's Fold-back Fitting Portion

1. Fold a piece of cotton cloth, absorbent gauze, or the like of approximately 50 mm (2 in) in width into a rectangle.
2. Mix one part neutral detergent into approximately twenty parts warm water.
3. Wet the cloth in the detergent mixture, pass it through the fold-back fitting portion of the belt, and slide it back and forth and laterally until dirt can no longer be seen.
4. Remove the cloth, remove moisture from the fitting portion of the belt using a dry cloth, and then allow it to dry naturally out of direct sunlight.
5. Check to be sure the seat belt retracts and pulls out correctly.



#### ADVICE

- Avoid using anything like a tool to pass the cloth through the fold-back fitting portion or try to remove stubborn dirt. Using such an object can result in plastic parts or seat belt webbing damage.

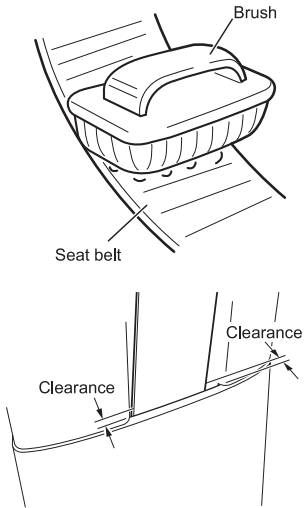

### Cleaning a Belt Webbing

1. Fully extract the belt and examine for any difference in color between the front and back surfaces.
2. Mix one part neutral detergent into approximately twenty parts warm water.
3. Wet a nail brush or another similar brush having soft bristles (of nylon or the like) in warm water, and use this to clean away dirt.
4. Wipe the seat belt dry using a dry cloth, and then allow it to dry naturally out of direct sunlight.
5. Check to be sure the seat belt retracts and pulls out correctly.



### ADVICE

- If the above-described upkeep operations do not improve the operation of the seat belt through the retractor, there is a possibility that the belt is making contact with the door pillar trim. In this case, arrange for inspection and maintenance to be carried out by your Isuzu Dealer.
- If the belt is not winding and unwinding correctly, or if inspection reveals problems such as loose mountings, metal parts deformation, webbing damage, fraying or discoloration, arrange for replacement to be carried out by your Isuzu Dealer.

### Leather Seat Care

**NOTE**

- Regarding the purchase of leather seat care products (cleaners, etc.), please contact your Isuzu Dealer.

1. Remove any dust and sand with a vacuum cleaner or a brush.
2. Wipe off stains using a soft cloth moistened with a diluted detergent (consisting of neutral detergent for wool diluted to about 5%).
3. Wipe off any detergent remaining on the surface using a cloth dipped in fresh water and then tightly wrung.
4. Wipe off any moisture on the surface with a soft, dry cloth, and allow it to dry in well-ventilated shade.

### Fabric Seat Covering and Carpet Care

Remove dirt and dust using a home-use electric vacuum cleaner.

Do not remove the carpet. Use standard household cleaning products and methods to remove stains from food, drink and the like.

Be sure to use neutral detergents or cleaning products indicated as higher alcohol based detergents.

MAINTENANCE DATA

---

• Inspection and Maintenance

6-136

---

**Inspection and Maintenance**

For safe and economic driving, be sure to have your vehicle inspected and serviced regularly according to the schedule prescribed by the dealer.

**Maintenance Schedule**

To drive your vehicle safely and at minimum cost, it is essential to have your vehicle regularly inspected and serviced at your Isuzu Dealer as per the specified maintenance schedule.

Contact your Isuzu Dealer for inspection that requires disassembly and/or special equipment.

For Inspection and Maintenance Schedules please refer to:

[www.isuzu.co.za/complete-care/servicing](http://www.isuzu.co.za/complete-care/servicing)

## Recommended Fluids, Lubricants and Diesel Fuels

It is extremely important to select correct lubricants and diesel fuels so that your Isuzu vehicle demonstrates its full performance over the years. Top up the lubricants in accordance with the Maintenance Schedule specified for your vehicle. Use the Isuzu genuine lubricants or those recommended in the list below. Also, do not use additives other than those specified. The lubricant change intervals specified in the Maintenance Schedule and the terms and conditions of the new vehicle warranty assume the use of the Isuzu genuine or Isuzu recommended lubricants listed below.

Also, select the viscosity appropriate for the temperature at which your vehicle operates.

### Engine Oil and Gear Oil Viscosity Charts

→ Refer to page 6-141

LUBRICATION	MAKE	BRAND	GRADE		
			API	ACEA	JASO
Diesel engine crankcase	<b>ISUZU</b>	<b>BESCO DURAMAX (10W-30)</b>	<b>CH-4</b>	—	—
		<b>BESCO MULTI Z CH-4 (10W-30)</b>	<b>CH-4</b>	—	—
	Chevron/Texaco/Caltex	Delo Gold Ultra (15W-40)	CI-4	E7	DH-1
	Chevron/Texaco/Caltex	Delo Sports Synthetic Blend (10W-30)	CI-4	E7	DH-1
	Elf	Diesel 750 CR (10W-30)	CI-4	E7	—
	ExxonMobil	Delvac Ultra Ultimate Defense (5W-40)	CI-4	E7	DH-1
	ExxonMobil	Delvac Modern Super Defense (10W-30), (15W-40)	CI-4	E7	DH-1
	ExxonMobil	Delvac 1 (5W-40)	CI-4	E7	DH-1
	ExxonMobil	Delvac MX (10W-30), (15W-40)	CI-4	E7	DH-1
	Shell	Rimula R4X (15W-40)	CI-4	E7	DH-1
	Shell	Rimula R4 Multi (10W-30)	CI-4	E7	DH-1
	Total	Rubia TIR 7400 HZX (15W-40)	CI-4	E7	DH-1
	Total	Rubia TIR 9200 FE (5W-30)	CI-4	E4	—
Manual transmission	<b>ISUZU</b>	<b>BESCO TRANSAXLE (5W-30)</b>	—	—	—
Transfer case	<b>ISUZU</b>	<b>BESCO TRANSAXLE (5W-30)</b>	—	—	—
	Chevron/Texaco/Caltex	Delo 400 MGX (15W-40)	CJ-4	E9	DH-2
	Chevron/Texaco/Caltex	Delo Gold Ultra (15W-40)	CI-4	E7	DH-1
	Elf	Performance PRO 700 (15W-40)	CI-4	E7	—
	ExxonMobil	Delvac Modern Full Protection (15W-40)	CK-4	E9	DH-2
	ExxonMobil	Delvac MX ESP (15W-40)	CK-4	E9	DH-2
	ExxonMobil	Delvac Modern Super Defense (15W-40)	CI-4	E7	DH-1
	ExxonMobil	Delvac MX (15W-40)	CI-4	E7	DH-1
	Shell	Rimula R4X (15W-40)	CI-4	E7	DH-1
Total	Rubia TIR 7400 HZX (15W-40)	CI-4	E7	—	
Automatic transmission	<b>ISUZU</b>	<b>ISUZU ATF WSI</b>	—	—	—

**ADVICE**

[Lubrication for manual transmission]

- It is recommended to use Isuzu genuine oil "BESCO TRANSAXLE(5W-30)". If a manual transmission oil other than Isuzu genuine oil "BESCO TRANSAXLE (5W-30)" is used, there may be differences in the transmission noise, shift feeling, and fuel efficiency, depending on the characteristics of the oil and/or the operating conditions.

[Lubrication for automatic transmission]

- It is recommended to use Isuzu genuine fluid "ISUZU ATF WSI". If an automatic transmission fluid other than Isuzu genuine fluid "ISUZU ATF WSI" is used, the shift quality may be degraded, and the transmission may lock up due to vibration, resulting in a malfunction of the automatic transmission.

**NOTE**

[Lubrication for manual transmission]

- The factory filled oil "BESCO TRANSAXLE(5W-30)" is optimal for fuel efficiency, shift feeling, noise, and other manual transmission performances, as well as for low temperature operation.

LUBRICATION	MAKE	BRAND	GRADE		
			API	ACEA	JASO
Front differential	<b>ISUZU</b>	<b>BESCO SHIFT ON THE FLY (75W-90)</b>	<b>GL-5</b>	—	—
	BASF	Emgard® XFE (75W-85)	GL-5/MT-1		
	Elf	Tranself SYN FE (75W-90)	GL-5/MT-1		
	ExxonMobil	Delvac 1 Gear Oil (75W-90)	GL-5/MT-1		
	Shell	Spirax S6 AXME (75W-90)	GL-5/MT-1		
Total	Traxium Dual 9 FE (75W-90)	GL-5/MT-1			
Rear differential	BASF	Emgard® XFE (75W-85)	GL-5/MT-1		
Power steering (HPS model)	<b>ISUZU</b>	<b>BESCO ATF III</b>	—	—	—
	Chevron/Texaco/Caltex	Texamatic 1888			
	ExxonMobil	ATF Multi-Vehicle (Dexron® VI)			
	ExxonMobil	Dexron VI ATF (Dexron® VI)			
	ExxonMobil	Multipurpose ATF			
Shell	Spirax S3 ATF MD3				
Total	Fluidmatic DVI MV (Dexron® VI)				
Total	Fluidmatic DIII MV				
Wheel hub bearing/ Center bearing (Multi purpose grease)	<b>ISUZU</b>	<b>BESCO L2 GREASE (No.2), L3 GREASE (No.3)</b>	—	—	—
	Chevron/Texaco/Caltex	Delo Starplex EP (No.2)			
	ExxonMobil	Mobilgrease XHP 222 (No.2), 223 (No.3)			
	Shell	Gadus S3 V220C 2 (No.2)			
	Total	Multis Complex EP2 (No.2), EP3 (No.3)			
Propeller shaft sliding yoke/ Universal joint (Multi purpose grease containing molybdenum disulfide)	<b>ISUZU</b>	<b>BESCO ONE LUBER Mo GREASE (No.2)</b>	—	—	—
	Chevron/Texaco/Caltex	Multifak Moly EP (No.2)			
	Shell	Gadus S2 V220AD 2 (No.2)			
	Total	Multis Complex HV2 Moly (No.2)			

COOLANT	MAKE	BRAND
Engine cooling system	<b>ISUZU</b>	<b>BESCO LLC SUPER TYPE E, AS</b>
	Arteco	Havoline XLC
	BASF	Glysantin G34
	Total	Glacelf Auto Supra
	Total	Coolelf Auto Supra -37 C

Use Isuzu recommended coolant, or ISUZU ENGINEERING STANDARD-MATERIAL ISC-C73-004 (Ethylene glycol based Organic Acid Technology (OAT) Extended Life Antifreeze/Coolant and free of nitrites, amines, borates, silicates.) or equivalent.



## ADVICE

- Mix the coolant and water at an appropriate concentration.
- Direct use of "50/50 Pre-diluted" product which is already diluted to 50% concentration is recommended.

## Preparing Engine Coolant

→ Refer to page 6-40

FLUID	MAKE	BRAND	GRADE
Clutch and brake fluid reservoir	<b>ISUZU</b>	<b>BESCO BRAKE FLUID SUPER</b>	<b>DOT 3</b>
	AC Delco	Supreme 11	(FMVSS 116 or SAE J1703)
			<b>DOT 4</b>
			(FMVSS 116 or SAE J1704)

### DIESEL FUEL / APPLICABLE STANDARD

Japanese Industrial Standards (JIS)	Based on K2204 : 1997 Diesel Fuel
Deutsche Industrie Normen (DIN)	Based on EN590 : 1997
American Society for Testing and Materials (ASTM)	Based on D975-04c No.1-D S500 or No.2-D S500 (below 500 ppm)
British Standards (BS)	Based on EN590 : 1997

### DIESEL FUEL / APPLICABLE STANDARD (Sulfur content below 50 ppm)

Japanese Industrial Standards (JIS)	Based on K2204 : 2007 Diesel Fuel
Deutsche Industrie Normen (DIN)	Based on EN590 : 2004
American Society for Testing and Materials (ASTM)	Based on D975-04c No.1-D S15 or No.2-D S15 (below 15 ppm)
British Standards (BS)	Based on EN590 : 2004

**WARNING**

- Open the fuel tank filler cap slowly. If you open it quickly, the fuel tank pressure may cause fuel to spurt out.
- Use diesel fuel that is specified by the relevant vehicle emission standards. For specified diesel fuel, check "Recommended Fluids, Lubricants and Diesel Fuels".
- Do not add or mix in poor quality fuels, or gasoline, kerosene, alcohol-based fuels, or any fuels that are not diesel, or water removing agents or other fuel additives. Starting the engine with inappropriate fuel in the tank is very dangerous because it may adversely affect the fuel filter and cause poor movement of fuel-lubricated parts in the injectors, in addition to adversely affecting engine components, and could possibly result in a breakdown or even a fire.
- If inappropriate fuel is accidentally added to the tank, drain it out completely.

**CAUTION**

- Using diesel fuel other than those specified by the relevant vehicle emission standards could prevent the vehicle from complying with local legal requirements.

**ADVICE**

- Only use fuels listed above. Do not use other fuels as they may adversely affect the engine.
- Do not use diesel fuel with higher sulfur content than the diesel fuel that is specified by the relevant vehicle emission standards. Using high-sulfur diesel fuel may adversely affect the engine, exhaust emission reduction system, or EGR system, possibly resulting in a breakdown.

Engine Oil and Gear Oil Viscosity Charts

Select appropriate engine and gear oils in accordance with the tables below. It is also important to select the viscosity appropriate for the temperature at which your vehicle operates. Use the following tables for making correct selections.

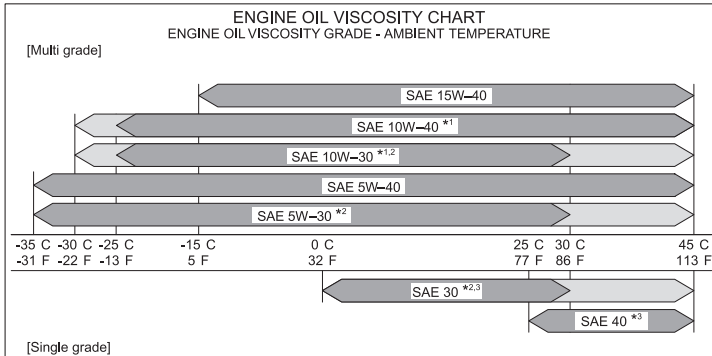

- \*1: When starting aids (oil pan heater, block heater, etc.) are used, grade 10W-xx oils can be used at an ambient temperature as low as -30 C (-22 F).
- \*2: Use is possible at ambient temperatures of up to 45 C (113 F) in the case of Isuzu genuine oils or other recommended oils of grade xxW-30.
- \*3: Single grade oils are only applied to engines that conform to Euro II emission standard and other less severe emission standards.

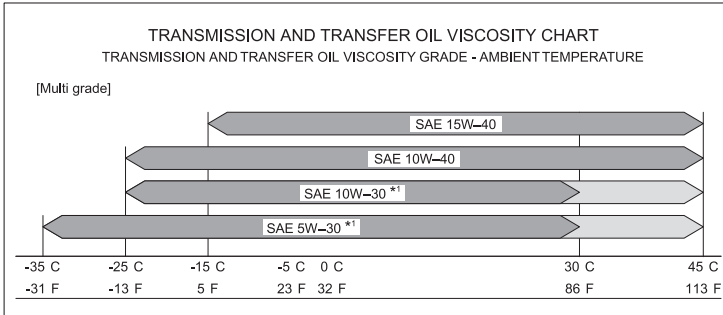

\*1: Use is possible at ambient temperatures of up to 45 C (113 F) in the case of Isuzu genuine oils of grade xxW-30.

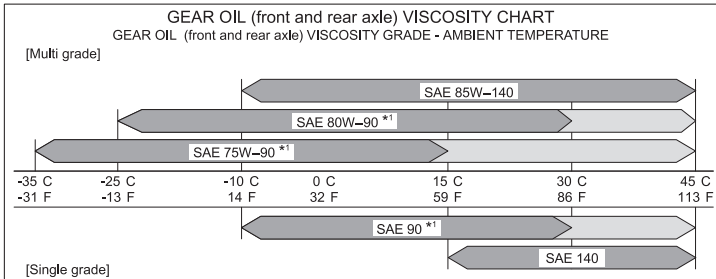

\*1: Use is possible at ambient temperatures of up to 45 C (113 F) in the case of Isuzu genuine oils or other recommended oils of grade xxW-90.

• Troubleshooting	7-2
• When the Electronic Key Battery Goes Flat	7-7
• Emergency Engine Stopping (Models with Passive Entry and Start System)	7-10
• Emergency Engine Starting (Models with Passive Entry and Start System)	7-11
• When the Vehicle Breaks Down during Driving	7-12
• When the Tire Goes Flat	7-13
• When the Engine Stops While Driving	7-14
• When the Engine Stalls and Cannot Be Restarted	7-15
• When the Brakes Do Not Work	7-15
• When the Battery Goes Flat	7-16
• When the Fuel Runs Out	7-18
• When the Generator Warning Light Comes On	7-20
• When the Engine Oil Pressure Warning Light Comes On	7-21
• When the Warning Light Comes On	7-21
• When the Engine Overheats	7-22
• When the Light Does Not Come On	7-24
• Replacing the Fuses and Relays	7-24
• When Driving on Bad Roads	7-28
• Towing	7-29

### Troubleshooting

Performing regular inspections and maintenance prevents damage. Be sure to perform inspections and maintenance at regular intervals. Also, quickly rectify any fault in the vehicle (even a small fault) to prevent it from becoming more serious.

If a symptom shown in the following table occurs, perform inspections and take corrective action in accordance with the table. If you are unable to perform a repair, the corrective action shown in the table does not eliminate a symptom or you cannot locate a fault, contact the nearest Isuzu Dealer.



#### ADVICE

- Any item for which there is a © in the "Corrective action" column requires repairs and adjustments. Contact the nearest Isuzu Dealer.

Symptom		Cause	Corrective action	Reference page
Engine does not start	Starter does not turn over, or is weak	Flat battery	Recharge or replace	7-16
		Battery terminals detached, loose or corroded	After repairing corroded section, connect the terminals firmly	6-123
		Starter ground wire terminal detached, loose or corroded	After repairing corroded section, connect the terminals firmly	
		Engine oil viscosity too high	Change to oil with proper viscosity	6-148
		Starter or electrical system is faulty	⊙	
		Selector lever is not in the "P" or "N" position (automatic transmission model)	Place selector lever in "P" or "N" position (automatic transmission model)	4-4 4-145
		Gearshift lever is not in the "N" position (manual transmission models with passive entry and start system)	Place the gearshift lever in the "N" position (manual transmission models with passive entry and start system)	4-4 4-144
		Brake pedal (automatic transmission models) or clutch pedal (manual transmission models) is not depressed (models with passive entry and start system)	Depress the brake pedal (automatic transmission models) or clutch pedal (manual transmission models) (models with passive entry and start system)	4-4 4-142
		Passive entry and start system is not verified	Check if electronic key is carried with you	4-4
	Passive entry and start system is faulty	Replace the battery	3-12	
	Starter turns over	No fuel	Make sure there are no fuel leaks, and then add fuel	
		Air in the fuel system	Bleed fuel system	7-19
		Fuel filter is clogged	⊙	
		Fuel is frozen	Warm fuel pipe with hot water or wait until it gets warmer	
		Common rail system is faulty	⊙	
Preheating system is faulty		⊙		

Symptom	Cause	Corrective action	Reference page
Starter takes a long time to turn over	Pre-heating is performed (models with passive entry and start system)		4-4
Engine starts, but immediately stops	Fuel filter is clogged	⊙	
	Air cleaner is clogged	Clean or replace element	6-49
	Common rail system is faulty	⊙	
Unsteady engine speed	There is water or air in the fuel system	Drain water from fuel filter or bleed fuel system	6-51 7-19
	Fuel system is faulty	⊙	
White or black exhaust smoke	Engine not sufficiently warmed up	Allow engine to warm up sufficiently	
	Excessive engine oil	Correct oil level	6-22
	Air cleaner is clogged	Clean or replace element	6-49
	Fuel system is faulty	⊙	
Engine is overheating	No or low engine coolant	Add engine coolant	6-39
	Front of radiator is clogged with dirt	Wash clean with tap water	6-44
	Radiator cap not sufficiently tightened	Refill the engine coolant and make sure the radiator cap is firmly tightened.	6-39
	Fan belt loose	Adjust the tension or replace the belt	6-46
	Engine coolant dirty	⊙	
	Fan clutch is faulty	⊙	
	Radiator cap dirty or faulty	⊙	
Oil pressure is low	Improper engine oil viscosity	Change to oil with proper viscosity	6-148
	Engine oil level too low	Add engine oil	6-22
	Engine inner components are faulty	⊙	
	Meter, indicator/warning lights or switches faulty	⊙	

Symptom	Cause	Corrective action	Reference page
Not enough engine power	Parking brake not fully released	Make sure it is fully released	
	Brake dragging	⊙	
	Clutch slipping (manual transmission model)	⊙	
	Air cleaner is clogged	Clean or replace element	6-49
	Fuel filter is clogged	⊙	
	Engine control system faulty	⊙	
	Common rail system faulty	⊙	
	Engine faulty	⊙	
Brakes not effective	Drum-to-lining gap too large	⊙	
	Air in brake fluid	⊙	
	Brake system failure	⊙	
Uneven braking	Unbalanced air pressure in tires	Adjust to proper air pressure	6-62
	Tire unevenly worn	Replace tire	6-78
	Unbalanced drum-to-lining gap of the wheels	⊙	
	Poor wheel alignment	⊙	
Steering wheel hard to turn	Loaded too far forward	Load properly	2-7
	Power steering fluid level too low (hydraulic power steering model)	Add fluid	6-91
	Insufficient air in front tires	Adjust to proper inflation pressure	6-62
Excessive play in the steering wheel	Wheel nuts loose	Tighten to the specified torque	6-87
	Unbalanced inflation pressure in the tires	Adjust to proper inflation pressure	6-62
	Unbalanced tires	⊙	
	Excessive steering wheel play	⊙	
Poor steering wheel return	Poor lubrication in the steering mechanisms	⊙	
	Poor wheel alignment	⊙	

Symptom		Cause	Corrective action	Reference page
Clutch disengages poorly (manual transmission model)		Insufficient clutch fluid	Add fluid	6-88
		Excessive clutch pedal free play	⊙	
Loud or abnormal noises	From the transmission	Insufficient transmission oil	⊙	
		Transmission inner components faulty	⊙	
	From differential	Insufficient differential gear oil	⊙	
		Differential inner components faulty	⊙	
	From the suspension	Spring pins, shackles, or stoppers worn	⊙	
	From the propeller shaft	Poor lubrication in each component	⊙	
		Splines or bearings worn	⊙	
	From the transfer case	Insufficient transfer oil	⊙	
Transfer inner components faulty		⊙		

## When the Electronic Key Battery Goes Flat

If switching the power mode and/or starting the engine using the passive entry and start system becomes impossible due to the electronic key battery goes flat, it is possible to switch the power mode and/or start the engine by putting the electronic key close to the engine start/stop button.

### Passive Entry and Start System

→ Refer to page 3-17

### Engine Start/Stop Button (Models with Passive Entry and Start System)

→ Refer to page 4-112

1. Push the engine start/stop button. The engine start/stop button indicator light will flash in yellow and "Put electronic key close to start button" will be displayed in the MID.

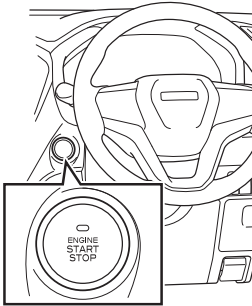

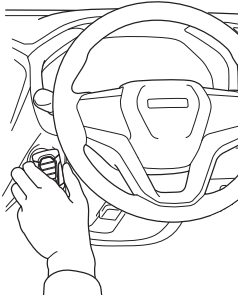

### Manual transmission model



### Automatic transmission model



2. Put the electronic key near the engine start/stop button while the engine start/stop button indicator light is flashing (within 10 seconds).
3. The buzzer sounds and the flashing of the engine start/stop button indicator light will change from fast to slow and the procedure for starting the engine will be displayed in the MID.
4. When attempting to change the power mode, push the engine start/stop button within 10 seconds. When attempting to start the engine, perform the following operations within 10 seconds.
5. Make sure that the parking brake lever is fully pulled.
6. If your vehicle is a manual transmission model, make sure that the gearshift lever is in the "N" position and then depress the clutch pedal and brake pedal fully. In an automatic transmission model, make sure that the selector lever is in the "P" position and then depress the brake pedal fully.
7. With the pedal(s) depressed, push the engine start/stop button. The engine start/stop button indicator light will then change from flashing to being continuously illuminated and the engine will start.

**NOTE**

- The electronic key contains an immobilizer transponder chip, and it can be used to start the engine and change the power mode.
- After the engine start/stop button indicator light goes out, it is not possible to start the engine or change the power mode if more than approximately 10 seconds have passed. Push the engine start/stop button and put the electronic key close to the engine start/stop button again.
- The system will not function properly in the following situations:
  - A metallic object is touching or covering the handle of the key.
  - Another vehicle's transponder key is near your key.

**Key with Immobilizer Transponder Chip**

→ Refer to page 3-5

### Emergency Engine Stopping (Models with Passive Entry and Start System)

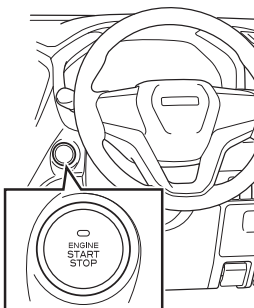

The engine can be stopped while the vehicle is in motion by performing the following operation:

- Continue pushing the engine start/stop button for 3 seconds or more.
- Push the engine start/stop button three times or more within 2 seconds.

#### **WARNING**

- Do not perform emergency engine stopping except in times of emergency. If the engine is stopped, brake effectiveness will be reduced and the steering wheel will be hard to turn.

**When the Engine Stops While Driving**

→ Refer to page 7-14

## Emergency Engine Starting (Models with Passive Entry and Start System)

If the engine becomes unable to start for some reason, the engine may be able to be started by performing the following operation.

### CAUTION

- Because the vehicle may move unexpectedly when the engine is started, perform the procedure after ensuring that the surrounding area is safe to do so.
- Although starting of the engine can be attempted in the "N" position for automatic transmission models, for safety reasons, it is recommended that starting be performed in the "P" position.

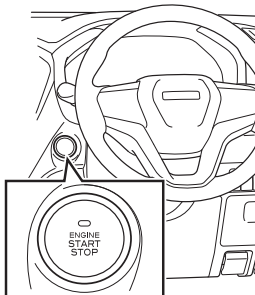

1. Push the engine start/stop button once and the power mode will switch to "ACC".
2. Make sure that the parking brake lever is fully pulled.
3. If your vehicle is a manual transmission model, make sure that the gearshift lever is in the "N" position and then depress the clutch pedal and brake pedal fully. In an automatic transmission model, make sure that the selector lever is in the "P" position and then depress the brake pedal fully.
4. With the pedal(s) depressed, continue pushing the engine start/stop button for 15 seconds or more.

### NOTE

- Perform the emergency engine starting procedure within 5 minutes of the switching the power mode to "ACC".
- When attempting to start the engine, the glow plug indicator light will come on if the engine is cold. In such cases, engine starting will be delayed until the glow plugs have sufficiently warmed. Continue depressing the clutch pedal (manual transmission models) or the brake pedal (automatic transmission models) until the engine starts.
- When the engine does not start, contact your nearest Isuzu Dealer as soon as possible.

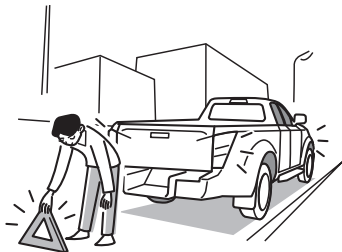
**When the Vehicle Breaks Down during Driving**

1. Operate the hazard warning flasher and pull the vehicle immediately over to a safe place that does not impede traffic (shoulder, verge). Place the triangle reflectors to alert other traffic to the presence of your vehicle.
2. Have the other passengers get out and wait in a safe place.
3. Walk to a safe place and take appropriate measures by using the closest telephone, etc.

**WARNING**

[If there is a fuel leak]

- Leaking fuel from the vehicle is dangerous due to possible combustion or explosion. Stop the engine immediately.

### When the Tire Goes Flat

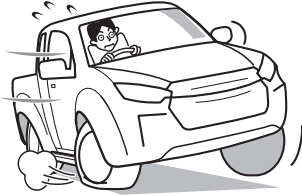

When the tire gets flat while driving, avoid hard braking, hold on to the steering wheel firmly and stop the vehicle.

The tire should be changed on a flat space to prevent obstructing other vehicles or pedestrians.

#### **WARNING**

- If you continue to drive on a flat tire, undue force will be applied to the wheel bolts, possibly causing the bolts to break and the wheel to come off.

**Tools** → Refer to page 6-8

**Spare Tire** → Refer to page 6-68

**Handling the Jack** → Refer to page 6-73

**Changing Tires** → Refer to page 6-78

### When the Engine Stops While Driving



As the brake booster will no longer operate, brake effectiveness will be reduced. The power steering system will not work so the steering wheel will be hard to turn. Stay calm and decrease vehicle speed by depressing the brake pedal. Then, promptly pull the vehicle over to a safe location and inspect its condition. If the engine does not start, contact the nearest Isuzu Dealer.

#### **WARNING**

- Vehicle operations will change, so stop the vehicle in a safe place with the following in mind.
  - The power steering system will not work so the steering wheel will be hard to turn. It will require more strength than during normal operation.
  - As the brake booster will no longer be functional, brake effectiveness will be greatly reduced. Be sure to apply more pressure than usual to the brake pedal.
- In models with passive entry and start system, if the engine stops while the vehicle is in motion, etc., do not open the doors until the vehicle has come to a safe stop. This is dangerous as the steering wheel lock may operate if the doors are opened. After stopping the vehicle in a safe place, immediately contact your nearest Isuzu Dealer.

#### **NOTE**

- If the engine stopped because the vehicle ran out of fuel while driving, refueling alone will not be enough to restart the engine. Bleed the fuel system after refueling the vehicle.

#### When the Fuel Runs Out

→ Refer to page 7-18

### When the Engine Stalls and Cannot Be Restarted

Place the gearshift lever (manual transmission models) or the selector lever (automatic transmission models) in the "N" position and push the vehicle to a safe place.



#### CAUTION

- In case of emergency with manual transmission models, place the gearshift lever in "R (reverse)", "1 (1st gear)" or "2 (2nd gear)" if the starter turns over. Then, keep turning the starter switch with your foot off the clutch pedal to move the vehicle (models without passive entry and start system). However, doing so may cause damage to the starter.

### When the Brakes Do Not Work



If the brakes unexpectedly stop working, reduce speed by quickly shifting gears down incrementally to 1st gear. Gradually pull the parking brake lever while firmly holding on to the steering wheel and stop the vehicle on the side of the road. After stopping the vehicle, immediately contact the nearest Isuzu Dealer.



#### CAUTION

- It is very dangerous to suddenly pull the parking brake lever all the way while moving at high speed. Reduce speed first by shifting down and then gradually pull the parking brake lever.
- Do not continue driving with the brakes in a non-working condition.

### When the Battery Goes Flat

Use a jumper cable (sold separately) and the batteries of another vehicle to start the engine in this sequence.



#### CAUTION

- For safety and the protection of the vehicle, do not push-start the vehicle.
- Make sure that the booster batteries in the vehicle providing the charge have the same voltage as the disabled vehicle.
- Never let the battery's positive and negative terminals to come into contact with one another.
- Never let the clips come into contact with one another when connecting the cables.
- Ask the nearest Isuzu Dealer to recharge the battery.
- Do not disconnect a battery terminal with the engine running. It could cause a breakdown in the electrical system.

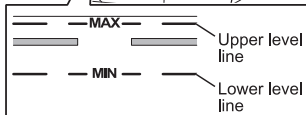
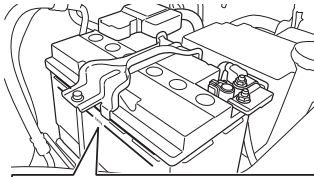

1. Check the battery fluid level in the disabled vehicle.
2. Use a vehicle that has a charged battery with the same voltage.

3. Connect the jumper cables in the numbered sequence in the drawing.

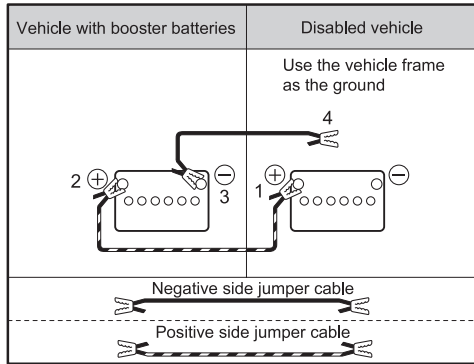

4. After connecting the cables, start the engine of the vehicle with the booster battery. Slightly rev up the engine of the vehicle with the booster battery and start the engine of the disabled vehicle.

#### Starting the Engine

→ Refer to page 4-4

5. If the engine in the disabled vehicle starts, remove the jumper cables in the reverse sequence as they were connected.

#### WARNING

- Check the battery fluid level before connecting the jumper cables. Usage or charging of the battery when the battery fluid is below the lower level line can accelerate deterioration, and give rise to dangerous situations such as the generation of heat and may even cause an explosion. Perform the work after adding the battery fluid.
- A vehicle battery generates flammable gas that could explode. Be careful of the following to avoid creating sparks.
  - Do not connect one end of the jumper cable shown in step 4 in the drawing directly to the battery's negative terminal. Connect the jumper cable to a metal part of the engine that is away from the battery.
  - Do not let the cable connected to the positive terminal come in contact with the cable connected to the negative terminal or the body.
  - Keep flames away from the battery.
- Be careful not to become entangled in any belts when connecting and removing the cables.

**NOTE**

- When it is difficult to start the engine in a cold location, after connecting the jumper cables, start the engine of the vehicle with the booster batteries. Wait a few minutes before starting the engine of the disabled vehicle.

**When the Fuel Runs Out****Models with MID**

When the fuel runs out, air will enter the fuel system, so refueling alone will not be enough to restart the engine. Use the following methods to bleed the fuel system.

**Models with LCD**

## Bleeding the Fuel System

### Right-hand Drive

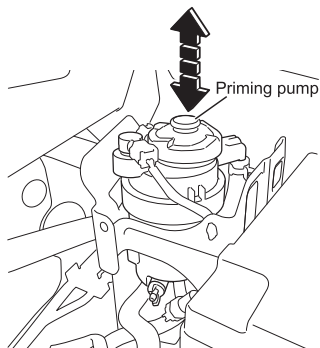

### Left-hand Drive

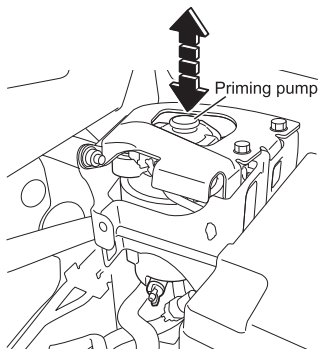

1. Operate the priming pump up and down to perform air bleeding. Repeatedly operate the priming pump up and down until its operational force becomes strong.
2. Without depressing the accelerator pedal, start the engine.

### Starting the Engine

→ Refer to page 4-4



### NOTE

- If the engine does not start or it stops immediately after starting, perform the procedure from step 1 again.
3. After the engine has started, allow it to idle for 1 minute.
  4. Slowly and fully depress the accelerator pedal to increase the engine r/min, then release your foot from the pedal once the tachometer pointer comes close to the red zone (Repeat this operation a few times).
  5. If the engine could not be started, try again from step 1.



### ADVICE

- Insufficient air bleeding can result in faulty engine operation. Bleeding of the fuel system should always be performed using the correct procedure.
- Insufficient air bleeding may cause the check engine warning light (for models other than those conforming to Euro 4 emission standards), or either malfunction indicator light (MIL) or SVS indicator light (for models conforming to Euro 4 emission standards) to illuminate, or improper engine performance.

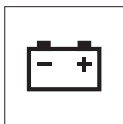
**When the Generator Warning Light Comes On**

When this warning light comes on, the charging system may have failed.

Immediately stop the vehicle in a safe place, perform checks and take corrective action.

**Generator Warning Light**

→ Refer to page 4-75

**Check and Corrective Action**

Check to see if the fan belt/accessory belt is broken or loose.

- If the fan belt is loose, adjust the tension.
- If there is no abnormality in the fan belt/accessory belt, contact the nearest Isuzu Dealer.

**Fan Belt/Air Conditioning Compressor Belt/Accessory Belt**

→ Refer to page 6-46

**CAUTION**

- Do not drive the vehicle when the warning light is on. The battery can be discharged.

**When the Engine Oil Pressure Warning Light Comes On**

When this warning light comes on, the oil pressure is too low.

Immediately stop the vehicle in a safe place, stop the engine, perform checks and then take corrective action.

**Engine Oil Pressure Warning Light**

→ Refer to page 4-69

**Check and Corrective Action**

1. Check the engine oil level.
2. If the engine oil level is too low, check for leaks and add oil.
3. When the oil level is normal and there are no oil leaks, the oil filter may be clogged.  
Replace the oil filter. Have the engine oil filter replacement performed at an Isuzu Dealer.
4. When the oil level is normal and the oil filter is not clogged, but there are oil leaks, contact the nearest Isuzu Dealer.

**Engine Oil** → Refer to page 6-22

**CAUTION**

- Do not drive the vehicle when the warning light is on. It could damage the engine.

**NOTE**

- In winter, when the engine oil temperature is low and the oil viscosity is high, the light might come on for a time. It will go out when the engine warms up.

**When the Warning Light Comes On**

If the Warning Light and Indicator Light come on, refer to chapter 4.

**Warning and Indicator Lights**

→ Refer to page 4-61

## When the Engine Overheats

If engine power drops and the engine coolant temperature gauge goes up above the upper limit of the safety zone and then enters "H" zone and flashes at the time, the engine is overheating. The engine overheat warning light will come on and the engine overheat warning buzzer will sound. Either steam or boiling water will squirt out of the radiator. Take the following corrective actions immediately.

### Models with MID

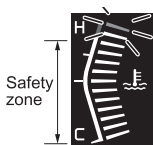

### Models with LCD

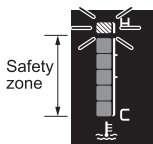

### Engine overheat warning light (models with MID)

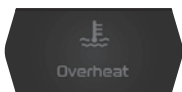

### Engine overheat warning light (models with LCD)



1. Operate the hazard warning flasher and pull the vehicle immediately over to a safe place that does not impede traffic (shoulder, verge) and park it.
2. Lower the temperature of the engine for a while with the engine idling.



### WARNING

- If steam or abnormal noises are being emitted from within the engine compartment, immediately stop the engine and contact the nearest Isuzu Dealer. Should this happen, do not open the engine hood as you may be scalded by hot water that could possibly blow out.



### ADVICE

- Do not stop the engine immediately. Otherwise, the engine may seize.
- Turn off the air conditioner if it is running.
- Stop the engine if the engine coolant temperature gauge does not go down even when the engine is idled. Contact the nearest Isuzu Dealer.

3. When the gauge of the engine coolant temperature gauge returns to the middle of the safety zone, stop the engine.

**⚠ WARNING**

- Even when the engine has been stopped, the engine coolant in the radiator remains under pressure. Immediately removing the radiator cap could cause steam or hot water to blow out, and you could be scalded as a result. The engine coolant in the reserve tank may also be hot. Immediately removing the cap could cause hot water to blow out, and possibly scald you.
- When removing the radiator cap and reserve tank cap, use a thick cloth to cover the cap and turn it little by little.



4. Check the engine coolant level in the reserve tank and radiator after the engine has sufficiently cooled. If the level is insufficient, add engine coolant. Also, check to see if the fan belt is loose or has been damaged.

**👤 ADVICE**

- Make sure that the gauge on the engine coolant temperature gauge is below "C" before adding engine coolant. Adding engine coolant when the engine is not sufficiently cool could cause a breakdown in the engine or damage it.
- When tap water only has been used for engine coolant in an emergency, adjust the engine coolant concentration as soon as possible.

**Warning Buzzer** → Refer to page 4-106

**Engine Coolant** → Refer to page 6-39

**Fan Belt/Air Conditioning Compressor Belt/Accessory Belt**

→ Refer to page 6-46

### When the Light Does Not Come On

If the exterior light or interior light does not come on, refer to chapter 6.

Lights → Refer to page 6-102

### Replacing the Fuses and Relays

When the lights will not come on or flash, or the equipment in the electrical system does not operate, check to see if a fuse has blown.



#### ADVICE

- It is not necessary to open or close the cover unless trouble is found.
- The fuse and relay box structure makes it difficult for water to enter. If you should spill water or a beverage on the cover, however, wipe it off before opening the cover.
- The area around the cover will get warm when the vehicle is being driven, but this is not abnormal.

### The Location of Fuses and Relays

The fuses and relays are inside the cab and the engine compartment. When inspecting or replacing the fuses or relays in the cab, remove the small article storage pocket that is located on the lower driver side part of the instrument panel. When inspecting or replacing the fuses or relays in the engine compartment, open the cover of the fuse and relay box that is located on the front left side of the engine compartment. Check the diagram on the fuse box for the layout of the fuses and relays as well as the amperages of the fuses.



#### NOTE

- The layout of the fuses inside the cab is shown on the opposite side of the small article storage pocket.

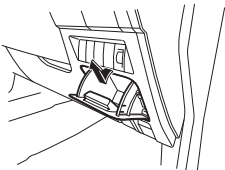
**Removal method****Removing the Small Article Storage Pocket**

Pull the small article storage pocket towards you to open it. While in the open position, pull it up until it unlocks from the hinge to remove it.

To install the small article storage pocket, perform the removal procedure in reverse.

**Installation method**

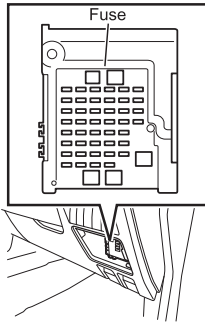

### Replacing Fuses

1. Before replacing fuses, be sure to switch the power mode to "OFF" (models with passive entry and start system) or turn the starter switch to the "LOCK" position (models without passive entry and start system) and pull back on the parking brake lever.
2. Place the fuse puller on the fuse and pull it out. (The fuse puller is stored in the fuse box inside the engine compartment.)

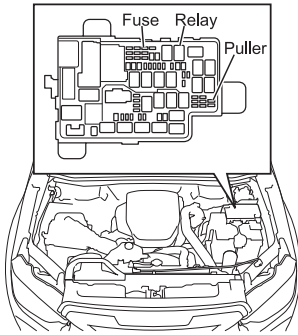

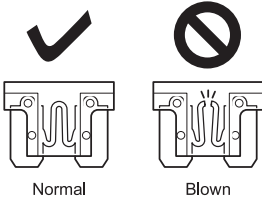

3. If the fuse appears as shown in the right-hand side of the diagram at left, the fuse is blown. Replace with a spare fuse. Spare fuses are stored in the fuse box inside the engine compartment and within the instrument panel.

 **WARNING**

- Use fuses of the same amperage for replacement. Do not use any other fuses than those designated.
- Using fuses other than those specified could result in fire or damage to the equipment.
- If the new fuses blow right away, contact the nearest Isuzu Dealer.



**NOTE**

- For automatic transmission models with a passive entry and start system, if the back light fuse is blown or has been replaced, the check system warning light may be displayed in the multi-information display (MID). When this happens, perform the following procedure:

- With the selector lever in the "N" position, switch the power mode to "ON" and leave it for 5 seconds or more, or until the check system warning light goes out.
- To start the engine, follow the normal engine starting procedure after switching the power mode once to "OFF".

If the check system warning light continues to be displayed even after performing the above procedures, contact the nearest Isuzu Dealer.

**Starting the Engine**

→ Refer to page 4-4

**Replacing Relays**

When replacing the relays, contact the nearest Isuzu Dealer.

### When Driving on Bad Roads

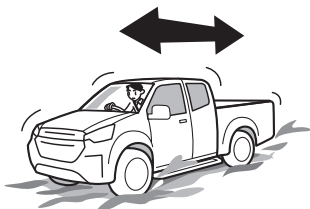

If the vehicle gets stuck in mud, depressing the accelerator pedal more than necessary will simply dig the vehicle deeper into the mud and make it harder to extricate. Either put stones, tree branches or blankets under the tires to gain traction or repeatedly drive forward and backward to use the vehicle's momentum to extricate it.



#### WARNING

- When the vehicle is stuck and people or objects are nearby, do not drive the vehicle forward and backward. When driving the vehicle forward and backward, the vehicle may suddenly become unstuck and injure nearby people or cause damage to objects.



#### NOTE

- On a muddy road with an automatic transmission model, by depressing the brake pedal you can make a standing start in the manual mode 2nd gear and move the selector lever to the "+" (upshift) position. This provides better traction and safer vehicle operation.
- For models that are equipped with electronic stability control (ESC), when you want to free the vehicle from mud where the tires may slip slightly by increasing the engine speed, you can press the ESC OFF switch to disable just the traction control system (TCS).
- For models that are equipped with differential locks, use the differential lock when you want to free the vehicle from mud.

#### Automatic Transmission

→ Refer to page 4-145

#### Electronic Stability Control (ESC)

→ Refer to page 4-162

#### Rear Differential Lock Switch

→ Refer to page 4-128

## Towing

To move a disabled vehicle, it is best to rely on the nearest Isuzu Dealer or someone in the wrecker or tow vehicle business. If that is not possible, follow these procedures. When towing, use appropriate equipment and comply with local legal requirements. Do not try to start the engine by towing or pushing the vehicle.

### Right-hand Drive 4x2 Models

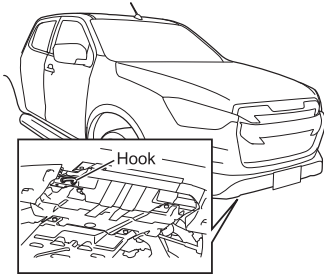

### Left-hand Drive 4x2 Models

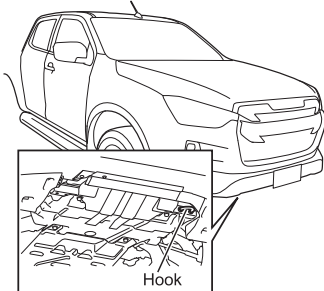

### ⚠ CAUTION

- Do not tow a vehicle at an angle of greater than 15°. This could exert too much stress on the vehicle and damage it.
- Attach a rope to the towing hook only. Attaching a rope to other part of the vehicle could damage it.
- Make sure there are no people near the towing rope and hook before towing a vehicle. If the rope snaps or the vehicle falls off the hook and is damaged, people nearby may be injured or objects may be damaged.
- The towing hook is for use to tow a vehicle with about the same weight as the towing vehicle on good roads.
- Follow the instructions of the equipment manufacturer.
- A separate safety chain must be used.
- Do not tow a vehicle that is attached to another vehicle.
- If the vehicle does not move even when towed, stop the towing procedure. Contact the nearest Isuzu Dealer or a towing service for assistance.

Left-hand and Right-hand Drive 4x4 Models

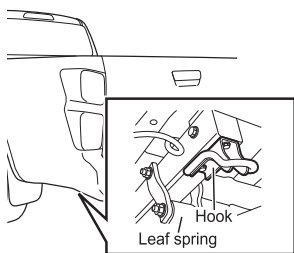
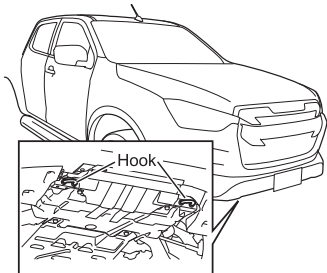

Usable range of towing rope

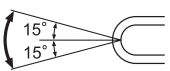

Usable range of towing rope

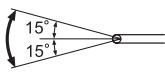

## When Towed

 **WARNING**

- Before towing, make sure that the towing hook is in good condition and that the fixing bolts are tightened properly.

 **CAUTION**

- Whenever possible, tow a vehicle with the engine started.  
If the engine is not started:
    - The brakes will not be as effective;
    - The steering wheel will be hard to turn;
    - The steering wheel could lock, making it impossible to turn. This is extremely dangerous (particularly when the key is removed).
  - In models with a passive entry and start system, when the battery voltage of the vehicle is low, the power mode may not be able to switch. It may prevent unlocking of the steering wheel lock. If that happens, use a jumper cable (sold separately) and the batteries of another vehicle to switch the power mode (unlock the steering wheel lock).
  - In models with passive entry and start system, when the engine start/stop button malfunctions, the steering wheel lock will be unable to be unlocked and towing will not be possible.
- [Request a tow vehicle in case of one of the following conditions]
- When the vehicle will descend long hills. (The brakes could overheat and become ineffective.)
  - When the vehicle breaks down on a highway.

**ADVICE**

- Whenever possible, transport the vehicle with all wheels off the ground using a flatbed truck, etc. If you cannot avoid towing the vehicle with the front wheels/ rear wheels/all wheels on the ground, tow at a speed of 30 km/h (19 MPH) or less and a towing distance within 80 km (50 miles).
- For 4WD vehicles, set the 4WD switch to the "2H" position and confirm that the 4WD indicator light has turned off. If the 4WD indicator light does not turn off, transport the vehicle with all four wheels off the ground using a flatbed truck, etc.
- For models with the rear differential lock, turn the rear differential lock switch off and make sure that the rear differential lock indicator light is off.
- If the manual transmission, automatic transmission, or differential is damaged, transport the vehicle with all four wheels off the ground using a flatbed truck, etc.

**NOTE**

- Depending on the model, one or two front towing hooks will be equipped.

**4WD Switch** → Refer to page 4-311

**Passive Entry and Start System**

→ Refer to page 3-17

**Engine Start/Stop Button (Models with  
Passive Entry and Start System)**

→ Refer to page 4-112

**When the Battery Goes Flat**

→ Refer to page 7-16

**Rear Differential Lock Switch**

→ Refer to page 4-128

**All Four Wheels On Ground**

When it is possible to operate the steering wheel, the vehicle can be towed with all wheels on the ground.

However, the power steering will not be able to provide any power assist when the engine cannot be started.

1. Remove the cover of the front bumper extension. Facing the cover, pull down its left side edge to release the tabs, and then slide the cover to remove it.

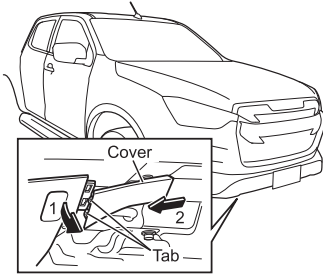
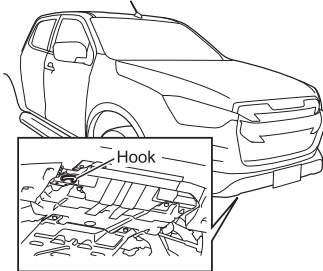
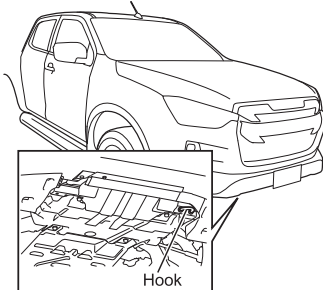
**Right-hand Drive 4x2 Models****Left-hand Drive 4x2 Models**

2. Firmly attach a rope to the front towing hook. The driver must be inside the cabin to control the steering wheels and brake. Switch the power mode to "ACC" (models with passive entry and start system) or turn the starter switch to the "ACC" position (models without passive entry and start system).
3. For manual transmission vehicles, place the gearshift lever in the "N" position and release the parking brake. For automatic transmission vehicles, place the selector lever in the "N" position and release the parking brake. For 4WD vehicles, set the 4WD switch to the "2H" position and confirm that the 4WD indicator light has turned off.

**4WD Switch** → Refer to page 4-311

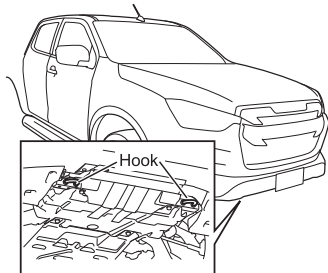
**Left-hand & Right-hand Drive 4x4 Models**

4. During towing, carefully watch the stop lights of the towing vehicle in order to prevent the rope from becoming slack. Tow the vehicle gently, ensuring that there are no strong impacts or lateral forces applied to the vehicle.

**Front Wheels Off the Ground**

For manual transmission vehicles, place the gearshift lever in the "N" position and release the parking brake. For automatic transmission vehicles, place the selector lever in the "N" position and release the parking brake. For 4WD vehicles, set the 4WD switch to the "2H" position and confirm that the 4WD indicator light has turned off.

**4WD Switch → Refer to page 4-311**

**Rear Wheels Off the Ground**

1. For manual transmission vehicles, place the gearshift lever in the "N" position. For automatic transmission vehicles, place the selector lever in the "N" position. For 4WD vehicles, set the 4WD switch to the "2H" position and confirm that the 4WD indicator light has turned off.

**4WD Switch → Refer to page 4-311**

2. Secure the steering wheel in order to keep it in a straight position. Switch the power mode to "ACC" (models with passive entry and start system) or turn the starter switch to the "ACC" position (models without passive entry and start system).

**ADVICE**

- When towing, locking the steering wheel by switching the power mode to "OFF" (models with passive entry and start system) or turning the starter switch to the "LOCK" position (models without passive entry and start system) may result in damage to the lock mechanism.

### When Towing

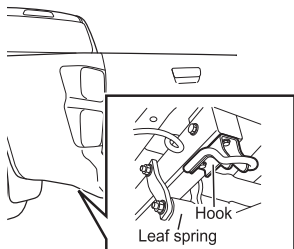

1. Firmly attach a rope to the front towing hook on the same side.
2. During towing, tow the vehicle gently ensure that there is no strong shock or lateral force applied to the vehicle.



#### ADVICE

- Do not tow a vehicle heavier than the towing vehicle. The traction strength has been set up to be smaller than the weight of the towing vehicle.



#### NOTE

- Depending on the model, a rear towing hook may not be equipped.

**7-36**

**IN CASE OF EMERGENCY**



---

• Main Data and Specifications	8-2
• Others	8-14

---

## Main Data and Specifications

## Engine

## 4JJ3 Engine Model

Specifications	
Water-cooled, overhead camshaft, direct injection engine with an inter-cooled turbocharger	
Compression ratio	(to 1) 16.3
Displacement	cc (cu. in) 2,999 (183)
Firing order	1-3-4-2
Fuel injection timing	Electronic control
Valve clearance (Between cam and roller)	mm (in) Both inlet and exhaust valves: 0.15 (0.006) in cold engine
Idling speed	r/min 675 - 725
Belt tension	mm (in)/Hz Fan belt: 7.0 - 7.8 (0.28 - 0.31) / 176 - 190 * New belt: 5.0 - 6.0 (0.20 - 0.24) / 207 - 231 Air conditioning compressor belt: 16.5 - 19.1 (0.65 - 0.75) / 79 - 91 * New belt: 12.5 - 16.5 (0.49 - 0.65) / 92 - 112
Oil filter	Replaceable element type
Engine oil capacity [Reference value] <b>liters (US gal./Imp gal.)</b>	When changing oil and filter: 2WD: <b>7.0 (1.85/1.54)</b> 4WD: <b>7.5 (1.98/1.65)</b>
Engine coolant capacity [Reference value] <b>liters (US gal./Imp gal.)</b>	With heater-defroster: (M/T) <b>10.7 (2.83/2.35)</b> , (A/T) <b>11.1 (2.93/2.44)</b> Without heater-defroster: (M/T) <b>10.1 (2.67/2.22)</b> , (A/T) <b>10.5 (2.77/2.31)</b>
Preheating system	Glow plugs

\* Marks: The new belt values only apply when replacing with a new belt.

**RZ4E Engine Model**

Specifications		
Water-cooled, overhead camshaft, direct injection engine with an inter-cooled turbocharger		
Compression ratio	(to 1)	16.5
Displacement	cc (cu. in)	1,898 (115.8)
Firing order		1-3-4-2
Fuel injection timing		Electronic control
Valve clearance (Between cam and roller)		No adjustments needed
Idling speed	r/min	725 - 775
Belt tension		Accessory belt: Automatic adjust
Oil filter		Replaceable element type
Engine oil capacity [Reference value]		When changing oil and filter:
	<b>liters (US gal./Imp gal.)</b>	<b>6.6 (1.74/1.45)</b>
Engine coolant capacity [Reference value]		With heater-defroster:
	<b>liters (US gal./Imp gal.)</b>	(M/T) <b>10.3 (2.72/2.27)</b> , (A/T) <b>10.7 (2.83/2.35)</b>
		Without heater-defroster:
		(M/T) <b>9.6 (2.54/2.11)</b> , (A/T) <b>10.0 (2.64/2.20)</b>
Preheating system		Glow plugs

## Transmission

## MVL6S Model (Manual Transmission)

Specifications		
Six-speed transmission (overdrive gear for 5th and 6th), synchromesh for 1st to 6th and reverse		
Gear ratio (to 1)	1st	4.942
	2nd	2.452
	3rd	1.428
	4th	1.000
	5th	0.749
	6th	0.634
	Reverse	4.597
Transmission oil capacity [Reference value] liters (US gal./Imp gal.)		2.8 (0.74/0.62)

## MVL6Y Model (Manual Transmission)

Specifications		
Six-speed transmission (overdrive gear for 5th and 6th), synchromesh for 1st to 6th and reverse		
Gear ratio (to 1)	1st	4.942
	2nd	2.686
	3rd	1.527
	4th	1.000
	5th	0.749
	6th	0.634
	Reverse	4.597
Transmission oil capacity [Reference value] liters (US gal./Imp gal.)		2.8 (0.74/0.62)

## AWR6B45 Model (Automatic Transmission)

Specifications		
Six-speed automatic transmission (overdrive gear for 5th and 6th), lock-up clutch for 3rd to 6th		
Gear ratio (to 1)	1st	3.600
	2nd	2.090
	3rd	1.488
	4th	1.000
	5th	0.687
	6th	0.580
	Reverse	3.732
Transmission fluid capacity [Reference value] liters (US gal./Imp gal.)		4J3 engine model: 9.6 (2.54/2.11) RZ4E engine model: 7.9 (2.09/1.74)

Transfer

T150 Model

Specifications	
Transfer type	Chain drive
Transfer gear ratio (to 1)	1.000 (High range), 2.482 (Low range)
Transfer oil capacity [Reference value] liters (US gal./Imp gal.)	1.3 (0.34/0.29)

Gross Axle Weight (GAW) and Gross Vehicle Weight (GVW) Ratings

Specifications	
GAW: Front kg (lb)	2WD High-Ride: 1,450 (3,197) 4WD: 1,450 (3,197)
GAW: Rear (Standard/Heavy duty suspension) kg (lb)	2WD High-Ride: 1,910 (4,212) 4WD: 1,910 (4,212)
GVW (Standard/Heavy duty suspension) kg (lb)	2WD High-Ride: 3,000 (6,615) 4WD: 3,100 (6,836)



## Service Specifications

## TFR40 Model

Engine	
Model	4JJ3-TCX
Engine oil capacity	Refer to page 8-2
Engine coolant capacity	

Transmission	
Model	Manual transmission model: MVL6S Automatic transmission model: AWR6B45
Transmission oil/fluid capacity	Refer to page 8-4

Rear axle	
Differential gear oil capacity [Reference value] <b>liters (US gal./Imp gal.)</b>	<b>1.6 (0.42/0.35)</b>

Fuel	
Fuel tank capacity [Reference value] <b>liters (US gal./Imp gal.)</b>	<b>76 (20.1/16.7)</b>

Steering	
Steering wheel free play	mm (in) 10 - 30 (0.39 - 1.18)
Power steering fluid capacity [Reference value] <b>liters (US gal./Imp gal.)</b>	HPS model: <b>1.0 (0.26/0.22)</b>

Wheel			
Wheel alignment	: Toe-in	(degree)	0° 26' ~ 0° 38'
	: Camber	(degree)	-0° 30' ~ 0° 30'
	: Caster	(degree)	2° 35' ~ 4° 05'
	: King pin	(degree)	12° 30'

Service brakes	
Brake pedal free play	Refer to page 6-58
Brake pedal height	Refer to page 6-58
Clearance between the brake pedal and the floor	Refer to page 6-58

Parking brake	
Lever effective stroke (Under pull force of approximately <b>294 N</b> (30 kgf/ <b>66 lb</b> ))	6 - 9 notches

Electrical system		
Battery type		EN: 375LN3
Starter	volt-kw	12 - 1.8
Generator	volt/amp.	12/90

**TFS40 Model**

Engine	
Model	4JJ3-TCX
Engine oil capacity	Refer to page 8-2
Engine coolant capacity	

Transmission	
Model	Manual transmission model: MVL6S Automatic transmission model: AWR6B45
Transmission oil/fluid capacity	Refer to page 8-4
Transfer oil capacity	Refer to page 8-5

Rear axle	
Differential gear oil capacity [Reference value] <b>liters (US gal./Imp gal.)</b>	<b>1.6 (0.42/0.35)</b>

Front axle	
Differential gear oil capacity [Reference value] <b>liters (US gal./Imp gal.)</b>	<b>1.24 (0.33/0.27)</b>

Fuel	
Fuel tank capacity [Reference value] <b>liters (US gal./Imp gal.)</b>	<b>76 (20.1/16.7)</b>

Steering	
Steering wheel free play	mm (in) 10 - 30 (0.39 - 1.18)
Power steering fluid capacity [Reference value] <b>liters (US gal./Imp gal.)</b>	HPS model: <b>1.0 (0.26/0.22)</b>

Wheel			
Wheel alignment	: Toe-in	(degree)	0° 26' ~ 0° 38'
	: Camber	(degree)	-0° 30' ~ 0° 30'
	: Caster	(degree)	2° 35' ~ 4° 05'
	: King pin	(degree)	12° 30'

Service brakes	
Brake pedal free play	Refer to page 6-58
Brake pedal height	Refer to page 6-58
Clearance between the brake pedal and the floor	Refer to page 6-58

Parking brake	
Lever effective stroke (Under pull force of approximately <b>294 N</b> (30 kgf/ <b>66 lb</b> ))	6 - 9 notches

Electrical system		
Battery type		EN: 375LN3
Starter	volt-kw	12 - 1.8
Generator	volt/amp.	12/90

**TFR87 Model**

Engine	
Model	RZ4E-TC
Engine oil capacity	Refer to page 8-3
Engine coolant capacity	

Transmission	
Model	Manual transmission model: MVL6Y Automatic transmission model: AWR6B45
Transmission oil/fluid capacity	Refer to page 8-4

Rear axle	
Differential gear oil capacity [Reference value] <b>liters (US gal./Imp gal.)</b>	<b>1.6 (0.42/0.35)</b>

Fuel	
Fuel tank capacity [Reference value] <b>liters (US gal./Imp gal.)</b>	<b>76 (20.1/16.7)</b>

Steering	
Steering wheel free play                      mm (in)	10 - 30 (0.39 - 1.18)
Power steering fluid capacity [Reference value] <b>liters (US gal./Imp gal.)</b>	<b>1.0 (0.26/0.22)</b>

Wheel			
Wheel alignment	: Toe-in	(degree)	0° 26' ~ 0° 38'
	: Camber	(degree)	-0° 30' ~ 0° 30'
	: Caster	(degree)	Cab chassis model: 2 55' Except cab chassis model: 2° 35' ~ 4° 05'
	: King pin	(degree)	12° 30'

Service brakes	
Brake pedal free play	Refer to page 6-58
Brake pedal height	Refer to page 6-58
Clearance between the brake pedal and the floor	Refer to page 6-58

Parking brake	
Lever effective stroke (Under pull force of approximately <b>294 N</b> (30 kgf/ <b>66 lb</b> ))	6 - 9 notches

Electrical system		
Battery type		EN: 375LN3
Starter	volt-kw	12 - 1.6
Generator	volt/amp.	12/90

**TFS87 Model**

Engine	
Model	RZ4E-TC
Engine oil capacity	Refer to page 8-3
Engine coolant capacity	

Transmission	
Model	Manual transmission model: MVL6Y Automatic transmission model: AWR6B45
Transmission oil/fluid capacity	Refer to page 8-4
Transfer oil capacity	Refer to page 8-5

Rear axle	
Differential gear oil capacity [Reference value] <b>liters (US gal./Imp gal.)</b>	<b>1.6 (0.42/0.35)</b>

Front axle	
Differential gear oil capacity [Reference value] <b>liters (US gal./Imp gal.)</b>	<b>1.24 (0.33/0.27)</b>

Fuel	
Fuel tank capacity [Reference value] <b>liters (US gal./Imp gal.)</b>	<b>76 (20.1/16.7)</b>

Steering	
Steering wheel free play	mm (in)
	10 - 30 (0.39 - 1.18)
Power steering fluid capacity [Reference value] <b>liters (US gal./Imp gal.)</b>	<b>1.0 (0.26/0.22)</b>

Wheel			
Wheel alignment	: Toe-in	(degree)	0° 26' ~ 0° 38'
	: Camber	(degree)	-0° 30' ~ 0° 30'
	: Caster	(degree)	2° 35' ~ 4° 05'
	: King pin	(degree)	12° 30'

Service brakes	
Brake pedal free play	Refer to page 6-58
Brake pedal height	Refer to page 6-58
Clearance between the brake pedal and the floor	Refer to page 6-58

Parking brake	
Lever effective stroke (Under pull force of approximately <b>294 N</b> (30 kgf/ <b>66 lb</b> ))	6 - 9 notches



Electrical system		
Battery type		EN: 375LN3
Starter	volt-kw	12 - 1.6
Generator	volt/amp.	12/90

## Others

## For the Republic of South Africa



**Passive Entry and Start System**

This vehicle's passive entry and start system conforms to the basic requirements of the Independent Communications Authority of South Africa (ICASA) and related regulations.

Model name	Model number	ICASA logo and approval number
WAM HI	IM1135AA	 TA-2020/6718 APPROVED
PESS FOB	IK4310E	 TA-2020/6716 APPROVED

**Remote Keyless Entry**

This vehicle's keyless entry system (radio remote control units for door-lock) conforms to the basic requirements of the Independent Communications Authority of South Africa (ICASA) and related regulations.

Model name	Model number	ICASA logo and approval number
WAM MID	IM2035BB	 TA-2020/6717 APPROVED
RKE TXE	IK3600F	 TA-2020/6721 APPROVED

**Immobilizer**

This vehicle's immobilizer system conforms to the basic requirements of the Independent Communications Authority of South Africa (ICASA) and related regulations.

Model name	Model number	ICASA logo and approval number
WAM LO	IM2005BB	 TA-2020/6758 <b>APPROVED</b>

**Tire Pressure Monitoring System**

This vehicle's tire pressure monitoring system conforms to the basic requirements of the Independent Communications Authority of South Africa (ICASA) and related regulations.

Model number	ICASA logo and approval number
AG2PF4	 TA-2020/5678 <b>APPROVED</b>



**Blind Spot Monitor**

This vehicle's blind spot monitor conforms to the basic requirements of the Independent Communications Authority of South Africa (ICASA) and related regulations.



Model number	ICASA logo and approval number
RS4	 TA-2016/3407 <b>APPROVED</b>

## For Republic of Zambia

## Passive Entry and Start System

Model name	Model number	Type Approval Ref
WAM HI	IM1135AA	 <b>ZICTA</b> ZMB/ZICTA/TA/2020/5/102
PESS FOB	IK4310E	 <b>ZICTA</b> ZMB/ZICTA/TA/2020/5/98

## Remote Keyless Entry

Model name	Model number	Type Approval Ref
WAM MID	IM2035BB	 <b>ZICTA</b> ZMB/ZICTA/TA/2020/5/101
RKE TXE	IK3600F	 <b>ZICTA</b> ZMB/ZICTA/TA/2020/5/96

## Immobilizer

Model name	Model number	Type Approval Ref
WAM LO	IM2005BB	 <b>ZICTA</b> ZMB/ZICTA/TA/2020/5/100

**Blind Spot Monitor**

Model number	Type Approval Ref
RS4	 <b>ZICTA</b> ZMB/ZICTA/TA/2017/6/7

## For the Republic of Botswana

## Passive Entry and Start System

Model name	Model number	Approval number
WAM HI	IM1135AA	BOCRA REGISTERED No: BOCRA/TA/2020/5408
PESS FOB	IK4310E	BOCRA REGISTERED No: BOCRA/TA/2020/5413

## Remote Keyless Entry

Model name	Model number	Approval number
WAM MID	IM2035BB	BOCRA REGISTERED No: BOCRA/TA/2020/5410
RKE TXE	IK3600F	BOCRA REGISTERED No: BOCRA/TA/2020/5407

## Immobilizer

Model name	Model number	Approval number
WAM LO	IM2005BB	BOCRA REGISTERED No: BOCRA/TA/2020/5409

## Blind Spot Monitor

Model number	Approval number
RS4	BOCRA REGISTERED No: BOCRA/TA/2019/4666

**For Republic of Ghana****Passive Entry and Start System**

Model name	Model number	Type Approval Ref
WAM HI	IM1135AA	NCA APPROVED: SRO-1M-7E4-X7D
PESS FOB	IK4310E	NCA APPROVED: SRO-1M-7E4-X88

**Remote Keyless Entry**

Model name	Model number	Type Approval Ref
WAM MID	IM2035BB	NCA APPROVED: SRO-H8-7E4-X90
RKE TXE	IK3600F	NCA APPROVED: SRO-1M-7E4-X7B

**Immobilizer**

Model name	Model number	Type Approval Ref
WAM LO	IM2005BB	NCA APPROVED: SRO-1M-7E4-X76

**Blind Spot Monitor**

Model number	Type Approval Ref
RS4	NCA APPROVED: 1R3-1M-7E1-0B7

**Federal Republic of Nigeria****Blind Spot Monitor**

Connection and use of this communications equipment is permitted by the Nigerian Communications Commission

**Statement of Compliance with UN R13 (ECE R13)**

Information required by European brake regulation UN R13 (ECE R13) (brake wear check procedure and the wear limit) is disclosed on the following website.

URL: <http://www.isuzu.co.jp/world/ci/brake/index.php>

**NOTE**

- The vehicle identification number (VIN) is necessary for confirmation of information.

**Vehicle Identification Number (VIN) and  
Engine Number → Refer to page 1-2**

**A**

Accessory Socket	5-31
Adaptive Cruise Control (ACC)	4-245
Air Cleaner	6-49
Air Outlets	5-2
Antenna	5-46
Anti-lock Brake System (ABS)	4-157
Anti-theft System	3-8
Attention Assist	4-304
Automatic Air Conditioner	5-5
Automatic High Beam (AHB)	4-306
Automatic Transmission	4-145
Automatic Transmission Fluid (Automatic Transmission Model)	6-89
Automatic Transmission Model	2-55
Autonomous Emergency Braking (AEB)	4-226

**B**

Before Driving	2-2
Blind Spot Monitor (BSM)	4-179
Bottle Holder and Small Article Storage Pocket (Front and Rear Doors)	5-43
Brake Assist Function	4-169
Brakes	6-56

**C**

Carrying Children	2-25
Cautions for Driving in Cold Regions	2-71
Cautions for Driving in Hot Regions	2-70
Center Console Box	5-39
Changing Tires	6-78
Checking Components that Showed Abnormalities during Previous Operation	6-18
Child Restraint System (CRS)	3-77
Clutch Fluid (Manual Transmission Model)	6-88
Coat Hook	5-45
Combination Light Control Switch	4-117
Cruise Control	4-151
Cup Holder	5-40
Cup Holder and Small Article Storage Pocket	5-41

**D**

Daily Checks (Preoperational Checks)	6-16
Dashboard Tray	5-37
Discarded Parts, Oils and Other Liquids	6-7
Doors	3-25
Driving	2-28

**E**

Electronic Braking force Distribution (EBD)	4-161
Electronic Stability Control (ESC)	4-162
Emergency Engine Starting (Models with Passive Entry and Start System)	7-11
Emergency Engine Stopping (Models with Passive Entry and Start System)	7-10
Emergency Lane Keeping (ELK)	4-287
Emergency Stop Signal (ESS)	4-170
Engine Conditions	6-20
Engine Coolant	6-39
Engine Coolant Temperature Gauge	4-18
Engine Hood	6-11
Engine Oil	6-22
Engine Start/Stop Button (Models with Passive Entry and Start System)	4-112
Exterior (PICTORIAL INDEX)	0-18
Exterior Maintenance	6-126

**F**

Fan Belt/Air Conditioning Compressor Belt/Accessory Belt	6-46
Four Wheel Drive (4WD) Model	2-60, 4-310
Front Fog Light Switch	4-126
Fuel Filter	6-51
Fuel Gauge	4-19
Fuel Tank Filler Cap	3-49
Fully Adjustable Steering	3-63

**G**

Getting In and Out of the Vehicle	3-43
Glove Compartment	5-36
Grip	5-44

**H**

Handling the Battery	6-115
Handling the Jack	6-73
Handling the Radiator and Intercooler	6-44
Hazard Warning Flasher Switch	4-127
Head Up Display	4-60
Headlight Leveling Switch	4-125
Hill Descent Control	4-172
Hill Start Assist	4-171
Hook	5-45
Horn Button	4-137
How to Read the Instruments (Instruments Layout)	4-14

**I**

Illumination Control Switch	4-140
Illumination of Center Display	4-27
Inspection and Maintenance	6-136
Interior (PICTORIAL INDEX)	0-6
Interior Lights	5-26
Interior Maintenance	6-130
Isuzu Genuine Oils and Grease	6-7

**K**

Key	3-2
Key with Immobilizer Transponder Chip	3-5
Keyless Entry System	3-11

**L**

Lane Departure Prevention (LDP)	4-278
Lane Departure Warning (LDW)	4-273
Lane Keep Assist System (LKAS)	4-296
Lights	6-102
Liquid Crystal Display (LCD)	4-50

**M**

Main Data and Specifications	8-2
Manual Air Conditioner	5-15
Manual Speed Limiter (MSL)	4-270
Manual Transmission	4-144
Manually Operated Windows	3-48
Mirrors	3-64
Multi-Collision Brake (MCB)	4-178
Multi-Information Display (MID)	4-28

**O**

Odometer and Trip Meter	4-17
Off-road Driving	2-46
Others	8-14
Overhead Console	5-29

**P**

Parking Aid System	4-197
Parking Brake	4-143, 6-61
Passenger Side SRS Airbag On-Off Switch	3-117
Passive Entry and Start System	3-17
Pedal Misapplication Mitigation	4-239
Pedals	4-142
Power Steering Fluid (Hydraulic Power Steering Model)	6-91
Power Windows	3-44
Precautions for Checking and Adjustments	6-4
Preventing Breakdowns	2-80

**R**

Rear Cross Traffic Alert (RCTA)	4-188
Rear Differential Lock Switch	4-128
Rear Fog Light Switch	4-126
Rear Vision Camera	5-48
Rear Window Defogger Switch	4-140
Refrigerant	6-124
Remote Control Mirror Switch	4-138
Remote Engine Start System	3-122
Replacing the Fuses and Relays	7-24
Retractable Power Mirror Switch	4-139

**S**

Seat Belt with Pretensioner and SRS Airbag System	2-20, 3-96
Seat Belts	3-67
Seats	3-53
Side Access Panel (Extended Cab Model)	3-38
Small Article Storage Pocket	5-34
Small Article Storage Pocket (Driver's Side)	5-38
Small Article Storage Pocket (Passenger's Side)	5-35
Small Article Storage Pocket (Upper Side of Dashboard)	5-37
Spare Tire	6-68
Speed Limit Device	2-87
Speedometer	4-16
Starter Switch (Models without Passive Entry and Start System)	4-115
Starting the Engine	4-4
Staying Safe	2-76
Steering Wheel	6-90
Steering Wheel Remote Control	5-47
Stereo Camera	4-210
Stopping and Parking	2-63
Stopping the Engine	4-10
Sun Visor	5-30

**T**

Tachometer	4-16
Tailgate	3-40
Ticket Holder	5-30
Tire Pressure Monitoring System (TPMS)	4-319
Tire Rotation	6-67
Tools	6-8
Towing	7-29
Trailer Sway Control	4-176
Trailer Towing	2-47
Troubleshooting	7-2

**U**

USB Power Outlet	5-33
------------------	------

**V**

Vanity Mirror	5-31
Vehicle Data Collection	2-87
Vehicle Identification Number (VIN) and Engine Number	1-2

**W**

Warning and Indicator Lights	4-61
Warning and Indicator Lights Layout	4-21
Warning Buzzer	4-106
Warning/Caution Labels in Your Vehicle	0-32
Warning/Indicator Light Index	0-19
Wheels and Tires	6-61
When Driving on Bad Roads	7-28
When the Battery Goes Flat	7-16
When the Brakes Do Not Work	7-15
When the Electronic Key Battery Goes Flat	7-7
When the Engine Oil Pressure Warning Light Comes On	7-21
When the Engine Overheats	7-22
When the Engine Stalls and Cannot Be Restarted	7-15
When the Engine Stops While Driving	7-14
When the Fuel Runs Out	7-18
When the Generator Warning Light Comes On	7-20
When the Light Does Not Come On	7-24
When the Tire Goes Flat	7-13
When the Vehicle Breaks Down during Driving	7-12
When the Warning Light Comes On	7-21
When to Visit Your Isuzu Dealer	2-84
Windshield Washer Fluid	6-94
Windshield Wiper and Windshield Washer Switch	4-131
Windshield Wiper Blades	6-95