

Stock Symbol:605369



PRODUCTS CATALOG



ZHEJIANG GONGDONG
MEDICAL TECHNOLOGY CO.,LTD

Products Catalog

GONG DONG MEDICAL
www.gongdong.com

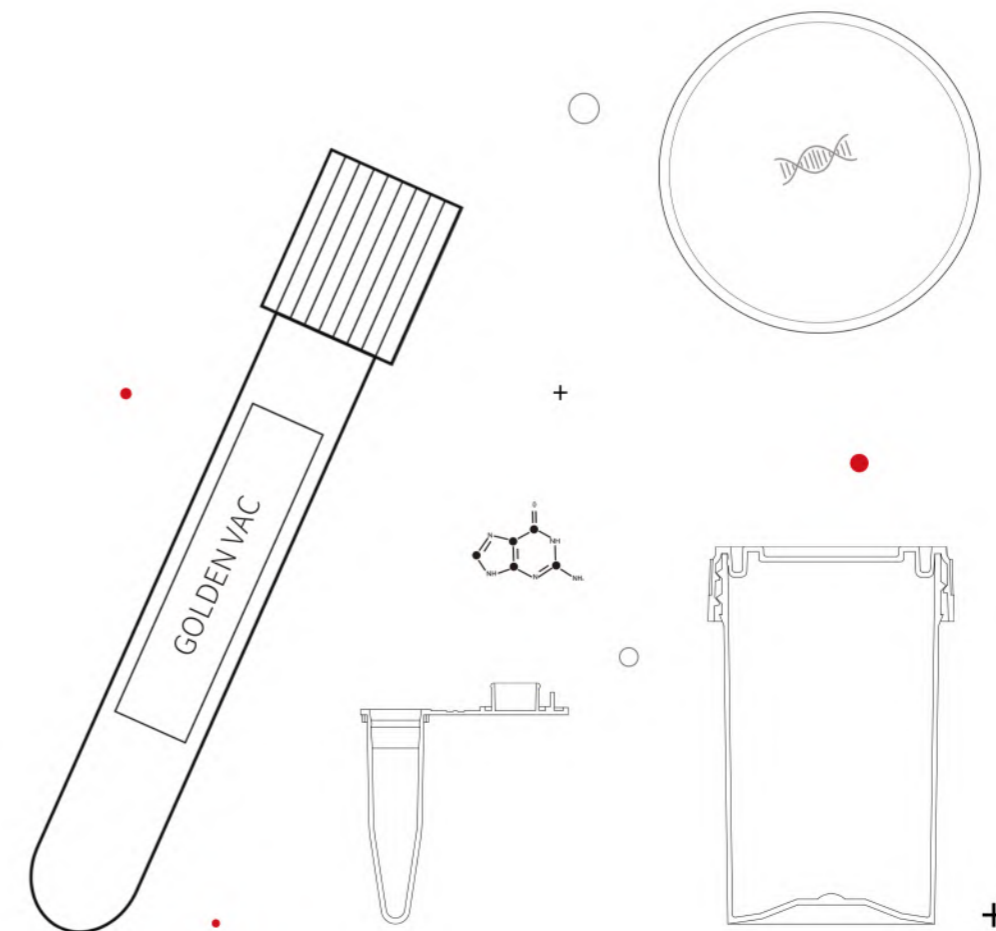

ZHEJIANG GONGDONG
MEDICAL TECHNOLOGY CO.,LTD

Headquarter:

Add: No. 10 Beiyuan Ave, Huangyan, Taizhou, Zhejiang, China

Tel: 0086 576 84115678

Fax: 0086 576 84050789 P.C:318020

U.S. Office:

Add: 1725 Business Center Drive, Duarte, CA 91010

Tel: 001 626-531-6551

E-mail:info@gongdong.com





COMPANY PROFILES

Zhejiang Gongdong Medical Technology Co., Ltd. was found in 1985 in the developed coastal city Huangyan, Taizhou. It's specialized in manufacturing disposable medical testing products. After thirty-two years' efforts, it has become a well-known company in the field of medical and laboratory wares in China, and also the member unit of China Association for Medical Device Industry. Nowadays it is regarded as a leader in the field of disposable medical wares.

Following by the concept of promoting health care, relying on technological innovation, Gongdong improves its product's technology content constantly, to make sure to provide the safe and effective products to the people. Until now it has five big series of items, but more than 300 types of products.

In order to follow the market trend and seek a far-reaching development, Gongdong got ISO and CE certificates in 2001, and also started to do exportation in the same year. Based on its famous brand name and many years' development experience, Gongdong has made great achievements: It's vacuum tube, vaginal speculum and petri dish are highly

enjoyed, particularly in the United States, Japan market; And it has built up a close business relation with some world-top 500 global corporations from medical treatment industry; Now, some famous global corporations from gene science and life field of science, start to cooperate with Gongdong, which makes Gongdong have further development in this advanced field of science.

Today, when the world economy develops steadily, but people requires more on medical and health care, which for sure pushes on development of medical research, diagnosis and supplies industries. It was just under this situation. Gongdong continues to be the leader in medical equipment industry.

While obtaining above great achievement, Gongdong also pay high attention to the talented, emphasizes on "People-Oriented, Team-Oriented", the employee of it understand well at it's policy "High Efficiency, High Quality, Development with Prosperity Together".

In future, Gongdong will redouble its' effort, keep improving products' technology and its' service, to develop more high-tech and new products, to contribute more to human being.

PULL ALL TOGETHER, AS QUALITY
ALWAYS THE FIRST





5t

5t

1-17
作业指引与生产记录

MA 2000 III

CHUANY Robot
750

750

机械活动区域内
请勿靠近
违者中止进入

消防
FIRE EXTINGUISHER

HIGH QUALITY HIGH EFFICIENCY DEVELOPMENT WITH PROSPER TOGETHER

Efficiency stressing speed, character striving for quality and the harmonious unification of speed and quality, which create Gongdong's belief in high standards of products.

Gongdong has always adhered to this idea, so that it can walk in the forefront of medical consumables industry.



CERTIFICATE

EC Certificate
Production Quality Assurance System
Directive 93/42/EEC on Medical Devices (MDD), Annex V
(Devices in Class IIa, IIb or IIc)
No. G2 18 03 42464 031

Manufacturer: Zhejiang Gongdong Medical Technology Co., Ltd.
No. 12 Shengshu Ave., Hangzhou
310020 Tachou, Zhejiang
PEOPLE'S REPUBLIC OF CHINA

EC-Representative: Shanghai International Holding Corp. GmbH (Europe)
Erfurter Str.
20537 Hamburg
GERMANY

Product Category(ies): Disposable Vacuum Blood Collection System, Disposable Umbilical Cord Scissors

The Certification Body of TÜV SÜD Product Service GmbH declares that the aforementioned manufacturer has implemented a quality assurance system for manufacture and final inspection of the respective device / device categories in accordance with MDD Annex V. This quality assurance system conforms to the requirements of the Directive and is subject to periodic surveillance. For manufacturing of class IIa and IIb devices an additional Annex II certificate is mandatory. See also notes overleaf.

Report No.: SH18116XT01
Valid from: 2018-06-05
Valid until: 2023-06-05
Date: 2019-04-03
I. Punnit
(Date Print)

TÜV SÜD Product Service GmbH is a Notified Body with identification no. 0123
Page 1 of 2
TÜV SÜD Product Service GmbH · Zähringerstraße · Röhrenstraße 65 · 40238 Mönchengladbach · Germany · TÜV

EC Certificate
Production Quality Assurance System
Directive 93/42/EEC on Medical Devices (MDD), Annex V
(Devices in class IIc in certain conditions, implanted systems or pressure packs)
No. G2B 042464 0034 Rev. 00

Manufacturer: Zhejiang Gongdong Medical Technology Co., Ltd.
No. 12 Shengshu Ave., Hangzhou
310020 Tachou, Zhejiang
PEOPLE'S REPUBLIC OF CHINA

Product Category(ies): Disposable Plastic Forceps, Disposable Vaginal Speculum, Disposable Sterile Swabs, Transportation Swabs with Medium, Disposable Anoscope, Sterile Vaginal Applicator

The Certification Body of TÜV SÜD Product Service GmbH declares that the aforementioned manufacturer has implemented a quality assurance system for manufacture in accordance with MDD Annex V. This quality assurance system covers those aspects of manufacture concerned with securing and maintaining sterile conditions of the respective device / device categories and conforms to the requirements of the Directive. It is subject to periodic surveillance. See also notes overleaf.

Report No.: SH18116XT01
Valid from: 2019-11-04
Valid until: 2024-05-26
Date: 2019-11-04
C. O. H.
Christoph Oels
Head of Certification/Notified Body

Page 1 of 2
TÜV SÜD Product Service GmbH is a Notified Body with identification no. 0123
TÜV SÜD Product Service GmbH · Certification Body · Röhrenstraße 65 · 40238 Mönchengladbach · Germany · TÜV



Confirmation Statement on validity of EC Certificate (MDD)
pursuant to Directive 93/42/EEC concerning medical devices
No. G2C 042464 0035 Rev. 00

Manufacturer: Zhejiang Gongdong Medical Technology Co., Ltd.
No. 12 Shengshu Ave., Hangzhou
310020 Tachou, Zhejiang
PEOPLE'S REPUBLIC OF CHINA

This Confirmation Statement is only valid in combination with the following EC Certificate (MDD): G2B 042464 0034 Rev. 00

This Confirmation Statement confirms the validity of the aforementioned EC Certificate MDD. It considers clarification of scope statements, scope reductions and changes to the manufacturer data entered in May 2021 or later. The conditions laid down in Article 120 (2) of Regulation (EU) 2017/745 on medical devices for placing devices on the market and putting into service apply.

Report No.: SH2111102
Valid until: 2024-05-26
Issue Date: 2022-09-05
C. O. H.
Christoph Oels
Head of Certification/Notified Body

Page 1 of 2
TÜV SÜD Product Service GmbH is a Notified Body with identification no. 0123
TÜV SÜD Product Service GmbH · Certification Body · Röhrenstraße 65 · 40238 Mönchengladbach · Germany · TÜV

Confirmation Statement on validity of EC Certificate (MDD)
pursuant to Directive 93/42/EEC concerning medical devices
No. G2C 042464 0036 Rev. 00

Manufacturer: Zhejiang Gongdong Medical Technology Co., Ltd.
No. 12 Shengshu Ave., Hangzhou
310020 Tachou, Zhejiang
PEOPLE'S REPUBLIC OF CHINA

This Confirmation Statement is only valid in combination with the following EC Certificate (MDD): G2 18 03 42464 031

This Confirmation Statement confirms the validity of the aforementioned EC Certificate MDD. It considers clarification of scope statements, scope reductions and changes to the manufacturer data entered in May 2021 or later. The conditions laid down in Article 120 (2) of Regulation (EU) 2017/745 on medical devices for placing devices on the market and putting into service apply.

Report No.: SH2111102
Valid until: 2023-05-06
Issue Date: 2022-09-05
C. O. H.
Christoph Oels
Head of Certification/Notified Body

Page 1 of 2
TÜV SÜD Product Service GmbH is a Notified Body with identification no. 0123
TÜV SÜD Product Service GmbH · Certification Body · Röhrenstraße 65 · 40238 Mönchengladbach · Germany · TÜV

U.S. FOOD & DRUG ADMINISTRATION
Establishment Registration & Device Listing

Establishment	Registration Number	Current Registration Ex. Pr.
Zhejiang Gongdong Medical Technology Co., Ltd.	CHN017905	2026
Guangdong Lanyang Medical Device Manufacturing Co., Ltd.	CHN017906	2026
Guangdong Lanyang Medical Device Manufacturing Co., Ltd.	CHN017907	2026
Guangdong Lanyang Medical Device Manufacturing Co., Ltd.	CHN017908	2026
Guangdong Lanyang Medical Device Manufacturing Co., Ltd.	CHN017909	2026
Guangdong Lanyang Medical Device Manufacturing Co., Ltd.	CHN017910	2026
Guangdong Lanyang Medical Device Manufacturing Co., Ltd.	CHN017911	2026
Guangdong Lanyang Medical Device Manufacturing Co., Ltd.	CHN017912	2026
Guangdong Lanyang Medical Device Manufacturing Co., Ltd.	CHN017913	2026
Guangdong Lanyang Medical Device Manufacturing Co., Ltd.	CHN017914	2026
Guangdong Lanyang Medical Device Manufacturing Co., Ltd.	CHN017915	2026
Guangdong Lanyang Medical Device Manufacturing Co., Ltd.	CHN017916	2026
Guangdong Lanyang Medical Device Manufacturing Co., Ltd.	CHN017917	2026
Guangdong Lanyang Medical Device Manufacturing Co., Ltd.	CHN017918	2026
Guangdong Lanyang Medical Device Manufacturing Co., Ltd.	CHN017919	2026
Guangdong Lanyang Medical Device Manufacturing Co., Ltd.	CHN017920	2026
Guangdong Lanyang Medical Device Manufacturing Co., Ltd.	CHN017921	2026
Guangdong Lanyang Medical Device Manufacturing Co., Ltd.	CHN017922	2026
Guangdong Lanyang Medical Device Manufacturing Co., Ltd.	CHN017923	2026
Guangdong Lanyang Medical Device Manufacturing Co., Ltd.	CHN017924	2026
Guangdong Lanyang Medical Device Manufacturing Co., Ltd.	CHN017925	2026
Guangdong Lanyang Medical Device Manufacturing Co., Ltd.	CHN017926	2026
Guangdong Lanyang Medical Device Manufacturing Co., Ltd.	CHN017927	2026
Guangdong Lanyang Medical Device Manufacturing Co., Ltd.	CHN017928	2026
Guangdong Lanyang Medical Device Manufacturing Co., Ltd.	CHN017929	2026
Guangdong Lanyang Medical Device Manufacturing Co., Ltd.	CHN017930	2026
Guangdong Lanyang Medical Device Manufacturing Co., Ltd.	CHN017931	2026
Guangdong Lanyang Medical Device Manufacturing Co., Ltd.	CHN017932	2026
Guangdong Lanyang Medical Device Manufacturing Co., Ltd.	CHN017933	2026
Guangdong Lanyang Medical Device Manufacturing Co., Ltd.	CHN017934	2026
Guangdong Lanyang Medical Device Manufacturing Co., Ltd.	CHN017935	2026
Guangdong Lanyang Medical Device Manufacturing Co., Ltd.	CHN017936	2026
Guangdong Lanyang Medical Device Manufacturing Co., Ltd.	CHN017937	2026
Guangdong Lanyang Medical Device Manufacturing Co., Ltd.	CHN017938	2026
Guangdong Lanyang Medical Device Manufacturing Co., Ltd.	CHN017939	2026
Guangdong Lanyang Medical Device Manufacturing Co., Ltd.	CHN017940	2026
Guangdong Lanyang Medical Device Manufacturing Co., Ltd.	CHN017941	2026
Guangdong Lanyang Medical Device Manufacturing Co., Ltd.	CHN017942	2026
Guangdong Lanyang Medical Device Manufacturing Co., Ltd.	CHN017943	2026
Guangdong Lanyang Medical Device Manufacturing Co., Ltd.	CHN017944	2026
Guangdong Lanyang Medical Device Manufacturing Co., Ltd.	CHN017945	2026
Guangdong Lanyang Medical Device Manufacturing Co., Ltd.	CHN017946	2026
Guangdong Lanyang Medical Device Manufacturing Co., Ltd.	CHN017947	2026
Guangdong Lanyang Medical Device Manufacturing Co., Ltd.	CHN017948	2026
Guangdong Lanyang Medical Device Manufacturing Co., Ltd.	CHN017949	2026
Guangdong Lanyang Medical Device Manufacturing Co., Ltd.	CHN017950	2026

U.S. Food and Drug Administration
U.S. Department of Health & Human Services



CONTENTS

01

Vacuum Blood Collection System

27

Specimen Containers

36

Petri Dishes

39

Nursing Plasticware Series

44

Centrifuge Tube
Cryo Vials series

51

Pipette Tips

56

Culture Plate & Pipette Series

62

Test Tubes & Racks Series

69

Cuvettes & Sample Cups

75

Other Disposable Plasticwares

77

Pharmaceutical Packaging Materials

Category	Item	Additive	Cap Color	Tube material	Tube cap	Tube Size (mm)	Test Item
Serum Blood Collection Tube	Plain Tube	Plain	Red	Glass/Plastic		13*75 13*100 16*100	Clinical Biochemistry, Immunology and Serology Test
						16*100	
	Pro-coagulation Tube	Clot Activator	Red	Glass/Plastic		13*75 13*100 16*100	
						16*100	
	Gel & Clot Activator Tube	Gel & Coagulant	Yellow	Glass/Plastic		13*75 13*100 16*100	
						16*100	
Whole Blood Collection Tube	EDTA Tube	Sprayed K2EDTA/ Sprayed K3EDTA	Purple	Glass/Plastic		13*75 13*100 16*100	Haematology Test (Blood Routine Examination)
						16*100	
	ESR Tube	3.8% Sodium Citrate Buffer(0.129mol/L)	Black	Glass/Plastic		13*75	Erythrocyte Sedimentation Rate Test
						8*120	
Plasma Blood Collection Tube	Coagulation Tube	3.2% Sodium Citrate Buffer(0.109mol/L)	Blue	Glass/Plastic		13*75 13*100	Coagulation Function Test
						10.25*64	

Category	Item	Additive	Cap Color	Tube material	Tube cap	Tube Size (mm)	Test Item
Plasma Blood Collection Tube	Heparin Tube	Sodium Heparin/ Lithium Heparin	Green	Glass/Plastic		13*75 13*100 16*100	Clinical Chemistry for Emergency Treatment,Blood Rheology Test
	Gel & Heparin Tube	Gel & Sodium Heparin/ Gel & Lithium Heparin	Green	Glass/Plastic		16*100	
						13*75 13*100 16*100	
	Glucose Tube	Sodium Fluoride & Sodium Heparin/ Sodium Fluoride & EDTA/ Sodium Fluoride & Potassium Oxalate	Grey	Glass/Plastic		13*75 13*100	Glucose and Lactate Test
	EDTA & Gel Tube	Gel & Sprayed K2EDTA/ Gel & Sprayed K3EDTA	Purple	Glass/Plastic		13*75 13*100 16*100	Molecular Biology Test (Such as PCR)
					16*100		



Golden Vac™ Vacuum Blood Collection System

As a leading manufacturer of medical and laboratory plastic consumables in China over 36 years with ISO13485:2016 and CE certification, Gongdong continuously invests in new and innovated technologies to improve quality control and customers satisfaction throughout whole procedures.

- Fully automated production lines distribute to reliable and accurate digital inspection individually using a robotic imaging system
- Automatic labeling machines provide speed and high-precision by intelligent control with optimal readability Provide customized services for different requirements as various dimensions, labeling, or precise adjustments compatible with increasing altitude
- End-user and distributor training plans provided by our professional team
- Centrifugation: ≤ 1300 g (RCF) for 10 minutes at 18-25° C.



Golden Vac™ Closures



- Various stopper colors conform with international standards.
- Rubber stopper is recessed inside the plastic shield to avoid potential contact from any blood drops left by a collection needle.
- High quality rubber stopper provides maximum sealing with easy puncturing and reliable self-sealing after needle piercing and preventing any possible interactions with blood samples in tubes.
- With lower residuals and impurities by suitable rubber formulation, rubber stopper chips seldom occur during needle piercing. And it also provides lower insertion forces and lower pulling forces.
- Gongdong patented non screw safety twist caps with strong, durable construction can be removed with a gentle pull, making outer plastic shield and interior rubber stopper more secured.
- Universal closures/safe-lock closures/rubber stoppers are available.
- Compatible with multi-types of automated analyzers.



Golden Vac™ Tubes



- Versatile tubes and reliable additives for optimal performance in the laboratory.
- Tubes are made of medical grade virgin polyethylene terephthalate (PET), clear as glass with equal or better performance, offer low permeability to solvents, eliminating breakage when tubes are centrifuged at higher speed or when stopper is removed and reinserted, to reduce risk of tube breakage during handling.
- Interior tube wall is coated with microscopic silica particles which activate clotting when tubes are gently inverted.
- Suitable for incineration or autoclaving; no harmful gas is generated.



Golden Vac™ Separator Gel

- High quality and reliable inert separation gel is ideal for the collection, storage, and transport of undiluted plasma for molecular diagnostics testing. When the tube is centrifuged, the separation gel migrates and forms a stable barrier between the plasma and most of the cellular elements without any interference to blood testing.

Preset Vacuum & High-Quality Additives



- Preset standard ration additives based on CLSI and CCCLS recommendation.
- Accurate preset vacuum level in the tubes ensure precise blood drawing.
- Various additives are ultrasonically spray-dried on interior wall to make sure coagulation or anticoagulation more thoroughly.

Vacuum Tubes for High Altitude



- Customized vacuum tube for high altitude to make sure accurate blood drawing in different area.

Serum Clot Activator Tube

Golden Vac™ serum clot activator tube is to obtain serum specimen used for serum determinations in chemistry, serology, and immunohematology.

Description

- Silica particles act as the clot activator.
- Blood clotting promoted with ultrasonically spray-dried silica particles on the interior tube wall.
- Gently mix the blood collection tube by inverting 5-6 times immediately to activate clotting after blood drawing.
- To obtain serum, tube should be allowed to stand for 30 minutes or until the clot is formed.
- **Centrifugation:** ≤ 1300 g (RCF) for 10 minutes at 18-25° C.



Plain Tube

Golden Vac™ plain tubes with no additives for biochemistry, immunology and serology test.

Description

- Naturally separate out the blood cells and fibrin.
- The intact serum is suitable for a wide range of lab operation.



Cat. No	Volume/ml	Size/mm	Additive	Separator	Material	Cap Color	Closure
GD020CA	2.0	13X75	Clot Activator	/	PET/GLASS		Safety Cap+Rubber
GD030CA	3.0	13X75	Clot Activator	/	PET/GLASS		Safety Cap+Rubber
GD040CA	4.0	13X75	Clot Activator	/	PET/GLASS		Safety Cap+Rubber
GD050CA	5.0	13X75	Clot Activator	/	PET/GLASS		Safety Cap+Rubber
GD060CA	6.0	13X100	Clot Activator	/	PET/GLASS		Safety Cap+Rubber
GD070CA	7.0	13X100	Clot Activator	/	PET/GLASS		Safety Cap+Rubber
GD090CA	9.0	16X100	Clot Activator	/	PET/GLASS		Safety Cap+Rubber
GD0100CA	10.0	16X100	Clot Activator	/	PET/GLASS		Safety Cap+Rubber
GD090CAR	9.0	16X100	Clot Activator	/	PET/GLASS		Rubber Stopper
GA0100CAR	10.0	16X100	Clot Activator	/	PET/GLASS		Rubber Stopper

- Available in a range of 1-10ml blood collection tubes.
- All tubes are supplied in 1000pcs or 1200 pcs/ctn.

Cat. No	Volume/ml	Size/mm	Additive	Separator	Material	Cap Color	Closure
GD020A	2.0	13X75	/	/	PET/GLASS		Safety Cap+Rubber
GD030A	3.0	13X75	/	/	PET/GLASS		Safety Cap+Rubber
GD040A	4.0	13X75	/	/	PET/GLASS		Safety Cap+Rubber
GD050A	5.0	13X75	/	/	PET/GLASS		Safety Cap+Rubber
GD060A	6.0	13X100	/	/	PET/GLASS		Safety Cap+Rubber
GD070A	7.0	13X100	/	/	PET/GLASS		Safety Cap+Rubber
GD090A	9.0	16X100	/	/	PET/GLASS		Safety Cap+Rubber
GD0100A	10.0	16X100	/	/	PET/GLASS		Safety Cap+Rubber
GD090AR	9.0	16X100	/	/	PET/GLASS		Rubber Stopper
GA0100AR	10.0	16X100	/	/	PET/GLASS		Rubber Stopper

- Available in a range of 1-10ml blood collection tubes.
- All tubes are supplied in 1000pcs or 1200 pcs/ctn.

EDTA Tube

Golden Vac™ EDTA Tubes contain EDTA as an anticoagulant, are widely used for determinations in EDTA whole blood clinical hematology test, especially for routine blood examination.

Description

- The EDTA inhibits the coagulation process by eliminating the calcium in the blood.
- Available in K2 · EDTA or K3 · EDTA.
- The anticoagulant effect of K3 · EDTA is stronger than that of K2 · EDTA. K3 · EDTA results in greater RBC shrinkage and produces a larger increase in cell volume on standing.
- Ultrasonically and finely coated to make sure accurate additives.
- After the tube has been filled with blood, immediately invert the tube 8-10 times to mix and ensure adequate anticoagulation of the specimen.
- **Centrifugation:** 1100 g for 10 minutes at 18-25° C (Only for EDTA tubes with separator gel)



Cat. No	Volume/ml	Size/mm	Additive	Separator	Material	Cap Color	Closure
GD020EK2	2.0	13X75	K2 · EDTA	/	PET/GLASS		Safety Cap+Rubber
GD030EK2	3.0	13X75	K2 · EDTA	/	PET/GLASS		Safety Cap+Rubber
GD040EK2	4.0	13X75	K2 · EDTA	/	PET/GLASS		Safety Cap+Rubber
GD050EK2	5.0	13X75	K2 · EDTA	/	PET/GLASS		Safety Cap+Rubber
GD060EK2	6.0	13X100	K2 · EDTA	/	PET/GLASS		Safety Cap+Rubber
GD070EK2	7.0	13X100	K2 · EDTA	/	PET/GLASS		Safety Cap+Rubber
GD080EK2	8.0	16X100	K2 · EDTA	/	PET/GLASS		Safety Cap+Rubber
GD090EK2	9.0	16X100	K2 · EDTA	/	PET/GLASS		Safety Cap+Rubber
GD0100EK2	10.0	16X100	K2 · EDTA	/	PET/GLASS		Safety Cap+Rubber
GD0100EK2R	10.0	16X100	K2 · EDTA	/	PET/GLASS		Rubber Stopper

Cat. No	Volume/ml	Size/mm	Additive	Separator	Material	Cap Color	Closure
GD020EK3	2.0	13X75	K3 · EDTA	/	PET/GLASS		Safety Cap+Rubber
GD030EK3	3.0	13X75	K3 · EDTA	/	PET/GLASS		Safety Cap+Rubber
GD040EK3	4.0	13X75	K3 · EDTA	/	PET/GLASS		Safety Cap+Rubber
GD050EK3	5.0	13X75	K3 · EDTA	/	PET/GLASS		Safety Cap+Rubber
GD060EK3	6.0	13X100	K3 · EDTA	/	PET/GLASS		Safety Cap+Rubber
GD070EK3	7.0	13X100	K3 · EDTA	/	PET/GLASS		Safety Cap+Rubber
GD080EK3	8.0	16X100	K3 · EDTA	/	PET/GLASS		Safety Cap+Rubber
GD090EK3	9.0	16X100	K3 · EDTA	/	PET/GLASS		Safety Cap+Rubber
GD0100EK3	10.0	16X100	K3 · EDTA	/	PET/GLASS		Safety Cap+Rubber
GD0100EK3R	10.0	16X100	K3 · EDTA	/	PET/GLASS		Rubber Stopper

Cat. No	Volume/ml	Size/mm	Additive	Separator	Material	Cap Color	Closure
GD035EK2G	3.5	13X75	K2 · EDTA	Gel	PET/GLASS		Safety Cap+Rubber
GD060EK2G	6.0	13X100	K2 · EDTA	Gel	PET/GLASS		Safety Cap+Rubber
GD085EK2G	8.5	16X100	K2 · EDTA	Gel	PET/GLASS		Safety Cap+Rubber
GD085EK2RG	8.5	16X100	K2 · EDTA	Gel	PET/GLASS		Rubber Stopper
GD035EK3G	3.5	13X75	K3 · EDTA	Gel	PET/GLASS		Safety Cap+Rubber
GD060EK3G	6.0	13X100	K3 · EDTA	Gel	PET/GLASS		Safety Cap+Rubber
GD085EK3G	8.5	16X100	K3 · EDTA	Gel	PET/GLASS		Safety Cap+Rubber
GD085EK3RG	8.5	16X100	K3 · EDTA	Gel	PET/GLASS		Rubber Stopper

- All tubes are supplied in 1000pcs or 1200 pcs/ctn.

ESR Tube

For the manual determination of erythrocyte sedimentation rates with ESR stand.

Description

- Sodium citrate is used as anticoagulant to prevent blood from clotting.
- Filled with a buffered sodium citrate solution in a concentration of 0.129mol/L (3.8%).
- The blood to additive ratio is 4:1.
- After ESR tube has been filled with blood, immediately invert the tube 8-10 times to mix and ensure adequate anticoagulation of the specimen.



Cat. No	Volume/ml	Size/mm	Additive	Separator	Material	Cap Color	Closure
GD016ESR	1.6	8X120	Sodium Citrate 3.8%	/	PET/GLASS		Safety Cap+Rubber
GD0128ESR	1.28	8X120	Sodium Citrate 3.8%	/	PET/GLASS		Safety Cap+Rubber
GD016ESRN	1.6	9X120	Sodium Citrate 3.8%	/	PET/GLASS		Safety Cap+Rubber

- All tubes are supplied in 1000pcs or 1200 pcs/ctn.

ESR Tube Rack

Immediately before the tubes are placed in the ESR tube rack for measurement, the tubes must be mixed again. After one or two hours the results are read. The ESR tube rack holds a maximum of 10 ESR tubes and has a height adjustable zero mark. The measurement results achieved correspond to the Westergren method.

Cat. No	Size/mm
H1020A	ESR Tube Rack, for ESR 8X120mm, 1.6ml tube
H1020B	ESR Tube Rack, for ESR 8X120mm, 1.28ml tube

- All tube racks are supplied in cases of 10pcs.

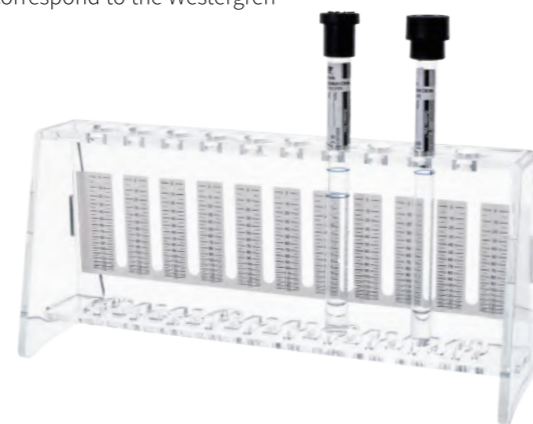

Coagulation Tube

Golden Vac™ blue-top blood collection tubes are used for clinical coagulation tests.

Description

- Sodium citrate is used as anticoagulant to prevent blood from clotting.
- Filled with a buffered sodium citrate solution in a concentration of 0.109mol/L (3.2%).
- The blood to additive ratio is 9:1. The ratio of blood to anticoagulant is critical for valid prothrombin time results.
- Immediately after draw, gently invert the tube 3-4 times in order to activate adequate anticoagulant.
- Aluminum composite bags available to provide optimum protection against additive evaporation, UV light, dirt and mechanical influences.
- All the necessary custom service options to fulfill your project requirements.
- **Centrifugation:** 2000-2500g for 10-15 minutes at 18-25° C.



Cat. No	Volume/ml	Size/mm	Additive	Separator	Material	Cap Color	Closure
GD018SC	1.8	13X75	Sodium Citrate 3.2%	/	PET/GLASS		Safety Cap+Rubber
GD027SC	2.7	13X75	Sodium Citrate 3.2%	/	PET/GLASS		Safety Cap+Rubber
GD036SC	3.6	13X75	Sodium Citrate 3.2%	/	PET/GLASS		Safety Cap+Rubber
GD045SC	4.5	13X75	Sodium Citrate 3.2%	/	PET/GLASS		Safety Cap+Rubber
GD018SC-F	1.8	10.25X64	Sodium Citrate 3.2%	/	PET/GLASS		Safety Cap+Rubber
GD027SC-F	2.7	10.25X64	Sodium Citrate 3.2%	/	PET/GLASS		Safety Cap+Rubber

- All tubes are supplied in 1000pcs or 1200 pcs/ctn.
- All tubes (Flat Bottom) are supplied in 1000pcs/ctn.

Double-wall tubes

Golden Vac™ blue-top blood tubes specially designed with double walls are made of PP (polypropylene) and PET (polyethylene terephthalate). PP is ideal for sensitive coagulation parameters due to its nonreactive characteristics. The inner tube is made of PP and prevents the evaporation of liquid. The outer tube is made of PET and ensures a long shelf-life for the vacuum.

Description

- Sodium citrate is used as anticoagulant to prevent blood from clotting. Filled with a buffered sodium citrate solution in a concentration of 0.109mol/L (3.2%).
- The blood to additive ratio is 9:1. The ratio of blood to anticoagulant is critical for valid prothrombin time results.
- Immediately after draw, gently invert the tube 3-4 times in order to activate adequate anticoagulant.
- **Centrifugation:** 2000-2500 g for 10-15 minutes at 18-25° C.

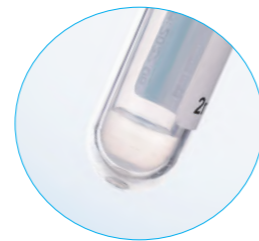

Cat. No	Volume/ml	Size/mm	Additive	Separator	Material	Cap Color	Closure
GD018SCD	1.8	13X75	Sodium Citrate 3.2%	/	PET (Double Wall)		Safety Cap+Rubber
GD027SCD	2.7	13X75	Sodium Citrate 3.2%	/	PET (Double Wall)		Safety Cap+Rubber

- All tubes are supplied in 1000pcs or 1200 pcs/ctn.

Heparin Tube

Golden Vac™ heparin tube is used for drawing heparinized plasma or whole blood for emergency biochemical and hemorheological tests.

Description

- Available in lithium heparin and sodium heparin.
- The anticoagulant heparin activates antithrombin, which blocks the clotting cascade and thus produces a whole blood/plasma sample.
- Lithium heparin has no interference with all ion detection during testing, including sodium ion.
- Immediately after draw, gently invert the tube 8-10 times in order to activate adequate anticoagulant.
- **Centrifugation:** ≤ 1300 g (RCF) for 10 minutes at 18-25° C.



Cat. No	Volume/ml	Size/mm	Additive	Separator	Material	Cap Color	Closure
GD020LH	2.0	13X75	Lithium Heparin	/	PET/GLASS		Safety Cap+Rubber
GD030LH	3.0	13X75	Lithium Heparin	/	PET/GLASS		Safety Cap+Rubber
GD040LH	4.0	13X75	Lithium Heparin	/	PET/GLASS		Safety Cap+Rubber
GD050LH	5.0	13X75	Lithium Heparin	/	PET/GLASS		Safety Cap+Rubber
GD060LH	6.0	13X100	Lithium Heparin	/	PET/GLASS		Safety Cap+Rubber
GD070LH	7.0	13X100	Lithium Heparin	/	PET/GLASS		Safety Cap+Rubber
GD080LH	8.0	16X100	Lithium Heparin	/	PET/GLASS		Safety Cap+Rubber
GD090LH	9.0	16X100	Lithium Heparin	/	PET/GLASS		Safety Cap+Rubber
GD0100LH	10.0	16X100	Lithium Heparin	/	PET/GLASS		Safety Cap+Rubber
GD0100LHR	10.0	16X100	Lithium Heparin	/	PET/GLASS		Rubber Stopper

Cat. No	Volume/ml	Size/mm	Additive	Separator	Material	Cap Color	Closure
GD020SH	2.0	13X75	Sodium Heparin	/	PET/GLASS		Safety Cap+Rubber
GD030SH	3.0	13X75	Sodium Heparin	/	PET/GLASS		Safety Cap+Rubber
GD040SH	4.0	13X75	Sodium Heparin	/	PET/GLASS		Safety Cap+Rubber
GD050SH	5.0	13X75	Sodium Heparin	/	PET/GLASS		Safety Cap+Rubber
GD060SH	6.0	13X100	Sodium Heparin	/	PET/GLASS		Safety Cap+Rubber
GD070SH	7.0	13X100	Sodium Heparin	/	PET/GLASS		Safety Cap+Rubber
GD080SH	8.0	16X100	Sodium Heparin	/	PET/GLASS		Safety Cap+Rubber

Cat. No	Volume/ml	Size/mm	Additive	Separator	Material	Cap Color	Closure
GD090SH	9.0	16X100	Sodium Heparin	/	PET/GLASS		Safety Cap+Rubber
GD0100SH	10.0	16X100	Sodium Heparin	/	PET/GLASS		Safety Cap+Rubber
GD0100SHR	10.0	16X100	Sodium Heparin	/	PET/GLASS		Rubber Stopper

- Available in a range of 1-10ml blood collection tubes
- All tubes are supplied in 1000pcs or 1200 pcs/ctn.

Heparin Tube (Separator Gel)

These Golden Vac™ heparin tubes contain a polymer separation gel and spray-dried heparin additive.

Description

- Available in lithium heparin and sodium heparin.
- The anticoagulant heparin activates antithrombin, which blocks the clotting cascade and thus produces a whole blood/plasma sample.
- Lithium heparin has no interference with all ion detection during testing, including sodium ion.
- The separation gel separates the plasma from the blood cells during centrifugation, preventing contamination of the plasma.
- Immediately after draw, gently invert the tube 8-10 times in order to activate adequate anticoagulant.
- **Centrifugation:** 1800-2200g for 8-15 minutes at 18-25° C.



Cat. No	Volume/ml	Size/mm	Additive	Separator	Material	Cap Color	Closure
GD030LHG	3.0	13X75	Heparin Lithium	Gel	PET/GLASS		Safety Cap+Rubber
GD040LHG	4.0	13X75	Heparin Lithium	Gel	PET/GLASS		Safety Cap+Rubber
GD050LHG	5.0	13X100	Heparin Lithium	Gel	PET/GLASS		Safety Cap+Rubber
GD085LHG	8.5	16X100	Heparin Lithium	Gel	PET/GLASS		Safety Cap+Rubber

Cat. No	Volume/ml	Size/mm	Additive	Separator	Material	Cap Color	Closure
GD030SHG	3.0	13X75	Heparin Lithium	Gel	PET/GLASS		Safety Cap+Rubber
GD040SHG	4.0	13X75	Heparin Lithium	Gel	PET/GLASS		Safety Cap+Rubber
GD050SHG	5.0	13X100	Heparin Lithium	Gel	PET/GLASS		Safety Cap+Rubber
GD085SHG	8.5	16X100	Heparin Lithium	Gel	PET/GLASS		Safety Cap+Rubber

- All tubes are supplied in 1000pcs or 1200 pcs/ctn.

Glucose Tube

Golden Vac™ glucose tube is used for blood glucose, glucose tolerance, red blood cell electrophoresis, sugar hemoglobin, etc.

Description

- Obtain highly stable plasma for blood glucose testing.
- Sodium Fluoride is an inhibitor of glucose degradation.
- Potassium Oxalate, EDTA Na₂, and Heparin Sodium prevent blood coagulation and avoid blood hemolysis.
- Immediately after draw, gently invert the tube 8-10 times in order to activate adequate anticoagulant.
- **Centrifugation:** ≤ 1300 g (RCF) for 10 minutes at 18-25° C.



Cat. No	Volume/ml	Size/mm	Additive	Separator	Material	Cap Color	Closure
GD020SFH	2.0	13X75	Sodium Fluoride + Heparin Sodium	/	PET/GLASS		Safety Cap+Rubber
GD030SFH	3.0	13X75	Sodium Fluoride + Heparin Sodium	/	PET/GLASS		Safety Cap+Rubber
GD040SFH	4.0	13X75	Sodium Fluoride + Heparin Sodium	/	PET/GLASS		Safety Cap+Rubber
GD050SFH	5.0	13X75	Sodium Fluoride + Heparin Sodium	/	PET/GLASS		Safety Cap+Rubber

Cat. No	Volume/ml	Size/mm	Additive	Separator	Material	Cap Color	Closure
GD020SNA	2.0	13X75	Sodium Fluoride + EDTA Na ₂	/	PET/GLASS		Safety Cap+Rubber
GD030SNA	3.0	13X75	Sodium Fluoride + EDTA Na ₂	/	PET/GLASS		Safety Cap+Rubber
GD050SNA	5.0	13X75	Sodium Fluoride + EDTA Na ₂	/	PET/GLASS		Safety Cap+Rubber

Cat. No	Volume/ml	Size/mm	Additive	Separator	Material	Cap Color	Closure
GD020SP	2.0	13X75	Sodium Fluoride + Potassium Oxalate	/	PET/GLASS		Safety Cap+Rubber
GD030SP	3.0	13X75	Sodium Fluoride + Potassium Oxalate	/	PET/GLASS		Safety Cap+Rubber
GD040SP	4.0	13X75	Sodium Fluoride + Potassium Oxalate	/	PET/GLASS		Safety Cap+Rubber
GD050SP	5.0	13X75	Sodium Fluoride + Potassium Oxalate	/	PET/GLASS		Safety Cap+Rubber

- All tubes are supplied in 1000pcs or 1200 pcs/ctn.

Non Vacuum Blood Tube

Micro collection tube and Capillary blood collection tube belongs to Non-Vacuum blood tube.

Cat. No	Volume/ml	Size/mm	Additive	Separator	Material	Cap Color	Closure
GDN050EK2	5.0	18X55	EDTA K2	/	PP		Screw Cap
GDN050EK3	5.0	18X55	EDTA K3	/	PP		Screw Cap
GDN050A	5.0	18X55	Plain	/	PP		Screw Cap
GDN050CA	5.0	18X55	Clot Activator	/	PP		Screw Cap
GDN050SP	5.0	18X55	Fluoride Oxalate	/	PP		Screw Cap
GDN050LH	5.0	18X55	Heparin Lithium	/	PP		Screw Cap

Non-Vacuum Serum Separator Tube

For serum determinations in chemistry, immunology and serology.

Description

- Contain an inert polymer gel that separates the serum from the blood clot during centrifugation, preventing contamination of the serum.
- Made of transparent polypropylene for easy visibility of blood samples PET.
- Immediately after draw, gently invert the tube 8-10 times in order to activate adequate anticoagulant.
- To obtain serum, tube should be allowed to stand for 30 minutes or until the clot is formed.
- **Centrifugation:** 1800-2200g for 8-15 minutes at 18-25° C.



Cat. No	Volume/ml	Size/mm	Additive	Separator	Material	Cap Color	Closure
GDN050SGC	5.0	13X75	Clot Activator	Gel	PP		Push Cap
GDN060SGC	6.0	13X100	Clot Activator	Gel	PP		Push Cap
GDN085SGC	8.5	18X100	Clot Activator	Gel	PP		Push Cap

- All tubes are supplied in 1000pcs or 1200 pcs/ctn.

Micro Blood Collection Tubes

Used for pediatric & finger-prick blood sample collections. Made from medical grade polypropylene (PP), virtually unbreakable and highly transparent.



Description

- Ultrasonically sprayed additives for different clinical lab tests.
- Precision molded snap cap maintains a tight seal during procedures and allows to open by single hand.
- Caps are available in bright attractive colors for sample identification purposes.
- An integrated scoop on the tube for easier micro blood collection.
- Marked with fill lines, lot numbers and expiration date on labels.
- Holds 250 to 500µL of blood.
- Immediately after draw, gently invert the tube in order to mix with additives.
- To obtain serum with clot activator, tubes should be allowed to stand for 30 minutes or until the clot is formed.

Cat. No	Volume/ml	Size/mm	Additive	Separator	Material	Cap Color	Closure
GD005A	0.5	10X45	NONE	/	PP		Snap Cap
GD005CA	0.5	10X45	Clot Activator	/	PP		Snap Cap
GD005EK2	0.5	10X45	EDTA K2	/	PP		Snap Cap
GD005EK3	0.5	10X45	EDTA K3	/	PP		Snap Cap
GD005LH	0.5	10X45	Heparin Lithium	/	PP		Snap Cap
GD005SH	0.5	10X45	Heparin Sodium	/	PP		Snap Cap
GD005SFH	0.5	10X45	Heparin Sodium+ Sodium Fluoride	/	PP		Snap Cap
GD005SGC	0.5	10X45	Clot Activator	Gel	PP		Snap Cap

- All tubes are supplied in 1000pcs or 1200 pcs/ctn.

Micro Blood Collection Tubes



Skirted tube with false bottom to make a full-size blood collection tube, with dimensions as 13 X 75mm; Compatible with automated hematology analyzers without the need for a tube adapter.

Used for pediatric & finger-prick blood sample collections.

Description

- Ultrasonically sprayed additives for different clinical lab tests.
- Precision molded snap cap maintains a tight seal during procedures and allows to open by single hand. They are available in bright attractive colors for sample identification purposes.
- An integrated scoop on the tube for easier micro blood collection.
- Marked with fill lines, lot numbers and expiration date on labels.
- Made from medical grade polypropylene (PP), virtually unbreakable and highly transparent.
- Immediately after draw, gently invert the tube in order to mix with additives.
- To obtain serum with clot activator, tubes should be allowed to stand for 30 minutes or until the clot is formed.

Cat. No	Volume/ml	Size/mm	Additive	Separator	Material	Cap Color	Closure
GDNM005A	0.5	13X75	NONE	/	PP		Snap Cap
GDNM005CA	0.5	13X75	Clot Activator	/	PP		Snap Cap
GDNM005EK2	0.5	13X75	EDTA K2	/	PP		Snap Cap
GDNM005EK3	0.5	13X75	EDTA K3	/	PP		Snap Cap
GDNM005LH	0.5	13X75	Heparin Lithium	/	PP		Snap Cap
GDNM005SH	0.5	13X75	Heparin Sodium	/	PP		Snap Cap
GDNM005SFH	0.5	13X75	Heparin Sodium+Sodium Fluoride	/	PP		Snap Cap
GDNM005SGC	0.5	13X75	Clot Activator	Gel	PP		Snap Cap

- All tubes are supplied in 1000pcs or 1200 pcs/ctn.

Capillary Blood Collection Tube

For collecting, transport and processing capillary blood, especially in children, geriatric patients when small amount of blood sample is required.



Description

- Ultrasonically sprayed additives for different clinical lab tests.
- Small volume blood collection use.
- Micro Tube with central crossed rubber cap for inserting capillary tubes, allowing appropriate capillary to be inserted without removing the cap.
- Immediately after draw, gently invert the tube in order to mix with additives.
- To obtain serum with clot activator, tubes should be allowed to stand for 30 minutes or until the clot is formed.

Cat. No	Volume/ml	Size/mm	Additive	Separator	Material	Cap Color	Closure
GDC005A	0.5	10X45	NONE	/	PP		Snap Cap
GDC005CA	0.5	10X45	Clot Activator	/	PP		Snap Cap
GDC005EK2	0.5	10X45	EDTA K2	/	PP		Snap Cap
GDC005EK3	0.5	10X45	EDTA K3	/	PP		Snap Cap
GDC005LH	0.5	10X45	Heparin Lithium	/	PP		Snap Cap
GDC005SH	0.5	10X45	Heparin Sodium	/	PP		Snap Cap
GDC005SFH	0.5	10X45	Heparin Sodium+Sodium Fluoride	/	PP		Snap Cap
GDC005SGC	0.5	10X45	Clot Activator	Gel	PP		Snap Cap

- All tubes are supplied in 1000pcs or 1200 pcs/ctn.

Butterfly Needles

Safety blood collection needle devices specialized for venipuncture.



Description

- Accessing a superficial vein or artery for intravenous injection or phlebotomy. It consists, from front to rear, of a Hypodermic needle, two bilateral flexible "wings".
- Flexible small-bore transparent tubing (often 20-35cm long).
- Transparent tubes for optimal observation of venous blood return.
- All butterfly needles are supplied in 2000 pcs/ctn.

Cat. No	Specification	Color
GD-BF21G	21Gx3/4"	Green
GD-BF22G	22Gx3/4"	Black
GD-BF23G	23Gx3/4"	Blue

Pen Type Blood Collection Needles

Used for blood collection.



Description

- Easily identified by different color .
- Thin-walled design, big inner dia, so the flow rate is high.
- Pyrogen free.
- Non-toxic.

Cat. No	Size	Color
GDN18G	18GX1 1/2"	Pink
GDN20G	20GX1 1/2"	Yellow
GDN21G	21GX1 1/2"	Green
GDN21G2	21GX1 1/4"	Green
GDN22G	22GX1 1/2"	Black
GDN22G	22GX1 1/4"	Black
GDN23G	23GX1 1/2"	Blue

- All needles are supplied in 4000 pcs/ctn.

Flashback Blood Collection Needles

Flashback blood collection needles avoid the potential multiple sticks of the same patient with instant confirmation of needle placement, through a unique visual flashback indication.

Cat. No	Specification	Color
GDN21GFB	Flash Back Needle 21Gx1"	Green
GDN22GFB	Flash Back Needle 22Gx1"	Black

- All flash back needles are supplied in 5000 pcs/ctn.



Blood Collection Tube Holder

Blood collection tube holder for taking blood samples.

Description

- Compatible with standard, multiple sample blood collection needles.

Cat. No	Specification	Qty/ctn
GD-H	Holder, PP	2000
GD-H1	Holder with safety cover, PP	2000



Sharps Container



- **Material:** Polypropylene, PVC-free.
- Standard disposable sharps container used to collect sharps waste, including syringes, infusion sets, hypodermic needles, surgical needles, etc.
- **Available in a variety of sizes:**
- 1L, 3L, 5L, 7L, 13L; 1 gallon, 2 gallons, 6 gallons; 1 quart, 2 quarts, 5 quarts.
- The container is made of puncture-resistant medical plastics; the lid is flip-top or rotating for easy collection and transport. FDA 510(k) approval.

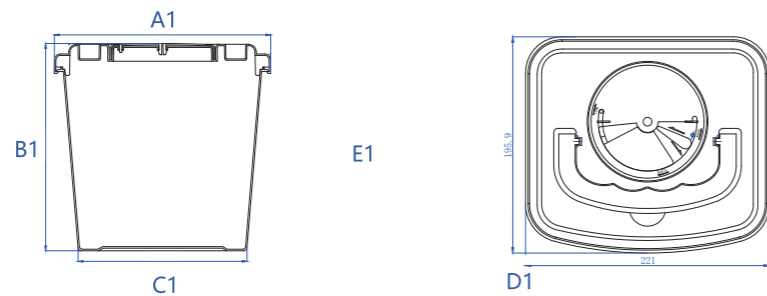
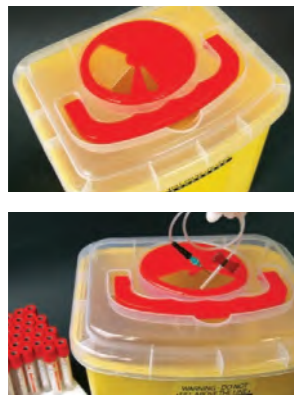

X

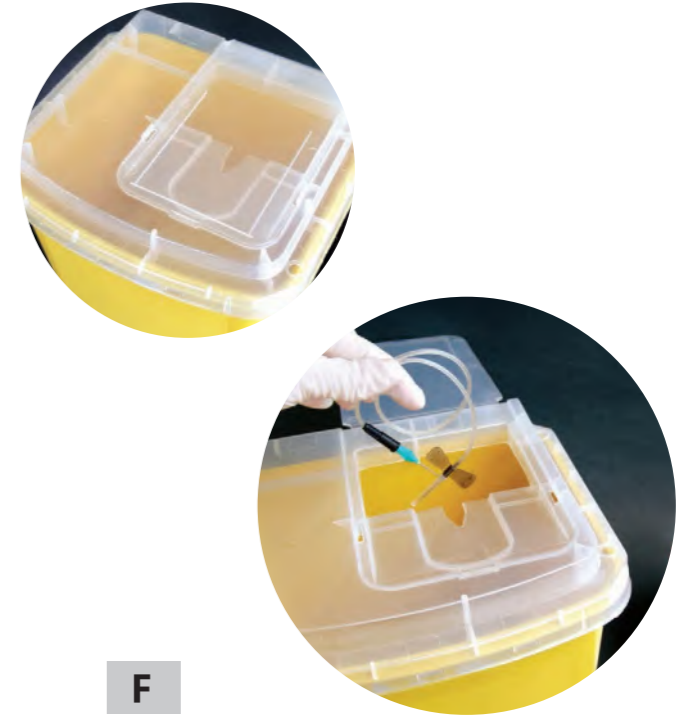
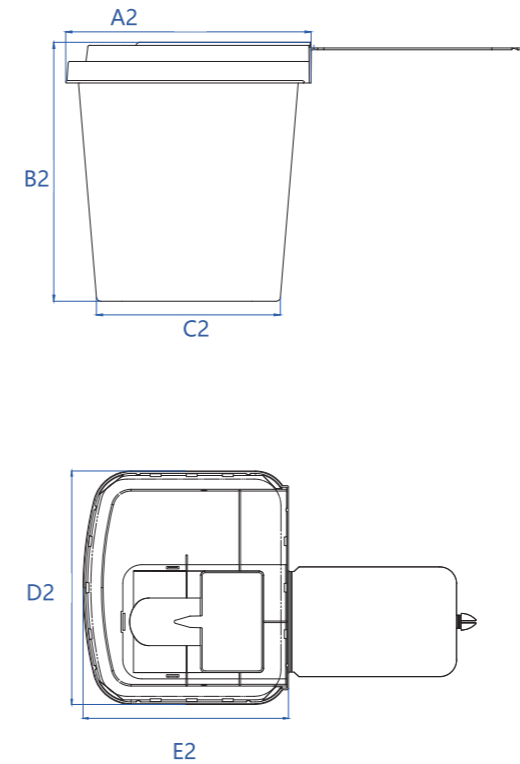

F

Item	Usable Capacity	Color	Type	Closure	A1	B1	C1	D1	E1 Unit(mm)	Qty/ctn
GDC-03-X	3L	Yellow	Free Standing	Rotary Lid	184.4	183.3	141.8	154.3	184.3	48
GDC-05-X	5L	Yellow	Free Standing	Rotary Lid	221	213.3	173.7	195.9	221	32
GDC-07-X	7L	Yellow	Free Standing	Rotary Lid	241.2	224	194	220.4	241.2	24
GDC-013-X	13L	Yellow	Side Knob	Rotary Lid	300.2	394.3	220.7	253.6	300.2	20

Item	Usable Capacity	Color	Type	Closure	A1	B1	C1	D1	E1 Unit(mm)	Qty/ctn
GDC-01-F	3L	Yellow	Free Standing	Flip Lid	102.5	166.4	70.4	122	102.5	60
GDC-03-F	5L	Yellow	Free Standing	Flip Lid	158.1	190.6	112.8	188.4	58.1	48
GDC-05-F	7L	Yellow	Free Standing	Flip Lid	199	210.1	149.1	226.2	199	32
GDC-07-F	13L	Yellow	Free Standing	Flip Lid	223.9	223.6	170.5	241.4	220.9	24

Sharps Container



SC-01Q

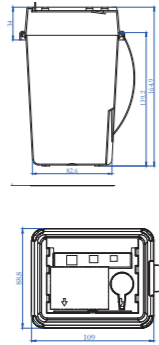

SC-02Q

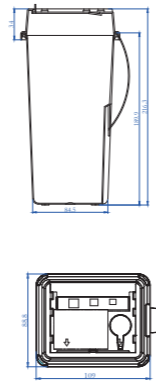

SC-05Q

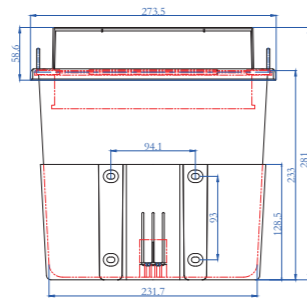

SC-01G

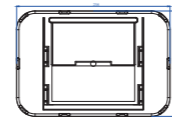
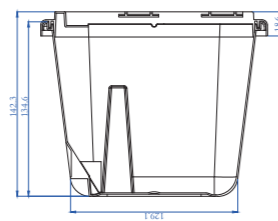

SCT50



SC-02G

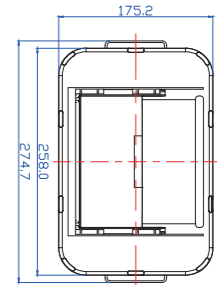
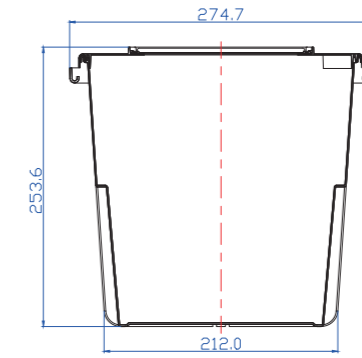

SC-06G

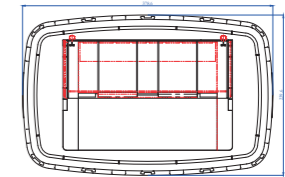
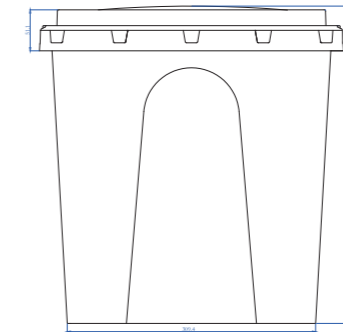

Item	Usable Capacity	Color	Type	Closure	Qty/ctn
SC-01Q	1 Quart	Red	One-handed	Flid	60
SC-02Q	2 Quart	Red	One-handed	Flid Lid	60
SC-05Q	5 Quart	Red	Wall Mount	Horizontal Entry Lid	20
SC-01G	1 Gallon	Red	Wall Mount	Slide Lid	24
SC-02G	2 Gallon	Red	Wall Mount	Slide Lid	24
SC-06G	6 Gallon	Red	Side Knob	Slide Lid	12
SCT50	50ml	Transparent	Portable Sharps Shuttle Container	Lock-safe cap	24



SPECIMEN CONTAINERS

Specimen collection is a basic element directly related to test results. Specimen preservation and transportation are important parts of test quality assurance. Gongdong specimen collection system provides a guarantee for test accuracy and precision at the source.

The sealing performance is superior to prevent leakage, which can prevent external bacteria and foreign matters from polluting the specimen, prevent spatter of specimens during transportation, reduce the risk of patients and medical personnel contacting the pathogenic specimen, and provide convenience for mixing the specimen.

The specimen collection apparatus is designed reasonably to facilitate the collection of different forms of specimens. Convenient to carry, suitable for different places to collect specimens for inspection, and completely suitable for logistics system to transport specimens.

Discarded specimens are sealed in airtight collectors for easy hospital disposal, greatly improves the sanitary conditions of the laboratory.

Sterilized by ethylene oxide and packaged.

Stool specimen collection

Those containers are used for the collection of stool specimens. It provides easy stool collection and closed container transport in a clean, convenient and safe way, effectively preventing the drying, spillage and leakage of stool specimens. It offers easy specimen labeling, bulk transport and sampling during testing.



Item No.	Description of Goods	Quantity	Packing
K1011	20ml stool container with stick	1000	100pcs*10bags
K1012	25ml stool culture bottle with stick	650	25pcs*26bags
K1013	60ml Stool container with stick	500	1pc*500bags
K1013-1	60ml Stool container without stick	500	1pc*500bags
H1016-6	60ml Stool container with spoon	500	1pc*500bags

Item No.	Description of Goods	Quantity	Packing
K1012-1	25ml stool container	650	25pcs*26bags
K1014	5ml stool collection with spoon	2000	25pcs*80bags
K1014-1	5ml stool collection without spoon	2000	25pcs*80bags
K1017-2	25ml universal container with spoon PP	650	25pcs*26bags
K1017-3	25ml universal container with spoon PS	650	25pcs*26bags
K1018-2	20ml stool container with spoon	650	25pcs*26bags
k1018-3	20ml stool container with spoon	650	in bulk

Collection of sputum cup specimens

This container is used for the collection of sputum specimens. It provides easy sputum collection and closed container transport in a clean, convenient and safe way.



Item No.	Description of Goods	Quantity	Packing
K1015	30ml sputum container	500	1pc*500bags
K1016	40ml sputum container	500	5pcs*100bags
K1017	25ml universal container	650	25pcs*26bags
K1017-1	25ml sputum container (skirted bottom)	650	25pcs*26bags
K1018	30ml sputum container	1000	10pcs*100bags



Item No.	Description of Goods	Quantity	Packing
K1018-1	20ml sputum container	1500	in bulk
K1019	Sputum cassette	2000	100pcs*10bags
K1023	Mucus trap, 40CC	50	1pc/bag*50bags
K1024	Mucus trap, 80CC	50	1pc/bag*50bags

Stool specimen collection

This container is used for the collection of urine specimens. It is made of medical grade plastics with a user-friendly design. It has an evenly thick wall that enables easy urine collection and closed transport and testing. It thus facilitates the specimen transport for testing and its use with testing instruments, and prevents contamination. (The product use is clean, convenient and safe, which provides a guarantee for the normalization and standardization of urine analysis from the source.)



Item No.	Description of Goods	Quantity	Packing
K1009	Soft urine cup white	10000	in bulk
K1010	Soft urine cup transparent	10000	in bulk
K1025	30ml urine container with mouth on cap,30ml	500	1pc*500bags
H1015	100ml-120ml specimen container Individual packing	500/1000	20pcs*50bags
H1016	60ml specimen container	500	1pc*500bags



Item No.	Description of Goods	Quantity	Packing
H1016-1	60ml specimen container, PS	500	1pc*500bags
H1016-2	90ml specimen container	500	1pc*500bags
H1016-5	40ml renovate urine container	500	in bulk
H1021	140ml specimen container	500	1pc*500bags
K1026	Urine transfer device for urine tube, 100ml-120ml	250	1pc*250bags
K1027	Urine transfer device for urine tube, 100ml-120ml	250	1pc*250bags
GD0100UA	Vacuum Urine Tube, Yellow cap, no Additive, 16*100mm, 10ml	1200	100pcs*12racks
GD0100UB	Vacuum Urine Tube, Yellow cap, Boric Acid, 16*100mm, 10ml	1200	100pcs*12racks
GD080UAC	Vacuum Urine Tube, Conical, Rubber stopper, no Additive, 16*100mm, 8ml	1200	100pcs*12racks

95KPA Compliant Specimen Container

Product is specifically designed for the safe, secure collection and transportation of biological specimens for laboratory evaluation



Urine Storage Container for 24 hours

Using the latest nano antibacterial release technology, made of new antibacterial inert plastic, can significantly inhibit the growth of bacteria within 48 hours. It is especially suitable for containers that need to collect urine continuously for 24 hours for analysis of various proteins, hormones, amino acids and other items.



Urinary biochemical tube

Using the latest nano antibacterial release technology, the test tube is firm, strong pressure resistance (centrifugation 4000 RPM/min), and can widely inhibit the growth of microorganisms (mainly bacteria, mold), can make the various proteins being measured stable for several days.



PETRI DISHES

The Gongdong Petri dish series are made of imported polystyrene with high quality as raw material. Its smoothness and transparent finish fully achieve the International standard of similar product. It is produced Class 100,000 cleanroom plant where there is no heat source and sterilized by ethylene oxide. Adopt the internationally popular easy tear package, which is simple and convenient and reduce the pollution opportunities in the use of products. Each batch of products is evaluated by growth status observation, test of cell growth rate, test of cell adherence strength, pyrogenicity test and sterility test to ensure product quality In comparison with similar quality products in the world. The Gongdong petri dish series is suitable for cell, bacteria culture and drug sensitivity test.

Item No.	Description of Goods	Quantity	Packing
GD3510	20ml Container with 35mm Cap	1000	EA/Case
GD4815	40ml Container with 48mm Cap	500	EA/Case
GD4825	60ml Container with 48mm Cap	500	EA/Case
GD4834	90ml Container with 48mm Cap	400	EA/Case
GD5334	90ml Container with 53mm Cap	300	EA/Case
GD5343	120ml Container with 53mm Cap	300	EA/Case
H1016-3	40ml specimen container	500	1pc*500bags
H1026	Urine storage container for 24 hours, 3000ml	50	in bulk
H1027	Urine tube, 16*85mm, 10ml	2000	200pcs*10bags

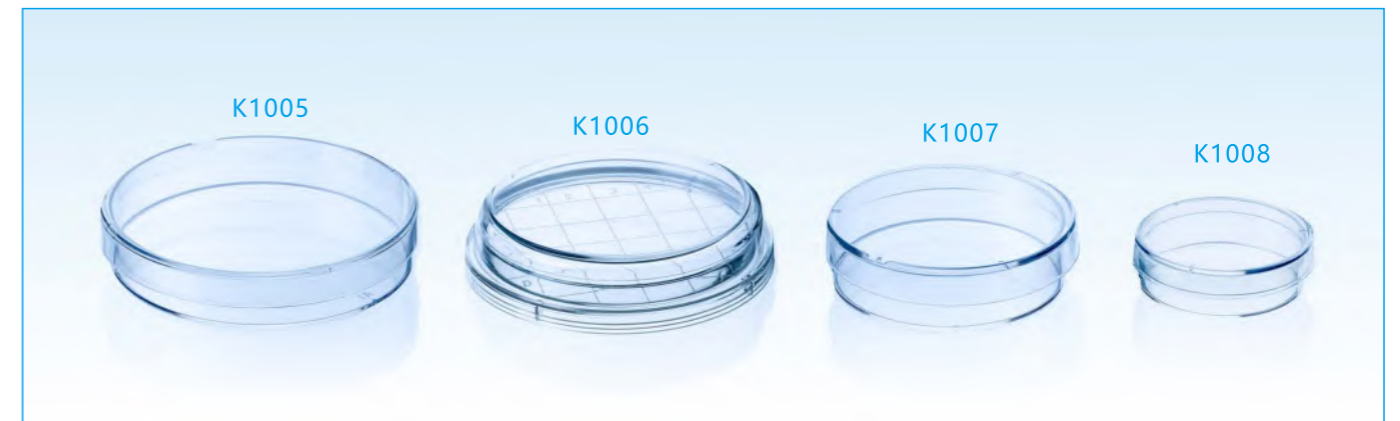

Item No.	Description of Goods	Quantity	Packing
K1001	150*15mm Petri Dish	180	10pcs/bag*18bags
K1002	90*20mm Petri Dish	500	10pcs/bag*50bags
K1004-J	90*15mm no vents Petri Dish	500	10pcs/bag*50bags
K1004-J-3Vents	90*15mm 3-vents Petri Dish	500	10pcs/bag*50bags
K1004-M	90*15mm for machine use Petri Dish	500	10pcs/bag*50bags
K1004-T	90*15mm 3-vents Petri Dish	500	10pcs/bag*50bags
K1020	Inoculation Loops, 10ul ,Blue	3000	10pcs/bag*300bags
K1021	Inoculation Loops, 1ul , White	3000	10pcs/bag*300bags
K1022	Inoculation Loops, Needles, Red	3000	10pcs/bag*300bags

Item No.	Description of Goods	Quantity	Packing
K1003	90*15mm Petri Dish Two-Compartments	500	10pcs/bag*50bags
K1005	70*15mm Petri Dish	600	10pcs/bag*60bags
K1006	65*15mm Petri Dish	650	10pcs/bag*65bags
K1007	55*15mm Petri Dish	1000	10pcs/bag*100bags
K1008	30*15mm Petri Dish	2200	10pcs/bag*220bags
K1009	14cm Petri Dish	180	10pcs/bag*18bags
K1032-S	25cm Cell Scaper	100	Individual Packing
K1032-L	39cm Cell Scaper	100	Individual Packing
K1033	18cm Cell Lifter	100	Individual Packing



NURSING PLASTICWARE SERIES

Gongdong's Vaginal Speculum got FDA approved without any defect. The products are sold well in the United States and other countries. The product design is delicate, humanized and simple to operate. A variety of different specifications of dressing cups are suitable for all ages, all kinds of medicine, convenient and clean. All kinds of PP plastic tweezers adopt connecting lever design, more excellent performance, can meet different working requirements.



Item No.	Description of Goods	Quantity	Packing
P1001	Vaginal Speculum Large, Middle, Small	100	10pcs/bag*10bags
P1002-L	Vaginal Speculum with light source , Large	80	8pcs/bag*10bags
P1002-M	Vaginal Speculum with light source, Middle	100	10pcs/bag*10bags
P1002-S	Vaginal Speculum with light source, Small	100	10pcs/bag*10bags
P1003	Transparent dressing bowl(Sterile)	1500	2pcs/packet*50pcs/bags*15bags
P1004-1	Dressing basin(soft)	1000	2pcs/packet*50pcs/bags*10bags
P1004-2	Dressing basin(hard)	80	2pcs/bag*40bags
P1008	Tongue Depressor	2800	200pcs/bag*14bags
P1010	Mouth piece for Endoscope(Large, Small)	1000	100pcs/bag*10bags

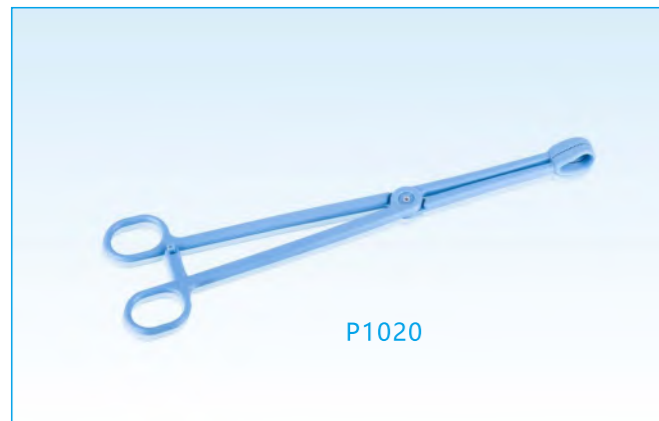
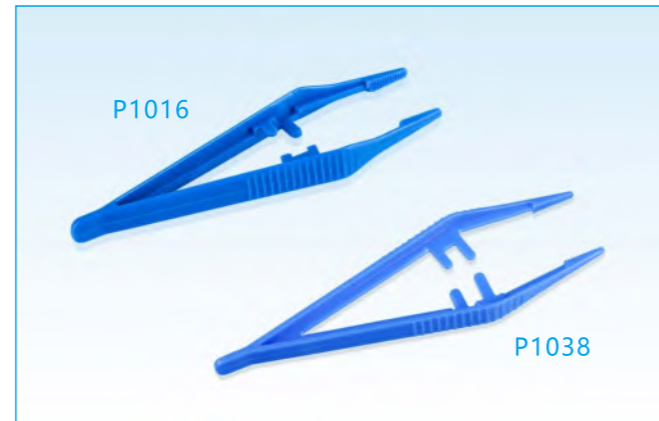
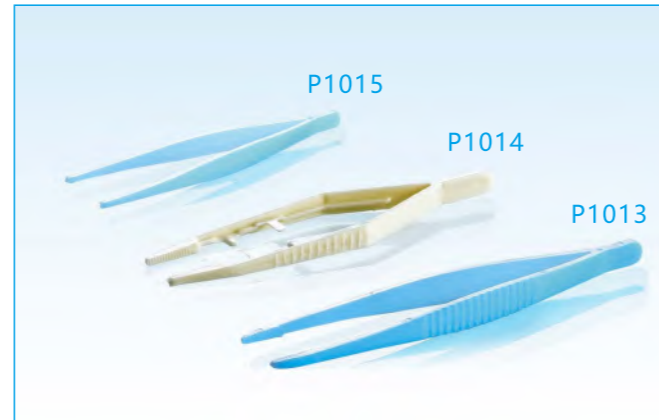

Item No.	Description of Goods	Quantity	Packing
P1012 a/b/c/e	Tweezers 12.5cm Long	2500	250pcs/bag*10bags
P1012-1	Fine-tipped Tweezers 10cm Long	2500	250pcs/bag*10bags
P1013	Tweezers with tooth 12cm Long	2500	250pcs/bag*10bags
P1014	Long Tweezers 13cm Long	2000	200pcs/bag*10bags
P1015	Tweezers without tooth 12cm Long	2500	250pcs/bag*10bags
P1016	Blue Tweezers 13cm Long	2000	200pcs/bag*10bags
P1020	Sponge Holder 23cm Long	500	50pcs/bag*10bags
P1021	Sponge Holder 18cm Long	500	50pcs/bag*10bags
P1038	Blue Tweezers 13cm Long, ABS	2000	200pcs/bag*10bags

Item No.	Description of Goods	Quantity	Packing
P1022	Sponge Holder 11cm Long	1200	1100pcs/bag*12bags
P1023	Sponge Holder 10cm Long	1200	100pcs/bag*12bags
P1024	Sponge Holder 14.3cm Long	1200	100pcs/bag*12bags
P1025	Sponge Holder 13.9cm Long	1200	100pcs/bag*12bags
P1033	Scissors, Blue, ABS	1000	100pcs/bag*10bags
P1004	Scissors, Blue	1200	100pcs/bag*12bags



Item No.	Description of Goods	Quantity	Packing
P1026	Disposable umbilical cord scissors		
K1034	2.5mm Ear Speculum	8500	34pcs/bag*25bags*10bags
K1035	4.25mm Ear Speculum	8500	34pcs/bag*25bags*10bags
P1030	Anus speculum, Large, Middle, Small	100	25pcs/bag*4bags
P1039	Anus speculum	100	25pcs/bag*4bags

CENTRIFUGE TUBE CRYO VIALS SERIES

Centrifuge tube series are made of polypropylene with high quality. The thickness of the tube wall is uniform. The tubes are all marked with scales so that the volume of concentrated liquid can be directly read out, and make it easier to recycle concentrated liquid with straw. The unique sealing cover prevents liquid leakage, and can be sterilized in high temperature and pressure. Match with a variety of centrifuge tube holders.

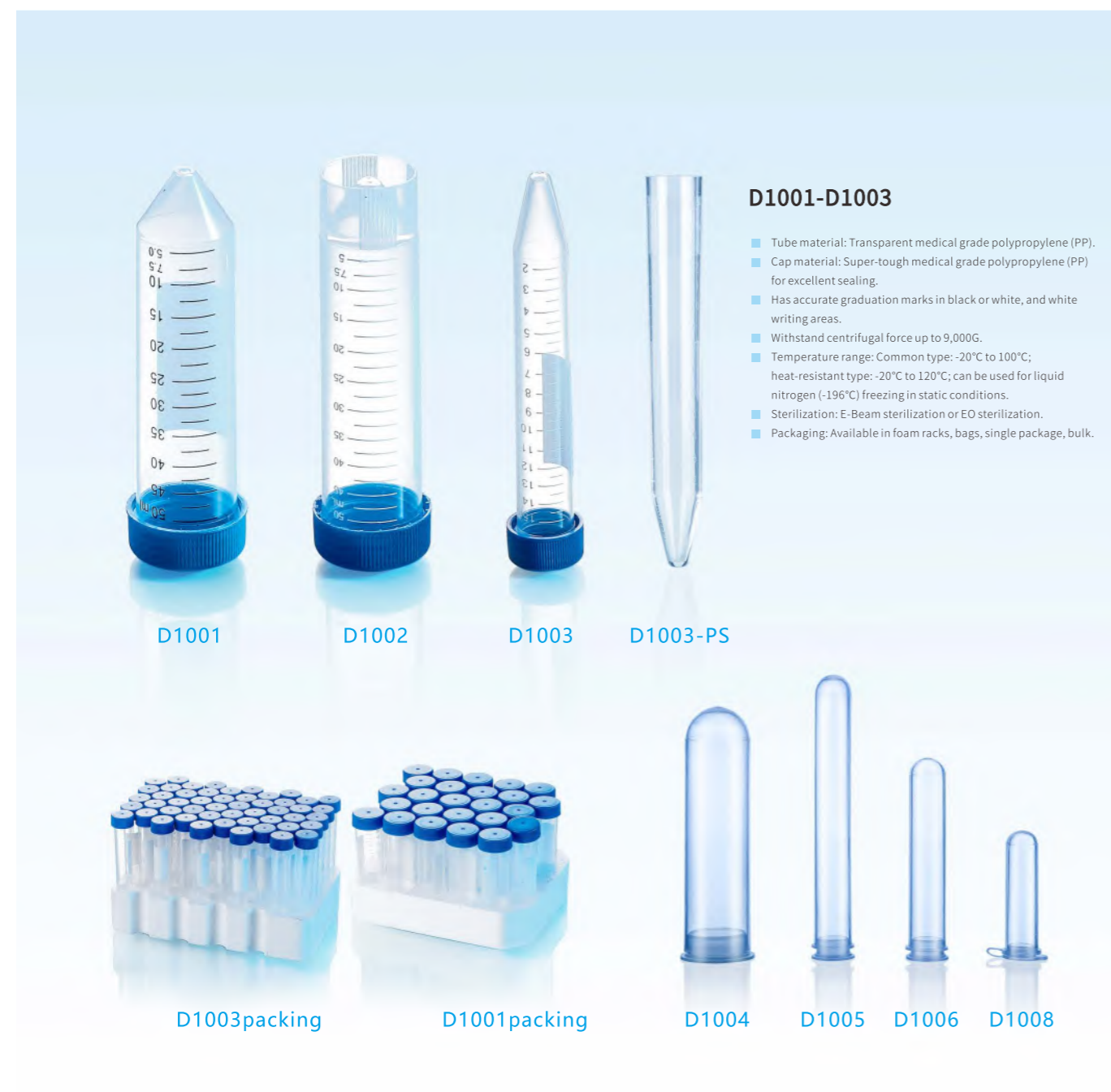

Item No.	Description of Goods	Quantity	Packing
D1001	50ml conical with graduation	500	50pcs*10bags
D1002	50ml self-standing	500	50pcs*10bags
D1003	15ml conical with graduation	1000	50pcs*20bags
D1003-PS	15ml conical with graduation, PS	1000	50pcs*20bags
D1004	50ml	500	50pcs*10bags
D1005	15ml	1500	150pcs*10bags
D1006	10ml	2000	200pcs*10bags
D1008	5ml with cap	3000	300pcs*10bags

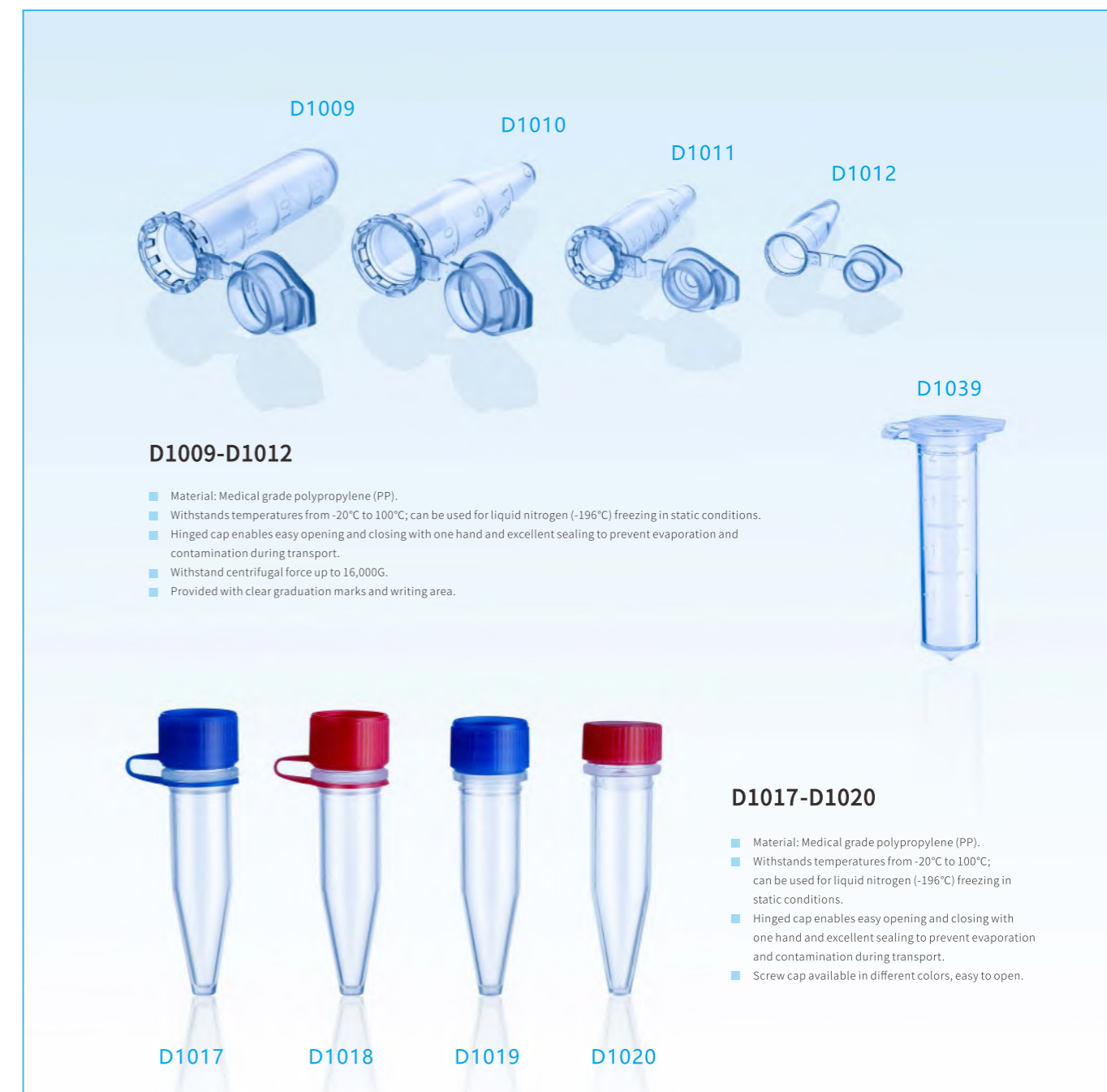

Item No.	Description of Goods	Quantity	Packing
D1009	2ml	5000	500pcs*10bags
D1010	1.5ml with transparent cap	6000	500pcs*12bags
D1011	0.5ml	12000	1000pcs*12bags
D1012	0.2ml	30000	1000pcs*30bags
D1017	1.5 ml linked green cap	6000	500pcs*12bags
D1018	1.5ml linked red cap	6000	500pcs*12bags
D1019	1.5ml blue cap	6000	1000pcs*6bags
D1020	1.5 ml red cap	6000	1000pcs*6bags
D1039	2ml conical	5000	500pcs*10bags



Item No.	Description of Goods	Quantity	Packing
D1013	5ml+cap	2000	200pcs*10bags
D1015	1.8ml	5000	500pcs*10bags
D1015-5	Cryo vial 0.5ml	5000	500pcs*10bags
D1015-10	Cryo vial 1ml	5000	500pcs*10bags
D1015-15	Cryo vial 1.5ml	5000	500pcs*10bags
D1015-20	Cryo vial 2ml	5000	500pcs*10bags
D3027	Cryo vial 0.5ml	5000	500pcs*10bags
D3028	Cryo vial 1.5ml	5000	500pcs*10bags
D3029	Cryo vial 2.0ml	5000	500pcs*10bags



Item No.	Description of Goods	Quantity	Packing
D3033	Cryo vial 0.5ml	5000	500pcs*10bags
D3034	Cryo vial 1.0ml	5000	500pcs*10bags
D3035	Cryo vial 1.8ml	5000	500pcs*10bags
D3036	Cryo vial 1.5ml	5000	500pcs*10bags
D3037	Cryo vial 1.8ml	5000	500pcs*10bags
D3038	Cryo vial 5.0ml	5000	500pcs*10bags
D3056	0.5ml cryo vial, 3 codes (Barcode, digital code, and 2D)	1920	96pcs/box*20boxes
D3057	0.5ml cryo vial, 3 codes (Barcode, digital code, and 2D)	2000	100pcs/bag*20bags

PCR Eight connected pipe

- Material: Medical grade polypropylene.
- The tube is transparent for easy sample observation.
- Dished cap: ensures a tight fit to effectively prevent the evaporation and loss of samples;
- Flat cap: ideal for quantitative real-time PCR experiments. The tube cap is specially lengthened for inner seal and the cap body is sealed, effectively preventing accidental opening.
- Customized support: Can be DNA/RNA-free, pyrogen-free and endotoxin-free.
- Operating temperature: -20°C to 100°C.
- Fit for common brand PCR instruments; withstand centrifugal force of 6,000G in a fully supported rotor.



D1028

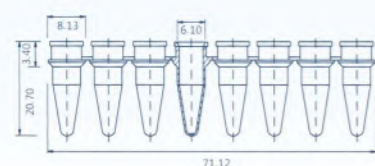

D1029

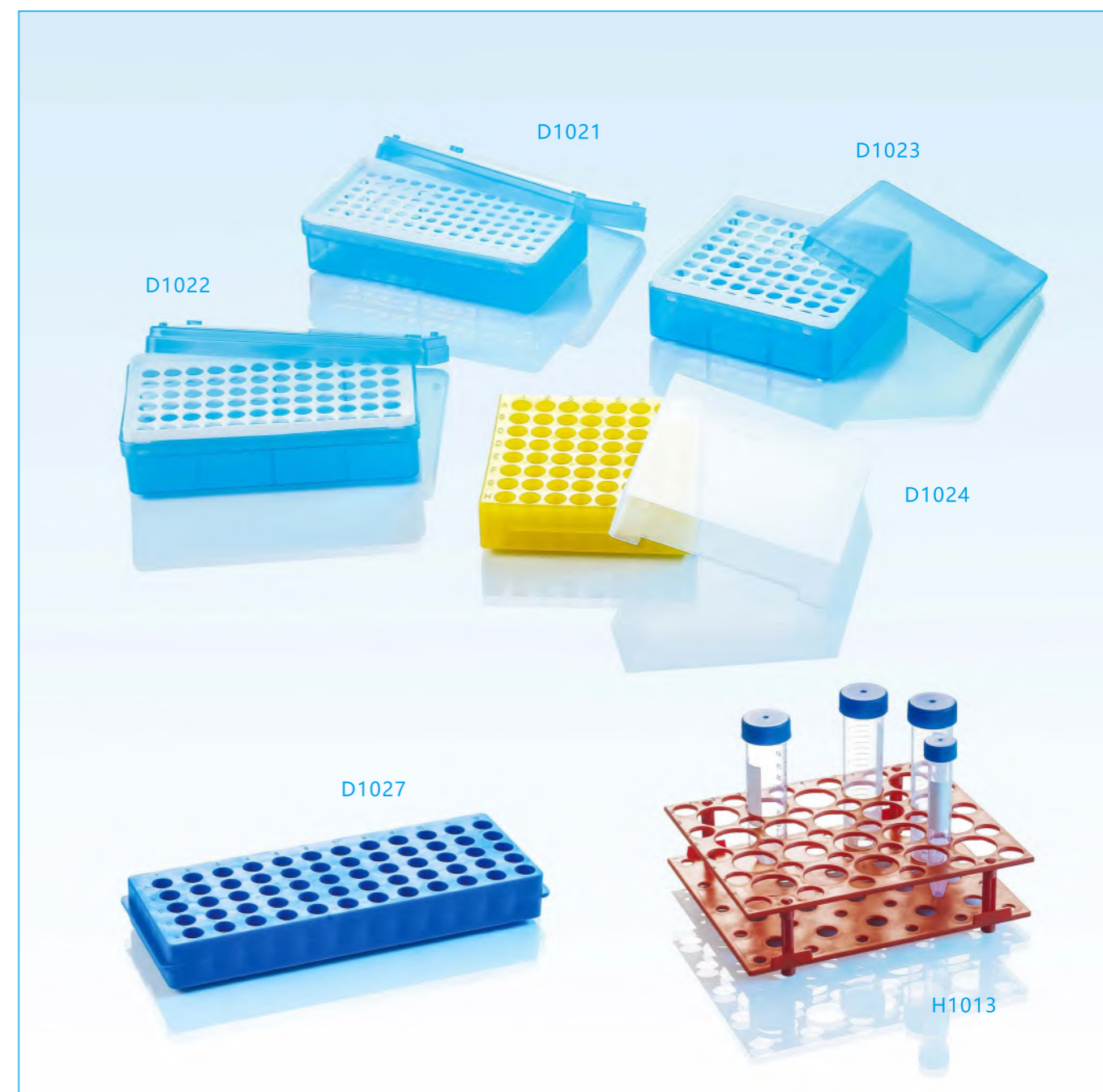

Item No.	Description of Goods	Quantity	Packing
D1028	8-Strip tubes for PCR 0.1ml milk white with cap	1250	125pcs/bag/small box*10boxes
D1029	8-Strip tubes for PCR 0.2ml transparent with cap	1250	125pcs/bag/small box*10boxes

Item No.	Description of Goods	Quantity	Packing
D1021	98 wells centrifugation tube rack for 0.5ml	40	1pc*40bags
D1022	72 wells centrifugation tube rack for 1.5ml	40	1pc*40bags
D1023	81 wells centrifugation tube rack for 1.5ml	40	1pc*40bags
D1024	Two purpose tube rack	40	1pc*40bags
D1027	Two-purpose centrifuge tube rack(front 1.5ml, reverse side 0.5ml)	50	1pc*50bags
H1013	Centrifugation rack for 50ml, 15ml	50	1pc*50bags



PIPETTE TIPS

The special Gongdong pipette tip is used to ensure the accuracy and precision of the experiment. The precision pipette tip provides optimum reproducibility and accuracy. Standard tip and tip with filter can be disinfected and sterilized in high pressure. The unique filter element silicified tip does not hang the residual liquid, which guarantees the accuracy of liquid transfer to the utmost. It almost meets and fits the requirements of most commercially available pipettes. It is also equipped with a variety of tip boxes, in high temperature and pressure. Match with a variety of centrifuge tube holders.

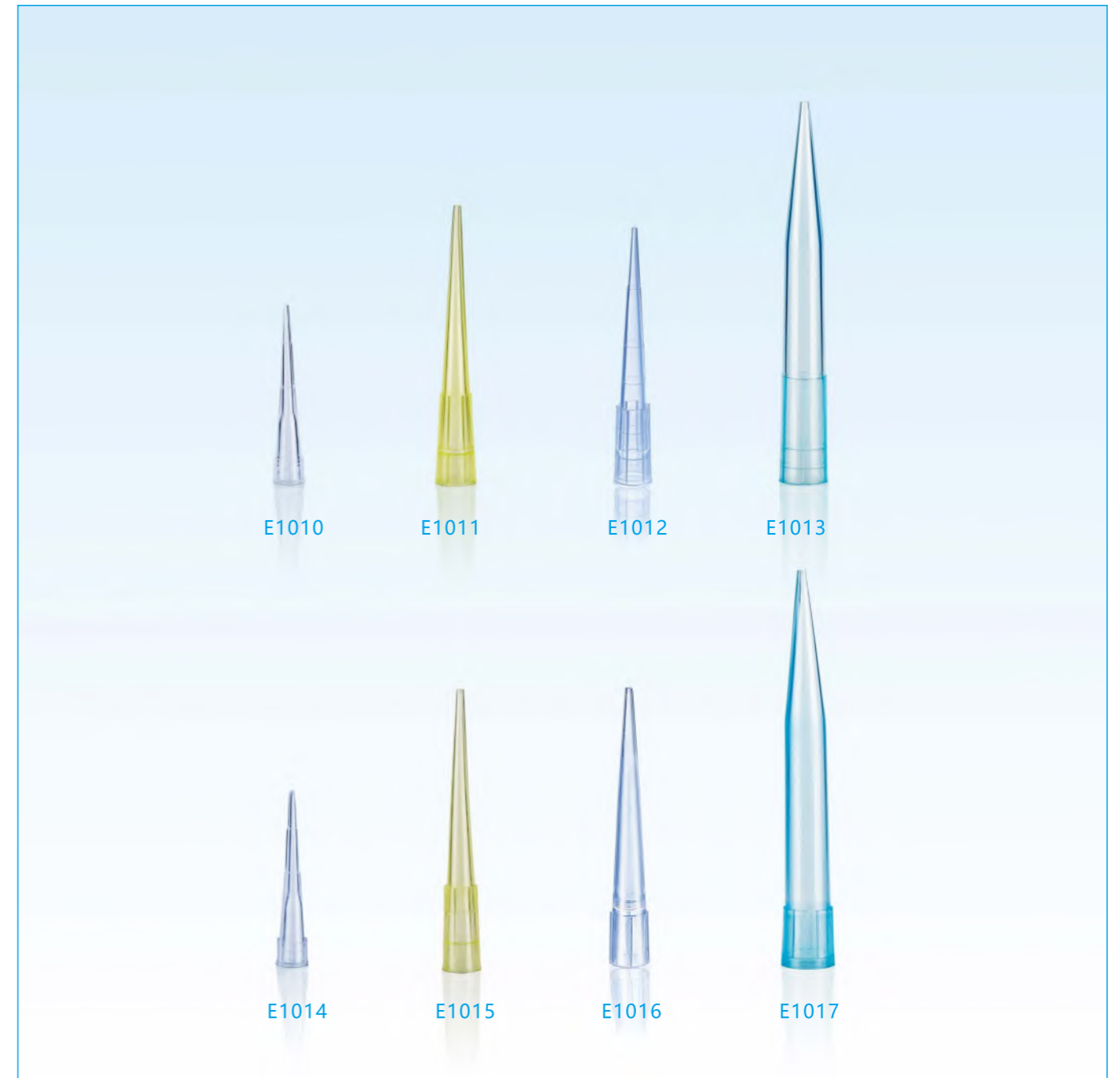

Item No.	Description of Goods	Quantity	Packing
E1010	10μl φ5*32mm Fit For Gilson	60000	1000pcs/bag*60bags
E1011	10μl-200μl φ6*50mm (Yellow) Fit For Gilson	30000	1000pcs/bag*30bags
E1012	10μl-200μl φ6*50mm (Graduation) Fit For Gilson	30000	1000pcs/bag*30bags
E1013	200μl-1000μl φ8*71mm Fit For Gilson	10000	500pcs/bag*20bags
E1014	10μl φ5*32mm Fit For Finland	60000	1000pcs/bag*60bags
E1015	10μl-200μl φ6*50mm Fit For Finland	30000	1000pcs/bag*30bags
E1016	10μl-250μl φ6*52mm Fit For Finland	25000	1000pcs/bag*25bags
E1017	200μl-1000μl φ8*71mm Fit For Finland	10000	500pcs/bag*20bags

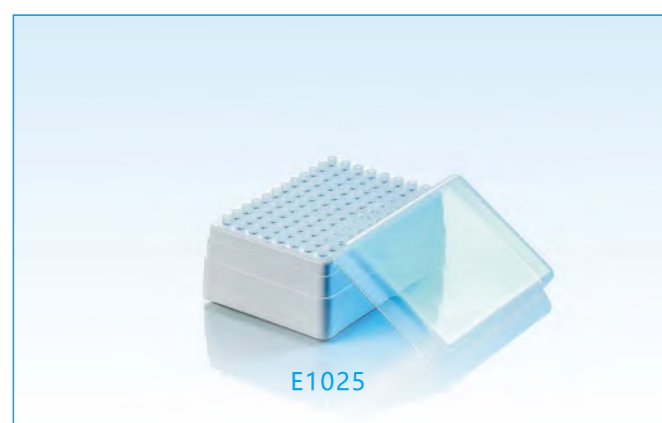
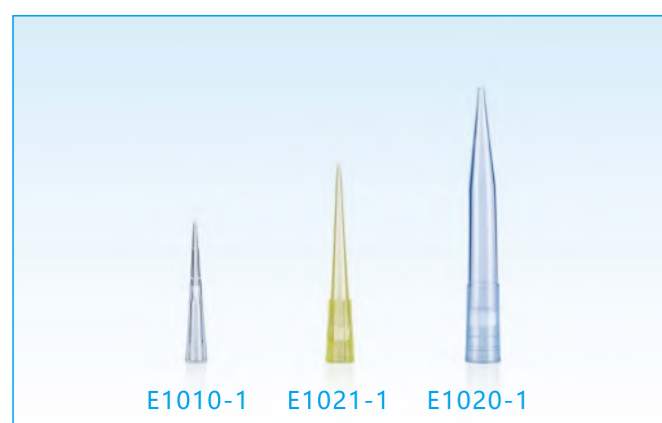
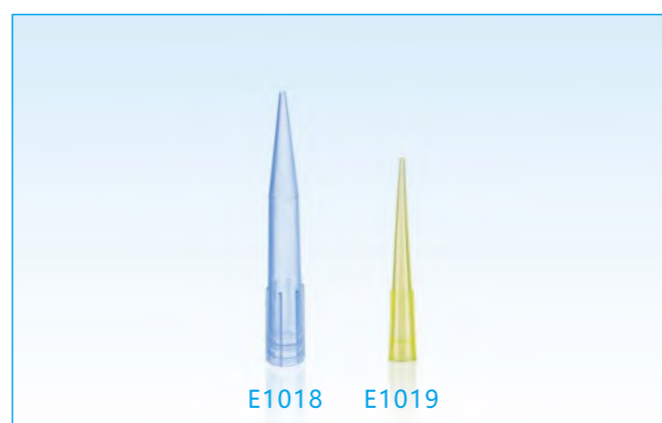
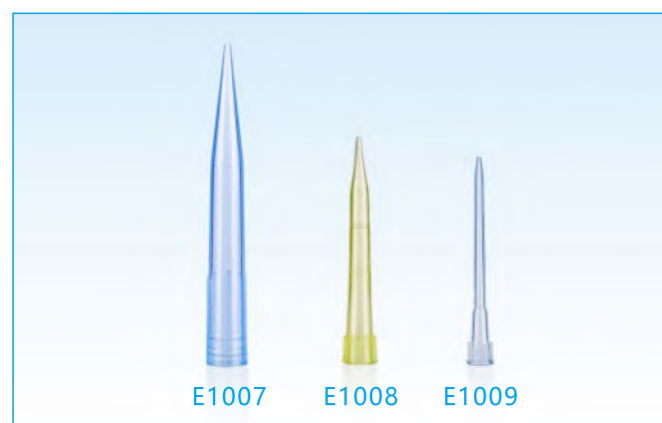

Item No.	Description of Goods	Quantity	Packing
E1007	200µl-1000µl Fit For Eppendorf	10000	500pcs/bag*20bags
E1008	10µl-300µl Fit For Eppendorf	30000	1000pcs/bag*30bags
E1009	10µl φ4*49mm Fit For Eppendorf	60000	1000pcs/bag*60bags
E1018	200µl-1000µl φ8*71mm Fit For Switzerland	10000	500pcs/bag*20bags
E1019	10µl-200µl φ6*50mm Fit For Switzerland	30000	1000pcs/bag*30bags
E1010-1	10µl φ5*32mm With Filter Fit For Gilson	60000	1000pcs/bag*60bags
E1020-1	10µl-1000µl With Filter Fit For Gilson	10000	500pcs/bag*20bags
E1021-1	10µl-200µl φ6*50mm With Filter Fit For Gilson	30000	1000pcs/bag*30bags
E1024	Tips Box 96wells For 200µl	68	bulk
E1025	Tips Box 96wells For 200µl&10µl	68	bulk
E1027	Fit for Uranus Ae120	9600	500pcs/box*100boxs

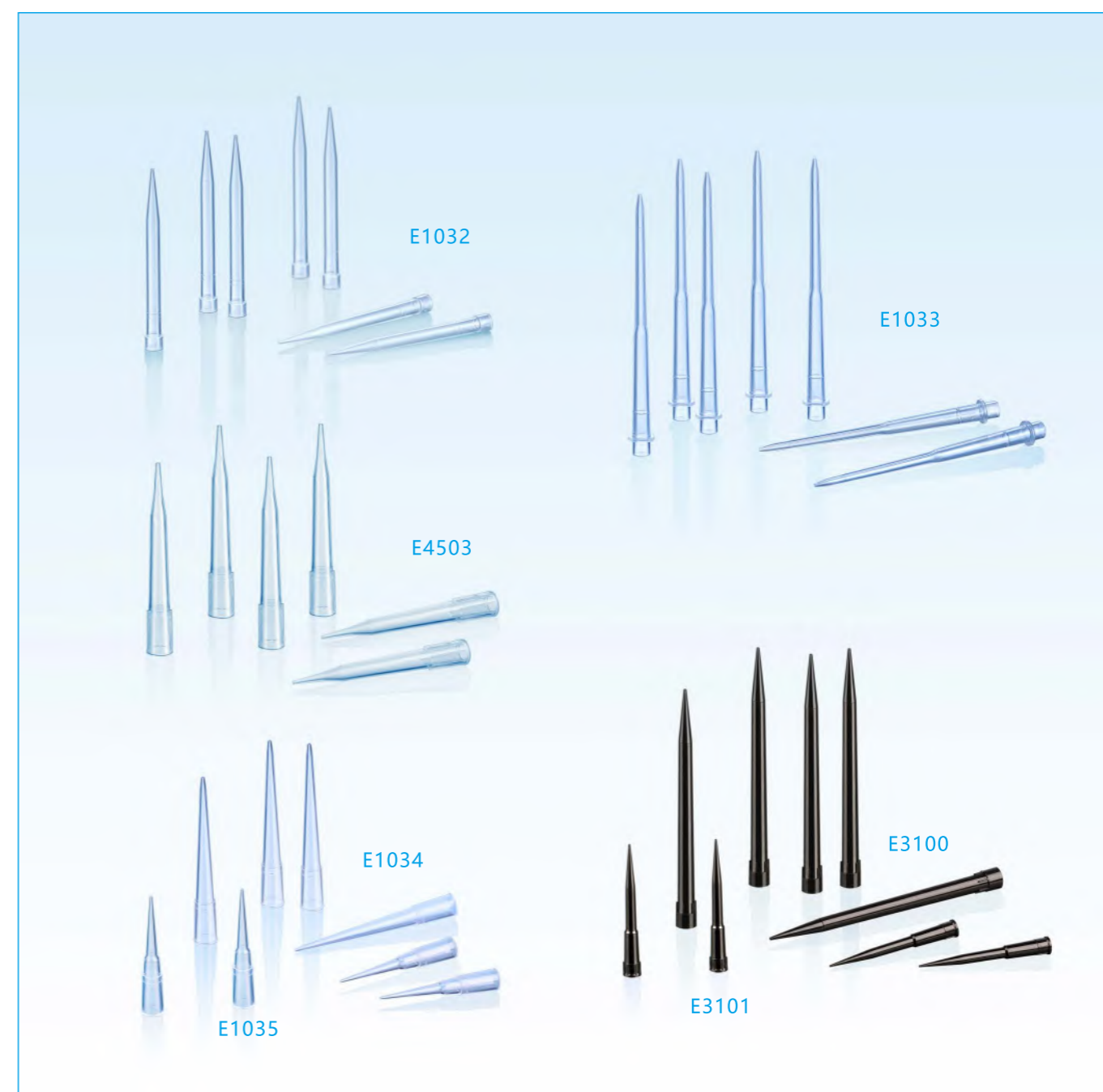

Item No.	Description of Goods	Quantity	Packing
E1032	Fit For ADDCON	10000	100pcs/bag*100bags
E1033	Fit For Siemens	8640	24box/carton
E1034	Fit For TECAN Freedom EVO 200 MAC 96 Workstation	24000	(1000pcs*2bags) /box*12boxs
E1035	TECAN Freedom EVO MCA Workstaion	24000	(1000pcs*2bags) /box*12boxs
E4503	50-300µl Fit For Finland	11520	384pcs/box*30boxs
E3100	1000µl Fit For TECAN	4608	192pcs/box*24boxs
E3101	200µl Fit For TECAN	4608	192pcs/box*24boxs

Pyrogen-free Tips

- Material: Polypropylene (PP).
- These tips have a hydrophobic filter to prevent cross-contamination of aerosol and liquid. The low-adsorption tips are suitable for handling viscous liquids and liquids with low surface tension, greatly reducing the liquid retention on the wall to ensure the accuracy of experimental results. They can be directly used in genetic testing.

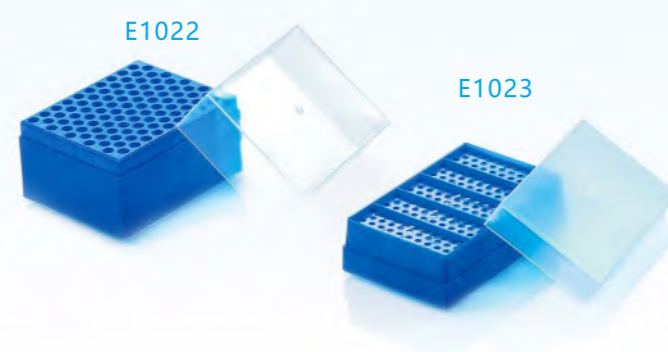

Item No.	Description of Goods	Quantity	Packing
E1010-1D	Universal tips with filter for dispensers 10 μl	4800	96pcs/plastic box*10boxes/carboard box*5carboard box/Case
E1020-1D	Universal tips with filter for dispensers 1000 μl	4800	96pcs/plastic box*10boxes/carboard box*5carboard box/Case
E1020-1D1250	Universal tips with filter for dispensers 1250 μl	4800	96pcs/plastic box*10boxes/carboard box*5carboard box/Case
E1021-1D	Universal tips with filter for dispensers 200 μl	4800	96pcs/plastic box*10boxes/carboard box*5carboard box/Case
E1022	Tips Box 100wells For 1000μl	30	in bulk
E1023	Tips Box 200wells For 200μl	40	in bulk

CULTURE PLATE & PIPETTE SERIES

The Gongdong culture plate adopts the most advanced surface treatment technology and manufacturing process of low-temperature polymer material at present in the world. A variety of series product such as cell culture flasks, cell culture plates, isotope flasks and coplin jars can be produced to meet the needs of single cell to large-scale cell and tissue cultures in a 100 thousand stage purification plant.

96 Wells Plate

- Specially designed with 96 wells; each well has a capacity of 0.2ml.
- Precisely molded for uniformly thin walls that allows well-to-well consistency and fast heat transfer.
- This plate has a U-shaped bottom or a V-shaped bottom. It features a flexible design with removable boards that allow a combination of 12/24/48/72/96 wells as needed.
- Surface marked with letters and numbers for easy positioning and identification.

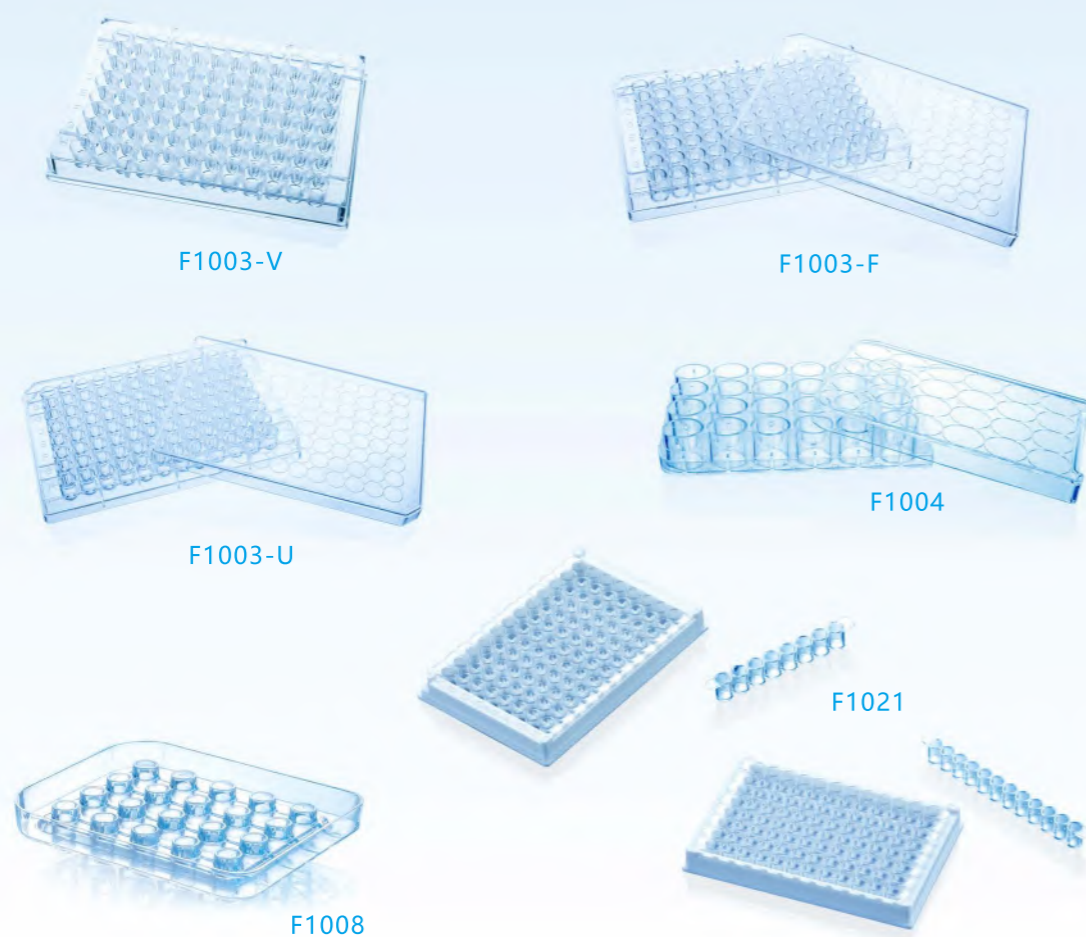

Item No.	Description of Goods	Quantity	Packing
F1003-U	96 wells Plate (U bottom)	270	1pc*270bags
F1003-F	96 wells Plate (Flat bottom)	270	1pc*270bags
F1003-V	96 wells Plate (V bottom)	270	1pc*270bags
F1004	24 wells Plate	170	1pc*170bags
F1008	20 Wells plate	180	1pc*180bags
F1021	96 wells detachable plate, suitable for 8 or 12 wells strip	270	1pc*270bags

Square Media Bottles

- Flask material: PC or PET; cap material: polyethylene
- Clear graduation marks with an error of ± 5
- Features an anti-reverse flow mouth; available in five sizes: 125ml, 150ml, 250ml, 500ml, 1000ml
- Sterilization: E-Beam sterilization or EO sterilization; D-Nase free, R-Nase free, pyrogen free



Item No.	Description of Goods	Quantity	Packing
PET250W	PET Square Media Bottles 250ml, White Cap	100	Individual Package
PET500W	PET Square Media Bottles 500ml, White Cap	100	Individual Package
PET1000W	PET Square Media Bottles 1000ml, White Cap	48	Individual Package
PC150	PC Square Media Bottles 150ml, Blue Cap	100	Individual Package
PC250	PC Square Media Bottles 250ml, Blue Cap	100	Individual Package
PC500	PC Square Media Bottles 500ml, Blue Cap	100	Individual Package
PC1000	PC Square Media Bottles 1000ml, Blue Cap	48	Individual Package
PET125	PET Square Media Bottles 125ml, Blue Cap	100	Individual Package
PET250	PET Square Media Bottles 250ml, Blue Cap	100	Individual Package
PET500	PET Square Media Bottles 500ml, Blue Cap	100	Individual Package
PET1000	PET Square Media Bottles 1000ml, Blue Cap	48	Individual Package

Embedding Cassette

Embedding cassette is made of durable and porous molded plastic, which can secure the samples stored in liquid and completely avoid the chemical reaction of histological solvent and provide a variety of different colors for easily identifying different tissue samples.



- Material: Engineering plastic POM with good chemical resistance to all histological solvents.
- Writing area is at 45° available for inkjet printing and laser printing.
- Available in white, pink, green, yellow, orange, and blue.

Item No.	Description of Goods	Quantity	Packing
F1009	Embedding Cassette	5000	500pcs*10bags
F1009H	Embedding Cassette in Tube Racks	3000	75ea/tube*40tube
F1010	Embedding Cassette White	4000	500pcs*8bags
F1011	Embedding Cassette Green	2700	300pcs*9bags
F1012	Embedding Cassette Hinged Lid	500	500pcs*10bags

Transfer Pipettes

- Plastic transfer pipettes make up for the fragility of glass pipettes, ending the history of transferring high-risk contagious liquids by glass pipettes and rubber plugs.
- Smooth inner wall reduces the damage of tissue structure and cells in the liquid, and allows quick, safe, and quantitative transfer of the liquid specimen.
- Cold-resistant; can be sterilized at high temperatures.

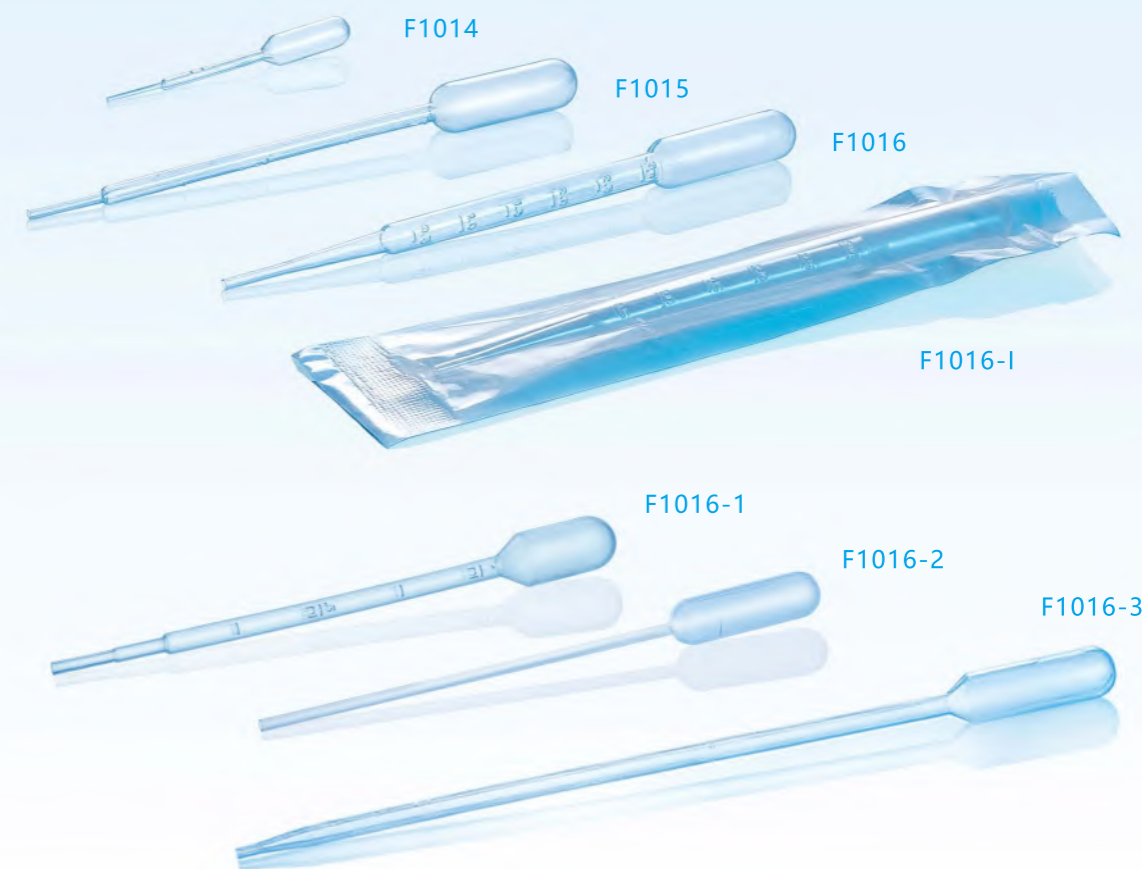

Item No.	Description of Goods	Quantity	Packing
F1014	25 μ l & 35 μ l Transfer pipette	16000	2000pcs*8bags
F1015	1ml Transfer pipette	5000	250pcs*20bags
F1016	3ml Transfer pipette	5000	250pcs*20bags
F1016-1	3ml Transfer pipette, sterile	2500	1pc*100pcs/bags*25bags
F1016-1	1.5ml Transfer pipette	5000	250pcs*20bags
F1016-2	1ml Transfer pipette	5000	250pcs*20bags
F1016-3	3.5ml Transfer pipette	4000	250pcs*16bags

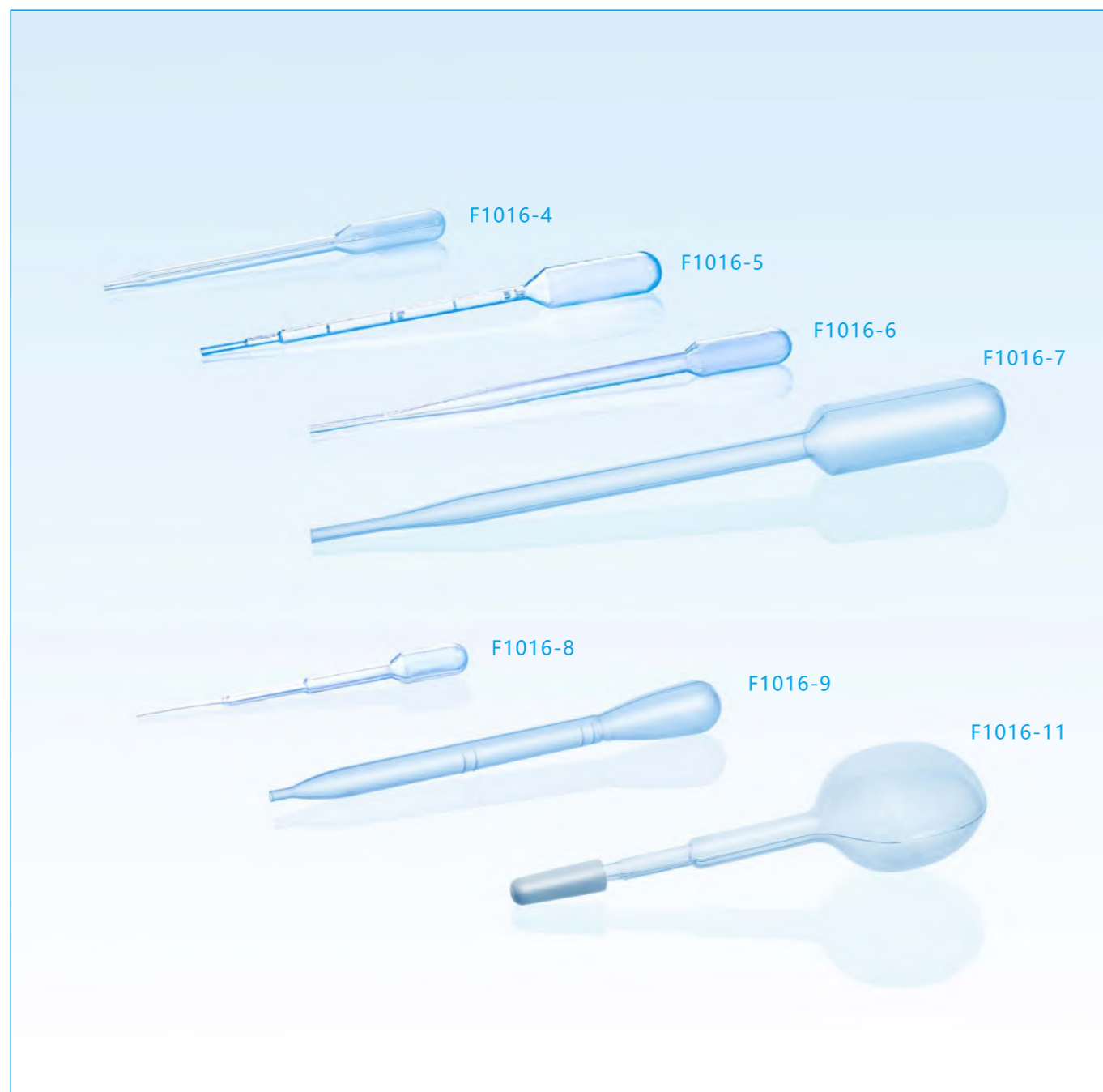

Item No.	Description of Goods	Quantity	Packing
F1016-4	1ml Transfer pipette	5000	250pcs*20bags
F1016-5	3.5ml Transfer pipette	4000	250pcs*16bags
F1016-6	2ml Transfer pipette	5000	250pcs*20bags
F1016-7	5ml Transfer pipette	4000	250pcs*16bags
F1016-8	1ml Transfer pipette	5000	250pcs*20bags
F1016-9	2ml Transfer pipette	5000	250pcs*20bags
F1016-11	Spherical pipette	5000	250pcs*20bags



TEST TUBES & RACKS SERIES

The Gongdong test tube series is made of material PP, PS. It is transparent, smooth and high chemically tolerant. Among them, the test tube made of material PP is resistant to weak acid, weak base, organic solvent and high temperature, which can offer various specifications, flat bottom, round bottom, and various lengths.

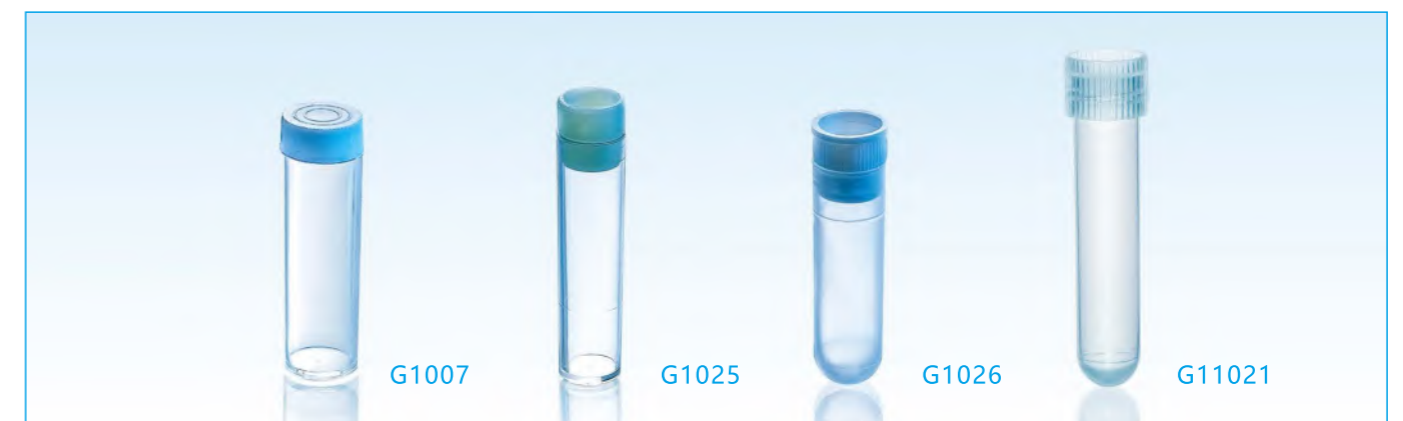
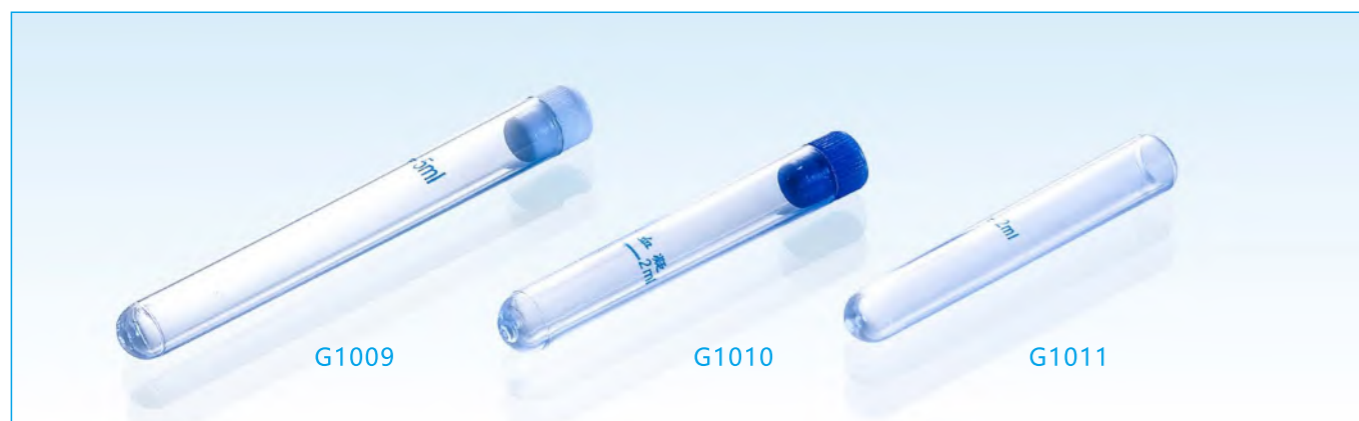
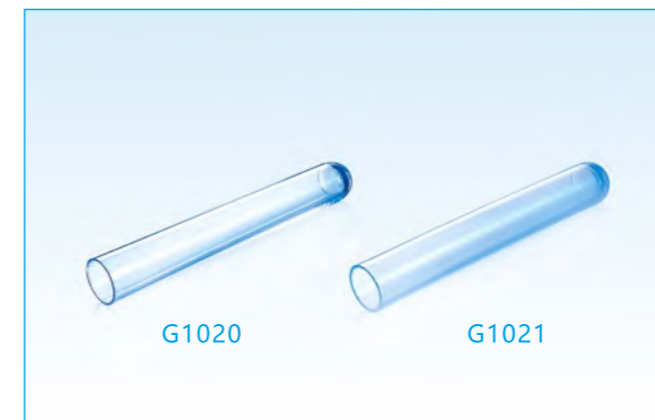
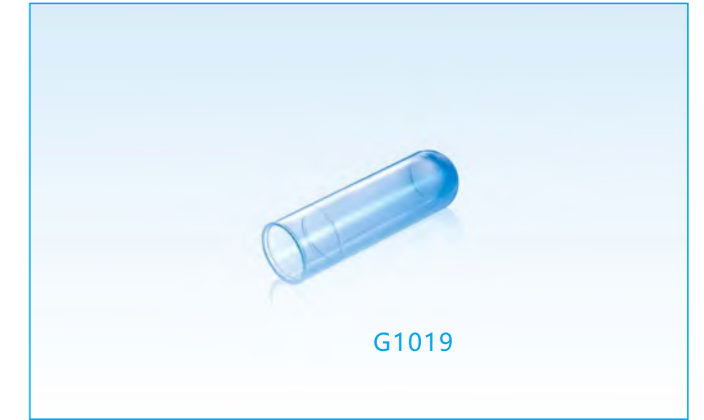
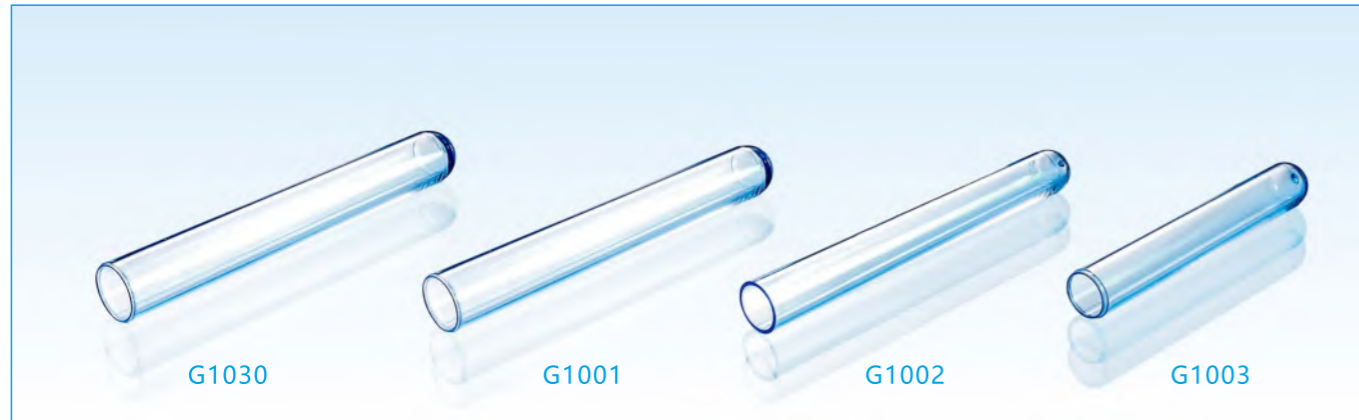

Item No.	Description of Goods	Quantity	Packing
G1030	Test Tube 16*100mm	1600	200pcs*8bags
G1001	Test Tube 15*100mm, 10ml	2000	200pcs*10bags
G1002	Test Tube 13*100mm, 7ml	3000	300pcs*10bags
G1003	Test Tube 13*78mm, 5.5ml	4008	334pcs*12bags
G1004	Test Tube 12*60mm, 3.5ml	6000	400pcs*15bags
G1005	Test Tube 12*75mm, 5ml	4800	400pcs*12bags
G1006	Test Tube 12*78mm, 5.5ml	4800	400pcs*12bags
G1009	Test Tube 13*100mm, 7ml with cap, with 5ml graduation	3000	300pcs*10bags
G1010	Test Tube 12*75mm, 5ml with cap, with 2ml graduation	4800	400pcs*12bags
G1011	Test Tube 12*60mm, 3.5ml, with 2ml graduation	6000	400pcs*15bags

Item No.	Description of Goods	Quantity	Packing
G1012	Test Tube 12*75mm, 5ml, used for BD flow cytometry	4008	334pcs*12bags
G1013	Test Tube 12*75mm, 5ml, hexagonal bottom	4800	400pcs*12bags
G1019	Test Tube 15*50mm, 4.5ml	3600	400pcs*9bags
G1020	Test Tube 13*78mm, 5.5ml	4800	400pcs*12bags
G1021	Test Tube 12*75mm, 5ml PS/PP	4800	400pcs*12bags
G11021	Test Tube 16*75mm (round bottom)	2500	25pcs*100bags
G1025	Test Tube 15*60mm (flat bottom)	2800	5pcs*560bags
G1026	Test Tube 16*60mm (round bottom)	2500	25pcs*100bags
G1027	Test Tube 15*150mm, 15ml	1500	100pcs*15bags
G1007	Test Tube 16*53mm, 6ml with cap	3000	300pcs*10bags

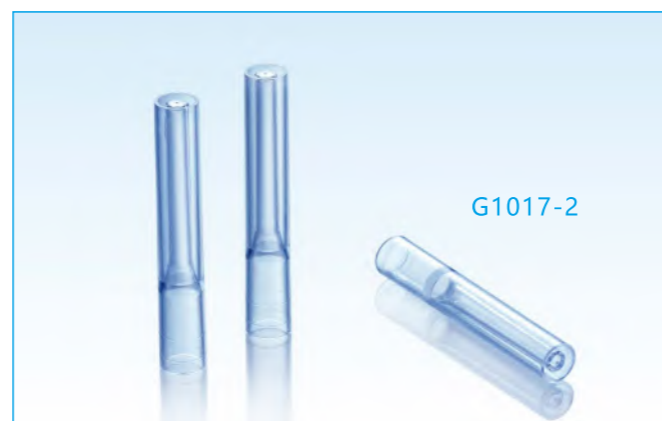
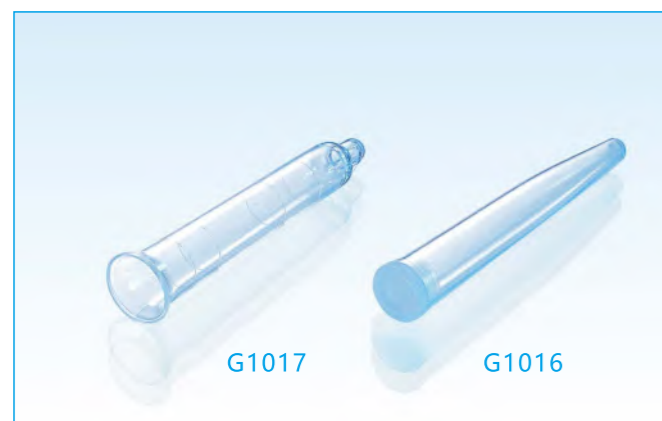



Product Description

- Tube body material: high transparent PS, Cap: PP + silicone film.
- Maximum capacity: 11ml, can withstand 3400 rpm centrifugation.

Use Method

- After collecting urine with a disposable urine cup, the tested person pours the urine into the urine sediment test tube, puts the cap on and sends it to the laboratory, and puts it into the special test tube rack of the urine sediment analyzer. The cap should be unscrewed before starting the test.



G1017-3

G1017-1



Item No.	Description of Goods	Quantity	Packing
G1016	Test Tube 12ml with cap	2800	200pcs*14bags
G1017	Test Tube 12ml urine cup	1500	150pcs*10bags
G1017-1	12ml urine cup with cap	1500	150pcs*10bags
G1017-2	US urine test tube	1200	200pcs*6bags
G1017-3	Urine test tube(new type) with cap	2000	100pcs*20bags

Item No.	Description of Goods	Quantity	Packing
G1022	13*150mm, tube with Swab	1800	150pcs*12bags
G1023	12*75mm, tube with Swab	2200	2pcs/bags*100bags*11bags
G1031	16*95mm test tube with pipette	1500	150pcs*10bags
G1017-14	6ml urine test tube	2000	200pcs/bag*10bags
G1028	Test tube with graduation, 14.7X101mm with cap. Color: transparent or amber	1000	100pcs*10bags
G1017-4	12ml urine cup with cap	1500	150pcs*10bags

Cary-Blair Transport medium

- It is used to collect and transport specimen of Escherichia coli, Klebsiella, Salmonella and Shigella.
- Specimens can be stocked at 4°C for 48 hours.

Amies and Amies with Charcoal Transport medium

- It is used to collect and transport specimen of Escherichia coli.
- Specimens can be stocked at 4°C for 48 hours.

Stuart and Stuart with Charcoal Transport medium

- It is used to collect and transport specimen of gonococcus.
- Specimens can be stocked at 4°C for 48 hours.

Item No.	Description of Goods	Quantity	Packing
G10261	Transport swab with medium (Amies)	600	50pcs*12bags
G10262	Transport swab with medium (Amies with charcoal)	600	50pcs*12bags
G10263	Transport swab with medium (Cary Blair)	600	50pcs*12bags
G10264	Transport swab with medium (Stuart)	600	50pcs*12bags
G10265	Transport swab with medium (Stuart with charcoal)	600	50pcs*12bags

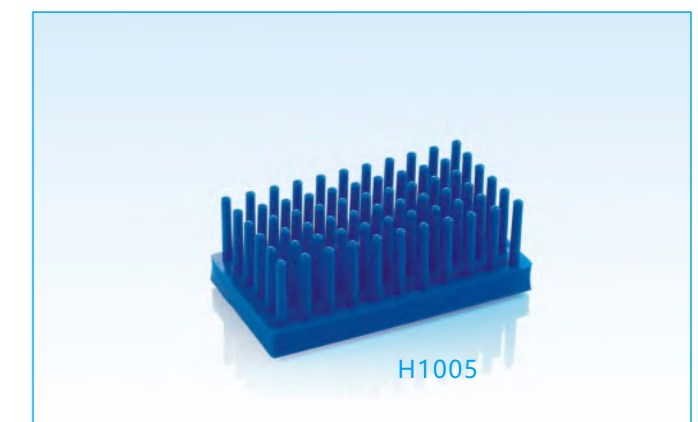
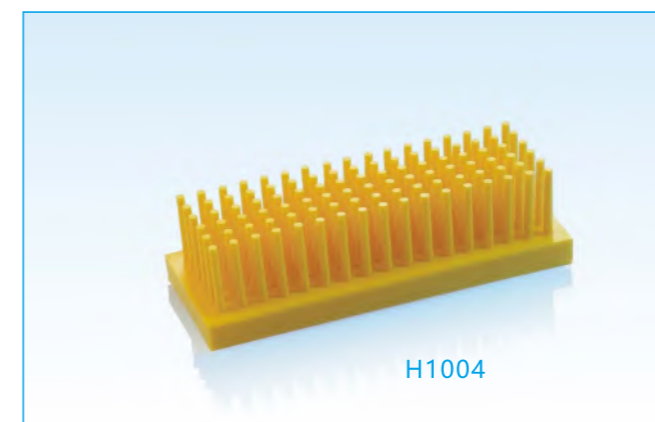
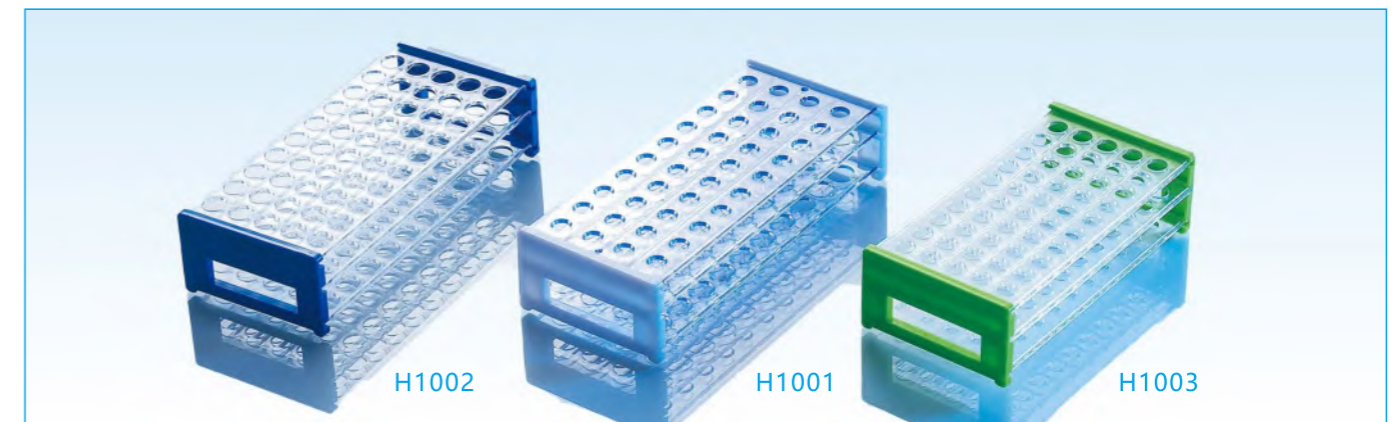

Item No.	Description of Goods	Quantity	Packing
H1001	40 Wells φ18mm Tube Rack	40	2pcs/bag*20bags
H1002	50Wells φ15mm Tube Rack	40	2pcs/bag*20bags
H1003	50Wells φ13mm Tube Rack	40	2pcs/bag*20bags
H1004	Pillar-like φ5*16 Tube Rack	54	1pc*54bags
H1005	Pillar-like φ5*10 Tube Rack	51	1pc*51bags
H1018	Multi-Function Rack	50	1pc*50bags
H1019	Double-Deck Muti-Function Rack	25	1pc*25bags

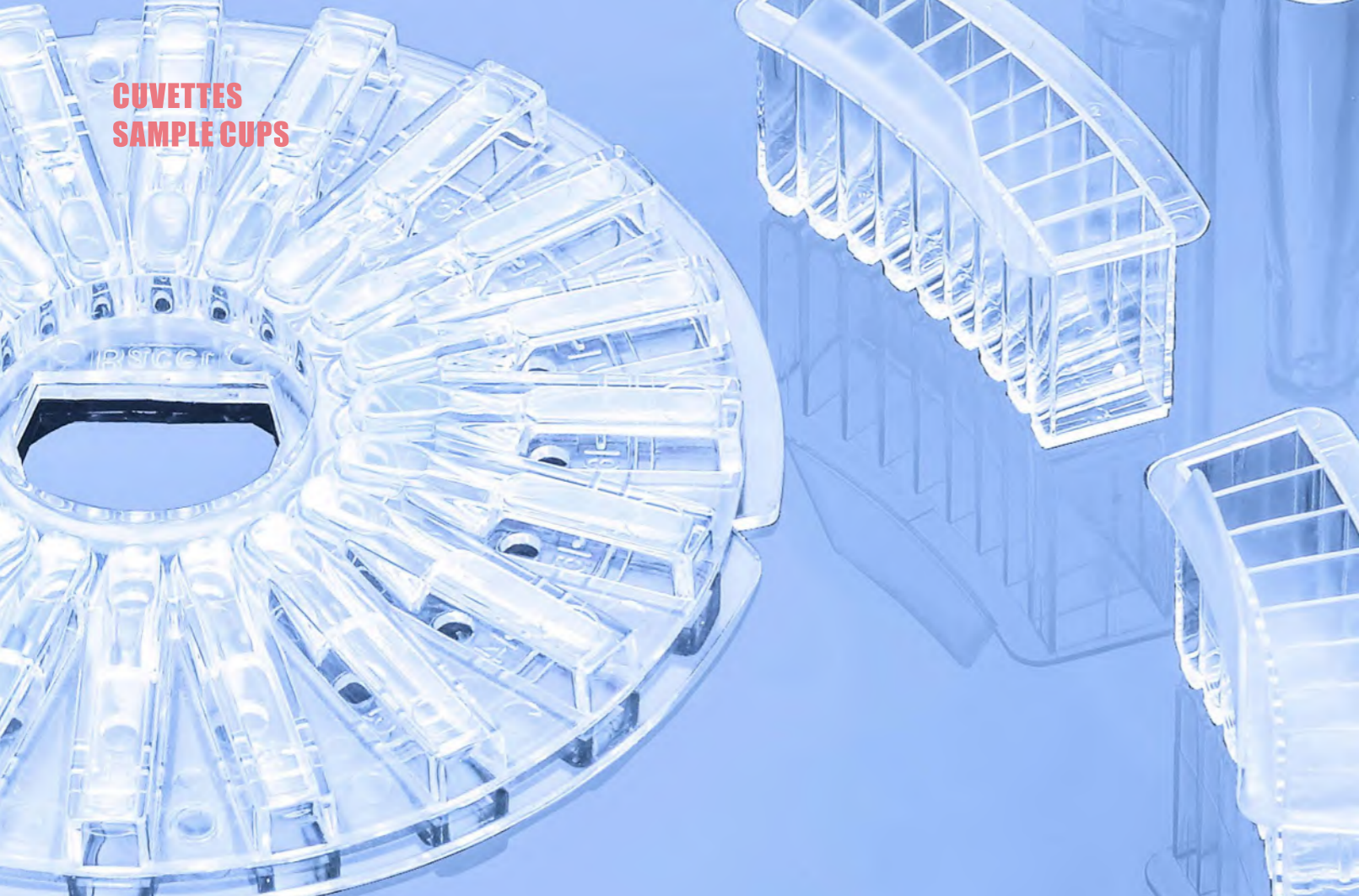

CUVETTES & SAMPLE CUPS

The Gongdong sample cup series adopts imported optical plastics, and is casted with high precision mould. The inside and outside surface of the product is transparent, level and smooth with superior light transmission performance. It is suitable for all kinds of automatic biochemical analyzer, blood coagulation instrument and spectrophotometer at home and abroad.

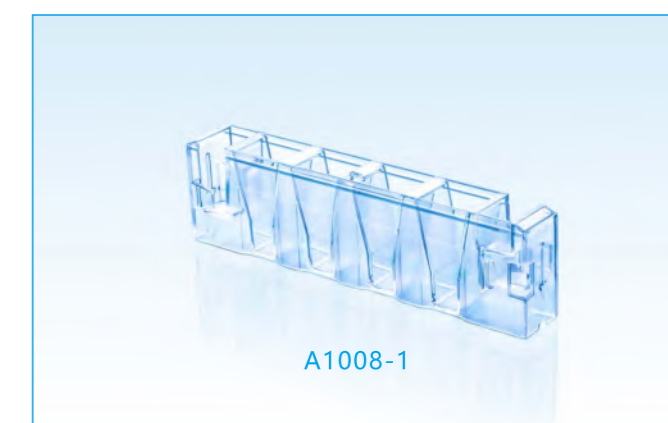
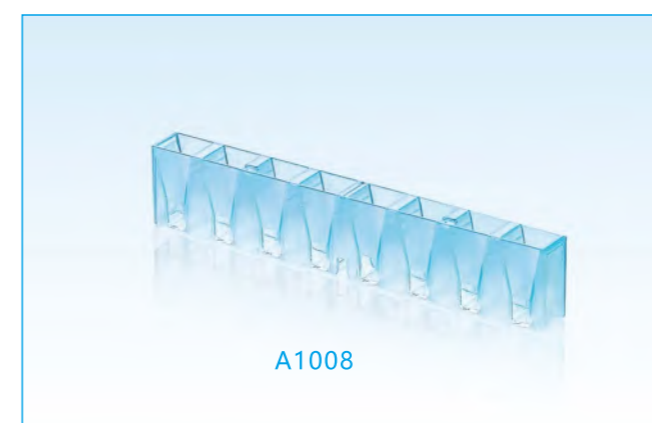

Item No.	Description of Goods	Quantity	Packing
A1001	Tianjin Pulisheng & French stago	1600	50pcs/box*32boxes/ctn
A1001-1	Steellex Reaction Vessels	2304	72pcs/box*32boxes/ctn
A1002-1	American MD 3000 Biochemical Analysis	960	240pcs/box*4boxes/ctn
A1005	BN100 Special Protein Apparatus	2688	70pcs/box*32boxes/ctn
A1007	American Pacific, German TECO	3200	100pcs/bag*32bags/ctn
A1007-1	MC Coatron 1800	3200	100pcs/bag*32bags/ctn
A1008	Beckman	1500	100pcs/box*15boxes/ctn
A1008-1	Beckman Top	1500	100pcs/box*15boxes/ctn



Item No.	Description of Goods	Quantity	Packing
A1018	Spain Cruor Apparatus	8000	1000pcs*8bags
A1019	German LABOR	10000	1000pcs*10bags
A1020	German TECO Sample Cup	12000	1000pcs*12bags
B1009	Japan TOA CA1500	20000	2000pcs*10bags
B1010	Japan TOA CA530	20000	2000pcs*10bags
B1011	Japan TOA CA6000	20000	2000pcs*10bags
B1020	Japan TOA CA7000	20000	1000pcs*20boxes
B1005	Abbott AXSYM	3600	400pcs*9bags
B1016	For Special Protein Analyzer	960	40pcs/box*24boxes

Item No.	Description of Goods	Quantity	Packing
B1025	Abbott R2000	10000	1000pcs*10boxes
B1026	Siemens ADVIA Centaur CP	6000	1000pcs*6bags
B1027	Siphon quantitative extraction tubes	10000	1000pcs*10bags
B1015	Rayto RAC-1800 hematology machine	20000	1000pcs*20boxes
C1001	Hitachi 7150, 7060 Series; Aulinbas 2ml	5000	500pcs*10bags
C1002	BECKMAN COULTER CX Series, 0.5ml	8000	1000pcs*8bags
C1003	IL Sample Cup, Monarch Biochemical Analysis Apparatus(0.5ml)	13000	1000pcs*13bags



Item No.	Description of Goods	Quantity	Packing
C1004	BECKMAN COULTER 700(1.5ml), AmericanDubang, Holland VITALAB SAMPLE CUP	8000	1000pcs*8bags
C1025	FC serum sample cup(L)	10000	1000pcs*10bags
C1026	FC serum sample cup(S)	10000	1000pcs*10bags
C1017	Hitachi Minimum	6000	500pcs*12bags
C1019	Hitachi Conical	9000	1000pcs*9bags
C1020	Kodak Sample Cup	12000	1000pcs*12bags
C1028	Beckman DX1800RV	12000	1000pcs*12bags
C1029	Analysis tube	2400	200pcs*12bags

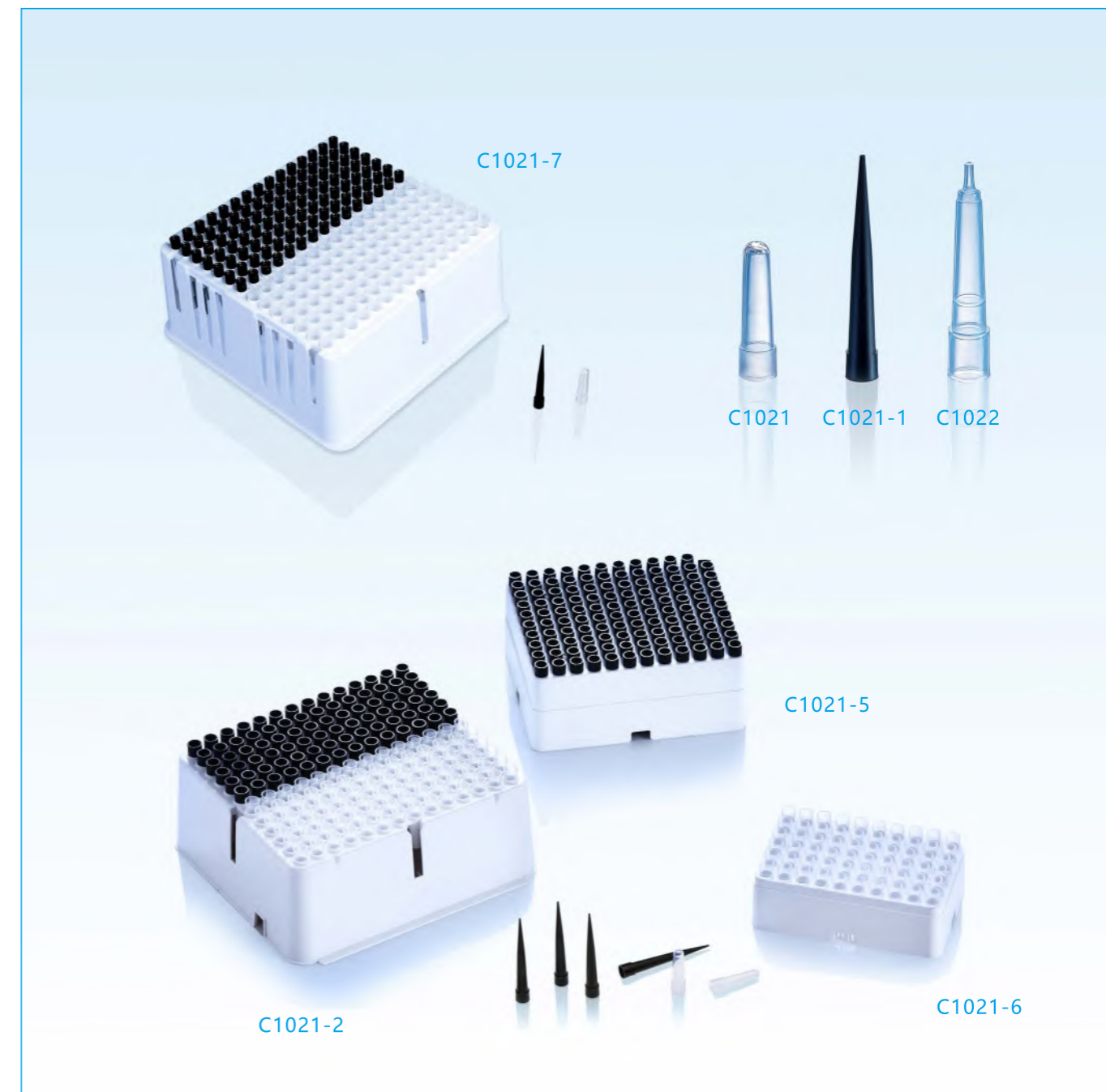

Item No.	Description of Goods	Quantity	Packing
C1021	BOWLIN MAN Sample Tube	500	100pcs/box*5boxes
C1021-1	BOWLIN MAN black pipette tips	20000	1000pcs*20boxes
C1022	Kodak Tip	16000	1000pcs*40bags
C1021-2	Roche Tip&Cup	48boxes	6boxes/bag*8bags
C1021-5	Roche Tip (with box)	120boxes	120boxes
C1021-6	Roche Cup (with box)	240boxes	240boxes
C1021-7	Roche 801	36 boxes	36 boxes



OTHER DISPOSABLE PLASTICWARES

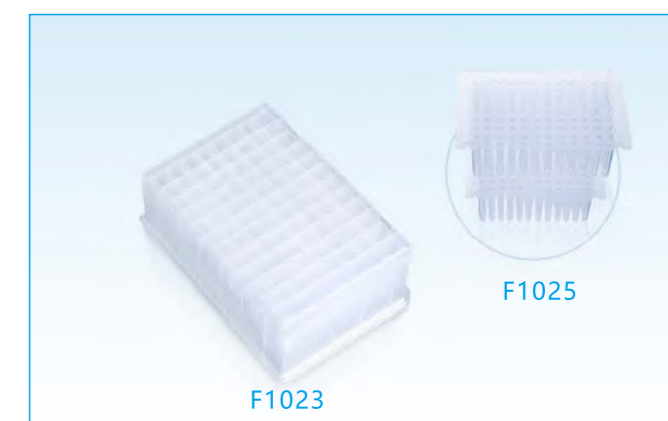
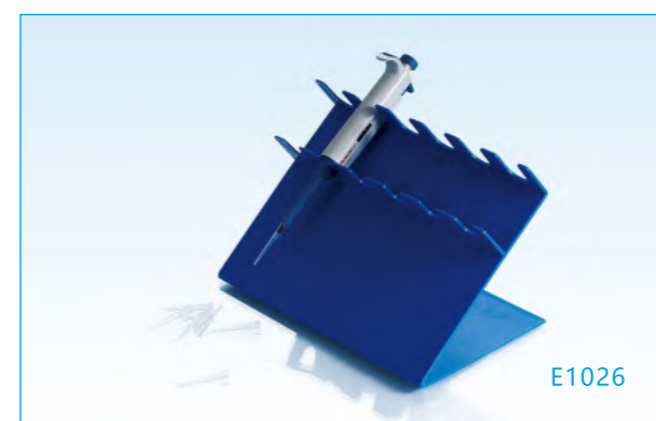

Item No.	Description of Goods	Quantity	Packing
H1010	PP Container with separating plate	10	pile up
F1019	Reservoir type "V"	200	Individual Packing
E1026	Pipette shelf	10	in bulk
F1023	96 deep-well plate, v-bottom	50	Individual Packing 50pcs/case
F1025	96 tip comb for deep-well	100	Individual Packing 100pcs/case
GDF01	Disposable face shield,PET,Size:33-22cm Thickness: 0.18±0.05mm	200	1pc/Polyethylene film bags*10pcs/ PE bags*20PE bags
GDG01	Toughened Lens to prevent for Scratches, Anti-flog	300	1pc/PEbags*12pcs/Carton*25Carton
GDG02	Eye Glass, Non-sterile	200	10pcs/cs*20cs



PHARMACEUTICAL PACKAGING MATERIALS

Gongdong got state food and drug administration approved, which includes oral solid pharmaceutical HDPE bottles (State Drug Packing Material Administration Approve No.:20130717) and oral liquid medicinal polyester bottles (State Drug Packing Material Administration Approve No.:20130122), PP Topical ointment bottles with the sealing (State Drug Packing Material Administration Approve No.:20060014), Drug-Prefilled PP vaginal syringes (State Drug Packing Material Administration Approve No.:20140075), Oral drops LDPE bottles (State Drug Packing Material Administration Approve No.:20060101). Gongdong imported advanced instruments and packaging machines from Germany, which can be used to R&D various specifications of products for various pharmaceutical manufacturers, biological products companies and hospitals. Nowadays, Gongdong have already built long-term cooperation with many well-known pharmaceutical industry, and became a well-known manufacturing base of drug packing material.

