

iMOW® 5.0, 6.0, 7.0

STIHL



2 - 46 Instruction Manual



Contents

1	Introduction.....	2
2	Guide to Using this Manual.....	2
3	Overview.....	3
4	Safety Precautions.....	5
5	Description of Operation.....	13
6	Preparing the Mowing Area and Robot Mower for Operation.....	14
7	Positioning the docking station.....	15
8	Installing the Perimeter Wire.....	22
9	Completing the Perimeter Wire Installation	29
10	Installing Guide Wire.....	31
11	Electrically connecting the docking station	33
12	Charging the Robot Mower.....	35
13	Closing Bluetooth® Radio Interface.....	35
14	Light patterns on the robot mower and charging station.....	36
15	Operating and Adjusting the Robot Mower	36
16	Stopping the robot mower and activating the device lock.....	37
17	Transporting.....	37
18	Storing.....	38
19	Cleaning.....	39
20	Maintenance.....	39
21	Repairing.....	41
22	Troubleshooting.....	42
23	Specifications.....	42
24	Spare Parts and Accessories.....	44
25	Disposal.....	44
26	EC Declaration of Conformity.....	44
27	UKCA Declaration of Conformity.....	45
28	Open Source Software.....	45

1 Introduction

Dear Customer,

Thank you for choosing STIHL. We develop and manufacture our quality products to meet our customers' requirements. The products are designed for reliability even under extreme conditions.

STIHL also stands for premium service quality. Our dealers guarantee competent advice and instruction as well as comprehensive service support.

STIHL expressly commit themselves to a sustainable and responsible handling of natural resources. This user manual is intended to help you use your STIHL product safely and in an environmentally friendly manner over a long service life.

We thank you for your confidence in us and hope you will enjoy working with your STIHL product.



Dr. Nikolas Stihl

**IMPORTANT! READ BEFORE USING AND
KEEP IN A SAFE PLACE FOR REFERENCE.**

2 Guide to Using this Manual

2.1 Applicable Documents

The local safety regulations apply.

- ▶ In addition to this User Manual, you should also read, understand and retain the following documents:
 - Safety information for STIHL batteries and products with built-in battery:
www.stihl.com/safety-data-sheets

Additional information on STIHL robotic mowers, compatible accessories and FAQs can be found at support.stihl.com, info.myimow.stihl.com or is available at a STIHL authorized dealer.

The Bluetooth® mark designation and Bluetooth® logos are registered trademarks owned by Bluetooth SIG, Inc. These word marks and logos are used by STIHL under license.

The robot mower is equipped with a Bluetooth® radio interface and radio network interface. Local operating restrictions (in aircraft or hospitals, for example) must be observed.

2.2 Warning Notices in Text

DANGER

- This notice refers to risks which result in serious or fatal injury.
 - ▶ Serious or fatal injuries can be avoided by taking the precautions mentioned.

WARNING

- This notice refers to risks which **can** result in serious or fatal injury.
 - ▶ Serious or fatal injuries can be avoided by taking the precautions mentioned.

NOTICE

- This notice refers to risks which can result in damage to property.
 - ▶ Damage to property can be avoided by taking the precautions mentioned.

2.3 Symbols in Text

This symbol refers to a chapter in this instruction manual.

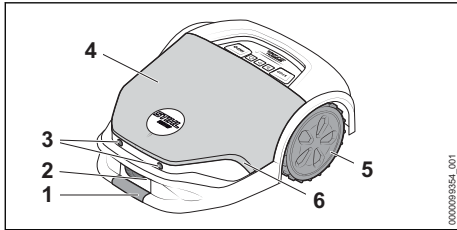
3 Overview**3.1 Robot mower**

- 1 Front grip surface**
Lift and transport the robot mower by simultaneously gripping it at the front and rear grip surface.
- 2 Charging contacts**
The charging contacts connect the robot mower with the docking station.
- 3 Ultrasound sensors**
The ultrasound sensors detect obstacles.
- 4 Hood**
The hood is spring-mounted and features a bump sensor to detect obstacles on the mowing area.
- 5 Drive wheels**
The drive wheels drive the robot mower.
- 6 Light strip**
The light strip shows the robot mower's status.

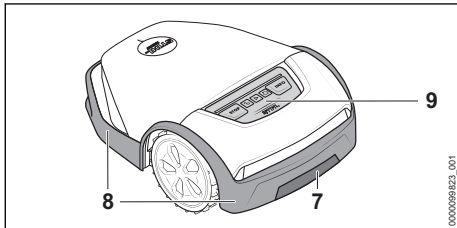
**7 Rear grip surface**

Lift and transport the robot mower by simultaneously gripping it at the front and rear grip surface.

8 Protective strip

The protective strip protects the user against ejected objects and contact with the blades.

9 Control panel

The control panel features pushbuttons and a rain sensor.

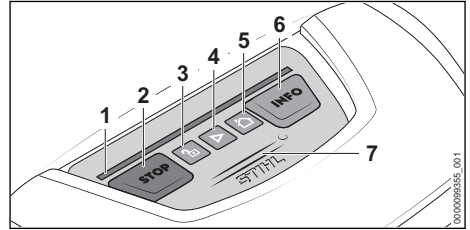
3.2 Control panel**1 Light strip**

The light strip shows the robot mower's status and signals which key combination to press for a certain action.

2 STOP pushbutton

The pushbutton stops the robot mower and mowing unit. The pushbutton also activates the device lock.

3 LOCK pushbutton

This pushbutton unlocks the robot mower in conjunction with a displayed key combination.

4 START pushbutton

This pushbutton starts mowing operations.

5 HOME pushbutton

This pushbutton makes the robot mower return to the docking station or cancels the current mowing job if the robot mower is in the docking station.

6 INFO pushbutton

This pushbutton starts voice output about the current status of the robot mower.

7 Rain sensor

The rain sensor reacts to moisture. Depending on the setting, the robot mower can take weather conditions into account for the mowing plan.

3.3 Mowing unit

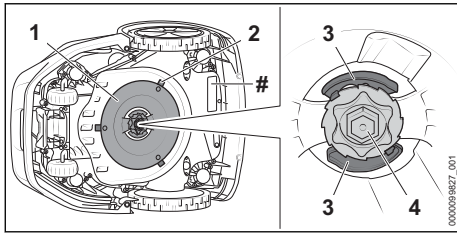

- 1 Blade disk**
The blade disk serves to attach the blades.
- 2 Blades**
The blades mow the lawn.
- 3 Levers**
The levers secure the nut.
- 4 Nut**
The nut secures the blade disk.

Rating plate with the machine number

3.4 Docking station and power supply

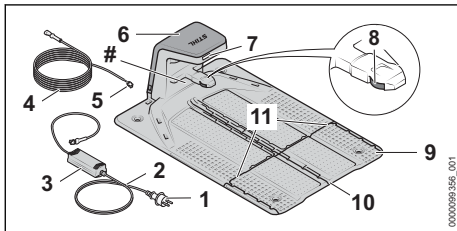

- 1 Mains plug**
The mains plug connects the connecting cable to a socket.
- 2 Connecting cable**
The connecting cable connects the power supply to the mains plug.
- 3 Power supply**
The power supply supplies the docking station with energy.
- 4 Charging cable**
The charging cable connects the power supply to the docking station.
- 5 Plug**
The plug connects the charging cable to the docking station.
- 6 Hood**
The hood covers the docking station and protects the internal electronics.

7 LED

The LED indicates the status of the docking station.

8 Charging contacts

The charging contacts connect the docking station with the robot mower.

9 Base plate

The base plate is the base for the docking station.

10 Cable duct

The guide wire is routed in the middle cable duct.

11 Cable duct

The perimeter wire is routed in the outer cable ducts.

Rating plate with the machine number

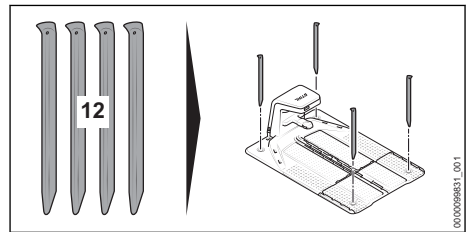

12 Ground peg

The four ground pegs secure the docking station to the ground.

3.5 iMOW® Ruler and Installation Kit

iMOW® Ruler

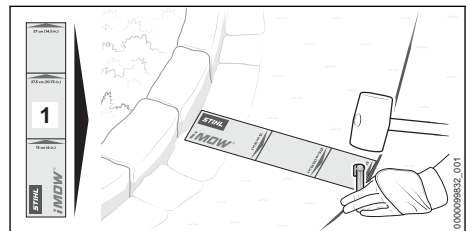

1 iMOW® Ruler

The ruler makes it easier to install wires and serves to maintain the correct distance.

Installation Kit

An installation kit is required to commission the robot mower; it is not included in the scope of delivery of the robot mower. Appropriate installa-

tion kits are available as accessories for different garden sizes.

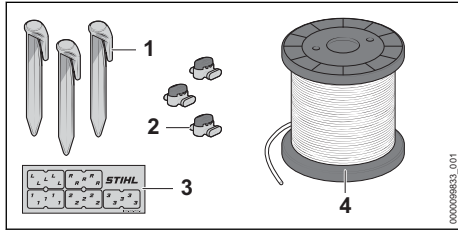

- 1 Fixing pin**
The fixing pin secures the perimeter wire and guide wire to the ground.
- 2 Wire connector**
The wire connector connects wire ends to each other.
- 3 Cable markers**
The cable markers serve to mark wire ends on the inside of the docking station. They facilitate the assignment of the wire ends when connecting to the correct terminal.
- 4 Wire coil**
The wire coil is required to install the perimeter wire and guide wire.

3.6 Symbols

Meanings of symbols on the robot mower, docking station, power supply or installed battery:

- This symbol shows the diameter of the blade disk.
- This symbol indicates the direction for unlocking the blade carrier when changing blades.
- This symbol indicates the direction for locking the blade carrier when changing blades.
- Protection class 2, double insulated.
- Do not dispose of the product with domestic waste.
- The information next to this symbol indicates the energy content of the battery according to the cell manufacturer's specification. The energy content available during use is lower.
- 1 LED lights up red. The battery is too warm or too cold.
- 4 LEDs flash red. There is a fault in the battery.

4 Safety Precautions

4.1 Warning symbols

Meanings of warning symbols on the robot mower, docking station, power supply or installed battery:

- Observe safety instructions and take the necessary precautions.
- Read and understand the User Manual and keep it in a safe place.
- Comply with the safety instructions concerning ejected objects and take the necessary precautions.
- Maintain a safe distance.
- Do not touch rotating blade disk with blades.
- Do not climb or sit on the robot mower.
- Stop the robot mower and activate the device lock during transport, storage, cleaning, servicing, repair or when there is changed or unusual behavior.
- Keep children away from the robot mower and mowing area.
- Keep animals away from the robot mower and mowing area.
- Do not immerse the battery in liquids.
- Protect battery against heat and fire.

4.2 Intended Use

STIHL iMOW® 5.0, 6.0, 7.0 robotic mowers are designed for mowing and mulching grass. The STIHL docking station and supplied power supply DM160X-420X or DM210X-420X are

used to charge STIHL iMOW® 5.0, 6.0, 7.0 robotic mowers.

The robotic mower, docking station and power supply can be used in the rain.

A STIHL AAI battery supplies the robotic mower with power. The battery has been installed in the robotic mower and may only be removed by a STIHL authorized dealer.

The robotic mower can be configured and operated via the MY iMOW® app.

▲ WARNING

- Docking stations, power supply units and batteries not explicitly approved for the STIHL robotic mower may cause a fire or explosion. Persons may be seriously or fatally injured, and property may be damaged.
 - ▶ Use the robotic mower with the STIHL AAI installed battery.
 - ▶ Charge the STIHL iMOW® 5.0, 6.0, 7.0 robotic mower with the STIHL docking station and STIHL power supply DM160X-420X or DM210X-420X.
- Using the robotic mower, battery, docking station or power supply other than for its intended use can result in serious injuries or death and damage to property.
 - ▶ Use the robotic mower, docking station and power supply as described in this User Manual.

4.3 Requirements for the user

▲ WARNING

- Users without adequate training or instruction cannot recognize or assess the risks involved in using the robot mower, docking station and power supply. The user or other persons may sustain serious or fatal injuries.



- ▶ Read and understand the User Manual and keep it in a safe place for reference.
- ▶ If you pass the robot mower, docking station or power supply on to another person: Always give them the User Manual.
- ▶ Make sure that the user meets the following conditions:
 - The user is rested.
 - The user is physically, sensorially and mentally able to use and operate the robot mower, docking station and power supply. If the user is able to operate the equipment but is physically, hearing,

visually or mentally impaired, the user may only use the robot mower under the supervision of or after receiving instruction from a responsible person. This includes all work with and on the robot mower, docking station, power supply, charging cable, guide wire and perimeter wire.

- The user can recognize and assess the risks involved in using the robot mower, docking station and power supply.
- The user is an adult or is being trained in an occupation under supervision according to national regulations.
- The user has received instruction from a STIHL authorized dealer or other experienced user before using the robot mower, docking station and power supply for the first time.
- The user is not under the influence of alcohol, medication or drugs.
- During installation, operation, cleaning, maintenance and transportation of the robot mower, keep your balance, provide secure footing and do not run.
- The terms "operation", "use" and "usage" include all work on the robot mower, docking station, power supply, charging cable, guide wire and perimeter wire as well as all iMow® accessories.
- ▶ If you are unsure: Consult a STIHL authorized dealer.

4.4 Clothing and Equipment

▲ WARNING

- During the routing of the perimeter wire or guide wire and attaching the docking station, objects may be thrown at high speed by driving a fixing pin or earth staple into the ground. This may result in injury to the user.
 - ▶ Wear close-fitting safety glasses. Suitable safety glasses are tested in accordance with EN 166 or national regulations and available commercially with the corresponding marking.
 - ▶ Wear work gloves made of robust material.
- Objects can be ejected at high speed during the mowing operation. This may result in injury to the user.
 - ▶ If the mowing area is entered during the mowing operation:
 - Wear long pants made of robust material.

- Wear sturdy, closed-toed footwear with high-grip soles.
- Unsuitable clothing may get caught in wood, undergrowth and in the robot mower. Users not wearing suitable clothing may be seriously injured.
 - ▶ Wear close-fitting clothing.
 - ▶ Remove scarves and jewelry.
- The user may come into contact with the blades during cleaning, maintenance or transport. This may result in injury to the user.
 - ▶ Wear work gloves made of robust material.
- Wearing unsuitable footwear may cause the user to slip. This may result in injury to the user.
 - ▶ If the mowing area is entered during the mowing operation: Wear sturdy, closed-toed footwear with high-grip soles.

4.5 Work Area and Surroundings

4.5.1 Robot mower and mowing area

▲ WARNING

- Bystanders, children and animals cannot be aware of nor assess the dangers of the robot mower and objects being thrown into the air. This may result in serious injury to bystanders, children and animals and damage to property.



- ▶ Keep bystanders, children and animals away from the mowing area during the mowing operation.
- ▶ If the robot mower is used in publicly accessible areas: Close off mowing area and set up signs with warning text "Warning! Automatic lawn mower! Keep children and animals away and supervise them!" Comply with local regulations.
- ▶ Make sure that children cannot play with the robot mower.
- ▶ With the help of the perimeter wire, define the mowing area as described in this User Manual. Using the perimeter wire, mark off designated areas that the robot mower must not mow or navigate from the mowing area.
- ▶ Do not operate the robot mower on gravel or crushed stone.
- People can trip over the perimeter wire, guide wire or the fixing pins. This may result in injury to people and damage to property.
 - ▶ Route the perimeter wire and guide wire flat on the ground.
 - ▶ Drive the fixing pins completely into the ground.

- If a gardening tool is used in the mowing area, the tool can strike and damage the perimeter wire, guide wire or fixing pins. Objects can be ejected at high speed. This may result in injury to people and damage to property.
 - ▶ Do not use a gardening tool around the perimeter wire or guide wire.
- The robot mower's electrical components can produce sparks. Sparks may cause fires and explosions in highly flammable or explosive environments. Persons may be seriously or fatally injured, and property may be damaged.
 - ▶ Do not operate the robot mower in highly flammable or explosive environments.
- As a result of a storm, the robot mower can be damaged, or foreign objects may be on the mowing area. The robot mower may be in an unsafe condition, and objects may be ejected at high speed during the mowing. Persons may be seriously or fatally injured, and property may be damaged.
 - ▶ After a storm, check that the robot mower is in a safe condition.
 - ▶ Check the condition of the mowing area and remove any foreign objects from it.

4.5.2 Battery

The battery has been installed in the robot mower and must only be removed by a STIHL authorized dealer.

▲ WARNING

- Bystanders, children and animals cannot recognize or assess the dangers of the battery. Bystanders, children and animals may be seriously injured.
 - ▶ Keep bystanders, children and animals away from the work area.
 - ▶ Do not leave the battery unattended.
 - ▶ Make sure that children cannot play with the battery.
 - The battery is not protected against all ambient conditions. If the battery is exposed to certain ambient conditions, the battery may catch fire, explode or be irreparably damaged. This may result in serious injury to people and damage to property.
 - ▶ Protect battery from heat and fire.
 - ▶ Do not throw the battery into a fire.
- ▶ Do not charge, use and store the battery outside of the specified temperature limits,  23.6.





- ▶ Do not immerse the battery in liquids.

- ▶ Keep battery away from small metal parts.
- ▶ Do not expose the battery to high pressure.
- ▶ Do not expose the battery to microwaves.
- ▶ Protect the battery against chemicals and salts.

4.5.3 Docking station and power supply

▲ WARNING

- Bystanders, children and animals are not aware of and cannot assess the dangers of the docking station or power supply. Bystanders, children and animals may be seriously or fatally injured.
 - ▶ Keep bystanders, children and animals away from the work area.
 - ▶ Make sure that children cannot play with the docking station or power supply.
- The docking station and the power supply are not protected against all environmental conditions. If the docking station and power supply are exposed to certain environmental conditions, they may catch fire or explode. This may result in serious injury to people and damage to property.
 - ▶ Do not operate the docking station and power supply in a flammable environment or explosive environment.
 - ▶ Do not use or store the docking station and power supply outside of their specified temperature limits,  23.6.
 - ▶ Disconnect the power supply before a storm or when there is a risk of a lightning strike.
- People can trip over the docking station, charging cable, power supply or connecting cable. People can be injured, and the docking station, charging cable, power supply or connecting cable can be damaged.
 - ▶ Set up the docking station and power supply in a clearly visible area.
 - ▶ Route the connecting cable and charging cable flat on the ground.
- The housing of the power supply can get very hot in direct sunlight. There is a risk of burn injuries.

- ▶ Do not touch a hot power supply.



4.6 Safe Condition

4.6.1 Robot mower

The robot mower is in a safe condition if the following conditions are met:

- The robot mower is undamaged.
- The controls function properly and have not been modified.
- The blades are properly installed and are undamaged.
- Original STIHL accessories designed for this robot mower are installed.
- The accessories are correctly installed.

▲ WARNING

- If not in safe condition, components may no longer operate correctly and safety devices may be rendered ineffective. There is a risk of serious or fatal injury.
 - ▶ Operate an undamaged and functioning robot mower.
 - ▶ Do not modify the robot mower.
 - ▶ If the control panel is not functioning: Do not operate the robot mower.
 - ▶ Install original STIHL accessories designed for this robot mower.
 - ▶ Install the blades as described in this User Manual.
 - ▶ Install accessories as described in this User Manual or in the User Manual for the accessories.
 - ▶ Do not insert objects in the robot mower's openings.
 - ▶ Do not bridge charging contacts with metallic objects (short circuit).
 - ▶ Replace worn or damaged labels.
 - ▶ If you are unsure: Consult a STIHL authorized dealer.

4.6.2 Blades

The blades are in a safe condition if the following conditions are met:

- The blades, blade disk and blade carrier are undamaged.
- The blades are not deformed.
- The blades are properly installed.

▲ WARNING

- If they are in an unsafe condition, parts of the blades may come off and be ejected at high speed. People may be seriously injured.
 - ▶ Work with undamaged blades and an undamaged blade disk and blade carrier.
 - ▶ Install blades correctly.
 - ▶ If you are unsure: Consult a STIHL authorized dealer.

4.6.3 Battery

The battery has been installed in the robot mower and must only be removed by a STIHL authorized dealer.

The battery is in a safe condition if the following points are observed:

- Battery is undamaged.
- The battery is clean and dry.
- Battery functions properly and has not been modified.

⚠ WARNING

- A battery that is not in a safe condition cannot operate safely. Persons may be seriously injured.
 - ▶ Never work with a damaged battery.
 - ▶ Never attempt to charge a damaged or defective battery.
 - ▶ If the battery is dirty: Clean the battery.
 - ▶ If the battery is moist or wet: Allow the battery to dry.
 - ▶ Never attempt to modify the battery.
 - ▶ Never insert objects in the battery's openings.
 - ▶ Never bridge the battery's contacts with metallic objects (short circuit).
 - ▶ Do not open the battery.
 - ▶ Replace worn or damaged labels.
- Fluid may leak from a damaged battery. If that liquid comes into contact with the skin or eyes, the skin or eyes may be irritated.
 - ▶ Avoid contact with the liquid.
 - ▶ If skin contact occurs: Wash affected areas of skin with plenty of water and soap.
 - ▶ In the event of contact with eyes: Rinse eyes with plenty of water for at least 15 minutes and consult a doctor.
- A damaged or defective battery may smell unusual, emit smoke or burn. Persons may be seriously or fatally injured, and property may be damaged.
 - ▶ If the battery smells unusual or emits smoke: do not use the battery and keep it away from combustible substances.
 - ▶ If the battery catches fire: Attempt to extinguish the battery with a fire extinguisher or water.

4.6.4 Docking station, charging cable, power supply and connecting cable

The docking station, charging cable, power supply, connecting cable and plug connections are

in a safe condition if the following conditions are met:

- The docking station, charging cable, power supply, connecting cable and plug connections are undamaged.
- The docking station, charging cable, power supply, connecting cable and plug connections are clean.
- Original STIHL accessories designed for this docking station are installed.
- The accessories are correctly installed.
- Docking station and power supply are not covered during operation.

⚠ WARNING

- If not in a safe condition, components may no longer operate safely and safety devices may be rendered ineffective. There is a risk of serious or fatal injury.
 - ▶ Use an undamaged docking station, charging cable, power supply, connecting cable and plug connections.
 - ▶ If the docking station, power supply or plug connections are dirty: Clean them.
 - ▶ Do not modify the docking station, charging cable, power supply, connecting cable and plug connections.
 - ▶ Do not insert objects into the openings of the docking station and power supply.
 - ▶ Do not bridge the electrical contacts of the docking station, power supply and plug connections with metallic objects (short circuit).
 - ▶ Do not open the docking station and power supply.
 - ▶ Do not cover the docking station and power supply.
 - ▶ Do not bury the power supply in the ground.
 - ▶ Do not sit on the docking station.
 - ▶ Do not stand on the base plate of the docking station.

4.7 Mowing operation

⚠ WARNING

- The blades on the rotating blade disk can cut the user. This may result in serious injury to the user.



- ▶ Do not touch rotating blade disk and blades.
- ▶ If the user approaches the robot mower during the mowing operation or before they want to make adjustments on the device: Press the STOP pushbutton.
- ▶ Do not tilt or lift the robot mower during the mowing operation.

- ▶ If the blade disk or blades are blocked by an object: Stop the robot mower and activate the device lock. Only then remove the object.



- ▶ Keep children away from the robot mower and mowing area.



- ▶ Keep animals away from the robot mower and mowing area.



- ▶ Do not climb or sit on the robot mower. Do not transport children, animals or objects on the robot mower.

- If the behavior of the robot mower changes during operation or feels unusual, it may no longer be in a safe condition. This may result in serious injury to people and damage to property.
 - ▶ Press the STOP pushbutton and activate the device lock. Contact a STIHL authorized dealer.
- If the blades hit a foreign object during the mowing operation, the blades or parts of them can be damaged or ejected at high speed. This may result in injury to people and damage to property.
 - ▶ Remove foreign objects from the mowing area.
 - ▶ Remove broken off blades or parts of blades from the mowing area.
- When the STOP pushbutton is pressed, the blade disk with the blades will continue to rotate for a short time. People may be seriously injured.
 - ▶ Wait until the blade disk is no longer rotating.
- If the blades hit a hard object during the mowing operation, sparks can be produced and the blades can be damaged. Sparks can cause fires in a flammable environment. Persons may be seriously or fatally injured, and property may be damaged.
 - ▶ Do not use in a flammable environment.
 - ▶ Make sure that the blades are in a safe condition.

▲ DANGER

- If the robot mower is operating near live electric cables, the blades can come in contact with the cables and damage them. There is a risk of serious or fatal injury.
 - ▶ Do not operate the robot mower in the vicinity of live cables.

4.8 Charging

▲ WARNING

- A damaged or defective power supply may produce an unusual smell or emit smoke during the charging process. This may result in injury to people and damage to property.
 - ▶ Disconnect the mains plug from the wall socket.
- The power supply can overheat and cause a fire if heat dissipation is inadequate. Persons may be seriously or fatally injured, and property may be damaged.
 - ▶ Do not cover the power supply.

4.9 Connecting to the power supply

Contact with live components may occur for the following reasons:

- The connecting cable or the extension cord is damaged.
- The mains plug of the connecting cable or extension cord is damaged.
- The socket is not properly installed.

▲ DANGER

- Contact with live parts may result in electric shock. This may result in serious or fatal injury to the user.
 - ▶ Check that the wires and their mains plugs are undamaged.



If the connecting cable or the extension cord is damaged:

- ▶ Do not touch the damaged area.
- ▶ Disconnect the mains plug from the wall socket.
- ▶ Be sure your hands are dry before touching the wires and their mains plugs.
- ▶ Insert mains plugs only in a properly installed and fused wall socket.
- ▶ If the wall socket is outside of a building: Make sure that the socket is approved for outdoor use.
- ▶ Install the power supply with a fault current circuit breaker (30 mA, 30 ms).
- ▶ If the connecting cable or extension cable is connected or disconnected, always grip the plug and do not pull on the cable.
- A damaged or unsuitable extension cable can result in electric shock. There is a risk of serious or fatal injury.
 - ▶ Use an extension cable with the correct cable cross-section,  23.5.
 - ▶ Use a splash water protected extension cable approved for outdoor use.
 - ▶ Protect plug connection between the power supply and extension cable against water.

- ▶ Use an extension cable with the same specifications as the power supply's connecting cable.

⚠ WARNING

- An incorrect line voltage or mains frequency can result in an overvoltage in the power supply. The power supply may be damaged.
 - ▶ Make sure the line voltage and mains frequency match the data on the power supply's rating label.
- If the power supply is connected to a power strip, electrical components may be overloaded during the charging process. The electrical components may overheat and cause a fire. Persons may be seriously or fatally injured, and property may be damaged.
 - ▶ Ensure that the technical specifications for the power strip are not exceeded by the information on the rating plate of the power supply and of all electrical devices connected to the power strip.
- An improperly routed connecting cable, extension cable or charging cable can be damaged and cause people to trip over them. This may result in serious injury to people and damage to property.
 - ▶ Route the wires and charging cable so that they are outside of the mowing area.
 - ▶ Route and mark the wires and charging cable so that they will not be damaged by work with a gardening device or tool.
 - ▶ Route and mark the wires and charging cable in such a way that people cannot trip over them.
 - ▶ Route the wires and charging cable in such a way that they are not under tension or tangled.
 - ▶ Route the wires and charging cable in such a way that they will not be damaged, bent, crushed or will not chafe.
 - ▶ Protect the wires and charging cable from heat, oil and chemicals.
 - ▶ Route the wires and charging cable so that they are not on a permanently wet surface.
- If electrical wiring and conduits are routed in the wall, they may be damaged if the power supply is mounted on the wall. Contact with wiring can result in electric shock. This may result in serious injury to people and damage to property.
 - ▶ Make sure there is no electrical wiring or conduits in the wall at the proposed mounting site.
 - ▶ Mount the power supply on a wall as described in this User Manual.

- If the power supply is connected to a generator, the electricity supply cannot be permanently ensured and the robot mower may not function properly. The power supply may be damaged by fluctuations in the electricity supply.
 - ▶ Only connect the power supply to a properly installed socket.

4.10 Transporting

4.10.1 Robot mower

⚠ WARNING

- The robot mower may tip over or move during transport. This may result in injury to people and damage to property.



- ▶ Stop the robot mower and activate the device lock.
- ▶ Secure the robot mower with lashing straps, belts or a net so that it cannot tip over or move.

4.10.2 Battery

The battery has been installed in the robot mower and must only be removed by a STIHL authorized dealer.

⚠ WARNING

- The battery is not protected against all environmental conditions. The battery may be damaged if it is exposed to certain ambient conditions, and damage to property may occur.
 - ▶ Never transport a damaged battery.
- The battery may turn over or shift during transport. Persons may be injured, or property may be damaged.
 - ▶ Pack the battery in packaging in such a way that it cannot move.
 - ▶ Secure the packaging so that it cannot move.

4.10.3 Docking station and power supply

⚠ WARNING

- The docking station or power supply may tip over or move during transport. This may result in injury to people and damage to property.
 - ▶ Disconnect the mains plug from the wall socket.
 - ▶ Remove the robot mower from the docking station.

- ▶ Secure the docking station and power supply with lashing straps, belts or a net to ensure that they cannot tip over or move.
- The connecting cable and charging cable are not intended to carry the weight of the power supply or docking station. The connecting cable, power supply, charging cable or docking station may be damaged.
 - ▶ Disconnect the charging cable from the power supply and docking station and coil it.
 - ▶ Grip the docking station by the base plate and hold it firmly.
 - ▶ Wind up the connecting cable and attach it to the power supply.
 - ▶ Grip the power supply by the housing and hold it firmly.

4.11 Storing

4.11.1 Robotic Mower

▲ WARNING

- Children are not aware of and cannot assess the dangers of the robot mower. Children may be seriously injured.



- ▶ Stop the robot mower and activate the device lock.

- ▶ Store the robot mower out of the reach of children.
- Moisture may cause the electrical contacts on the robot mower and metal components to corrode. The robot mower may be damaged.
 - ▶ Store the robot mower in a clean and dry condition.
- The robot mower may start unintentionally and begin to move if its device lock is not activated before storage. This may result in serious injury to people and damage to property.



- ▶ Stop the robotic mower and activate the device lock.

- The hood and handles are not intended to be used to hang up the robotic mower. Safety devices may be rendered inoperative, and the robot mower may be damaged.
 - ▶ Store the robotic mower as described in this User Manual.

4.11.2 Battery

The battery has been installed in the robot mower and must only be removed by a STIHL authorized dealer.

▲ WARNING

- Children are not aware of and cannot assess the dangers of the battery. Children may be seriously injured.
 - ▶ Store the battery out of the reach of children.
- The battery is not protected against all ambient conditions. If the battery is exposed to certain ambient conditions, the battery may be irreparably damaged.
 - ▶ Store the battery in a clean and dry condition.
 - ▶ Store the battery in an enclosed space.
 - ▶ Do not store the battery outside of the specified temperature limits,  23.6.

4.11.3 Docking station and power supply

▲ WARNING

- Children are not aware of and cannot assess the dangers of a docking station or power supply. Children can be seriously injured or killed.
 - ▶ Remove the robot mower from the docking station.
 - ▶ Store the docking station and power supply out of the reach of children.
- The docking station and the power supply are not protected against all environmental conditions. If the docking station and power supply are exposed to certain environmental conditions, they may be damaged.
 - ▶ Remove the robot mower from the docking station.
 - ▶ If the power supply is hot: Allow the power supply to cool down.
 - ▶ Store the docking station and power supply in a clean and dry condition.
 - ▶ Store the docking station and power supply in an enclosed space.
 - ▶ Do not store the power supply outside of the specified temperature limits,  23.6.
- The connecting cable and charging cable are not intended to carry the weight of the power supply or docking station. The connecting cable, power supply, charging cable or docking station may be damaged.
 - ▶ Disconnect the charging cable from the power supply and docking station and coil it.
 - ▶ Grip the docking station by the base plate and hold it firmly.
 - ▶ Wind up the connecting cable and attach it to the power supply.
 - ▶ Grip the power supply by the housing and hold it firmly.

4.12 Cleaning, maintenance and repair

▲ WARNING

- The robot mower may start unintentionally if the device lock is not activated during cleaning, maintenance or repair operations. This may result in serious injury to people and damage to property.



- ▶ Stop the robot mower and activate the device lock.

- Harsh detergents or cleaning with a high pressure washer or sharp metallic objects can damage the robot mower. If the robot mower is not cleaned correctly, components may no longer function properly or safety devices may be rendered inoperative. People may be seriously injured.
 - ▶ Clean the robot mower as described in this User Manual.
- Harsh detergents or cleaning with a high pressure washer or sharp metallic objects can damage the docking station, power supply, connecting cable, charging cable and plug connections. If the docking station, power supply, connecting cable, charging cable or their plug connections are not cleaned correctly, components may no longer function properly or safety devices may be rendered inoperative. People may be seriously injured.
 - ▶ Disconnect the power supply's mains plug from the wall socket.
 - ▶ Clean the docking station, power supply, connecting cable, charging cable and their plug connections as described in this User Manual.
- If the robot mower, docking station or power supply are not serviced or repaired correctly, components may no longer function properly or safety devices may be rendered inoperative. There is a risk of serious or fatal injury.
 - ▶ Do not service or repair the robot mower, docking station and power supply yourself.
 - ▶ If the robot mower, docking station or power supply require servicing or repairs: Contact a STIHL authorized dealer.
 - ▶ Maintain the blades as described in this User Manual.
- The user can be cut by the sharp cutting edges of the blades while cleaning or servicing the mowing unit. This may result in injury to the user.
 - ▶ Wear work gloves made of robust material.

- If the power supply's connecting cable is faulty or damaged:
 - ▶ Replace power supply.
- If the plug of the diagnostic socket on the bottom of the robot mower does not fit correctly, moisture and dirt can penetrate the robot mower. The robot mower may be damaged.
 - ▶ Check the fit of the plug during each cleaning and blade change.
 - ▶ Do not operate the robot mower with a missing or damaged plug.

5 Description of Operation

5.1 Functional Description

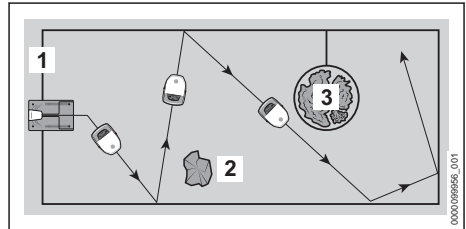

The robot mower mows the grass in randomly selected paths. It is necessary to route a perimeter wire (1) so the robot mower can identify the boundaries of the mowing area.

The perimeter wire (1) transmits a signal to the robot mower. The signal is generated by the docking station.

The robot mower identifies fixed obstacles (2) in the mowing area using ultrasound sensors and a bump sensor.

If the robot mower identifies a fixed obstacle (2), it will slow down, bump into the fixed obstacle and then continue to move in a different direction.

Areas (3) the robot mower must not navigate and obstacles it must not come into contact with must be blocked off from the remaining mowing area with the help of the perimeter wire (1).

If the robot mower identifies a blocked-off area (3), it will slow down and then continue to move in a different direction.

In mowing operation, the robotic mower leaves the docking station by itself and mows the lawn.

The robotic mower is operated by the MY iMOW® app and the buttons in the control panel on the robotic mower. Light strips on the robotic mower as well as an artificially generated

voice output provide information about the current status of the robotic mower.

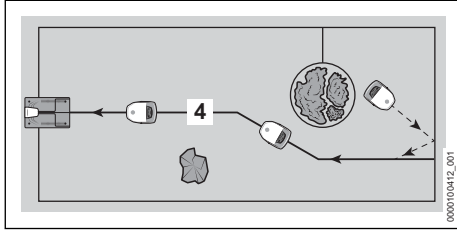

If the battery's state of charge is low, the robotic mower will search for the nearest guide wire (4) during the mowing operation. If a guide wire (4) is recognized, the robotic mower will return to the docking station by itself. The docking station recharges the battery. At least one guide wire (4) must be installed in the mowing area. A maximum of two guide wires can be installed. If the mowing operation is canceled or the battery must be charged, the robotic mower can be sent directly back to the docking station using the MY iMOW® app or HOME pushbutton.

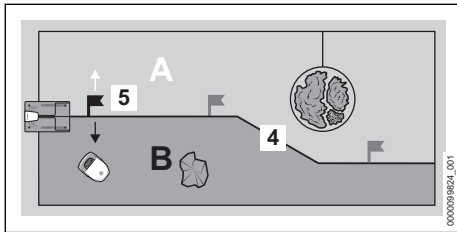

Up to three starting points (5) can be specified on a guide wire (4). The robotic mower can move specifically to the respective starting point and start mowing from there.

The mowing area can be divided into several zones (example: A and B) by the guide wire (4). The zones are defined by a starting point (5). The robotic mower can be directed from the selected starting point to the left or right into the desired zone. The robotic mower can then mow specifically in the selected zone. The starting points and zones are managed in the MY iMOW® app and can be taking into account in the mowing plan.

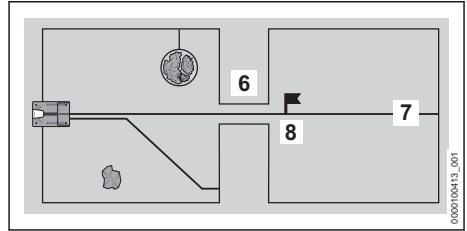

If there is a confined section (6) in the mowing area, the robotic mower navigates the confined area, provided that a particular minimum width is maintained between the perimeter wires. If the minimum distance cannot be maintained, a guide wire (7) must be routed through the confined section (6). The guide wire (7) then guides the robotic mower directly through the confined section (6) to a starting point (8). From the starting point (8), the robotic mower can mow the mowing area behind the confined section (6). The frequency at which the robotic mower returns to the starting point (8) can be managed by the MY iMOW® app and taken into account in the mowing plan.

6 Preparing the Mowing Area and Robot Mower for Operation

6.1 Planning and preparing mowing areas

Plan and prepare the mowing area prior to commissioning the robot mower. This enables a robust installation and smooth operation and eliminates potential sources of faults.

Planning mowing surfaces

- ▶ Familiarize yourself with the descriptions about the docking station and wire routing in the following sections.
- ▶ Transfer the information to your own garden:
 - Outline of the mowing area
 - Position of the docking station
 - Routing of the perimeter wire (note described distances to the edges and wire routing cases)
 - Routing of the guide wire(s) (at least one, maximum of two)

Preparing mowing areas

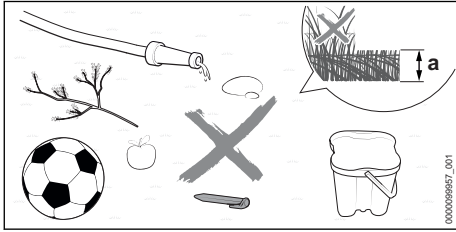

- ▶ Remove any objects lying around.
- ▶ Remove metals, magnetic materials and materials that conduct electricity as well as old perimeter wires.
- ▶ Mow lawns with a lawn mower to the cutting height that will later be set for the operation of the robot mower. The default setting for the cutting height on the robot mower is $a = 6$ cm.
- ▶ Level out holes and rough, uneven patches.
- ▶ Where ground is hard and dry, slightly moisten the mowing area to make driving the anchoring stakes easier.

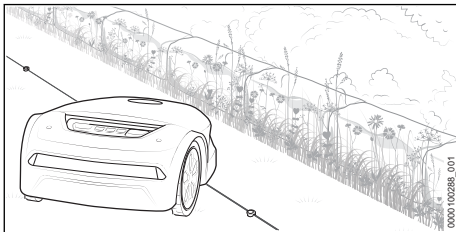

- ▶ As a result of its design, the robot mower leaves a strip with unmown lawn along unnavi-gable areas. This strip can be used, for example, to sow flower seeds and create areas with blossoming vegetation for insects.

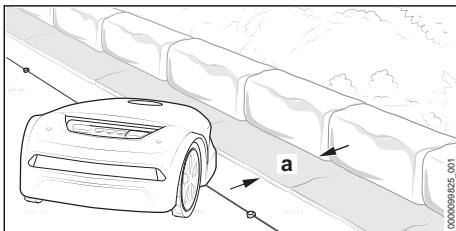

- ▶ If you want to mow without leaving an edge along inaccessible areas: Install edging stones or flagstones with a minimum width of $a = 24$ cm along these areas.

6.2 Preparing the robot mower for operation

- ▶ Remove the packaging material and transport locks.
- ▶ Ensure that the following components are in a safe condition:
 - Robot mower, [📖 4.6.1](#)
 - Blades, [📖 4.6.2](#)
 - Battery, [📖 4.6.3](#)
 - Docking station and power supply, [📖 4.6.4](#)
- ▶ Positioning the docking station, [📖 7](#)
- ▶ Installing the perimeter wire, [📖 8](#)
- ▶ Completing the perimeter wire installation, [📖 9.1](#)
- ▶ Installing the guide wire, [📖 10.1](#)
- ▶ Electrically connecting the docking station, [📖 11.1](#)
- ▶ Charging the robot mower, [📖 12.1](#)
- ▶ Locking the Bluetooth® radio interface, [📖 13.1](#)
- ▶ If you cannot carry out these steps: Do not use the robot mower and contact a STIHL authorized dealer for assistance.

7 Positioning the docking station

7.1 General requirements

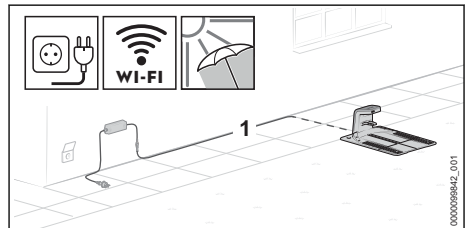

- ▶ Choose the docking station location so that the following conditions are met:
 - The charging cable (1) can be installed outside of the mowing area to connect to a suitable wall socket.
 - The docking station and power supply are positioned in a clearly visible area.
 - The docking station is in the mowing area that is the largest or most frequently mowed.
 - If possible, protect the location against adverse weather conditions and direct sunlight.
 - If possible, the docking station is within range of a wireless network (WLAN connection).
 - If possible, in a mowing area with a slope, the docking station is in the lower area of the slope.

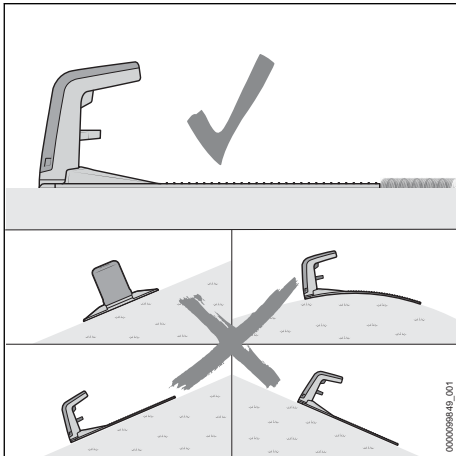

- ▶ Align the docking station so that the following conditions have been met:
 - The docking station has been positioned on a level surface.
 - The opening of the docking station is facing forward toward the mowing area.
 - The docking station has been aligned horizontally and is not tilted to the side, the front or the rear.
 - The base plate does not sag and lies flat on the ground.

7.2 Positioning the docking station

The correct position of the docking station depends on the planned location and its surroundings.

- ▶ Select the location and set up the docking station as described.

Positioning the docking station within the mowing area

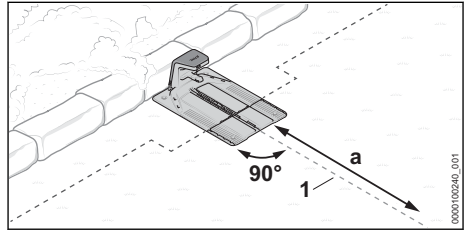

The docking station is at the edge of the mowing area by a wall and the guide wire (1) can be routed for $a = 2$ m in a straight line from the docking station to the mowing area.

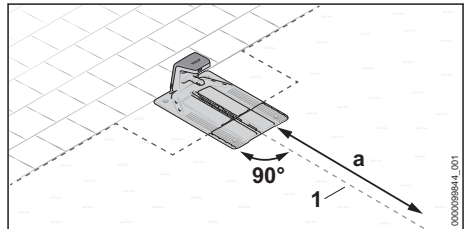

The docking station is at the edge of the mowing area. The adjacent area is navigable and the guide wire (1) can be routed for $a = 2$ m in a straight line from the docking station to the mowing area.

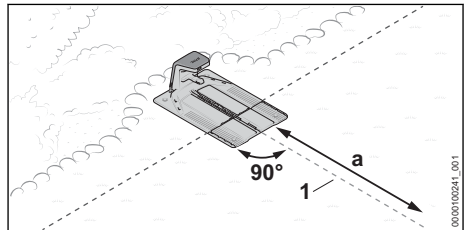

The docking station is partially in a bed and partially on the mowing area and the guide wire (1) can be routed for $a = 2$ m in a straight line from the docking station to the mowing area.

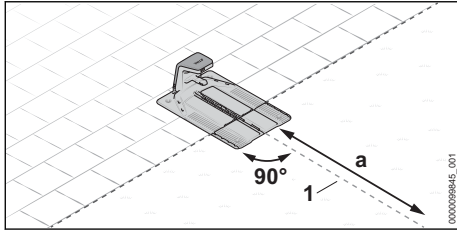

The docking station is partially in the mowing area and the guide wire (1) can be routed for $a = 2$ m in a straight line from the docking station to the mowing area.

- ▶ Prepare the docking station, [7.3](#).
- ▶ Setting up the docking station in a mowing area, [7.4](#).

Setting up the docking station outside the mowing area

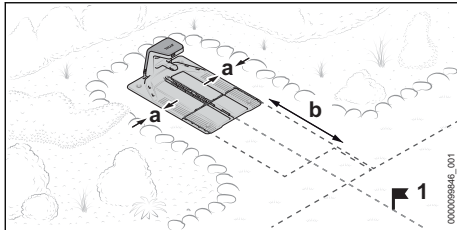

The docking station is outside the mowing area.

The minimum lateral distance toward adjacent areas must be at least $a = 15$ cm.

The minimum distance between the front edge of the docking station and the mowing area must be at least $b = 2$ m.

With this variant, it is mandatory to define a starting point (1) within the mowing area at the conclusion of commissioning. The robotic mower then starts mowing from this point and not directly from the docking station. Starting points can be set using the MY iMOW® app. The approach frequency of the starting point (1) must be set in the app at 100%.

- ▶ Prepare the docking station, [7.3](#).
- ▶ Setting up the docking station outside the mowing area, [7.5](#).

Setting up the docking station in the center of the mowing area

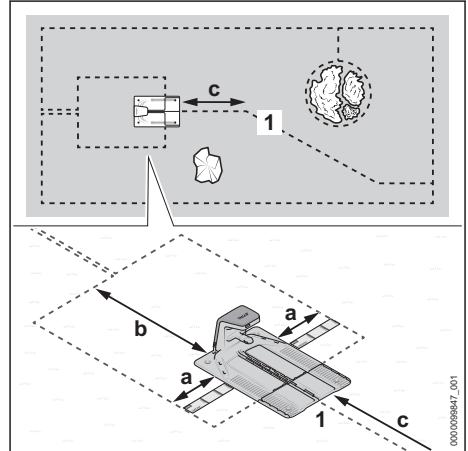

The docking station is positioned as an island in the center of the mowing area.

With this variant, the perimeter wire is routed around the docking station toward the rear and the edge of the mowing area. The guide wire is routed toward the front to the edge of the mowing area.

The minimum lateral distance to adjacent areas must be at least $a = 37$ cm (length: 1x iMOW® Ruler).

The minimum distance between the rear edge of the docking station and the edge of the mowing area must be $b = 2$ m.

It must be possible to route the guide wire (1) for $c = 2$ m in a straight line from the docking station to the mowing area.

- ▶ Prepare the docking station, [7.3](#).
- ▶ Set up the docking station in the center of the mowing area, [7.6](#).

7.3 Preparing the docking station

Connecting the charging cable.

NOTICE

- In assembled condition, the plug connections of the charging cable are protected against contamination, e.g. dust and dirt. Contamination of the plug connections may result in breakdowns of the docking station.
 - ▶ Protect open plug connections against contamination.
 - ▶ Clean the contaminated plug connections as described in this User Manual.

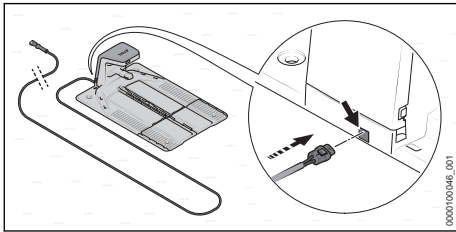

Normally the charging cable is connected from the rear.

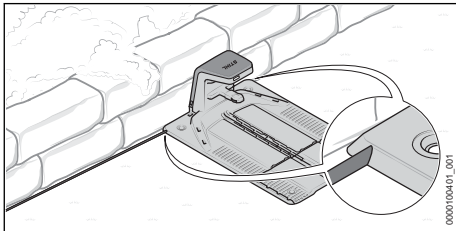

If the docking station has been positioned directly against a wall, it is also possible to install the charging cable under the base plate. The charging cable can be routed out of the base plate to the left or right.

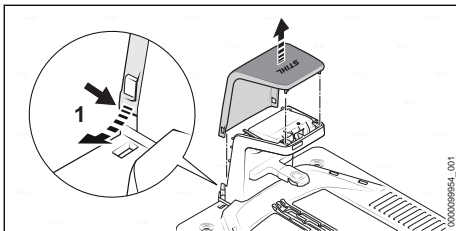

- ▶ Slightly bend the hood (1) toward the outside on both sides and remove it upward.

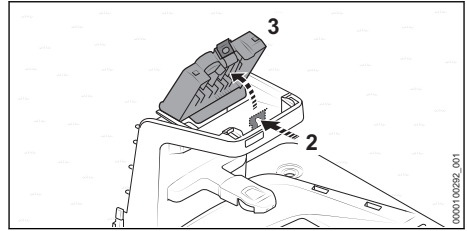

- ▶ Press the retaining latch (2) and open the cover (3).

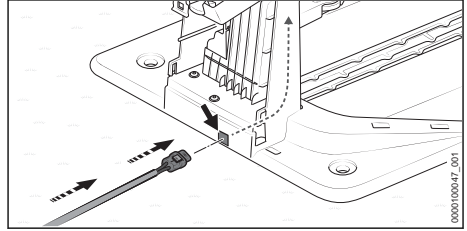

- ▶ If you intend to connect the docking station from the rear:
 - ▶ Insert the plug (4) into the conduit (5) and feed the charging cable (6) through. Push the charging cable (6) upward inside the docking station.

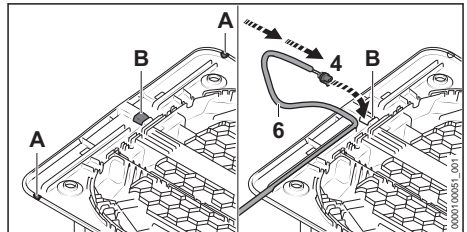

- ▶ If the docking station has been positioned directly against a wall or you want to route the charging cable underneath the base plate toward the side:
 - ▶ Open the edge and deburr it on the desired side of the base plate at position (A).
 - ▶ Cut out and deburr an opening in the center of the base plate (B).
 - ▶ Insert the plug (4) into the opening (B) and feed the charging cable (6) through. Push the charging cable (6) upward inside the docking station.

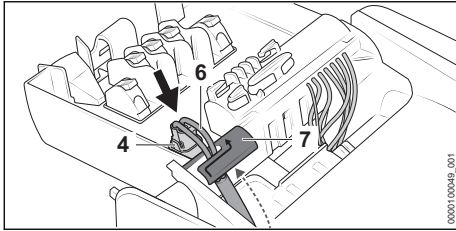

- ▶ Secure the charging cable (6) in the cable holder (7).
- ▶ Insert the plug (4).
- The plug (4) audibly and noticeably engages on both sides.

Securing the docking station

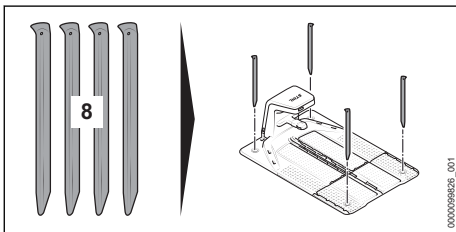

- ▶ Secure the docking station on the ground with four ground pegs (8).

Feeding the perimeter wire

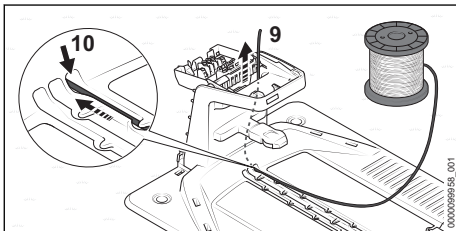

- ▶ Insert the beginning of the wire (9) into the right conduit (10) and feed it through. Push the perimeter wire (9) upward inside the docking station.

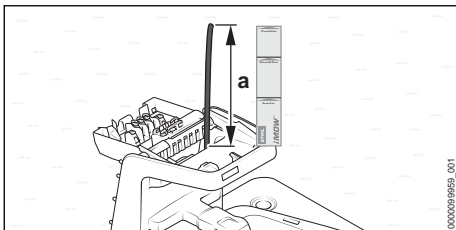

- ▶ Feed the perimeter wire through until it protrudes upward for a = 37 cm (length: 1x iMOW® Ruler).

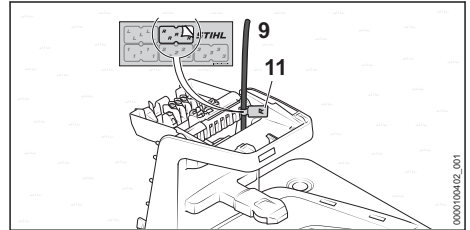

- ▶ Using the appropriate cable marker (11), mark the beginning of the wire (9) near the housing. Marking will facilitate the subsequent connection to the correct terminal.

7.4 Positioning the docking station within the mowing area

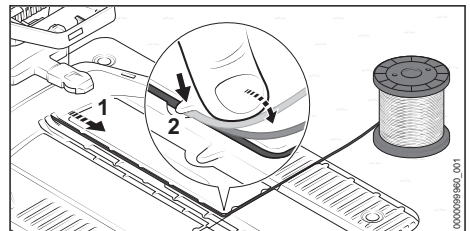

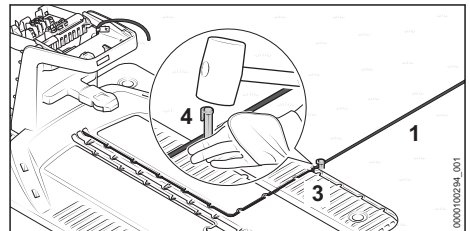

- ▶ Install the perimeter wire (1) in the base plate so that the guide wire lies flat in the cable duct and is secured by the hook (2).

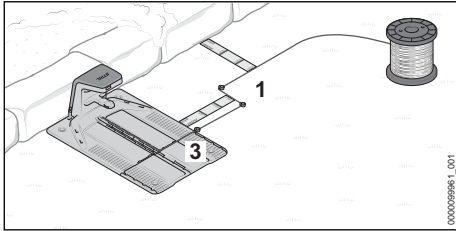

- ▶ Attach the perimeter wire (1) directly on the base plate (3) with a fixing pin (4).

If the docking station is against a wall:



- ▶ Route the perimeter wire (1) 37 cm (length: 1x iMOW® Ruler) away from the base plate (3) toward the side.
- ▶ Route the perimeter wire (1) in parallel to the base plate (3) toward the edge of the mowing area and maintain a distance from the wall of 37 cm (length: 1x iMOW® Ruler).
- ▶ Route the perimeter wire (1) clockwise around the mowing area,  8.

If the docking station is in an adjacent, navigable area:

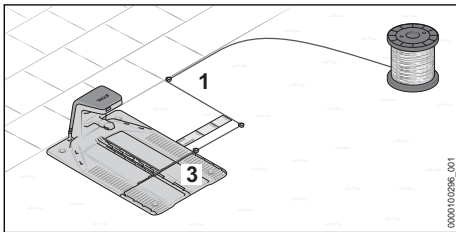

- ▶ Route the perimeter wire (1) 37 cm (length: 1x iMOW® Ruler) away from the base plate (3) toward the side.
- ▶ Route the perimeter wire (1) in parallel to the base plate (3) toward the edge of the mowing area.
- ▶ Route the perimeter wire (1) clockwise around the mowing area,  8.

If the docking station is partly positioned in a bed and partly in the mowing area:

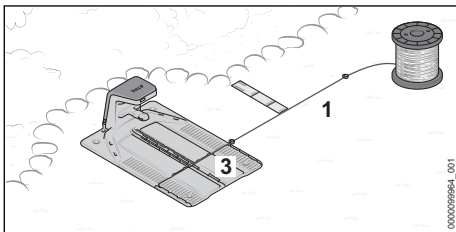

- ▶ Route the perimeter wire (1) away from the base plate (3) toward the side and maintain a distance of 37 cm (length: 1x iMOW® Ruler) in parallel to the bed.

- ▶ Route the perimeter wire (1) clockwise around the mowing area,  8.

If the docking station has been positioned partly in a navigable area and partly in the mowing area:

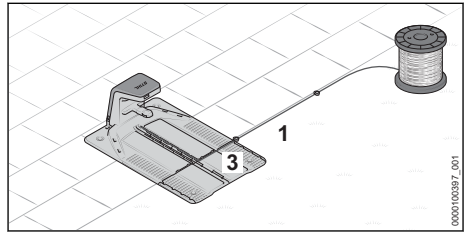

- ▶ Route the perimeter wire (1) away from the base plate (3) toward the side and along the navigable area.
- ▶ Route the perimeter wire (1) clockwise around the mowing area,  8.

7.5 Setting up the docking station outside the mowing area

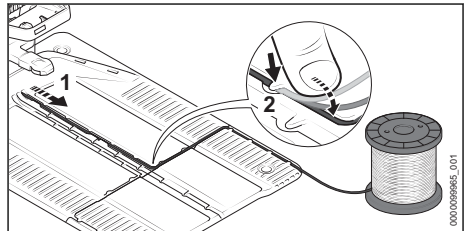

- ▶ Install the perimeter wire (1) in the base plate so that the guide wire lies flat in the cable duct and is secured by the hook (2).

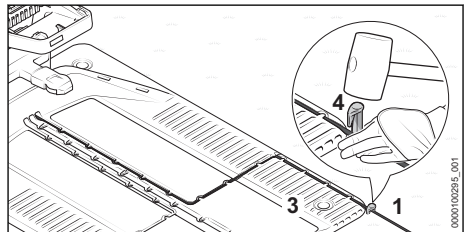

- ▶ Attach the perimeter wire (1) directly on the base plate (3) with a fixing pin (4).

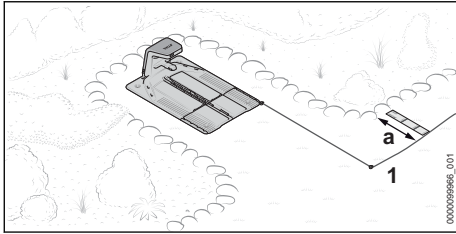

- ▶ Route the perimeter wire (1) toward the front to the mowing area.
The correct distance to the edge of the mowing area depends on whether the edge of the mowing area is navigable, or a distance of $a = 37$ cm (length: 1x iMOW® Ruler) needs to be maintained.
- ▶ Route the perimeter wire (1) clockwise around the mowing area,  8.

7.6 Setting up the docking station in the center of the mowing area

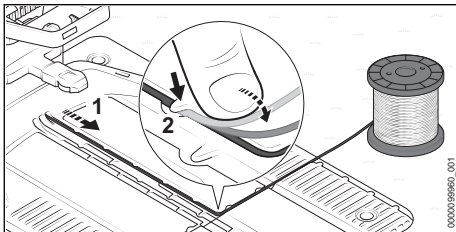

- ▶ Install the perimeter wire (1) in the base plate so that the guide wire lies flat in the cable duct and is secured by the hook (2).

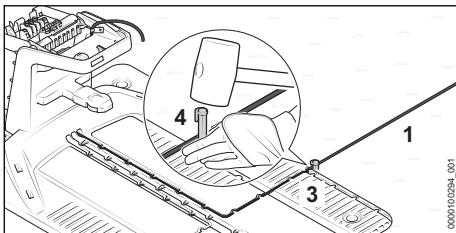

- ▶ Attach the perimeter wire (1) directly on the base plate (3) with a fixing pin (4).

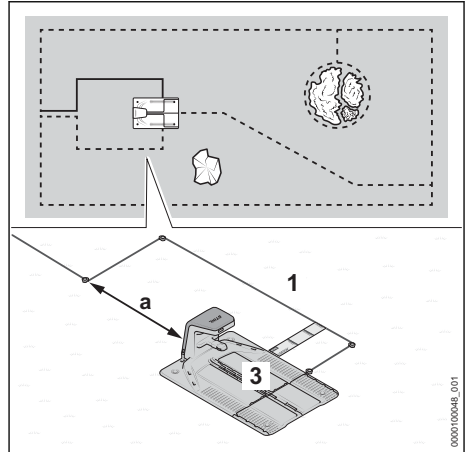

- ▶ Route the perimeter wire (1) at least 37 cm (length: 1x iMOW® Ruler) away from the base plate (3) toward the side.
- ▶ Route the perimeter wire (1) at least $a = 2$ m behind the base plate (3).
- ▶ Route the perimeter wire (1) in the center behind the docking station toward the edge of the mowing area.
Maintain the correct distance to the edge of the mowing area depending on the adjacent area.
- ▶ Route the perimeter wire (1) clockwise around the mowing area,  8.

8 Installing the Perimeter Wire

8.1 General requirements

Checking routing of perimeter wire and guide wire in the mowing area

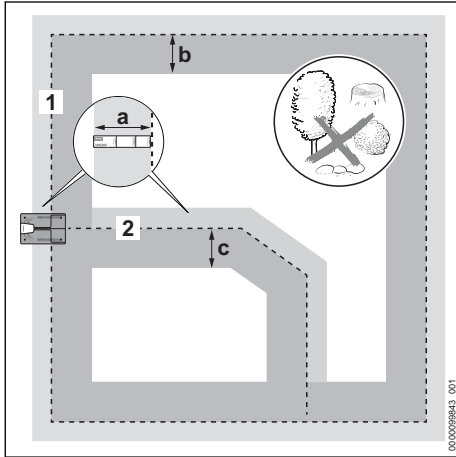

- ▶ Make sure that the mowing area along the perimeter wire and the guide wire is flat and clear of obstacles as far as possible along the following widths:

Perimeter wire (1)

- Toward the outside: $a = 37$ cm (length: 1x iMOW® Ruler)
- Toward the inside: $b = 1.2$ m

Guide wire (2)

- Toward the right in the direction of travel toward the docking station: $a = 37$ cm (length: 1x iMOW® Ruler)
- Toward the left in the direction of travel toward the docking station: $c = 1.2$ m

Installing the Perimeter Wire

- ▶ Install the perimeter wire clockwise starting at the docking station.
- ▶ Do not kink, cut, put tension on or cross the perimeter wire.
- ▶ Make sure that the perimeter wire does not cross over a guide wire.
 - ▶ Exception: When installing a corridor, the guide wire must cross the perimeter wire.
- ▶ Keep a minimum distance of 1 m to perimeter wires of adjacent robot mower installations.
- ▶ Make sure that the length of the perimeter wire does not exceed 850 m.
- ▶ Do not route the perimeter wire and guide wire at different depths in the soil.

Attaching perimeter wire and guide wire

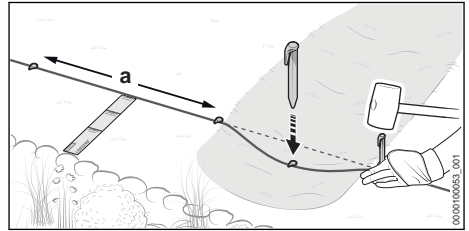

- ▶ Use anchoring stakes to secure the perimeter wire and guide wire so that the following conditions are met:
 - The maximum distance between fixing pins must not exceed $a = 1$ m.
 - The perimeter wire and guide wire lie flat on the ground in all areas.
 - The anchoring stakes are sunk completely into the ground.

Installing Wire Reserves

Wire reserves make it easier to correct installed wire and give some leeway for future adaptations.

Examples:

- A bed is extended and blocked off.
- Bushes and shrubbery grow and the perimeter wire must be installed around the plants in a larger arc.
- The perimeter wire was cut too short at the docking station and cannot be connected.

One or several wire reserves can be planned and installed.

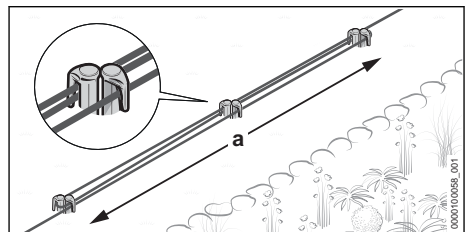

- ▶ Route $a = 1$ m of perimeter wire in parallel and closely together around 2 fixing pins without the perimeter wires crossing over each other.
- ▶ Secure the wire reserve at the center using two additional fixing pins.

8.2 Planning guide wire and routing connection point in the perimeter wire

Carefully plan the routing of one or several guide wires in advance. Take into account the position of all guide wires when installing the perimeter wire. At least one guide wire must be installed; two guide wires may be installed.

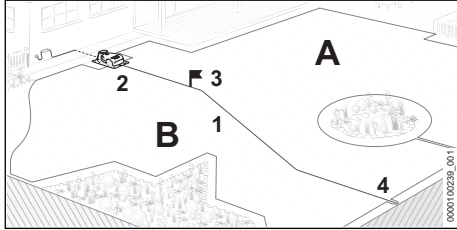

A guide wire (1) fulfills the following functions:

- Orientation for returning to the docking station (2)
- Moving toward a starting point (3)
- Splits the mowing area into zones (A and B)

Starting at the docking station (2), install the guide wire (1) across the mowing area and connect it to a point on the circumferential perimeter wire (4) that is as far away as possible.

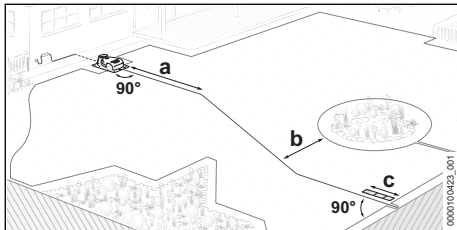

► Plan the guide wire so that the following conditions are met:

- Route the guide wire for a length of $a = 2$ m in a straight line from the docking station to the mowing area.
- The minimum distance between the guide wire and the circumferential perimeter wire is $b = 27.5$ cm
- Route the guide wire with a minimum distance $c = 37$ cm (length: 1x iMOW® Ruler) in a straight line and at a right angle to the perimeter wire and connect it.

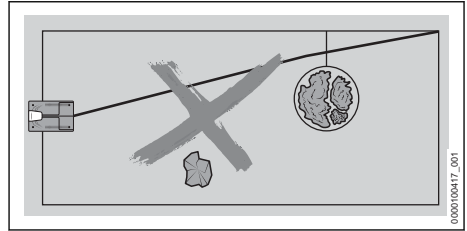

- The guide wire must not cross over a blocked-off area connection.
- The guide wire must not be connected to the perimeter wire in a corner.
- The guide wire must not cross over a perimeter wire.
Exception: When installing a corridor, the guide wire must cross the perimeter wire.
- The guide wire must not be kinked or under tension, and it must not cross over itself.

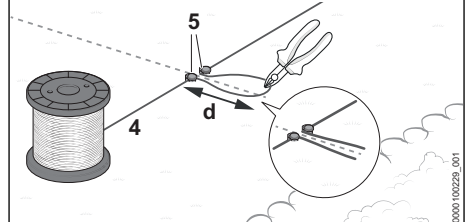
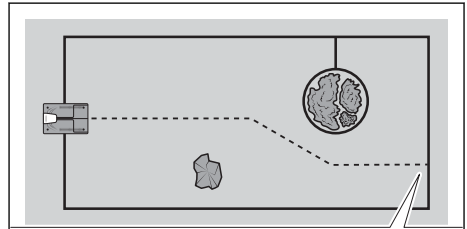

The connection point for the guide wire must be installed during the installation of the circumferential perimeter wire (4).

- Secure the perimeter wire (4) at the intended areas using a fixing pin (5).
- Place the perimeter wire (4) in a loop with a length of $a = 15$ cm and secure with another fixing pin (5).
- Cut the perimeter wire (4) at the end of the wire loop with a wire cutter.
The wire ends are connected to the guide wire at the completion of the installation.  10.1
- Continue to install the perimeter wire (4) around the mowing area.

8.3 Corners

Corners with a 90° angle

Corners with a 90° angle can be split into two corners with a 45° angle. Consequently, the robot mower changes its direction more smoothly and with less jerking in this area.

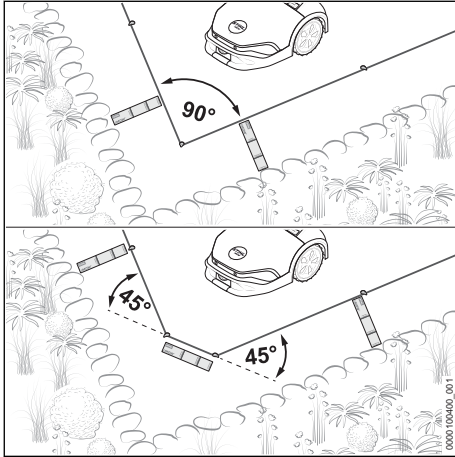

- ▶ Route the perimeter wire in corners for at least 37 cm (length: 1x iMOW® Ruler) across the area.

Tapered corners with an angle < 90°

Divide tapered corners with an angle < 90° into two corners. As a result, the robot mower changes its direction more smoothly and with less jerking in this area.

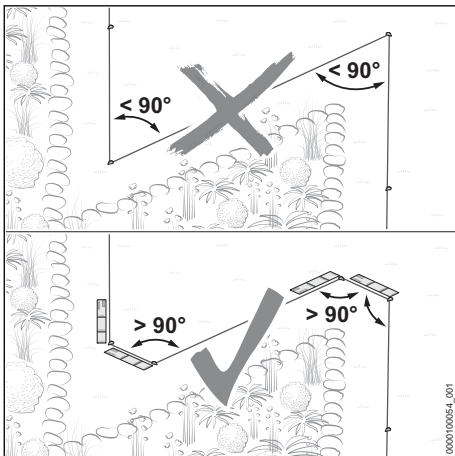

- ▶ Make sure that tapered corners are not at an angle less than 90°.

- ▶ If the angle is less than 90°: Split the angle.
 - ▶ Design one corner with an angle greater than 90°. Then route the perimeter wire in a straight line for at least 37 cm (length: 1x iMOW® Ruler).
 - ▶ Then design a corner with an angle greater than 90°. Subsequently route the perimeter wire in a straight line for at least 37 cm (length: 1x iMOW® Ruler).

8.4 Navigable area

The robot mower is able to navigate areas directly adjacent to the mowing area if the difference in height between the navigable area and the mowing area is no more than 1.5 cm. The ground must be solid and there must not be any obstacles.

Examples:

- Patio
- Paved path
- Edging stones or flagstones

Edgeless mowing is enabled by maintaining a short distance between the perimeter wire and the navigable area.

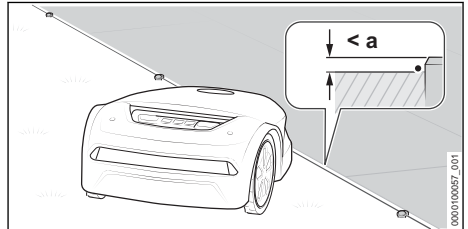

- ▶ Route the perimeter wire parallel to and without any distance from the navigable area. The maximum difference in height between the navigable area and the mowing area is $a = 1.5$ cm

8.5 Unnavigable area

An area is unnavigable if obstacles close to the ground protrude into the mowing area, the ground is not solid or is very uneven and if the difference in height between the mowing area and the adjacent area is more than 1.5 cm.

Examples:

- Wall or fence
- Hedge or shrubbery with branches that grow close to the ground
- Stone garden or gravel path
- Heavily rooted or uneven ground

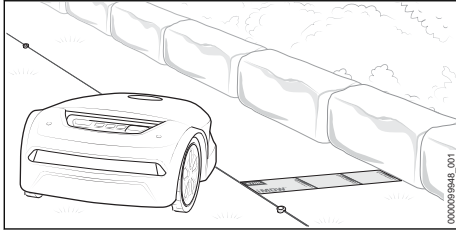

- ▶ Route 37 cm (length: 1x iMOW® Ruler) of perimeter wire parallel to the un-navigable area.
- ▶ If the un-navigable area is within the mowing area: Block off the un-navigable area with a restricted area.

8.6 Water areas

An increased wire distance must be maintained to water areas if the water area has not been blocked off from the mowing area by a fixed obstacle with a minimum height of 10 cm.

Examples:

- Garden pond
- Pool
- Stream or watercourse

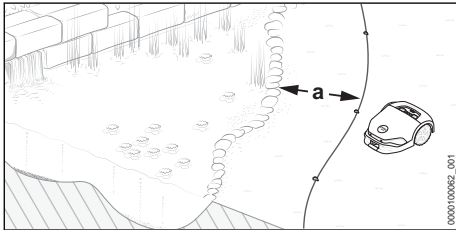

- ▶ Route the perimeter wire at a distance of $a = 1$ m in parallel to the bank area.
- ▶ If the water area is within the mowing area: Block off the water area with a restricted area.

8.7 Drop-off edge

Keep an increased wire distance to drop-off edges if the drop-off edge has not been blocked from the mowing area by a fixed obstacle with a minimum height of 10 cm.

Examples:

- Stairs
- Retaining wall
- Tiered slope

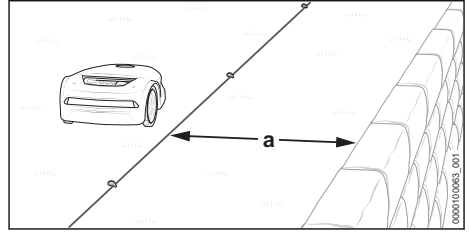

- ▶ Route the perimeter wire at a distance of $a = 1$ m parallel to the drop-off edge.

8.8 Restricted area

Areas within the mowing area that must not or cannot be navigated by the robot mower must be blocked by a restricted area.

Examples:

- Bed without a fixed border with a minimum height of 10 cm
- Garden pond or pool without a fixed border with a minimum height of 10 cm
- Obstacles that the device must not come into contact with:
- Obstacles that are not strong enough
- Obstacles below a height of 10 cm

To ensure a robust mowing operation, restricted areas must not have any inwardly curved shapes.

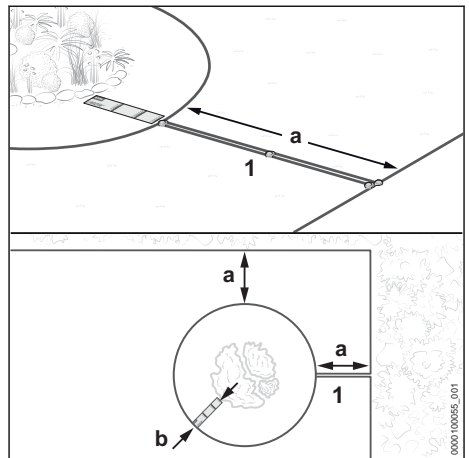

- ▶ Route the perimeter wire (1) away from the edge toward the restricted area. Make sure that the following dimensions are maintained for the restricted area:
 - Minimum distance to other perimeter wires $a = 55$ cm
 - Wire distance $b = 37$ cm (length: 1x iMOW® Ruler) (for water areas and drop-off edges, $b = 1$ m)
 - Minimum diameter of the restricted area: 74 cm

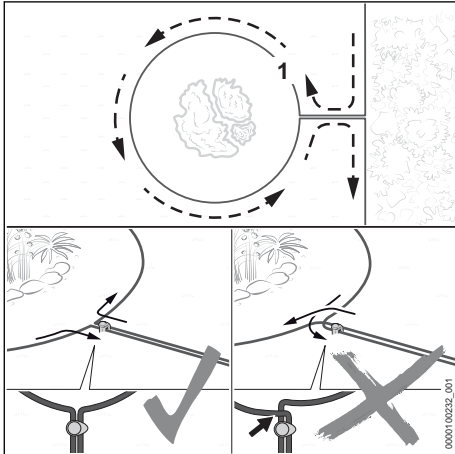

- ▶ Route the perimeter wire (1) around the area to be blocked off.
- ▶ Route the perimeter wire (1) parallel and close together back to the edge without the perimeter wires crossing each other.

8.9 Fixed obstacle

A fixed obstacle within the mowing area does not have to be blocked off by a restricted area if the obstacle is at least 10 cm high. The obstacle is identified by the ultrasound sensors and the bump sensor.

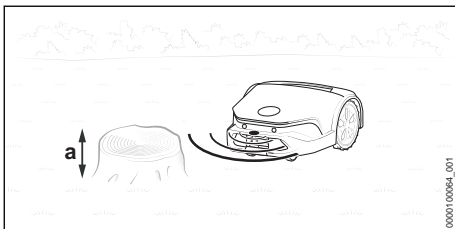

- ▶ A fixed obstacle with a minimum height of $a = 10$ cm does not need to be blocked off.

8.10 Confined section

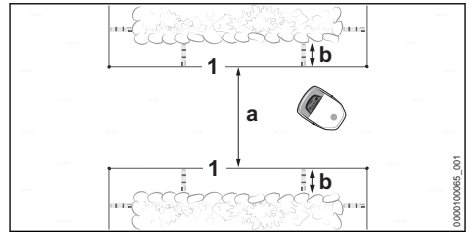

The robot mower navigates all confined areas, provided that a minimum width (a) is maintained between the perimeter wires (1).

- ▶ Route the perimeter wire (1) as illustrated and make sure that the following dimensions have been maintained:
 - Minimum distance between the perimeter wires (1) in the confined section: $a = 2$ m
 - If the confined section is restricted by side obstacles: Include an additional distance of $b = 37$ cm (length: 1x iMOW® Ruler)
- ▶ If the minimum distance $a = 2$ m between the perimeter wires (1) cannot be maintained: Route a guide wire through the middle of the confined section.

Confined section with guide wire

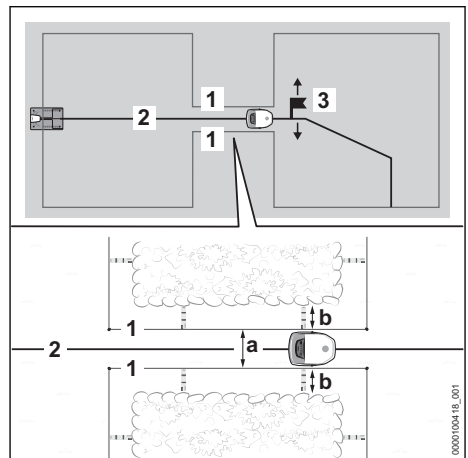

A guide wire (2) directs the robot mower through the confined area, provided that a minimum width (a) is maintained between the perimeter wires (1).

On completing commissioning, it is mandatory to place a starting point (3) behind the confined section and the starting point's approach frequency. Otherwise, the robotic mower will not

find its way through the confined section. Starting points can be set using the MY iMOW® app.

- ▶ Route the perimeter wire (1) as illustrated and make sure that the following dimensions have been maintained:
 - Minimum distance between the perimeter wires (1) in the confined section: $a = 55$ cm
 - If the confined section is restricted by side obstacles: Include an additional distance of $b = 37$ cm (length: 1x iMOW® Ruler)
- ▶ Route the guide wire (2) in the middle of the confined section.
- ▶ If the side distance $b = 37$ cm (length: 1x iMOW® Ruler) is not possible: Install a corridor to be able to guide the robot mower to another mowing area  8.11 or block off the confined section from the mowing area.

8.11 Corridor

Functional Description

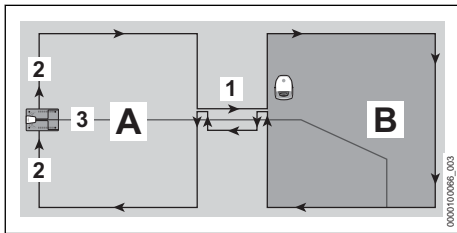

Use a corridor (1) to overcome confined sections in a precise way or to define passageways. The corridor divides the mowing area into a main mowing area (A) and another mowing area (B).

The perimeter wire (2) is routed without interruptions. It forms a corridor at the transition from the main mowing area (A) to the other mowing area (B).

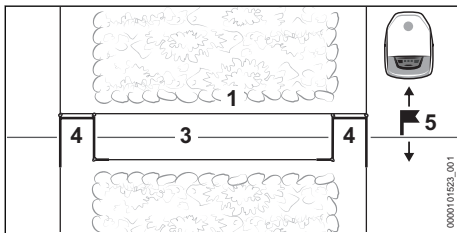

Wire loops (4) indicate to the robotic motor when a corridor starts or ends.

A guide wire (3) must be installed in the middle of the corridor.

A corridor must be followed by a starting point (5) within the mowing area (B). Otherwise, the robotic mower will not find its way from the main mowing area (A) through the corridor to the other mowing area (B). Starting points and their approach frequency can be set using the MY iMOW® app.

There is no mowing within a corridor.

General requirements

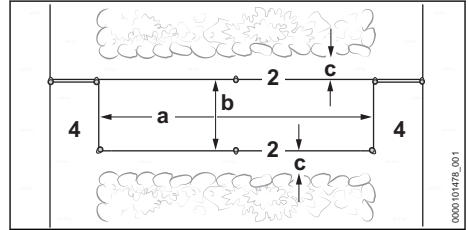

- ▶ Make sure that the following conditions are fulfilled:
 - The minimum distance between the wire loops (4) must be at least $a = 74$ cm.
 - The distance between the perimeter wires (2) must be at least $b = 55$ cm.
 - The distance to side obstacles must be at least $c = 15$ cm.

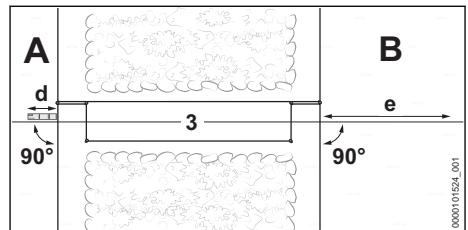

- ▶ Make sure that the following conditions are fulfilled:
 - The guide wire (3) can be routed before the corridor for a length of at least $d = 37$ cm (length: 1x iMOW® ruler) in a straight line and at a right angle (90°) to the corridor.
 - The guide wire (3) can be routed after the corridor for a length of at least $e = 2$ m in a straight line and at a right angle (90°) from the corridor into the mowing area (B).
- ▶ If the distances and lengths cannot be complied with, the mowing area (B) must be separated from the main mowing area (A) and a side area must be installed.

Installing a corridor

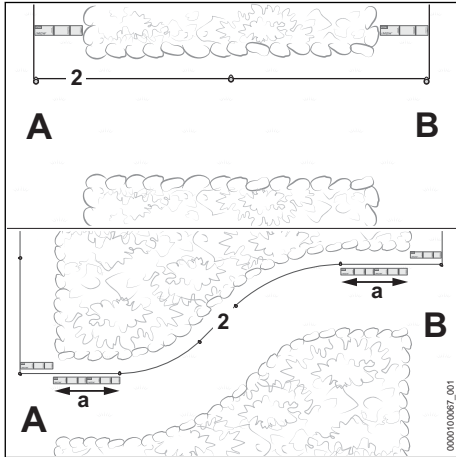

- ▶ Guide the perimeter wire (2), as illustrated, from the main mowing area (A) to the mowing area (B).
- ▶ If the corridor is to be installed in an arc: Route the perimeter wire (2) for a length of $a = 74$ cm (length: 2x iMOW® ruler) at the start and end of the corridor and at a right angle (90°) to the mowing area.
- ▶ Route the perimeter wire (2) clockwise around the mowing area (B) and back to the corridor.

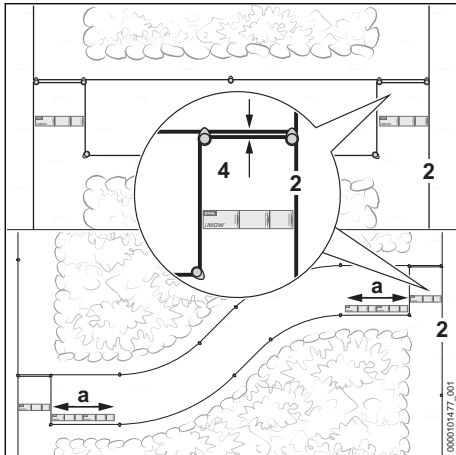

- ▶ Route the perimeter wire (2) parallel and closely together for 37 cm (length: 1x iMOW® ruler) without the perimeter wires crossing over each other.
- ▶ Route the perimeter wire (2) parallel at a distance of at least 55 cm toward the main mowing area (A).

- ▶ Route the perimeter wire (2) parallel and closely together for 37 cm (length: 1x iMOW® ruler) to the main mowing area (A) without the perimeter wires crossing over each other.
- ▶ If the corridor is to be installed in an arc: Route the perimeter wire (2) for a length of $a = 74$ cm (length: 2x iMOW® ruler) at the start and end of the corridor and at a right angle (90°) to the mowing area.
- ▶ Complete the routing of the wire on the main mowing area (A).

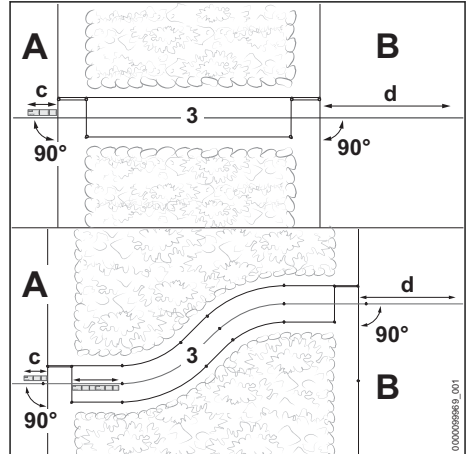

- ▶ Route the guide wire (3) on the main mowing area (A) for a length of at least $c = 37$ cm (length: 1x iMOW® ruler) in a straight line and at a right angle (90°) to the corridor.
- ▶ Route the guide wire in the center of the corridor.
- ▶ Route the guide wire (3) after the corridor for a length of at least $d = 2$ m in a straight line and at a right angle (90°) into the mowing area (B).

8.12 Inclines/slopes

The robot mower can navigate and mow inclines up to 40%.

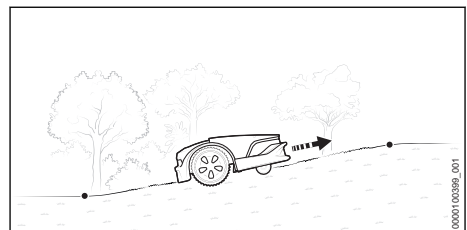

- ▶ If there is an incline/slope up to 27% within the mowing area: Install perimeter wire normally.

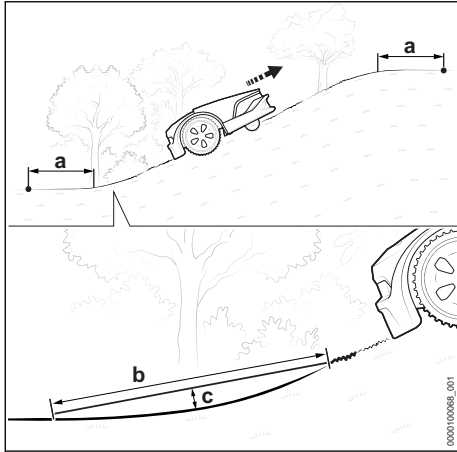

- ▶ If there is an incline/slope of more than 27% within the mowing area: Install the perimeter wire with a minimum distance $a = 1.20$ m before and after the incline/slope.
- ▶ So that the robot mower can navigate the transition between level ground and the incline/slope, the radius of the transition must be such that for $b = 1$ m the distance to the ground $c = 10$ cm must not be exceeded.

8.13 Side Area

The robot mower cannot reach an adjacent area by itself. The customer must place the robot mower in the adjacent area.

A guide wire must not be installed in an adjacent area.

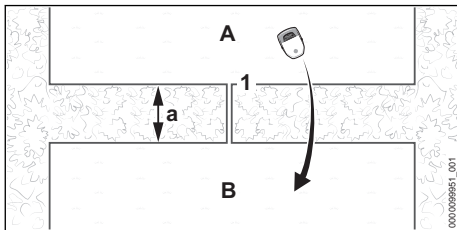

- ▶ Route the perimeter wire (1) from the main area (A) to the adjacent area (B). Minimum distance to the perimeter wires $a = 74$ cm
- ▶ Make sure that the length of the perimeter wire (1) does not exceed 850 m.
- ▶ Route the perimeter wires (1) in parallel and close to each other back to the mowing area (A) without the perimeter wires crossing.

8.14 Small Mowing Area

The STIHL AKM 100 small area module must be used for a small mowing area where less than 20 m of perimeter wire is required.

The STIHL AKM 100 stabilizes the wire signal and is incorporated into the perimeter wire by means of wire connectors.

9 Completing the Perimeter Wire Installation

9.1 Completing the routing of the perimeter wire

Docking station on the edge of the mowing area, docking station on the edge of the lawn area

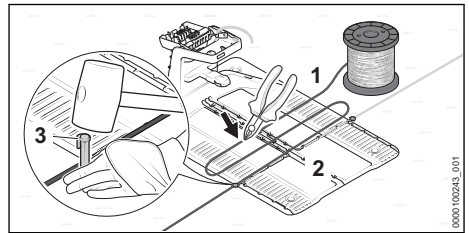

- ▶ Attach the perimeter wire (1) directly on the base plate (2) with a fixing pin (3).
- ▶ Use the perimeter wire (1) to measure two times the width of the base plate (2) and then cut the perimeter wire (1) to length with a wire cutter.

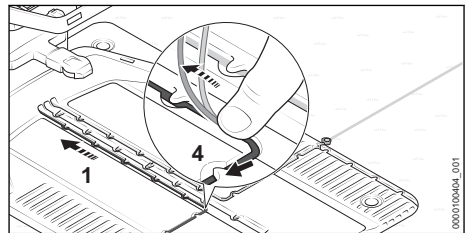

- ▶ Install the perimeter wire (1) in the base plate so that the guide wire lies flat in the cable duct and is secured by the hook (4).

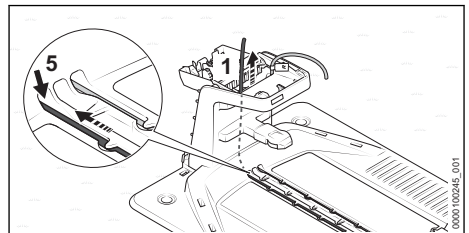

- ▶ Insert the perimeter wire (1) into the left conduit (5) and feed it through. Push the wire end (1) upward inside the docking station.

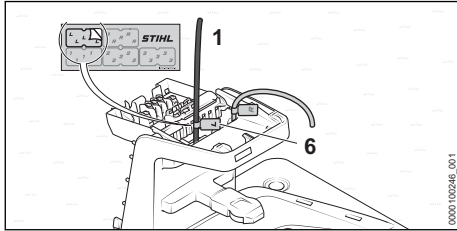

- ▶ Mark the wire end (1) near the housing using the matching cable marker (6).

Docking station outside the mowing area

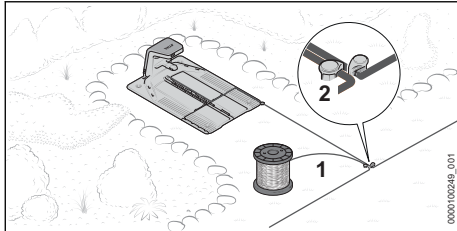

- ▶ Route the perimeter wire (1) close to the already routed perimeter wire and secure with a fixing pin (2).

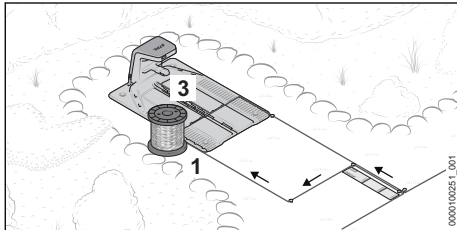

- ▶ Route the perimeter wire (1) parallel and closely to the other perimeter wire for 37 cm (length: 1x iMOW® Ruler) back to the docking station without crossing over the perimeter wires.
- ▶ Route the perimeter wire (1) back to the edge and further toward the base plate (3).

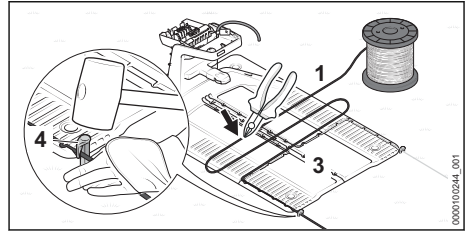

- ▶ Attach the perimeter wire (1) directly on the base plate (3) with a fixing pin (4).
- ▶ Use the perimeter wire (1) to measure two times the width of the base plate (3) and then cut the perimeter wire (1) to length with a wire cutter.

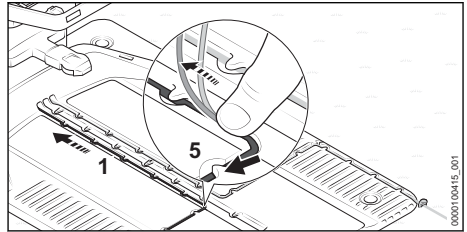

- ▶ Install the perimeter wire (1) in the base plate so that the guide wire lies flat in the cable duct and is secured by the hook (5).

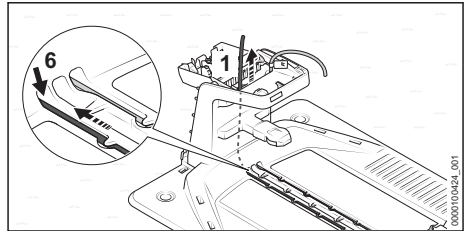

- ▶ Insert the perimeter wire (1) into the left conduit (6) and feed it through. Push the wire end (1) upward inside the docking station.

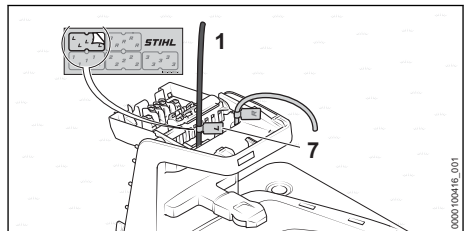

- ▶ Mark the wire end (1) near the housing using the matching cable marker (7).

It is mandatory to define a starting point within the mowing area at the conclusion of commissioning. Otherwise, the robotic mower will not find its way to the mowing area. Starting points and their approach frequency can be set using the MY iMOW® app.

Setting up the docking station in the center of the mowing area

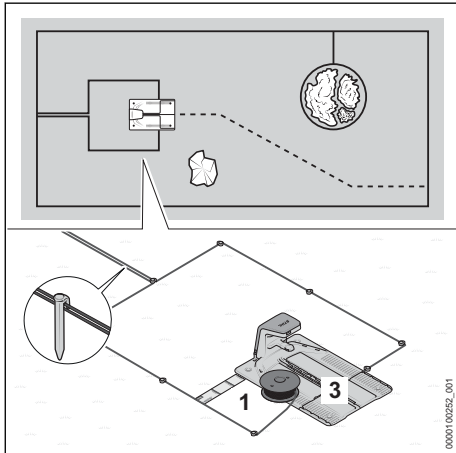

- ▶ Route the perimeter wire (1) close to the already routed perimeter wire.
- ▶ Route the perimeter wire (1) parallel and close to the other perimeter wire back to the docking station without crossing over the perimeter wires.
- ▶ Route the perimeter wire (1) toward the front around the base plate (3) at a distance of 37 cm (length: 1x iMOW® Ruler).

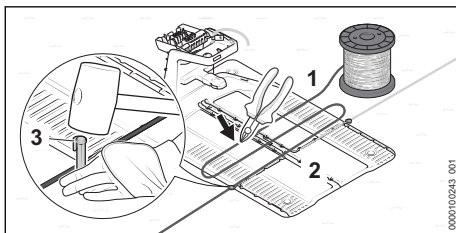

- ▶ Attach the perimeter wire (1) directly on the base plate (2) with a fixing pin (3).
- ▶ Use the perimeter wire (1) to measure two times the width of the base plate (2) and then cut the perimeter wire (1) to length with a wire cutter.

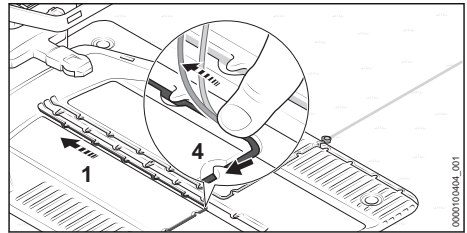

- ▶ Install the perimeter wire (1) in the base plate so that the guide wire lies flat in the cable duct and is secured by the hook (4).

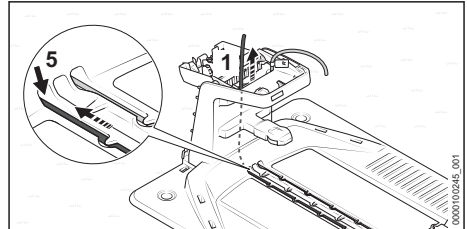

- ▶ Insert the perimeter wire (1) into the left conduit (5) and feed it through. Push the wire end (1) upward inside the docking station.

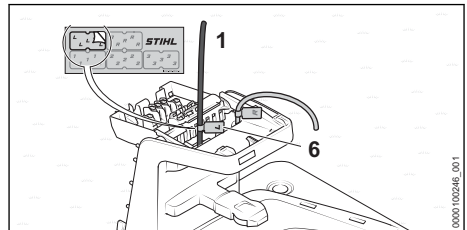

- ▶ Mark the wire end (1) near the housing using the matching cable marker (6).

10 Installing Guide Wire

10.1 Installing guide wire

Take into account the position of all guide wires when installing the perimeter wire.

- ▶ Take into account the general guidelines for installing the guide wire  8.1.

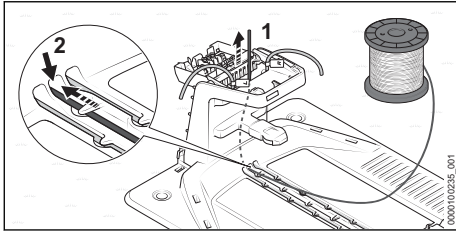

- ▶ Insert the beginning of the guide wire (1) into the middle conduit (2) and feed the wire through.
Push the guide wire (1) upward inside the docking station.

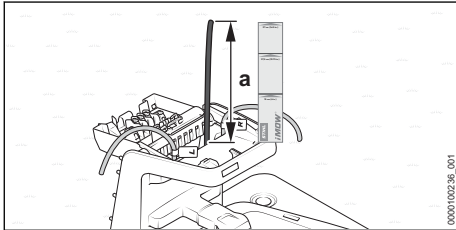

- ▶ Feed the guide wire (1) through until it protrudes upward for $a = 37$ cm (length: 1x iMOW® Ruler).

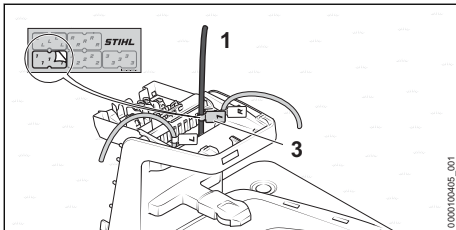

- ▶ Using the appropriate cable marker (3), mark the guide wire (1) near the housing.
Marking will facilitate the subsequent connection to the correct terminal.

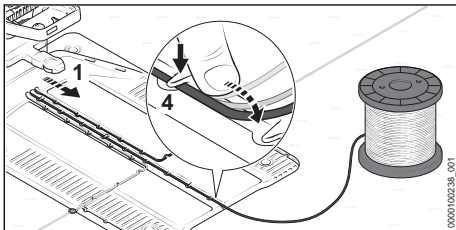

- ▶ Install the guide wire (1) in the base plate so that the guide wire lies flat in the cable duct and is secured by the hook (4).

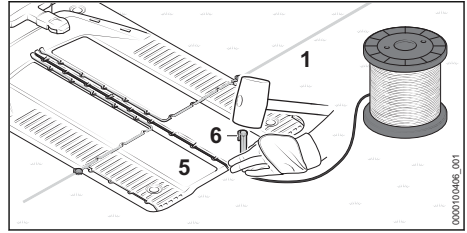

- ▶ Attach the guide wire (1) directly at the base plate (5) with a fixing pin (6).

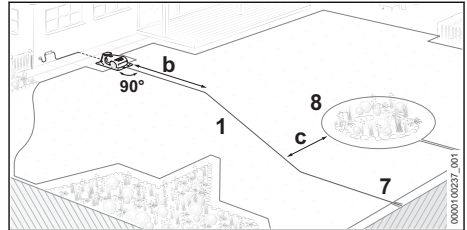

- ▶ Route the guide wire (1) for $b = 2$ m in a straight line and at a right angle (90°) from the docking station to the mowing area.
- ▶ Route the guide wire (1) to the wire loop (7) at the edge of the mowing area. The distance to circumferential perimeter wire (8) must be at least $c = 27.5$ cm.

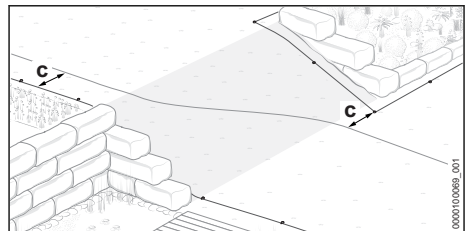

- ▶ Route the guide wire diagonally on inclines.
The distance to the perimeter wire must be at least $c = 27.5$ cm.

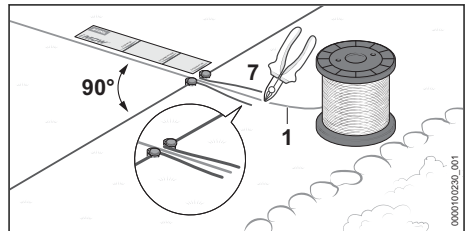

- ▶ Route guide wire (1) for at least $e = 37$ cm (length: 1x iMOW® Ruler) in a straight line and at a right angle (90°) to the wire loop (7).

- ▶ Route the guide wire (1) through the center of the wire loop (7).
- ▶ Using a wire cutter, cut through the guide wire (1) at the end of the wire loop (7) and make all wire ends the same length.

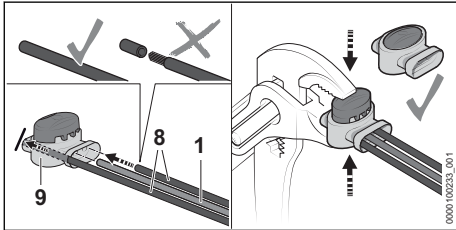

- ▶ Insert the ends of the perimeter wires (8) and the guide wire (1) into the wire connector (9) up to the limit stop. Do not strip the wire ends.
- ▶ Press the wire connector (1) together up to the limit stop with a pair of pliers.

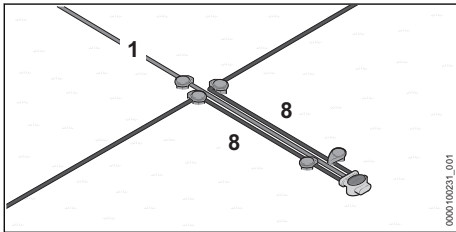

- ▶ Route the perimeter wires (8) and guide wire (1) in parallel and close to each other without the wires touching.
- ▶ Secure the wires using additional fixing pins.

11 Electrically connecting the docking station

11.1 Connecting perimeter wire and guide wire

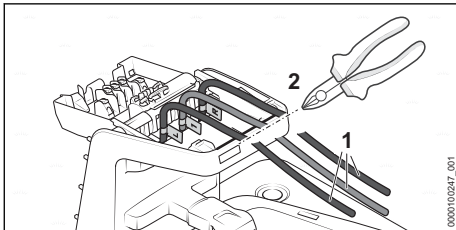

- ▶ Slightly tension the wire ends (1) and cut to length along the edge (2) with a wire cutter.

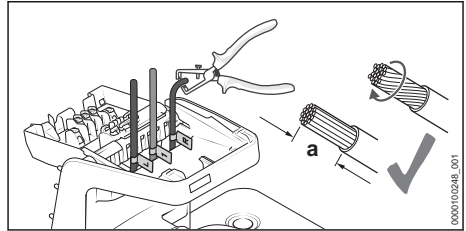

- ▶ Strip a = 10 mm of the wire ends.
- ▶ Twist wire strands so that no individual strands stick out.

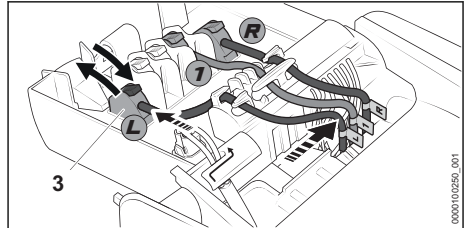

- ▶ Assign the labeled wire ends to the respective terminals.
- ▶ Fold the lever of the corresponding terminal (3) backward.
- ▶ Insert the insulated wire end into the corresponding terminal (3) and fold the lever forward again to close.
- ▶ Secure the perimeter wires and guide wire in the cable holders as shown and press toward the right.

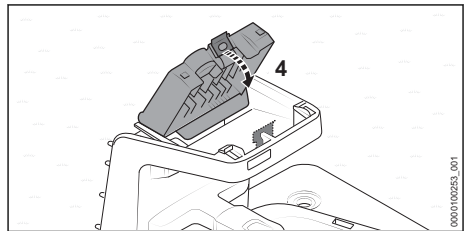

- ▶ Fold the cover (4) toward the front. The cover (4) engages with an audible and noticeable click.

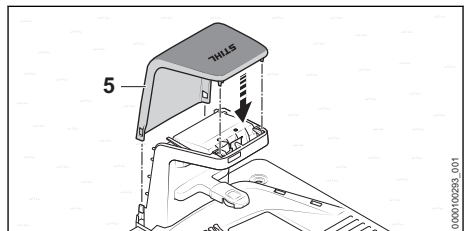

- ▶ Put on the hood (5).
The hood (5) engages with an audible click.

11.2 Routing the charging cable and connecting the power supply

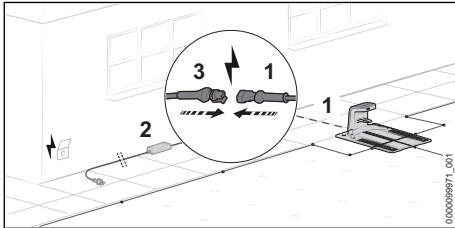

- ▶ Route the charging cable (1) to the location of the power supply (2).
- ▶ Choose the power supply (2) location so that the following conditions are met:
 - The power supply (2) and the connecting cable are outside of the mowing area.
 - A suitable wall socket is within reach of the power supply (2).
 - The power supply (2) rests on a flat and not permanently wet surface.
 - The power supply (2) is installed elevated above the ground in case it is exposed to more protracted wet conditions.
 - If possible, protect the location against adverse weather conditions and direct sunlight.
- ▶ Route the charging cable so that the following conditions are met:
 - The charging cable (1) is outside of the mowing area.
 - The charging cable (1) is routed so that people cannot trip over it.
 - The charging cable (1) is not under tension or tangled.
 - The charging cable (1) is completely unwound and is not under the docking station.
 - The charging cable (1) is not on a permanently wet surface.
- ▶ Connect charging cable (1) with the plug (3) of the power supply (2).

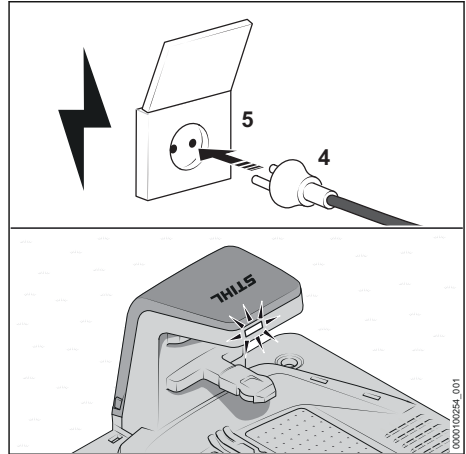

- ▶ Plug the mains plug (4) into a correctly installed socket (5).
The LED on the docking station lights up green.

11.3 Mounting the power supply on a wall

The power supply can be mounted on a wall.

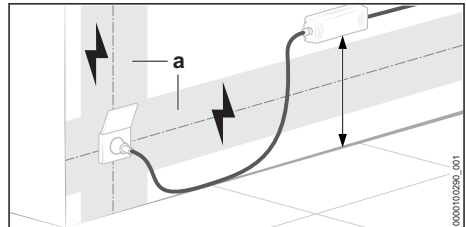

- ▶ Mount the power supply so that the following conditions are met:
 - Suitable fixing materials.
 - The power supply is level.
 Following distances are complied with:
 - The power supply is outside of the range (a) of possible electrical installations.
 - A suitable socket is within reach of the power supply.
 - If possible, protect the location against adverse weather conditions and direct sunlight.

12 Charging the Robot Mower

12.1 Charging the robotic mower

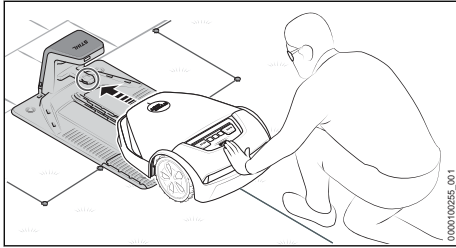

- ▶ Push the robot mower into the docking station up to the limit stop.
The robot mower carries out a system start and begins charging.

The charging time depends on various factors, e.g. the battery temperature or the ambient temperature. For optimum performance, note the recommended temperature ranges, [23.7](#).

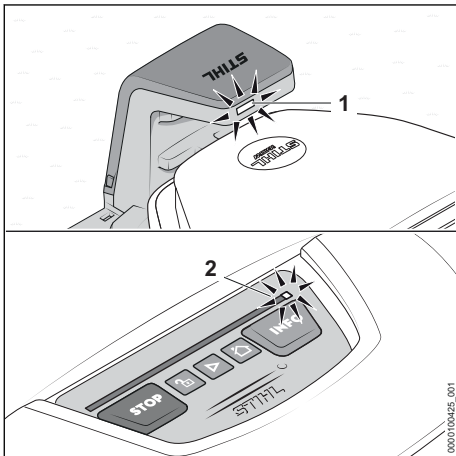

The LED (1) on the docking station lights up white. An LED (2) lights up white on the light strip of the robot mower.

After the first charging, the robotic mower will charge automatically in the future as soon as it returns to the docking station after a mowing job.

Energy efficient charging

In order to charge the robotic mower's battery with a minimum amount of energy, all of the robotic mower's and docking station's unnecessary extra features besides the charging function can be deactivated.

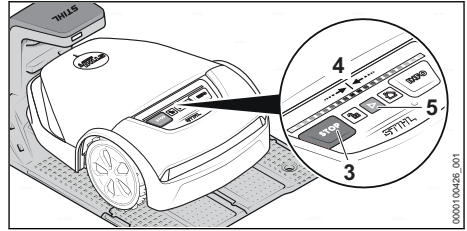

- ▶ If the theft protection function in the MY iMOW® app is activated, deactivate the theft protection.

Press the following key combination one after the other:

- ▶ Press STOP (3).
- ▶ The robot mower is stopped and locked
- ▶ Press and hold STOP (3) until the light strip (4) fully lights up red.
- ▶ Press STOP (1).
The light strip (4) flashes twice. The device lock of the robot mower is activated.
- ▶ Press and hold STOP (3) until the light strip (4) fully lights up red and finally flashes red twice.
"Energy efficient charging" mode is activated. The robot mower's battery is fully charged. All extra functions are deactivated.

After charging is complete, the robot mower must be activated so that it is operational again:

- ▶ Press START (5).
The robotic mower is operational.

13 Closing Bluetooth® Radio Interface

13.1 Setting up the Bluetooth®-radio interface

The robotic mower regularly emits a Bluetooth® signal in order to be able to connect with a mobile device. In delivered condition, the radio interface is not password protected.

- ▶ Download the MY iMOW® in the app store of your mobile device and create an account.
- ▶ Add the robotic mower to the account.
- ▶ Follow the instructions on the screen and secure the Bluetooth® radio interface with a password.
After the password is assigned, the mobile device is authorized to control and configure the robot mower.

An additional mobile device can only be authorized by entering the selected password. In this

way, the robot mower is secured against unauthorized access.

14 Light patterns on the robot mower and charging station

14.1 Light strips on the robot mower

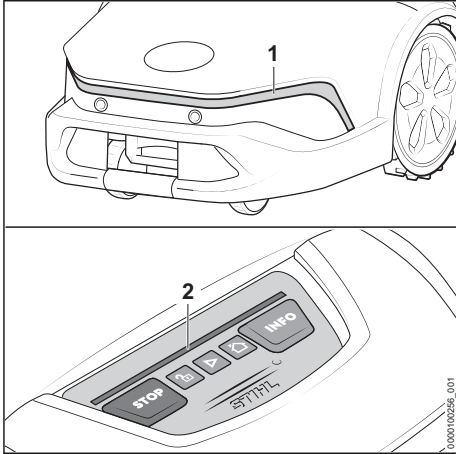

The light strips (1 and 2) indicate the robot mower's status and faults.

White light pattern:

- No active mowing.

Green light pattern:

- Mowing is active.

Blue light pattern:

- The robot mower is receiving a system update or the system is restarting.

Red light pattern:

- Device lock is active.
- Fault message.

14.2 LED on the docking station

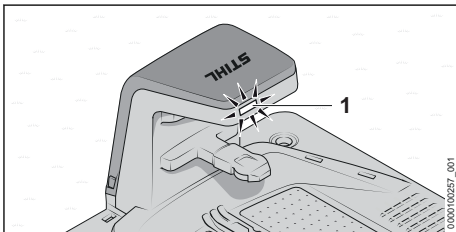

The LED (1) indicates the docking station status and faults.

LED (1) lights up white:

- The docking station is operational.
- The robot mower is in the docking station without active mowing.
- The robot mower is charging without active mowing.

The LED (1) lights up green.

- The robot mower is being partially recharged during mowing.

LED (1) lights up red.

- There is a fault.

LED (1) lights up blue:

- Communication with the robot mower.

15 Operating and Adjusting the Robot Mower

15.1 Control Panel

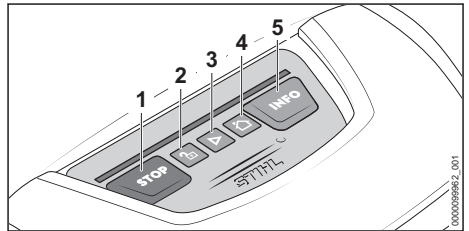

Use the pushbuttons (1 to 5) to operate the robotic mower's basic functions. The full scope of functions is available in the MY iMOW® app.

Starting the Mowing Process

- ▶ Press START (3).

The robot mower starts mowing and later automatically returns to the docking station.

Stopping the mowing process and locking the robot mower

- ▶ Press STOP (1).

The robot mower and the mowing unit stop. The robot mower is locked.

Sending the robot mower to the docking station

- ▶ Press HOME (4).

The robot mower returns to the docking station.

Unlocking the robot mower

- ▶ Press LOCK (2).
- ▶ Press the displayed key combination.

Accessing information

- ▶ Press INFO (5).

The robotic mower reports audible information about the current status.

15.2 The MY iMOW®

The MYiMOW® app is required for the convenient use of the robotic mower. The robotic mower can be operated and configured via the MYiMOW® app. The robotic mower can be connected to a mobile device via a wireless network connection (WLAN) or Bluetooth®. The robotic mower can be operated and configured from a desktop computer using the MY iMOW® web app.

Main functions:

- Starting and stopping the mowing process
- Mowing plan
 - Configuring mowing times (with an assistant or manually)
 - Configuring starting points (optional)
 - Selecting zones (optional)
- Setting the cutting height
- Remote access to the robotic mower via a wireless network connection (WLAN)
- Support

16 Stopping the robot mower and activating the device lock

16.1 Stopping the robot mower and activating the device lock



! WARNING

- The robot mower may unintentionally be switched on if the robot mower is not stopped and shut down by activating the device lock as described in this User Manual. This may result in serious injury to people and damage to property.
 - ▶ Stop the robot mower and activate the device lock during transport, storage, cleaning, servicing and repair or when there is changed or unusual behavior.

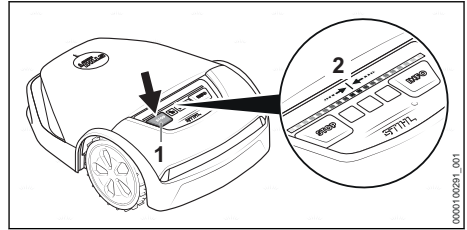

- ▶ Press STOP (1).
The robot mower is stopped and locked.
- ▶ Press and hold STOP (1) until the light strip (2) fully lights up red.
- ▶ Press STOP (1).
The light strip (2) flashes twice. The device lock of the robot mower is activated. The robot mower can be transported, stored, cleaned or serviced.

17 Transporting

17.1 Transporting the robot mower

- ▶ Stop the robot mower and activate the device lock.

Carrying the robot mower

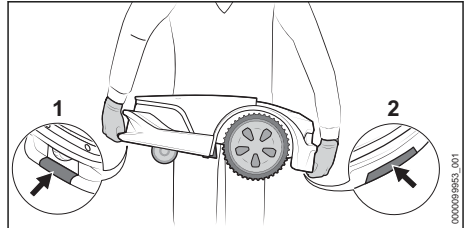

- ▶ Wear work gloves made of robust material.
- ▶ Carry the robot mower at the front grip surface (1) and the rear grip surface (2).

Transporting the robot mower in a vehicle

- ▶ Secure the robot mower so that it does not tip over and cannot move.

17.2 Transporting the Battery

The battery has been installed in the robot mower and must only be removed by a STIHL authorized dealer.

- ▶ Check that the battery is in a safe condition.
- ▶ Pack the battery in packaging in such a way that it cannot move inside the packaging.
- ▶ Secure the packaging so that it cannot move.

The battery is subject to the Carriage of Dangerous Goods regulations. The battery is classified as UN 3480 (lithium ion batteries) and has been

tested pursuant to UN Manual Tests and Criteria Part III, Subsection 38.3.

The transport regulations can be found at www.stihl.com/safety-data-sheets.

18 Storing

18.1 Preparing the robotic mower for storage

STIHL recommends when the robotic mower is not used for longer periods of time, e.g., winter break, to put it into "hibernation". Hibernation deactivates all unnecessary extra functions of the robotic mower and ensures a low discharge of the battery.

- ▶ If the theft protection function in the MY iMOW® app is activated, deactivate the theft protection.
- ▶ If the robotic mower's state of charge is below 50%: charge the robotic mower until its state of charge exceeds 50%.

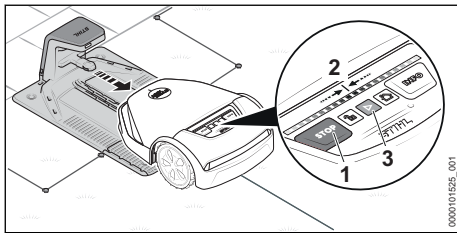

- ▶ Remove the robotic mower from the docking station.

Press the following key combination one after the other:

- ▶ Press STOP (1).
The robot mower is stopped and locked.
- ▶ Press and hold STOP (1) until the light strip (2) fully lights up red.
- ▶ Press STOP (1).
The light strip (2) flashes twice. The device lock of the robot mower is activated.
- ▶ Press and hold STOP (1) until the light strip (2) fully lights up red and finally flashes red twice.
The hibernation mode is activated. All extra functions are deactivated.

After the winter break, the robot mower must be activated so that it is operational again:

- ▶ Move robot mower to the mowing area.
- ▶ Press START (3).
The "hibernation" mode is deactivated and the robotic mower is once again operational.

18.2 Storing the robotic mower

- ▶ Store the robotic mower so that the following conditions have been met:
 - The robot mower is out of the reach of children.
 - The robotic mower is clean and dry.
 - The robotic mower is in an enclosed space.
 - The robotic mower's battery is charged.
 - Do not store the robotic mower outside of the specified temperature limits, 23.6.
 - The robotic mower cannot tip over.
 - The robotic mower cannot roll away.
 - The robot mower is horizontal on its wheels.
 - No objects are placed on the robot mower.

The robot mower can also be stored on a wall holder. The wall holder is available as an accessory.

NOTICE

- If the robotic mower is not stored as described in this User Manual, the battery may become deeply discharged and irreparably damaged.
 - ▶ Charge the battery of the robotic mower before storage.

18.3 Storing the docking station, charging cable and power supply

During longer periods of non-use, e.g. in winter, the docking station, charging cable and power supply may remain in the mowing area.

- ▶ Disconnect the power supply's mains plug from the wall socket.
- ▶ Protect the mains plug against weather conditions.
- ▶ Clean all components.

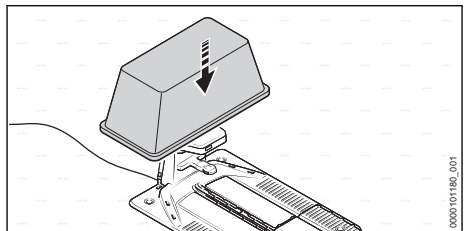

- ▶ Cover the docking station, e.g., with a large pail or a mortar bucket.

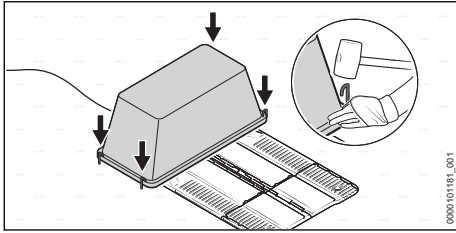

- ▶ Secure the pail or mortar bucket to the ground with peps.

Dismantling the docking station, charging cable and power supply

To store the wall holder available as an accessory, or if covering is not possible, the docking station, charging cable and power supply can also be removed.

- ▶ Disconnect the power supply's mains plug from the wall socket.
- ▶ Clean all components.
- ▶ Disconnect the charging cable from the docking station and power supply and coil it.
- ▶ Remove power supply and coil up connecting cable.
- ▶ Disconnect perimeter wire and guide wire from the docking station.
- ▶ Grease wire ends to protect against corrosion and weather conditions.
- ▶ Remove the docking station.

19 Cleaning

19.1 Cleaning the Robot Mower



WARNING

- The cutting edges of the blades are sharp. There is a risk of cutting oneself.
 - ▶ Wear work gloves made of robust material.
- ▶ Stop the robot mower and activate the device lock.

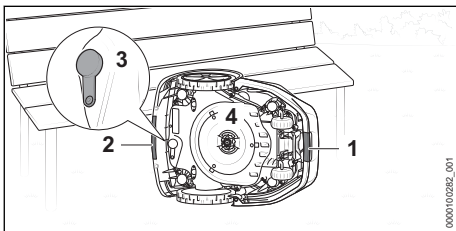

- ▶ Grip the robotic mower at the front grip surface (1) and the rear grip surface (2).
- ▶ Place the robot mower on its side and secure it against falling over.

- ▶ Check the plug (3) of the diagnostic socket for damage and tight fit.
- ▶ If the blade disk (4) is heavily soiled, remove the blade disk (4).

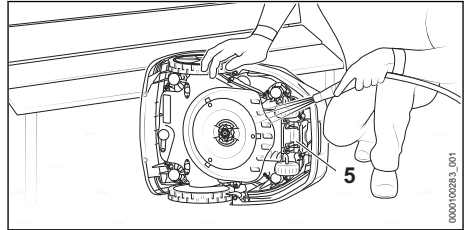

- ▶ Remove the dirt with a wooden rod or a soft brush. If necessary, use a ph-neutral detergent. STIHL recommends STIHL Multiclean.
- ▶ Rinse off loose dirt with a gentle water jet.
- ▶ Clean the underside of the robotic mower with a damp cloth.
- ▶ Clean the charging contacts (5) with a damp cloth.
- ▶ Clean the hood and control panel with a damp cloth.

19.2 Cleaning the docking station, power supply, charging cable and plug connections

- ▶ Disconnect the power supply's mains plug from the wall outlet.
- ▶ Clean the docking station, power supply and charging cable with a damp cloth.
 - ▶ If necessary, remove built-up dirt with a soft brush.
- ▶ Clean plug connections with a dry lint-free cloth.
 - ▶ If necessary, remove built-up dirt with a brush.

20 Maintenance

20.1 Visual Inspection

- ▶ Regularly check the robot mower:
 - Cleanliness of the charging contacts
 - Check the hood and protective strip for damage
 - Check that the wheels run smoothly
 - Check the blades for damage, wear, cracks and smooth running

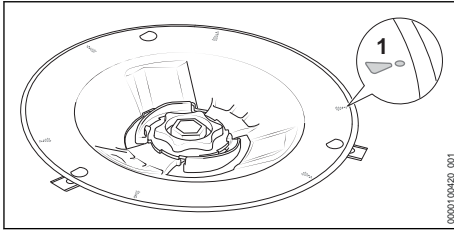

- Check the blade disk for damage and wear.
 - If the wear marks (1) are worn through, creating a hole, replace the blade disk.

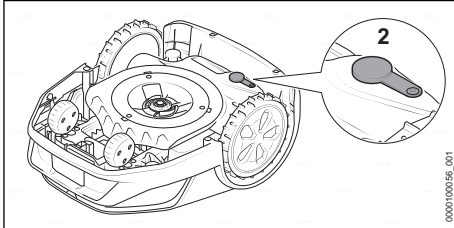

- Check the plug (2) of the diagnostic socket for damage and tight fit.

20.2 Replacing blades

WARNING

- The cutting edges of the blades are sharp. There is a risk of cutting oneself.
 - ▶ Wear work gloves made of robust material.
- ▶ Stop the robot mower and activate the device lock.

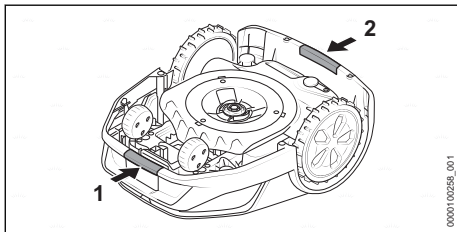

- ▶ Grab the robot mower at the front grip surface (1) and the rear grip surface (2).
- ▶ Turn the robot mower on its back.

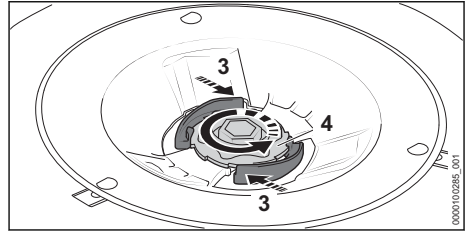

- ▶ Press and hold the lever (3).
- ▶ Rotate the nut (4) counterclockwise until it can be removed.

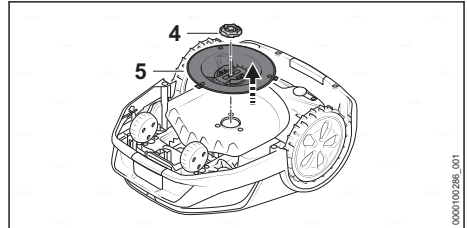

- ▶ Remove the nut (4).
- ▶ Remove the blade disk (5).

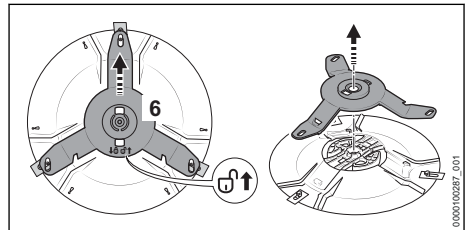

- ▶ Push the blade carrier (6) in the direction indicated by the arrow \varnothing . The blade carrier (6) is unlocked.
- ▶ Remove the blade carrier (6).

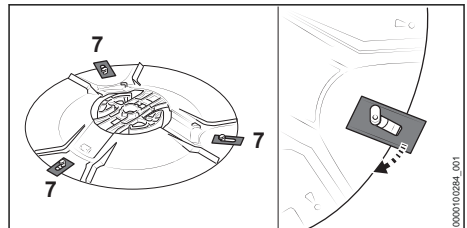

- ▶ Detach all old blades (7).

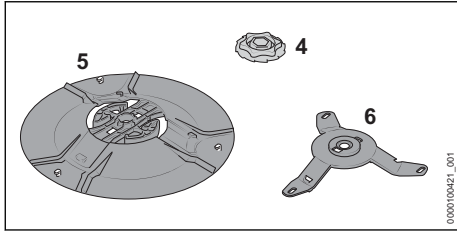

- ▶ Clean, blade disk (5), blade carrier (6) and nut (4).

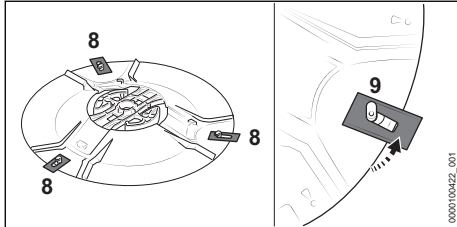

- ▶ Attach new blades (8). Insert only one blade per pin (9).

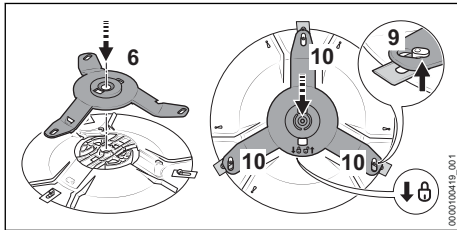

- ▶ Put on the blade carrier (6).
- ▶ Push the blade carrier (6) in the direction of the arrow \odot and make sure that all three arms (10) underneath the pins (9) are positioned.
The blade carrier (6) is locked.
- ▶ Position the blade disk (5) on the robot mower.
- ▶ Press and hold the lever (3).
- ▶ Turn the nut (4) clockwise.
- ▶ Release the lever (3) and tighten nut (4) securely clockwise.
The levers (3) engage audibly.

21 Repairing

21.1 Repairing the robot mower, battery, blades, docking station and power supply

Users cannot repair the robot mower, battery, docking station and power supply themselves.

Damaged or worn blades can be replaced.

- ▶ If the robot mower, battery, docking station, charging cable, power supply or connecting cable is damaged: Do not use the robot mower, battery, docking station, charging cable, power supply or connecting cable and contact a STIHL authorized dealer.
- ▶ If a blade is damaged or worn:
 - ▶ Stop the robot mower and activate the device lock.
 - ▶ Replace all blades. The blades cannot be re-sharpened.
- ▶ If warning labels are illegible or damaged: Have the warning labels replaced by a STIHL authorized dealer.

21.2 Extending or repairing perimeter wire or guide wire

The perimeter wire or guide wire can be extended or repaired using wire connectors.

Wire connectors are filled with gel to prevent premature wear or corrosion of the wire ends.

- ▶ Make sure that the overall length of the perimeter wires does not exceed the maximum length of 850 m.

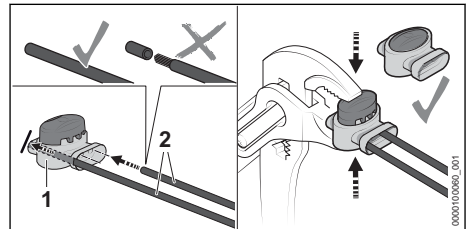

- ▶ Insert the wire ends (2) into the wire connectors (1).
Do not strip the wire ends.
- ▶ Press the wire connector (1) together up to the limit stop with a pair of pliers.

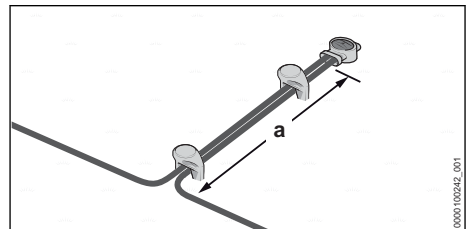

- ▶ Route perimeter wires at least for a length of $a = 5$ cm parallel and close together without the perimeter wires crossing over each other.

22 Troubleshooting

22.1 Troubleshooting the robotic mower

Most faults are indicated in the MY iMOW® app and by red light patterns on the robotic mower or docking station.

Proceed as follows for troubleshooting:

► Follow the instructions in the MY iMOW® app.

or

► Press the INFO pushbutton on the control panel and follow the audible instructions.

Fault	Light strips on the robot mower or docking station	Cause	Remedy
The robot mower stops on the way back to the docking station.		The battery is discharged.	<ul style="list-style-type: none"> ► Make sure that the length of the perimeter wire does not exceed 850 m. ► Optimize routing of the guide wire. ► Install another guide wire within the mowing area. ► Carry the robot mower to the docking station for charging. ► If possible, in a mowing area with a slope, position the docking station in the lower area of the slope.
The robot mower fails to start the mowing process as expected.	Illuminated strips light up blue.	The robot mower is restarting.	<ul style="list-style-type: none"> ► Wait until the restart has been completed. The robot mower then automatically starts the mowing process.
	Light strips light up red. The LED on the docking station lights up red.	There is a fault on the perimeter wire or guide wire.	<ul style="list-style-type: none"> ► Make sure that the perimeter wire or guide wire is undamaged. ► Make sure that the perimeter wire or guide wire is correctly connected to the docking station. ► Make sure that the perimeter wire and guide wire are correctly connected to the wire connector. ► Follow the instructions in the MY iMOW® app.
The robotic mower is not charging.	Light strips light up red. The LED on the docking station lights up red.	There is a fault in the robot mower, battery, power supply or docking station.	<ul style="list-style-type: none"> ► Make sure that the charging contacts on the docking station and robotic mower are clean. ► Follow the instructions in the MY iMOW® app. ► If the fault persists: Do not attempt to further charge the robotic mower, remove the mains plug of the connecting cable from the socket outlet and contact a STIHL authorized dealer.

23 Specifications

23.1 STIHL iMOW® 5.0, 6.0, 7.0 Robotic Mower

Specifications

- Cutting width: 28 cm
- Cutting height - electric: 20 mm to 60 mm
- Speed of the blade disk: 2400 rpm
- Mowing speed
 - iMOW® 5.0: 0.45 m/s

- iMOW® 6.0: 0.45 m/s
- iMOW® 7.0: 0.45 m/s
- Dimensions:
 - Height: 291 mm
 - Width: 525 mm
 - Length: 705 mm
- Weight:
 - iMOW® 5.0: 14 kg
 - iMOW® 6.0: 15 kg
 - iMOW® 7.0: 15 kg

- Protection class: III
- Degree of protection: IP56
- Maximum mowing area:
 - iMOW® 5.0: 1500 m²
 - iMOW® 6.0: 3000 m²
 - iMOW® 7.0: 5000 m²
- Active time 1000 m² (per week) ¹
 - iMOW® 5.0: 50 h
 - iMOW® 6.0: 35 h
 - iMOW® 7.0: 30 h
- Maximum length of the perimeter wire: 850 m
- Maximum gradient: 40%

Bluetooth®

- Data connection: Bluetooth® 5.1. The mobile appliance must be compatible with Bluetooth® Low Energy 5.0 and support Generic Access Profile (GAP).
- Frequency band: ISM band 2.4 GHz
- Maximum RF power transmitted: 1 mW
- Signal range: approx. 10 m. The signal strength depends on the ambient conditions and the mobile terminal. Signal range can vary greatly depending on local conditions, including the receiver. The range may be perceptibly reduced inside enclosed rooms and through metal barriers (such as walls, shelves or cases).
- Mobile terminal operating system requirements: See info.myimow.stihl.com

Radio network (WLAN)

- Network standard: IEEE 802.11b/g/n
- Frequency band: 2.4 GHz
- Maximum RF power transmitted: 100 mW

23.2 Blades

- Number of blades: 3

23.3 STIHL AAI battery

The battery has been installed in the robot mower and must only be removed by a STIHL authorized dealer.

- Battery technology: lithium-ion
- Voltage: 36 V
- Capacity in Ah: see rating label
- Energy content in Wh: see rating label
- Weight in kg: see rating label

23.4 Docking station and power supply

Docking station

- Protection class: III
- Degree of protection: IPX5
- Weight: 4.0 kg
- Perimeter wire and guide wire
 - Voltage: 42 V DC
 - Frequency range: 1.4 kHz to 20 kHz

Power supply

- Market-dependent versions:
 - DM160E-420A
 - DM160E-420AS
 - DM160K-420A
 - DM160S-420A
 - DM210E-420A
 - DM210E-420AS
 - DM210K-420A
 - DM210S-420A
- Weight:
 - Version 160 W: 1.6 kg
 - Version 210 W: 2.0 kg
- Rated voltage: See rating plate
- Frequency: see rating plate
- Rated power: see rating plate
- Charging current: See rating plate
- Protection class: II
- Degree of protection: IP 67

23.5 Extension Cords

If an extension cord is used, the cross sectional area of its conductors must meet the following minimum requirements – depending on the line voltage and length of the extension cord:

If rated voltage on the rating label is 220V to 240V:

- Cord length up to 20 m: AWG 15 / 1.5 mm²
- Cord length 20 m up to 50 m: AWG 13 / 2.5 mm²

If rated voltage on the rating label is 100V to 127V:

- Cord length up to 10 m: AWG 14 / 2.0 mm²
- Cord length 10 m up to 30 m: AWG 12 / 3.5 mm²

¹Under ideal conditions (few obstacles, simple geometry and low gradients in garden, moderate growth of lawn)

23.6 Temperature limits



WARNING

- The battery in the robot mower is not protected against all environmental conditions. If the battery is exposed to certain environmental conditions, it may catch fire or explode. This may result in serious injury to people and damage to property.
 - ▶ Do not charge the battery below 5°C or above 40°C.
 - ▶ Do not use the robot mower below 5°C or above 40°C.
 - ▶ Do not use the docking station and power supply below 5°C or above 40°C.
 - ▶ Do not store the robot mower below 0°C or above 40°C.
 - ▶ Do not store the docking station and power supply below -20°C or above 60°C.

23.7 Recommended temperature ranges

For optimum performance of the battery installed in the robot mower and of the docking station and power supply, observe the following temperature ranges:

- Charging: 5°C to 40°C
- Use: 5°C to 40°C
- Storage of robot mower: 0°C to 40°C
- Storage of docking station and power supply: -20°C to 60°C

If the battery is charged, used or stored outside the recommended temperature ranges, performance may be reduced.

23.8 Noise values

The K value for the sound power level is 2 dB(A).

- Sound power level measured according to 2000/14 EC: 59 dB(A).
- Sound power level guaranteed according to 2000/14 EC: 61 dB(A).

23.9 REACH

REACH is an EC regulation and stands for the Registration, Evaluation, Authorisation and Restriction of Chemical substances.

For information on compliance with the REACH regulation see www.stihl.com/reach.

24 Spare Parts and Accessories

24.1 Spare parts and accessories

STIHL These symbols indicate original STIHL spare parts and original STIHL accessories.

STIHL recommends the use of original STIHL spare parts and accessories.

Despite ongoing market observation, STIHL is unable to judge the reliability, safety and suitability of other manufacturers' spare parts and accessories; accordingly, STIHL cannot warrant for the use of those parts.

Original STIHL spare parts and original STIHL accessories are available from STIHL dealers.

25 Disposal

25.1 Disposal of the robot mower

Contact local authorities or a STIHL authorized dealer for information on disposal.

Improper disposal can be harmful to health and pollute the environment.

The robot mower contains a built-in rechargeable battery, which must be disposed of separately.

- ▶ Return the robot mower to a STIHL authorized dealer for disposal.
 - The STIHL authorized dealer will remove the built-in battery from the robot mower for separate disposal.
- ▶ Take STIHL products including packaging to a suitable collection point for recycling in accordance with local regulations.
- ▶ Do not dispose with domestic waste.

26 EC Declaration of Conformity

26.1 STIHL iMOW® 5.0, 6.0, 7.0 Robotic Mower

ANDREAS STIHL AG & Co. KG
Badstraße 115
D-71336 Waiblingen

Germany

declares under our sole responsibility that

Designation: Robot mower

- Manufacturer's brand: STIHL
- Type: iMOW® 5.0, 6.0, 7.0
- Serial number: IA01

Designation: Docking station

- Manufacturer's brand: STIHL
- Type: Docking station
- Serial number: IA01

conforms to the specifications of the Directives 2006/42/EC, 2011/65/EU, 2006/66/EC, 2014/53/EU and has been developed and built in compliance with the versions of the following standards valid at the production date: EN 50636-2-107, EN 60335-1 Ed 5, EN 55014-1, EN 55014-2, EN 61000-3-2, EN 61000-3-3, EN 62311, ETSI EN 301 489-1 V2.2.3 (2019-11), ETSI EN 301 489-3 V 2.1.2 (2021-03), ETSI EN 303 447 V1.3.1 (2022-07), ETSI EN 301 489-52 V1.2.1 (2021-11), ETSI EN 303 413 V1.1.1 (2017-06), ETSI EN 301 489-17 V3.2.4 (2020-09), ETSI EN 301 489-19 V2.2.1 (2022-09), ETSI EN 300 328 V2.2.2 (2019-07).

Participating notified body: VDE Prüf- u. Zertifizierungsinstitut GmbH, No. 0366, has verified the conformity in accordance with Annex III Module B of the Directive 2014/53/EU and has issued the following EU type examination certificate: 40055521.

The technical documents are stored at ANDREAS STIHL AG & Co. KG Product Approval.

The year of construction, the country of manufacture and the machine number are shown on the robot mower.

Waiblingen, 2023-02-16

ANDREAS STIHL AG & Co. KG

pp 

Robert Olma, Vice President, Regulatory Affairs & Global Governmental Relations

27 UKCA Declaration of Conformity

27.1 STIHL iMOW® 5.0, 6.0, 7.0 Robotic Mower



ANDREAS STIHL AG & Co. KG
Badstraße 115
D-71336 Waiblingen

0458-011-0101-A

Germany

declares under our sole responsibility that

- Designation: Robot mower
- Manufacturer's brand: STIHL
 - Type: iMOW® 5.0, 6.0, 7.0
 - Serial number: IA01
- Designation: Docking station
- Manufacturer's brand: STIHL
 - Type: Docking station
 - Serial number: IA01

conforms to the specifications of the UK regulations The Restriction of the Use of Certain Hazardous Substances in Electrical and Electronic Equipment Regulations 2012, Supply of Machinery (Safety) Regulations 2008, Electromagnetic Compatibility Regulations 2016 and has been developed and built in compliance with the versions of the following standards valid at the production date: EN 50636-2-107, EN 60335-1 Ed 5, EN 55014-1, EN 55014-2, EN 61000-3-2, EN 61000-3-3, EN 62311, ETSI EN 301 489-1 V2.2.3 (2019-11), ETSI EN 301 489-3 V 2.1.2 (2021-03), ETSI EN 303 447 V1.3.1 (2022-07), ETSI EN 301 489-52 V1.2.1 (2021-11), ETSI EN 303 413 V1.1.1 (2017-06), ETSI EN 301 489-17 V3.2.4 (2020-09), ETSI EN 301 489-19 V2.2.1 (2022-09), ETSI EN 300 328 V2.2.2 (2019-07).

The technical documents are stored at ANDREAS STIHL AG & Co. KG.

The year of construction, the country of manufacture and the machine number are shown on the robot mower.

Waiblingen, 2023-02-16

ANDREAS STIHL AG & Co. KG

pp 

Robert Olma, Vice President, Regulatory Affairs & Global Governmental Relations

28 Open Source Software

28.1 Open source software

This product contains copyright protected open source software that has been published by the respective copyright holders under certain license terms such as GNU General Public License (GPL), GNU Lesser General Public License (LGPL), Apache License or similar licen-

ses. If copyright protected notes, terms of use or license terms are contained in this User Manual that contradict the terms of an applicable open source license, they are not used in the User Manual. The use and dissemination of the contained open source software is subject exclusively to the respective open source license. Insofar as the applicable license grants you the right to the source code of this software and/or other additional data, you can obtain the source code from us during a period of three years after our last delivery of the product and if the license terms require it for as long as we offer customer support for the product. To obtain the complete corresponding source code from us, you can send your request with information of the product name, serial number and version of the corresponding software to the following address: ANDREAS STIHL AG & Co. KG, Open Source Team/Officer, Postfach 17 71, 71307 Waiblingen, Germany. We reserve the right to charge you the costs of the data carrier as well as shipping costs. You can find additional information at the following website: <https://open-source.stihl.com>

www.stihl.com



0458-011-0101-A



0458-011-0101-A