

MS 182, 212

STIHL



2 - 32 Instruction Manual



Contents

1	Introduction.....	2
2	Guide to Using this Manual.....	2
3	Overview.....	2
4	Safety Precautions.....	4
5	Preparing the Saw for Operation.....	11
6	Assembling the Saw.....	11
7	Engaging and Disengaging the Chain Brake	14
8	Mixing Fuel and Refueling the Chainsaw..	15
9	Starting and Stopping the Engine.....	16
10	Checking the Saw.....	18
11	Operating the Saw.....	20
12	After Finishing Work.....	24
13	Transporting.....	24
14	Storing.....	24
15	Cleaning.....	25
16	Maintenance.....	26
17	Repairing.....	27
18	Troubleshooting.....	27
19	Specifications.....	29
20	Bar and Chain Combinations.....	30
21	Spare Parts and Accessories.....	31
22	Disposal.....	31
23	EC Declaration of Conformity.....	31
24	UKCA Declaration of Conformity.....	32
25	Addresses.....	32

1 Introduction

Dear Customer,

Thank you for choosing STIHL. We develop and manufacture our quality products to meet our customers' requirements. The products are designed for reliability even under extreme conditions.

STIHL also stands for premium service quality. Our dealers guarantee competent advice and instruction as well as comprehensive service support.

STIHL expressly commit themselves to a sustainable and responsible handling of natural resources. This user manual is intended to help you use your STIHL product safely and in an environmentally friendly manner over a long service life.

We thank you for your confidence in us and hope you will enjoy working with your STIHL product.



Dr. Nikolas Stihl

IMPORTANT! READ BEFORE USING AND KEEP IN A SAFE PLACE FOR REFERENCE.

2 Guide to Using this Manual

2.1 Symbols used with warnings in the text

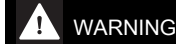

- This symbol indicates dangers that can cause serious injuries or death.
 - ▶ The measures indicated can avoid serious injuries or death.

NOTICE

- This symbol indicates dangers that can cause damage to property.
 - ▶ The measures indicated can avoid damage to property.

2.2 Symbols in Text



This symbol refers to a chapter in this instruction manual.

3 Overview

3.1 Chainsaw

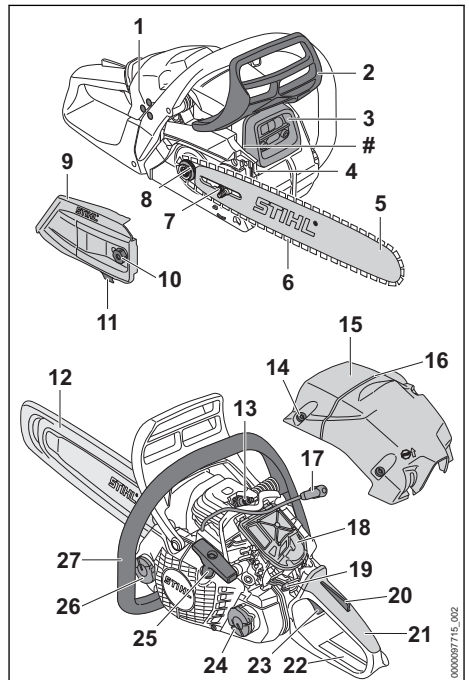

- 1 Carburetor adjusting screws**
For tuning the carburetor.
- 2 Front hand guard**
The front hand guard protects the operator's left hand against contact with the saw chain and is used to engage the chain brake in the event of kickback.
- 3 Muffler**
Reduces chainsaw noise emissions.
- 4 Spiked bumper**
The spiked bumper supports the chainsaw against the wood while cutting.
- 5 Guide bar**
The guide bar supports and guides the saw chain.
- 6 Saw chain**
The saw chain cuts the wood.
- 7 Tensioning screw**
The tensioning screw is used to adjust the chain tension.
- 8 Chain sprocket**
The chain sprocket drives the saw chain.
- 9 Chain sprocket cover**
The chain sprocket cover covers the chain sprocket and fastens the guide bar to the chainsaw.
- 10 Nut**
The nut secures the chain sprocket cover to the chainsaw.
- 11 Chain catcher**
The chain catcher catches the saw chain if it breaks or comes off the bar.
- 12 Chain scabbard**
The chain scabbard protects against contact with the saw chain.
- 13 Spark plug**
Ignites the fuel-air mixture in the engine.
- 14 Shroud lock**
The shroud lock secures the shroud to the chainsaw.
- 15 Hood**
The cover covers the engine.
- 16 Felling notch**
The felling direction can be controlled by the felling notch.
- 17 Spark plug boot**
Connects the ignition lead to the spark plug.
- 18 Air filter**
The air filter filters the air entering the engine.

- 19 Master control lever**
For starting, running and stopping the engine.
- 20 Throttle trigger lockout**
The throttle trigger lockout unlocks the throttle trigger.
- 21 Control handle**
The control handle is used to control, hold and guide the chainsaw.
- 22 Rear hand guard**
The rear hand guard protects the right hand against contact with the saw chain if the chain breaks or comes off the bar.
- 23 Throttle trigger**
The throttle trigger is used to control the engine speed.
- 24 Fuel tank cap**
The fuel tank cap closes the fuel tank.
- 25 Starter grip**
The starter grip is used for starting the engine.
- 26 Oil tank cap**
The oil tank cap closes the oil tank.
- 27 Handlebar**
The handlebar is used to hold, control and carry the chainsaw.
- # Serial number**

3.2 Equipment features

Depending on the respective market, the chainsaw can have the following features:

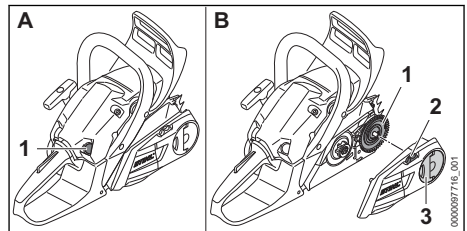

Manual fuel pump (A)

- 1 Manual fuel pump**
The manual fuel pump eases engine starts.

Fast-tensioning device (B)

- 1 Tensioning gear**
The tensioning gear moves the guide bar and thus tensions and slackens the saw chain.
- 2 Adjusting wheel**
The adjusting wheel is used to adjust the chain tension.

3 Wing nut

The wing nut fastens the sprocket cover to the chain saw.

3.3 Symbols

Meanings of icons that may be on the chainsaw:



This icon denotes the fuel tank.



This symbol marks the saw chain oil tank.



Direction in which the chain brake is engaged or released.



This symbol shows the direction of rotation of the saw chain.



Rotate in this direction to increase the saw chain tension



This symbol indicates the manual fuel pump.



Switch the master control lever in this direction to shut the engine off.



Switch the master control lever in this position to shut the engine off.



Switch the master control lever in this position to run the engine.



Switch the master control lever in this position to start the engine.



Switch the master control lever in this position to prepare the engine for startup.



Guaranteed sound power level in accordance with Directive 2000/14/EC in dB(A) for the purpose of comparing the sound emissions of products.

4 Safety Precautions

4.1 Warning Signs

Meanings of warning signs on the chainsaw:



Observe safety notices and take the necessary precautions.



Read, understand and save the instruction manual.



Wear safety glasses, hearing protection and a hard hat.



Observe safety notices on kickback and take the necessary precautions.

4.2 Intended Use

The STIHL MS 182 and MS 212 chainsaws are designed for cutting wood, limbing and felling trees.

▲ WARNING

- Using the chainsaw for purposes for which it is not designed may result in serious or fatal injuries and damage to property.
 - ▶ Always use the chainsaw as described in this User Manual.

4.3 The Operator

▲ WARNING

- Users without adequate training or instruction cannot recognize or assess the risks involved in using the chainsaw. The user or other persons may sustain serious or fatal injuries.



- ▶ Read, understand and save the instruction manual.

- ▶ If the chainsaw is passed on to another person: Always give them the instruction manual.
- ▶ Make sure the user meets the following requirements:
 - The user must be rested.
 - The user must be in good physical condition and mental health to operate and work with the chainsaw. If the user's physical, sensory or mental ability is restricted, he or she may work only under the supervision of or as instructed by a responsible person.
 - The user can identify and assess the dangers of the chainsaw.
 - The user must be of legal age or is being trained in a trade under supervision in accordance with national rules and regulations.
 - The user has received instruction from a STIHL servicing dealer or other experienced user before working with the chainsaw for the first time.
 - The user must not be under the influence of alcohol, medication or drugs.
- ▶ If the user is working with a chainsaw for the first time: Practice cutting logs on a sawhorse or other support.
- ▶ If you have any queries: Contact your STIHL servicing dealer for assistance.

- The chainsaw's ignition system produces an electromagnetic field. This field may interfere with some pacemakers. This can result in serious or fatal injuries.
 - ▶ If the user has a pacemaker: Make sure the pacemaker is not affected.

4.4 Clothing and Equipment

▲ WARNING

- Long hair can become entangled in the saw during operation. This can result in serious injuries.
 - ▶ Tie up long hair so that it is above shoulder level.
- Objects can be thrown through the air at high speed during operation. This can result in personal injury.



- ▶ Wear close-fitting safety glasses. Suitable safety glasses that have been tested and labeled in accordance with EN 166 or national standards are available from retailers.

- ▶ STIHL recommends that you wear a face shield.
- ▶ Wear a long-sleeved, snug-fitting upper garment.
- Noise occurs during operation. Noise can harm your hearing.



- ▶ Wear hearing protection.

- Falling objects can cause head injuries.



- ▶ If there is a danger of falling objects during operation: Wear a safety hard hat.

- Dust can be whipped up during operation: Whipped up dust can damage the respiratory passages and cause allergic reactions.
 - ▶ If dust is whipped up and forms a cloud: Wear a dust respirator mask.
- Inappropriate clothing can snag on wood, brush or the saw. Not wearing suitable clothing may result in serious injury.
 - ▶ Wear snug-fitting clothing.
 - ▶ Do not wear a scarf or jewelry.
- The user can come into contact with the rotating saw chain during operation. This can result in serious injuries.
 - ▶ Wear long trousers with cut-retardant inserts.
- The user can be cut by the wood during operation. The user can come into contact with the saw chain during cleaning and maintenance work. This can result in personal injury.

- ▶ Wear work gloves made of durable material.
- Wearing unsuitable footwear may cause you to slip or stumble. Contact with the rotating saw chain can result in cuts. This can result in personal injury.
 - ▶ Wear chainsaw boots with cut retardant inserts.

4.5 Work Area and Surroundings

▲ WARNING

- Bystanders, children and animals are not aware of the dangers of the chainsaw or thrown objects. Innocent bystanders, children and animals may be seriously injured and damage to property may occur.
 - ▶ Keep bystanders, children and animals away from the work area.
 - ▶ Do not leave the chainsaw unattended.
 - ▶ Make sure that children cannot play with the chainsaw.
- Hot exhaust gas is emitted through the muffler while the engine is running. Hot exhaust gas can ignite easily flammable materials and cause a fire.
 - ▶ Keep exhaust gas well away from easily flammable materials.

4.6 Safe Condition

4.6.1 Chainsaw

The chainsaw is in a safe condition if the following points are observed:

- The chainsaw is not damaged.
- There is no fuel leaking from the chainsaw.
- The fuel tank and oil tank caps are closed.
- The chainsaw is clean.
- The chain catcher is fitted and undamaged.
- The chain brake is operating properly.
- The controls function properly and have not been modified.
- The chain lubrication is operating properly.
- Wear marks on the chain sprocket are not deeper than 0.5 mm.
- A combination of guide bar and saw chain recommended in this User Manual is mounted.
- The guide bar and saw chain are properly mounted.
- The saw chain is properly tensioned.
- Only original STIHL accessories designed for this chainsaw model are fitted.
- The accessories are correctly attached.

▲ WARNING

- If not in safe condition, components may no longer operate correctly, safety devices may be disabled and fuel leakage may occur. This may result in serious or fatal injury to people.
 - ▶ Work only with an undamaged chainsaw.
 - ▶ If fuel is leaking from the chainsaw: Do not use the chainsaw and contact a STIHL dealer for assistance.
 - ▶ Close the fuel tank and oil tank caps.
 - ▶ If the chainsaw is dirty: Clean the chainsaw.
 - ▶ Work only with property fitted and undamaged chain catcher.
 - ▶ Never modify your chainsaw. Exception: Mounting a combination of guide bar and saw chain recommended in this User Manual.
 - ▶ If the controls do not function properly: Do not use your chainsaw.
 - ▶ Only fit original STIHL accessories designed for this chainsaw model.
 - ▶ Mount the guide bar and saw chain as described in this User Manual.
 - ▶ Attach accessories as described in this User Manual or in the User Manual for the accessories.
 - ▶ Never insert objects in the chainsaw's openings.
 - ▶ Replace worn or damaged labels.
 - ▶ If you have any doubts, be sure to consult a STIHL dealer.

4.6.2 Guide Bar

The guide bar is in a safe condition if the following points are observed:

- Guide bar is not damaged.
- Guide bar is not deformed.
- The minimum groove depth is maintained,  19.3.
- Bar rails are free from burrs.
- Bar groove is not pinched or splayed.

▲ WARNING

- If the guide bar is not in a safe condition, it can no longer support and guide the saw chain properly. The rotating saw chain can jump off the guide bar. This can result in serious or fatal injuries.
 - ▶ Work only with an undamaged guide bar.
 - ▶ If the groove depth is less than the minimum depth: Mount a new guide bar.
 - ▶ Deburr the guide bar every week.
 - ▶ If you have any queries: Contact your STIHL servicing dealer.

4.6.3 Saw Chain

The saw chain is in a safe condition if the following points are observed:

- Chain is not damaged.
- Chain is properly sharpened.
- The service marks on the cutters are still visible.

▲ WARNING

- If components do not comply with safety requirements, they will no longer function properly and safety devices may be rendered inoperative. This can result in serious or fatal injuries.
 - ▶ Work only with an undamaged saw chain.
 - ▶ Sharpen the chain properly.
 - ▶ If you have any queries: Contact your STIHL servicing dealer for assistance.

4.7 Fuel Mixture and Refueling

▲ WARNING

- This chainsaw requires a fuel mixture of gasoline and two-stroke engine oil. Mixed fuel and gasoline are extremely flammable. If fuel mixture or gasoline make contact with open fire or hot objects, they can cause a fire or explosions. Persons may be seriously or fatally injured and property may be damaged.
 - ▶ Protect fuel mixture and gasoline from heat and fire.
 - ▶ Do not spill mixed fuel or gasoline.
 - ▶ If fuel has been spilled: Wipe up fuel with a cloth and do not attempt to start engine until all parts of the chainsaw are dry.
 - ▶ Do not smoke.
 - ▶ Never refuel near a fire.
 - ▶ Shut off the engine and allow it to cool down before refueling.
 - ▶ Start the engine at least 3 meters from the fueling spot, outdoors only.
- Inhaling fuel fumes and gasoline fumes can have toxic effects.
 - ▶ Avoid inhaling fuel fumes or gasoline fumes.
 - ▶ Refuel in a well-ventilated location.
- The chainsaw will become hot during operation, or in a very hot environment. Depending on the type of fuel, altitude, ambient temperature and the temperature of the saw, the fuel expands and can cause a build-up of pressure in the tank. Fuel may spray out and ignite when the fuel tank cap is opened. The user may be seriously injured and property damage may occur.

- ▶ Allow the chainsaw to cool down before opening the fuel tank cap.
- ▶ Open the fuel tank cap slowly and not all at once.
- Clothing that has been in contact with fuel or gasoline will become more easy to ignite. Persons may be seriously or fatally injured and property may be damaged.
 - ▶ If your clothing comes into contact with fuel or gasoline: Change your clothing.
- Fuel mix, gasoline and two-stroke engine oil can harm the environment.
 - ▶ Do not spill fuel, gasoline or two-stroke engine oil.
 - ▶ Dispose of fuel mix, gasoline and two-stroke engine oil in accordance with local regulations and environmental requirements.
- Fuel, gasoline or two-stroke engine oil can cause irritation if they come into direct contact with the skin or eyes.
 - ▶ Avoid contact with fuel, gasoline and two-stroke engine oil.
 - ▶ If skin contact occurs: Wash affected areas of skin with plenty of water and soap.
 - ▶ If eye contact occurs: Flush eyes with plenty of water for at least 15 minutes and consult a doctor.
- The ignition system of the chainsaw generates sparks. Unconfined sparks may cause a fire or an explosion in an easily combustible or explosive environment. Persons may be seriously or fatally injured and property may be damaged.
 - ▶ Use the spark plugs described in this instruction manual.
 - ▶ Insert and tighten down the spark plug.
 - ▶ Connect the spark plug boot and press it down firmly.
- The saw can be damaged if it is run on a mixture of fuel which includes unsuitable gasoline or unsuitable two-stroke engine oil, or if an incorrect mix ratio of gasoline and two-stroke engine oil is used.
 - ▶ Mix the fuel as described in this instruction manual.
- The mixture of gasoline and two-stroke engine oil can separate or age if it is stored for a long period. The chainsaw can be damaged if it is used with a fuel mix that has separated or has aged.
 - ▶ Before refueling the saw: Thoroughly mix the fuel.
 - ▶ Use a mixture of gasoline and two-stroke engine oil that is not older than 30 days (STIHL MotoMix: 5 years).

4.8 Working

4.8.1 Sawing

⚠ WARNING

- Always work within calling distance of others
 - ▶ in case help is needed.
- If the engine is not started properly, the user may lose control of the chainsaw. This can result in serious injuries.
 - ▶ Start the engine as described in this instruction manual.
 - ▶ If the saw chain is touching the ground or objects: Do not start the engine.
- The user cannot concentrate on the work in certain situations. The user can lose control of the saw, trip or fall and be seriously injured.
 - ▶ Work calmly and carefully.
 - ▶ If light and visibility are poor: Do not use your saw.
 - ▶ Operate the chain saw alone.
 - ▶ Do not work above shoulder height.
 - ▶ Watch out for obstacles.
 - ▶ Stand on the ground while working and keep a good balance. If it is necessary to work at heights: Use a lift bucket or a safe platform.
 - ▶ If you begin to feel tired: Take a break.
- Exhaust gas is produced when the engine is running. Breathing in exhaust gas can have toxic effects.
 - ▶ Avoid inhaling exhaust gas.
 - ▶ Operate the chainsaw in a well ventilated location.
 - ▶ In the event of nausea, headache, visual disturbances, problems with hearing or dizziness: Stop work and seek medical advice.
- The user's ability to hear and assess noises is restricted when wearing hearing protection with the engine running.
 - ▶ Work calmly and carefully.
- The user will not be able to control the chainsaw properly if it is operated with the Master Control lever in the position **⌘**. This can result in serious injuries.
 - ▶ Move the Master Control lever to position **I**.
 - ▶ Start the engine as described in this instruction manual.
- Do not accelerate the engine with the chain brake engaged since this can damage the chain brake.
 - ▶ Disengage the chain brake before you start cutting.
- The rotating saw chain can cut the operator. This can result in serious injuries.

- ▶ Do not touch the rotating saw chain.
- ▶ If the saw chain is blocked by an object: Shut off the engine and engage the chain brake. Then remove the object causing the blockage.
- The rotating chain becomes hot and expands. If the chain is not lubricated sufficiently and retensioned, it can come off the guide bar or break. This can result in serious injuries and damage to property.
 - ▶ Use special chain oil.
 - ▶ Check chain tension regularly during cutting work. If chain tension is insufficient: Tension the chain.
- If the behavior of the saw changes during operation or feels unusual, it may no longer be in a safe condition. This can result in serious injuries and damage to property.
 - ▶ Stop work and contact your STIHL dealer for assistance.
- Saw vibrations may occur during operation.
 - ▶ Wear gloves.
 - ▶ Take regular breaks.
 - ▶ If signs of circulation problems occur: Seek medical advice.
- Sparks may occur if the rotating chain makes contact with a hard object. Sparks may cause a fire in an easily combustible location. This can result in serious or fatal injuries and damage to property.
 - ▶ Do not work in an easily combustible location.
- Note that the saw chain continues to rotate for a short period after you release the trigger. The rotating saw chain can cut the user. This can result in serious injuries.
 - ▶ Wait for the chain to come to a standstill.

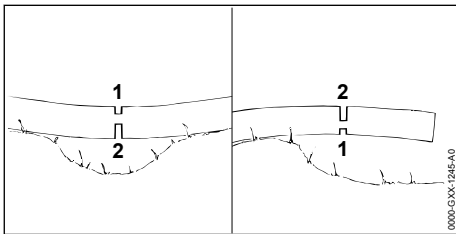

▲ WARNING

- The guide bar can be pinched when cutting wood that is under tension. The user can lose control of the saw and be seriously injured.
 - ▶ Make a relieving cut in the compression side (1) first, then perform bucking cut at the tension side (2).

4.8.2 Limbing

▲ WARNING

- If the underside of the felled tree is limbed first, it will no longer be supported on the ground by branches. The tree can move during cutting work. This can result in serious or fatal injuries.
 - ▶ Cut through large limbs on the underside of the tree only after it has been bucked.
 - ▶ Do not stand on the log while limbing it.
- A branch may fall to the ground during limbing. The user may trip, fall or be seriously injured.
 - ▶ Limb from the base to the crown of the tree.

4.8.3 Felling

▲ WARNING

- Inexperienced users cannot assess the dangers when felling a tree. Persons may be seriously or fatally injured and property may be damaged.
 - ▶ The user needs relevant knowledge of felling technology and experience of felling work.
 - ▶ If anything is unclear, consult an experienced expert for assistance and to determine the appropriate felling technique.
- A tree and branches can fall on bystanders or objects during felling. The larger the falling parts are, the greater the risk of serious or fatal injury to people. Damage to property may occur.
 - ▶ Determine direction of fall so that the area in which the tree falls is clear.
 - ▶ Do not allow bystanders, children or animals within 2.5 tree lengths of the work area.
 - ▶ Remove broken or dead branches from the tree crown before felling.
 - ▶ If bent or withered branches cannot be removed from the tree crown, consult an experienced expert for assistance and to determine the appropriate felling technique.
 - ▶ Be aware of the tree crown and crowns of neighboring trees, and keep clear of falling branches.
- When the tree falls the trunk could break or spring back in the direction of the user. This may result in serious or fatal injury to the user.
 - ▶ Plan a sideways escape path behind the tree.
 - ▶ Walk backwards along the escape path and observe the falling tree.
 - ▶ Do not walk backwards down slopes.

- Obstacles in the work area and on the escape path can hinder the user. The user may trip and fall. This may result in serious or fatal injury to the user.
 - ▶ Remove all obstacles from the work area and escape path.
- If you cut into or through the hinge, stabilizing strap or holding strap too soon, the intended direction of fall cannot be controlled or the tree may fall prematurely. Persons may be seriously or fatally injured and property may be damaged.
 - ▶ Do not cut into or through the hinge.
 - ▶ Cut through the stabilizing strap or holding strap last.
 - ▶ If the tree begins to fall too soon: Abandon the felling cut and retreat along the escape path.
- Kickback can occur if the rotating chain in the upper quadrant of the bar nose makes contact with a hard felling wedge and is suddenly braked. There is a risk of serious or fatal injury.
 - ▶ Use aluminum or plastic felling wedges.
- If the tree does not fall all the way to the ground or gets caught on another tree, the operator cannot finish the operation in a controlled manner.
 - ▶ Stop the felling operation and use a cable winch or suitable vehicle to pull the tree to the ground.

4.9 Reactive Forces

4.9.1 Kickback

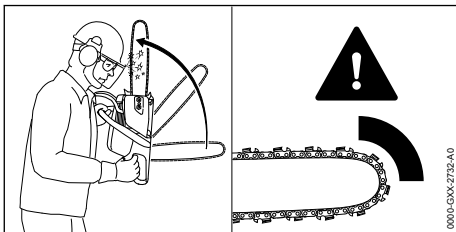

Kickback can be caused for the following reasons:

- The rotating saw chain in the upper quadrant of the bar nose makes contact with a hard object and is suddenly braked.
- The rotating saw chain is pinched at the bar nose.

The chain brake cannot prevent kickback.

▲ WARNING

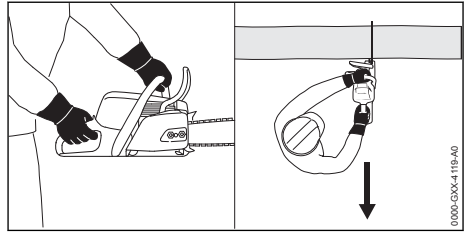

- If kickback occurs, the saw can be thrown up in the direction of the operator. The operator can lose control of the saw and be seriously or fatally injured.
 - ▶ Hold the saw firmly with both hands.
 - ▶ Always keep your body out of the plane of the cutting attachment.
 - ▶ Use the working techniques described in this instruction manual.
 - ▶ Do not cut with the upper quadrant of the bar nose.
 - ▶ Always cut with a properly sharpened and tensioned saw chain.
 - ▶ Use a reduced kickback saw chain.
 - ▶ Use a guide bar with a narrow radius nose.
 - ▶ Always cut with the chain running at full speed.

4.9.2 Pull-in

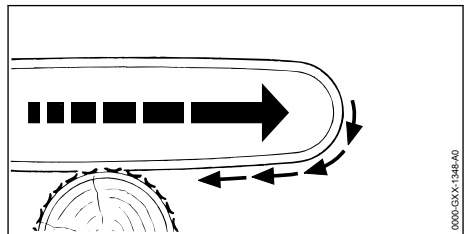

The saw is pulled away from the operator when the bottom of the bar is used for cutting.

▲ WARNING

- If the rotating chain makes contact with a hard object and is suddenly pinched, the saw is abruptly jerked away from the operator. The operator can lose control of the saw and be seriously or fatally injured.
 - ▶ Hold the saw firmly with both hands.
 - ▶ Operate the saw as described in this instruction manual.
 - ▶ Keep the guide bar straight in the cut.
 - ▶ Apply the spiked bumper properly.
 - ▶ Always cut with the chain running at full speed.

4.9.3 Pushback

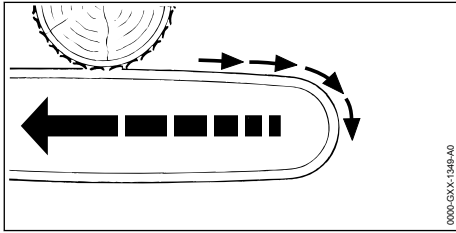

The saw is pushed back toward the operator when the top of the bar is used for cutting.

▲ WARNING

- If the rotating chain makes contact with a hard object and is suddenly pinched, the saw can be abruptly pushed back toward the operator. The operator can lose control of the saw and be seriously or fatally injured.
 - ▶ Hold the saw firmly with both hands.
 - ▶ Operate the saw as described in this instruction manual.
 - ▶ Keep the guide bar straight in the cut.
 - ▶ Always cut with the chain running at full speed.

4.10 Transport

▲ WARNING

- The saw may turn over or shift during transport. This may result in serious injury to people and damage to property.
 - ▶ Shut off the engine.
 - ▶ Engage the chain brake.
 - ▶ Fit the chain scabbard so that it completely covers the guide bar.
 - ▶ Secure the chainsaw with lashing straps, belts or a net to prevent it turning over and moving.

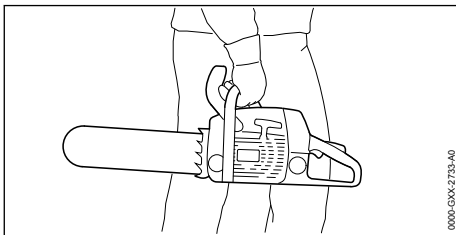

- The muffler and engine may be hot after a period of operation. There is a risk of burn injuries.
 - ▶ Carry the chainsaw by holding the front handle in your right hand with the guide bar pointing to the rear.

4.11 Storing

▲ WARNING

- Children are not aware of and cannot assess the dangers of a chainsaw and can be seriously injured.
 - ▶ Shut off the engine.
 - ▶ Engage the chain brake.
 - ▶ Fit the scabbard so that it completely covers the guide bar.
 - ▶ Store the saw out of the reach of children.
- Dampness can corrode the electrical contacts on the saw and metal components. This can damage the saw.
 - ▶ Store the saw in a clean and dry condition.

4.12 Cleaning, Maintenance and Repair

▲ WARNING

- The saw chain can start up unintentionally if the engine is running during cleaning, maintenance or repair operations. This may result in serious injury to people and damage to property.
 - ▶ Shut off the engine.
 - ▶ Engage the chain brake.
- The muffler and engine may be hot after a period of operation. This can result in burn injuries.
 - ▶ Wait until the muffler and engine cool down.
- Aggressive cleaning agents, a water jet or pointed objects can damage the chainsaw, guide bar and saw chain. If the chainsaw, guide bar or saw chain are not cleaned correctly, components may no longer function properly or safety devices may be rendered inoperative. They may cause serious injury to persons.
 - ▶ Clean the chainsaw, guide bar and saw chain as described in this user manual.
- If the chainsaw is not maintained as described in this user manual, components may no longer function properly or safety devices may be rendered inoperative. This may result in serious or fatal injury to people.
 - ▶ Service or repair the chainsaw as described in this user manual.
- If the guide bar and saw chain are not maintained or repaired as described in this user manual, components may no longer function properly or safety devices may be rendered inoperative. They may cause serious injury to persons.

- ▶ Service or repair the guide bar and saw chain as described in this User Manual.
- The user may be cut by the sharp cutters while cleaning or servicing the saw chain. This may result in injury to the user.
 - ▶ Wear work gloves made from resistant material.

5 Preparing the Saw for Operation

5.1 Preparing the Saw for Operation

Perform the following steps before starting work:

- ▶ Make sure the following components are in a safe condition:
 - Chainsaw, 4.6.1.
 - Guide bar, 4.6.2.
 - Saw chain, 4.6.3.
- ▶ Clean the saw, 15.1.
- ▶ Mount the bar and chain, 6.1.
- ▶ Tension the saw chain, 6.2.
- ▶ Fill up with chain oil, 6.3.
- ▶ Check the chain brake, 10.4.
- ▶ Refuel the saw, 8.2.
- ▶ Check the controls, 10.5.
- ▶ Check chain lubrication, 10.6.
- ▶ If you cannot carry out these steps: Do not use your chainsaw and contact your STIHL servicing dealer for assistance.

6 Assembling the Saw

6.1 Mounting and Removing the Bar and Chain

6.1.1 Mounting the Guide Bar and Saw Chain

The guide bar and saw chain combinations that can be used with the chain sprocket are listed in the specifications, 20.1.

- ▶ Shut off the engine and engage the chain brake.

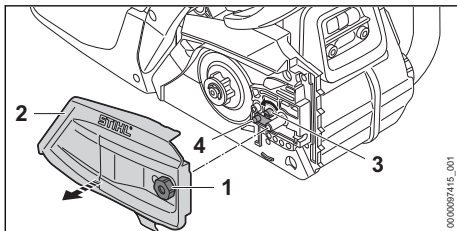

- ▶ Rotate the nut (1) counterclockwise until the chain sprocket cover (2) can be removed.

- ▶ Remove the chain sprocket cover (2).
- ▶ Turn the tensioning screw (3) counterclockwise until the tensioner slide (4) butts against the left end of the housing.

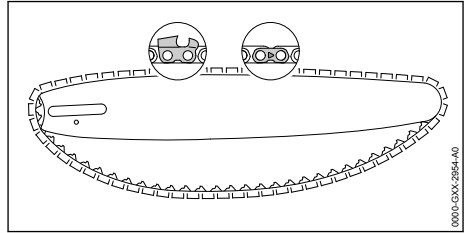

- ▶ Fit the saw chain in the guide bar groove so that the arrows on the tie straps on the top of the bar point in the direction of rotation.

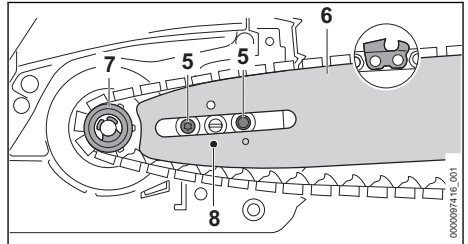

- ▶ Fit the guide bar and saw chain on the chainsaw and check the following points:
 - The drive links of the saw chain are seated in teeth of the chain sprocket (7).
 - The collar studs (5) are located in slot in tail of guide bar (6).
 - The peg of tensioner slide (4) engages the hole (8) in guide bar (6).

The guide bar (6) may be fitted either way round. The logo on the guide bar (6) may also be upside down.

- ▶ Disengage the chain brake.

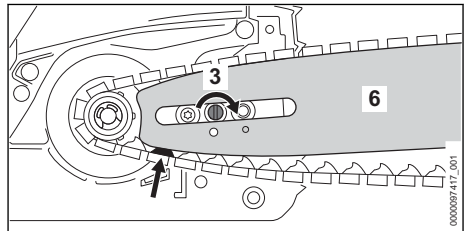

- ▶ Turn the tensioning screw (3) clockwise until the saw chain fits snugly against the guide bar. Make sure the drive links of the saw chain engage the guide bar groove. The guide bar (6) and saw chain are positioned against the chainsaw.

- ▶ Fit the chain sprocket cover (2) so that it is flush with the chainsaw.
- ▶ Fit the nut (1) and tighten it down firmly.

6.1.2 Mounting the Guide Bar and Saw Chain (Quick Chain Tensioner)

The guide bar and saw chain combinations that can be used with the chain sprocket are listed in the specifications,  20.1.

- ▶ Shut off the engine and engage the chain brake.

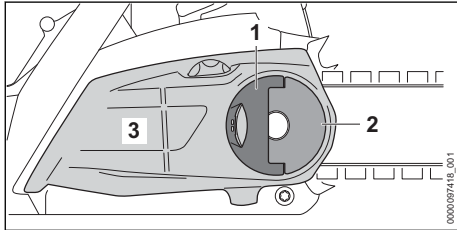

- ▶ Open the handle (1) of the wing nut (2).
- ▶ Rotate the wing nut (2) counterclockwise until the chain sprocket cover (3) can be removed.
- ▶ Remove the chain sprocket cover (3).

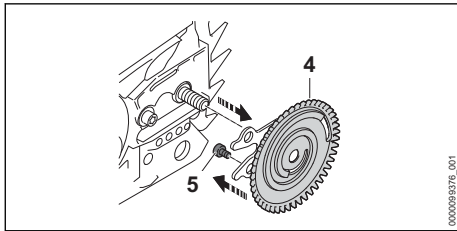

- ▶ Remove the tensioning gear (4).
- ▶ Remove the screw (5).

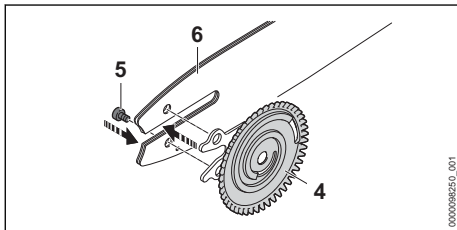

- ▶ Place the guide bar (6) on the tensioning gear (4) so that both pegs of the tensioning gear (4) sit in the bores of the guide bar.

The guide bar (6) may be fitted either way round. The logo on the guide bar may also be upside down.

- ▶ Insert and tighten down the screw (5) firmly.

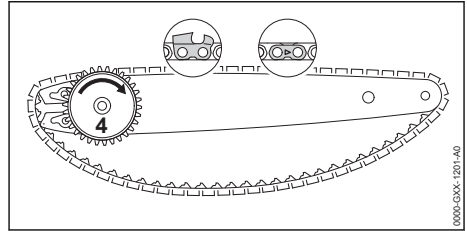

- ▶ Fit the saw chain in the guide bar groove so that the arrows on the tie straps on the top of the bar point in the direction of rotation.
- ▶ Turn the tensioning gear (4) clockwise as far as it will go.

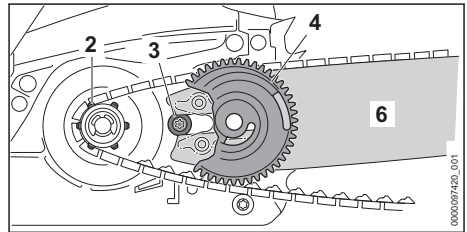

- ▶ Fit the guide bar with tensioning gear and saw chain on the saw and check the following points:
 - The tensioning gear (4) points towards the user.
 - The drive links of the saw chain are seated in teeth of the chain sprocket (2).
 - The head of screw (3) is seated in the slot in the guide bar (6).

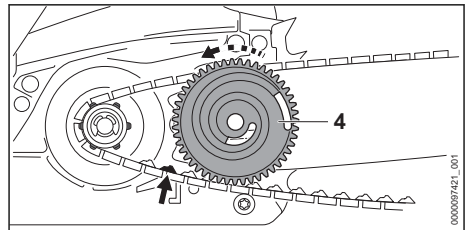

- ▶ Disengage the chain brake.
- ▶ Rotate the tensioning gear (4) counterclockwise until the saw chain fits snugly against the guide bar. Make sure the drive links of the saw chain engage the guide bar groove. The guide bar and saw chain are positioned against the chainsaw.
- ▶ Fit the chain sprocket cover so that it is flush with the chainsaw.

- ▶ If the chain sprocket cover is not flush with the chainsaw: Twist the adjusting wheel and reposition the chain sprocket cover. The teeth of the adjusting wheel engage with the teeth of the tensioning gear.
- ▶ Rotate the wing nut clockwise until the chain sprocket cover sits tightly at the chainsaw.
- ▶ Close the handle of the wing nut.

6.1.3 Removing the Guide Bar and Saw Chain

- ▶ Shut off the engine and engage the chain brake.
- ▶ Rotate the nut counterclockwise until the chain sprocket cover can be removed.
- ▶ Remove the chain sprocket cover.
- ▶ Turn the tensioning screw counterclockwise as far as it will go. The saw chain is now slack.
- ▶ Remove the guide bar and saw chain.

6.1.4 Removing the Guide Bar and Saw Chain (Quick Chain Tensioner)

- ▶ Shut off the engine and engage the chain brake.
- ▶ Open the handle of the wing nut.
- ▶ Rotate the wing nut counterclockwise until the chain sprocket cover can be removed.
- ▶ Remove the chain sprocket cover.
- ▶ Turn the tensioning gear clockwise as far as it will go. The saw chain is now slack.
- ▶ Remove the guide bar and saw chain.
- ▶ Remove the screw of the tensioning gear.
- ▶ Remove the tensioning gear.

6.2 Tensioning the Chain

6.2.1 Tensioning the Saw Chain

The saw chain expands or contracts during cutting work. The saw chain tension changes as a result. Check the saw chain tension regularly during operation and readjust if necessary.

- ▶ Shut off the engine and engage the chain brake.

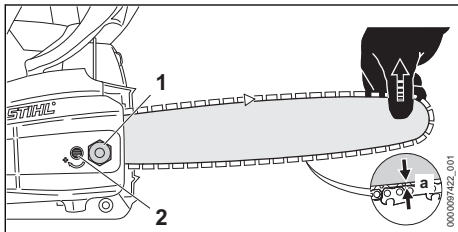

- ▶ Loosen the nuts (1).
- ▶ Disengage the chain brake.

- ▶ Hold the guide bar nose up and turn the tensioning screw (2) clockwise or counterclockwise until the following points apply:
 - The chain sag 'a' in the center of the guide bar is 1 - 2 mm.
 - The saw chain can still be pulled easily along the guide bar with two fingers.
- ▶ Keep holding the guide bar nose up and tighten down the nuts (1) firmly.
- ▶ If the chain sag distance 'a' in the center of the guide bar is not 1-2 mm: Readjust the saw chain tension.

6.2.2 Tensioning the Saw Chain (Quick Chain Tensioner)

The saw chain expands or contracts during cutting work. The saw chain tension changes as a result. Check the saw chain tension regularly during operation and readjust if necessary.

- ▶ Shut off the engine and engage the chain brake.

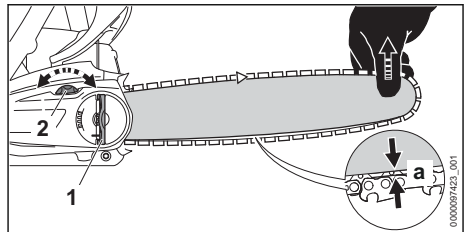

- ▶ Open the handle of the wing nut (1).
- ▶ Back off the wing nut (1) 2 turns counterclockwise. You have loosened the wing nut (1).
- ▶ Disengage the chain brake.
- ▶ Hold the guide bar nose up and turn the adjusting wheel (2) clockwise or counterclockwise until the following points apply:
 - The chain sag 'a' in the center of the guide bar is 1 - 2 mm.
 - The saw chain can still be pulled easily along the guide bar with two fingers.
- ▶ Continue holding the guide bar nose up and turn the wing nut (1) clockwise until the chain sprocket cover sits tightly against the chainsaw.
- ▶ If the chain sag 'a' in the center of the guide bar is not 1 - 2 mm: Readjust the saw chain tension.
- ▶ Fold in the handle of the wing nut (1).

6.3 Filling Up with Saw Chain Oil

The saw chain oil lubricates and cools the rotating chain.

STIHL recommends you use a STIHL saw chain oil or an equivalent chain oil approved for chainsaws.

- ▶ Shut off the engine and engage the chain brake.
- ▶ Place your chainsaw on a level surface so that the oil tank cap faces up.
- ▶ Use a damp cloth to clean the oil tank cap and the area around it.

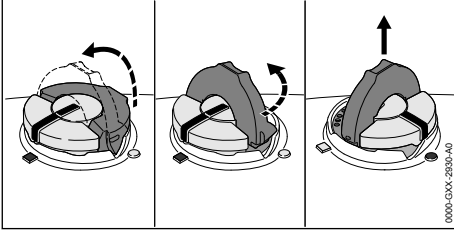

- ▶ Swing the grip on the oil tank cap to the vertical position.
- ▶ Turn the oil tank cap counterclockwise as far as it will go.
- ▶ Remove the oil tank cap.
- ▶ Fill up with saw chain oil, taking care not to spill any oil and not to overfill the tank.
- ▶ If the grip on the oil tank cap has dropped into the closed position: Raise the grip until it is vertical.

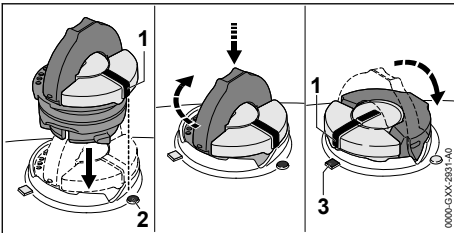

- ▶ Place the oil tank cap in the filler opening so that mark (1) lines up with mark (2).
- ▶ Press the oil tank cap down and rotate it clockwise as far as it will go. The oil tank cap snaps into place. The mark (1) points to mark (3).
- ▶ Check to see if the oil tank cap can be pulled upwards and off.
- ▶ If the oil tank cap cannot be pulled upwards and off: Fold down the grip on the oil tank cap. The oil tank is closed.

If the oil tank cap can be pulled upwards and off, perform the following steps:

- ▶ Place the oil tank cap in the filler opening – in any position.

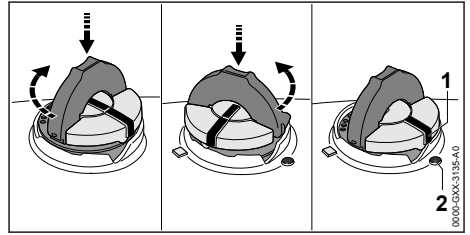

- ▶ Press the oil tank cap down and rotate it clockwise as far as it will go.
- ▶ Press the oil tank cap down and rotate it counterclockwise until mark (1) points to mark (2).
- ▶ Now try again to close the oil tank.
- ▶ If the oil tank still cannot be closed properly: Do not use the chainsaw and contact a STIHL dealer for assistance. The chainsaw is not in a safe condition.

6.4 Mounting the Spiked Bumper

- ▶ Remove the guide bar and saw chain.

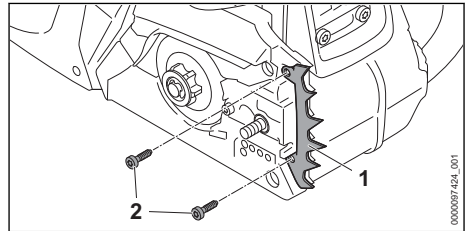

- ▶ Position the spiked bumper (1).
- ▶ Insert the screws (2) and tighten them firmly.

Do not remove the spiked bumper (1).

7 Engaging and Disengaging the Chain Brake

7.1 Engaging the Chain Brake

The saw is equipped with a chain brake.

The chain brake is activated by the inertia of the front hand guard if the kickback force is high enough or can be engaged by the operator.

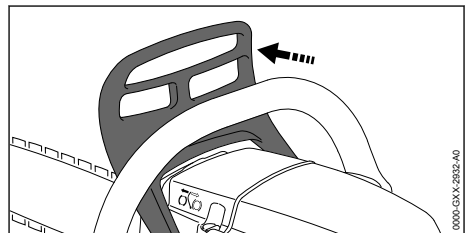

- ▶ Push the hand guard away from the front handle with your left hand.
The hand guard engages with an audible click.
The chain brake is engaged.

7.2 Disengaging the Chain Brake

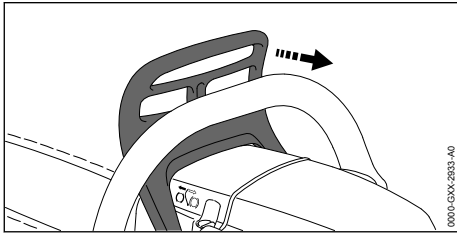

- ▶ Pull the hand guard toward the front handle with your left hand.
The hand guard engages with an audible click.
The chain brake is disengaged.

8 Mixing Fuel and Refueling the Chainsaw

8.1 Mixing fuel

The fuel required for this chainsaw is a mixture of two-stroke engine oil and gasoline, in a mixing ratio of 1:50.

STIHL recommends you use STIHL MotoMix.

If you mix the fuel yourself, use only STIHL two-stroke engine oil or another high-performance engine oil in accordance with JASO FB, JASO FC, JASO FD, ISO-L-EGB, ISO-L-EGC or ISO-L-EGD.

STIHL specifies STIHL HP Ultra two-stroke engine oil or an equivalent high-performance engine oil in order to maintain emission limits over the machine's service life.

- ▶ Make sure that the octane number of the gasoline is at least 90 RON and the ethanol content is not more than 10% (for Brazil: 27%).
- ▶ Make sure the two-stroke engine oil you are using meets the requirements.
- ▶ Depending on the desired amount of fuel, determine the correct amounts of two-stroke engine oil and gasoline in a mixing ratio of 1:50. Examples for fuel mixes:
 - 20 ml Two-stroke engine oil, 1 l gasoline
 - 60 ml Two-stroke engine oil, 3 l gasoline
 - 100 ml Two-stroke engine oil, 5 l gasoline
- ▶ Pour two-stroke engine oil into a clean approved fuel canister first and then add gasoline.
- ▶ Thoroughly mix the fuel before topping up.

8.2 Filling up the Chainsaw with Fuel

- ▶ Shut off the engine and engage the chain brake.
- ▶ Allow the chainsaw to cool down.
- ▶ Place your chainsaw on a level surface so that the fuel tank cap faces up.
- ▶ Use a damp cloth to clean the fuel tank cap and the area around it.
- ▶ Fold out the handle on the fuel tank cap.

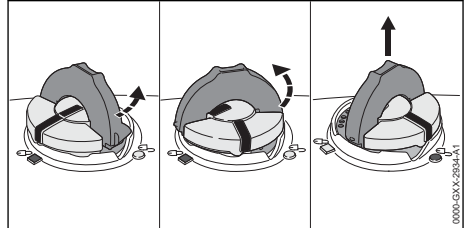

! WARNING

- The chainsaw will become hot during operation, or in a very hot environment. Depending on the type of fuel, altitude, ambient temperature and the temperature of the saw, the fuel expands and can cause a build-up of pressure in the tank. Fuel may spray out and ignite when the fuel tank cap is opened. The user may be seriously injured and property damage may occur.
 - ▶ Allow the chainsaw to cool down before opening the fuel tank cap.
 - ▶ Open the fuel tank cap slowly and not all at once.
- ▶ Turn the fuel tank cap about 1/8-of-a-turn counterclockwise.
If the fuel tank is under pressure, you will hear the overpressure being released.
- ▶ When the tank is no longer under pressure: Turn the fuel tank cap counterclockwise until the marks on the cap and fuel tank are in alignment.
- ▶ Remove the fuel tank cap.

NOTICE

- Exposure to light, direct sunlight and extreme temperatures may accelerate fuel separation or aging. Topping the chainsaw up with unmixed or older fuel may damage the chainsaw.
 - ▶ Thoroughly mix the fuel before topping up.
 - ▶ Do not top up with fuel stored for more than 30 days (STIHL MotoMix: 5 years).

- ▶ When topping up, ensure that no fuel is spilled and that the fuel level remains at least 15 mm under the edge of the tank.
- ▶ If the handle on the fuel tank cap has dropped into the closed position: Fold out the handle.

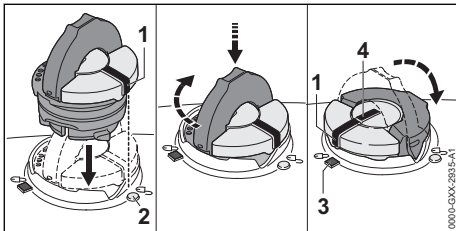

- ▶ Place the fuel tank cap in the filler opening so that mark (1) lines up with mark (2).
- ▶ Press the fuel tank cap down and rotate it clockwise until it stops.
The fuel tank cap snaps into place. Mark (1) is in line with mark (4) and points to mark (3).
- ▶ Check to see if the fuel tank cap can be pulled up and off.
- ▶ If the fuel tank cap cannot be pulled up and off: Fold the handle flat to the top of the cap. The fuel tank is closed.

If the fuel tank cap can be pulled up and off, perform the following steps:

- ▶ Place the fuel tank cap in the filler opening – in any position.

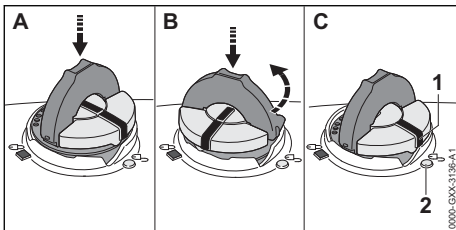

- ▶ Press the fuel tank cap down and rotate it clockwise until it stops.
- ▶ Press the cap down and rotate it counterclockwise until mark (1) points to mark (2).
- ▶ Now try again to close the fuel tank.

- ▶ If the fuel tank still cannot be closed properly: Do not use the chainsaw and contact a STIHL dealer for assistance.
The chainsaw is not in a safe condition.

9 Starting and Stopping the Engine

9.1 Selecting the correct starting procedure

When must the engine be prepared for starting?

The engine must be prepared for starting if one of the following conditions apply:

- The engine is at ambient temperature.
- The engine stopped when accelerated for the first time.
- The engine stopped because the fuel tank was empty.
- ▶ Prepare engine for start, [9.2](#) and then start the engine, [9.3](#).

When can the engine be started without preparation?

The engine can be started without preparation if it has been running for at least 1 minute and only shut down for a short work break.

- ▶ Starting the engine, [9.3](#).

9.2 Preparing the engine for start

- ▶ Select the correct starting procedure.

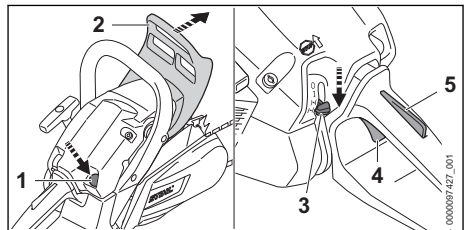

- ▶ Engage the chain brake (2).
- ▶ If manual fuel pump (1) is fitted: Press the manual fuel pump (1) at least 10 times.
- ▶ Press the throttle trigger lockout (5) and keep pressed.
- ▶ Press the throttle trigger (4) and keep pressed.
- ▶ Move the Master Control Lever (3) to position **I**.

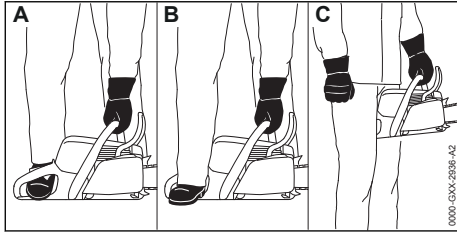

- ▶ Hold the chainsaw tight using of the three possible options:
 - Place the chainsaw on level ground. Hold the saw firmly on the ground with your left hand on the handlebar – your thumb should be under the handlebar. Put the toe of your right boot into the rear handle and press down.
 - Place the chainsaw on level ground. Hold the saw firmly on the ground with your left hand on the handlebar – your thumb should be under the handle. Put the heel of your right boot into the rear handle and press down.
 - Hold the chainsaw firmly with your left hand on the handlebar – your thumb should be under the handle. Hold the rear handle tightly between your legs, just above the knees.



- ▶ Pull the starter grip slowly with your right hand until you feel it engage.
- ▶ Pull the starter grip quickly and allow the starter rope to rewind several times until the engine fires and stops.
 - ▶ If the engine stalled because the fuel tank was empty: Pull out the starter grip not more than 5 times.

9.3 Starting the engine

- ▶ Select the correct starting procedure.

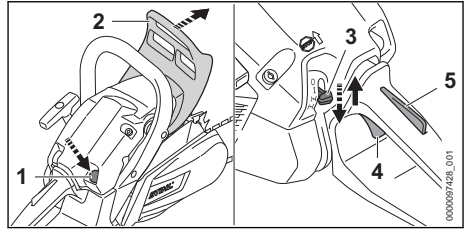

- ▶ Engage the chain brake (2).
- ▶ Pull off the chain scabbard.
- ▶ If manual fuel pump (1) is fitted: Press the manual fuel pump (1) at least 10 times.
- ▶ Press the throttle trigger lockout (5) and keep pressed.
- ▶ Press the throttle trigger (4) and keep pressed.
- ▶ Move the Master Control Lever (3) to position **I**.
- ▶ Release the throttle trigger lockout (5) and throttle trigger (4).
- ▶ Move the Master Control Lever (3) to position **II**.

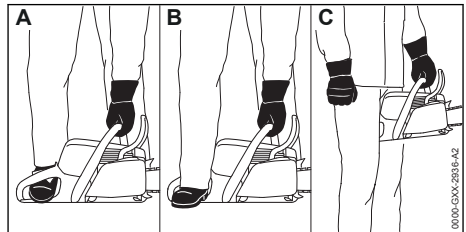

- ▶ Hold the chainsaw using one of the three possible options:
 - Place the chainsaw on level ground. Hold the saw firmly on the ground with your left hand on the handlebar – your thumb should be under the handlebar. Put the toe of your right boot into the rear handle and press down.
 - Place the chainsaw on level ground. Hold the saw firmly on the ground with your left hand on the handlebar – your thumb should be under the handle. Put the heel of your right boot into the rear handle and press down.
 - Hold the chainsaw firmly with your left hand on the handlebar – your thumb should be under the handle. Hold the rear handle tightly between your legs, just above the knees.

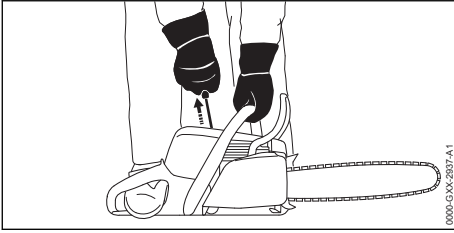

- ▶ Pull the starter grip slowly with your right hand until you feel it engage.
- ▶ Pull the starter grip quickly and allow the starter rope to rewind several times until the engine runs.
- ▶ Press the throttle trigger lockout (5) and keep pressed.
- ▶ Blip the throttle trigger (4). The master control lever (3) springs to position **I**. The engine runs at idling speed.

NOTICE

- Do not accelerate the engine with the chain brake engaged since this can damage the chain brake.
 - ▶ Disengage the chain brake before you start cutting.
-
- ▶ Disengage the chain brake. The chainsaw is ready for use.
 - ▶ If the saw chain rotates while the engine is idling: See troubleshooting. Idle speed adjustment is not correct.
 - ▶ If the engine does not start: Prepare the engine for the start and then try again to start the engine.

9.4 Shut off the engine

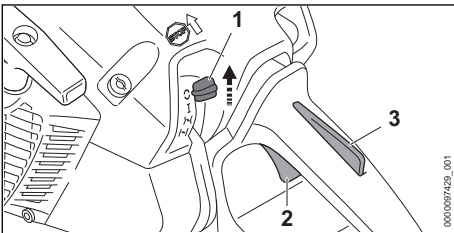

- ▶ Release the throttle trigger (2) and throttle trigger lockout (3). The engine runs at idling speed.
- ▶ Move the Master Control Lever (1) to position **C**. The engine stops and the Master Control lever (1) springs back to position **I**.
- ▶ If the engine does not stop:

- ▶ Move the Master Control Lever to position **I**. The engine stops.
- ▶ Do not use the chainsaw. Consult a STIHL dealer. The Master Control lever is defective.

10 Checking the Saw

10.1 Checking the Chain Sprocket

- ▶ Shut off the engine.
- ▶ Disengage the chain brake.
- ▶ Remove the chain sprocket cover.
- ▶ Remove the guide bar and saw chain.

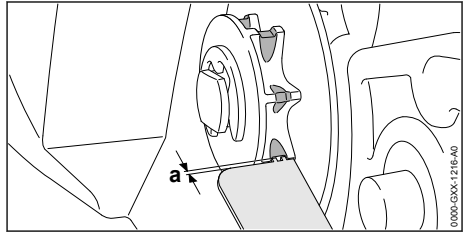

- ▶ Use a STIHL gauge to check the wear marks on the chain sprocket.
- ▶ If wear marks are deeper than $a = 0.5 \text{ mm}$: Do not use your chainsaw and contact your STIHL dealer for assistance. The chain sprocket must be replaced.

10.2 Checking the Guide Bar

- ▶ Shut off the engine and engage the chain brake.
- ▶ Remove the chain and guide bar.

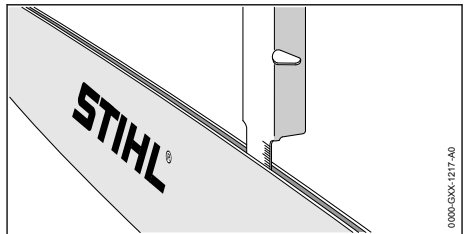

- ▶ Measure depth of bar groove with scale on STIHL filing gauge.
- ▶ Install a new guide bar if one of the following points applies:
 - Guide bar is damaged.
 - Measured bar groove depth is less than specified minimum depth, **19.3**.
 - Bar groove is pinched or splayed.
- ▶ If you have any queries: Contact your STIHL servicing dealer for assistance.

10.3 Checking the Saw Chain

- ▶ Shut off the engine and engage the chain brake.

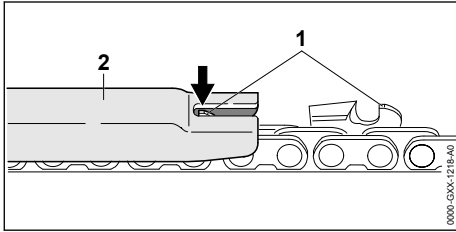

- ▶ Use a STIHL filing gauge (2) to check the height of the depth gauges (1). The STIHL filing gauge must match the chain pitch.
- ▶ If a depth gauge (1) projects from the filing gauge (2): Lower the depth gauge (1),  16.3.

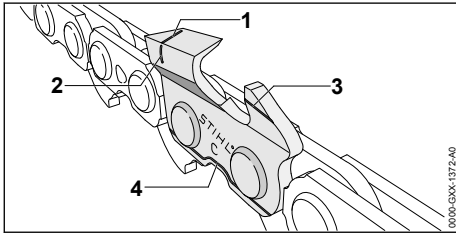

- ▶ Make sure the service marks (1 to 4) on the cutters are visible.
- ▶ If one of the service marks is not visible on a cutter: Do not use your chainsaw and contact your STIHL servicing dealer for assistance.
- ▶ Use a STIHL filing gauge to check that a filing angle of 30° has been maintained on all cutters. The STIHL filing gauge must match the chain pitch.
- ▶ If a filing angle of 30° has not been maintained: Resharpener the saw chain.
- ▶ If you have any queries: Contact your STIHL servicing dealer for assistance.

10.4 Testing the Chain Brake

- ▶ Shut off the engine and engage the chain brake.

WARNING

- The chain's cutters are very sharp. There is a risk of cut injuries.
 - ▶ Wear work gloves made of durable material.
- ▶ Try to pull the chain along the guide bar by hand.
 - If the chain cannot be pulled along the bar by hand, the chain brake is functioning.



- ▶ If the chain can be pulled along the bar by hand: Do not use your chainsaw and contact your STIHL servicing dealer for assistance. The chain brake is defective.

10.5 Checking the Controls

Throttle trigger lockout and throttle trigger

- ▶ Shut off the engine and engage the chain brake.
- ▶ Attempt to pull the trigger without depressing the lockout lever.
- ▶ If the trigger can be pulled: Do not use your chainsaw and contact your STIHL servicing dealer for assistance. There is a malfunction in the throttle trigger lockout.
- ▶ Press down the throttle trigger lockout and hold it there.
- ▶ Pull the throttle trigger and release it again.
- ▶ If the throttle trigger is stiff or does not spring back to its idle position: Do not use your chainsaw and contact your STIHL servicing dealer for assistance. The throttle trigger is defective.

Stopping the engine

- ▶ Start the engine.
- ▶ Move the Master Control lever to position . The engine stops and the Master Control lever springs back to position .
- ▶ If the engine does not stop:
 - ▶ Move the Master Control lever to position . The engine stops.
 - ▶ Do not use your chainsaw and contact your STIHL servicing dealer for assistance. The Master Control lever is defective.

10.6 Checking Chain Lubrication

- ▶ Start the engine and disengage the chain brake.
- ▶ Hold the guide bar over a light surface.
- ▶ Open the throttle.
 - Chain oil is thrown off the chain and is visible on the light surface. Chain lubrication is operating properly.
- ▶ If no chain oil can be seen:
 - ▶ Shut off the engine.
 - ▶ Fill up with chain oil.
 - ▶ Check chain lubrication again.
 - ▶ If chain oil is still not visible on the light surface: Do not use your chainsaw and contact your STIHL servicing dealer for assistance. Chain lubrication is defective.

11 Operating the Saw

11.1 Adjusting the carburetor setting for working at high altitude

If you use the chainsaw at high altitude, the engine may no longer deliver optimum power. The carburetor settings can be adjusted to ensure that the chainsaw delivers optimum power.

- ▶ Start the engine and release the chain brake.
- ▶ Warm up the engine by opening and closing the throttle for about 1 minute.

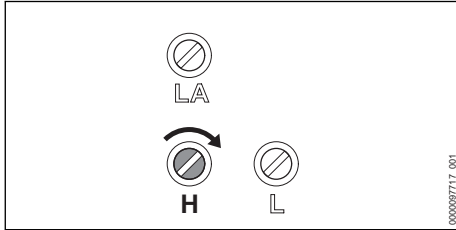

NOTICE

- If the chainsaw is later used at a low altitude, the engine may overheat.
 - ▶ Adjust to standard setting.
- ▶ Rotate the high speed screw H clockwise until the chainsaw delivers optimum power.

11.2 Adjusting the carburetor settings for working at temperatures of below -10 °C

The engine will not accelerate properly if the chainsaw is used at temperatures below -10 °C. The carburetor settings can be adjusted to ensure that the engines accelerates properly.

- ▶ Start the engine and release the chain brake.
- ▶ Warm up the engine by opening and closing the throttle for about 1 minute.

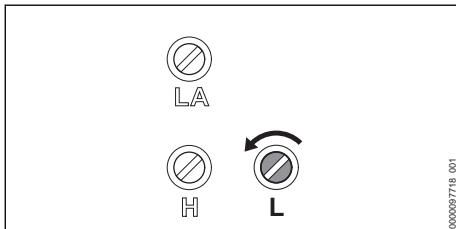

NOTICE

- Engine power may drop noticeably when the chainsaw is subsequently used at temperatures above -10 °C.
 - ▶ Adjust to standard setting.
- ▶ Turn the low speed screw L 1/4 of a turn counterclockwise.
- ▶ If the saw chain runs continuously or the engine stops: Adjust idle speed.

11.3 Holding and Controlling the Chainsaw

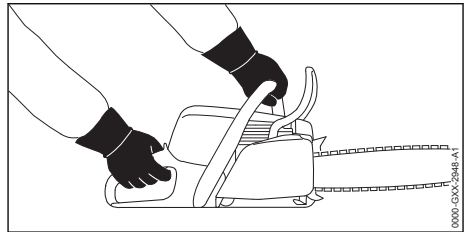

- ▶ Hold and control your chainsaw with your left hand on the handlebar and your right hand on the control handle. Wrap thumb of left hand around the handlebar and thumb of right hand around the control handle.

11.4 Sawing

! WARNING

- If kickback occurs, the chainsaw can be thrown up in the direction of the operator. This may result in serious or fatal injury to the user.
 - ▶ Always cut with the chain running at full speed.
 - ▶ Do not cut with the upper quadrant of the guide bar nose.
- ▶ Begin the cut with the chain running at full speed and keep the guide bar vertical.

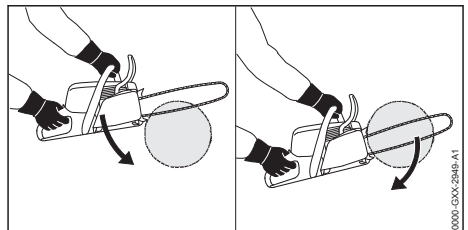

- ▶ Engage the spiked bumper and use it as a fulcrum.

- ▶ Guide the full width of the guide bar into the wood and reposition the spiked bumper as required.
- ▶ Take the weight of the chainsaw at the end of the cut.

11.5 Limbing

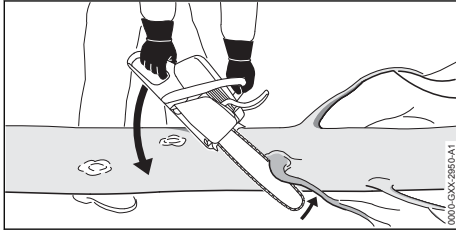

- ▶ Support the chainsaw on the log.
- ▶ With the chain running at full speed, pivot the guide bar downward against the limb.
- ▶ Cut through the limb with the top of the guide bar.

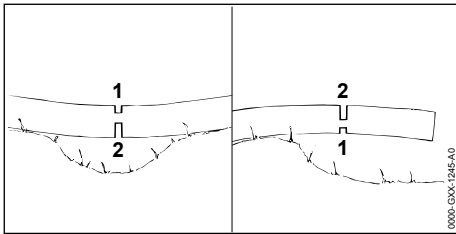

- ▶ If the limb is under tension: Make the relieving cut (1) at the compression side and then perform the bucking cut (2) from the tension side.

11.6 Felling

11.6.1 Determining direction of fall and escape path

- ▶ Determine direction of fall so that the area in which the tree falls is clear.

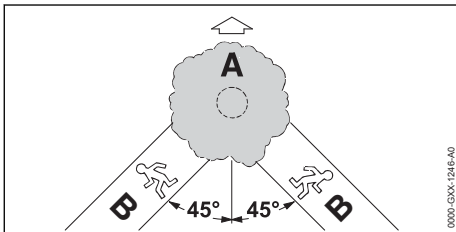

- ▶ Observe the following points when planning escape path (B):
 - Escape path (B) at an angle of 45° to direction of fall (A).
 - No obstacles on the escape path (B).

- The top of the tree can be observed.
- If the escape path (B) is on a slope, it must be parallel to the slope.

11.6.2 Preparing work area at base of tree

- ▶ Remove obstacles from work area at tree base.
- ▶ Remove growth from tree base.

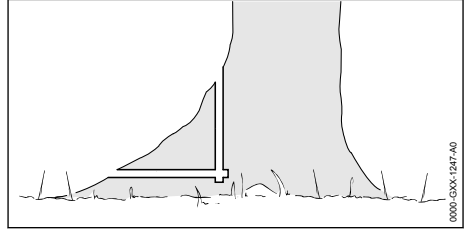

- ▶ If the tree has large, healthy buttress roots: Make vertical cut first and then a horizontal cut, and remove the resulting piece.

11.6.3 Basic information on felling cut

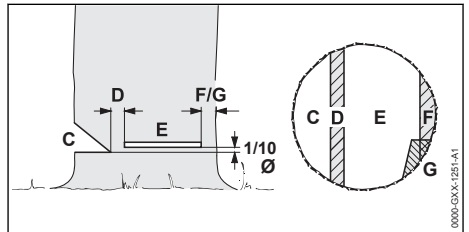

C Felling notch

The felling notch determines the direction of fall.

D Hinge

The hinge helps control the falling tree. The width of the hinge is 1/10 of the trunk diameter.

E Felling cut

The tree is felled with the felling cut. The felling cut is 1/10 of the trunk diameter (at least 3 cm) above the bottom of the felling notch.

F Stabilizing strap

The stabilizing strap supports the tree and helps prevent it from falling prematurely. The width of the stabilizing strap is 1/10 to 1/5 of the trunk diameter.

G Holding strap

The holding strap supports the tree and helps prevent it from falling prematurely. The width of the holding strap is 1/10 to 1/5 of the trunk diameter.

11.6.4 Cutting a Felling Notch

The felling notch determines the direction in which the tree will fall. Country-specific standards for making the felling notch must be observed.

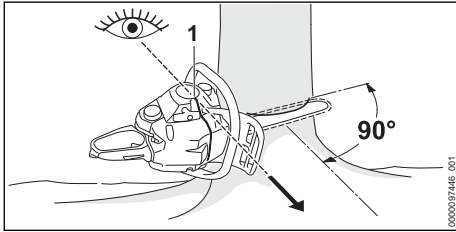

- ▶ Position the chainsaw so that the felling notch is at a right angle to the felling direction and the chainsaw is close to the ground.
- ▶ Control the felling direction with the felling notch (1).
- ▶ Make the horizontal cut.
- ▶ Make the angled cut at 45° to the horizontal cut.

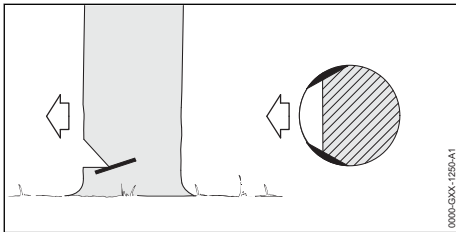

- ▶ If the wood is sound and long-fibered: Observe the following points when making sapwood cuts:
 - The cuts must be the same on both sides.
 - The cuts must be at the same height as the bottom of the felling notch.
 - The width of the cuts is 1/10 of the trunk diameter.
- The trunk does not splinter when the tree falls.

11.6.5 Plunge cutting

Plunge cutting is a technique required for felling.

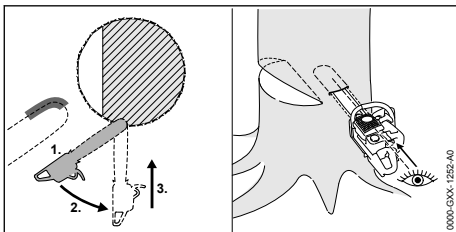

- ▶ Begin cut with the lower portion of the guide bar nose – with chain running at full speed.
- ▶ Cut until depth of kerf is twice the width of the guide bar.
- ▶ Swing the saw into plunge-cutting position.
- ▶ Perform the plunge cut

11.6.6 Selecting the Appropriate Felling Cut

The choice of appropriate felling cut depends on the following conditions:

- The natural inclination of the tree
- The tree's branch formation
- Damage to the tree
- The tree's state of health
- If there is snow on the tree: the snow load
- The direction of slope
- Wind direction and speed
- Nearby trees, if any

There are different features of these conditions. Only two features are described in this Instruction Manual.

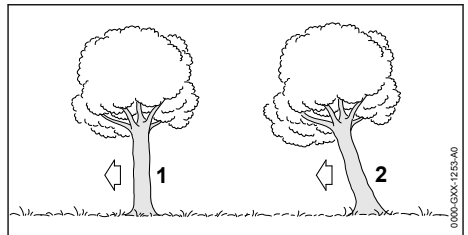

1 Normal tree

A normal tree is vertical and has an even crown.

2 Leaner

A leaner stands at an angle and the crown faces in the direction of fall.

11.6.7 Felling normal, small diameter tree

A normal tree is felled with a felling cut and stabilizing strap. This felling cut must be performed if the tree diameter is less than the guide bar's length.

- ▶ Shout a warning.

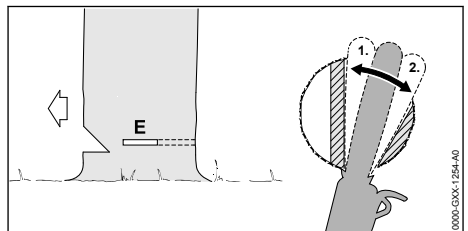

- ▶ Plunge the guide bar into the felling cut until it is visible at the other side of the trunk,  11.6.5.
- ▶ Apply the spiked bumper behind the hinge and use it as a pivot.
- ▶ Enlarge felling cut in direction of hinge.
- ▶ Enlarge felling cut in direction of stabilizing strap.

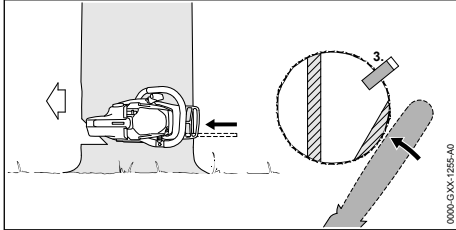

- ▶ Insert a felling wedge. The felling wedge must match the tree diameter and the width of the felling cut.
- ▶ Shout a warning.
- ▶ With outstretched arms, cut through the stabilizing strap horizontally from outside at the same level as the felling cut. The tree falls.

11.6.8 Felling normal, large diameter tree

A normal tree is felled with a felling cut and stabilizing strap. This felling cut must be performed if the tree diameter is greater than the guide bar's length.

- ▶ Shout a warning.

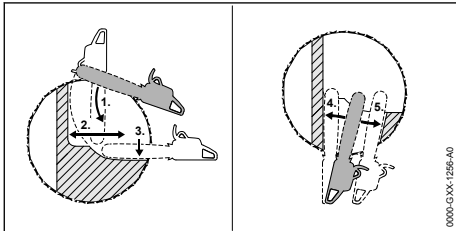

- ▶ Apply the spiked bumper at the same height as the felling cut and use it as a pivot.
- ▶ Hold the saw horizontally and swing it into the felling cut as far as possible.
- ▶ Enlarge felling cut in direction of hinge.
- ▶ Enlarge felling cut in direction of stabilizing strap.
- ▶ Move to the other side of the tree.
- ▶ Plunge the guide bar into the felling cut at the same height.
- ▶ Enlarge felling cut in direction of hinge.

- ▶ Enlarge felling cut in direction of stabilizing strap.

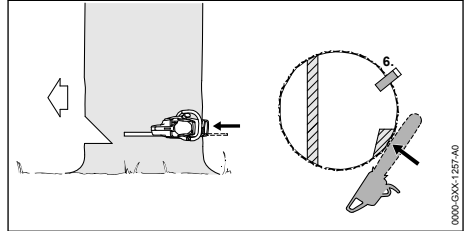



- ▶ Insert a felling wedge. The felling wedge must match the tree diameter and the width of the felling cut.
- ▶ Shout a warning.
- ▶ With outstretched arms, cut through the stabilizing strap horizontally from outside at the same level as the felling cut. The tree falls.

11.6.9 Felling a small diameter leaner

A leaner is felled with a felling cut and holding strap. This felling cut must be performed if the tree diameter is less than the guide bar's length.

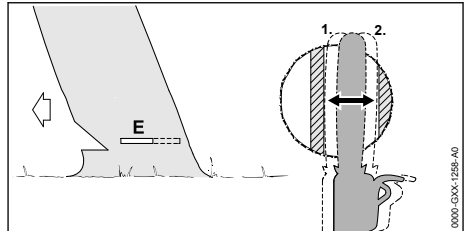
- ▶ Shout a warning.



- ▶ Plunge the guide bar into the felling cut until it is visible at the other side of the trunk,  11.6.5.
- ▶ Enlarge felling cut in direction of hinge.
- ▶ Enlarge felling cut in direction of holding strap.

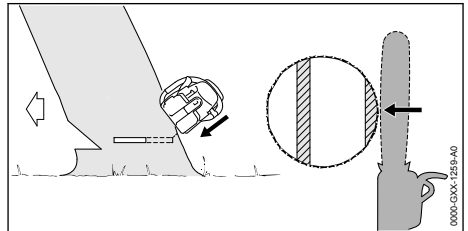

- ▶ Shout a warning.
- ▶ With arms outstretched, cut through the holding strap from outside at a downward angle. The tree falls.

11.6.10 Felling a large diameter leaner

A leaner is felled with a felling cut and holding strap. This felling cut must be performed if the tree diameter is greater than the guide bar's length.

- ▶ Shout a warning.

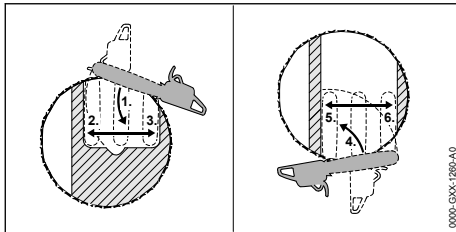

- ▶ Apply the spiked bumper behind the holding strap at the same height as the felling cut and use it as a pivot.
- ▶ Hold the saw horizontally and swing it into the felling cut as far as possible.
- ▶ Enlarge felling cut in direction of hinge.
- ▶ Enlarge felling cut in direction of holding strap.
- ▶ Move to the other side of the tree.
- ▶ Apply the spiked bumper behind the hinge at the same height as the felling cut and use it as a pivot.
- ▶ Hold the saw horizontally and swing it into the felling cut as far as possible.
- ▶ Enlarge felling cut in direction of hinge.
- ▶ Enlarge felling cut in direction of holding strap.

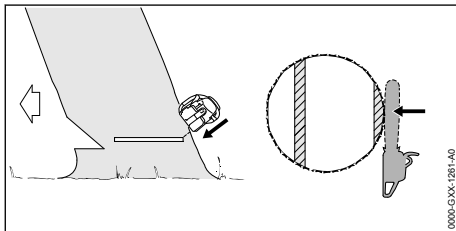

- ▶ Shout a warning.
- ▶ With arms outstretched, cut through the holding strap from outside at a downward angle. The tree falls.

12 After Finishing Work

12.1 When Work is Finished

- ▶ Shut off the engine and engage the chain brake.
- ▶ Allow the chainsaw to cool down.
- ▶ If the chainsaw is wet: Allow the chainsaw to dry.
- ▶ Clean the chainsaw.
- ▶ Clean the air filter.

- ▶ Clean the guide bar and saw chain.
- ▶ Loosen the nuts on the chain sprocket cover.
- ▶ Back off the tensioning screw 2 turns counterclockwise.
The saw chain is now slack.
- ▶ Tighten down the nuts on the chain sprocket cover.
- ▶ Fit the chain scabbard so that it completely covers the guide bar.

Quick chain tensioner

- ▶ Shut off the engine and engage the chain brake.
- ▶ Allow the chainsaw to cool down.
- ▶ If the chainsaw is wet: Allow the chainsaw to dry.
- ▶ Clean the chainsaw.
- ▶ Clean the air filter.
- ▶ Clean the guide bar and saw chain.
- ▶ Loosen the wingnut.
- ▶ Turn the adjusting wheel 2 turns counterclockwise.
The saw chain is now slack.
- ▶ Tighten the wingnut.
- ▶ Fit the chain scabbard so that it completely covers the guide bar.

13 Transporting

13.1 Transporting the Chainsaw

- ▶ Shut off the engine and engage the chain brake.
- ▶ Fit the chain scabbard so that it completely covers the guide bar.

Carrying the chainsaw

- ▶ Carry the chainsaw by holding the front handle in your right hand with the guide bar pointing to the rear.

Carrying the chainsaw in a vehicle

- ▶ Secure the saw to prevent tipping over and movement.

14 Storing

14.1 Storing the chainsaw

- ▶ Shut off the engine and engage the chain brake.
- ▶ Push the chain scabbard over the guide bar so that it completely covers the guide bar.
- ▶ Comply with the following conditions when storing the chainsaw:
 - The chainsaw cannot tip over or move.
 - The chainsaw is out of reach of children.
 - The chainsaw is clean and dry.

- ▶ If you store the chainsaw for more than 30 days:
 - ▶ Remove the guide bar and saw chain.
 - ▶ Open the fuel tank cap.
 - ▶ Drain the fuel tank.
 - ▶ Close the fuel tank.
 - ▶ If a manual fuel pump is fitted: Press the manual fuel pump at least 5 times.
 - ▶ Start the engine and let it run at idling speed until it stops.

15 Cleaning

15.1 Cleaning the chainsaw

- ▶ Shut off the engine and engage the chain brake.
- ▶ Allow the chainsaw to cool down.
- ▶ Clean the chainsaw with a damp cloth or STIHL resin solvent.
- ▶ Clean vents with a paintbrush.

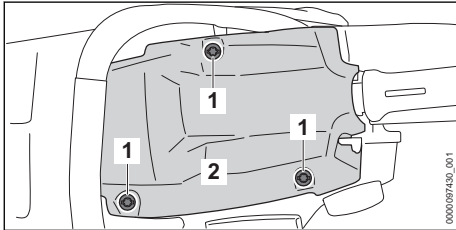

- ▶ Turn the shroud locks (1) counterclockwise until the cover (2) can be removed.
- ▶ Remove cover (2).
- ▶ Remove the chain sprocket cover.
- ▶ Use a soft brush, damp cloth or STIHL resin solvent to clean the cylinder fins and the inside of the shroud.
- ▶ Clean the area around the chain sprocket with a damp cloth or STIHL resin solvent.
- ▶ Fit the cover (2).
- ▶ Turn the shroud locks (1) clockwise and tighten them firmly.
The cover (2) is closed.
- ▶ Fit the chain sprocket cover.

15.2 Cleaning the Guide Bar and Saw Chain

- ▶ Shut off the engine and engage the chain brake.
- ▶ Remove the guide bar and saw chain.

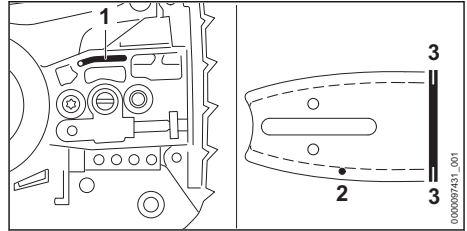

- ▶ Clean the oil inlet hole (1), oil port (2) and bar groove (3) with a soft brush or STIHL resin solvent.
- ▶ Clean the saw chain with a soft brush or STIHL resin solvent.
- ▶ Mount the guide bar and saw chain.

15.3 Cleaning the Air Filter

- ▶ Shut off the engine and engage the chain brake.

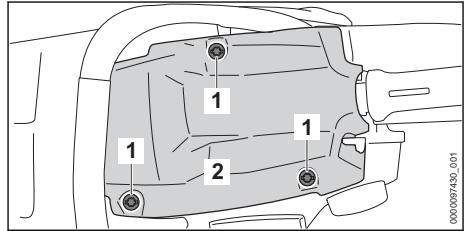

- ▶ Turn the shroud locks (1) counterclockwise until the cover (2) can be removed.
- ▶ Remove cover (2).

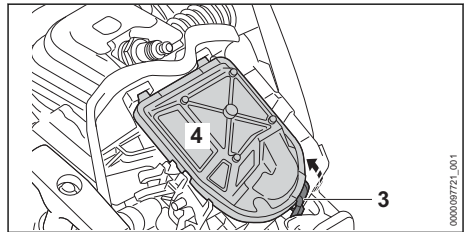

- ▶ Pull the latch (3) forward and remove the air filter (4).
- ▶ Dust down the air filter (4).
- ▶ If the air filter (4) is damaged: Install a new air filter (4).
- ▶ From the clean side, blow off the air filter (4) with compressed air.

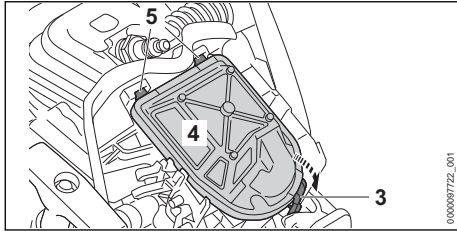

- ▶ Suspend the hook (5) and insert the air filter (4) so that the latch (3) engages with an audible click.
- ▶ Fit the cover (2).
- ▶ Turn the shroud locks (1) clockwise and tighten them firmly. The cover (2) is closed.

15.4 Cleaning the Spark Plug

- ▶ Shut off the engine and engage the chain brake.
- ▶ Allow the chainsaw to cool down.

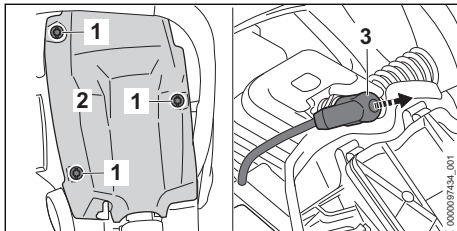

- ▶ Turn the shroud locks (1) counterclockwise until the cover (2) can be removed.
- ▶ Remove cover (2).
- ▶ Pull off the spark plug boot (3).
- ▶ If the area around the spark plug is soiled: Clean it with a cloth.
- ▶ Unscrew the spark plug.
- ▶ Clean the spark plug with a cloth.
- ▶ If the spark plug is corroded: Replace the spark plug.

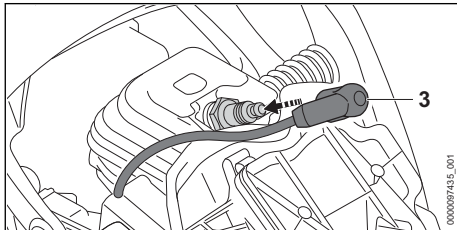

- ▶ Insert and tighten down the spark plug.
- ▶ Press the spark plug boot (3) firmly home.
- ▶ Fit the cover (2).

- ▶ Turn the shroud locks (1) clockwise and tighten them firmly. The cover (2) is closed.

16 Maintenance

16.1 Maintenance intervals

Maintenance intervals depend on the ambient conditions and the operating conditions. STIHL recommends the following maintenance intervals:

Chain brake

- ▶ Have a STIHL dealer service the chain brake in the following intervals:
 - Full-time use: every three months
 - Part-time use: every six months
 - Occasional use: every year

After every 100 hours of operation

- ▶ Replace the spark plug.

Weekly

- ▶ Check the chain sprocket.
- ▶ Check and deburr the guide bar.
- ▶ Check and sharpen the saw chain.

Monthly

- ▶ Have the oil tank cleaned by a STIHL dealer.
- ▶ Have the fuel tank cleaned by a STIHL dealer.
- ▶ Have the pickup body in the fuel tank cleaned by a STIHL dealer.

Annually

- ▶ Have the pickup body in the fuel tank replaced by a STIHL dealer.

16.2 Deburring the Guide Bar

A burr can build up on the outer edge of the guide bar.

- ▶ Remove burr with a flat file or a STIHL guide bar dressing tool.
- ▶ If you have any queries: Contact your STIHL servicing dealer.

16.3 Sharpening the Saw Chain

Correctly sharpening saw chains requires a lot of practice.

STIHL files, STIHL filing aids, STIHL sharpeners and the brochure "Sharpening STIHL Saw Chains" help you achieve the right results. To obtain the brochure visit <http://www.stihl.com/sharpening-brochure>.

STIHL recommends you have saw chains resharpened by a STIHL servicing dealer.

! WARNING

- The chain's cutters are very sharp. There is a risk of cut injuries.
 - ▶ Wear work gloves made of durable material.

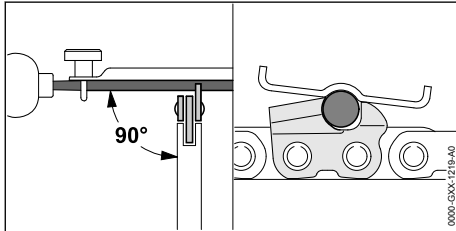

- ▶ File each cutter with a round file so that the following points are observed:
 - Round file matches the chain pitch.
 - File from the inside to the outside of the cutter.
 - Hold the file at right angle to the guide bar.
 - Maintain a filing angle of 30°.

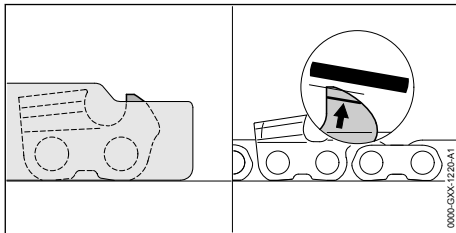

- ▶ File down the depth gauges with a flat file so that they are level with the STIHL filing gauge and parallel to the service mark. The STIHL filing gauge must match the chain pitch.
- ▶ If you have any queries: Contact your STIHL servicing dealer for assistance.

17 Repairing

17.1 Repairing the Chain Saw, Guide Bar and Saw Chain

The chain saw, guide bar and saw chain cannot be repaired by the user.

- ▶ If the saw, guide bar or saw chain is damaged: Do not use your saw, guide bar or saw chain, and contact your STIHL servicing dealer.

18 Troubleshooting

18.1 Troubleshooting the Chainsaw

Most problems can be attributed to the same cause.

- ▶ Carry out the following measures:
 - ▶ Clean the air filter.
 - ▶ Clean or replace the spark plug.
 - ▶ Adjust to standard setting.
 - ▶ Adjust the idle speed.
 - ▶ Adjusting the carburetor setting for working at high altitude.
 - ▶ Adjust carburetor for cutting at temperatures below -10 °C.
- ▶ If the problem continues: Carry out the measured listed below.

Fault	Cause	Remedy
The engine does not start.	There is not enough fuel in the fuel tank.	▶ Mix the fuel and top up the chainsaw.
	The engine has flooded.	▶ Vent the combustion chamber.
	The carburetor is too hot.	▶ Allow the chainsaw to cool down. ▶ If a manual fuel pump is fitted: Press the manual fuel pump at least 10 times before starting the engine.

Fault	Cause	Remedy
	The carburetor has iced up.	▶ Allow the chainsaw to warm up to +10 °C.
The engine idles erratically.	The carburetor has iced up.	▶ Allow the chainsaw to warm up to +10 °C.
The engine stops while idling.	The carburetor has iced up.	▶ Allow the chainsaw to warm up to +10 °C.
Poor acceleration.	The saw chain is over-tensioned.	▶ Tension the saw chain as specified.
The saw chain does not start running when revved up.	The chain brake is engaged.	▶ Disengage the chain brake.
	The saw chain is over-tensioned.	▶ Tension the saw chain as specified.
	The sprocket nose of the guide bar is blocked.	▶ Clean the sprocket nose of the guide bar with STIHL resin solvent.
Engine does not reach maximum power.	The muffler is soiled.	▶ Contact a STIHL servicing dealer.
Smoke or burning smell while cutting.	The saw chain has not been correctly sharpened.	▶ Sharpen chain as specified.
	Insufficient saw chain oil in the oil tank.	▶ Fill up with saw chain oil.
	The saw chain is over-tensioned.	▶ Tension the saw chain as specified.
	The chainsaw is not being used properly.	▶ Have correct use explained, then practice.

18.2 Adjust to standard setting

- ▶ Shut off the engine and engage the chain brake.

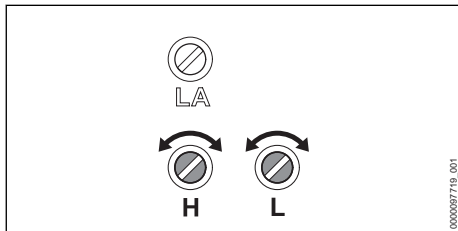

- ▶ Turn the high speed screw H counterclockwise as far as it will go.
- ▶ Turn the low speed screw L clockwise as far as it will go.
- ▶ Turn the low speed screw L 1/4 of a turn counterclockwise.

18.3 Adjust idle speed

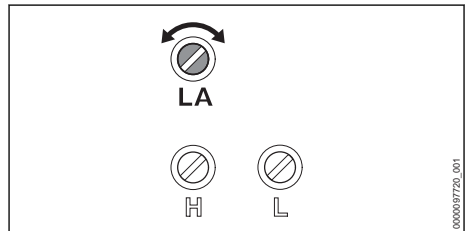

The Engine stops while idling

- ▶ Adjust to standard setting.
- ▶ Start the engine and release the chain brake.
- ▶ Warm up the engine by opening and closing the throttle for about 1 minute.
- ▶ If the engine continues to stop while idling: Turn the idle speed screw LA 1/2 turns clockwise and start the engine up again.
- ▶ Turn the idle speed screw LA clockwise until the saw chain begins to run.
- ▶ Turn the LA idle speed screw 1.5 turns counterclockwise.

Saw chain runs continuously while engine is idling

- ▶ Adjust to standard setting.
- ▶ Start the engine and release the chain brake.
- ▶ Warm up the engine by opening and closing the throttle for about 1 minute.
- ▶ Turn the idle speed screw LA counterclockwise until the saw chain stops running.
- ▶ Turn the idle speed screw LA 1.5 turns counterclockwise.

18.4 Venting the Combustion Chamber

- ▶ Engage the chain brake.

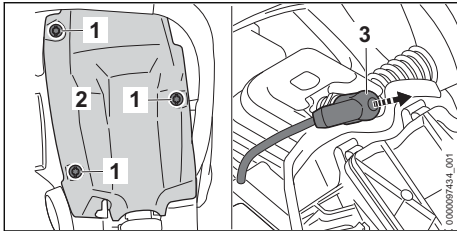

- ▶ Turn the shroud locks (1) counterclockwise until the cover (2) can be removed.
- ▶ Remove cover (2).
- ▶ Pull off the spark plug boot (3).
- ▶ Unscrew the spark plug.
- ▶ Dry the spark plug.



WARNING

- If the starter grip is pulled out while the spark plug boot is removed, sparks may escape. Sparks may cause fires and explosions in highly flammable or explosive environments. Persons may be seriously or fatally injured and property may be damaged.
 - ▶ Move the Master Control Lever to position  and hold it there before pulling out the starter grip.
- ▶ Move the Master Control Lever to position and hold it there.
- ▶ Pull the starter grip and guide it back several times. You have vented the combustion chamber.
- ▶ Insert and tighten down the spark plug.

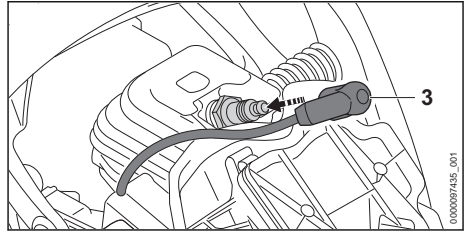

- ▶ Press the spark plug boot (3) firmly home.
- ▶ Fit the cover (2).
- ▶ Turn the shroud locks (1) clockwise and tighten them firmly. The cover (2) is closed.

19 Specifications

19.1 STIHL MS 182, MS 212 Chain-saw

MS 182

- Displacement: 35.8 cm³
- Engine power to ISO 7293: 1.6 kW (2.2 bhp)
- Idle speed according to ISO 11681: 3000 ± 50 rpm
- Approved spark plugs: NGK CMR6H from STIHL, STIHL ZK C 10
- Electrode gap of the spark plug: 0.5 mm
- Weight with empty fuel tank and without guide bar and saw chain:
 - MS 182: 4.6 kg
 - MS 182 C: 4.9 kg
- Max. fuel tank capacity: 396 cm³ (0.396 l)
- Max. oil tank capacity: 280 cc (0.28 l)

MS 212

- Displacement: 38.6 cm³
- Engine power to ISO 7293: 1.8 kW (2.4 bhp)
- Idle speed according to ISO 11681: 3000 ± 50 rpm
- Approved spark plugs: NGK CMR6H from STIHL, STIHL ZK C 10
- Electrode gap of the spark plug: 0.5 mm
- Weight with empty fuel tank and without guide bar and saw chain:
 - MS 212: 4.6 kg
 - MS 212 C: 4.9 kg
- Max. fuel tank capacity: 396 cm³ (0.396 l)
- Max. oil tank capacity: 280 cm³ (0.28 l)

19.2 Chain Sprockets and Chain Speeds

The following chain sprockets may be used:

- 6-tooth for 3/8" P
 - Maximum chain speed according to ISO 11681: 24.8 m/s

- Chain speed at maximum power:
18.6 m/s

19.3 Minimum Groove Depth of Guide Bars

The minimum groove depth depends on the pitch of the guide bar.

- 3/8" P: 5 mm

19.4 Sound and vibration values

MS 182

- Sound pressure level L_{pA} measured according to ISO 22868: 100 dB(A). The K-value for the sound pressure level is 2 dB(A).
- Sound power level L_{weq} measured according to ISO 22868: 112 dB(A) The K value for the sound power level is 2 dB(A).
- Vibration level a_{HV} measured according to ISO 22867:
 - Handlebar: 2.5 m/s². The K value for the vibration level is 2 m/s².
 - Control handle: 3.4 m/s². The K value for the vibration level is 2 m/s².

MS 182 (EU only)

- Sound pressure level L_{peq} measured according to ISO 22868: 103 dB(A). The K-value for the sound pressure level is 2 dB(A).
- Sound power level L_{weq} measured according to ISO 22868: 112 dB(A) The K value for the sound power level is 2 dB(A).
- Vibration level a_{HV} measured according to ISO 22867:
 - Handlebar: 3.1 m/s². The K value for the vibration level is 2 m/s².
 - Control handle: 3.7 m/s². The K value for the vibration level is 2 m/s².

MS 212

- Sound pressure level L_{pA} measured according to ISO 22868: 103 dB(A). The K-value for the sound pressure level is 2 dB(A).

- Sound power level L_{weq} measured according to ISO 22868: 113 dB(A) The K value for the sound power level is 2 dB(A).
- Vibration level a_{HV} measured according to ISO 22867:
 - Handlebar: 3.1 m/s². The K value for the vibration level is 2 m/s².
 - Control handle: 3.7 m/s². The K value for the vibration level is 2 m/s².

For information on compliance with the Physical Agents (Vibration) Directive 2002/44/EC, see www.stihl.com/vib.

19.5 REACH

REACH is an EC regulation and stands for the Registration, Evaluation, Authorisation and Restriction of Chemical substances.

For information on compliance with the REACH regulation see www.stihl.com/reach.

19.6 Exhaust Emissions

The CO₂ value measured in the EU type approval procedure is specified at www.stihl.com/co2 in the product-specific technical data.

The measured CO₂ value was determined on a representative engine in accordance with a standardised test procedure under laboratory conditions and does not represent either an explicit or implied guarantee of the performance of a specific engine.

The applicable exhaust emission requirements are fulfilled by the intended usage and maintenance described in this instruction manual. The type approval expires if the engine is modified in any way.

20 Bar and Chain Combinations

20.1 STIHL MS 182, MS 212 Chainsaw

Pitch	Drive link gauge/groove width	Length	Guide bar	Number of teeth, sprocket nose	Number of drive links	Saw chain
3/8"	1.3 mm	30 cm	Rollomatic E / Light 04	9	44	63 PM (type 3613) 63 PM3 (type 3636) 63 PS (type 3617) 63 PS3
			Rolomatic E Light / Light P04			

Pitch	Drive link gauge/groove width	Length	Guide bar	Number of teeth, sprocket nose	Number of drive links	Saw chain
		35 cm	Rollomatic E / Light 04		50	(type 3616) 63 PD3 (type 3612)
			Rolomatic E Light / Light P04			
		40 cm	Rollomatic E / Light 04		55	
			Rolomatic E Light / Light P04			
		45 cm	Rollomatic E / Light 04		61	

The cutting length of a guide bar depends on the chainsaw and the saw chain being used. The actual cutting length of a guide bar may be less than the specified length.

21 Spare Parts and Accessories

21.1 Spare parts and accessories

STIHL  These symbols indicate original STIHL spare parts and original STIHL accessories.

STIHL recommends the use of original STIHL spare parts and accessories.

Despite ongoing market observation, STIHL is unable to judge the reliability, safety and suitability of other manufacturers' spare parts and accessories; accordingly, STIHL cannot warrant for the use of those parts.

Original STIHL spare parts and original STIHL accessories are available from STIHL dealers.

22 Disposal

22.1 Disposing of Chainsaw

Contact the local authorities or your STIHL dealer for information on disposal.

Improper disposal can be harmful to health and pollute the environment.

- ▶ Take STIHL products including packaging to a suitable collection point for recycling in accordance with local regulations.
- ▶ Do not dispose with domestic waste.

23 EC Declaration of Conformity

23.1 STIHL MS 182, MS 212 Chainsaw

ANDREAS STIHL AG & Co. KG
Badstraße 115
D-71336 Waiblingen
Germany

declares under our sole responsibility that

- Category: chainsaw
- Manufacturer's brand: STIHL
- type: MS 182, serial identification: 1148
 - Displacement: 35.8 cm³
- type: MS 212, serial identification: 1148
 - Displacement: 38.6 cm³

conforms to the relevant provisions of Directives 2011/65/EU, 2006/42/EC, 2014/30/EU and 2000/14/EC and has been developed and manufactured in compliance with the following standards in the versions valid on the date of production: EN ISO 11681-1, EN 55012 and EN 61000-6-1.

The EC type examination pursuant to Directive 2006/42/EC Art. 12.3(b) was carried out by DPLF, Deutsche Prüf- und Zertifizierungsstelle für Land- und Forsttechnik GbR (NB 0363), Spremberger Straße 1, 64823 Groß-Umstadt, Germany

- Certification number:
 - MS 182: K-EG-2019/9436
 - MS 212: K-EG-2019/9438

The measured and guaranteed sound power levels were determined according to Directive

2000/14/EC, Annex V, using the ISO 9207 standard.

- Measured sound power level: 115 dB(A)
- Guaranteed sound power level: 117 dB(A)

The technical documents are stored at ANDREAS STIHL AG & Co. KG Produktzulassung.

The year of manufacture and serial number are indicated on the chainsaw.

Waiblingen, 2022-08-01

ANDREAS STIHL AG & Co. KG

pp 

Robert Olma, Vice President, Regulatory Affairs & Global Governmental Relations

24 UKCA Declaration of Conformity

24.1 STIHL MS 182, MS 212 Chainsaw



ANDREAS STIHL AG & Co. KG
Badstraße 115
D-71336 Waiblingen
Germany

declares under our sole responsibility that

- Category: chainsaw
- Manufacturer's brand: STIHL
- type: MS 182, serial identification: 1148
 - Displacement: 35.8 cm³
- type: MS 212, serial identification: 1148
 - Displacement: 38.6 cm³

conforms to the relevant provisions of UK regulations The Restriction of the Use of Certain Hazardous Substances in Electrical and Electronic Equipment Regulations 2012, Supply of Machinery (Safety) Regulations 2008, Electromagnetic Compatibility Regulations 2016 and Noise Emission in the Environment by Equipment for use Outdoors Regulations 2001 and has been manufactured in compliance with the following standards in the versions valid on the date of production: EN ISO 11681-1, EN 55012 and EN 61000-6-1.

The type examination was carried out by: Inter-tek Testing & Certification Ltd, Academy Place, 1-9 Brook Street, Brentwood, Essex, CM14 5NQ, United Kingdom

- Certification number:
 - MS 182: UK-MCR-0029
 - MS 212: UK-MCR-0030

The measured and guaranteed sound power levels have been determined in accordance with the UK regulation Noise Emission in the Environment by Equipment for use Outdoors Regulations 2001 Schedule 8, using the ISO 9207 standard.

- Measured sound power level: 115 dB(A)
- Guaranteed sound power level: 117 dB(A)

The technical documentation is stored at ANDREAS STIHL AG & Co. KG.

The year of manufacture and serial number are indicated on the chainsaw.

Waiblingen, 2022-08-01

ANDREAS STIHL AG & Co. KG

pp 

Robert Olma, Vice President, Regulatory Affairs & Global Governmental Relations

25 Addresses

www.stihl.com

www.stihl.com



0458-221-0121-B



0458-221-0121-B