

# STIHL

## STIHL SE 62

Instruction Manual





## Contents

Guide to Using this Manual	2
Safety Precautions and Working Techniques	2
Packing List	7
Assembling the Unit	7
Connecting to Power Supply	9
Switching On	10
Working	10
Switching Off	12
After Finishing Work	12
Emptying the container	13
Cleaning the filter element	13
Replacing the filter element	14
Maintenance and Care	15
Minimize Wear and Avoid Damage	16
Troubleshooting	16
Main Parts	18
Specifications	19
Maintenance and Repairs	19
Disposal	20
EC Declaration of Conformity	20
UKCA Declaration of Conformity	21

# STIHL

SE 62, SE 62 E

Dear Customer,

Thank you for choosing a quality engineered STIHL product.

It has been built using modern production techniques and comprehensive quality assurance. Every effort has been made to ensure your satisfaction and trouble-free use of the product.

Please contact your dealer or our sales company if you have any queries concerning this product.

Your



Dr. Nikolas Stihl

## Guide to Using this Manual

### Pictograms

---

All the pictograms attached to the machine are shown and explained in this manual.

### Symbols in text

---



#### WARNING

Warning where there is a risk of an accident or personal injury or serious damage to property.



#### NOTICE

Caution where there is a risk of damaging the machine or its individual components.

### Engineering improvements

---

STIHL's philosophy is to continually improve all of its products. For this reason we may modify the design, engineering and appearance of our products periodically.

Therefore, some changes, modifications and improvements may not be covered in this manual.

## Safety Precautions and Working Techniques



Special safety precautions are necessary when using this machine. The power connection is a particular source of danger.



It is important you read and understand the Instruction Manual before first use and keep the manual in a safe place for future reference. Non-observance of the Instruction Manual may result in serious or even fatal injury.

## ! WARNING

- Children or youngsters should never be allowed to use the machine. Supervise children to ensure that they do not play with the machine.
- The machine should only be provided or loaned to people familiar with this model and its operation. The instruction manual should always be handed over with the machine.
- Before starting any work on the machine, e. g., cleaning, servicing, replacement of parts – **unplug the power plug!**

Comply with national safety regulations issued, e.g. by employers' liability insurance associations, social security institutions, occupational safety and health authorities or other organizations.

When the machine is not in use, shut it off so that it does not endanger others. Ensure that the machine cannot be used without authorization; unplug the power plug.

The machine may only be used by persons who have been duly trained to use and handle it or who can demonstrate that they can operate the machine safely.

The machine can be used by persons with limited physical, sensory or mental capacity or with little experience and know-how as long as they are supervised and have been instructed on how to handle the machine safely and understand the associated risks.

The user is responsible for avoiding injury to third parties or damage to their property.

If you have not used this machine model before: Have your STIHL dealer or another expert show you how to use it safely.

Always check that the machine is in good working order before starting work. Particular attention must be devoted to the connecting cord, the power plug and the safety parts.

Inspect the connecting cord regularly for signs of damage and aging. Never use the

machine if the connecting cord is damaged – **Danger of electrocution!**

Do not use the connecting cord to pull or transport the machine.

Connect only electric power tools to the socket outlet – see "Connecting the machine to the power supply" and "Switching on the machine".

Do not use high-pressure cleaners to clean the machine. The hard water jet can damage parts of the machine.

Never spray the upper part of the vacuum cleaner with water – **Danger of short-circuiting!**

### **Accessories and Spare Parts**

Only use parts or accessories which have been approved by STIHL for this machine or which are technically equivalent. If you have any questions in this respect, consult a servicing dealer. Only use high-quality parts and attachments. Otherwise, there may be a risk of accidents and damage to the machine.

STIHL recommends the use of genuine STIHL parts and accessories. They are specifically designed to match your model and meet your performance requirements.

Do not modify the machine – otherwise the safety may be endangered. STIHL excludes all liability for personal injury and damage to property caused while using unauthorized attachments.

### **Areas of application**

Vacuuming of dry, non-flammable materials (dust, dirt, broken glass, wood or metal shavings, sand, etc.) and non-flammable liquids (dirty water, spilled juices, etc.)



Never use the machine to vacuum hot materials (hot ash, flammable explosive dust, glowing cigarette butts, etc.) or combustible liquids (gasoline, thinner, etc.) as well as aggressive liquids (acids, lye) – **Danger of fire or explosion!**

The machine is not suitable for vacuuming toxic dust.

Do not use the machine for any other purpose because of the increased risk of accidents and damage to the machine. The machine must not be modified in any way – this may also lead to accidents or damage to the machine.

### Transporting the machine

When transporting the machine in or on a vehicle, it must be secured, e.g. with straps, so that it cannot slip or tip over.

Do not tilt the machine if there is liquid in the container.

Close all latches on the container before transport.

### Before starting work

#### Checking the machine

- It must be possible to move the switch easily to the 0 position.
- The switch must be in the 0 position.

Do not operate the machine if it is not properly assembled and in good condition – **risk of accident!**

The machine may only be used when all parts are in perfect working order and are securely mounted.

Remove the filter bag and check correct operation of the float before vacuuming liquids or wet materials. Never work without the filter element.

Never attempt to modify the controls or safety devices

### Electrical connection

Minimize the risk of electrical shock:

- Voltage and frequency of the machine (see rating plate) must match the voltage and frequency of the mains supply
- Examine the connecting cord, power plug and extension cord for damage. Damaged cords, couplings and plugs or connecting cords that do not comply with the regulations must not be used
- Only connect the machine to a correctly installed power socket
- Use only extension cords that comply with the specifications for the respective application.
- The insulation on the connecting cord and any extension cord, the plug and the coupling must be fully intact

Route the connecting cord and extension cord properly:

- Observe the minimum cross-section of the individual cords – see "Connecting the machine to the power supply"
- Route and mark the connecting cord so that it cannot become damaged and no one is endangered – **danger of stumbling!**
- Use of unsuitable extension cords can be dangerous. Use only extension cords that are approved for outdoor use and are correspondingly marked and have a sufficient cross-section
- The connector and coupling of the extension cord must be waterproof or routed in such a way that they cannot come into contact with water – the connector and coupling of the extension cord must not lie in water
- don't let the cord rub against edges or pointed or sharp objects

- don't squeeze the cord under doors or windows
- if cords become snarled – unplug the power plug and unsnarl the cord
- always unroll the connecting cord from the cable reel completely to avoid risk of fire due to overheating

### During operation



If the connecting cord is damaged, immediately disconnect the power plug from the wall outlet – **risk of electric shock!**

Ensure that the connecting cord is not damaged by being driven over, squashed or pulled, etc.

Never unplug the power plug by pulling on the connecting cord: always grip the plug itself.

Only touch the power plug, connecting cord and extension cord and electrical plug connections with dry hands.

Never spray electrical devices with water – **Danger of short-circuiting!**

In the event of imminent danger or in an emergency – move switch to 0 .

Never let the machine run unattended.

Do not leave the machine outdoors in the rain.

The machine may only be operated in an upright position. Do not cover the machine and ensure adequate motor ventilation.

Ensure that the filter element is always undamaged.

If foam develops or liquid escapes, stop work immediately, unplug the power plug, and empty the container.

If the machine is subjected to unusually high loads for which it was not designed (e. g., heavy impact or a fall), always check that it is in good condition before continuing work - refer also to the chapter "Before starting work". Also make certain that the safety mechanisms are working properly. Never continue

using a machine that is not in perfect working order. In case of doubt, have the unit checked by your servicing dealer.

Before leaving the machine unattended: Switch off the machine – unplug the power plug.

### After finishing work

Unplug the power plug from the socket.

Never unplug the power plug by pulling on the connecting cord: always grip the plug itself.

Always clean dust and dirt off the machine – do not use any grease solvents for this purpose.

### Maintenance and repairs

#### **WARNING**



Before starting any work on the machine: Always disconnect the machine from the mains power supply.

- Use only high-quality spare parts. Otherwise, there may be a risk of accidents and damage to the unit. If you have any questions in this respect, consult a servicing dealer.
- To avoid risks, work on the machine (e. g. replacing a damaged power cord) may only be carried out by authorized dealers or qualified electricians.

Clean plastic parts with a cloth. Harsh detergents can damage the plastic.

Clean ventilation slots in motor housing as needed.

The machine must be serviced regularly. Do not attempt any maintenance or repair work not described in the Instruction Manual. All other work should be carried out by a servicing dealer.

STIHL recommends the use of genuine STIHL spare parts. Such parts have been optimized for the machine and the user's requirements.

STIHL recommends that maintenance and repair work be carried out only by

authorized STIHL dealers. STIHL dealers receive regular training and are supplied with technical information.



## Packing List

### SE 62

- 1x suction hose 2.5 m
- 1x hand tube
- 2x insertable suction tube

### SE 62 E

- 1x suction hose 3.5 m
- 1x hand tube
- 1x telescoping suction tube

### Accessories in container

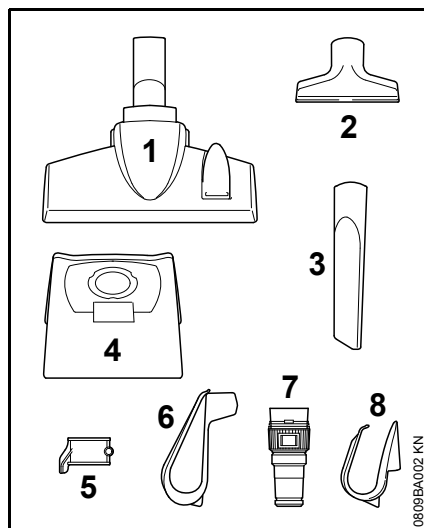

- 1x Kombi floor tool (1)
- 1x all-purpose tool (2)
- 1x crevice tool (3)
- 1x filter bag (4)

- 1x suction tube holder (5)
- additionally only for SE 62**
- 1x holder for power cord (6)
- additionally only for SE 62 E**
- 1x adapter for electrical power tools (7)
- 1x holder for power cord (8)

## Assembling the Unit

The following accessory parts must be fitted before using the machine for the first time.

### **!** WARNING

Do not plug the power cord into the outlet until the machine is completely assembled.

### Opening and closing the container

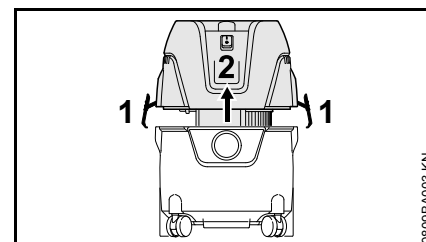

### Opening

- Release the spring catches (1)
- Lift the upper part of the vacuum cleaner (2) vertically up and off
- Remove accessories and insert filter bag – see "Inserting filter bag"

### Closing

- Refit the upper part of the vacuum cleaner (2) and close the latches (1) – ensure that the latches engage properly

### Fit filter bag

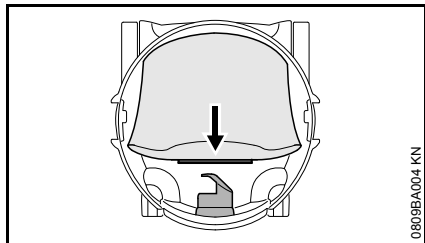

- Push filter bag sleeve onto intake port as far as possible

### Mount suction hose and hand tube

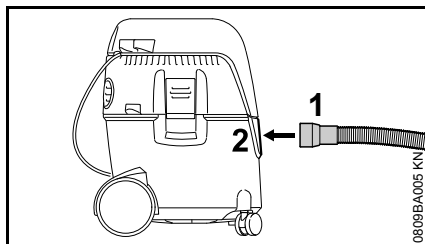

- Insert sleeve (1) of suction hose into the intake port (2)

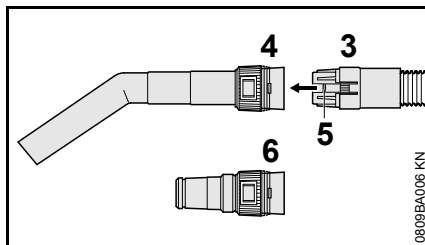

- Slide clutch (3) of suction hose into the retainer (4) on the hand tube – lock (5) must engage

When using the adapter for electric power tools (supplied with the model SE 62 E):

- Slide clutch (3) of suction hose into the retainer (6) of the adapter for electric power tools – lock (5) must engage

### Holders for power cord

#### SE 62

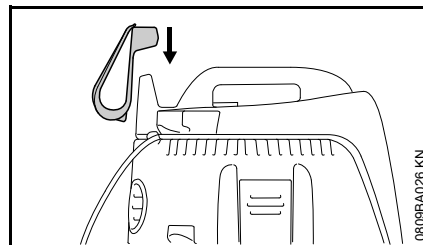

- Connect holder for power cord via the support on the upper part of the vacuum cleaner

#### SE 62 E

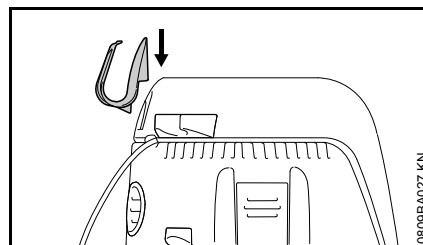

- Attach holder for power cord on the right tab on the upper part of the vacuum cleaner

### Extension tube

#### SE 62

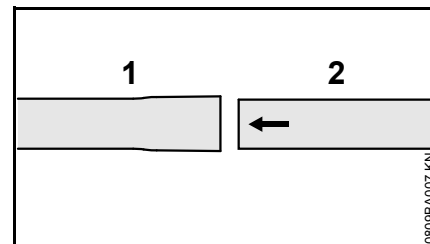

- Connect suction tubes (1) and (2)

#### SE 62 E

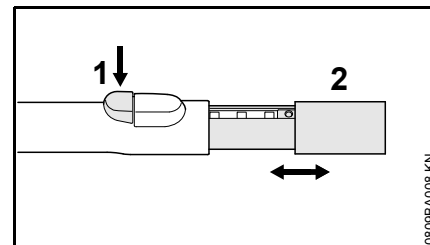

- Press button (1)
- Retract or extend suction tube (2)

### Mount suction tube holder

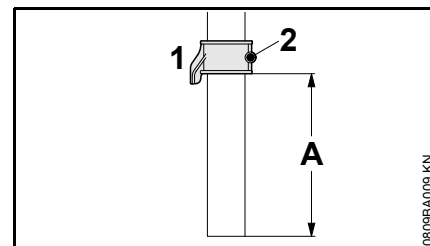

- Slide the suction tube holder (1) via the suction tube (distance A approx. 8 cm / 3.150 in.) and secure it with the screw (2)

## Fastening accessories

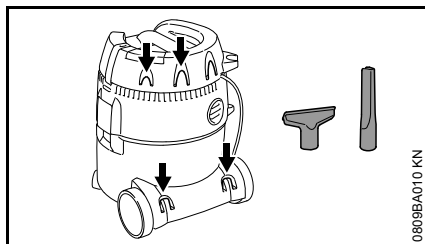

Fasten accessories on the holders provided – as shown in picture.

## Connecting to Power Supply

The voltage and frequency of the machine (see rating plate) must match the voltage and frequency of the power connection.

The minimum fuse protection of the power connection must comply with the specifications – see "Specifications".

The machine must be connected to the power supply via an earth-leakage circuit breaker to disconnect the power supply if the differential current to earth exceeds 30 mA.

The power connection must correspond to IEC 60364 and relevant national regulations.

### Extension cord

The design of the extension cord must at least fulfill the same features as the connecting cord on the machine. Observe the design marking (type designation) on the connecting cord.

The cores in the cord must have the following minimum cross-section depending on the mains voltage and cord length.

<b>Cord length</b>	<b>Minimum cross-section</b>
<b>220 V – 240 V:</b>	
Up to 20 m	1.5 mm <sup>2</sup>
20 m to 50 m	2.5 mm <sup>2</sup>
<b>100 V – 127 V:</b>	
Up to 10 m	AWG 14 / 2.0 mm <sup>2</sup>
10 m to 30 m	AWG 12 / 3.5 mm <sup>2</sup>

## Connection to the power supply socket

Before connection to the power supply, check that the machine is switched off – see "Switching off the machine"

- Plug the power cord or extension cord into a properly installed outlet

## Switching On

### SE 62

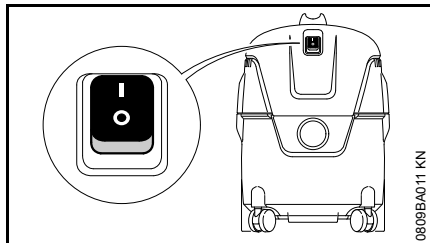

#### Switch positions:



vacuum cleaner is switched on



vacuum cleaner is switched off

- To switch on, set master switch to I

### SE 62 E

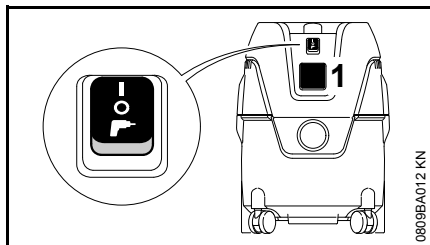

Power tools can be plugged into the machine socket (1). Do not exceed the maximum connected load of the machine socket – see "Specifications".

- Switch off the vacuum cleaner and the electric power tool that is to be connected prior to connection to the machine socket (1).

The power consumption of the vacuum is adjusted automatically when using electric power tools with electronic speed control.

#### Switch positions



Vacuum switched on, the socket outlet on the appliance cannot be used.



vacuum cleaner is switched off



Vacuum ready for operation – the machine connected to the socket outlet on the appliance switches the vacuum on and off via the automatic switch-on function

- To switch on, set master switch to the corresponding switch position

## Working

- Depending on the intended use of the vacuum cleaner – select the appropriate accessory and fit to the suction tube, hand tube or suction hose (only adapter for electrical power tool)

### Kombi floor tool

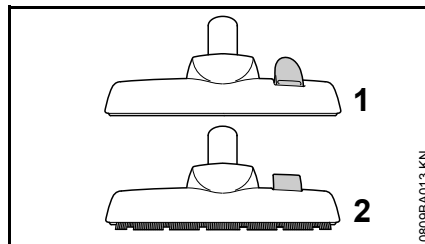

- Position for vacuuming carpets (1)
- Position for vacuuming hard floors (2)

### All-purpose tool

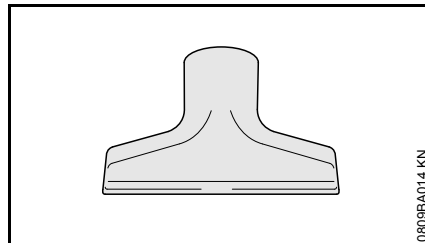

To clean upholstery or inside of vehicles.

## Crevice tool

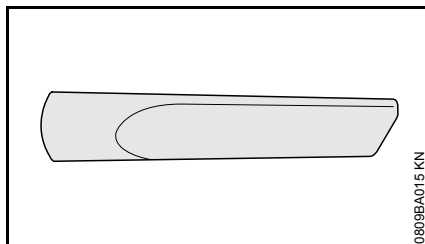

To clean ingrained dirt, e. g. in corners or joints.

## Adapter for electrical power tool (supplied with the model SE 62 E)

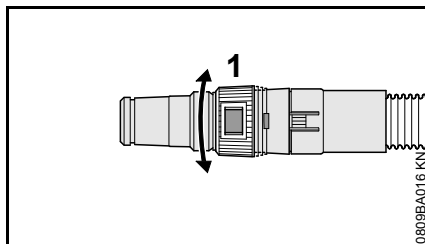

To connect electrical power tools to suction attachment:

- Connect adapter for electrical power tool to suction hose instead of hand tube
- Use the adjusting ring (1) to adjust the suction power to the relevant task or to the relevant electrical power tool

## Vacuumping dry materials

### **!** WARNING

**Flammable materials must not be vacuumed.**

Always make sure that the filter bag has been fitted in the container before vacuuming dry materials. The vacuumed material can then be disposed of without difficulty. Dry materials can also be vacuumed without filter bag.

### **⚙** NOTICE

Never use the vacuum cleaner with a damaged filter element or without the filter element.

## Vacuumping liquids

### **!** WARNING

**Flammable liquids must not be vacuumed.**

Always remove the filter bag and check operation of the float before vacuuming liquids. The float switches off the air stream when the container is full. If the machine is exclusively used for wet-vacuumping, the filter element should be replaced by a special insert (special accessory).

The filter element is damp after vacuuming liquids. The filter element is likely to clog up more quickly if dry material is vacuumed while it is still damp. For this reason, the filter element

should be dried or replaced by a dry filter element before vacuuming dry materials.

## Blower mode

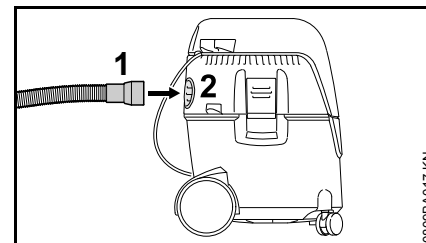

For difficult to reach areas and for all those applications where vacuuming is not possible or advisable.

- Remove suction hose from intake port
- Connect suction hose (1) in exhaust opening (2)

## Adjusting the suction power

The suction power can be adjusted with the adjusting ring if required to avoid lifting light carpets etc. from the floor:

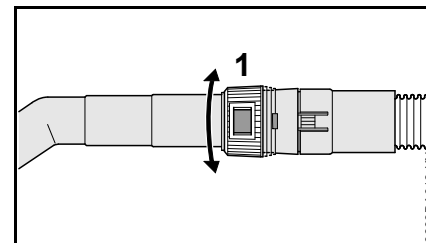

- Turn adjusting ring (1) and adapt suction power to the relevant cleaning task

## Switching Off

### SE 62

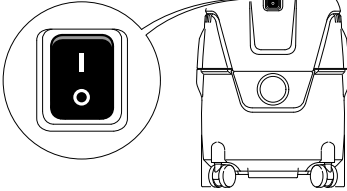

### SE 62 E

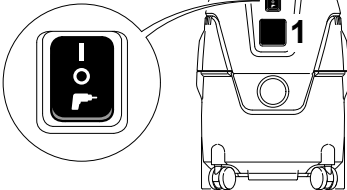

0809BA019 KN

- Turn the master switch to **O**
- Unplug the power plug from the socket

## After Finishing Work

- Empty the container and clean the machine

After vacuuming liquids:

- Remove the upper part of the vacuum cleaner so that the filter element can dry

### SE 62

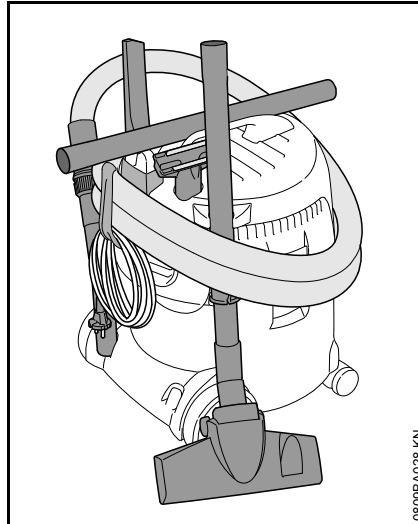

0809BA028 KN

- Roll up the power cord and hang it on the holder
- Fasten the extension tube, suction hose and accessories to the holders provided for this purpose
- The vacuum cleaner must be stored in a dry room and protected against unauthorized use

### SE 62 E

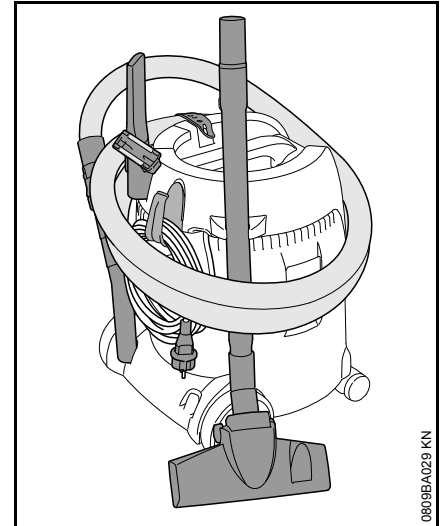

0809BA029 KN

- Roll up the power cord and secure with the rubber strap
- Fasten the extension tube, suction hose and accessories to the holders provided for this purpose
- The vacuum cleaner must be stored in a dry room and protected against unauthorized use

## Emptying the container

- Switch off the vacuum cleaner
- Unplug the power plug from the socket
- Open the container – see “Assembling the machine”

### When dry-vacuuming without filter bag and when wet-vacuuming

- Remove suction hose from intake port
- Empty the container and dispose of its contents in accordance with the applicable regulations

### When dry-vacuuming with filter bag

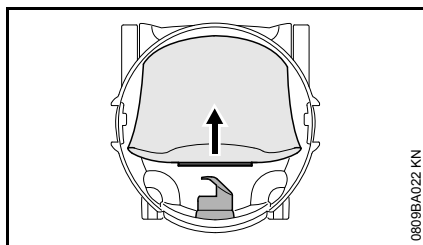

- Pull filter bag sleeve off intake port and seal filter bag sleeve with slide
- Carefully remove filter bag from container and dispose of in accordance with statutory regulations
- Insert new filter bag (instructions on filter bag)
- Push filter bag sleeve onto intake port as far as possible

## Close the container

- Clean the edge of the container
- Fit the upper part of the vacuum cleaner – see “Assembling the machine”
- before fitting the suction hose: Clean the sleeve of the suction hose and intake port

## Cleaning the filter element

- Close slide on hand tube
- Switch on machine

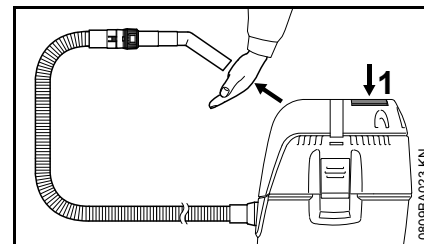

- Press opening of hand tube firmly against the level surface or close by hand
- Press the button (1) to clean filter 3x

Dust deposits are removed from the filter element.

## Replacing the filter element



### NOTICE

Never use the vacuum cleaner with a damaged filter element or without the filter element.

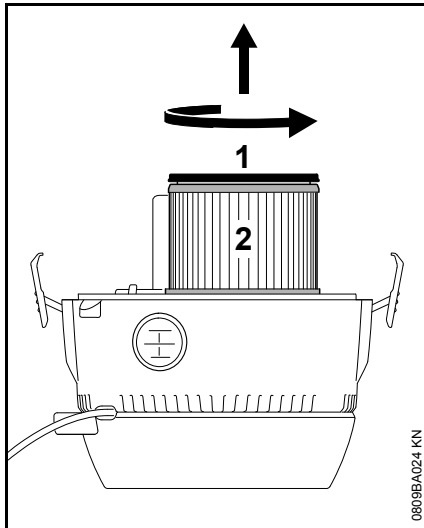

- Unplug the power plug from the socket
- Remove upper part of vacuum cleaner and turn it over
- Turn the cover (1) in the direction of the arrow and remove it
- Remove filter element (2) and dispose of it in accordance with the statutory regulations
- Check correct operation of the float: the float must move easily when the upper part of the vacuum cleaner is turned over
- Fit new filter element in the reverse sequence of steps
- Refit upper part of the vacuum cleaner



## Maintenance and Care

The following intervals apply for normal operating conditions. The specified intervals must be shortened accordingly when working for longer than normal or under difficult cutting conditions (extensive dust, etc.).		Before starting work	At the end of work and/or daily	Weekly	Monthly	If faulty	If damaged	As required
Complete unit	visual inspection (condition)	X						
	Clean		X					
Connecting cable	check	X						
	Have replaced by servicing dealer <sup>1)</sup>						X	
Switch	Function test	X						
	Have replaced by servicing dealer <sup>1)</sup>					X	X	
Ventilation slots in motor housing	Clean							X
Filter bag	change							X
Filter element	Clean							X
	replace						X	
Container	Drain		X					
Accessible screws, nuts and bolts	Tighten							X
Safety information label	replace						X	

<sup>1)</sup> STIHL recommends STIHL dealers

## Minimize Wear and Avoid Damage

Observing the instructions in this manual helps reduce the risk of unnecessary wear and damage to the power tool.

The power tool must be operated, maintained and stored with the due care and attention described in this instruction manual.

The user is responsible for all damage caused by non-observance of the safety precautions, operating and maintenance instructions in this manual. This includes in particular:

- Alterations or modifications to the product not approved by STIHL.
- Using tools or accessories which are neither approved or suitable for the product or are of a poor quality.
- Using the product for purposes for which it was not designed.
- Using the product for sports or competitive events.
- Consequential damage caused by continuing to use the product with defective components.

### Maintenance Work

All the operations described in the "Maintenance Chart" must be performed on a regular basis. If these maintenance operations cannot be performed by the owner, they should be performed by a servicing dealer.

STIHL recommends that you have servicing and repair work carried out exclusively by an authorized STIHL

servicing dealer. STIHL dealers are regularly given the opportunity to attend training courses and are supplied with the necessary technical information.

If these maintenance operations are not carried out as specified, the user assumes responsibility for any damage that may occur. Among other things, this includes:

- Damage to the motor due to neglect or deficient maintenance (e.g. not cleaning cooling air inlets).
- Damage due to incorrect electrical connection (voltage, inadequately rated connecting cords).
- Corrosion and other consequential damage resulting from improper storage.
- Damage to the product resulting from the use of poor quality replacement parts.

### Wear Parts

Some parts of the machine are subject to normal wear and tear even when the machine is used in conformity with its intended use. These parts must be replaced in good time, depending on the nature and duration of use. Among other parts, this includes:

- Filter element, filter bag

## Troubleshooting

### Fault: Motor does not start

Cause	Remedy
Mains circuit-breaker has been tripped	Check and reset mains circuit breaker

### Fault: Motor does not run in automatic mode

Cause	Remedy
Power tool faulty or not plugged in correctly	Check correct operation of power tool and insert plug properly

### Fault: Poor suction performance

Cause	Remedy
Filter bag is full	See "Emptying the container"
Suction hose / tool is clogged	Clean suction hose / tool
Filter element is fouled	See "Cleaning the filter element" and "Replacing the filter element"
Gasket between upper part of vacuum cleaner and container is fouled or faulty	Clean or replace gasket

**Fault: No suction performance when  
wet-vacuuming**

Cause	Remedy
Container full (intake port is sealed by float)	See "Emptying the container"

## Main Parts

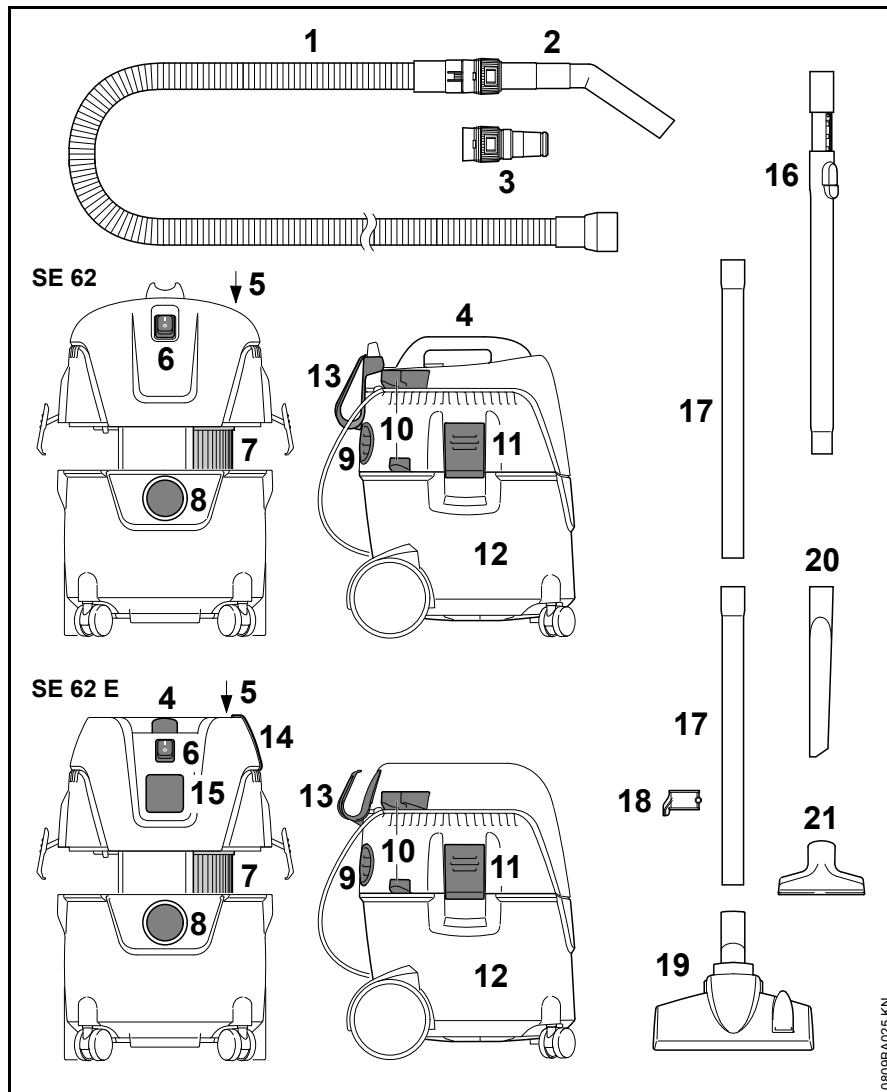

- 1 Suction hose
- 2 Handle tube
- 3 Adapter for electrical power tools<sup>1)</sup>
- 4 Handle
- 5 Filter cleaning button
- 6 Switch
- 7 Filter
- 8 Suction hose connection in suction mode
- 9 Exhaust opening and suction hose connection in blower mode
- 10 Holders for suction tube
- 11 Clip
- 12 Container
- 13 Holders for power cord
- 14 Rubber strap – holder for suction hose<sup>1)</sup>
- 15 Socket outlet<sup>1)</sup>
- 16 Telescoping suction tube<sup>1)</sup>
- 17 Suction tubes
- 18 Extension tube holder
- 19 Kombi floor tool
- 20 Crevice tool
- 21 All-purpose tool

0809BA025 KN

<sup>1)</sup> Supplied with the model SE 62 E

## Specifications

### Motor

Rated voltage:	220 - 240 V
Frequency:	50 Hz
Max. power consumption:	1400 W
Power consumption to EN 60335-2-2:	1000 W
Connected load for socket outlet SE 62 E:	2000 W
Mains fuse:	16 A 10 A <sup>1)</sup>
Protection class SE 62:	II 
Protection class SE 62 E:	I
Type of protection:	IP X4
<sup>1)</sup> only CH, AR	

### Performance data

max. intake capacity, air:	3600 l/min
max. vacuum:	210 mbar

### Dimensions

#### SE 62

Length approx.:	385mm
Width approx.:	377 mm
Height approx.:	506 mm
Container capacity:	20 l
Length of suction hose:	2.5 m
Interior diameter of suction hose:	32 mm

#### SE 62 E

Length approx.:	385mm
Width approx.:	377 mm
Height approx.:	485 mm
Container capacity:	20 l
Length of suction hose:	3.5 m
Interior diameter of suction hose:	32 mm

### Weight

#### SE 62

Ready for operation:	7.5 kg
----------------------	--------

#### SE 62 E

Ready for operation:	8 kg
----------------------	------

### Noise values

#### Sound pressure level $L_p$ to EN 60704-1 (at a distance of 1 m)

70.9 dB(A)

For the sound pressure level, the K-value in accordance with Directive 2006/42/EC = 2 dB(A).

### REACH

REACH is an EC regulation and stands for the Registration, Evaluation, Authorisation and Restriction of Chemical substances.

For information on compliance with the REACH regulation (EC) No. 1907/2006 see [www.stihl.com/reach](http://www.stihl.com/reach).

## Maintenance and Repairs

Users of this machine may only carry out the maintenance and service work described in this user manual. All other repairs must be carried out by a servicing dealer.

STIHL recommends that you have servicing and repair work carried out exclusively by an authorized STIHL servicing dealer. STIHL dealers are regularly given the opportunity to attend training courses and are supplied with the necessary technical information.

When repairing the machine, only use replacement parts which have been approved by STIHL for this power tool or are technically identical. Only use high-quality replacement parts in order to avoid the risk of accidents and damage to the machine.

STIHL recommends the use of original STIHL replacement parts.

Original STIHL parts can be identified by the STIHL part number, the **STIHL** logo and the STIHL parts symbol  (the symbol may appear alone on small parts).

## Disposal

Observe all country-specific waste disposal rules and regulations.

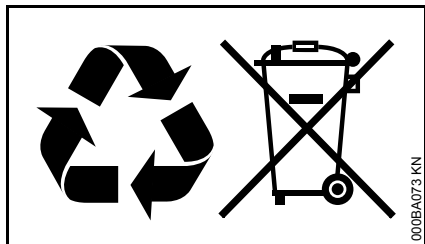

STIHL products must not be thrown in the garbage can. Take the product, accessories and packaging to an approved disposal site for environment-friendly recycling.

Contact your STIHL servicing dealer for the latest information on waste disposal.

## EC Declaration of Conformity

ANDREAS STIHL AG & Co. KG  
Badstr. 115  
D-71336 Waiblingen

Germany

declare under our sole responsibility that

Designation: Wet and dry vacuum cleaner  
Make: STIHL  
Series: SE 62, SE 62 E  
Serial identification number: 4784

conforms to the specifications of Directives 2011/65/EU, 2006/42/EC, 2014/30/EU and 2014/35/EU and has been developed and built in compliance with the versions of the following standards valid at the production date:

EN ISO 12100-1, EN ISO 12100-2,  
EN 60335-1, EN 60335-2-2,  
EN 55014-1, EN 55014-2,  
EN 61000-3-2, EN 61000-3-3

Technical documents deposited at:

ANDREAS STIHL AG & Co. KG  
Produktzulassung

The year of construction, the country of manufacture and the machine number are shown on the machine.

Done at Waiblingen, 15.07.2021  
ANDREAS STIHL AG & Co. KG

PP

A handwritten signature in black ink, appearing to read 'J. Hoffmann', written in a cursive style.

Dr. Jürgen Hoffmann

Director Product Certification &  
Regulatory Affairs

The CE mark, consisting of the letters 'C' and 'E' in a stylized, bold font.

## UKCA Declaration of Conformity

ANDREAS STIHL AG & Co. KG  
Badstr. 115  
D-71336 Waiblingen  
Germany

declare under our sole responsibility that

Designation: Wet and dry vacuum cleaner  
Make: STIHL  
Series: SE 62, SE 62 E  
Serial identification number: 4784

complies with the relevant provisions of the UK regulations The Restriction of the Use of Certain Hazardous Substances in Electrical and Electronic Equipment Regulations 2012, Supply of Machinery (Safety) Regulations 2008, Electromagnetic Compatibility Regulations 2016 and Electrical Equipment (Safety) Regulations 2016 and has been developed and manufactured in accordance with the versions of the following standards valid on the date of manufacture:

EN ISO 12100-1, EN ISO 12100-2,  
EN 60335-1, EN 60335-2-2,  
EN 55014-1, EN 55014-2,  
EN 61000-3-2, EN 61000-3-3

Technical documents deposited at:

ANDREAS STIHL AG & Co. KG

The year of construction, the country of manufacture and the machine number are shown on the machine.

Done at Waiblingen, 15.07.2021  
ANDREAS STIHL AG & Co. KG

pp



Dr. Jürgen Hoffmann  
Director Product Certification &  
Regulatory Affairs



0458-659-0121-B

englisch



[www.stihl.com](http://www.stihl.com)



0458-659-0121-B