

STIHL

STIHL HL-KM

Instruction Manual



Contents

KombiSystem	2
Guide to Using this Manual	2
Safety Precautions and Working Techniques	2
Using the Unit	6
Approved KombiEngines	8
Mounting the KombiTool	9
Assembling the Unit	9
Adjusting the Cutter Bar	10
Fitting the Harness	11
Starting / Stopping the Engine	12
Lubricating the Gearbox	13
Storing the Machine	14
Maintenance and Care	14
Sharpening Instructions	15
Minimize Wear and Avoid Damage	15
Main Parts	16
Specifications	17
Maintenance and Repairs	18
Disposal	18
EC Declaration of Conformity	19
UKCA Declaration of Conformity	20

STIHL

HL-KM

This instruction manual is protected by copyright. All rights reserved, especially the rights to reproduce, translate and process with electronic systems.

Dear Customer,

Thank you for choosing a quality engineered STIHL product.

It has been built using modern production techniques and comprehensive quality assurance. Every effort has been made to ensure your satisfaction and trouble-free use of the product.

Please contact your dealer or our sales company if you have any queries concerning this product.

Your



Dr. Nikolas Stihl

KombiSystem

In the STIHL KombiSystem a number of different KombiEngines and KombiTools can be combined to produce a power tool. In this instruction manual the functional unit formed by the KombiEngine **and** KombiTool is referred to as the power tool.

Therefore, the separate instruction manuals for the KombiEngine and KombiTool should be used together for the power tool.

Always read and and make sure you understand **both** instruction manuals before using your power tool for the first time and keep them in a safe place for future reference.

Guide to Using this Manual

Pictograms

All the pictograms attached to the machine are shown and explained in this manual.

Symbols in text



Warning where there is a risk of an accident or personal injury or serious damage to property.



Caution where there is a risk of damaging the machine or its individual components.

Engineering improvements

STIHL's philosophy is to continually improve all of its products. For this reason we may modify the design, engineering and appearance of our products periodically.

Therefore, some changes, modifications and improvements may not be covered in this manual.

Safety Precautions and Working Techniques



Because a hedge trimmer is a high-speed, fast-cutting power tool with very sharp cutting blades and a long reach, special safety precautions must be observed during operation.



Always read and and make sure you understand both instruction manuals (KombiMotor and KombiTool) before using your power tool for the first time and keep them in a safe place for future reference. Non-observance of the safety precautions may result in serious or even fatal injury.

Lend or rent your power tool only to persons who are familiar with this model and its operation – do not lend your power tool without the KombiMotor and KombiTool instruction manuals.

Use your hedge trimmer only for cutting hedges, shrubs, bushes, scrub and similar materials.

Do not use your power tool for any other purpose because of the **increased risk of accidents**.

Only use cutting blades and accessories that are explicitly approved for this power tool by STIHL or are technically identical. If you have any questions in this respect, consult a servicing dealer.

Use only high quality tools and accessories in order to avoid the risk of accidents and damage to the machine.

STIHL recommends the use of original STIHL tools, cutting attachments and accessories. They are specifically designed to match the product and meet your performance requirements.

Never attempt to modify your machine in any way since this may increase the risk of personal injury. STIHL excludes all liability for personal injury and damage to property caused while using unauthorized attachments.

Do not use a pressure washer to clean your power tool. The solid jet of water may damage parts of the power tool.

Clothing and Equipment

Wear proper protective clothing and equipment.



Clothing must be sturdy but allow complete freedom of movement. Wear snug-fitting clothing, an overall and jacket combination, do not wear a work coat.

Avoid clothing that could get caught on branches or brush or moving parts of the machine. Do not wear a scarf, necktie or jewelry. Tie up long hair so that it is above shoulder level.



Wear steel-toed safety boots with non-slip soles.

WARNING



To reduce the risk of eye injuries, wear close-fitting safety glasses in accordance with European Standard EN 166. Make sure the safety glasses are a comfortable and snug fit.

Wear hearing protection, e.g. earplugs or ear muffs.

Wear a safety hard hat with chin strap where there is a danger of head injuries from falling objects.



Wear heavy-duty work gloves made of durable material (e.g. leather).

STIHL offers a comprehensive range of personal protective clothing and equipment.

Transporting the Power Tool

Always shut off the engine.

Always fit the blade guard (scabbard) – even when you carry the unit for short distances.

On units with adjustable cutter bar: Engage the cutter bar in position.

On units with a defined transport position: Move the cutter bar to the transport position and make sure it is properly engaged.

Carry the power tool properly balanced by the drive tube – cutting blades behind you.

To reduce the risk of serious burn injuries, avoid touching hot parts of the machine, including the gearbox housing.

Transporting by vehicle: Properly secure your power tool to prevent turnover, fuel spillage and damage.

Before Starting

Check that your power tool is properly assembled and in good condition – refer to appropriate chapters in the KombiMotor and KombiTool instruction manuals.

- Cutting blades: Correctly assembled, securely mounted and in good condition (clean, move freely, not warped), properly sharpened and sprayed thoroughly with STIHL resin solvent (lubricant).
- On units with adjustable cutter bar: Make sure the adjuster is properly engaged in the required position for starting.
- On units with a defined transport position (cutter bar folded against drive tube): Never attempt to start the unit in the transport position.
- Never attempt to modify the controls or safety devices in any way.
- Keep the handles dry and clean – free from oil and dirt – for safe control of the power tool.
- Adjust shoulder strap and handles to suit your height and reach. See chapter on "Fitting the Harness".

To reduce the risk of accidents, operate your power tool only if it is in a safe condition.

If you use a shoulder strap or full harness: Practice removing and putting down the machine as you would in an emergency. To avoid damage, do not throw the machine to the ground when practicing.

Holding and Controlling the Power Tool

Always hold the power tool firmly with both hands on the handles.

Make sure you have firm and secure footing and hold the power tool so that the cutting blades are always away from your body.

Some versions of the machine can be carried on a harness to relieve the weight on the operator's arms.

Models with Loop Handle

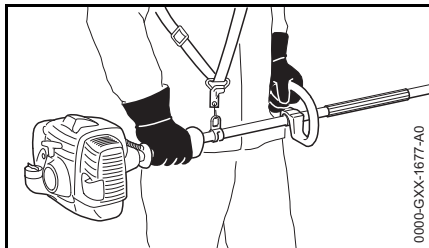

Right hand on control handle, left hand on loop handle on drive tube, even if you are left-handed. Wrap fingers and thumbs firmly around the handles.

Machines with handle hose

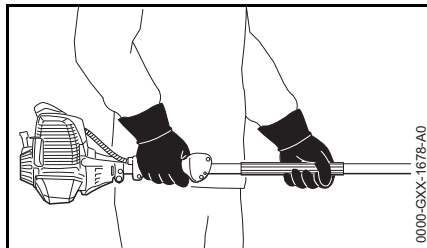

Right hand on control handle, left hand on handle hose on drive tube, even if you are left-handed. Wrap fingers and thumbs firmly around the handles.

During Operation

In the event of impending danger or in an emergency, switch off the engine immediately by moving the slide control / stop switch/button to **0** or **STOP**.



This power tool is not insulated against electric shock. **To reduce the risk of electrocution**, keep well clear of electric power lines.

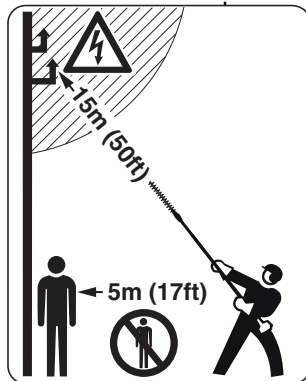

To reduce the risk of injury from moving blades or falling cuttings, do not allow bystanders within 5 meters of your own position. **To reduce the risk of damage to property**, also maintain this distance from other objects (vehicles, windows).

Maintain a minimum clearance of 15 meters between the tip of the cutter bar and electric power lines. Electricity can jump considerable distances by means of arcing. Higher voltage increases the distance electricity can arc. Have the power switched off before starting work in the immediate vicinity of power lines.

Make sure the idle speed setting is correct. The cutting blades must not run when the engine is idling with the throttle trigger released. Check and correct the idle speed setting regularly. If the cutting blades still run when the engine is idling, have your dealer check your machine and make proper adjustments or repairs. Check and correct the idle speed setting regularly.

Watch the cutting blades at all times – do not cut areas of the hedge that you cannot see.

Be extremely careful when cutting tall hedges, check the other side of the hedge before starting work.



The gearbox becomes hot during operation. **To reduce the risk of burn injury**, do not touch the gearbox housing.

Take special care in slippery conditions (ice, wet ground, snow) – on slopes or uneven ground.

Clear away fallen branches, scrub and cuttings from the work area.

Watch out for obstacles: Roots and tree stumps which **could cause you to trip or stumble**.

Make sure you always have good balance and secure footing.

When working at heights:

- Always use a lift bucket
- Never work on a ladder or in a tree
- Never work on an insecure support
- Never operate your power tool with one hand

Be particularly alert and cautious when wearing hearing protection because your ability to hear warnings (shouts, alarms, etc.) is restricted.

To reduce the risk of accidents, take a break in good time to avoid tiredness or exhaustion.

Work calmly and carefully – in daylight conditions and only when visibility is good. Stay alert so as not to endanger others.

Inspect the hedge and work area to avoid damaging the cutting blades:

- Remove stones, rocks, pieces of metal and other solid objects.
- When working close to the ground, make sure that no sand, grit or stones get between the blades.
- Take particular care when cutting hedges next to or against wire fences.

To avoid the risk of electrocution, do not touch electric power lines – never cut through electric power lines.



Do not touch the cutting blades while the motor is running. If the cutting blades become jammed by an object, switch off the engine immediately before attempting to remove the object – **there is otherwise a risk of injury**.

Opening the throttle while the blades are blocked increases the load and reduces engine speed. The clutch then slips continuously and this causes overheating and damage to important components (e.g. clutch, polymer housing components) – and **this can increase the risk of injury** from the cutting blades moving while the engine is idling.

If your power tool is subjected to unusually high loads for which it was not designed (e.g. heavy impact or a fall), always check that it is in good condition before continuing work – see also "Before Starting". Make sure the safety devices are working properly. Do not continue operating your power tool if it is damaged. In case of doubt, consult your servicing dealer.

If the hedge is very dusty or dirty, spray the blades with STIHL resin solvent from time to time during cutting. This helps greatly reduce blade friction as well as the aggressive effects of sap and the build-up of dirt particles.

Check the cutting attachment at regular short intervals during operation or immediately if there is a noticeable change in cutting behavior:

- Stopping the Engine
- Wait until the cutting blades have come to a complete standstill.
- Check condition and tightness, look for cracks.
- Check sharpness.

After Finishing Work

After finishing work or before leaving the power tool unattended: Shut off the engine.

Always clean dust and dirt off the machine – do not use any grease solvents for this purpose.

Spray the blades with STIHL resin solvent. Run the motor briefly to ensure that the solvent is evenly distributed.

Maintenance and Repairs

Service the machine regularly. Do not attempt any maintenance or repair work not described in the KombiTool and KombiEngine instruction manuals. Have all other work performed by a servicing dealer.

STIHL recommends that you have servicing and repair work carried out exclusively by an authorized STIHL servicing dealer. STIHL dealers are regularly given the opportunity to attend training courses and are supplied with the necessary technical information.

Only use high-quality replacement parts in order to avoid the risk of accidents and damage to the machine. If you have any questions in this respect, consult a servicing dealer.

STIHL recommends the use of genuine STIHL replacement parts. They are specifically designed to match your model and meet your performance requirements.

To reduce the risk of injury, **always shut off the engine** before carrying out any maintenance or repairs or cleaning the machine.

Using the Unit

Cutting Season

Observe country-specific or municipal rules and regulations for cutting hedges.

Do not use your hedge trimmer during rest periods customary in the neighborhood.

Cutting Sequence

If a radical cut is necessary, cut a little at a time in several stages.

Use lopping shears to cut out thick branches first.

Cut the sides of the hedge first, then the top.

Disposal

Do not throw cuttings into the garbage can – they can be composted.

Preparations

- Adjustable gearbox: Set cutter bar to required angle.
- Remove the blade scabbard.
- Start the engine.
- If you use a harness: Put on the harness and attach it to the machine.

Working Techniques

Horizontal Cut (with cutter bar at an angle)



Cutting close to the ground from a standing position, e.g. low shrubs.

Swing the cutter bar up and down as you move along the hedge – use both sides of the cutting blades, do not rest the cutter bar on the ground.

Vertical Cut (with cutter bar at an angle)

Cutting without standing directly next to the hedge, e.g. flowerbed between operator and hedge.

Swing the cutter bar up and down in an arc as you move along the hedge – use both sides of the cutting blades.

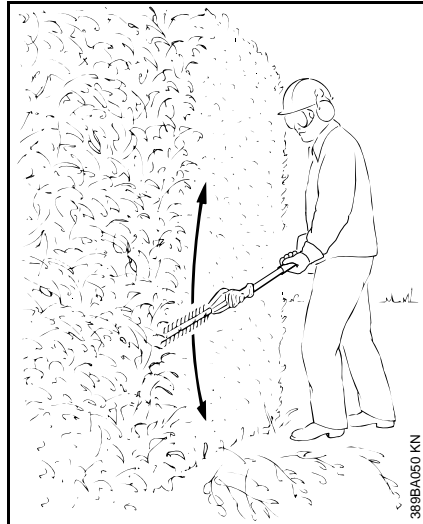
Vertical Cut (with straight cutter bar)

Extra long reach without the need for other aids.

Swing the cutter bar up and down in an arc as you move along the hedge – use both sides of the cutting blades.

Overhead Cut (with cutter bar at an angle)

Hold the hedge trimmer vertically and swing it in an arc to make maximum use of its reach.

! WARNING

Any working position above head height is tiring. To minimize the risk of accidents, work in such positions for short periods only. Set angle of adjustable cutter bar to maximum so that the unit can be held in a lower, less tiring position (with shoulder strap) while still providing adequate reach.

Horizontal Cut (with straight cutter bar)

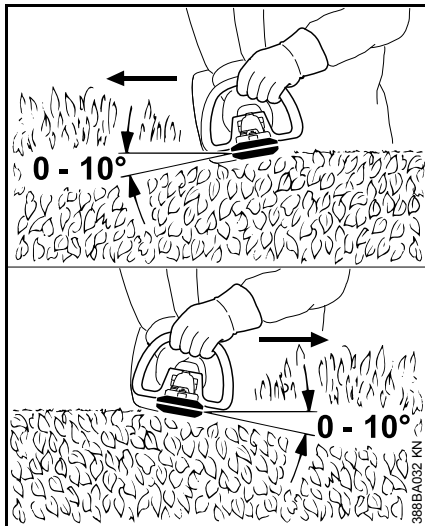

Hold the cutter bar at an angle of 0° to 10° as you swing the hedge trimmer horizontally.

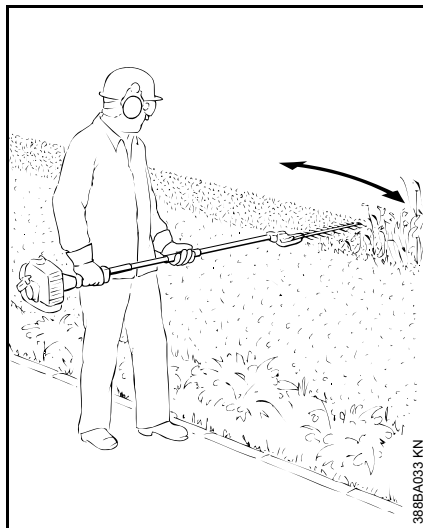

Swing the cutter bar in an arc towards the outside of the hedge so that the cuttings are swept to the ground.

Recommendation: Only cut hedges that are no more than chest height.

Approved KombiEngines

KombiEngines

Only use KombiEngines supplied or explicitly approved by STIHL for use with the attachment.

This KombiTool may be operated only in combination with the following KombiEngines:

KM 56 R, KM 85 R¹⁾, KM 94 R,
KM 111 R, KM 131, KM 131 R, KMA
130 R, KMA 135 R



WARNING

The HL-KM 0° is not approved for use on KombiEngines with a bike handle.

Brushcutters with split shaft

The KombiTool can also be fitted to STIHL brushcutters with a split shaft (T-models) (basic power tools).

This KombiTool can therefore also be used on the following machine:

STIHL FR 131 T



WARNING

Refer to the user manual of the power tool for use of the barrier bar.

Mounting the KombiTool

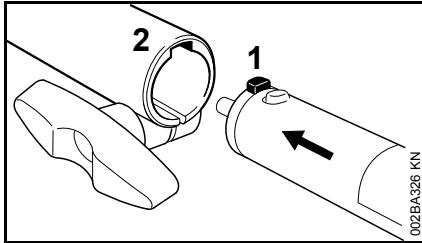

- Push the lug (1) on the drive tube into the slot (2) in the coupling sleeve as far as stop.

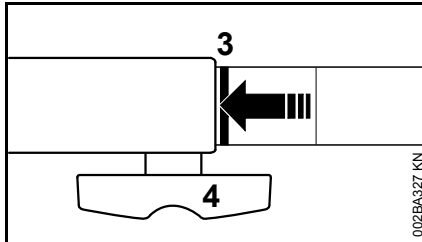

When correctly installed, the red line (3) (arrow point) must be flush with the end of the coupling sleeve.

- Tighten down the star knob (4) **firmly**.

Removing the KombiTool

- Reverse the above sequence to remove the drive tube.

Assembling the Unit

Removing the Protective Cap

If a cap is fitted on the end of the KombiTool's or basic power tool's drive tube:

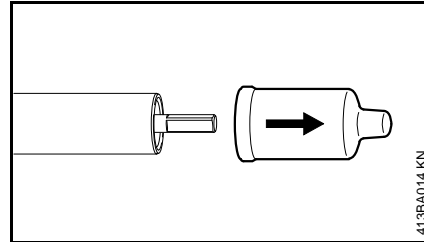

- Pull the protective cap off the end of the drive tube and keep it in a safe place.

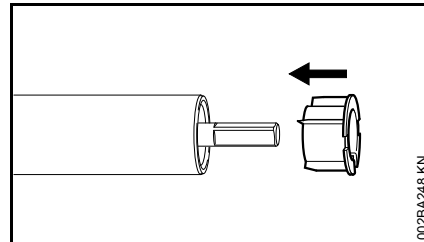

If the plug comes out of the drive tube when you pull off the cap:

- Push the plug into the drive tube as far as stop.

Mounting the Gearbox

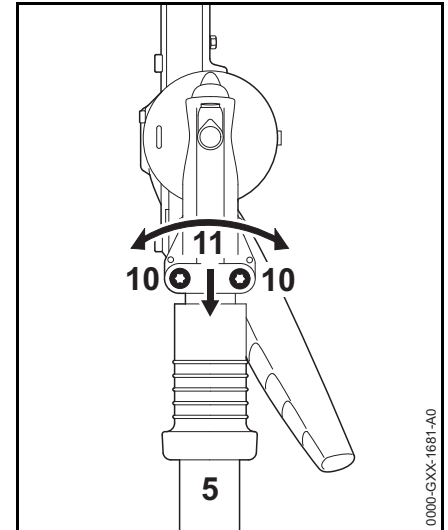

- Loosen the clamp screws (10).
- Push the gearbox (11) onto the drive tube (5), turn the gearbox (11) back and forth as necessary.

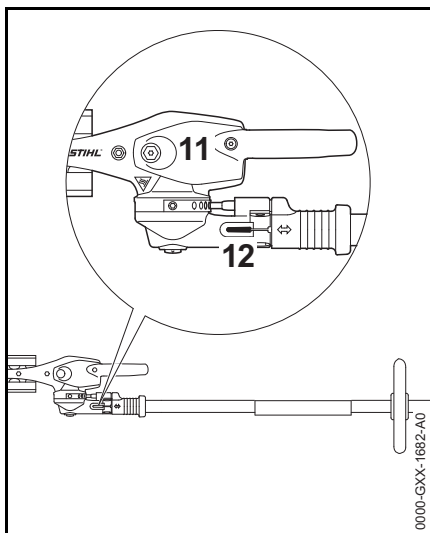

Once the end of the drive tube is inserted beyond the slot in the clamp (12):

- Push the gearbox (11) fully home as far as stop.
- Tighten down the clamp screws moderately.
- Line up the gearbox (11) with the powerhead.
- Tighten down the clamp screws firmly.

Adjusting the Cutter Bar

Angle Adjuster - 145°

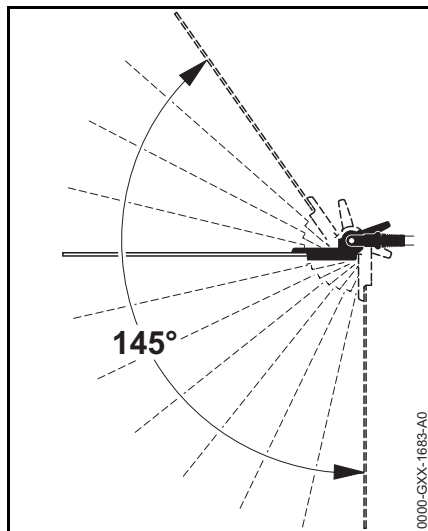

The angle of the cutter bar can be adjusted upwards in 4 stages from 0° (straight) to 55°, and downwards in 7 stages from 0° to 90° (right angle facing down). There are therefore 12 possible working positions.

! WARNING

To reduce the risk of injury, carry out the adjustment only when the cutting blades are at a standstill – engine at idle speed.

! WARNING

The gearbox gets hot during operation. To reduce the risk of burn injury, do not touch the gearbox.

! WARNING

To reduce the risk of injury, never touch the blades while making adjustments.

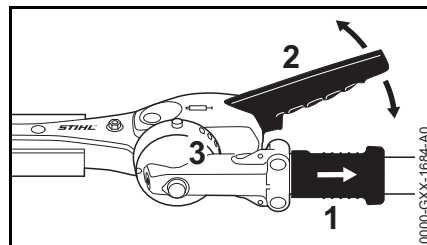

- Pull back the sliding sleeve (1) and use the lever (2) to adjust the joint by one or several holes.
- Release the sliding sleeve (1) and make sure the lock pin engages the quadrant (3).

Transport Position

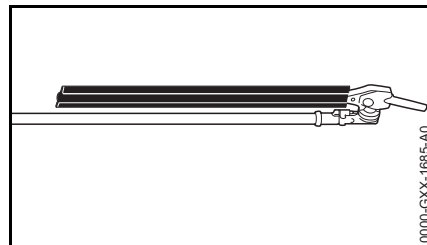

The cutter bar can be folded flat against the drive tube and locked in position to save space during transportation.

! WARNING

To reduce the risk of injury, always shut off the engine – depress stop switch – and fit the blade scabbard before

moving the cutter bar to the transport position or from the transport position to the normal working position.

! WARNING

The gearbox gets hot during operation. **To reduce the risk of burn injury**, do not touch the gearbox.

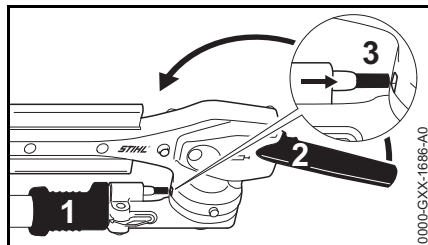

- Shut off the engine.
- Fit the blade scabbard.
- Pull back the sliding sleeve (1) and use the lever (2) to swing the joint upwards – in direction of drive tube – until the cutter bar is flat against the drive tube.
- Release the sliding sleeve (1) and make sure the lock pin engages the quadrant (3).

Fitting the Harness

The type and style of the harness and carabiner (spring hook) depend on the market.

Shoulder Strap

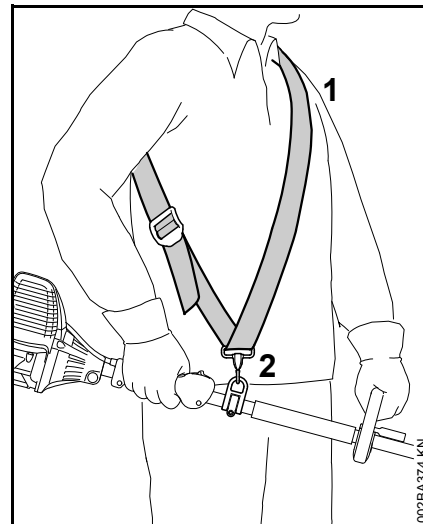

- Put on the shoulder strap (1).
- Adjust the length of the strap so that the carabiner (2) is about a hand's width below your right hip.

Full Harness

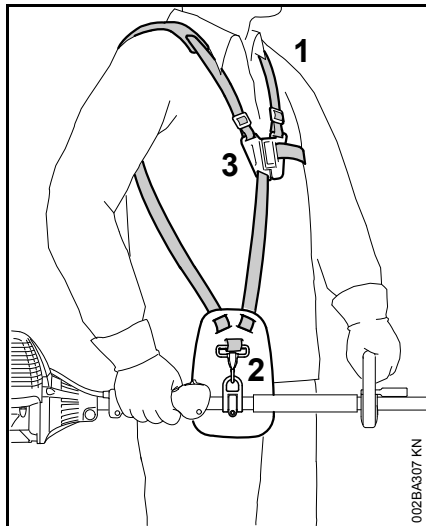

- Put on the full harness (1).
- Adjust the length of the strap so that the carabiner (2) is about a hand's width below your right hip.
- Close the locking plate (3).

Attaching Machine to Harness

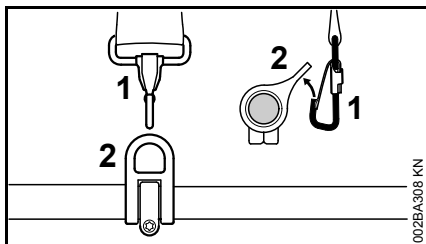

- Attach the carabiner (1) to the carrying ring (2) on the drive tube – hold the carrying ring steady.

Disconnecting Machine from Harness

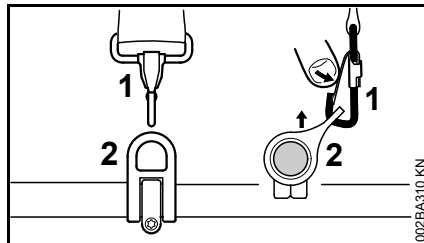

- Press down the bar on the carabiner (1) and pull the carrying ring (2) out of the carabiner.

Throwing Off the Machine



WARNING
The machine must be quickly thrown off in the event of imminent danger. Practice removing and putting down the machine as you would in an emergency. To avoid damage, do not throw the machine to the ground when practicing.

Practice quickly detaching the power tool from the carabiner as described under "Disconnecting Machine from Harness".

If you are using a shoulder strap: Practice slipping the strap off your shoulder.

If you are using a full harness: Practice quickly opening the locking plate and slipping the harness straps off your shoulders.

Starting / Stopping the Engine

Starting the Engine

Always follow the operating instructions for the KombiEngine and basic power tool.

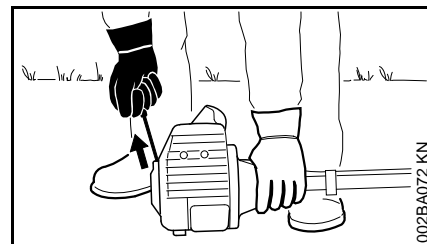
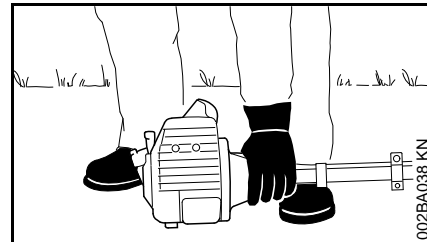

- Place the machine on the ground so that it rests securely on the engine support and the gearbox.
- On models with an adjustable cutter bar: Set the cutter bar to the straight (0°) position.
- Remove the blade scabbard.

To reduce the risk of accidents, check that the cutting blades are not touching the ground of any other obstacles.

- If necessary, rest the gearbox on a raised support (e.g. mound, brick or something similar).
- Make sure you have a firm footing, either standing, stooping or kneeling.
- Hold the machine with you left hand and press it down **firmly** – do not touch the controls on the control handle – see KombiEngine or basic power tool instruction manual.

**NOTICE**

Do not stand or kneel on the drive tube.

**WARNING**

The cutting attachment may begin to move as soon as the engine starts. For this reason, blip the throttle after starting – the engine returns to idling speed.

The starting procedure is now as described in the instruction manual of the KombiEngine or basic power tool you are using.

Stopping the Engine

- See KombiEngine or basic power tool instruction manual.

Lubricating the Gearbox

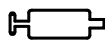

Blade Drive Gear

Lubricate the blade drive gear with STIHL gear lubricant for hedge trimmers – see "Special Accessories".

HL 0° version

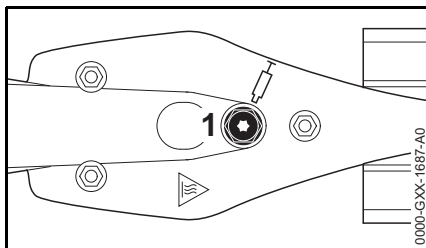

Adjustable HL 145° version

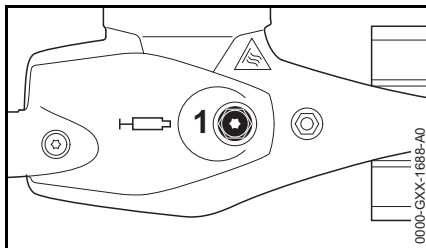

- Check the lubricant level at regular intervals of about every 25 hours of operation. Unscrew the filler

plug (1) – if no grease can be seen on the inside of the filler plug, screw the tube of grease into the filler hole.

- Squeeze up to 10 g (2/5 oz) grease into the gearbox.

**NOTICE**

Do not completely fill the gearbox with grease.

- Unscrew the tube of grease from the filler hole.
- Refit the filler plug and tighten it down firmly.

Angle Drive Gear

Lubricate the angle drive gear with STIHL gear lubricant for hedge trimmers (special accessory).

Adjustable HL 145° version

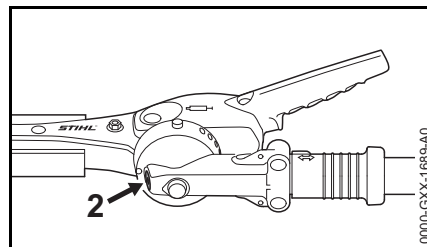

- Check the lubricant level at regular intervals of about every 25 hours of operation. Unscrew the filler plug (2) – if no grease can be seen on the inside of the filler plug, screw the tube of grease into the filler hole.
- Squeeze up to 5 g (1/5 oz) grease into the gearbox.



NOTICE

Do not completely fill the gearbox with grease.

- Unscrew the tube of grease from the filler hole.
- Refit the filler plug and tighten it down firmly.

Storing the Machine

For periods of about 3 months or longer

- Clean the cutting blades, check condition and spray them with STIHL resin solvent.
- Fit the blade scabbard.
- If the KombiTool is removed from the KombiEngine and stored separately: Fit the protective cap on the drive tube to protect it from dust and dirt.
- Store the machine in a dry and secure location. Keep out of the reach of children and other unauthorized persons.

Maintenance and Care

The following intervals apply to normal operating conditions only. If your daily working time is longer or operating conditions are difficult (very dusty work area, etc.), shorten the specified intervals accordingly.

All accessible screws and nuts

- Check and retighten if necessary (not screws and nuts on cutting blades)

Cutting blades

- Visual inspection before starting work
- Resharpener as necessary
- Replace if damaged

Gearbox lubrication

- Check before starting work
- Replenish as necessary

Safety labels

- Replace illegible safety labels

Sharpening Instructions

When cutting performance and behavior begin to deteriorate, i.e. blades frequently snag on branches: Resharpener the cutting blades.

It is best to have the cutting blades resharpened by a dealer on a workshop sharpener. STIHL recommends a STIHL servicing dealer.



NOTICE

Do not operate your machine with dull or damaged cutting blades. This may cause overload and will give unsatisfactory cutting results.

Minimize Wear and Avoid Damage

Observing the instructions in this manual and the KombiEngine manual helps reduce the risk of unnecessary wear and damage to the power tool.

The power tool must be operated, maintained and stored with the due care and attention described in these instruction manuals.

The user is responsible for all damage caused by non-observance of the safety precautions, operating and maintenance instructions. This includes in particular:

- Alterations or modifications to the product not approved by STIHL.
- Using tools or accessories which are neither approved or suitable for the product or are of a poor quality.
- Using the product for purposes for which it was not designed.
- Using the product for sports or competitive events.
- Consequential damage caused by continuing to use the product with defective components.

Maintenance Work

All the operations described in the chapter on "Maintenance and Care" must be performed on a regular basis. If these maintenance operations cannot be performed by the owner, they should be performed by a servicing dealer.

STIHL recommends that you have servicing and repair work carried out exclusively by an authorized STIHL

servicing dealer. STIHL dealers are regularly given the opportunity to attend training courses and are supplied with the necessary technical information.

If these maintenance operations are not carried out as specified, the user assumes responsibility for any damage that may occur. Among other parts, this includes:

- Corrosion and other consequential damage resulting from improper storage.
- Damage to the product resulting from the use of poor quality replacement parts.

Parts Subject to Wear and Tear

Some parts of the power tool (e.g. cutting blades) are subject to normal wear and tear even during regular operation in accordance with instructions and, depending on the type and duration of use, have to be replaced in good time.

Main Parts

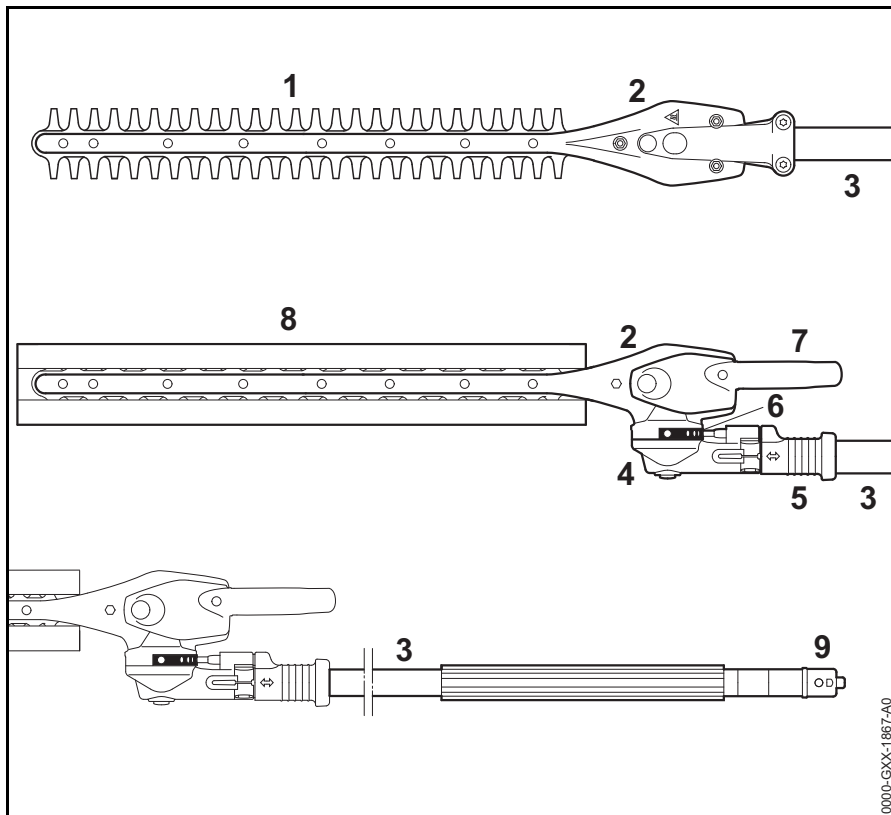

- 1 Cutting blades
- 2 Blade drive gear
- 3 Drive tube
- 4 Angle drive
- 5 Sliding sleeve
- 6 Quadrant
- 7 Adjusting lever
- 8 Blade guard (scabbard)
- 9 Cap

0000-GXX-1867-A0

Specifications

Cutting Blades

Type:	Double-edged for bidirectional cutting
Cutting length:	500 mm, 600 mm
Tooth spacing:	34 mm
Tooth height:	22 mm
Sharpening angle:	45° to horizontal

Weight

HL-KM 0° 500 mm:	1.7 kg
HL-KM 145° 500 mm:	2.4 kg
HL-KM 145° 600 mm:	2.6 kg

Sound and Vibration Levels

Noise and vibration data measurements on power tools with the HL-KM KombiTool include idling and rated maximum speed in a ratio of 1:4.

For further details on compliance with Vibration Directive 2002/44/EC see www.stihl.com/vib

Sound pressure level L_{peq} in accordance with ISO 22868

	0°	145°
	500 mm	500 mm, 600 mm
HL-KM		
KM 56 R:	95 dB(A)	92 dB(A)
KM 85 R:	95 dB(A)	94 dB(A)
KM 94 R:	95 dB(A)	93 dB(A)
KM 111 R:	93 dB(A)	93 dB(A)
KM 131:	-	94 dB(A)
KM 131 R:	94 dB(A)	94 dB(A)
KMA 130 R:	83 dB(A)	83 dB(A)
KMA 135 R:		81.8 dB(A)
FR 131 T:	94 dB(A)	94 dB(A)

Sound pressure level L_{peq} in accordance with EN 50636-2-91

	0°
	600 mm
HL-KM	
KMA 135 R:	85.3 dB(A)

Sound power level L_w in accordance with ISO 22868

	0°	145°
	500 mm	500 mm, 600 mm
HL-KM		
KM 56 R:	108 dB(A)	106 dB(A)
KM 85 R:	109 dB(A)	109 dB(A)
KM 94 R:	106 dB(A)	106 dB(A)
KM 111 R:	108 dB(A)	108 dB(A)
KM 131:	-	109 dB(A)
KM 131 R:	109 dB(A)	109 dB(A)
KMA 130 R:	94 dB(A)	93 dB(A)
KMA 135 R:		92 dB(A)
FR 131 T:	109 dB(A)	109 dB(A)

Sound power level L_w in accordance with EN 50636-2-91

	0°
	600 mm
HL-KM	
KMA 135 R:	92.5 dB(A)

Vibration level $a_{hv,eq}$ in accordance with ISO 22867

HL-KM 0° 500 mm	Handle, left	Handle, right
KM 56 R:	7.9 m/s ²	7.9 m/s ²
KM 85 R:	6.2 m/s ²	6.8 m/s ²
KM 94 R:	6.6 m/s ²	6.9 m/s ²
KM 111 R:	6.2 m/s ²	4.2 m/s ²
KM 131 R:	6.1 m/s ²	4.3 m/s ²
KMA 130 R:	3.5 m/s ²	3.0 m/s ²
KMA 135 R:	3.7 m/s ²	3.7 m/s ²
FR 131 T	8.5 m/s ²	5.3 m/s ²

HL-KM 145° 500 mm, 600 mm	Handle, left	Handle, right
KM 56 R:	5.9 m/s ²	7.9 m/s ²
KM 85 R:	3.7 m/s ²	4.6 m/s ²
KM 94 R:	5.5 m/s ²	4.6 m/s ²
KM 111 R:	3.8 m/s ²	3.7 m/s ²
KM 131:	2.9 m/s ²	3.2 m/s ²
KM 131 R:	3.4 m/s ²	5.2 m/s ²
KMA 130 R:	2.5 m/s ²	2.3 m/s ²
KMA 135 R:	3.4 m/s ²	2.3 m/s ²
FR 131 T:	4.2 m/s ²	2.9 m/s ²

The K-factor in accordance with Directive 2006/42/EC is 2.0 dB(A) for the sound pressure level and sound power level; the K-factor in accordance with Directive 2006/42/EC is 2.0 m/s² for the vibration level.

REACH

REACH is an EC regulation and stands for the Registration, Evaluation, Authorisation and Restriction of Chemical substances.

For information on compliance with the REACH regulation (EC) No. 1907/2006 see www.stihl.com/reach.

Maintenance and Repairs

Users of this machine may only carry out the maintenance and service work described in this user manual. All other repairs must be carried out by a servicing dealer.

STIHL recommends that you have servicing and repair work carried out exclusively by an authorized STIHL servicing dealer. STIHL dealers are regularly given the opportunity to attend training courses and are supplied with the necessary technical information.

When repairing the machine, only use replacement parts which have been approved by STIHL for this power tool or are technically identical. Only use high-quality replacement parts in order to avoid the risk of accidents and damage to the machine.

STIHL recommends the use of original STIHL replacement parts.

Original STIHL parts can be identified by the STIHL part number, the **STIHL** logo and the STIHL parts symbol  (the symbol may appear alone on small parts).

Disposal

Observe all country-specific waste disposal rules and regulations.

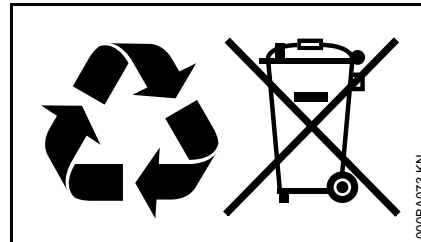

STIHL products must not be thrown in the garbage can. Take the product, accessories and packaging to an approved disposal site for environment-friendly recycling.

Contact your STIHL servicing dealer for the latest information on waste disposal.

EC Declaration of Conformity

ANDREAS STIHL AG & Co. KG
Badstr. 115
D-71336 Waiblingen

Germany

declare under our sole responsibility that

Designation: Hedge trimmer
KombiTool

Make: STIHL

Series: HL-KM

Serial identification
number: 4243

conforms to the relevant provisions of Directives 2006/42/EC and 2000/14/EC and has been developed and manufactured in compliance with the following standards in the versions valid on the date of production:

EN ISO 12100, EN ISO 10517 (in conjunction with the specified KM models).

EN ISO 12100, EN 60745-1, EN 60745-2-15 (in conjunction with KMA 130 R)

EN ISO 12100, EN 62841-1, EN 62841-4-2 (in conjunction with KMA 135 R)

EN ISO 12100 (in conjunction with the specified FR models).

The measured and the guaranteed sound power level have been determined in accordance with Directive 2000/14/EC, Annex V, and standard ISO 11094.

Measured sound power level

with KM 56 R: 102 dB(A)
with KM 85 R: 103 dB(A)
with KM 94 R: 101 dB(A)
with KM 111 R: 101 dB(A)
with KM 131: 102 dB(A)
with KM 131 R: 102 dB(A)
with KMA 130 R: 93 dB(A)
with KMA 135 R: 92.5 dB(A)
with FR 131 T: 102 dB(A)

Guaranteed sound power level

with KM 56 R: 104 dB(A)
with KM 85 R: 105 dB(A)
with KM 94 R: 103 dB(A)
with KM 111 R: 103 dB(A)
with KM 131: 104 dB(A)
with KM 131 R: 104 dB(A)
with KMA 130 R: 95 dB(A)
with KMA 135 R: 95 dB(A)
with FR 131 T: 104 dB(A)

Technical documents deposited at:

ANDREAS STIHL AG & Co. KG
Produktzulassung

The year of manufacture is specified on the power tool.

Waiblingen, 15.07.2021

ANDREAS STIHL AG & Co. KG

pp

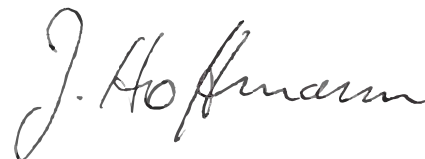

Dr. Jürgen Hoffmann

Director Product Certification &
Regulatory Affairs



UKCA Declaration of Conformity

ANDREAS STIHL AG & Co. KG
Badstr. 115
D-71336 Waiblingen

Germany

declare under our sole responsibility that

Designation: Hedge trimmer
KombiTool
Make: STIHL
Series: HL-KM
Serial identification
number: 4243

conforms to the relevant provisions of the UK regulations Supply of Machinery (Safety) Regulations 2008 and Noise Emission in the Environment by Equipment for use Outdoors Regulations 2001 and has been manufactured in compliance with the following standards in the versions valid on the date of production:

EN ISO 12100, EN ISO 10517 (in conjunction with the specified KM models).

EN ISO 12100, EN 60745-1, EN 60745-2-15 (in conjunction with KMA 130 R)

EN ISO 12100, EN 62841-1, EN 62841-4-2 (in conjunction with KMA 135 R)

EN ISO 12100 (in conjunction with the specified FR models).

The measured and guaranteed sound power levels were determined in accordance with the UK regulation Noise Emission in the Environment by

Equipment for Use Outdoors Regulations 2001, Schedule 8, using the ISO 11094 standard.

Measured sound power level

with KM 56 R: 102 dB(A)
with KM 85 R: 103 dB(A)
with KM 94 R: 101 dB(A)
with KM 111 R: 101 dB(A)
with KM 131: 102 dB(A)
with KM 131 R: 102 dB(A)
with KMA 130 R: 93 dB(A)
with KMA 135 R: 92.5 dB(A)
with FR 131 T: 102 dB(A)

Guaranteed sound power level

with KM 56 R: 104 dB(A)
with KM 85 R: 105 dB(A)
with KM 94 R: 103 dB(A)
with KM 111 R: 103 dB(A)
with KM 131: 104 dB(A)
with KM 131 R: 104 dB(A)
with KMA 130 R: 95 dB(A)
with KMA 135 R: 95 dB(A)
with FR 131 T: 104 dB(A)

Technical documents deposited at:

ANDREAS STIHL AG & Co. KG

The year of manufacture is indicated on the power tool.

Waiblingen, 15.07.2021

ANDREAS STIHL AG & Co. KG

pp



Dr. Jürgen Hoffmann

Director Product Certification &
Regulatory Affairs



0458-475-0121-D

englisch



www.stihl.com



0458-475-0121-D