

STIHL

STIHL MM 56

Instruction Manual



Contents

MultiSystem	2
Guide to Using this Manual	2
Safety Precautions and Working Techniques	2
Approved MultiTools	7
Adjusting the bicycle handle	8
Fuel	8
Fueling	9
Starting / Stopping the Engine	10
Extra weight	12
Wheels	13
Operating Instructions	14
Replacing the Air Filter	14
Adjusting the Carburetor	15
Spark Arresting Screen in Muffler	15
Spark Plug	15
Engine Running Behavior	16
Storing the Machine	17
Maintenance and Care	18
Minimize Wear and Avoid Damage	19
Main Parts	20
Specifications	21
Maintenance and Repairs	22
Disposal	23
EC Declaration of Conformity	23

Dear Customer,

Thank you for choosing a quality engineered STIHL product.

It has been built using modern production techniques and comprehensive quality assurance. Every effort has been made to ensure your satisfaction and trouble-free use of the product.

Please contact your dealer or our sales company if you have any queries concerning this product.

Your



Dr. Nikolas Stihl

STIHL

MultiSystem

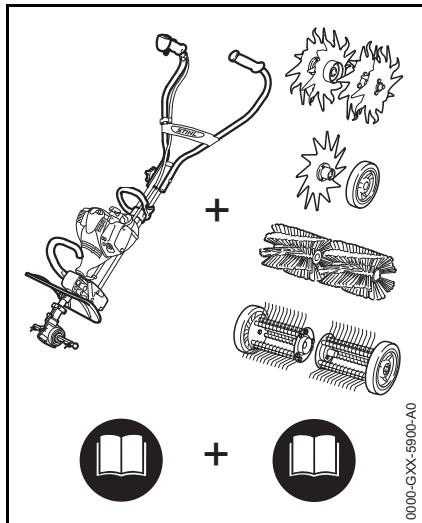

In the STIHL MultiSystem a number of different MultiEngines and MultiTools can be combined to produce a power tool. In this instruction manual the functional unit formed by the MultiEngine **and** MultiTool is referred to as the power tool.

Therefore, the separate instruction manuals for the MultiEngine and MultiTool should be used together for the power tool.

Always read and and make sure you understand **both** instruction manuals before using your power tool for the first time and keep them in a safe place for future reference.

Guide to Using this Manual

Pictograms

All the pictograms attached to the machine are shown and explained in this manual.

Symbols in text



WARNING

Warning where there is a risk of an accident or personal injury or serious damage to property.



NOTICE

Caution where there is a risk of damaging the machine or its individual components.

Engineering improvements

STIHL's philosophy is to continually improve all of its products. For this reason we may modify the design, engineering and appearance of our products periodically.

Therefore, some changes, modifications and improvements may not be covered in this manual.

Safety Precautions and Working Techniques



Special safety precautions must be observed when working with a power tool.



Always read and and make sure you understand both instruction manuals (MultiEngine and MultiTool) before using your power tool for the first time and keep them in a safe place for future reference. Non-observance of the safety precautions may result in serious or even fatal injury.

Observe all applicable local safety regulations, standards and ordinances.

If you have not used this type of power tool before: Have your dealer or other experienced user show you how it is operated or attend a special course in its operation.

Minors should never be allowed to use a power tool.

Keep bystanders, especially children, and animals away from the work area.

When the power tool is not in use, shut it off so that it does not endanger others. Secure it against unauthorized use.

The user is responsible for avoiding injury to third parties or damage to their property.

Lend or rent your power tool only to persons who are familiar with this model and its operation – do not lend or rent your power tool without the MultiEngine and MultiTool instruction manuals.

The use of noise emitting power tools may be restricted to certain times by national or local regulations.

To operate the power tool you must be rested, in good physical condition and mental health.

If you have any condition that might be aggravated by strenuous work, check with your doctor before operating a power tool.

Persons with pacemakers only: The ignition system of your power tool produces an electromagnetic field of a very low intensity. This field may interfere with some pacemakers. STIHL recommends that persons with pacemakers consult their physician and the pacemaker manufacturer to reduce any health risk.

Do not operate the power tool if you are under the influence of any substance (drugs, alcohol) which might impair vision, dexterity or judgment.

Use your power tool only for the applications described in the instruction manual of the MultiTool you are using.

Do not use your power tool for any other purpose because of the **increased risk of accidents**.

Do not operate the MultiEngine without a properly mounted MultiTool since this may result in damage to the machine.

Only use MultiTools and accessories that are explicitly approved for this power tool by STIHL or are technically

identical. It is important that you read the chapter on "Approved MultiTools". If you have any questions in this respect, consult a servicing dealer. Use only high quality tools and accessories in order to avoid the risk of accidents and damage to the machine.

STIHL recommends the use of genuine STIHL tools and accessories. They are specifically designed to match the product and meet your performance requirements.

Never attempt to modify your power tool in any way since this may increase the risk of personal injury. STIHL excludes all liability for personal injury and damage to property caused while using unauthorized attachments.

Do not use a pressure washer to clean your power tool. The solid jet of water may damage parts of the power tool.

Clothing and Equipment

Wear proper protective clothing and equipment.

Avoid clothing that could get caught on branches or brush or moving parts of the machine. Do not wear a scarf, necktie or jewelry. Tie up and confine long hair (e.g. with a hair net, cap, hard hat, etc.).



Wear steel-toed safety boots with non-slip soles.

WARNING



To reduce the risk of eye injuries, wear close-fitting safety glasses in accordance with European Standard EN 166. Make sure the safety glasses are a comfortable and snug fit.

Wear hearing protection, e.g. earplugs or ear muffs.

Wear a face shield and make sure it is a good fit. A face shield alone does not provide adequate eye protection.

See also notes on "Clothing and Equipment" in the instruction manual of the MultiTool you are using.

Transporting the Power Tool

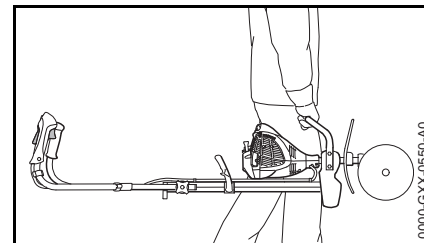

Always shut off the engine.

Carry the power tool by the carrying handle or loop handle with the attachment facing forwards.

Do not touch hot parts of the machine since **burn injury** will result.

The power tool can turn over or move while being transported. This may result in personal injuries and damage to property. Secure the power tool with

lashing straps or a net to prevent it turning over and moving. Allow the power tool to cool down before transporting it by vehicle. Position the power tool so that no fuel can escape.

See also notes on "Transporting the Power Tool" in the instruction manual of the MultiTool you are using.

Fueling



Gasoline is an extremely flammable fuel. Keep clear of naked flames. Do not spill any fuel – do not smoke.

Always shut off the engine before refueling.

Do not fuel a hot engine – fuel may spill and **cause a fire**.

Open the fuel cap carefully to allow any pressure build-up in the tank to release slowly and avoid fuel spillage.

Fuel your power tool only in well-ventilated areas. If you spill fuel, wipe the machine immediately – if fuel gets on your clothing, change immediately.



After fueling, tighten down the screw-type fuel cap as securely as possible.

This reduces the risk of unit vibrations causing the fuel cap to loosen or come off and spill quantities of fuel.



Check for leakage. To reduce the **risk of serious of fatal burn injuries**, do not start or run the engine until leak is fixed.

Before Starting

Check that your power tool is properly assembled and in good condition – refer to appropriate chapters in the instruction manuals.

- Check the fuel system for leaks, paying special attention to visible parts such as the tank cap, hose connections and the manual fuel pump (on machines so equipped). If there are any leaks or damage, do not start the engine – **risk of fire**. Have your machine repaired by a servicing dealer before using it again.
- Use only an approved combination of attachment and deflector. All parts must be assembled properly and securely.
- The stop switch must move freely.
- Smooth action of throttle trigger lockout and throttle trigger – the throttle trigger must return automatically to the idle position.
- Check that the spark plug boot is secure – a loose boot may cause arcing that could ignite combustible fumes **and cause a fire**.
- Never attempt to modify the controls or the safety devices in any way.

- Keep the handles dry and clean – free from oil and dirt – for safe control of the power tool.
- Swing the bicycle handle to the normal operating position and tighten it down firmly with the rotary knob. See "Adjusting the Handlebar".

To reduce the risk of accidents, operate your power tool only if it is in a safe condition.

See also notes on "Before Starting" in the instruction manual of the MultiTool you are using.

Check the position of the gearbox for the MultiTool you have mounted and correct it if necessary. This helps **reduce the risk of injury** from the MultiTool rotating in the wrong direction.

See "Mounting the MultiTool" in the instruction manual of the MultiTool you are using.

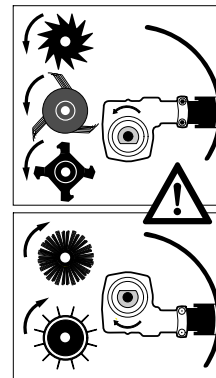

If you use metal tools, position the gearbox so that the axle is below the drive shaft.

Use for:

- BF-MM pick tines
- BK-MM bolo tines
- FC-MM edger
- RL-MM aerator
- MF-MM dethatcher

If you use sweeping attachments, position the gearbox so that the axle is above the drive shaft.

Use for:

- KB-MM bristle brush
- KW-MM PowerSweep

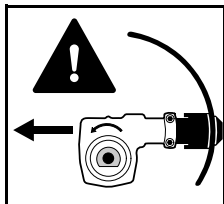

To use attachments for mowing grass, trimming and thinning out, remove the gearbox.

Use for:

- FS-MM brushcutter

Starting the Engine

Start the engine at least 3 meters from the fueling spot, outdoors only.

Place the power tool on firm ground in an open area. Make sure you have good balance and secure footing. Hold the power tool securely. The attachment must be clear of the ground and all other obstructions because it may begin to run when the engine starts.

Your power tool is for operation by one person only. To reduce the risk of injury from contact with the rotating tool, do not allow other persons within a radius of 5 meters of your own position – even when starting.



The tool begins to rotate as soon as the engine is started in the "Start" position. Always stand to one side of the machine when starting – never in front of the tools. **To reduce the risk of injury**, avoid contact with the working tool.

Do not drop start the power tool – start the engine as described in the instruction manual. Note that the attachment continues to run for a short period after you let go of the throttle trigger – flywheel effect.

Check idle speed setting: The attachment must be stationary when the engine is idling with the throttle trigger released.

To reduce the risk of fire, keep hot exhaust gases and hot muffler away from easily combustible materials (e.g. wood chips, bark, dry grass, fuel).

See also notes on "Starting / Stopping the Engine" in the instruction manual of the MultiTool you are using.

Holding and Controlling the Power Tool

Make sure you always have good balance and secure footing.

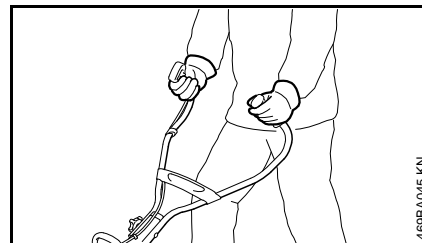

Always hold the power tool firmly with both hands on the handles.

Right handle on control handle, left hand on left handle.

During Operation

In the event of imminent danger or in an emergency, switch off the engine immediately – operate the stop switch.

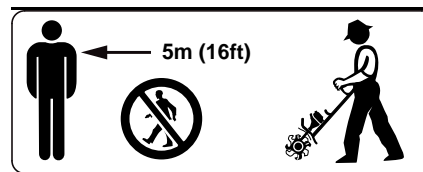

To reduce the risk of injury from contact with the tool and thrown objects, do not allow any other persons within a radius of 5 meters of your own position. **To reduce the risk of damage to property**, also maintain this distance from other objects (vehicles, windows).

The correct engine idle speed is important to ensure that the attachment stops moving when you let go of the throttle trigger. If the attachment continues to move when the engine is idling, have your dealer check the machine and make proper adjustments

or repairs. Check and correct the idle speed setting regularly. STIHL recommends an authorized STIHL servicing dealer.

Do not operate your power tool in the starting throttle position – engine speed cannot be controlled in this position.

Be particularly alert and cautious when wearing hearing protection because your ability to hear warnings (shouts, alarms, etc.) is restricted.

To reduce the risk of accidents, take a break in good time to avoid tiredness or exhaustion.

Work calmly and carefully – in daylight conditions and only when visibility is good. Stay alert so as not to endanger others.

Use your power tool only for those applications described in the MultiTool instruction manual.



Your power tool produces toxic exhaust fumes as soon as the engine is running. These fumes may be colorless and odorless and contain unburned hydrocarbons and benzol. Never run the engine indoors or in poorly ventilated locations, even if your model is equipped with a catalytic converter.

To reduce the risk of serious or fatal injury from breathing toxic fumes, ensure proper ventilation when working in trenches, hollows or other confined locations.

To reduce the risk of accidents, stop work immediately in the event of nausea, headache, visual disturbances (e.g. reduced field of vision), problems with hearing, dizziness, deterioration in ability to concentrate. Apart from other possibilities, these symptoms may be caused by an excessively high concentration of exhaust gases in the work area.

Operate your power tool so that it produces a minimum of noise and emissions – do not run the engine unnecessarily, accelerate the engine only when working.

To reduce the risk of fire, do not smoke while operating or standing near your power tool. Note that combustible fuel vapor may escape from the fuel system.

The dusts, vapor and smoke produced during operation may be dangerous to health. If the work area is very dusty or smoky, wear a respirator.

Do not touch hot parts of the machine since **burn injury** will result.



Keep your hands and feet well away from the working tool. **To reduce the risk of injury**, never touch a rotating tool. Always stand behind the deflector or to one side of the machine during operation – never in front of the rotating tools.

If your power tool is subjected to unusually high loads for which it was not designed (e.g. heavy impact or a fall), always check that it is in good condition before continuing work – see also "Before Starting". Check the fuel system

in particular for leaks and make sure the safety devices are working properly. Do not continue operating your power tool if it is damaged. In case of doubt, consult your servicing dealer.

To reduce the risk of injury, shut off the engine before changing the attachment.

After finishing work or before leaving the power tool unattended: Shut off the engine.

See also notes on "During Operation" in the instruction manual of the MultiTool you are using.

Vibrations

Prolonged use of the power tool may result in vibration-induced circulation problems in the hands (whitefinger disease).

No general recommendation can be given for the length of usage because it depends on several factors.

The period of usage is prolonged by:

- Hand protection (wearing warm gloves)
- Work breaks

The period of usage is shortened by:

- Any personal tendency to suffer from poor circulation (symptoms: frequently cold fingers, tingling sensations).
- Low outside temperatures.
- The force with which the handles are held (a tight grip restricts circulation).

Continual and regular users should monitor closely the condition of their hands and fingers. If any of the above symptoms appear (e.g. tingling sensation in fingers), seek medical advice.

Maintenance and Repairs

Service the machine regularly. Do not attempt any maintenance or repair work not described in the instruction manual. Have all other work performed by a servicing dealer.

STIHL recommends that you have servicing and repair work carried out exclusively by an authorized STIHL servicing dealer. STIHL dealers are regularly given the opportunity to attend training courses and are supplied with the necessary technical information.

Only use high-quality replacement parts in order to avoid the risk of accidents and damage to the machine. If you have any questions in this respect, consult a servicing dealer.

STIHL recommends the use of genuine STIHL replacement parts. These parts are specifically designed to match your machine model and meet your performance requirements.

To reduce **the risk of injury** from unintentional engine startup, **always shut off the engine and disconnect the spark plug boot** before performing any repairs, maintenance or cleaning work. – Exception: Carburetor and idle speed adjustments.

Do not turn the engine over on the starter with the spark plug boot or spark plug removed since there is otherwise a **risk of fire** from uncontained sparking.

To reduce the **risk of fire**, do not service or store your machine near open flames.

Check the fuel filler cap for leaks at regular intervals.

Use only a spark plug of the type approved by STIHL and make sure it is in good condition – see "Specifications".

Inspect the ignition lead (insulation in good condition, secure connection).

Check the condition of the muffler.

To reduce the **risk of fire and damage to hearing**, do not operate your machine if the muffler is damaged or missing.

Do not touch a hot muffler since **burn injury** will result.

Approved MultiTools

The following STIHL MultiTools may be mounted on the MultiEngine:

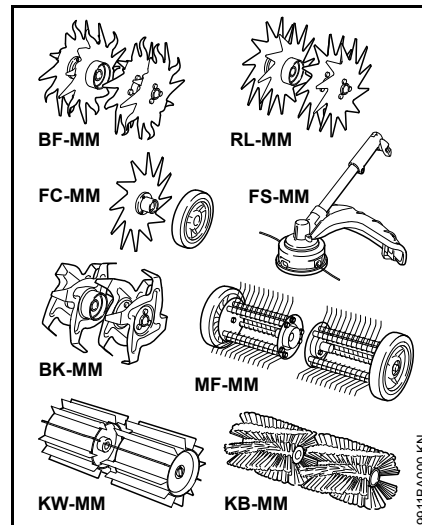

MultiTool	Application
BF-MM	Pick tines
BK-MM	Bolo tines
RL-MM	Aerator
FC-MM	Edger
FS-MM	Clearing saw
MF-MM	Dethatcher
KW-MM	STIHL PowerSweep™
KB-MM	Bristle brush

Adjusting the bicycle handle

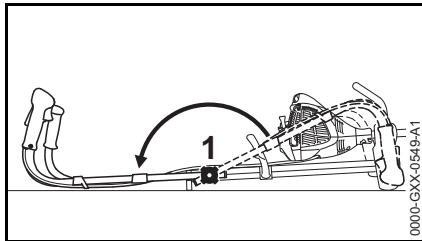

- Loosen the knob (1).
- Swing the bicycle handle with both hands into the working position (as far as stop).
- Tighten down the knob firmly.

Fuel

Your engine requires a mixture of gasoline and engine oil.

WARNING

For health reasons, avoid direct skin contact with gasoline and avoid inhaling gasoline vapor.

STIHL MotoMix

STIHL recommends the use of STIHL MotoMix. This ready-to-use fuel mix contains no benzol or lead, has a high octane rating and ensures that you always use the right mix ratio.

STIHL MotoMix uses STIHL HP Ultra two-stroke engine oil for an extra long engine life.

MotoMix is not available in all markets.

Mixing Fuel

NOTICE

Unsuitable fuels or lubricants or mix ratios other than those specified may result in serious damage to the engine. Poor quality gasoline or engine oil may damage the engine, sealing rings, hoses and the fuel tank.

Gasoline

Use only high-quality **brand-name** gasoline with a minimum octane rating of 90 – leaded or unleaded.

Gasoline with an ethanol content of more than 10% can cause running problems in engines with a manually adjustable carburetor and should not be used in such engines.

Engines equipped with M-Tronic deliver full power when run on gasoline with an ethanol content of up to 25% (E25).

Engine Oil

If you mix the fuel yourself, use only STIHL two-stroke engine oil or another high-performance engine oil in accordance with JASO FB, JASO FC, JASO FD, ISO-L-EGB, ISO-L-EGC or ISO-L-EGD.

STIHL specifies STIHL HP Ultra two-stroke engine oil or an equivalent high-performance engine oil in order to maintain emission limits over the machine's service life.

Mix Ratio

STIHL 50:1 two-stroke engine oil: 50 parts gasoline to 1 part oil

Examples

Gasoline Liters	STIHL engine oil 50:1	
	Liters	(ml)
1	0.02	(20)
5	0.10	(100)
10	0.20	(200)
15	0.30	(300)
20	0.40	(400)
25	0.50	(500)

- Use a canister approved for storing fuel. Pour oil into canister first, then add gasoline and mix thoroughly.

Storing Fuel

Store fuel only in approved safety-type fuel canisters in a dry, cool and safe location protected from light and the sun.

Fuel mix ages – only mix sufficient fuel for a few weeks work. Do not store fuel mix for longer than 30 days. Exposure to light, the sun, low or high temperatures can quickly make the fuel mix unusable.

STIHL MotoMix may be stored for up to 2 years without any problems.

- Thoroughly shake the mixture in the canister before fueling your machine.

! WARNING

Pressure may build up in the canister – open it carefully.

- Clean the fuel tank and canister from time to time.

Dispose of remaining fuel and cleaning fluid properly in accordance with local regulations and environmental requirements.

Fueling

Preparations

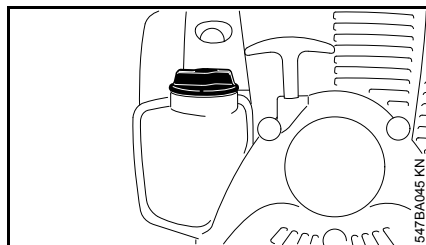

- Before fueling, clean the filler cap and the area around it to ensure that no dirt falls into the tank.
- Position the machine so that the filler cap is facing up.

Opening screw-type tank cap

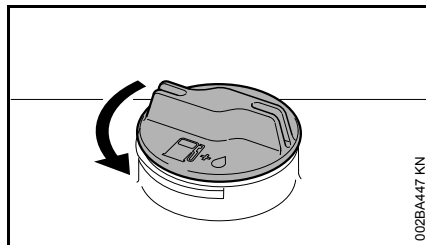

- Turn the cap counterclockwise until it can be removed from the tank opening.
- Remove the cap.

Filling up with fuel

Take care not to spill fuel while fueling and do not overfill the tank. STIHL recommends you use the STIHL filler nozzle (special accessory).

Closing screw-type tank cap

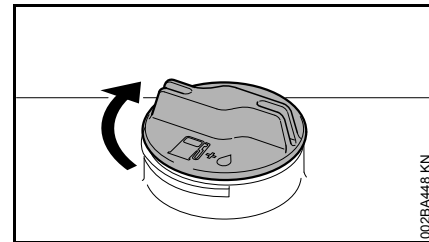

- Place the cap in the opening.
- Turn the cap clockwise as far as stop and tighten it down as firmly as possible by hand.

Starting / Stopping the Engine

Controls

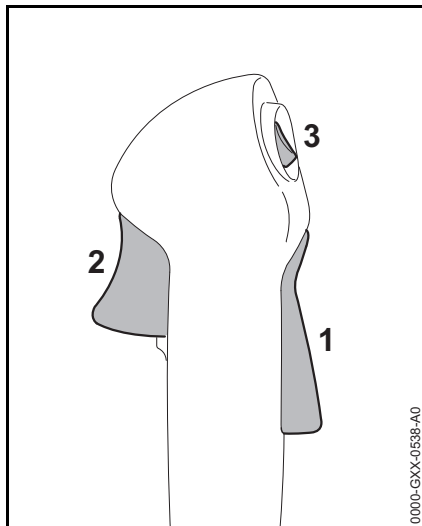

- 1 Throttle trigger lockout
- 2 Throttle trigger
- 3 Stop switch with **Run** and **Stop** positions. Depress the stop switch (⊖) to switch off the ignition – see "Function of Stop Switch and Ignition System".

Function of Stop Switch and Ignition System

The ignition is switched off and the engine stopped when the stop switch is depressed. The stop switch returns automatically to the **Run** position when it is released: The ignition is switched on again after the engine stops – the engine is then ready to start.

Starting the Engine

- Swing bicycle handle into working position – see "Adjusting the Bicycle Handle"

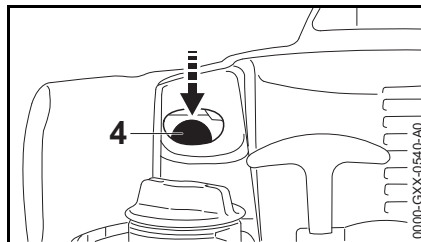

- Depress the manual fuel pump bulb (4) at least five times – even if the bulb is filled with fuel.

Cold engine (cold start)

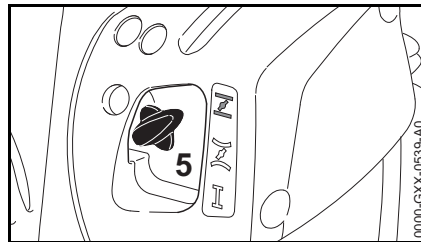

- Depress the choke knob (5) and turn it to \bar{I} at the same time.

Warm engine (warm start)

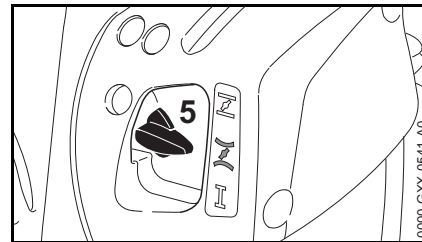

- Depress the choke knob (5) and turn it to \bar{I} at the same time.

Also use this setting if the engine has been running but is still cold.

Cranking

- Retract the wheels, if fitted.

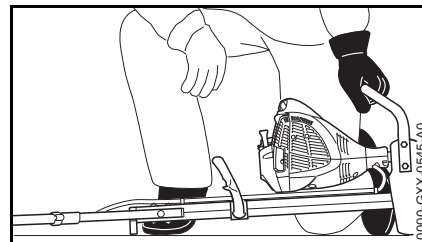

- Put the unit on the ground: It must rest securely on the engine flange and the support on the frame. Check that the MultiTool is not touching the ground or any other

obstacles – see also "Starting / Stopping the Engine" in the MultiTool instruction manual.

- Make sure you have secure footing – as shown. To reduce **the risk of injury** from the rotating attachment, always stand to one side of the power tool.
- With your left hand on the carrying handle, press the unit **firmly** against the ground.

**NOTICE**

Do not stand or kneel on the shaft.

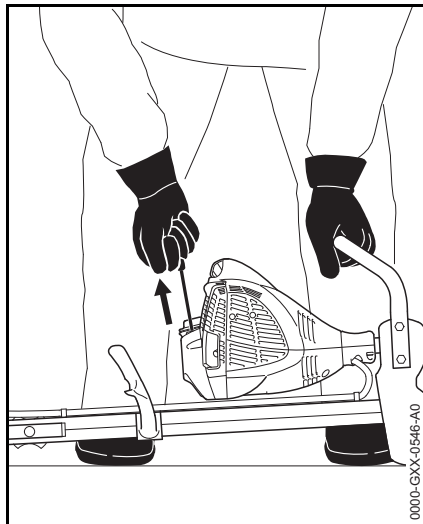

- Hold the starter grip with your right hand.

Version without ErgoStart

- Pull the starter grip slowly until you feel it engage and then give it a brisk strong pull.

Version with ErgoStart

- Pull the starter grip steadily.

**NOTICE**

Do not pull out the starter rope all the way – **it might otherwise break.**

- Do not let the starter grip snap back. Guide it slowly back into the housing so that the starter rope can rewind properly.
- Continue cranking until the engine runs.

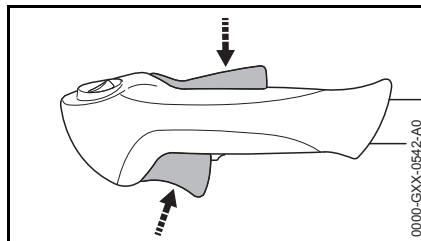
As soon as the engine runs

- Press down the throttle trigger lockout and open the throttle – the choke knob moves to the run position **I**. After a cold start, warm up the engine by opening the throttle several times.

**WARNING**

Make sure the carburetor is correctly adjusted. The MultiTool must not rotate when the engine is idling.

Your machine is now ready for operation.

Stopping the Engine

- Depress the momentary contact stop switch – the engine stops – release the stop switch – it springs back to the run position.

Other Hints on Starting**Engine stalls in cold start position **I** or under acceleration.**

- Move the choke knob to **II** and continue cranking until the engine runs.

Engine does not start in warm start position **II**

- Move the choke knob to **I** and continue cranking until the engine runs.

If the engine does not start

- Check that all settings are correct.
- Check that there is fuel in the tank and refuel if necessary.
- Check that the spark plug boot is properly connected.
- Repeat the starting procedure.

Engine is flooded

- Move the choke knob to **I** and continue cranking until the engine runs.

Fuel tank run until completely dry

- After refueling, depress the manual fuel pump bulb at least 5 times – even if the bulb is already filled with fuel.
- Set the choke knob to suit the engine temperature.
- Now start the engine.

Extra weight

An extra weight (special accessory) may be retrofitted on the MultiEngine to increase the weight on the MultiTool.

Use only original STIHL weights. The use of other weights or parts may result in damage to the machine or personal injury.

Mounting the extra weight

MultiEngine without wheels

Use the combination wrench to unscrew and retighten the weights.

Unscrew weights on the side without square end – as follows:

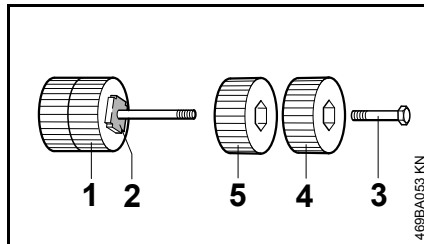

The weights (1) on the side with the square end (2) remain on the bolt.

- Take out the hex head screw (3) and remove the outer weight (4).
- Loosen the inner weight (5) and remove it from the bolt.

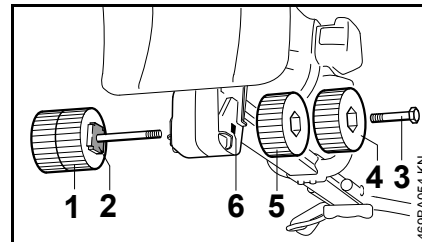

- Push the extra weight (1) with bolt through the bore (6) in the flange, turning it until the square end (2) engages the recess in the flange.
- Screw the inner weight (5) onto the bolt and tighten it down firmly.
- Screw the outer weight (4) with the hex head screw (3) into the thread of the inner weight and tighten it down firmly.

One of two weights may be mounted on each side of the extra weight as required.

Weight on each side	Total extra weight
1	2 kg
2	4 kg



NOTICE

The maximum allowable extra weight is 4 kg. Never use a heavier extra weight as this may damage the machine.

MultiEngine with wheels

If the MultiEngine is already equipped with wheels (special accessory), see chapter on "Wheels", additional parts are required to mount the extra weights.

In such a case have the extra weight mounted by your servicing dealer.

STIHL recommends that you have servicing and repair work carried out exclusively by an authorized STIHL servicing dealer.

Wheels

For convenient transport, the MultiEngine can be retrofitted with a set of wheels (special accessory).

Always use original STIHL wheels. Using other wheels can lead to damage to the machine and personal injuries.

Installing wheels

No additional weight is attached to the MultiEngine

To simplify installation, turn the machine so that it rests on the handles.

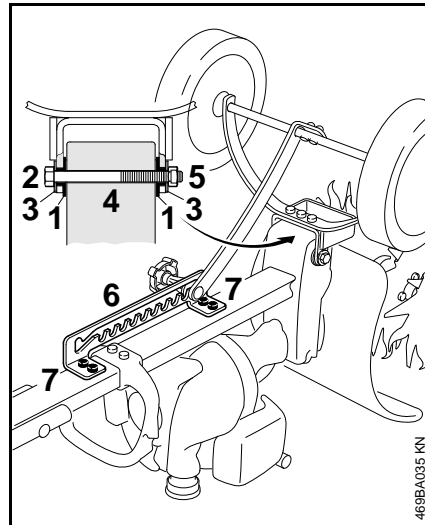

- Insert the two sleeves (1) in the frame
- Push the frame onto the flange

- Insert the bolt (2) with the washer (3) through the hole (4) in the flange
- Fit the washer (3) and tighten it down with the nut (5)
- Fasten the notched plate (6) to the frame with the screws (7) in the threaded holes – in the process, push the notched plate toward the handle
- The wheels must fold down automatically in working position; if necessary, loosen the nut (5) by a quarter turn

Additional weight is attached to the MultiEngine

If additional weight (special accessory) – see "Additional weight" – is already attached to the MultiEngine, then additional parts are required in order to install wheels.

In this case, have the wheels installed by a servicing dealer.

STIHL recommends that maintenance and repair work be carried out only by authorized STIHL dealers.

Folding the wheels in and out

The wheels can be locked in various positions.

If the wheels are not needed during work, fold in the wheels.

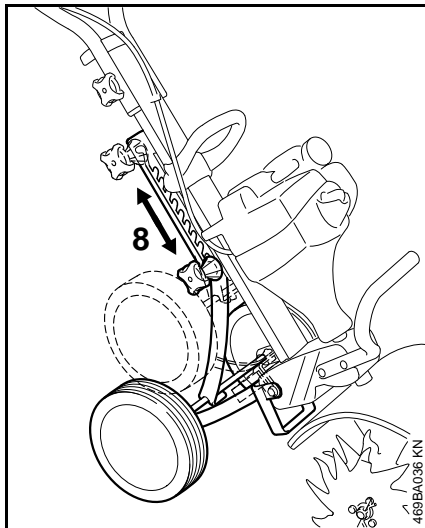

- Loosen knob (8)
- Engage knob in the desired working position and tighten it

Operating Instructions

During break-in period

A factory-new machine should not be run at high revs (full throttle off load) for the first three tank fillings. This avoids unnecessary high loads during the break-in period. As all moving parts have to bed in during the break-in period, the frictional resistances in the engine are greater during this period. The engine develops its maximum power after about 5 to 15 tank fillings.

During Operation

After a long period of full throttle operation, allow the engine to run for a short while at idle speed so that engine heat can be dissipated by the flow of cooling air. This protects engine-mounted components (ignition, carburetor) from thermal overload.

After Finishing Work

Storing for a short period: Wait for the engine to cool down. Empty the fuel tank and keep the machine in a dry place, well away from sources of ignition, until you need it again. For longer out-of-service periods – see "Storing the Machine".

Replacing the Air Filter

If There is a Noticeable Loss of Engine Power

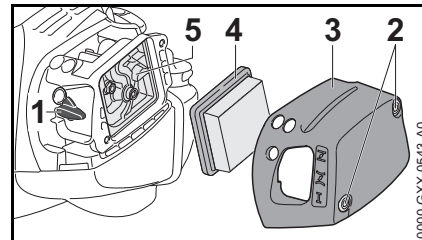

- Move the choke lever (1) to .
- Loosen the screws (2).
- Remove the filter cover (3).
- Clean away loose dirt from around the filter.
- Remove the filter element (4).
- Replace dirty or damaged filter element (4).

Replacing the filter element

- Install the filter element (4) in the filter housing (5) and fit the cover.
- Insert the screws (2) and tighten them down firmly.

Adjusting the Carburetor

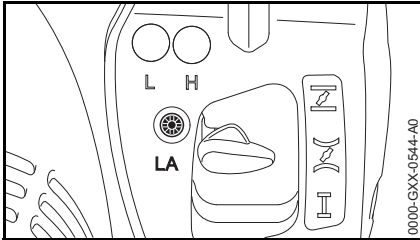

The carburetor has been set at the factory to provide an optimum fuel-air mixture under most operating conditions.

Adjusting Idle Speed

Engine stops while idling

- Warm up the engine for about 3 minutes.
- Turn the idle speed screw (LA) slowly clockwise until the engine runs smoothly – the MultiTool must not run.

MultiTool runs when the engine is idling

- Turn the idle speed screw (LA) counterclockwise until the MultiTool stops moving and then turn the screw about another 1/2 to 3/4 turn in the same direction.

! WARNING

If the MultiTool continues to run when the engine is idling, have your machine checked and repaired by your servicing dealer.

Spark Arresting Screen in Muffler

- If the engine is down on power, check the spark arresting screen in the muffler.
- Wait for the muffler to cool down.

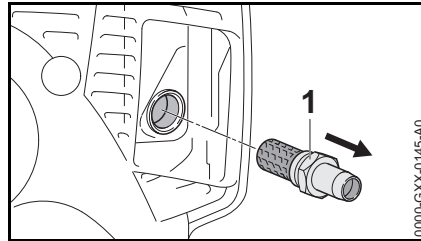

- Use the combination wrench to unscrew the spark arrester.
- Clean the spark arrester screen. If the screen is damaged or heavily carbonized, fit a new one.
- Insert the spark arrester and tighten it down firmly with the combination wrench.

Spark Plug

- If the engine is down on power, difficult to start or runs poorly at idle speed, first check the spark plug.
- Fit a new spark plug after about 100 operating hours – or sooner if the electrodes are badly eroded. Install only suppressed spark plugs of the type approved by STIHL – see "Specifications".

Removing the Spark Plug

- Shut off the engine.

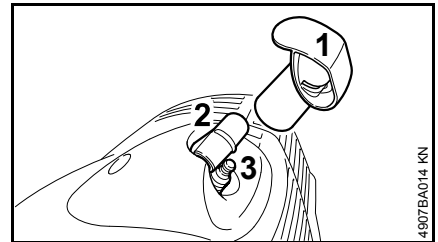

The spark plug boot (2) is under the cap (1).

! WARNING

The cap (1) protects the spark plug boot from damage. Do not operate the machine without a cap – replace a damaged cap.

- Remove the cap (1).
- Pull off the spark plug boot (2).
- Allow the spark plug (3) to cool down.
- Unscrew the spark plug (3).

Checking the Spark Plug

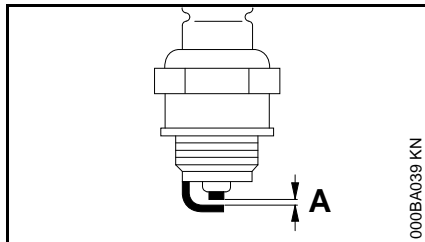

- Clean dirty spark plug.
- Check electrode gap (A) and readjust if necessary – see "Specifications".
- Rectify the problems which have caused fouling of the spark plug.

Possible causes are:

- Too much oil in fuel mix.
- Dirty air filter.
- Unfavorable running conditions.

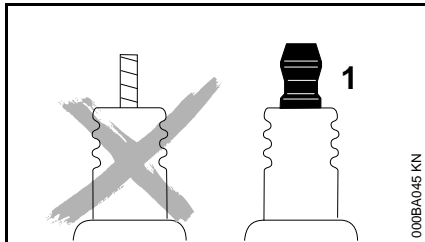

WARNING

Arcing may occur if the adapter nut (1) is loose or missing. Working in an easily combustible or explosive atmosphere may cause a fire or an explosion. This can result result in serious injuries or damage to property.

- Use resistor type spark plugs with a properly tightened adapter nut.

Installing the spark plug

- Screw the spark plug into the cylinder.
- Press the boot firmly onto the spark plug.

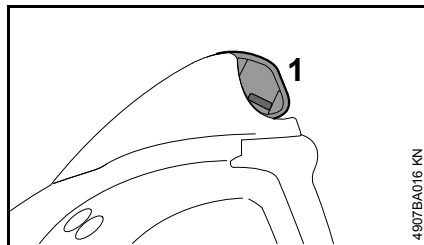

- Push the cap (1) on to the spark plug boot as far as stop.

Engine Running Behavior

If engine running behavior is unsatisfactory even though the air filter is clean and the carburetor is properly adjusted, the cause may be the muffler.

Have the muffler checked for contamination (carbonization) by your servicing dealer.

STIHL recommends that you have servicing and repair work carried out exclusively by an authorized STIHL servicing dealer.

Storing the Machine

For periods of about 3 months or longer

- Drain and clean the fuel tank in a well ventilated area.
- Dispose of fuel properly in accordance with local environmental requirements.
- Run the engine until the carburetor is dry – this helps prevent the carburetor diaphragms sticking together.
- Thoroughly clean the machine – pay special attention to the cylinder fins and air filter.
- Remove, clean and inspect the attachment.
- Store the machine in a dry and secure location. Keep out of the reach of children and other unauthorized persons.

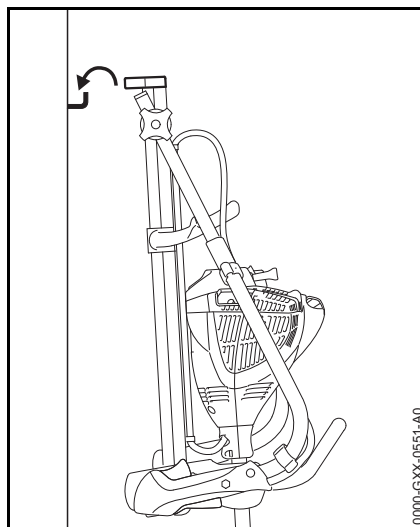

Fold the handle down and hang up the machine by the handle support.

Maintenance and Care

The following intervals apply to normal operating conditions only. If your daily working time is longer or operating conditions are difficult (very dusty work area, etc.), shorten the specified intervals accordingly.		before starting work	after finishing work or daily	after each refueling stop	weekly	monthly	every 12 months	if problem	if damaged	as required
Complete machine	Visual inspection (condition, leaks)	X		X						
	Clean		X							
Control handle	Check operation	X		X						
Air filter	Clean							X		X
	Replace								X	
Manual fuel pump (if fitted)	Check	X								
	Have repaired by servicing dealer ¹⁾								X	
Pickup body (filter) in fuel tank	Check							X		
	Have replaced by servicing dealer ¹⁾						X		X	X
Fuel tank	Clean							X		X
Carburetor	Check idle adjustment – the working/cutting attachment must not run	X		X						
	Readjust idle									X
Spark plug	Readjust electrode gap							X		
	Replace after every 100 operating hours									
Cooling inlet	Visual inspection		X							
	Clean									X
Spark arrestor in muffler	Check		X					X		
	Clean or replace								X	X
All accessible screws and nuts (not adjusting screws)	Tighten									X
Safety labels	Replace								X	

¹⁾ STIHL recommends an authorized STIHL servicing dealer.

Minimize Wear and Avoid Damage

Observing the instructions in this manual helps reduce the risk of unnecessary wear and damage to the power tool.

The power tool must be operated, maintained and stored with the due care and attention described in this owner's manual.

The user is responsible for all damage caused by non-observance of the safety precautions, operating and maintenance instructions in this manual. This includes in particular:

- Alterations or modifications to the product not approved by STIHL.
- Using tools or accessories which are neither approved or suitable for the product or are of a poor quality.
- Using the product for purposes for which it was not designed.
- Using the product for sports or competitive events.
- Consequential damage caused by continuing to use the product with defective components.

Maintenance Work

All the operations described in the "Maintenance Chart" must be performed on a regular basis. If these maintenance operations cannot be performed by the owner, they should be performed by a servicing dealer.

STIHL recommends that you have servicing and repair work carried out exclusively by an authorized STIHL

servicing dealer. STIHL dealers are regularly given the opportunity to attend training courses and are supplied with the necessary technical information.

If these maintenance operations are not carried out as specified, the user assumes responsibility for any damage that may occur. Among other parts, this includes:

- Damage to the engine due to neglect or deficient maintenance (e.g. air and fuel filters), incorrect carburetor adjustment or inadequate cleaning of cooling air inlets (intake ports, cylinder fins).
- Corrosion and other consequential damage resulting from improper storage.
- Damage to the machine resulting from the use of poor quality replacement parts.

Parts Subject to Wear and Tear

Some parts of the power tool are subject to normal wear and tear even during regular operation in accordance with instructions and, depending on the type and duration of use, have to be replaced in good time. Among other parts, this includes:

- Clutch
- Filters (air, fuel)
- Rewind starter
- Spark plug

Main Parts

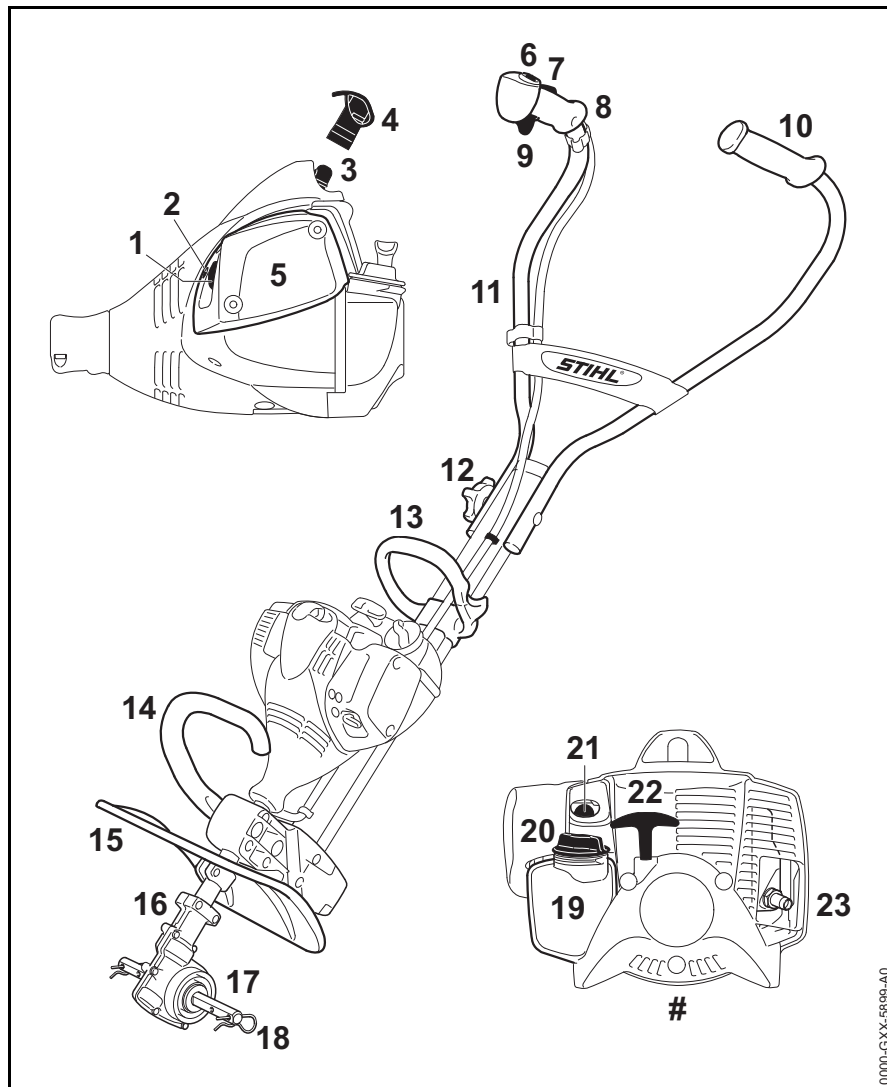

- 1 Choke lever
- 2 Carburetor adjusting screw
- 3 Spark plug boot
- 4 Cap
- 5 Air filter cover
- 6 Stop switch
- 7 Throttle trigger lockout
- 8 Control handle
- 9 Throttle trigger
- 10 Left handle
- 11 Handlebar
- 12 Knob
- 13 Loop handle
- 14 Carrying handle
- 15 Deflector
- 16 Gearbox
- 17 Axle
- 18 Hitch pin
- 19 Fuel tank
- 20 Tank cap
- 21 Manual fuel pump
- 22 Starter grip
- 23 Muffler with spark arresting screen
- # Serial Number

0000-GXX-5899-A0

Specifications

Engine

Single cylinder two-stroke engine

Displacement:	27.2 cc
Bore:	34 mm
Stroke:	30 mm
Engine power to ISO 8893:	0.85 kW (1.2 bhp) at 7,500 rpm
Idle speed:	2,800 rpm
Cut-off speed:	8,900 rpm
Max. output shaft speed (MultiTool):	200 rpm

Ignition System

Electronic magneto ignition

Spark plug (resistor type):	NGK CMR 6 H, BOSCH USR 4AC
Electrode gap:	0.5 mm

Fuel System

All position diaphragm carburetor with integral fuel pump

Fuel tank capacity: 330 cc (0.33 l)

Weight

Dry, without attachment
7.9 kg

Noise and Vibration Data

For further details on compliance with Vibration Directive 2002/44/EC visit www.stihl.com/vib.

MultiEngine with MultiTool

Version of MultiTools – see "Approved MultiTools".

BF-MM and BK-MM

Noise and vibration data are measured at idling and rated operating speed in a ratio of 1:6.

Sound pressure level L_{peq} to EN 709

87 dB(A)

Sound power level L_w to EN 709

96 dB(A)

Vibration level $a_{hv,eq}$ to EN 709

	Handle, left	Handle, right
BF-MM:	3.8 m/s ²	4.4 m/s ²
BK-MM:	3.7 m/s ²	4.0 m/s ²

FC-MM

Noise and vibration data is measured at idling and rated maximum engine speed in a ratio of 1:1.

Sound pressure level L_p to ISO 11789

91 dB(A)

Sound power level L_w to ISO 11789

100 dB(A)

Vibration level $a_{hv,eq}$ to EN 11789

	Handle, left	Handle, right
FC-MM	4.1 m/s ²	5.1 m/s ²

FS-MM

Noise and vibration data is measured at idling and rated maximum engine speed in a ratio of 1:6.

Sound pressure level L_p to DIN EN 14910

93 dB(A)

Sound pressure level L_{peq} to DIN EN 14910

102 dB(A)

Vibration level $a_{hv,eq}$ to DIN EN 14910

	Handle, left	Handle, right
FS-MM	4.0 m/s ²	4.3 m/s ²

KB-KM, KW-KM

Noise and vibration data is measured at idling and rated maximum engine speed in a ratio of 1:6.

Sound pressure level L_p to ISO 11201

94 dB(A)

Sound power level L_w to EN ISO 118061

102 dB(A)

Vibration level $a_{hv,eq}$ to ISO 20643

	Handle, left	Handle, right
KB-MM:	4.0 m/s ²	4.1 m/s ²
KW-MM:	4.0 m/s ²	4.1 m/s ²

MF-MM and RL-MM

Noise and vibration data is measured at idling and rated maximum engine speed in a ratio of 1:6.

Sound pressure level L_{peq} to EN 13684

MF-MM:	94 dB(A)
RL-MM:	93 dB(A)

Sound power level L_w to EN 13684

MF-MM:	101 dB(A)
RL-MM:	102 dB(A)

Vibration level $a_{hv,eq}$ to EN 13864

	Handle, left	Handle, right
MF-MM:	4.1 m/s ²	4.5 m/s ²
RL-MM:	4.1 m/s ²	4.5 m/s ²

The K-factor in accordance with Directive 2006/42/EC is 2.0 dB(A) for the sound pressure level and sound power level; the K-factor in accordance with Directive 2006/42/EC is 2.0 m/s² for the vibration level.

REACH

REACH is an EC regulation and stands for the Registration, Evaluation, Authorisation and Restriction of Chemical substances.

For information on compliance with the REACH regulation (EC) No. 1907/2006 see www.stihl.com/reach.

Exhaust Emissions

The CO₂ value measured in the EU type approval procedure is specified at www.stihl.com/co2.

The measured CO₂ value was determined on a representative engine in accordance with a standardized test procedure under laboratory conditions and does not represent either an explicit or implied guarantee of the performance of a specific engine.

The applicable exhaust emission requirements are fulfilled by the intended usage and maintenance described in this instruction manual. The type approval expires if the engine is modified in any way.

Maintenance and Repairs

Users of this machine may only carry out the maintenance and service work described in this user manual. All other repairs must be carried out by a servicing dealer.

STIHL recommends that you have servicing and repair work carried out exclusively by an authorized STIHL servicing dealer. STIHL dealers are regularly given the opportunity to attend training courses and are supplied with the necessary technical information.

When repairing the machine, only use replacement parts which have been approved by STIHL for this power tool or are technically identical. Only use high-quality replacement parts in order to avoid the risk of accidents and damage to the machine.

STIHL recommends the use of original STIHL replacement parts.

Original STIHL parts can be identified by the STIHL part number, the **STIHL** logo and the STIHL parts symbol  (the symbol may appear alone on small parts).

Disposal

Observe all country-specific waste disposal rules and regulations.

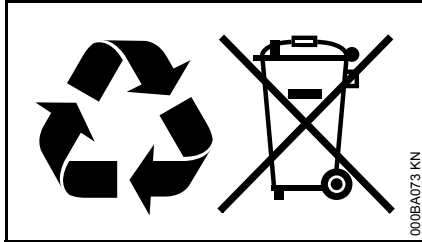

STIHL products must not be thrown in the garbage can. Take the product, accessories and packaging to an approved disposal site for environment-friendly recycling.

Contact your STIHL servicing dealer for the latest information on waste disposal.

EC Declaration of Conformity

ANDREAS STIHL AG & Co. KG
Badstr. 115
D-71336 Waiblingen

Germany

declare in exclusive responsibility that

Category:	MultiEngine
Make:	STIHL
Model:	MM 56
Serial identification:	4604
Displacement:	27.2 cc

conforms to the relevant provisions of Directives 2011/65/EU, 2006/42/EC und 2014/30/EU and has been developed and manufactured in compliance with the following standards in the versions valid on the date of production:

EN ISO 12100, EN 55012,
EN 61000-6-1 (in conjunction with the specified MultiTools: BF-MM, BK-MM, RL-MM, FC-MM, MF-MM, KB-MM, KW-MM)

The MultiEngine described here may be operated only in conjunction with the MultiTools approved by STIHL for use with this MultiEngine.

Technical documents deposited at:

ANDREAS STIHL AG & Co. KG
Produktzulassung (Product Licensing)

The year of manufacture and serial number are applied to the product.

Done at Waiblingen, 29.11.2018
ANDREAS STIHL AG & Co. KG

Thomas Elsner

Director Product Management and Services

0458-489-8321-A

AUS



www.stihl.com



0458-489-8321-A