

# STIHL

## STIHL SG 51, 71

Instruction Manual





## Contents

Guide to Using this Manual	2
Safety Precautions and Working Techniques	2
Assembling the Unit	6
Harness	7
Controls	9
Filling the Container	10
Spraying	11
After Spraying	11
Storing the Machine	11
Inspection and Maintenance by User	12
Maintenance and Care	14
Main Parts	15
Specifications	16
Troubleshooting	17
Maintenance and Repairs	18
Disposal	18
EC Declaration of Conformity	18

Dear Customer,

Thank you for choosing a quality engineered STIHL product.

It has been built using modern production techniques and comprehensive quality assurance. Every effort has been made to ensure your satisfaction and trouble-free use of the product.

Please contact your dealer or our sales company if you have any queries concerning this product.

Your



Dr. Nikolas Stihl

# STIHL

## Guide to Using this Manual

### Pictograms

---

All the pictograms attached to the machine are shown and explained in this manual.

### Symbols in text

---



#### WARNING

Warning where there is a risk of an accident or personal injury or serious damage to property.



#### NOTICE

Caution where there is a risk of damaging the machine or its individual components.

### Engineering improvements

---

STIHL's philosophy is to continually improve all of its products. For this reason we may modify the design, engineering and appearance of our products periodically.

Therefore, some changes, modifications and improvements may not be covered in this manual.

## Safety Precautions and Working Techniques

This instruction manual covers a STIHL sprayer which is also referred to as the unit in the descriptions.



Special safety precautions must be observed when working with this sprayer.



It is important that you read the instruction manual before first use and keep it in a safe place for future reference. Non-observance of the instruction manual may result in serious or even fatal injury.

### General

---

Observe all applicable local safety regulations, standards and ordinances.

If you have not used this model before: Have your dealer or other experienced user show you how it is operated or attend a special course in its operation.

Minors should never be allowed to use this product.

Keep bystanders, especially children, and animals away from the work area.

When the sprayer is not in use, put it in a place where it does not endanger others. Secure it against unauthorized use.

The user is responsible for avoiding injury to third parties or damage to their property.

Do not lend or rent your sprayer without the instruction manual. Be sure that anyone using it understands the information contained in this manual.

Do not operate your sprayer if any of its components are damaged. Make sure that all components are properly sealed – no leaks.

Pressurize the tank only with the pump that is installed in the sprayer.

Operate the sprayer only if it is complete and properly assembled.

To operate this sprayer you must be rested, in good physical condition and mental health.

Do not operate the sprayer if you are under the influence of any substance (drugs, alcohol) which might impair vision, dexterity or judgment.

### Intended use

---

The sprayer is suitable for spraying chemicals and other liquids to control pests and weeds. Typical areas of application are in fruit and vegetable growing, horticulture, plantations, grassland and the forestry industry.

Only use plant protection products that are specifically approved for use in sprayers.

Do not use your sprayer for any other purpose because of the increased risk of accidents and damage to the sprayer. Never attempt to modify your sprayer in any way since this may result in accidents or damage to the sprayer.

## Clothing and Equipment

---

Wear proper protective clothing and equipment when using, filling and cleaning the sprayer. Follow the chemical manufacturer's instructions with respect to protective equipment.

Clothing must be snug-fitting but allow complete freedom of movement.

Immediately change work clothes contaminated with plant control chemicals.

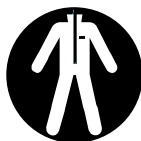

For some chemicals it is necessary to wear impermeable coveralls.

If you are spraying overhead, wear impermeable head covering.



Wear impermeable safety boots with a non-slip sole which are resistant to plant control chemicals.

Do not wear sandals or go barefoot.



Wear impermeable gloves resistant to plant control chemicals.

## WARNING



To reduce the risk of eye injuries, wear snug-fitting safety glasses in accordance with European Standard EN 166. Make sure the safety glasses are a good fit.

Wear a suitable respirator.

Inhaling plant control chemicals may endanger your health. Always wear a suitable respirator to protect yourself against health risks and allergic reactions. Observe warnings in the directions for use of the plant protection product and all applicable local safety regulations, standards and ordinances.

## Transport

---

Transporting in a vehicle:

- Properly secure the sprayer to prevent turnover and damage.
- The tank must be de-pressurized, empty and clean.

## Cleaning

---

Clean plastic surfaces with a cloth. Do not use aggressive detergents. They may damage the plastic.

Do not use a pressure washer to clean the unit. The solid jet of water may damage parts of the unit.

## Accessories

---

Only use parts and accessories that are explicitly approved for this tool by STIHL or are technically identical. If you have any questions in this respect, consult a servicing dealer. Use only high quality parts and accessories in order to avoid the risk of accidents and damage to the tool.

STIHL recommends the use of genuine STIHL replacement parts. They are specifically designed to match your model and meet your performance requirements.

Never attempt to modify your tool in any way since this may increase the risk of personal injury. STIHL excludes all liability for personal injury and damage to property caused while using unauthorized attachments.

## Handling Chemicals

---

Read the instructions supplied with the plant protection chemical prior to use. Follow the instructions with respect to mixing, using, personal protection equipment, storage and disposal.

Observe legal requirements for handling plant protection chemicals.

Plant protection chemicals may contain substances that are harmful to humans, animals, plants and the environment – **risk of poisoning and risk of serious or fatal injuries!**

Avoid contact with plant protection chemicals.

Plant protection chemicals may be used only by persons trained in their handling and the appropriate first-aid measures.

Keep instructions or label of the plant protection chemical available at all times in order to inform the doctor about the chemical concerned in an emergency. In an emergency, follow the chemical manufacturer's instructions provided or on the label. **Observe manufacturer's safety data sheets.**

### **Mixing plant protection chemicals and filling tank**

Use plant protection chemicals only as specified by the manufacturer.

- Before filling the tank with chemicals, carry out a test with fresh water and check all parts of the sprayer for leaks.
- Never apply undiluted liquid concentrates of plant protection products.
- Mix the plant protection chemical and fill the tank outdoors only or in well-ventilated locations.
- Only mix sufficient solution for the job in hand so that nothing is left over.
- Do not mix different plant protection products unless such a mixture is approved by the manufacturer.
- Mix different chemicals only in accordance with the manufacturer's instructions – incorrect mixtures may produce toxic fumes or explosive solutions.
- Stand the sprayer on a level surface – do not fill the tank above the maximum mark.

- When filling from central water supply, do not immerse the end of the hose in the solution – sudden low pressure in the system may cause the solution to be sucked back into the water supply.
- **To reduce the risk of injury**, do not fill the sprayer while carrying it.
- Close the tank tightly after filling.

### **Application**

- Work only in the open or in very well ventilated locations, e.g. open greenhouses.
- Do not eat, drink or smoke while working with plant protection chemicals.
- Never blow through nozzles or other components by mouth.
- Do not spray in windy conditions.

Too high or too low a spray pressure or unfavorable weather conditions can result in the wrong solution concentration. Overdosing may damage plants and the environment. Underdosing may result in unsuccessful plant treatment.

In order to reduce the risk of damage to the environment and plants, do not operate the sprayer:

- if pressure is too high or too low
- in windy conditions
- at temperatures above 40°C in the shade
- in direct sunlight

In order to reduce the risk of accidents and damage to the sprayer, never operate the sprayer with:

- flammable liquids
- viscous or sticky liquids
- caustic or corrosive chemicals
- liquids hotter than 40°C

### **Storage**

- During work breaks, do not leave the sprayer in the hot sun or near any heat source.
- Do not store plant protection chemical in the sprayer for longer than one day.
- Store and transport plant protection products only in approved containers.
- Never store the plant protection products in containers intended for foods, drinks or animal feed.
- Do not store plant protection products with foods, drinks or animal feed.
- Keep plant protection products out of the reach of children and animals.
- Store the sprayer empty and clean. It must not be under pressure.
- Store plant protection products and power tool in a place secured against unauthorized use.
- Store the unit in a dry place protected from frost.

## Disposal

Dispose of plant protection chemicals in accordance with environmental requirements – follow instructions of chemical manufacturer.

Never dispose of residual plant protection products or contaminated rinsing solutions in waterways, drains, sewers, street gutters or manholes.

- Dispose of residual chemicals and used containers in accordance with local waste disposal regulations.

## Holding and Controlling the Unit

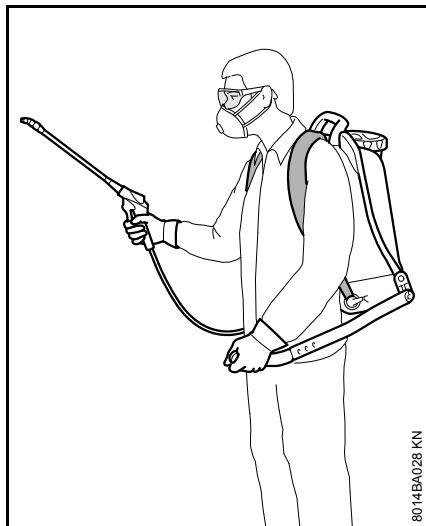

Carry the unit on your back with both harness straps – do not hang it over one shoulder.

Walk slowly forwards as you work – observe the nozzle outlet at all times – do not walk backwards – **risk of stumbling.**

Hold the unit upright. To avoid the risk of chemical leaking from the tank and causing injury, **do not bend forwards.**

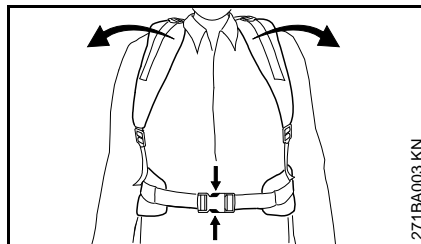

For emergencies: Practice quickly opening the fastener on the waist belt (SG 71 only), loosening the shoulder straps and setting down the unit. To avoid damage, do not throw the unit to the ground when practicing.

## During Operation



Never spray in the direction of bystanders – **risk of injury.**

**Take special care in slippery conditions** – damp, snow, ice, on slopes or uneven ground.

Watch out for obstacles: Be careful of refuse, tree stumps, roots and ditches which could **cause you to trip or stumble.**

**To reduce the risk of accidents,** take a break in good time to avoid tiredness or exhaustion.

Work calmly and carefully – in daylight conditions and only when visibility is good. Stay alert so as not to endanger others.

Never work on a ladder or any other insecure support.

When working in open ground and gardens take special care to avoid harming small animals.

To reduce the **risk of electrocution,** never work in the vicinity of live wires or power cables.

Always clean the sprayer before changing to a different plant protection product.

## After Finishing Work

Check all parts of the unit for leaks.

After finishing work, thoroughly clean the unit and wash your hands, face and, if necessary, your clothes.

Keep other persons and animals away from the areas that have been sprayed and do not walk on them until the plant protection chemical has dried.

## Maintenance and Repairs

Do not attempt any maintenance or repair work not described in the instruction manual. Have all other work performed by a servicing dealer.

STIHL recommends that you have servicing and repair work carried out exclusively by an authorized STIHL servicing dealer. STIHL dealers are

regularly given the opportunity to attend training courses and are supplied with the necessary technical information.

Only use high-quality replacement parts in order to avoid the risk of accidents and damage to the unit. If you have any questions in this respect, consult a servicing dealer.

STIHL recommends the use of genuine STIHL replacement parts. They are specifically designed to match your model and meet your performance requirements.

Always clean and empty the tank and release pressure in the sprayer before carrying out any maintenance or repair work.

When cleaning the tank, tube and hose system, make sure that other persons are not endangered by escaping liquid – **risk of injury.**

## Assembling the Unit

The small hardware required for assembly is in the tank.

### Connecting Hose to Unit

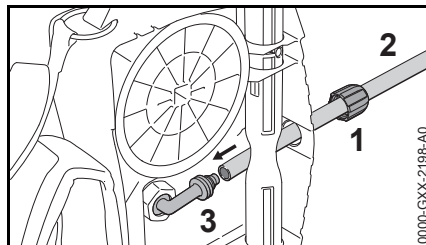

- Push the union nut (1) over the hose (2).
- Push the hose (2) behind the shaft and onto the elbow connector (3).
- Slip the union nut (1) onto the elbow connector (3) and tighten it down firmly by hand.

### Mounting the Spray Gun

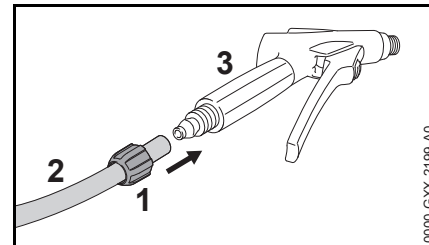

- Push the union nut (1) over the hose (2).
- Push the hose (2) onto the connector on the gun (3).
- Tighten down the union nut (1) by hand.

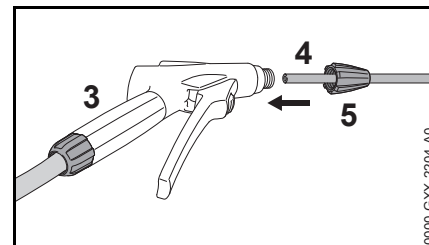

- Push the spray wand (4) into the connector on the gun (3).
- Tighten down the union nut (5) by hand.



## Mounting the Lever

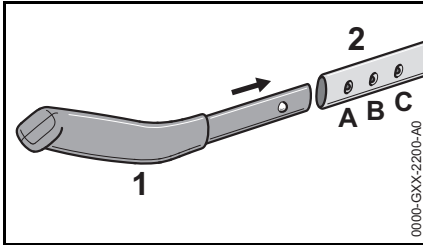

The length of the handle (1) can be adjusted (A, B, C) to suit the operator.

- Push the handle (1) into the lever (2).

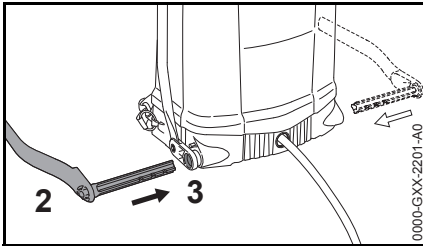

The lever can be mounted on the left or right of the unit.

- Push the lever (2) into the shaft (3).

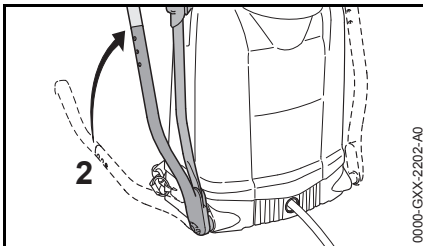

- Swing the lever (2) upwards.
- Lay the unit on its side.

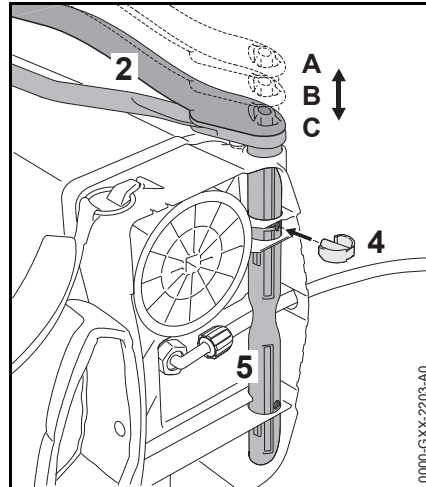

The position of the lever (2) can varied to suit the operator's size.

- Set the distance (A, B or C) as required.
- Insert retaining pin (4) in the hole in the shaft (5) to secure the lever (2).

## Harness

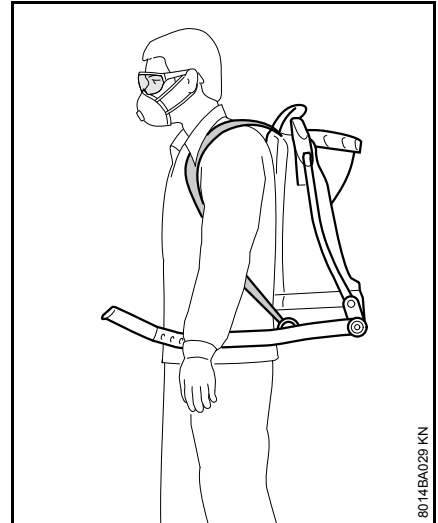

- Adjust the harness straps so that the backplate fits snugly and securely against your back.

### Adjusting Height of Harness Straps

The harness straps can be adjusted to suit your physique.

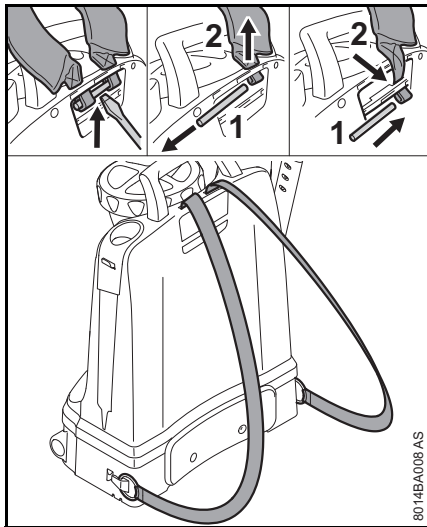

- Use a screwdriver to pry the pin (1) out of the backplate.
- Remove the pin (1) and pull out the ends of the harness straps (2).
- Fit the ends of the harness straps (2) in the lower position.
- Insert pin (1) and engage it in the backplate.

### Adjusting the Harness Straps

The SG 71 is equipped with a waist/hip belt.

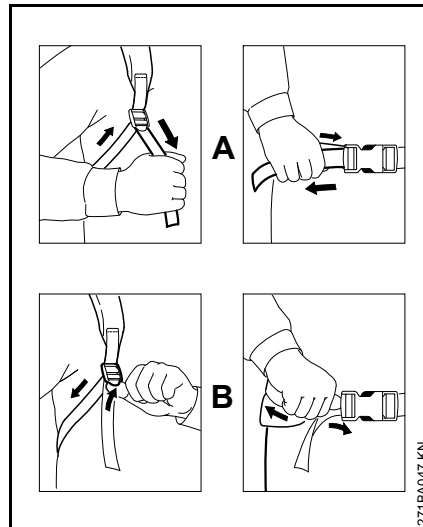

- A** Pull the ends of the straps downward to tighten the harness.
- B** Lift the tabs of the adjusters to loosen the straps.

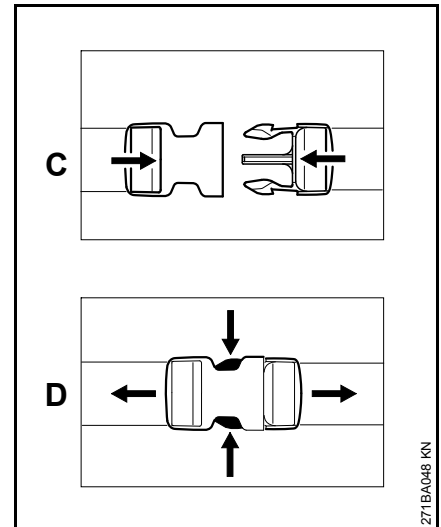

- C** Close and lock the quick-release fastener by pushing it together.
- D** Squeeze the hooks to open the quick-release fastener.

## Controls

Make yourself familiar with how the controls function before using your sprayer for the first time.

### Lever

#### Pressurizing the tank

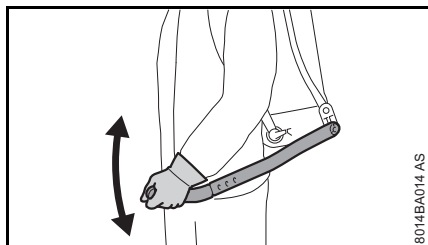

- Operate the pump lever slowly and steadily with the gun closed – several strokes are required to build up pressure.

#### Transport position

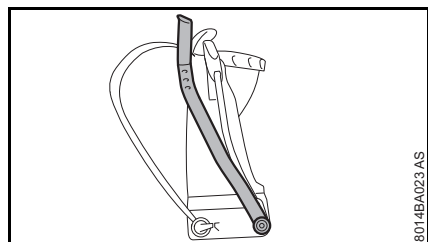

- Move the pump lever to upright position until it engages.

### Cap

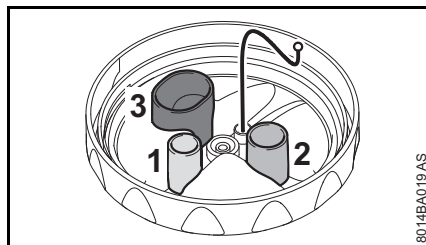

There are three measuring cups in the cap. They can be used to prepare the plant protection solution.

- 1 5 ml (0.2 fl.oz)
- 2 10 ml (0.3 fl.oz)
- 3 25 ml (0.8 fl.oz)

### Spray Gun

#### Unlocking / locking spray gun

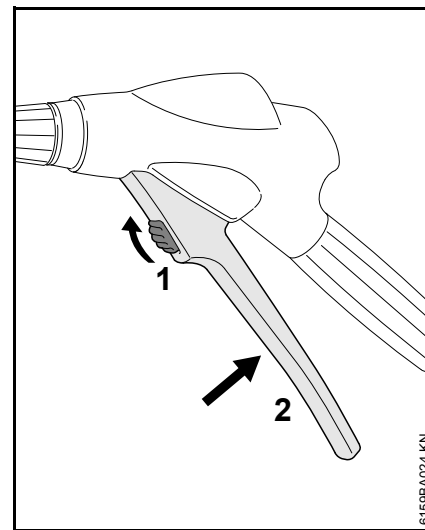

- Push locking lever (1) upwards – the trigger (2) is unlocked and can be operated.

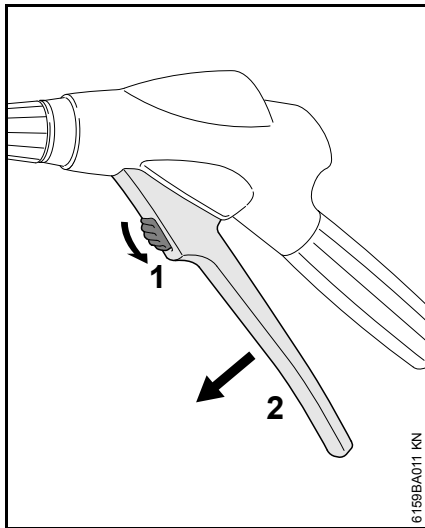

- Push the locking lever (1) downwards – the trigger (2) is locked to reduce the risk of accidental operation.

## Filling the Container

Before filling the tank with chemicals, carry out a test with fresh water and check all parts of the sprayer for leaks.

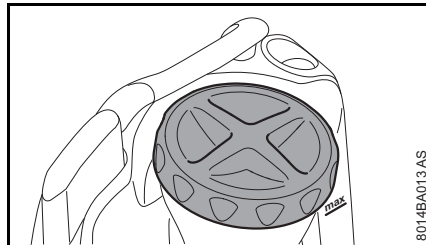

- Stand the sprayer on a level surface.
- Remove the cap from the tank.

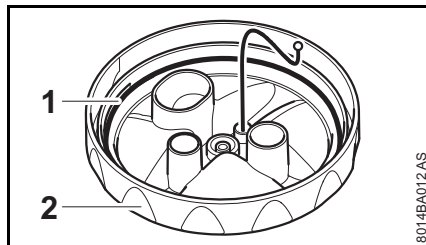

- Check the O-ring (1) in the cap (2). It must be in good condition.

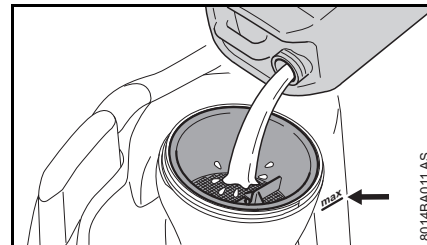

- Fill up with thoroughly mixed plant protection solution – do not overfill (no further than max. mark – arrow).

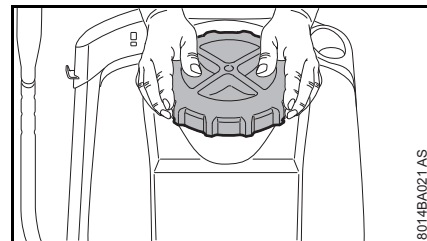

- Fit the cap and tighten it down firmly with both hands.

## Spraying

- Carry the unit on your back with both harness straps – do not hang it over one shoulder.
- Operate the pump lever slowly and steadily with the gun closed – several strokes are required to build up pressure.
- Operate the gun and always pay attention to the optimal working pressure while spraying.
- If the working pressure drops more than 0.5 bar (7.25 PSI) , restore it by operating the pump handle.

Working pressures / spray rates – see "Specifications".

## After Spraying

- Empty the container in a well ventilated location.
- Rinse the container with clean water.
- Fill the container with clean water.
- Fit the cap on the container and tighten it down firmly.
- Pressurize the container and continue spraying until the container is empty and no longer under pressure.

## Storing the Machine

- Secure the unit against unauthorized use.
- Dry the unit and store it in a place protected from direct sunlight and frost.

## Inspection and Maintenance by User

### Greasing the piston packing

#### Removal

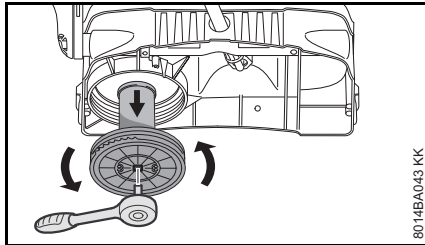

- Unscrew the pump tube from the container

The pump cover can be opened using a 1/2" ratchet wrench.

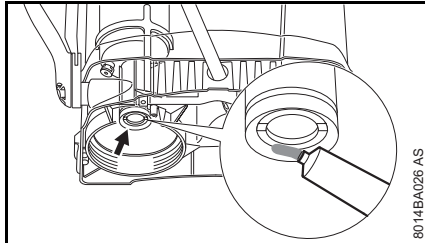

- Grease piston packing with a lubricating grease

#### Installing

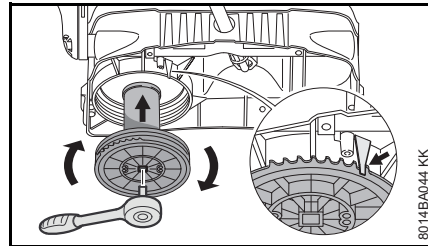

- Screw the pump tube into the container until the lug (arrow) engages in the tothing.

#### Oil pump rod

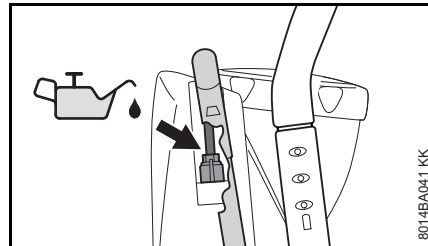

- Apply a few drops of resin-free oil to the pump rod

### Greasing the bearing of the pump lever

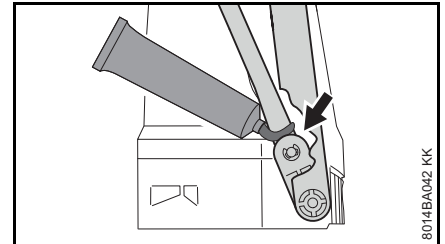

- Grease the bearing of the pump lever

### Cleaning the filter

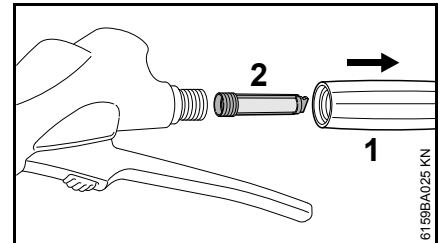

- Unscrew the handle (1) from the spray gun and take out the filter (2)

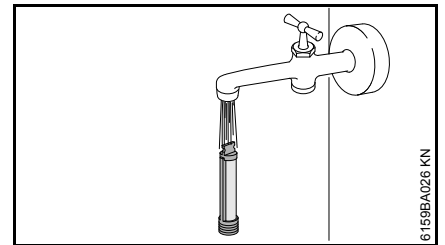

- Rinse out the filter under running water

## Cleaning the nozzle

---

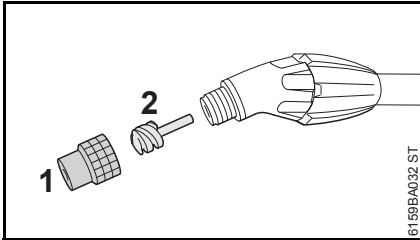

- Unscrew the hollow-cone nozzle (1) with swirl insert (2)

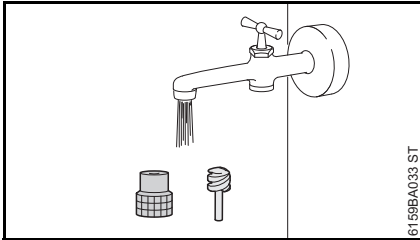

- Rinse out all parts under running water and then reassemble

## Maintenance and Care

The following intervals apply to normal operating conditions only. If your daily working times are longer, shorten the specified intervals accordingly.		before starting work	after finishing work or daily	weekly	monthly	every 12 months	if problem	if damaged	as required	after 50 refills
Complete unit	Visual inspection (condition, leaks)	X								
	Clean		X							
O-ring in container's cap	Visual inspection (condition, leaks)	X								
Solution container, hose system, wand	Drain		X							
	Clean		X							
Nozzle	Clean		X				X			
Filter in spray gun	Clean					X	X			X
Piston cup seal	Lubricate with grease					X	X			X
Pump rod	Lubricate with oil					X				X
Pump lever bearing	Lubricate with grease					X				X
Safety labels	Replace							X		



## Main Parts

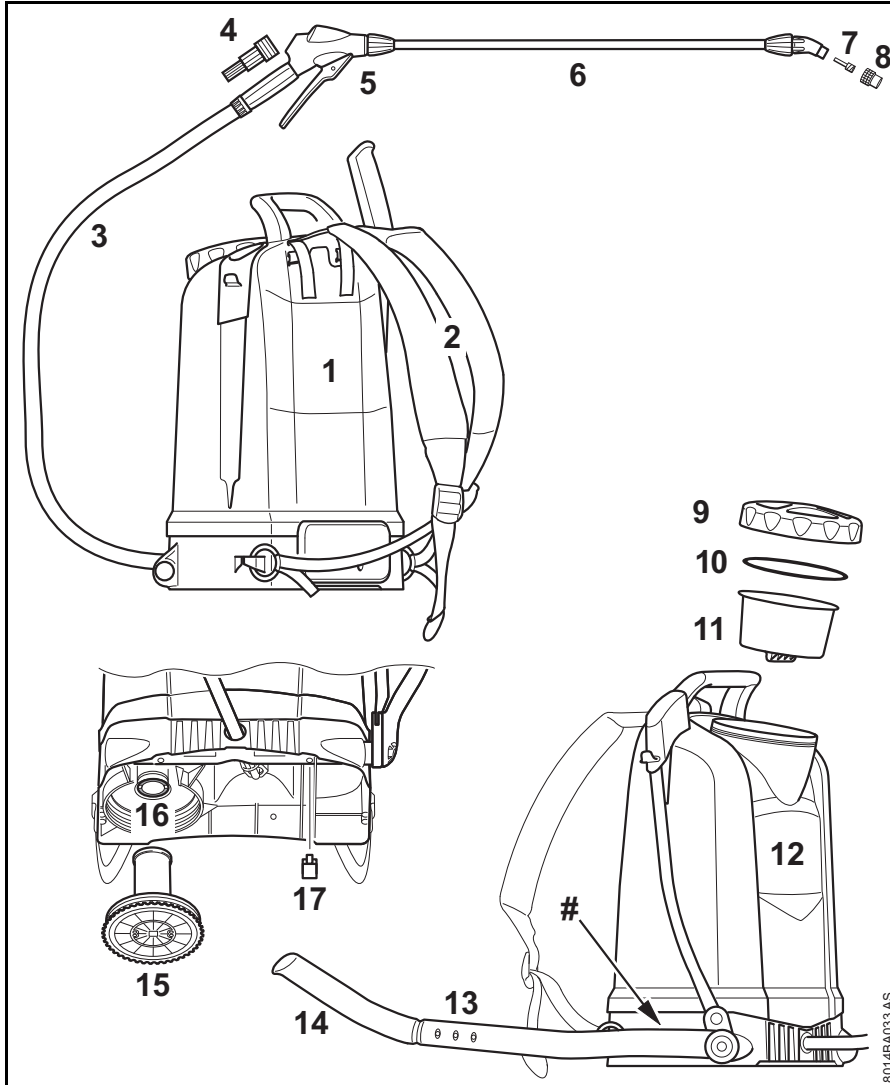

- 1 Backplate
- 2 Harness
- 3 Hose
- 4 Filter
- 5 Spray gun
- 6 Spray wand
- 7 Spinner insert
- 8 Hollow cone nozzle
- 9 Container cap
- 10 Gasket
- 11 Strainer
- 12 Tank
- 13 Lever
- 14 Handle
- 15 Pump barrel
- 16 Piston cup seal
- 17 Retaining pin
- # Serial number

8014BA033 AS

## Specifications

### Working Pressures / Spray Rates

Working pressure	Flow rate with hollow cone nozzle
1.0 bar	0.39 l/min
1.5 bar	0.49 l/min
2.0 bar	0.56 l/min
3.0 bar	0.69 l/min
4.0 bar	0.81 l/min
6.0 bar	0.96 l/min

### SG 51 Specifications

Working pressure, max.:	6 bar
Flow volume, max.:	1.4 l/min
Solution capacity, max.:	12 l
Operating temperature, max.:	40°C
Residual solution in tank:	<0.25 l
Recoil force:	<20 N
Dry weight:	4.5 kg

### SG 71 Specifications

Working pressure, max.:	6 bar
Flow volume, max.:	1.4 l/min
Solution capacity, max.:	18 l
Operating temperature, max.:	40°C
Residual solution in tank:	<0.27 l
Recoil force:	<20 N
Dry weight:	4.8 kg

## Troubleshooting

Before starting, spray the unit empty until the pressure has been completely relieved - when working on the unit, liquid may splash out uncontrollably if the pressure is not released.

After the work, carry out a test run with clear water.

<b>Fault</b>	<b>Cause</b>	<b>Remedy</b>
Pressure gauge does not show the container pressure	Pressure gauge defective	Replace pressure gauge
Pumping action produces no pressure. Lever is remarkably easy to operate	Pump tube damaged	Replace pump tube
	Valve disc damaged	Replace valve discs <sup>1)</sup>
	Piston packing damaged	Replace piston packing <sup>1)</sup>
Lever blocked or difficult to move down	Piston packing not greased	Grease piston packing
	Nozzle / swirl insert / filter blocked	Clean nozzle / swirl insert / filter
Tool only sprays when pumping	Pressure vessel fully filled with liquid	Pump the unit completely empty. Repeat after 5 fillings at the latest
Nozzle does not spray – pressure in unit OK	Nozzle / swirl insert / filter blocked	Clean nozzle / swirl insert / filter
Liquid drips from the nozzle	Nozzle / swirl insert / filter blocked	Clean nozzle / swirl insert / filter
Jet only – no atomization	Swirl insert on the nozzle missing	Insert swirl insert into nozzle
	Nozzle fouled	Cleaning the nozzle

<sup>1)</sup> STIHL recommends STIHL servicing dealers

## Maintenance and Repairs

Users of this machine may only carry out the maintenance and service work described in this user manual. All other repairs must be carried out by a servicing dealer.

STIHL recommends that you have servicing and repair work carried out exclusively by an authorized STIHL servicing dealer. STIHL dealers are regularly given the opportunity to attend training courses and are supplied with the necessary technical information.

When repairing the machine, only use replacement parts which have been approved by STIHL for this power tool or are technically identical. Only use high-quality replacement parts in order to avoid the risk of accidents and damage to the machine.

STIHL recommends the use of original STIHL replacement parts.

Original STIHL parts can be identified by the STIHL part number, the **STIHL** logo and the STIHL parts symbol  (the symbol may appear alone on small parts).

## Disposal

Observe all country-specific waste disposal rules and regulations.

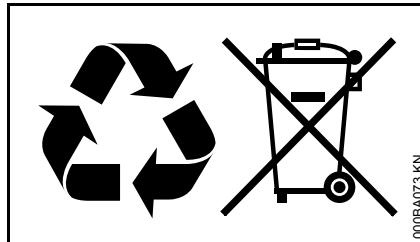

STIHL products must not be thrown in the garbage can. Take the product, accessories and packaging to an approved disposal site for environment-friendly recycling.

Contact your STIHL servicing dealer for the latest information on waste disposal.

## EC Declaration of Conformity

ANDREAS STIHL AG & Co. KG  
Badstr. 115  
D-71336 Waiblingen

Germany

Declare in exclusive responsibility that the product

Category:                   Sprayer  
Make:                         STIHL  
Model:                        SG 51, SG 71  
Serial identification:    4255

conforms to the relevant provisions of Directive 2006/42/EC and has been developed and manufactured in compliance with the following standards in the versions valid on the date of production:

DIN EN ISO 19932-1: 2013,  
DIN EN ISO 19932-2: 2014

Technical documents deposited at:

ANDREAS STIHL AG & Co. KG  
Produktzulassung (Product Licensing)

Done at Waiblingen, 17.06.2016

ANDREAS STIHL AG & Co. KG

Thomas Elsner

Director Product Management and Services

CE

0458-597-0121-A

englisch



[www.stihl.com](http://www.stihl.com)



0458-597-0121-A