

**STIHL**

**STIHL TS 440**

Instruction Manual





## Contents

Guide to Using this Manual	2
Safety Precautions and Working Techniques	2
Sample Applications	11
Cutting Wheels	14
Composite Abrasive Wheels	15
Diamond Abrasive Wheels	15
Abrasive wheel brake	18
Electronic Water Control	20
Mounting an Abrasive Wheel	21
Fuel	22
Fueling	23
Starting / Stopping the Engine	24
Air Filter System	28
Adjusting the Carburetor	29
Spark Arresting Screen in Muffler	30
Spark Plug	30
Storing the Machine	31
Maintenance and Care	32
Main Parts	34
Specifications	35
Maintenance and Repairs	36
Disposal	36
EC Declaration of Conformity	37

Dear Customer,

Thank you for choosing a quality engineered STIHL product.

It has been built using modern production techniques and comprehensive quality assurance. Every effort has been made to ensure your satisfaction and trouble-free use of the product.

Please contact your dealer or our sales company if you have any queries concerning this product.

Your



Dr. Nikolas Stihl

# STIHL

## Guide to Using this Manual

### Pictograms

---

Pictograms that appear on the machine are explained in this Instruction Manual.

Depending on the machine and equipment version, the following pictograms may appear on the machine.



Fuel tank; fuel mixture of gasoline and engine oil

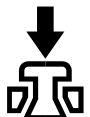

Actuate decompression valve

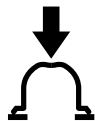

Actuate manual fuel pump



Pull starter grip



Actuate brake lever and release abrasive wheel brake

### Symbols in text

---



#### WARNING

Warning where there is a risk of an accident or personal injury or serious damage to property.



#### NOTICE

Caution where there is a risk of damaging the machine or its individual components.

### Engineering improvements

---

STIHL's philosophy is to continually improve all of its products. For this reason we may modify the design, engineering and appearance of our products periodically.

Therefore, some changes, modifications and improvements may not be covered in this manual.

## Safety Precautions and Working Techniques



Special safety precautions must be taken when working with the cut-off machine, due to the very high rotational speed of the abrasive wheel.



It is important you read and understand the Instruction Manual before first use and keep the manual in a safe place for future reference. Non-observance of the safety instructions may result in serious or even fatal injury.

Comply with national safety regulations, e.g. issued by employers' liability insurance associations, social security institutions, occupational safety and health authorities or other organizations.

For employers within the European Union, Directive 2009/104/EC is binding – Minimum safety and health requirements for the use of work equipment by workers at work.

Anyone using the power tool for the first time: Let the retailer or another expert explain to you how to handle it safely – or attend a training course.

Minors are not allowed to use the power tool, except adolescents above 16 years of age receiving instruction under supervision.

Keep children, animals and bystanders at a safe distance.

When the machine is not in use, put it down safely so that it does not endanger anyone. The machine must be secured against unauthorized access.

The user is responsible for accidents or hazards to third parties or damage to their property.

Hand over or lend the power tool only to persons who are familiar with this model and its handling – always give them the instruction manual as well.

The use of noise-emitting machines may be restricted to certain times by national or local regulations.

The machine may only be operated by people who are fit, in good physical health and in good mental condition.

If you have any condition that might be aggravated by strenuous work, check with your doctor before operating a power tool.

If you have a pacemaker: The ignition system of this machine produces an electromagnetic field of very low intensity. An effect on individual pacemaker types cannot be excluded entirely. STIHL recommends that you consult your doctor and the manufacturer of your pacemaker in order to avoid health hazards.

Never work with the machine while under the influence of alcohol, medication or drugs capable of impairing your reaction speed.

Postpone the work if the weather is bad (snow, ice, wind) – **higher risk of accidents!**

The machine is designed only for cutting as specified. It is not suitable for cutting wood or wooden objects.

Asbestos dust is extremely toxic – the machine must therefore **never be used to cut asbestos!**

Do not use the machine for any other purpose because of the increased risk of accidents and damage to the machine.

Do not modify the machine – otherwise safety may be compromised. STIHL excludes all liability for personal injury and damage to property caused by using unauthorized attachments.

Only use abrasive wheels or accessories which have been approved by STIHL for this machine or which are technically equivalent. If you have any questions in this respect, consult a servicing dealer. Only use high-quality abrasive wheels and attachments.

Otherwise there may be a risk of accidents or damage to the machine.

STIHL recommends the use of genuine STIHL abrasive wheels and accessories. These have been optimized for the product and the user's requirements.

Do not use a pressure washer to clean the machine. The strong water jet can damage parts of the machine.

Do not spray the machine with water.



Never use circular saw blades, carbide, rescue or wood cutting attachments or saws of any kind – **these may cause fatal injuries!** Instead of uniformly removing particles as when cutting with an abrasive wheel, the teeth of a circular saw blade may snag in the material. This causes the machine to react in a highly aggressive manner with uncontrolled and extremely dangerous kickback.

### Clothing and equipment

Wear proper protective clothing and equipment.



Clothing must be sturdy and snug-fitting, but allow complete freedom of movement. Wear close-fitting clothes such as a boiler suit, not a loose jacket

When cutting steel, always wear clothing made of barely flammable material (e.g., leather or cotton with flame-retardant finish) – no man-made fibers – **risk of fire due to flying sparks!**

Ensure that there are no flammable deposits (chips, fuel, oil, etc.) on your clothing.

Remove any clothes that could be trapped by moving parts, such as a scarf, tie or jewelry. Long hair must be tied up and covered.



Wear **safety boots** with steel toe caps and non-slip soles.

**! WARNING**



To reduce the risk of eye injuries, wear tight-fitting safety goggles conforming to standard EN 166. Make sure that the safety goggles fit correctly.

Wear a face mask and make sure it fits correctly. A face mask alone is not sufficient to protect the eyes.

Wear a hard hat wherever there is any risk of falling objects.

While working, dust (for example, crystalline material from the object to be cut), vapor and smoke may be produced – **danger to health!**

Always wear a **dust mask** if dust is generated.

If fumes or smoke are anticipated (e.g., when cutting composite materials), wear **respiratory protection**.

Wear "personal" **hearing protection** – for example, ear defenders.



Wear sturdy protective gloves made of a resistant material (e.g. leather).

STIHL can supply a comprehensive range of personal protective clothing and equipment.

### Transporting the machine

Always turn off the engine first.

Carry the machine by the handlebar only – abrasive wheel pointing to the rear – hot muffler away from the body.

Do not touch hot machine parts, in particular the muffler surface – **risk of burns!**

Never transport the power tool with cutting wheel fitted – **risk of breakage!**

In vehicles: Properly secure the machine to prevent turnover, damage and fuel spillage.

### Refueling



**Gasoline is an extremely flammable fuel** – keep clear of naked flames and fire – do not spill any fuel – no smoking.

**Switch off the engine** before refueling.

Never refuel the machine while the engine is still hot – the fuel may spill over – **risk of fire!**

Open the fuel filler cap carefully so that any excess pressure is relieved gradually and fuel does not splash out.

The machine may only be refueled in a well ventilated place. If fuel has been spilled, immediately clean the machine – do not allow your clothes to be splashed with fuel. If that happens, change your clothes at once.

Dust may collect on the engine unit, especially around the carburetor. If dust gets mixed with fuel – risk of fire! Remove the dust from the engine unit regularly.



Look out for leaks! Never start the engine if fuel has been spilled or is leaking - **Fatal burns may result!**

### Bayonet filler cap

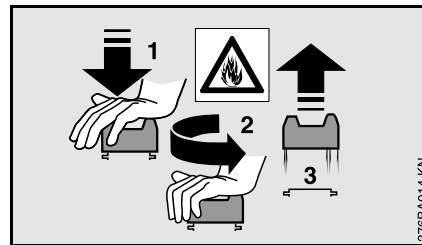

Never use a tool to open or close the bayonet filler cap. The cap can be damaged and fuel may escape.

Secure the bayonet filler cap tightly after refueling.

### Cut-off machine, spindle bearing

Correct spindle bearings ensure the concentricity and axial running of the diamond-tipped abrasive wheel – if necessary, get it checked by an approved dealer.

## Abrasive wheels

### Selecting the abrasive wheels

Abrasive wheels must be approved for freehand cutting. Do not use other cutting wheels and attachments – **risk of accident!**

Abrasive wheels are suitable for different materials: Observe the identification of the abrasive wheels.

STIHL generally recommends wet cutting.

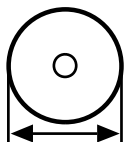

Observe the outer diameter of the abrasive wheel.

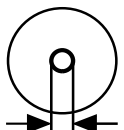

Spindle hole diameter of the abrasive wheel and shaft of cut-off machine must match.

Check the spindle hole for damage. Do not use cutting wheels with a damaged spindle hole – **risk of accident!**



The permissible speed of the abrasive wheel must be equal to or greater than the maximum spindle speed of the cut-off machine. – Refer to the chapter "Specifications".

Before fitting a used abrasive wheel, check that it is not cracked, chipped, undercut or uneven, and does not display any signs of core fatigue or overheating (discoloration); check also

that there are no damaged or missing segments and that the spindle hole is not damaged.

Never use cracked, chipped or bent abrasive wheels.

Substandard and/or unapproved diamond abrasive wheels can shimmy during cutting. This shimmying can cause such diamond abrasive wheels to be abruptly braked or become stuck in the cut – **Danger of kickback! Kickback can result in fatal injuries!** Diamond abrasive wheels that shimmy constantly or even only intermittently must be replaced immediately.

Never straighten diamond abrasive wheels.

Do not use a cutting wheel which has fallen to the ground – damaged cutting wheels may break – **risk of accident!**

Observe the expiration date where resin abrasive wheels are concerned.

### Fitting abrasive wheels

Inspect the spindle of the cut-off machine. Do not use a machine if the spindle is damaged – **risk of accident!**

Note the arrows indicating the direction of rotation on diamond abrasive wheels.

Position the front pressure plate – tighten up the clamping screw – rotate the cutting wheel by hand and take a sight check for concentricity and axial running.

### Storing abrasive wheels

Store abrasive wheels in a dry and frost-free place, on an even surface, at constant temperature – **risk of breakage and splintering!**

Always protect the abrasive wheel against sudden contact with the ground or objects.

### Before starting

Inspect the cut-off machine to check that it is in full working order – observe the respective chapters in the instruction manual:

- Check the fuel system for leaks, especially the visible parts, e.g., filler cap, hose connections, manual fuel pump (only on machines with a manual fuel pump). In case of leakage and damage, do not start the engine – **risk of fire!** Have the machine serviced by a servicing dealer before using it.
- The abrasive wheel must be suitable for the material to be cut. It must be in good condition and fitted correctly (direction of rotation, secure).
- Inspect the cutting wheel guard for tight seat – if loose, contact your specialist dealer.
- Both the throttle trigger and the throttle trigger lockout must move smoothly – the throttle trigger must automatically return to the idle position.
- Slide control / master control / stop switch must move easily to **STOP** or **0**
- Check that the spark plug boot is secure. A loose boot can lead to flying sparks which may ignite the escaping fuel/air mixture – **risk of fire!**

- Check the correct operation of the abrasive wheel brake. When the brake lever is activated, the abrasive wheel can be turned by hand – when the brake lever is released, the abrasive wheel can no longer be turned. It should not be possible to turn the abrasive wheel when the brake lever is not activated.
- Never attempt to modify the controls or safety devices in any way
- Keep the handles clean, dry, and free of oil and dirt – important for good control of the cut-off machine.
- For wet applications, provide sufficient water

The machine should only be used if it is in good working order – **risk of accident!**

### Starting the engine

Move at least 3 meters away from the place at which the machine was refueled and never start the machine in an enclosed space.

On even ground, ensure a firm and secure footing and hold the power tool firmly – the cutting wheel must not touch the ground or any objects and must not be in the cut.

The abrasive wheel brake is engaged when starting the machine. If the abrasive wheel starts turning immediately the machine is started, do not use the cut-off machine. Consult a Stihl servicing dealer. Have the abrasive wheel brake repaired.

The power tool is operated by a single person only – do not allow anyone else within the working area – not even when starting.

Do not drop-start the engine – start as described in the Instruction Manual.

After releasing the throttle trigger, the abrasive wheel keeps on running for a while – **danger of injury due to coasting effect!**

### Holding and controlling the machine

Use the cut-off machine only for hand-held cutting.

#### Hand-held cutting

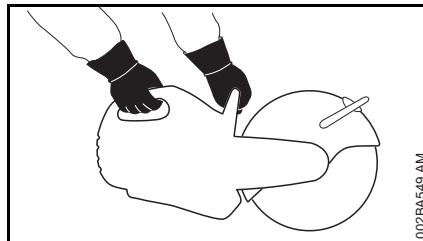

Always hold the machine **firmly with both hands**: Right hand on the rear handle – even if you are left-handed. To ensure reliable control, wrap your thumbs tightly around the handlebar and handle.

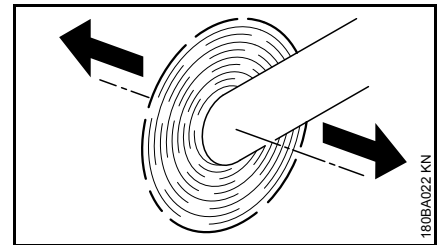

When a cut-off machine with an abrasive wheel rotating is moved in the direction of the arrow, a force is produced which causes the machine to tip sideways.

The object to be cut has to be firmly supported. Always guide the machine towards the workpiece, never the other way round.

### Guard

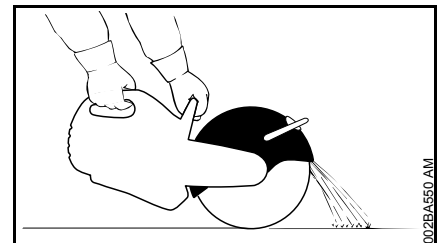

Set the abrasive wheel guard correctly: Direct particles of material away from the user and machine.

Note the direction of travel of the abraded particles of material.

### During operation

If there is imminent danger or in an emergency, immediately stop the engine – set the slide control / master lever / stop switch to **STOP** or **0**.



Check for correct idling so that the abrasive wheel is no longer driven when the throttle trigger is released and comes to a complete halt.

Check and/or correct the idle setting regularly. Have the machine repaired by a STIHL servicing dealer if the cutting wheel continues to turn nevertheless after the abrasive wheel brake has been released.

Keep the working area clear – bear in mind obstacles, holes and pits.

Take care on ice, water, snow, on slopes or uneven ground, etc. – **risk of slipping!**

Do not work while standing on a ladder – or in unstable places – not above your shoulder height – not with one hand only – **risk of accident!**

Ensure you always have a firm and secure footing.

Never work alone – always stay in earshot of other persons who can help in an emergency.

Keep everyone else away from the working area – maintain a sufficient distance from other people to protect them from noise and flying objects.

Pay increased attention and take greater care when wearing ear defenders – the perception of sounds indicating potential danger (shouts, audible warnings, etc.) is restricted.

Take a break in good time before you get tired.

Work calmly and carefully – in daylight conditions and only when visibility is good. Work with particular care, do not endanger others.



Your power tool produces toxic exhaust fumes as soon as the engine starts running. These gases may be colorless and odorless and may contain unburnt hydrocarbons and benzene. Never use the machine indoors or in poorly ventilated areas – even if your model is equipped with a catalytic converter.

Ensure proper ventilation when working in trenches, hollows or similar locations – **risk of fatal injury from breathing toxic fumes!**

Stop working immediately if you feel sick, have a headache, distorted vision (for example, shrinking field of vision), hearing impairment, dizziness, fading powers of concentration – such symptoms may be caused, among other things, by excessive exhaust concentrations – **risk of accident!**

**No smoking** when working with or near the machine - **risk of fire!**

If the power tool has been exposed to stress due to improper use (e.g. forceful impact by striking or dropping), inspect the machine to make sure it is in full working order before continuing work, in every case – see also "Before start-up". Check the fuel system for leaks and make sure the safety devices are working properly. Do not continue operating a machine which is damaged. In case of doubt, have the unit checked by your servicing dealer.

Do not work with the throttle trigger in the starting throttle position – in that position of the throttle trigger, the engine speed cannot be controlled.

Never touch a rotating abrasive wheel with your hand or any other part of your body.

Check the work area. Avoid danger due to damage to pipes and electric power lines.

The machine must not be used in the vicinity of flammable substances and combustible gases.

Do not cut into pipes, metal tanks or other containers unless you are absolutely sure that they do not contain any volatile or flammable substances.

Never leave the machine unattended with the engine running. Stop the engine before leaving the machine unattended (e.g. for breaks).

Stopping the engine engages the abrasive wheel brake. If the cut-off machine is on the ground with the abrasive wheel turning when the engine is switched off, engaging the abrasive wheel brake may cause the cut-off machine to topple forward, bringing the abrasive wheel into contact with the ground – **material damage!**

Before putting the cut-off machine down on the ground:

- Switch off the engine
- Wait until the abrasive wheel has come to a standstill or brake the abrasive wheel until it comes to a standstill by carefully touching a hard surface (e.g., concrete slab)



Frequently inspect the cutting wheel – replace the wheel right away if there are visible cracks, buckling or other damage (for example, overheating) – **risk of accident due to breakage!**

In the event of changes in cutting behavior (e.g., increased vibration, reduced cutting performance), stop work and eliminate the causes of the changes.

### Reactive forces

The most frequently occurring reactive forces are kickback and pull-in.



Danger of kickback – **Kickback can result in fatal injuries.**

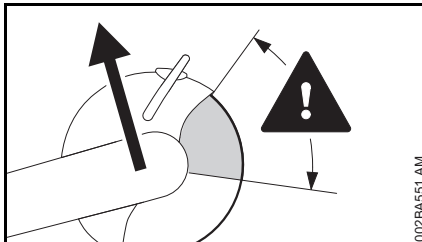

Kickback occurs when the cut-off machine is suddenly thrown up and back in an uncontrolled arc towards the operator.

### Kickback occurs if, for example, the abrasive wheel

- gets jammed – especially the upper quarter, or
- is abruptly braked through friction contact with a solid object

### QuickStop abrasive wheel brake

If activated, the abrasive wheel brake stops the abrasive wheel within a fraction of a second – refer to chapter "Abrasive wheel brake" in this Instruction Manual.

### Reducing the risk of kickback

- Work cautiously and methodically
- Hold the cut-off machine firmly with both hands and maintain a secure grip

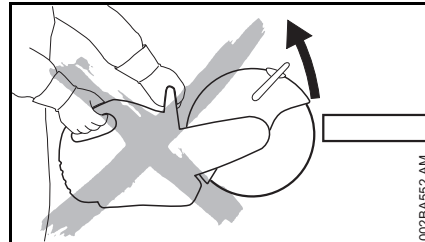

- Do not use the upper quarter of the abrasive wheel for cutting. Use extreme caution when guiding the abrasive wheel into a cut, do not twist or push into the cut

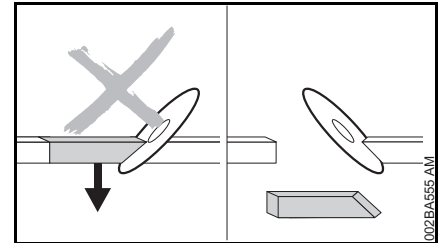

- Avoid any wedge effect - the severed part must not brake the abrasive wheel
- Always be aware that the object to be cut may move and other factors may cause the cut to close and jam the abrasive wheel.
- The object to be cut must be secured and supported so that the kerf remains open during and after cutting
- Objects to be cut must therefore be fully supported and must be secured against rolling away, slipping off or vibrations

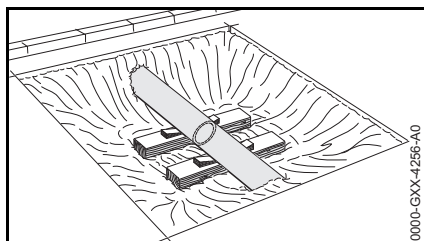

- An exposed pipe must be provided with a stable support that will bear its weight, using wedges if necessary – always bear in mind a proper support and the nature of the ground – material may crumble away
- Always work with water and wet cutting when using diamond abrasive wheels

### Pulling away

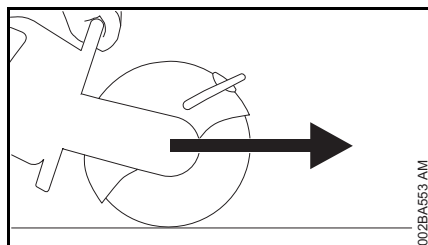

The cut-off machine pulls forward, away from the user, when the abrasive wheel touches the object to be cut from above.

### Working – cutting



The abrasive wheel must be guided straight in the cut, without wedging. Never exert lateral pressure on the abrasive wheel.



Do not use for lateral grinding or roughing.

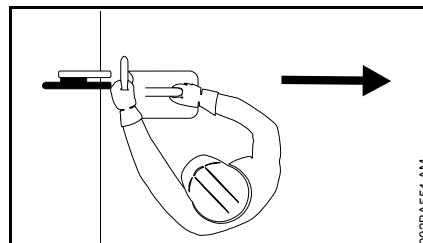

Do not stand in line with the abrasive wheel. Ensure sufficient freedom of movement, especially in construction trenches there must be sufficient space for the user and for the part being cut to fall.

Do not lean too far forwards and never bend over the abrasive wheel, especially when the guard has been pulled back.

Do not work above shoulder height.

The cut-off machine may only be used for cutting. It must not be used as a lever or shovel.

Do not press down on the cut-off machine.

Always decide the cutting direction before positioning the cut-off machine. Do not change the cutting direction. Never use the machine to push or hit into the cutting gap – do not let the machine fall into the gap – **risk of breakage!**

Diamond abrasive wheels: If cutting performance begins to deteriorate, check the sharpness of the diamond cutting wheel, sharpen as needed. To do this, briefly cut through abrasive material, e.g., sandstone, aerated concrete or asphalt.

At the end of the cut, the cut-off machine is no longer supported in the cut by the abrasive wheel. The user has to absorb the weight force – **risk of loss of control!**



When cutting steel: glowing metal particles **may cause fires!**

Keep water and sludge away from live electrical cables – **risk of electric shock!**

Pull the cutting wheel into the workpiece – do not push it into the material. Do not use the cut-off machine to correct severing cuts. Do not re-cut – remove any webs or breaking edges manually (for example, with a hammer).

When using diamond-coated cutting wheels, make a wet cut – for example, use the STIHL water connector.

Because of the reduced maximum spindle speed, STIHL has developed a special composite resin abrasive wheel for cutting steel. This abrasive wheel is only suitable for dry cutting. If a composite resin abrasive wheel of this type becomes wet, its cutting

performance is reduced and it becomes dull. If a composite resin abrasive wheel of this type becomes wet while working (e.g., due to puddles or water in pipes), do not increase the cutting pressure, but continue working with the same pressure – **risk of breakage!** Use up such composite resin abrasive wheels immediately.

Conventional composite resin abrasive wheels developed for cut-off machines with a high circumferential speed give a poor cutting performance and are therefore unsuitable.

### Vibrations

Prolonged use of the power tool may result in vibration-induced circulation problems in the hands (whitefinger disease).

No general recommendation can be given for the length of usage because it depends on several factors.

The period of usage is prolonged by:

- Hand protection (wearing warm gloves)
- Work breaks

The period of usage is shortened by:

- Any personal tendency to suffer from poor circulation (symptoms: frequently cold fingers, tingling sensations).
- Low outside temperatures.
- The force with which the handles are held (a tight grip restricts circulation).

Continual and regular users should monitor closely the condition of their hands and fingers. If any of the above symptoms appear (e.g. tingling sensation in fingers), seek medical advice.

### Maintenance and repairs

The machine must be serviced regularly. Do not attempt any maintenance or repair work not described in the Instruction Manual. All other work should be carried out by a servicing dealer.

STIHL recommends that maintenance and repair work be carried out only by authorized STIHL dealers. STIHL dealers receive regular training and are supplied with technical information.

Use only high-quality spare parts. Otherwise, there may be a risk of accidents and damage to the machine. If you have any questions in this respect, consult a servicing dealer.

STIHL recommends the use of genuine STIHL spare parts. Such parts have been optimized for the machine and the user's requirements.

Before starting any maintenance or repair work and before cleaning the machine, always **stop the engine and disconnect the spark plug boot – risk of injury** if the engine starts up inadvertently! – Exception: adjustment of carburetor and idle speed.

To reduce the **risk of fire** due to ignition outside the cylinder, move the slide control / stop switch to **STOP** or **0** before turning the engine over on the starter with the spark plug boot removed or the spark plug unscrewed.

Do not service or store the machine near a naked flame – **risk of fire** due to the fuel.

Check fuel cap regularly for tightness.

Use only spark plugs that are in perfect condition and have been approved by STIHL – see "Specifications".

Check ignition lead (insulation in good condition, secure connection).

Check that the muffler is in perfect working condition.

Do not use the machine if the muffler is damaged or missing – **risk of fire! – Hearing damage!**

Never touch a hot muffler – **risk of burns!**

Check the rubber buffers underneath the machine – the housing must not rub against the ground – **risk of damage!**

The condition of the anti-vibration elements influences vibration behavior – inspect anti-vibration elements periodically.

Before starting work, check the operation of the abrasive wheel brake.

## Sample Applications

**Water must always be used for wet cutting when working with diamond abrasive wheels**

**Extend service life and increase cutting speed**

Always ensure a supply of water to the abrasive wheel.

**Binding dust**

The abrasive wheel must be supplied with at least 0.6 liters of water per minute.

**Water attachment**

- Water attachment on the machine for all types of water supplies
- Pressurized water tank 10 l for binding dust

**STIHL composite resin cutting wheels may only be used for dry cutting**

During dry cutting, wear a suitable dust mask.

If fumes or smoke are anticipated (e.g., when cutting composite materials), wear **respiratory protection**.

**Observe with diamond and composite resin abrasive wheels**

**Objects to be cut**

- Must be fully supported
- Must be secured so they cannot roll or slip off
- Must be prevented from vibrating

**Severed parts**

With openings, recesses, etc., the sequence of the cuts is important. Always make the last cut so that the abrasive wheel does not become jammed and so that the operator is not endangered by the severed or separated part.

If necessary, leave small ridges that hold the part that is to be separated in position. Break these ridges later.

Before finally separating the part, determine:

- how heavy the part is
- how it can move after separation
- whether it is under tension

When breaking out the part, do not endanger assistants.

**Cut in several passes**

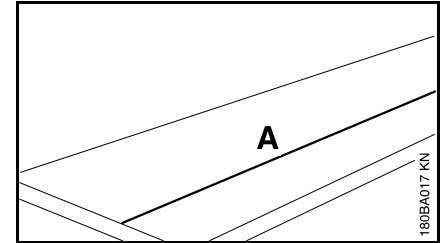

- Mark cutting line (A)

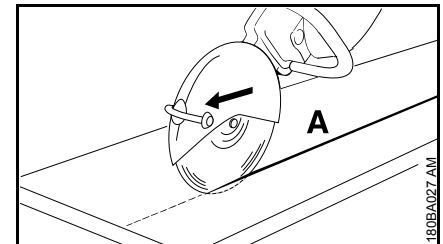

- Work along the cutting line. When making corrections, do not tilt the abrasive wheel, but always set the abrasive wheel against the workpiece anew – the cutting depth for each operation should not exceed 5 to 6 cm. Cut thicker material in multiple operations

**Cutting plates**

- Secure the plate (e. g. on a non-slip surface, sandbed)

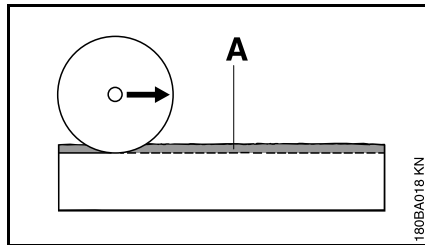

- Grind a guide groove (A) along the line marked

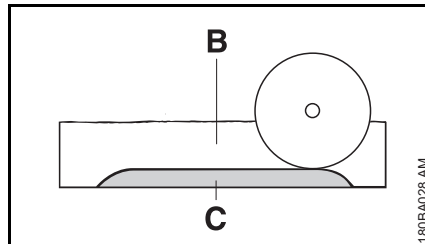

- Make the cut (B) deeper
- Leave a "hinge" (C)
- First sever the plate at the cut ends so that no material breaks away
- Break plate

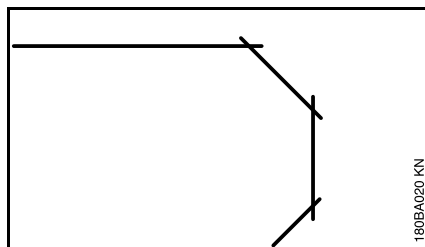

- Make curves in multiple operations – make certain that the abrasive wheel does not tilt

### Cutting pipes, round and hollow bodies

- Secure pipes, round and hollow bodies against vibrations, slipping and rolling away
- Note direction of fall and weight of the severed part
- Determine and mark the cutting line, avoid reinforcements, especially in the direction of the severing cut
- Determine sequence of severing cuts
- Grind a guide groove along the line marked
- Make cut deeper along the guide groove – observe the recommended cutting depth for each operation – for small corrections of direction, do not tilt the abrasive wheel, but always position it anew instead – if necessary, leave small ridges that hold the part that is to be separated in position. Break these ridges after the last planned cut

### Cutting concrete pipe

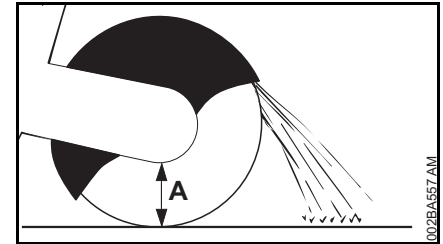

The procedure is dependent on the outer diameter of the pipe and the maximum possible cutting depth of the abrasive wheel (A).

- Secure pipe against vibrations, slipping and rolling away
- Note weight, tension and direction of fall of the part to be severed

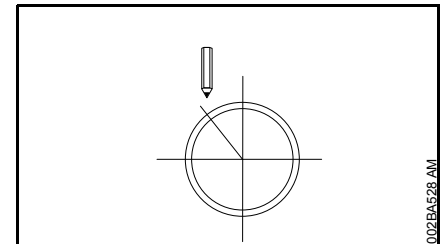

- Determine and mark direction of cut
- Determine sequence of cuts

Outer diameter is smaller than the maximum cutting depth

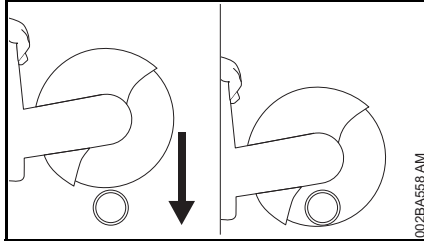

- Make **one** cut from the top to the bottom

Outer diameter is greater than the maximum cutting depth

Plan first, then cut. **Several** cuts are needed – correct sequence is important.

- Close guard, Illustration A

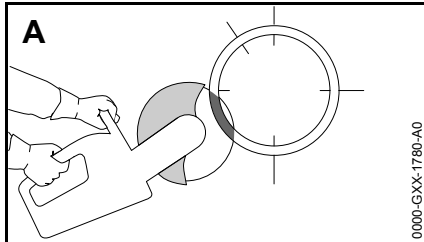

- Always start cut from underneath, Illustration A
- Open guard, Illustration B

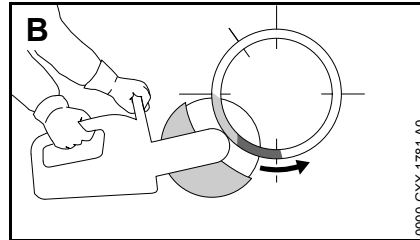

- Insert abrasive wheel at full throttle into the cut you have made, Illustration B
- Continue cutting downward more than half-way round the pipe, Illustration B
- Close guard, Illustration C

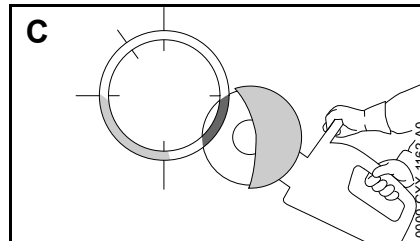

- Cut opposite underside, Illustration C
- Open guard, Illustration D

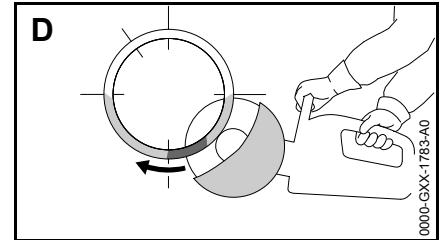

- Insert abrasive wheel at full throttle into the cut you have made, Illustration D
- Continue cutting downward more than half-way round the pipe, Illustration D
- Close guard, Illustration E

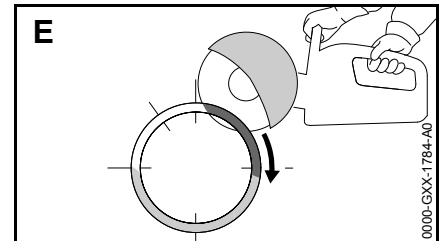

- First lateral cut on the top half of the pipe, Illustration E

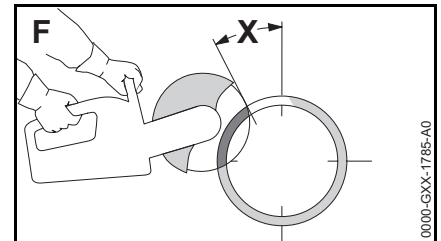

- Second lateral cut in the marked area – never cut into the area of the last cut (X), to ensure a firm hold on the part of pipe to be cut, Illustration F

Only make the last top cut once all bottom and lateral cuts have been made.

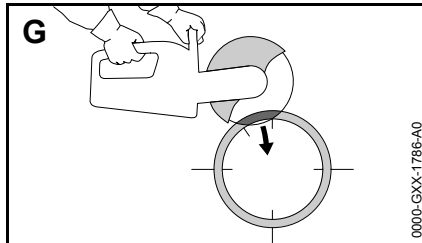

- Last cut always from the top (approx. 15 % of the pipe circumference), Illustration G

### Concrete pipe – cut recess

Sequence of cuts (1 to 4) is important:

- First, cut hard-to-reach areas

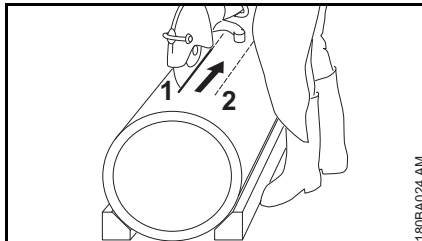

- Always make severing cuts so that the abrasive wheel is not pinched

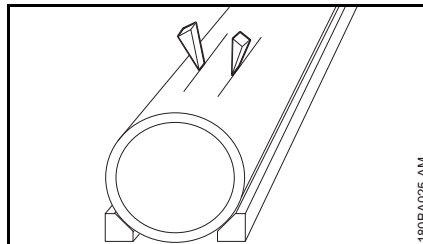

- Use wedges and/or leave ridges that are broken after cutting

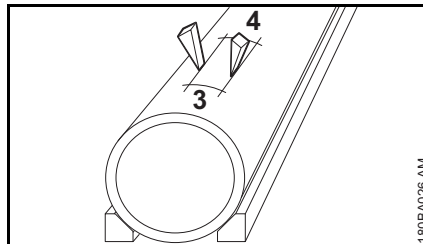

- If the severed part remains in the recess after cutting (due to wedges, ridges used), do not make any further cuts – break the severed part

## Cutting Wheels

Abrasive wheels are exposed to extremely high loads especially during freehand cutting.

Therefore only for use of approved and correspondingly labeled abrasive wheels with hand-held machines as per EN 13236 (diamond) or EN 12413 (composite resin). Note maximum permissible speed of the abrasive wheel – **risk of accident!**

The abrasive wheels, which have been developed by STIHL in cooperation with renowned manufacturers of abrasive wheels, are of high quality and tailored precisely to the respective intended use as well as the engine performance of the cut-off machine.

They are of consistently outstanding quality.

### Transport and storage

- Do not expose abrasive wheels to direct sunshine or other thermal stresses during transport and storage
- Avoid jolting and impacts
- Stack abrasive wheels flat on a level surface in the original packaging in a dry place where the temperature is as constant as possible
- Do not store abrasive wheels in the vicinity of aggressive fluids
- Store abrasive wheels in a frost-free place



## Composite Abrasive Wheels



Types:

- for dry applications

Because of the reduced maximum spindle speed, STIHL has developed a special composite resin abrasive wheel for cutting steel. This abrasive wheel is only suitable for dry cutting.

Do not cut any other materials – **Risk of accident!**

Conventional composite resin abrasive wheels developed for cut-off machines with a high circumferential speed give a poor cutting performance and are therefore unsuitable.

## Diamond Abrasive Wheels

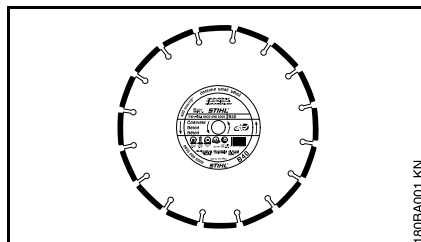

For wet applications.

The proper selection and use of diamond abrasive wheels ensures economical use and avoids accelerated wear. The product code which appears

- on the label and
- on the packaging (table with recommendations for use) is an aid to selection

STIHL diamond abrasive wheels are suitable, depending on the version, for cutting the following materials:

- Asphalt
- Concrete
- Stone (hard stone)
- Abrasive concrete
- Fresh concrete
- Clay brick
- Clay pipe
- Ductile cast iron pipe

Do not cut any other materials – **Risk of accident!**

Never use diamond abrasive wheels with side plating as they jam in the cut and can result in extreme kickback – **Risk of accident!**

### Product Codes

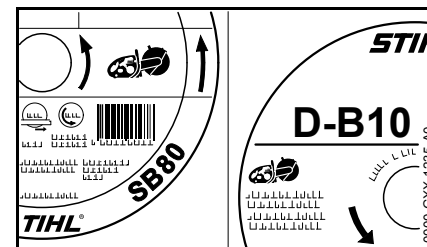

The product code is a combination of letters and numbers, consisting of up to four characters:

- the letters denote the main field of application of the abrasive wheel
- the numbers denote the performance class of the STIHL diamond abrasive wheel

### Axial and radial run-out

A faultless spindle bearing of the cut-off machine is necessary for a long service life and efficient functioning of the diamond abrasive wheel.

Using the abrasive wheel on a cut-off machine with a faulty spindle bearing can lead to deviations in radial and axial run-out.

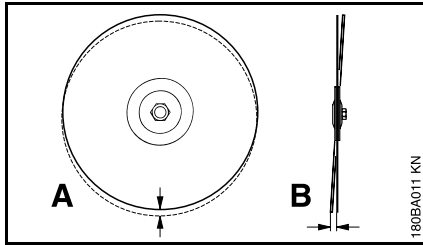

An excessively high radial run-out deviation (A) overloads individual diamond segments, which overheat in the process. This can lead to stress cracks in the parent wheel or to annealing of individual segments.

Deviations in axial run-out (B) result in higher thermal loading and wider cuts.

### Undercut

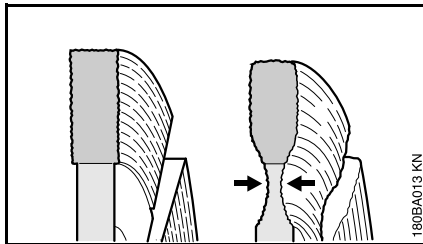

Do not cut into the base course (frequently chipped stones and gravel) when cutting roadway pavement – cutting in chipped stones and gravel is revealed by light-colored dust – excessive undercut may occur as a result – **Danger of shattering!**

### Built-up edges, sharpen

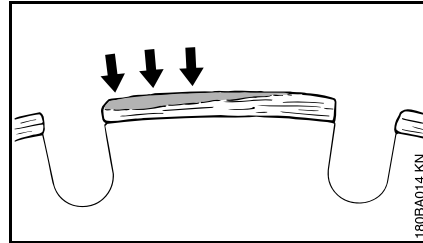

Built-up edges take the form of a light gray deposit on the tops of the diamond segments. This deposit on the segments clogs the diamonds and blunts the segments.

Built-up edges can form:

- when cutting extremely hard materials, e. g., granite
- with incorrect handling, e. g., excessive feed effort

Built-up edges increase vibration, reduce cutting performance, and cause formation of sparks.

At the first signs of built-up edges, immediately "sharpen" the diamond abrasive wheel – to do this, briefly cut through abrasive material such as sandstone, aerated concrete or asphalt.

Addition of water prevents the formation of built-up edges.

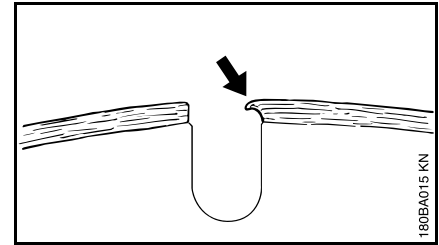

If work continues with dull segments, these may soften due to the high heat generated – the parent wheel is annealed and its strength is compromised – this can lead to stresses that are clearly recognizable by gyrations of the abrasive wheel. Do not continue to use the abrasive wheel – **Risk of accident!**

## Troubleshooting

---

### Abrasive wheel

Defects	Cause	Remedy
ragged edges or cut surfaces, crooked cut	Deviation in radial or axial run-out	Contact a servicing dealer <sup>1)</sup>
heavy wear on the sides of the segments	Abrasive wheel gyrates	use a new abrasive wheel
ragged edges, crooked cut, no cutting performance, generation of sparks	Abrasive wheel is dull; built-up edges with abrasive wheels for stone	Sharpen abrasive wheels for stone by briefly cutting through abrasive materials; replace abrasive wheel for asphalt with a new one
poor cutting performance, high segment wear	Abrasive wheel is turning in the wrong direction	Mount abrasive wheel so that it turns in the right direction
Breakdowns or tears in the parent wheel and segment	Overloading	use a new abrasive wheel
Undercut	Cutting in the wrong material	use new abrasive wheel; observe separating layers of various materials

1) STIHL recommends STIHL servicing dealers

## Abrasive wheel brake



This cut-off machine is fitted with the STIHL QuickStop cutting wheel brake.

When starting, the cutting wheel brake is engaged. After starting, the cutting wheel brake must be released.

The cutting wheel brake will be triggered if there is a sufficiently forceful kickback. When activated, the cutting wheel brake stops the abrasive cutting wheel within a fraction of a second.

## Checking function of the cutting wheel brake

Each time before starting work

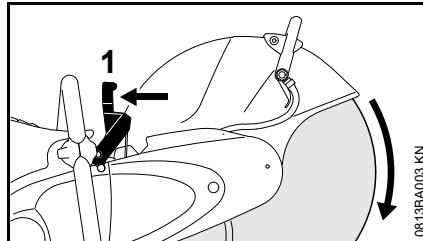

- Operate brake lever (1) in the direction of the handlebar and hold - the abrasive cutting wheel can be turned by hand.
- Release the brake lever (1) - the cutting wheel brake is engaged - the abrasive cutting wheel cannot be turned by hand.
- If the abrasive cutting wheel can be moved without operating the brake lever (1): Do not use the cut-off machine and consult your servicing dealer. Arrange for the cutting wheel brake to be repaired.

The brake lever must be free of dirt and easily movable.

## Releasing cutting wheel brake

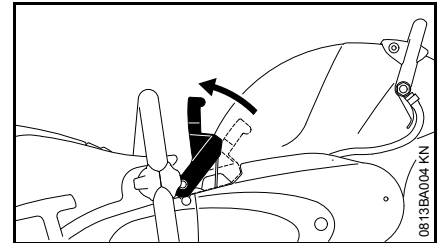

- When the engine is running, operate the brake lever in the direction of the handlebar and release - the cutting wheel brake is released



### NOTICE

The cutting wheel brake must be released before opening the throttle and before using the cut-off machine.

Increasing engine speeds with the cutting wheel brake engaged even for a short time results in damage to engine, clutch and cutting wheel brake.

### If the cutting wheel brake cannot be released with the engine running

The following causes are possible:

- Note regarding required maintenance for the cutting wheel brake
- Note regarding required repair for the cutting wheel brake

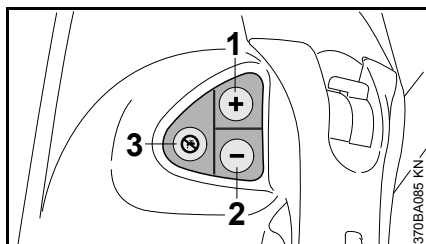

- Hold down button (3) on control panel for 3 seconds with the engine running
- Pull brake handle in the direction of the handlebar and release

**If this allows the cutting wheel brake to be released, the cutting wheel brake requires maintenance.**

- Carry on working and consult a STIHL servicing dealer after finishing the work
- Arrange for the required maintenance to be carried out on the cutting wheel brake

This procedure should be carried out afresh each time the engine is started. The number of such procedures is recorded in the control unit.

**If this still does not allow the cutting wheel brake to be released, the cutting wheel brake requires repair.**

- Stop work and consult a STIHL servicing dealer
- Arrange for the cutting wheel brake to be repaired

### Retensioning the front V belts

The V belts belong to the cutting wheel brake.

If the front V belt slips or squeals when accelerating or working, the front V belt is not tensioned correctly. The abrasive cutting wheel can remain stuck during cutting.

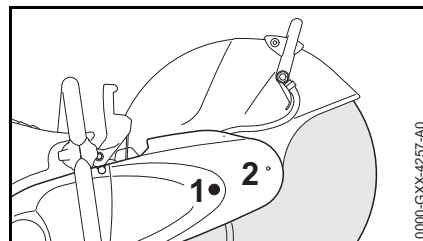

- Undo bolt (1)
- Remove guard (2)

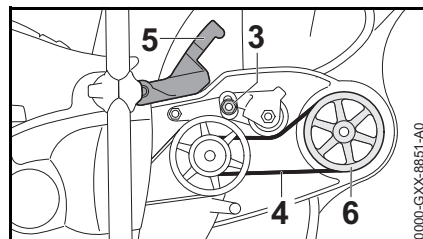

- Slacken nut (3). The front V belt (4) is tensioned
- Pull brake lever (5) in the direction of the handlebar and hold it there
- Turn the belt pulley (6) 3 turns. The tension is evenly distributed.
- Release the brake lever (5)
- Tighten nut (3) with a tightening torque of 20 Nm



To ensure correct function of the cutting wheel brake, the nut must be tightened with the specified torque. If it is not

possible to ensure that the nut can be tightened with the correct tightening torque, have the front V belt retensioned by a STIHL servicing dealer.

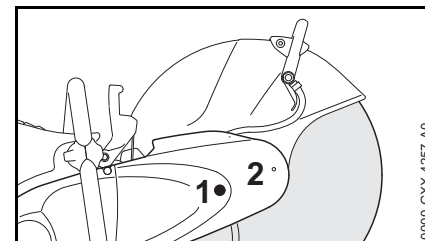

- Fit cover (2)
- Insert and tighten bolt (1)

If a V belt continues to slip or squeal when accelerating or working, a V belt may be worn. The abrasive cutting wheel can remain stuck during cutting, and the cutting wheel brake can no longer function correctly.

- Stop work and consult a STIHL servicing dealer
- Arrange for the cutting wheel brake to be repaired

### Maintain cutting wheel brake

The cutting wheel brake is subject to wear due to friction. In order for it to fulfill its function, it must be serviced and maintained periodically by trained personnel. STIHL recommends that maintenance and repair work be carried out only by authorized STIHL dealers.

- Note regarding necessary maintenance and required repair of the cutting wheel brake will be provided to the user when starting the engine and releasing the cutting

wheel brake, see section "Check function of the cutting wheel brake" and section "Releasing cutting wheel brake" in the chapter "Cutting wheel brake"

## Electronic Water Control

STIHL cut-off machines may be equipped with an electronic water control system.

The electronic water control system makes it possible to feed the optimum amount of water to the abrasive wheel. No water is fed to the abrasive wheel during idling.

### Before starting work

- Familiarize yourself with the sequence of motions while the engine is switched off

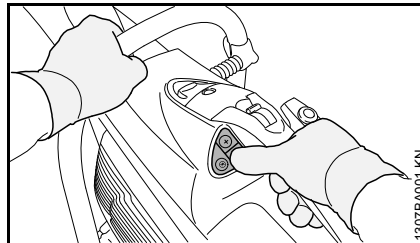

- All of the control panel buttons can be operated with the thumb of the right hand – the right hand always remains on the rear handle while doing so
- The left hand always remains on the handlebar

### Control panel

When the engine is running, you can activate/deactivate the electronic water control system and adjust the water flow.

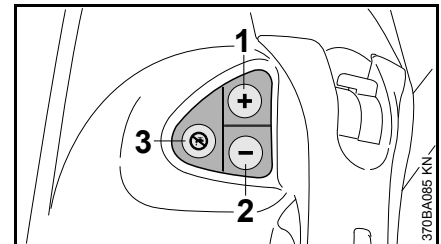

- 1 Button (+):  
activate the electronic water control or increase water flow to abrasive wheel
- 2 Button (-):  
activate the electronic water control or decrease water flow to abrasive wheel
- 3 Deactivate the electronic water control; no water is fed to the abrasive wheel

### Using the electronic water control

- Start the engine, see "Starting / Stopping the engine"
- Blip the (+) button or (-) button with the thumb of your right hand – the right hand always remains on the rear handle while doing so, the left hand always remains on the handlebar – no water is fed to the abrasive wheel yet during idling

During use, the set amount of water is fed to the abrasive wheel.

- Adjust water flow if necessary – to do so, blip the (+) button or (-) button with the thumb of your right hand until the correct water quantity is attained – the right hand always

remains on the rear handle while doing so, the left hand always remains on the handlebar

If the cut-off machine is idling after use, no more water will be fed to the abrasive wheel – the electronic water control, however, remains activated. On resuming use, the last quantity of water set will be fed to the abrasive wheel again automatically.

If the engine is stopped and restarted, the electronic water control is switched off.

### Maintenance and Care

If too little water or no water is fed to the abrasive wheel during use although the electronic water control has been activated:

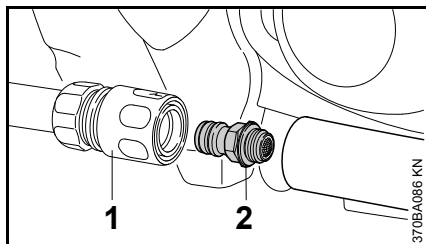

- Remove the coupling sleeve (1)
- Unscrew "water connection with screen" (2) and rinse under running water – the screen remains on the water connection

If too little water or no water is fed to the abrasive wheel even though the screen has been cleaned, contact your servicing dealer.

### Mounting an Abrasive Wheel

The engine must be switched off for fitting or replacement – set slide control to **STOP** or **0**.

#### Blocking the shaft

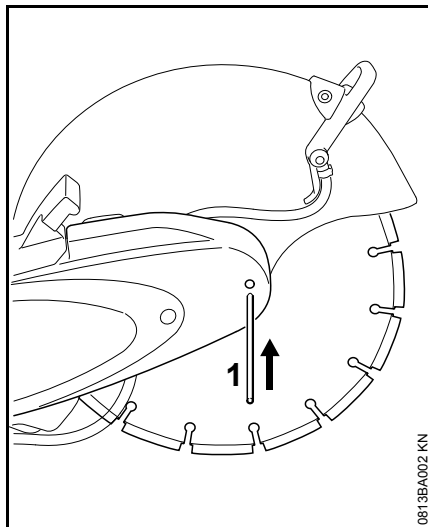

- Slide the locking pin (1) through the bore in the V-belt guard
- Actuate and hold the brake lever.
- Turn the shaft with the combination wrench until the locking pin (1) engages in the bore behind the guard
- Release brake lever

#### Removing the abrasive wheel

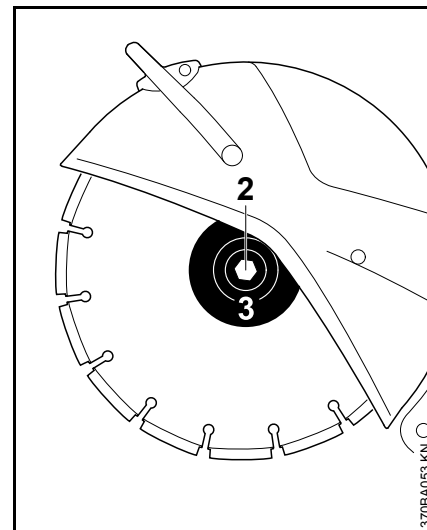

- Use the combination wrench to loosen and remove the hexagon head screw (2)
- Remove the front thrust washer (3) from the shaft together with the abrasive wheel

## Fitting the abrasive wheel

---

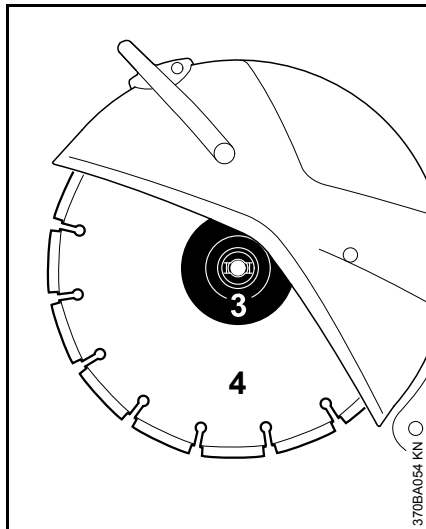

- Fit the new abrasive wheel (4)

### WARNING

Note the arrows indicating the direction of rotation on diamond abrasive wheels.

- Fit the front thrust washer (3). The catches of the front thrust washer (3) must engage in the shaft grooves.
- Screw in the hexagon bolt and **tighten it** with the combination wrench – if using a torque wrench, refer to the "Specifications" for the tightening torque
- Draw the locking pin out of the V-belt guard

### WARNING

Never use two abrasive wheels at the same time. The uneven wear creates a **risk of breaking and an injury hazard!**

## Fuel

Your engine requires a mixture of gasoline and engine oil.

### WARNING

For health reasons, avoid direct skin contact with gasoline and avoid inhaling gasoline vapor.

### STIHL MotoMix

---

STIHL recommends the use of STIHL MotoMix. This ready-to-use fuel mix contains no benzol or lead, has a high octane rating and ensures that you always use the right mix ratio.

STIHL MotoMix uses STIHL HP Ultra two-stroke engine oil for an extra long engine life.

MotoMix is not available in all markets.

### Mixing Fuel

---

### NOTICE

Unsuitable fuels or lubricants or mix ratios other than those specified may result in serious damage to the engine. Poor quality gasoline or engine oil may damage the engine, sealing rings, hoses and the fuel tank.

### Gasoline

Use only high-quality **brand-name** gasoline with a minimum octane rating of 90 – leaded or unleaded.



Gasoline with an ethanol content of more than 10% can cause running problems in engines with a manually adjustable carburetor and should not be used in such engines.

Engines equipped with M-Tronic deliver full power when run on gasoline with an ethanol content of up to 25% (E25).

### Engine Oil

If you mix the fuel yourself, use only STIHL two-stroke engine oil or another high-performance engine oil in accordance with JASO FB, JASO FC, JASO FD, ISO-L-EGB, ISO-L-EGC or ISO-L-EGD.

STIHL specifies STIHL HP Ultra two-stroke engine oil or an equivalent high-performance engine oil in order to maintain emission limits over the machine's service life.

### Mix Ratio

STIHL 50:1 two-stroke engine oil: 50 parts gasoline to 1 part oil

### Examples

Gasoline Liters	STIHL engine oil 50:1 Liters (ml)	
1	0.02	(20)
5	0.10	(100)
10	0.20	(200)
15	0.30	(300)
20	0.40	(400)
25	0.50	(500)

- Use a canister approved for storing fuel. Pour oil into canister first, then add gasoline and mix thoroughly.

### Storing Fuel

Store fuel only in approved safety-type fuel canisters in a dry, cool and safe location protected from light and the sun.

**Fuel mix ages** – only mix sufficient fuel for a few weeks work. Do not store fuel mix for longer than 30 days. Exposure to light, the sun, low or high temperatures can quickly make the fuel mix unusable.

STIHL MotoMix may be stored for up to 2 years without any problems.

- Thoroughly shake the mixture in the canister before fueling your machine.

### WARNING

Pressure may build up in the canister – open it carefully.

- Clean the fuel tank and canister from time to time.

Dispose of remaining fuel and cleaning fluid properly in accordance with local regulations and environmental requirements.

## Fueling



### Preparing the machine

- Before fueling, clean the filler cap and the area around it so that dirt cannot fall into the tank
- Always position the machine so that the filler cap is facing upwards

### WARNING

Never use a tool to open the bayonet filler cap. The cap can be damaged and fuel may escape.

### Opening the twist lock

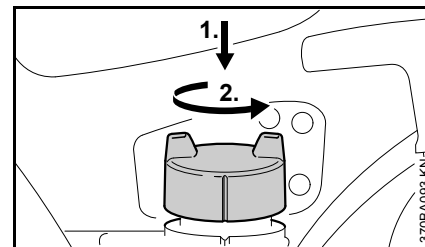

- Press the filler cap down as far as possible by hand, then turn it counterclockwise (approx. 1/8 turn) and remove

## Refueling

Take care not to spill fuel while fueling and do not overfill the tank. STIHL recommends use of the STIHL filling system for fuel (special accessory).

### Closing the filler cap

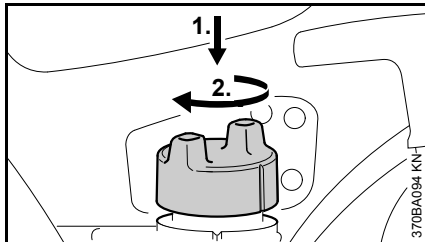

- Fit the cap and turn it until it engages in the bayonet catch
- Press the cap down as far as possible with your hand and turn it clockwise (approx. 1/8 of a turn) until it engages properly

### Checking the lock

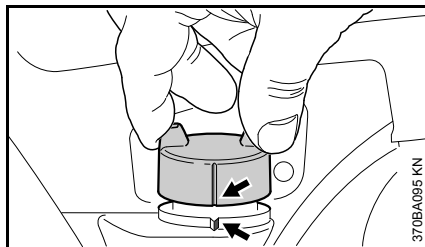

- Grip the cap – the cap is closed properly if it cannot be removed and the markings (arrows) on the cap and fuel tank are aligned

If the cap can be removed or the markings do not align, close the cap again – see sections "Closing the cap" and "Checking the lock".

### Changing the fuel pickup body every year

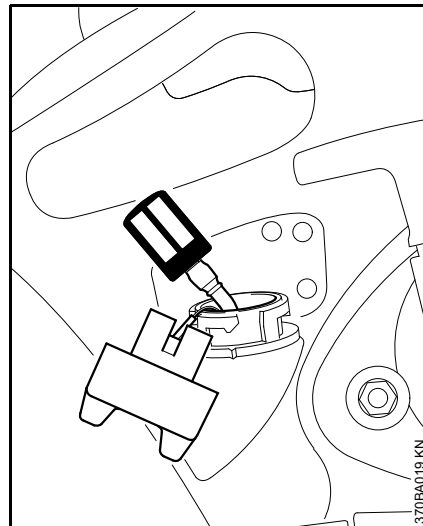

- Drain the fuel tank
- Pull the fuel pickup body out of the tank with a hook and disconnect it from the hose
- Connect a new fuel pickup body to the hose
- Return the fuel pickup body to the tank

## Starting / Stopping the Engine

### Checking the correct operation of the abrasive wheel brake

#### Each time before starting work

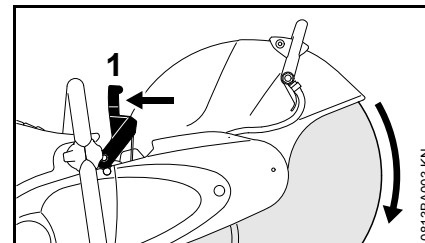

- Pull up brake lever (1) toward handlebar and hold it there – it should be possible to turn the abrasive wheel by hand
- Release brake lever (1) – the abrasive wheel brake is engaged – the abrasive wheel cannot be turned by hand
- If the abrasive wheel can be turned without operating the brake lever (1): Do not use the cut-off machine. Consult a STIHL servicing dealer. Have the abrasive wheel brake repaired.

The brake lever must be free of dirt and easily movable.

## Starting the engine

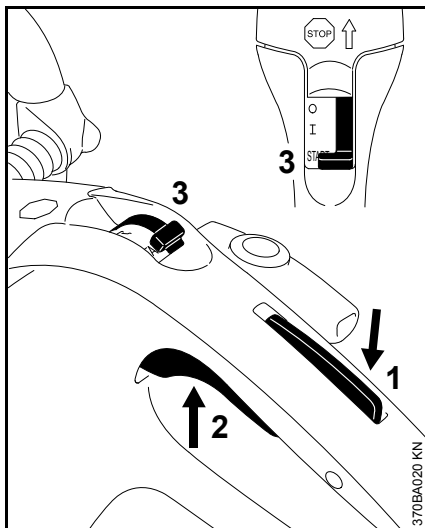

- Press throttle trigger lockout (1) and throttle trigger (2) simultaneously
- Hold both triggers down
- Set the slide control (3) to **START** and hold it there
- Release the throttle trigger, slide control and throttle trigger lockout in succession – **starting throttle position**

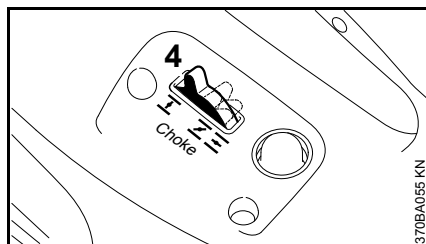

- Set the choke lever (4) according to the engine temperature

⏏ if engine is cold

⏏ if engine is **warm** (even if the engine is already running but is still cold or if the warm engine was shut off for less than 5 min)

⏏ if engine is **hot** (if the hot engine was switched off for longer than 5 min)

## Versions with decompression valve

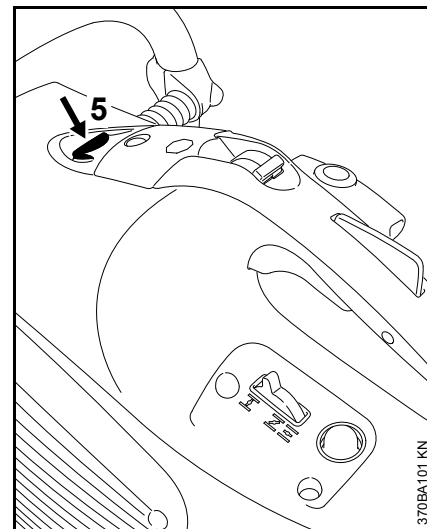

- Press the button (5) of the decompression valve before each starting procedure

**For all versions**

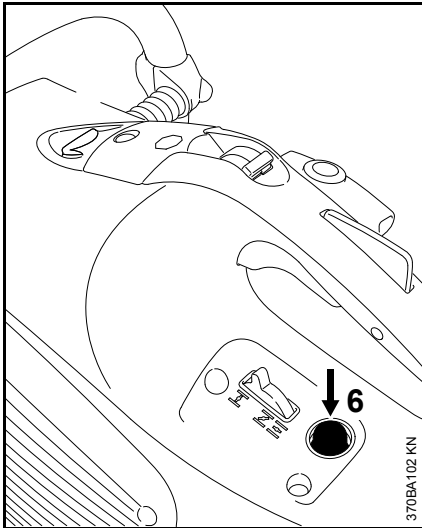

- Press the bulb (6) of the manual fuel pump 7-10 times – even if the bulb is still filled with fuel

**Starting**

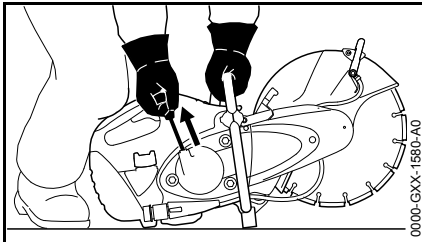

- Place the cut-off machine carefully on the ground, ensuring that the cutting wheel cannot touch the

ground or any objects. There must not be anyone within the swivel range of the cut-off machine

- Make sure you have a firm footing
- Press the cut-off machine firmly against the ground, holding the handle with your left hand, thumb wrapped round the handle
- Press the cut-off machine against the ground with your right knee on the shroud
- Pull the starter grip slowly with your right hand until you feel it engage – then give it a brisk strong pull – do not pull out the starter rope all the way

 **NOTICE**

Do not let the starter grip snap back – **danger of breakage!** Guide it back into the housing in the opposite direction so that it can rewind properly.

**When the engine has turned over for the first time**

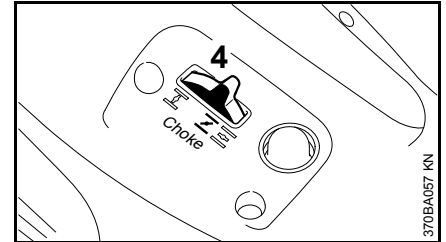

- Set choke lever (4) to  position
- Press the button of the decompression valve (depending on version)
- continue cranking

**Once the engine is running**

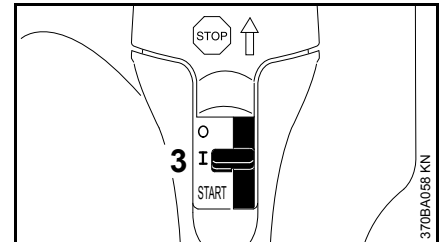

- Blip the throttle trigger – slide control (3) returns to the normal position **I** – the engine idles
- Set choke lever to  position

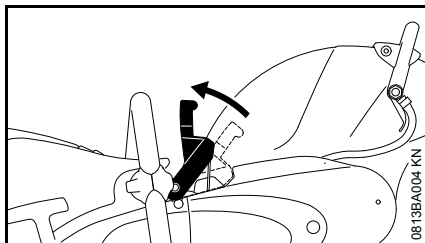

- Move brake lever toward handlebar and release – the abrasive wheel brake is released

If the carburetor has been set correctly, the cutting wheel should not rotate when the engine is idling.

The cut-off machine is now ready for use.



The abrasive wheel brake must be released before opening the throttle and before cutting.

Increasing the engine speed with the abrasive wheel brake engaged will cause damage to the engine, clutch and abrasive wheel brake, even after only a short time.

#### **If the abrasive wheel brake cannot be released with the engine running**

The following causes are possible:

- Indication that the abrasive wheel brake needs servicing
- Indication that the abrasive wheel brake needs repair

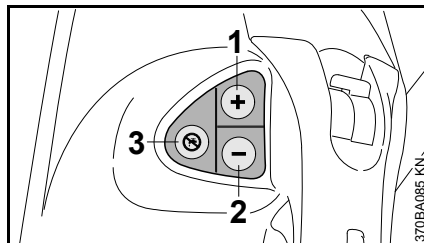

- Hold down button (3) on control panel for 3 seconds with the engine running
- Pull brake handle in the direction of the handlebar and release

#### **If that releases the abrasive wheel brake, the abrasive wheel brake needs servicing.**

- Carry on working and consult a STIHL servicing dealer after finishing the work
- Have the necessary servicing of the abrasive wheel brake carried out

This procedure should be carried out afresh each time the engine is started. The number of such procedures is recorded in the controller.

#### **If the abrasive wheel brake still cannot be released, the abrasive wheel brake needs repair.**

- Stop work and consult a STIHL servicing dealer
- Have the abrasive wheel brake repaired

#### **Switch off the engine**

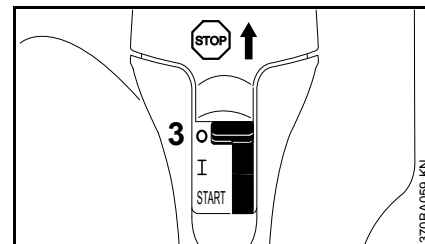

- Set the slide control (3) to **STOP** or **0**

#### **Additional hints on starting**

##### **If the engine does not start**

The choke lever was not returned to  in time after the engine turned over for the first time.

- Set slide control to **START = starting throttle position**
- Set choke lever to  = set warm start – even if the engine is cold
- Pull the starter rope through 10-20 times to ventilate the combustion chamber
- Restart the engine

##### **If the tank has been drained completely**

- Refueling
- Press the manual fuel pump bulb 7-10 times – even if it is full of fuel
- Set the choke lever in accordance with the engine temperature
- Restart the engine

## Air Filter System

### Basic information

**The average filter life is more than 1 year. Do not dismantle the filter cover or fit a new air filter unless there is a noticeable loss of engine power.**

In the long-life air filter system with the cyclone pre-separation system, dirty air is drawn in and deliberately rotated. The larger and heavier particles carried in the air are thus expelled and extracted. Only pre-cleaned air enters the air filter system and the result is extremely long filter life.

### Replacing the air filter

**Only if there is a noticeable loss of engine power**

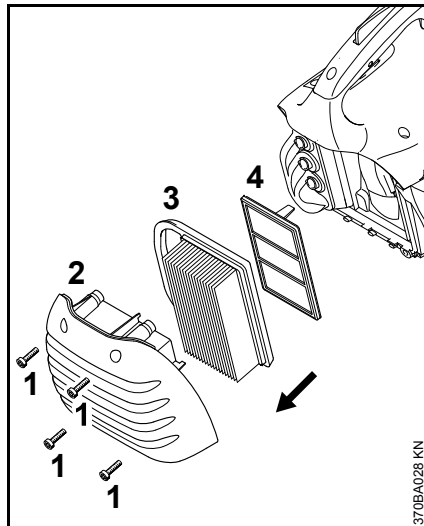

- Choke lever to  $\text{I}$
- Undo the screws (1).
- Remove the filter cover (2) and clean it
- Remove the main filter (3)
- Remove the auxiliary filter (4) – ensuring that dirt does not enter the intake area
- Clean the filter area
- insert new auxiliary filter and new main filter
- Refit the filter cover
- Tighten down the screws

Only high-quality air filters should be used, to protect the engine against ingress of abrasive dust.

STIHL recommends the use of genuine STIHL air filters. The high quality of these parts will ensure troublefree operation, a long service life for the engine and extremely long filter life.

## Adjusting the Carburetor

### Basic information

The ignition system of this cut-off machine is equipped with an electronic speed limiter. The maximum speed cannot be increased beyond a specified limit.

The carburetor is equipped with a factory-installed standard setting.

The carburetor has been adjusted for optimum performance and fuel efficiency in all operating states.

### Preparing the machine

- Switch off engine
- Check the air filter – clean or replace it if necessary
- Check the spark arresting screen in the muffler – clean or replace it if necessary

### Standard setting

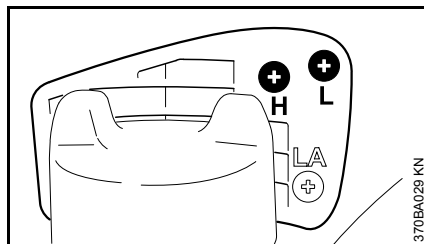

- Turn the high speed adjusting screw (H) counterclockwise as far as possible – max. 3/4 turn
- Turn the low speed adjusting screw (L) clockwise as far as possible – then turn it 3/4 turn counterclockwise

### Setting the idle speed

- Carry out the standard setting
- Start engine and let it warm up

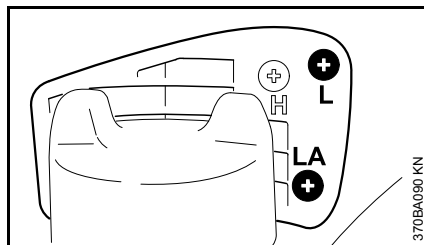

### Engine stops when idling

- Turn the idle speed adjusting screw (LA) clockwise until the abrasive cutting wheel begins to turn – then turn it back 1 turn

### Abrasive cutting wheel rotates when idling

- Turn the idle speed adjusting screw (LA) counterclockwise until the abrasive cutting wheel stops rotating – then give the screw another full turn in the same direction

### **!** WARNING

If the abrasive cutting wheel continues to rotate in idle even after adjustment, have the cut-off machine checked by a servicing dealer.

### Speed erratic when idling; poor acceleration (despite adjustment to LA setting)

The idle setting is too lean.

- Turn the low speed adjusting screw (L) approx. 1/4 turn counterclockwise until the engine runs and accelerates smoothly – max. up to the stop

### Idle speed cannot be increased sufficiently via the idle speed adjusting screw (LA), engine stops when changing from part-load to idle speed

The idle setting is too rich.

- Turn low speed adjusting screw (L) approx. 1/4 turn clockwise

Whenever the low speed adjusting screw (L) has been adjusted, it is usually also necessary to readjust the idle speed adjusting screw (LA).

## Correcting the carburetor setting for use at high altitudes

The setting may have to be marginally corrected if engine performance is unsatisfactory at high altitudes:

- Carry out the standard setting
- Allow engine to warm up
- Turn the high speed adjusting screw (H) slightly clockwise (leaner) – max. up to the stop

### NOTICE

After descending from a high altitude, restore the carburetor setting to the standard setting.

If you make the setting too lean it will increase the risk of engine damage through lack of lubrication and overheating.

## Spark Arresting Screen in Muffler

- If engine performance deteriorates, check the spark arresting screen in the muffler.

### WARNING

Wait until engine has cooled completely before performing the following operations.

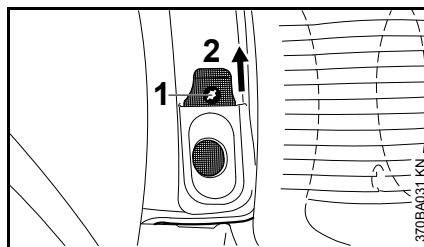

- Remove screw (1)
- Pull the spark arresting screen (2) upward out of the muffler
- Clean the soiled spark arresting screen
- If the screen is damaged or heavily carbonized, fit a new one
- Refit the spark arresting screen in reverse order of steps

## Spark Plug

- If the engine is down on power, difficult to start or runs poorly at idle speed, first check the spark plug.
- Fit a new spark plug after about 100 operating hours – or sooner if the electrodes are badly eroded. Install only suppressed spark plugs of the type approved by STIHL – see "Specifications".

### Removing the spark plug

- Switch off the engine – move stop switch to **STOP** or **0**

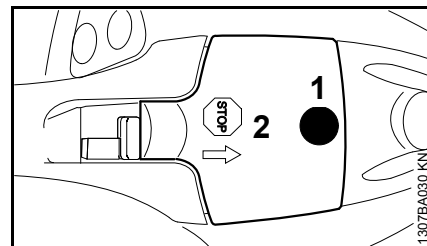

- Unscrew screw (1) and remove cap (2) – screw (1) is secured in the cap (2) to prevent loss

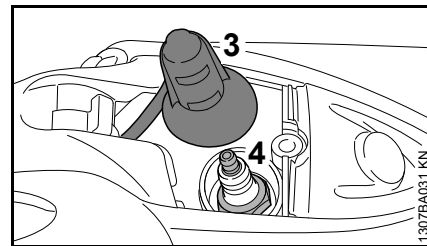

- Remove the spark plug boot (3).
- Unscrew the spark plug (4).



## Checking the Spark Plug

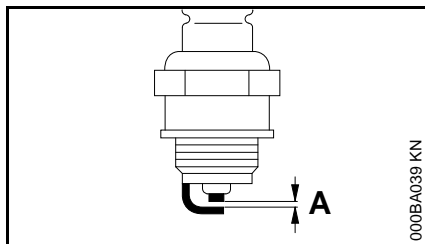

- Clean dirty spark plug.
- Check electrode gap (A) and readjust if necessary – see "Specifications".
- Rectify the problems which have caused fouling of the spark plug.

Possible causes are:

- Too much oil in fuel mix.
- Dirty air filter.
- Unfavorable running conditions.

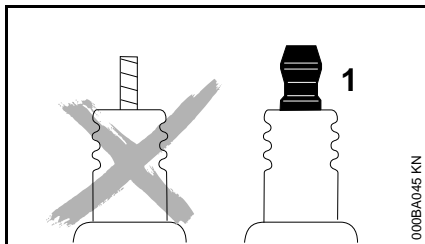

### WARNING

Arcing may occur if the adapter nut (1) is loose or missing. Working in an easily combustible or explosive atmosphere may cause a fire or an explosion. This can result result in serious injuries or damage to property.

- Use resistor type spark plugs with a properly tightened adapter nut.

## Installing the spark plug

- Fit the spark plug by hand and screw it in
- Tighten spark plug with combination wrench
- Press the spark plug boot firmly onto the spark plug
- Position the cap for the spark plug boot and screw it down

## Storing the Machine

If the machine is to remain out of use for approx. 3 months or more

- Drain and clean the fuel tank in a well ventilated place
- Dispose of fuel in accordance with the regulations and having regard for the environment
- Run the engine until the carburetor is dry, this helps to prevent the carburetor diaphragms sticking together
- Remove the abrasive wheel
- Thoroughly clean the machine
- Store machine in a safe and dry place. Protect against unauthorized use (e. g., by children)

## Maintenance and Care

The information applies in normal operating conditions. The specified intervals must be shortened accordingly when working for longer than normal or under difficult cutting conditions (extensive dust, etc.).		Before starting work	At the end of work and/or daily	Whenever tank is refilled	Weekly	Monthly	Yearly	If faulty	If damaged	As required
Complete machine	Visual inspection (condition, leaks)	X		X						
	Clean		X							
Controls	Check operation	X		X						
Cutting wheel brake, multi-rib belt	Check operation	X								
	Have them repaired by a specialist dealer <sup>1)</sup>							X		
Manual fuel pump (if present)	Inspect	X								
	Have it repaired by a specialist dealer <sup>1)</sup>								X	
Fuel pickup body in fuel tank	Inspect							X		
	Replace						X		X	X
Fuel tank	Clean					X				
Air filter (all filter components)	Replace	<b>Only if there is a noticeable loss of engine power</b>								
Cooling air intake slits	Clean		X							
Cylinder fins	Have them cleaned by a specialist dealer <sup>1)</sup>						X			
Spark arresting screen in muffler	Inspect		X							
	Clean or replace									X
Water connection	Inspect	X						X		
	Have it repaired by a specialist dealer <sup>1)</sup>								X	
Carburetor	Check idle adjustment – abrasive cutting wheel must not rotate	X		X						
	Readjust idle speed									X
Spark plug	Adjust electrode gap							X		
	Replace after 100 hours' operation									

The information applies in normal operating conditions. The specified intervals must be shortened accordingly when working for longer than normal or under difficult cutting conditions (extensive dust, etc.).		Before starting work	At the end of work and/or daily	Whenever tank is refilled	Weekly	Monthly	Yearly	If faulty	If damaged	As required
All accessible screws, nuts and bolts (not adjusting screws)	Tighten		X							X
Antivibration elements	Inspect	X						X		X
	Have them replaced by a servicing dealer <sup>1)</sup>								X	
Abrasive cutting wheel	Inspect	X		X						
	Replace								X	X
Supports/rubber buffers (underneath the machine)	Inspect		X							
	Replace								X	X
Safety information label	Replace								X	

<sup>1)</sup> STIHL recommends the STIHL servicing dealer

## Main Parts

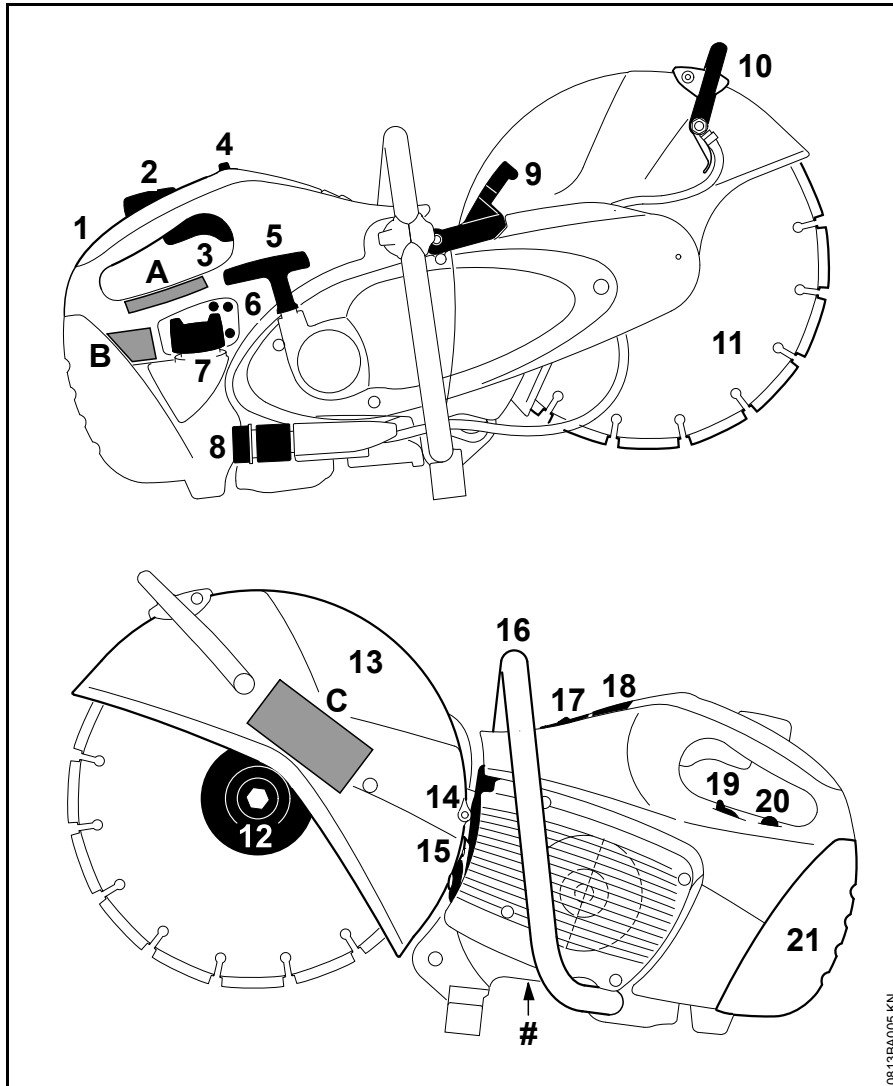

- 1 Rear handle
- 2 Throttle trigger lockout
- 3 Throttle trigger
- 4 Slide control
- 5 Starter grip
- 6 Carburetor adjusting screws
- 7 Filler cap
- 8 Water connection
- 9 Brake lever
- 10 Adjusting lever
- 11 Abrasive cutting wheel
- 12 Front thrust washer
- 13 Guard
- 14 Muffler
- 15 Spark arresting screen
- 16 Handlebar
- 17 Decompression valve
- 18 Cap for spark plug boot
- 19 Choke shutter lever
- 20 Manual fuel pump
- 21 Filter cover
- # Machine no.
- A Safety information label
- B Safety information label
- C Safety information label

0513BA005 KN

## Specifications

### Engine

STIHL single-cylinder two-stroke engine

Displacement:	66.7 cc
Cylinder bore:	50 mm
Piston stroke:	34 mm
Engine power according to ISO 7293:	3.2 kW (4.4 HP) at 9000 rpm
Idle speed:	2700 rpm
Max. spindle speed to ISO 19432:	2525 rpm

### Ignition system

Electronic magneto ignition

Spark plug (suppressed):	Bosch WSR 6 F
Electrode gap:	0.5 mm

### Fuel system

All-position diaphragm carburetor with integral fuel pump

Fuel tank capacity:	710 cc (0.71 l)
---------------------	-----------------

### Air filter

Main filter (paper filter) and flocked wire mesh auxiliary filter

### Weight

Without fuel, without abrasive cutting wheel, with electronic water control:  
11.1 kg

### Abrasive cutting wheels

The specified maximum permitted operating speed of the abrasive cutting wheel must be greater than or equal to the maximum spindle speed of the cut-off machine used.

Outside diameter:	350 mm
Max. thickness:	4.8 mm
Bore diameter/spindle diameter:	20 mm
Tightening torque:	30 Nm

### Composite resin abrasive cutting wheels

Minimum outside diameter of thrust washers: <sup>1) 2)</sup>	103 mm
Maximum cutting depth: <sup>3)</sup>	125 mm

- 1) For Japan 118 mm
- 2) For Australia 118 mm
- 3) When using thrust washers with an outside diameter of 118 mm, the maximum cutting depth is reduced to 116 mm

### Diamond abrasive cutting wheels

Minimum outside diameter of thrust washers: <sup>1)</sup>	103 mm
Maximum cutting depth: <sup>3)</sup>	125 mm

- 1) For Japan 118 mm
- 3) When using thrust washers with an outside diameter of 118 mm, the maximum cutting depth is reduced to 116 mm

### Sound and vibration levels

For further details concerning compliance with the Employers' Directive on Vibration 2002/44/EC, see [www.stihl.com/vib](http://www.stihl.com/vib)

#### Sound pressure level $L_{peq}$ to DIN EN ISO 19432

98 dB(A)

#### Sound power level $L_w$ to DIN EN ISO 19432

109 dB(A)

#### Vibration level $a_{hv,eq}$ to DIN EN ISO 19432

Left handle:	3.6 m/s <sup>2</sup>
Right handle:	3.9 m/s <sup>2</sup>

The K-factor in accordance with Directive 2006/42/EC is 2.0 dB(A) for the sound pressure level and sound power level; the K-factor in accordance with Directive 2006/42/EC is 2.0 m/s<sup>2</sup> for the vibration level.

## REACH

---

REACH is an EC regulation and stands for the Registration, Evaluation, Authorisation and Restriction of Chemical substances.

For information on compliance with the REACH regulation (EC) No. 1907/2006 see [www.stihl.com/reach](http://www.stihl.com/reach).

## Exhaust Emissions

---

The CO<sub>2</sub> value measured in the EU type approval procedure is specified at [www.stihl.com/co2](http://www.stihl.com/co2).

The measured CO<sub>2</sub> value was determined on a representative engine in accordance with a standardized test procedure under laboratory conditions and does not represent either an explicit or implied guarantee of the performance of a specific engine.

The applicable exhaust emission requirements are fulfilled by the intended usage and maintenance described in this instruction manual. The type approval expires if the engine is modified in any way.

## Maintenance and Repairs

Users of this machine may only carry out the maintenance and service work described in this user manual. All other repairs must be carried out by a servicing dealer.

STIHL recommends that you have servicing and repair work carried out exclusively by an authorized STIHL servicing dealer. STIHL dealers are regularly given the opportunity to attend training courses and are supplied with the necessary technical information.

When repairing the machine, only use replacement parts which have been approved by STIHL for this power tool or are technically identical. Only use high-quality replacement parts in order to avoid the risk of accidents and damage to the machine.

STIHL recommends the use of original STIHL replacement parts.

Original STIHL parts can be identified by the STIHL part number, the **STIHL** logo and the STIHL parts symbol  (the symbol may appear alone on small parts).

## Disposal

Observe all country-specific waste disposal rules and regulations.

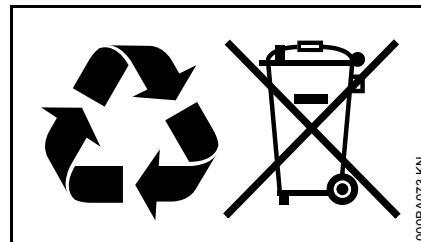

STIHL products must not be thrown in the garbage can. Take the product, accessories and packaging to an approved disposal site for environment-friendly recycling.

Contact your STIHL servicing dealer for the latest information on waste disposal.

## EC Declaration of Conformity

ANDREAS STIHL AG & Co. KG

Badstr. 115

D-71336 Waiblingen

declare under our sole responsibility that

Type: Cut-off machine

Make: STIHL

Model: TS 440

Serial identification  
number: 4238

Displacement: 66.7 cm<sup>3</sup>

conforms to the specifications of Directives 2011/65/EU, 2006/42/EC, 2014/30/EC and 2000/14/EC and has been developed and built in compliance with the versions of the following standards valid at the time of the production date:

EN ISO 19432, EN 55012,  
EN 61000-6-1

The measured and guaranteed sound power level has been determined in accordance with Directive 2000/14/EC, Annex V, and standard ISO 3744.

### Measured sound power level

113 dB(A)

### Guaranteed sound power level

115 dB(A)

The technical documentation has been retained by:

ANDREAS STIHL AG & Co. KG  
Produktzulassung

The year of construction and the serial number are shown on the machine.

Waiblingen, December 3, 2018

ANDREAS STIHL AG & Co. KG

pp



Thomas Elsner

Head of Product Management and  
Services



0458-520-8321-A

AUS



[www.stihl.com](http://www.stihl.com)



0458-520-8321-A