

**ACCENTRA**

**ASSA ABLOY**

Experience a safer  
and more open world

# 51 Series

## Door Closer



**ACCENTRA**

**ASSA ABLOY**

ASSA ABLOY is transitioning the Yale Commercial brand to ACCENTRA. This affects only the brand name; the products and product numbers will remain unchanged. Prior to May 20, 2024, products may be shipped either as Yale Commercial brand or ACCENTRA brand. Products shipping after May 20, 2024, will be branded ACCENTRA.

## CONTENTS

Features & Benefits . . . . .	3
Fasteners . . . . .	4
Features. . . . .	5
Finishes . . . . .	6
How To Order . . . . .	7
Applications . . . . .	8
Technical Details. . . . .	9-11
Accessories. . . . .	12-16
Parts List . . . . .	17-18
Sample Specification . . . . .	19

### 51 Series Door Closer

The ASSA ABLOY ACCENTRA™ 51 Series Closer is designed to fit almost any application and is the choice of engineers worldwide. It is ideal for use with aluminum storefront doors and frames, yet it also complements wood or metal door installations. Non-handed, the 51 Series is available as multi-sized units and offers tri-packed packaging on standard non-hold open and hold open closers. This UL listed, Grade 1 closer has a proven history of quality and tradition. With a variety of plates, brackets, precise valve adjustment and a complete range of arms, this closer can be used on retail stores, warehouses, restaurants, garages, or manufacturing and utility buildings.

## FEATURES & BENEFITS



### Features



- Exceeds 25 million cycles
- Non-handed
- Tri-packed (regular arm, top jamb and parallel arm mounting)
- Rack & pinion design
- Door weight 250 lbs.
- Cast aluminium body
- 1-3/8" (35mm) diameter piston
- 5/8" (16mm) diameter pinion journals
- Standard, separate and independent, latch, sweep and backcheck intensity valves
- 2-7/8" (73mm) projection
- All standard arm applications allow doors to swing 180 degrees, conditions permitting
- 30-year limited warranty
- Staked valves

### Benefits

- **Reliable:** High strength aluminum alloy closer body provides for long life; independent latch, sweep and backcheck intensity valves ensure positive control
- **Cost of Ownership:** Exceeds 25 million cycles; 30-year limited warranty
- **Flexible:** Adjustable 1-6 spring makes installation selection easier and reduces inventory for customers; non-handed for installation on right- or left-hand swing doors

## OVERVIEW

### Compliance Standards

- ANSI/BHMA A156.4, Grade 1 certified 
- UL / cUL listed for use on fire rated doors 
- UL10C listed for positive pressure fire test
- Manufactured in an ISO 9001 and ISO 14001 certified facility
- The 51 Series door closer is are designed to comply with requirements for the Americans with Disabilities Act  (A.D.A) and ANSI standard A117.1

#### **CAUTION: Door Closers for Low Opening Force Applications:**

Door closers installed in openings required to meet the requirements of the Americans With Disabilities Act or ANSI/ BHMA Standard A117.1, when adjusted to meet those requirements, may not provide adequate closing power to dependably close and latch the door based on opening or site conditions.

### Fasteners

Type	Description	Arm		
		RA	PA	TJ
<b>DOOR</b>				
SDST	Self drilling self tapping	S	S	S
MS	Machine screw	S	S	S
SN	Sleeve nut	O	O	O
TBGN	Thru bolts & grommet nuts	O	O	O
SMS	Sheet metal screws (wood)	O	O	O
<b>FRAME</b>				
SDST	Self drilling self tapping	S	S	S
MS	Machine screw	S	S	S
SMS	Sheet metal screws (wood)	O	O	O

**S = standard; O = optional**

**SN** are for use on unreinforced hollow metal doors or to prevent any hollow metal door from collapse/dimpling. They can also be used for thru bolting on wood doors. SN are supplied for 1-3/4" (44mm) thick doors unless specified for 2-1/4" (57mm) thick doors.

**TBGN** are an alternative to SN for wood doors. TBGN are supplied standard for 1-3/4" (44mm) thick doors. They can be specified for 1-3/8" (35mm) thick doors.

**SMS**, when specified, closer will be packed with sheet metal screws for the door **AND** sheet metal screws plus machine screws for the frame.

## FEATURES

### Standard Features

#### Aluminum Alloy Housing

Closer bodies are constructed of a special aluminum alloy, carefully selected to accommodate interaction with steel components and operating conditions.

#### Rack & Pinion Operation

Provides a smooth constant control of the door through its full opening and closing cycle. 180° door swing can be achieved when door, frame, hardware and arm function do not limit door swing.

#### Non-handed

With few exceptions all series 51 door closers are non-handed and can be installed on either right- or left-hand swing doors. Pinion shaft extends vertically through the closer body in both directions.

#### Tri-packed

The 51 Series comes with screws, brackets & soffit plate to allow for regular, top jamb, & parallel arm installations.

#### Sweep Speed Control Valve

Allows adjustment of door's speed from the door's full open position down to approximately 10° from the closed position.

#### Latch Speed Control Value

Allows adjustment of door speed from approximately 10° down to the door's fully closed position.

### Optional Features

#### Optional Molded Cover

Molded of high impact U.L. listed material that covers the entire closer body assembly. This cover is non-handed for regular and parallel arm applications. Suffix "P" to catalog number. Not designed for top jamb applications.



#### Adjustable Backcheck Cushion Valve

Provides control of the door in the opening cycle, beginning at approximately 75° of door opening. It slows/cushions the door opening, when the door is forcibly opened beyond its pre-adjusted opening speed limits.

#### Closer Fluid

All door closers are supplied with a temperature stable, multi-viscosity fluid. This fluid will permit the door closer to perform within a wide temperature range: from very high to as low as -40°F.

#### Warranty

These closers carry a limited 30-year warranty against defects and a limited lifetime warranty on the aluminum housing.

### Door Closer Power Options

#### 51 Series Multi-Sized Door Closer

Fully adjustable through the power range of sizes 1 through 6, as outlined in ANSI/BHMA specification A156.4. Also, complies with the opening force requirements as outlined in the Americans with Disabilities Act (A.D.A.) and ANSI A117.1 for interior doors.

### Optional Features - Arms

#### Non-Hold Open















Self-closes door every time door is opened. Auxiliary stop (by others) required.

#### Hold Open

Achieved by means of friction or ball and detent/roller. Friction hold open has a range of 90° to 180° using template location and mechanical adjustment. Ball and detent or roller hold open is effective in a range of 85° to 110°.

Door closers with a hold open arm are not permitted to be used on fire door assemblies.

**FINISHES**

ANSI/BHMA Code Finish Description			
600* Primed for Painting	605^ Bright Brass, Clear Coated	606^ Satin Brass, Clear Coated	611^ Bright Bronze, Clear Coated
			
612^ Satin Bronze, Clear Coated	613E^ Dark Oxidized Satin Bronze - equivalent	625^ Bright Chrome Plated	626^ Satin Chrome Plated
			
689 Aluminum Painted	690 Dark Bronze Painted	691 Light Bronze Painted	693 Black Painted
			
694 Medium Bronze Painted	696 Satin Brass Painted	BSP Black Suede Powder Coat	WSP White Suede Powder Coat
			

\*600 is a special rust-inhibiting prime coat. Closers can be ordered prime coat only (specify closer x 600). An additional charge applies if finish coat is required over prime coat (ex: 51 x 600 x 689).

^ Available on arms only.

**HOW TO ORDER**

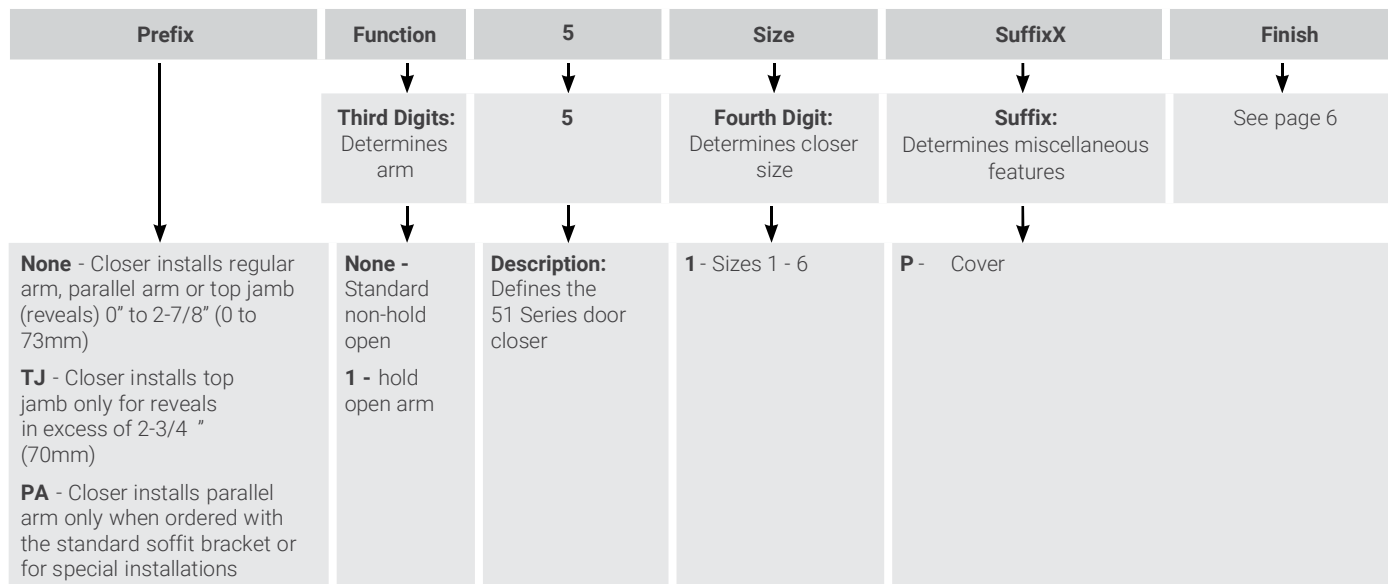

**Notes:**

- Before installing a door closer, verify the accessibility, fire, and life-safety requirements that are in effect. This includes the mounting height and projection into the clear opening. Check the adopted state and local building codes and consult the Authority Having Jurisdiction (AHJ).
- To maintain the warranty and ensure proper operation of the product, follow the installation instructions & templates and install on the inside of the building.
- Consult NFPA 80 for the hinge requirements on a fire door.
- Failure to use fasteners supplied with closer may void factory warranty.
- Optional fasteners are available for a variety of applications. Consult the door and frame manufacturer to ensure the proper fasteners are used to maintain certifications.
- Sizing charts are based on 1-3/4" x 7' standard weight doors swinging to 110°. Other application conditions (i.e. larger door heights or weight) may require larger size closer. Adjusting the spring power to meet the low opening force requirements of the Americans With Disabilities Act or ANSI/BHMA Standard A117.1, may not provide adequate closing power to dependably close and latch the door in some conditions (i.e. air movement from wind gusts or building stack pressure).

## APPLICATIONS



### Regular Arm

This is the only pull-side application where a double lever arm is used. It is the most power-efficient application for a door closer. Sufficient frame, door and/or ceiling clearance must be considered. Since the arm assembly projects directly out from the frame, this application may present an aesthetics issue or be prone to vandalism.



### Top Jamb

For efficiency reasons this application provides the best alternative to the regular arm application. There must be sufficient frame face and/or ceiling clearance for this application. It requires a top rail on the door of just 2-1/8" (54mm). This application provides the best door control for doors in exterior walls that swing out of a building. The entire door closer and arm assembly project from the frame, similar to the regular arm application, where the matters of appearance and malicious abuse can be of concern. Consideration must be given to depth of the frame reveal.



### Parallel Arm

This application provides the most appealing design appearance for a surface-mounted door closer having a double lever arm. This may also be beneficial in vandalism-prone areas. It is on the push side of the door and the arm assembly extends almost parallel to the door. In the closed position, there is very little or no hardware projecting beyond the frame face in most situations. Due to the geometry of the arm it is approximately 25% less power-efficient than a regular arm application. The entire closer and arm assembly are mounted below the frame stop, requiring a top rail clearance on the door of between 5-3/8" (137mm) when using the hold open arm.



### Corner Bracket

This application can be used where top jamb and parallel arm application will not accommodate the door and frame conditions. Requires minimal top rail on the door; however, vertical clearance to the floor within the door opening should be checked to ensure code compliance. The close proximity, for this application, of the door closer to the door's pivot point reduces the door closer's power efficiency by approximately 25% when compared to a regular arm. The projection of the arm from the door face might pose questions regarding design parameters or environment.



**TECHNICAL DETAILS**

**Regular Arm**

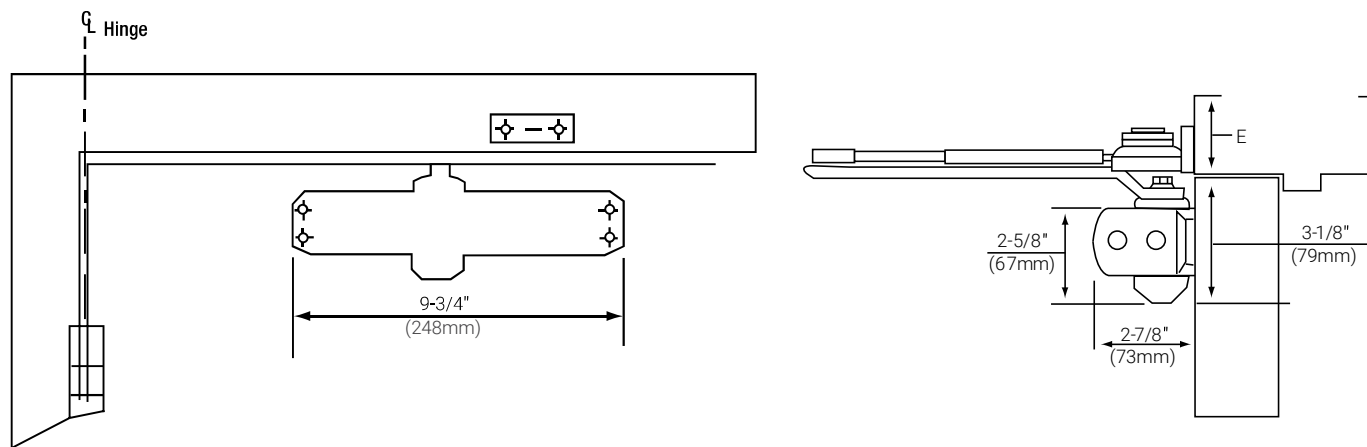

Mounting holes for closer body are spaced 3/4" (19mm) vertically x 9 - 1/16" (230mm) horizontally.

Model Number	
Non-Hold Open	Hold Open
51	151

E Minimum Ceiling Clearance Inches (mm)	
Non-Hold Open	Hold Open
1-1/2" (38)	1-5/8" (41)

Standard Door Widths	
Interior	32" - 48" (81 - 122cm)
Exterior	30" - 48" (76 - 122cm)

**TECHNICAL DETAILS**

**Top Jamb**

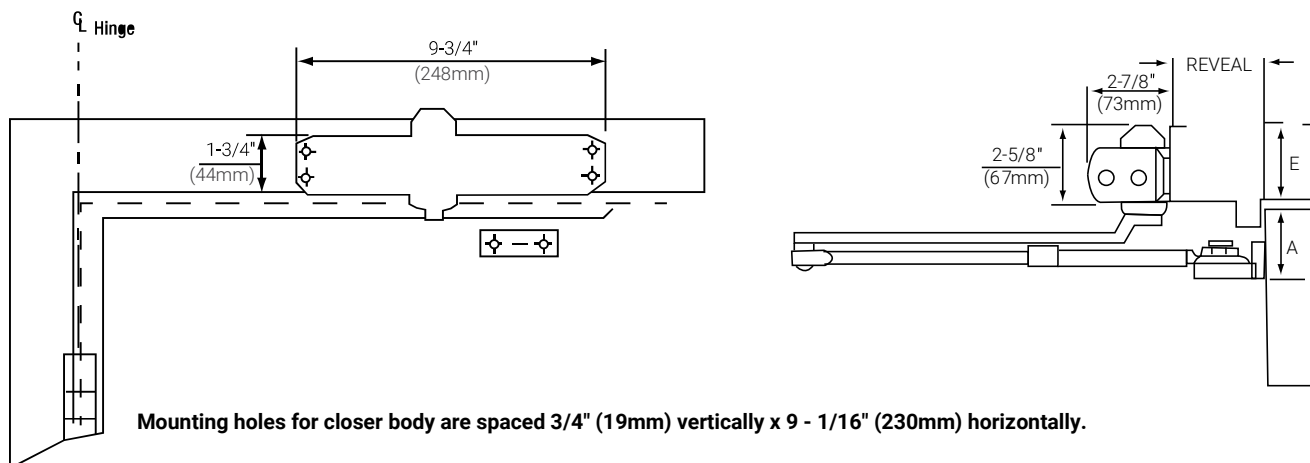

Model Number	
Non-Hold Open	Hold Open
51	151

E Minimum Ceiling Clearance		A Minimum Ceiling Clearance		
Without Drop Plate	With Drop Plate	Without Drop Plate	With 587 Drop Plate	With 214 Drop Plate
2-5/8" (67)	1-3/4" (44)	1-7/8" (48)	2-5/8" (67)	4" (102)

Standard Door Widths	
Interior	32" - 48" (81 - 122cm)
Exterior	30" - 48" (76 - 122cm)

Closer Series	Reveal Inches (mm)
51	0 to 3" (0 to 76)
TJ51	2-7/8" to 7" (73 to 178)
151	0 to 2-3/4" (0 to 70)
TJ151	2-3/4" to 6-3/4" (70 to 171)

**TECHNICAL DETAILS**

**Parallel Arm**

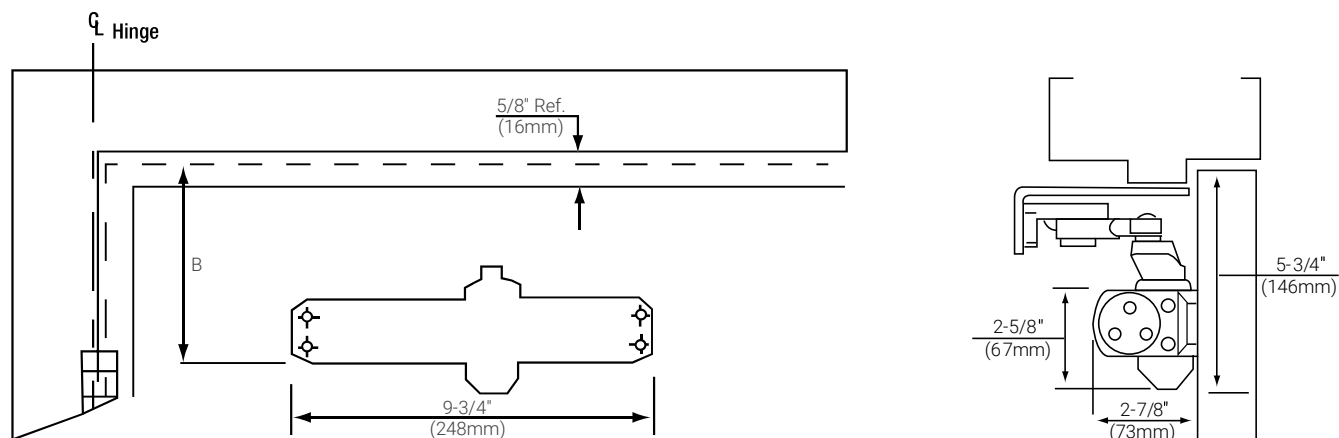

**Mounting holes for closer body are spaced 3/4" (19mm) vertically x 9 - 1/16" (230mm) horizontally.**

Model Number	
Non-Hold Open	Hold Open
51	151

B	
Minimum top rail of door with 5/8" (16mm) frame stop	
Without Drop Plate Inches (mm)	With Drop Plate Inches (mm)
5" (127)	3-1/8" (79)

Standard Door Widths	
Interior	30" - 48" (76 -122cm)
Exterior	

**ACCESSORIES**

**Regular Arm**

**Brackets for Non-Hold Open Arms**

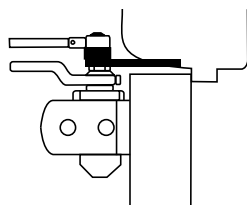
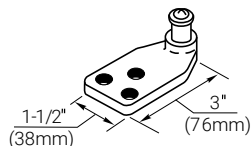

**Molded/Bull Nose Trim - 291 Bracket**

For use where the door frame has molded or bull nose trim which will not accept a standard non-hold open shoe. The bracket is mortised into the frame rabbet, and projects beyond the face of the frame. It will accommodate a frame rabbet up to 2" (51mm) deep.

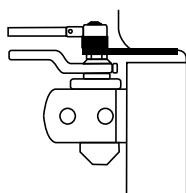
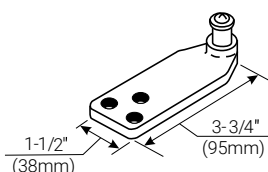

**Molded/Bull Nose Trim - 291A Bracket**

This bracket is similar to - but longer than - the 291 bracket. It is designed to accommodate frame rabbets from 2" to 2-7/8" (51mm to 73mm) deep.

**Brackets for Hold Open Arms**

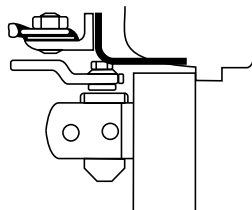
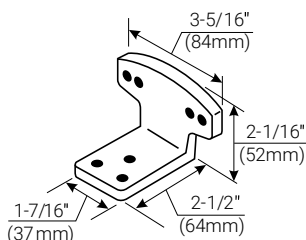

**Molded/Bull Nose Trim - 292 Bracket**

For use where the door frame has molded or bull nose trim which will not accept a standard hold open shoe. It is mortised into the frame rabbet, and projects beyond the face of the frame. It will accommodate a rabbet up to 2" (51mm) deep. This bracket is used in combination with the standard hold open mounting shoe.

**Corner Brackets for Closer Mounting**

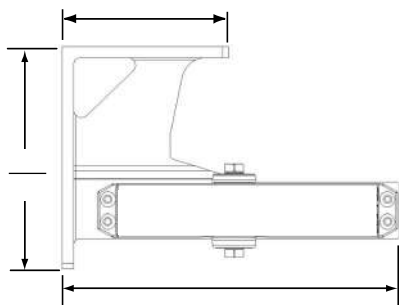

For closer sizing information, use the parallel arm sizing chart on page 11.

**Mounting Opposite Hinge Side - 2350 Corner Bracket**

For use where it is desired to mount the closer regular arm on the opposite to hinge side of the door. Can also be used to clear an overhead door holder.

**ACCESSORIES**

**Top Jamb**

Closer Mounting Plates	
	<p><b>Overhead Door Holder - 214 Drop Plate</b></p> <p>For use where an overhead door holder prevents normal top jamb mounting. This places the center line of the arm mounting screws at 3-1/2" (89mm) from the top of the door.</p>
	<p><b>Low Ceiling Clearance - Overhead Door Holder - 587 Drop Plate</b></p> <p>For use where the ceiling clearance is between 1-3/4" and 2-5/8" (44mm and 67mm). Or for use where an overhead door holder prevents normal top jamb mounting. This places the centerline of the arm mounting screws at 2-1/8" (54mm) from the top of the door.</p>

**ACCESSORIES**

**Parallel Arm**

**Closer Mounting Plate**

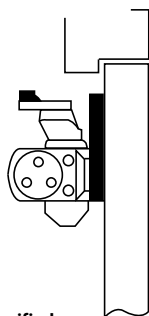
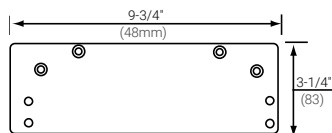

**Note: #214C - To be used when optional cover is specified.**

**Narrow Top Rail - 214 Drop Plate**

For use where a narrow top rail prevents the closer from being mounted directly to the door surface. This drop plate can be used to mount a closer on a top rail as narrow as 3-1/8" (79mm) in height for 50BC or 2-1/8" (54mm) for 50BCP.

Plate No.	Dimensions	
	A (width)	B (length)
214	3-1/4" (83mm)	9-3/4" (248mm)
214C	4-1/8" (105mm)	9-7/8" (251mm)

**Brackets for Non-Hold Open Arms**

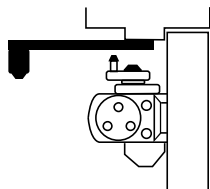
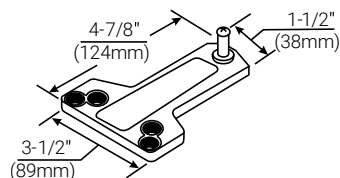

**Standard Installation - 289A Soffit Plate**

This soffit plate is supplied standard with parallel arm closers. It can be mounted where the frame soffit is as narrow as 1" (25 mm).

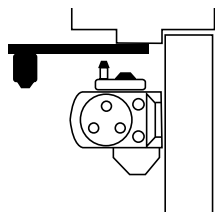
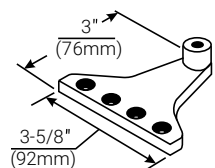

**Narrow Frame/Removable Stop - 297 Soffit Plate**

For use where a narrow frame or frame with removable stop does not permit use of the standard soffit plate. This soffit plate may be mounted on the frame soffit or the frame rabbet where the stop does not exceed 5/8" (16mm) in height. All of the screw holes are in a straight line, requiring as little as 1-1/4" (32mm) of frame reveal to mount bracket and maintain good closer arm geometry. Where the frame soffit is as 2" (51mm), this soffit plate may be used to clear weather - stripping that is up to 1-3/8" (35mm) wide and 5/8" (16mm) in height.

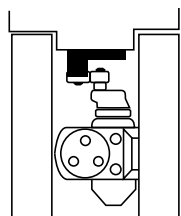
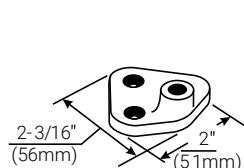

**Mounting Between Doors - 413A Soffit Bracket**

For use where insufficient space between companion doors does not permit use of other soffit plates. This bracket permits mounting of the closer between doors with as little as 3" (76mm) of header space. Permits closer arm to clear up to 5/8" (16mm) high stop.

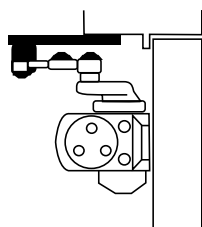
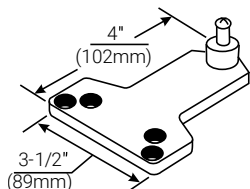

**Blade/Applied Stop - 299 Soffit Plate**

For use where a blade or applied stop does not permit installation of the standard soffit plate. Mounts to either the frame soffit or rabbet. Since this soffit plate projects 7/8" (22mm) less than a standard soffit plate, it requires a minimum frame reveal of 1-1/2" (38mm). Permits closer to clear up to a 5/8" (16mm) high frame stop.

**ACCESSORIES**

**Parallel Arm**

**Brackets for Non-Hold Open Arms (Continued)**

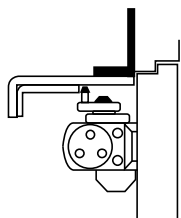
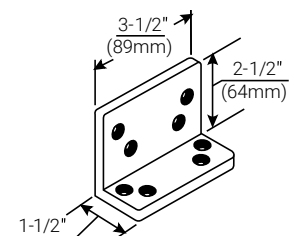

**Flush Transom - 589L Angle Bracket**

For use where rabbeted or flush transom conditions prevent installation of a soffit plate. Used in combination with the 289A soffit plate, or may be used in combination with the 290 soffit plate when it is necessary for the closer arm to clear a separate overhead door holder.

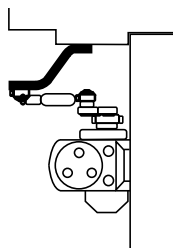
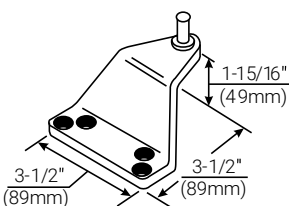

**Extra-Clearance - 290 Offset Soffit Plate**

For use where the need for additional clearance prevents use of the standard soffit plate. This plate mounts to the frame soffit to provide up to 2" (51mm) of clearance when a separate overhead door holder is used. Standard mounting requires a 2-5/8" (67mm) wide frame soffit. It may also be used where unusually high frame stops or weather stripping prevent the use of other soffit plates.

**Brackets for Hold Open Arms**

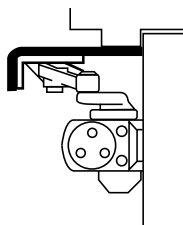
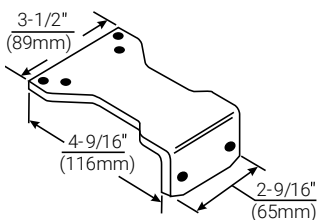

**Parallel Hold Open - 588 Adapter Plate**

This adapter plate is supplied standard with all parallel arm hold open closers. It can also be used to convert regular arm or top jamb hold open arms to parallel arm installation. It can be mounted where the frame soffit is as narrow as 1" (25mm).

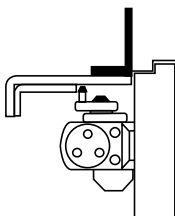
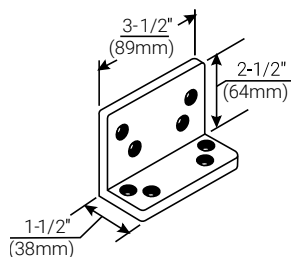

**Flush Transom Hold Open - 589L Angle Bracket**

For use where rabbeted or flush transom conditions prevent installation of the standard 588 hold open adapter plate. It is used in combination with the 588 adapter plate.

## ACCESSORIES

### Door Closer Body Assemblies

Body Only (Standard)	
51LAP	Multi-sized

**LAP = less all parts**

**Pinion cap and mounting screws supplied standard.**

**Cover (optional) - specify 50P**

**Dimensions (RA and PA applications):**

2-7/8"(73mm) height x 3-1/16"(78mm) deep x

9-7/8"(251mm) long

To order with closer, add suffix P to model number.

### 1639 Pinion Cap

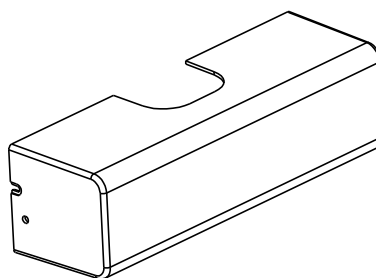
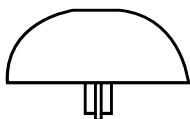

### Fasteners

#### Steel Door Application

Sex nut / sleeve-nut: "SN" (4 per pack) or

Sex nut / sleeve-nut & screw: "SNB" (4 per pack)

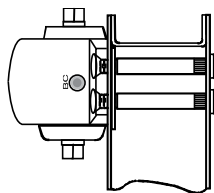

#### Aluminum and Wood Door Application

(Aluminum door shown)

Through-bolt & grommet nut : "TBGN" (4 per pack)

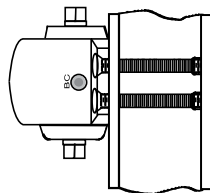

Door	SN'S	SNB's
1-3/4"	SN-134	SNB134-38
2"	SN-200	SNB200-38
2-1/4"	SN-214	SNB214-38
S.S. SNB's 1-3/4"	SN-134SS	SNB134SS-38

Door	TBGN's
1-3/8"	TBGN138-38
1-3/4"	TBGN134-38
2-1/4"	TBGN214-38



**PARTS LIST**

**Non-Hold Open Arm Assemblies**

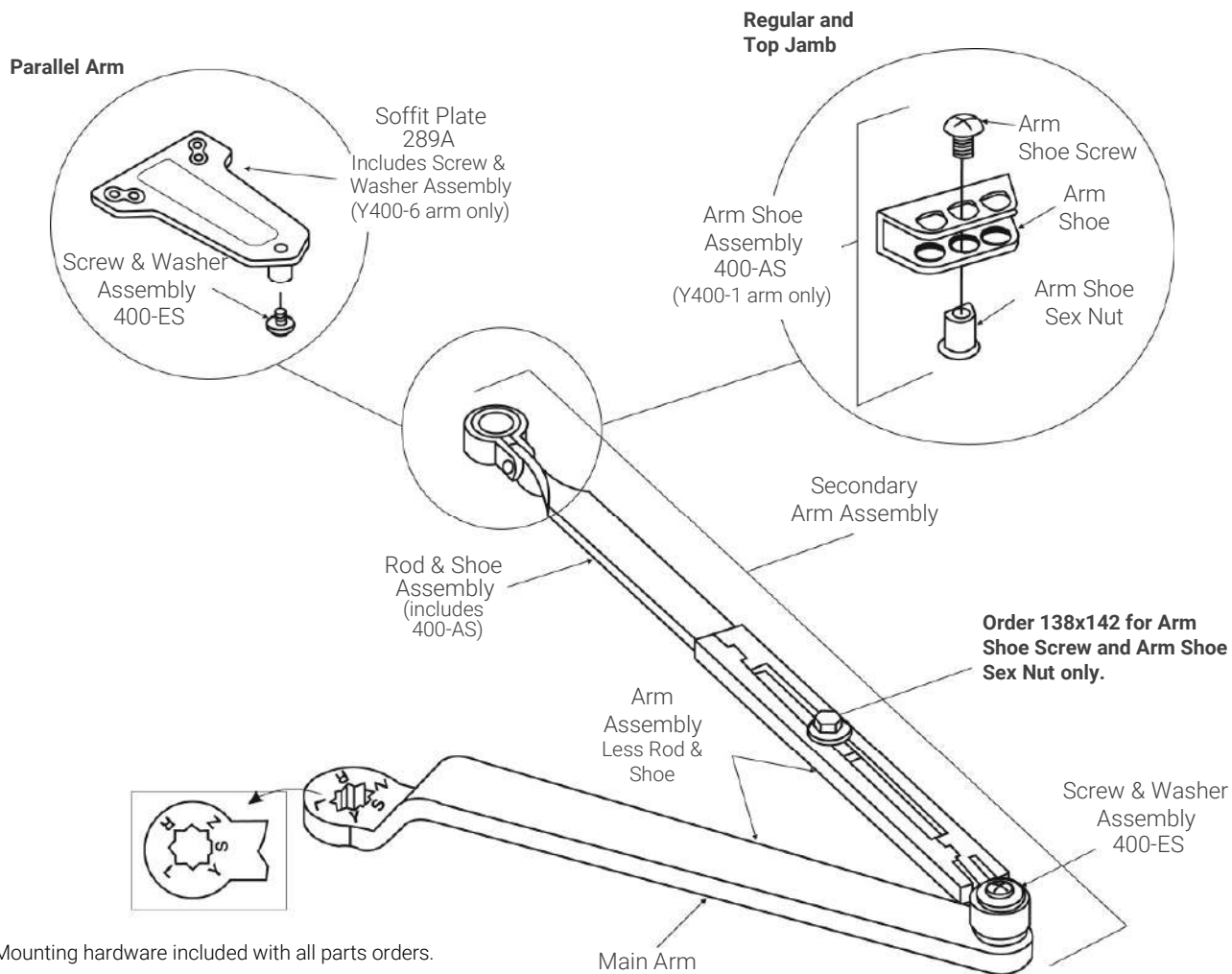

Closer Series	Complete Arm Assembly	Main Arm Assembly <sup>1</sup> (length)(mm) (includes 400-ES)	Secondary Arm Assembly (includes 400-ES)	Arm Assembly Less Rod and Shoe	Rod & Shoe Assembly <sup>2</sup> (length)(mm)
51	Y400-1	400-1M (11") (279)	Y400-111	Y400-1W	Y400-11 (8-7/8") (225)
TJ51	Y400-1A		Y400-121		Y400-11A (12-1/2") (318)
PA51	Y400-6		Y400-116		Y400-16 (8-7/8") (225)
PA51C <sup>3</sup>	Y400-6A		Y400-116A		Y400-16A (12-1/2") (318)
51	Y400-26 (Tri pack includes Y400-1 plus 289A plate)				

1. C/L to C/L length shown in parentheses.

2. C/L of connecting link to end of rod shown in parentheses.

3. For 180° door swing when using a special template for doors hung on 6" to 8" (162mm to 203mm) wide throw hinges.

**PARTS LIST**

**Hold Open Arm Assemblies**

400-13 Holder Shoe & Loop Assembly

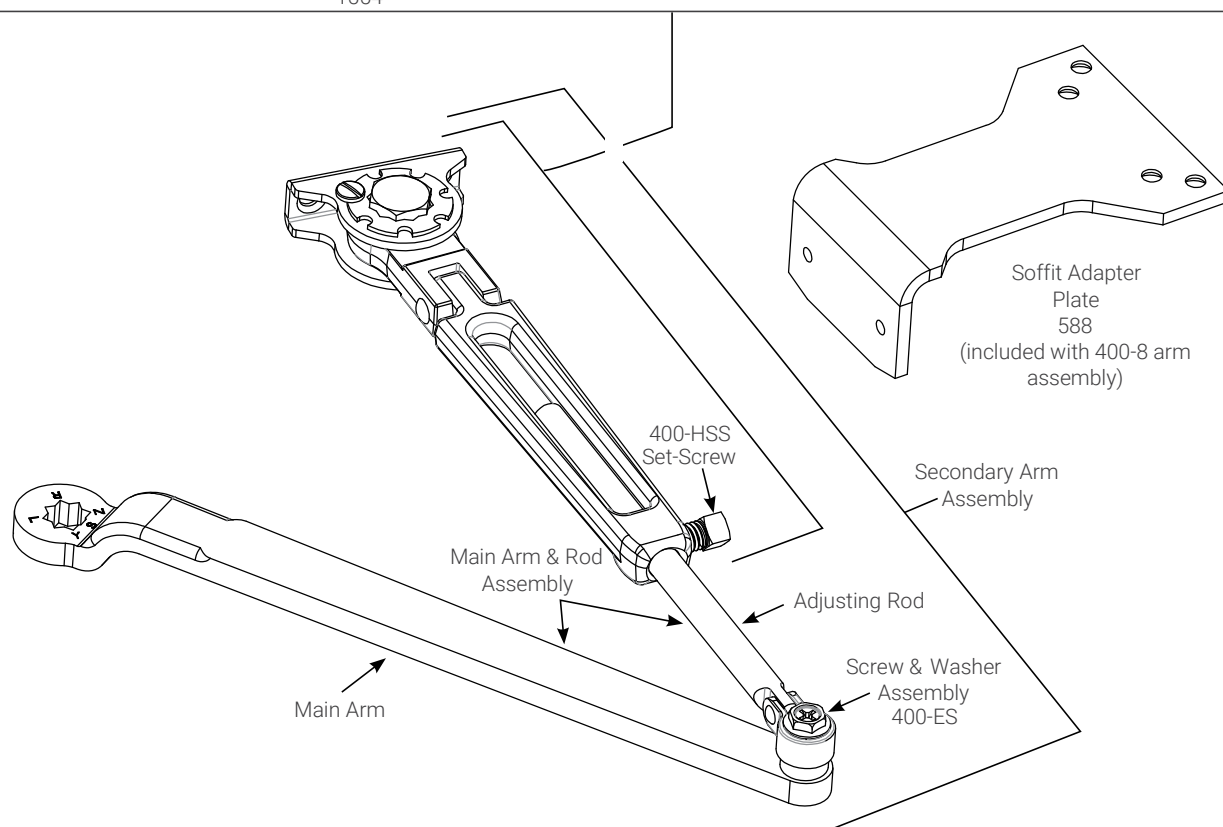
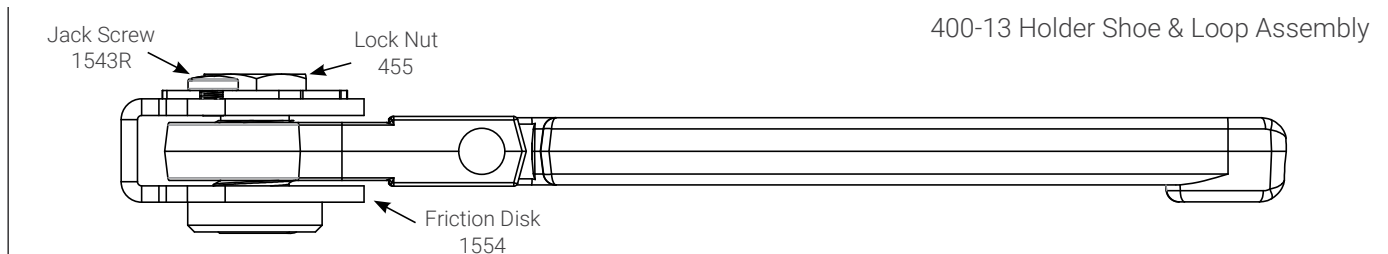

Note: Mounting hardware included with all parts orders.

Closer Series	Complete Arm Assembly	Main Arm Assembly <sup>1</sup> (length)(mm) (includes 400-ES)	Secondary Arm Assembly (includes 400-ES)	Main Arm & Rod Assembly	Holder Shoe & Loop Assembly	Adjusting Rod <sup>2</sup> (Length)(mm)
151	400-3/400-8 <sup>3</sup> (Reg)/(Par)	400-1M (11") (279)	400-113/400-118 (Reg)/(Par)	400-3W	400-13 / 400-18 <sup>4</sup> (Reg)/(Par)	400-31 (7-3/8") (187)
TJ151	400-3A		400-123	400-3WA		400-31A (10-13/16") (275)

**400-18 = Holder Shoe & Loop Assembly (400-13) with soffit adapter plate (588)**

1. C/L to C/L length shown in parentheses.
2. C/L of connecting link to end of rod shown in parentheses.
3. Same as 400-3 but includes 588 soffit adapter plate.
4. Same as 400-13 but includes 588 soffit adapter plate.

## SAMPLE SPECIFICATION

### 51 Series

Closers for interior and exterior doors shall be full rack-and-pinion type with cast aluminum alloy shell. Closers shall be surface mounted and shall project no more than 2-7/8" from the surface of the door. Closers shall be non-handed to permit installation on doors of either hand. Closer fluid shall contain lubricity and anti-oxidation agents. Closer fluid shall maintain stable viscosity to allow the door closer to perform in temperatures ranging from extremely high to as low as - 40°F. Closers shall have multi-size spring power adjustment to permit setting of spring power for sizes (1 through 6). Closers shall have two non-critical valves, hex key adjusted, to independently regulate sweep and latch speed. (Closers shall have adjustable backcheck cushioning controlled by a hex key adjusted valve.) Closer power shall be adjustable using 1/8" hex key.

(Closers shall be provided with a full molded cover.)

Regular arm and top jamb closers shall have a non-hold open shoe permitting 15% (+/- 7-1/2%) power adjustment. [51]

The ASSA ABLOY Group is the global leader in access solutions.  
Every day, we help billions of people experience a more open world.

ASSA ABLOY Opening Solutions leads the development within door openings and products for access solutions in homes, businesses and institutions. Our offering includes doors, frames, door and window hardware, mechanical and smart locks, access control and service.

**ACCENTRA**  
**ASSA ABLOY**

**TECHNICAL SUPPORT**

(Troubleshooting, product use and application, returns)  
Tel: 855-557-5078  
Email: techsupport.accentra@assaabloyusa.com

**CUSTOMER SUPPORT**

(Orders, product configuration, pricing, lead-time)  
Tel: 855-557-5078 x2  
Email: Customerservice.Accentra@assaabloy.com

**U.S.A.:**  
**ASSA ABLOY ACCENTRA™**  
225 Episcopal Road,  
Berlin, CT 06037-4004  
Tel: 1-800-438-1951  
Fax: 1-800-338-0965  
[www.accentra-assaabloy.com](http://www.accentra-assaabloy.com)

**Canada:**  
**ASSA ABLOY Door Security Solutions Canada**  
160 Four Valley Drive  
Vaughan, Ontario L4K 4T9  
Tel: 1-800-461-3007  
Fax: 1-800-461-8989  
[assaabloydss.ca](http://assaabloydss.ca)

**International:**  
**ASSA ABLOY Americas International**  
Tel: 1-905-821-7775  
Fax: 1-905-821-1429  
[assaabloyai.com](http://assaabloyai.com)