

# Upholstered Counter Stool

**S025416UK - Camel**  
**S025412UK - Grey**  
**S025410UK - Green**  
**S025401UK - Black**

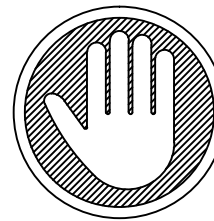
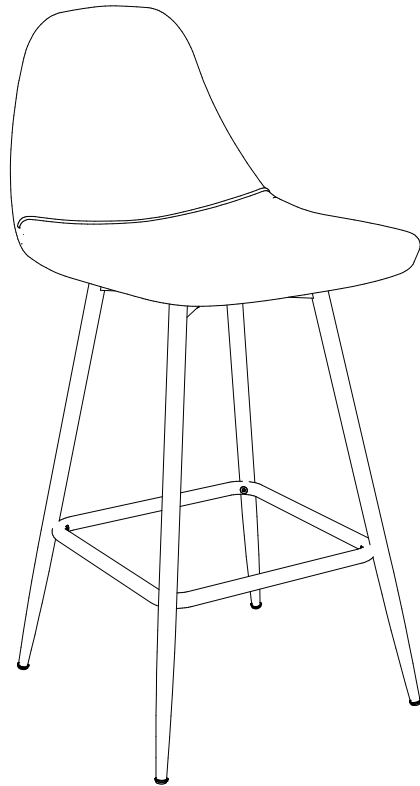

THIS INSTRUCTION BOOKLET CONTAINS **IMPORTANT** SAFETY INFORMATION. PLEASE READ AND KEEP FOR FUTURE REFERENCE.

## Read Before Beginning Assembly

- Call our 01942 524100 if you need assistance.
- Work in a spacious area and near where the unit will be used, preferably on a carpet, or use a piece of the cardboard packaging to protect your floor and product.
- Recommended # of people needed for assembly: 1 (however it is always better to have an extra hand). Estimated assembly time is 30 min .
- Make sure all parts are included. Most parts are labeled or stamped on the raw edge.
- Read each step carefully. It is very important that each step of the instructions is performed in the correct order. If these steps are not followed in sequence, assembly difficulties will occur.

## Contact Us!

For help with assembly, identifying parts, product information or to order parts, please contact us:



[cseurope@dorel.com](mailto:cseurope@dorel.com)



**01942 524100**

**Monday to Friday 9:00 am to 9:00 pm** (Eastern Time)

**Saturday 10 am to 6:30 pm** (Eastern Time)

**Sunday 11 am to 7 pm** (Eastern Time)

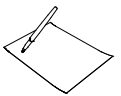

### Consumer Services

Dorel Home Furnishings Europe  
Building 4, Imperial Place  
Maxwell Road, Borehamwood  
WD6 1JN United Kingdom

## Caution

- This product is designed for home use and not intended for commercial use.
- This product contains small components. Please ensure that they are kept away from small children.
- Do not use power tools to assemble your furniture. Power tools may strip or damage the parts.

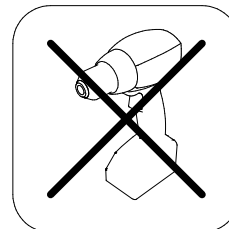

# Parts

Replacement Parts, visit

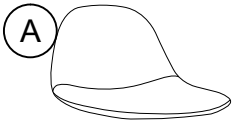

Seat  
X 1

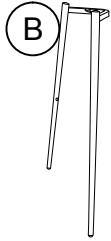

Leg  
X 2

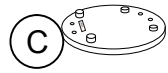

Round Plate  
X 1

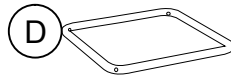

Square Support  
X 1



All in 1 big box!



Before you throw the package, please use the Check Box to identify the parts and ensure that you have all the parts needed for the assembly.

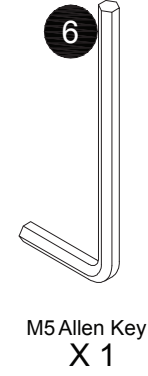
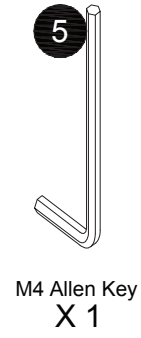
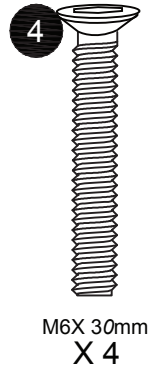
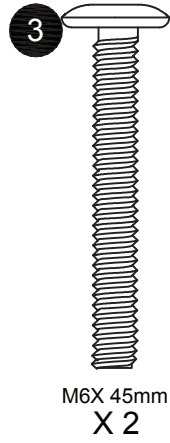
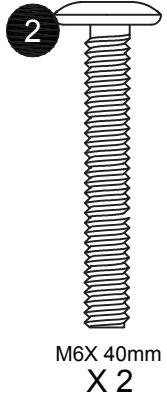
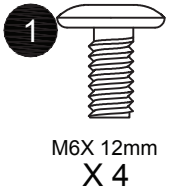

# Hardware Pack

Hardware Pack #: **TS014412-00**

Please do not completely tighten all the hardware, until the entire assembly is completed, unless otherwise indicated in the step-by-step instructions.

The screw(s), bolt(s) to be used at each step are shown in actual size in the lower right corner of the page.

# Step 1

Attach Bx2 to C with ①, as shown.

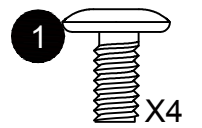
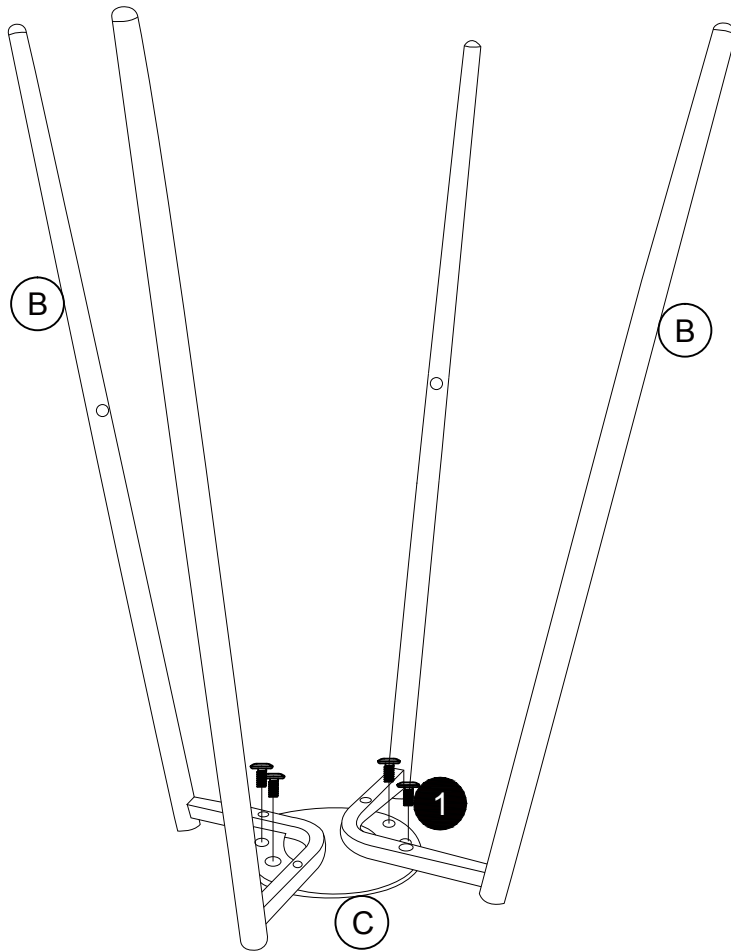

## Step 2

Attach **D** to **Bx2** with **4**, as shown.

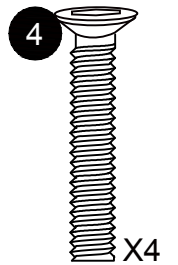
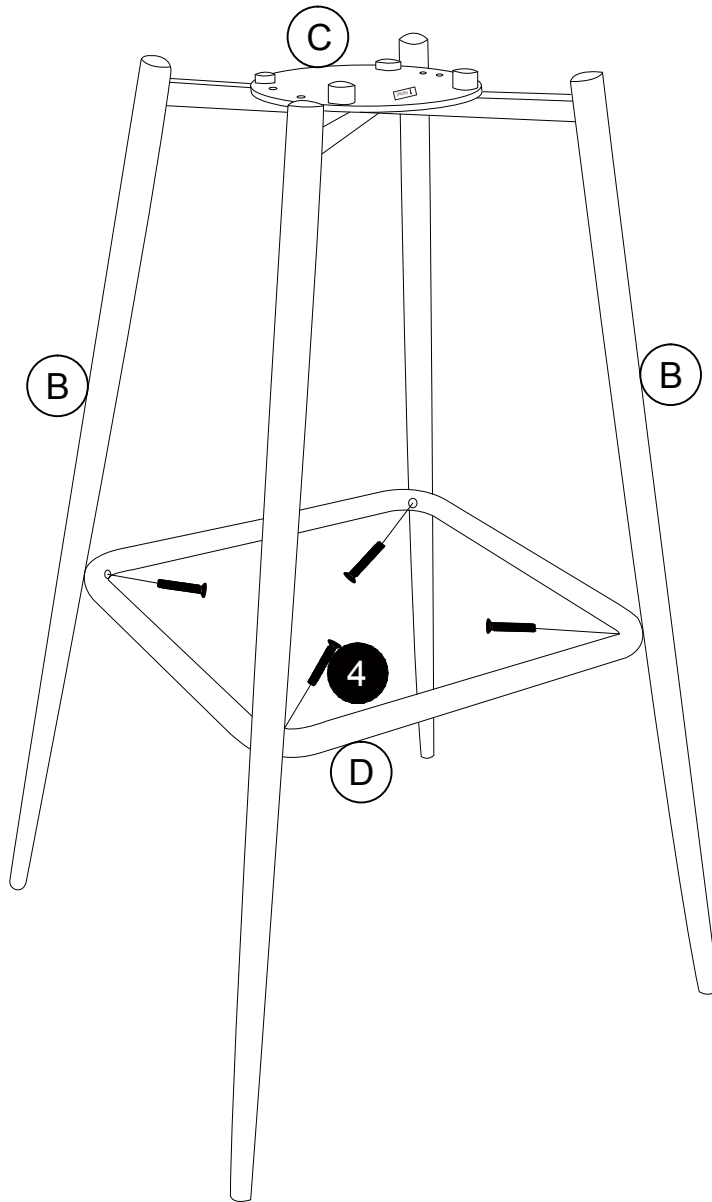

# Step 3

Attach **B** & **C** to **A** with **2** & **3**, as shown.

The round plate should be directed as shown.

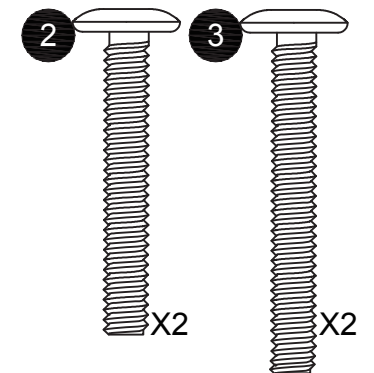
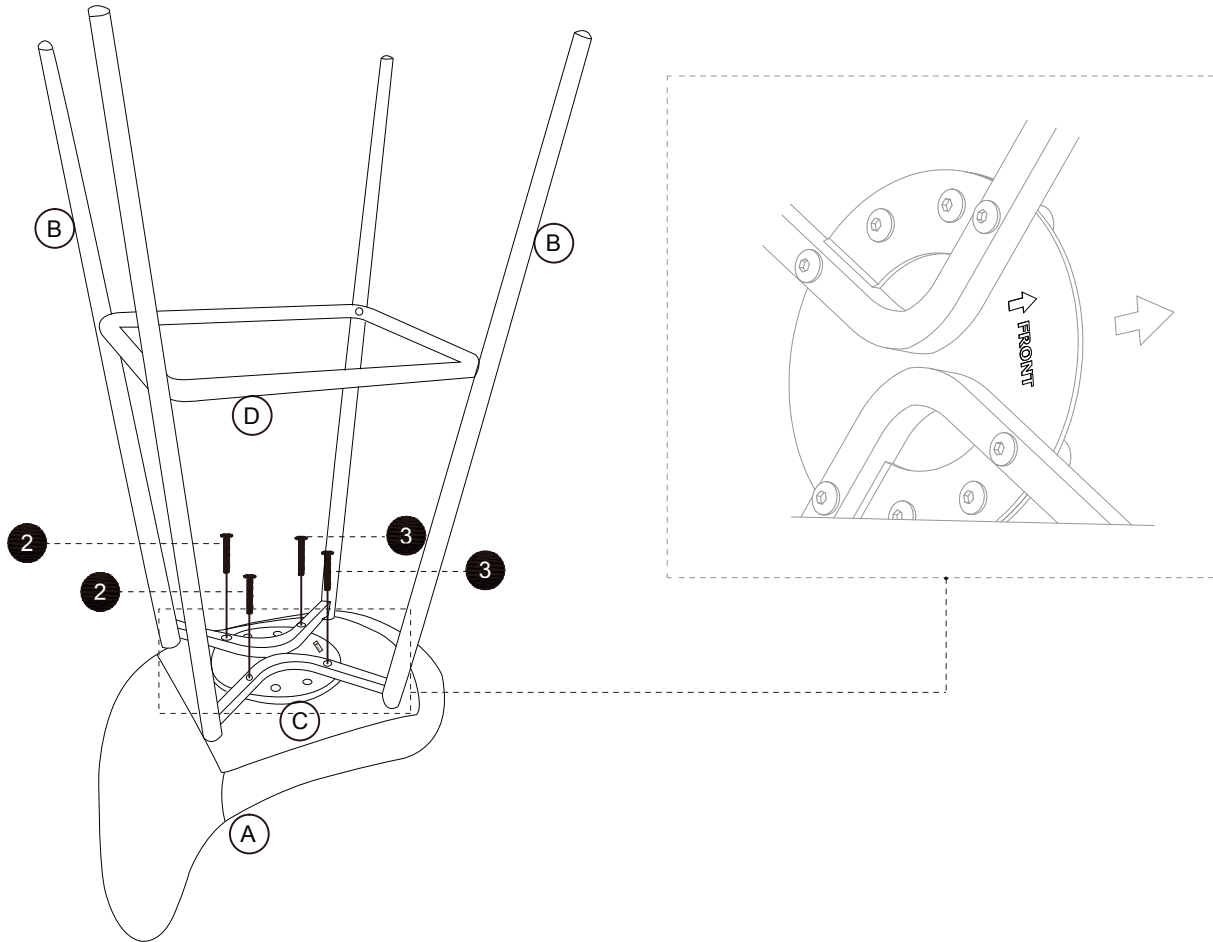

 Weight Limit: 250 Lb /113 Kg

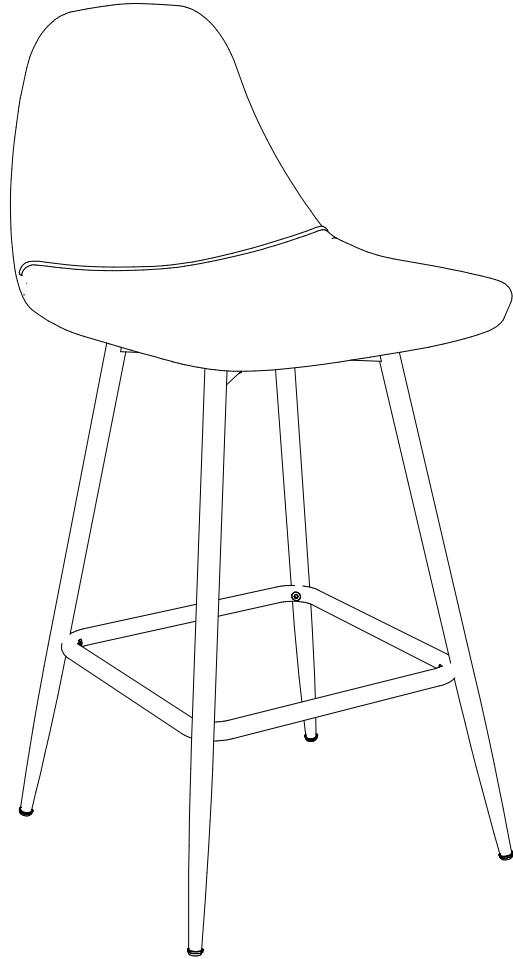

## Helpful Hints

- Move your new furniture carefully, with two people lifting and carrying the unit to its new location.
- Your furniture can be disassembled and reassembled to move.
- Clean the product with a soft damp cloth. DO NOT use harsh chemicals or abrasive cleaners.



# Calvin Counter Stool



Simple, stylish and versatile, the Calvin Upholstered Counter Stool promises to complement any room décor. With its clean lines and simple Mid-Century design, this chair will give your kitchen the finishing touch it needs. The upholstered seat with footrest and backrest with foam padding provides comfort while the metal legs make sure the Calvin is built to last!

- Simple, versatile design that complements any décor.
- Upholstered seat with footrest and backrest with foam padding for extra comfort. Sturdy metal legs.
- Ships in one box. Quick and easy assembly.
- Available in Black Faux Leather, Camel Faux Leather, Grey Velvet, Green Velvet.

# Calvin Counter Stool



**S025416UK Camel Faux Leather**  
**EAN: 5060669114314**



**S025401UK Black Faux Leather**  
**EAN: 5060669114284**



**S025410UK Green Velvet EAN: 5060669114291**



**S025412UK Grey Velvet**  
**EAN: 5060669114307**

<b>Product</b>	<b>Height:</b> 838mm	<b>Shipping</b>	<b>Height:</b> 635mm
	<b>Width:</b> 444mm		<b>Width:</b> 406mm
	<b>Depth:</b> 394mm		<b>Depth:</b> 229mm
	<b>Weight:</b> 6 kg		<b>Weight:</b> 7 kg