

1010-M

Q13880-AI_r2



PLACE LABEL
Q14171-SK
HERE



01942 524 100



customer.services@armourhome.co.uk



Armour Home Electronics, Units 7 & 8, Stortford Hall Industrial Park,
Dunmow Road, Bishops Stortford, Hertfordshire, UK, CM23 5GZ

1010-M

PLEASE INSPECT ALL PARTS PRIOR TO ASSEMBLY AND CONTACT US IF ANY OF THE PARTS ARE DAMAGED OR MISSING. THIS MUST BE DONE BEFORE ATTEMPTING ASSEMBLY.

Thank you for purchasing this Chair. Please read the instructions carefully before use to ensure safe and satisfactory operation of this product.

Pre-assembly preparation

Please ensure instructions are read in full before attempting to assemble this product

Necessary Tools

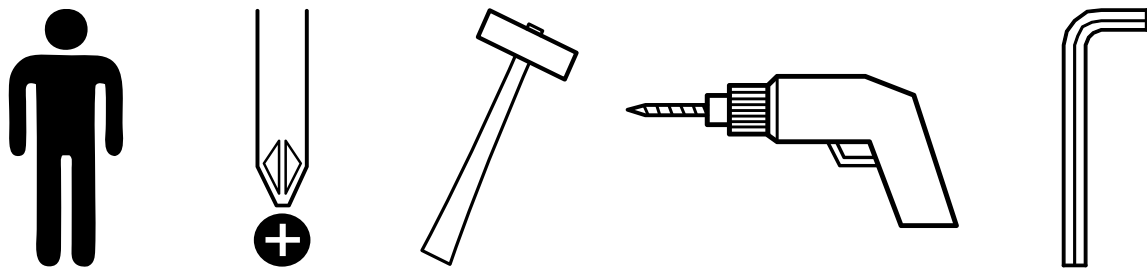

Note: Some of the tools shown here are optional and are required only for quick assembly of this product

Please check the pack contents before attempting to assemble this product. A full checklist of components is given in this leaflet. If any components are missing, please contact the retailer from whom you bought this product.

This product is **HEAVY**, it should be assembled as near as possible to the point of use. **TAKE CARE WHEN LIFTING** to avoid personal injury and (or) damage to the product.

This product takes approximately **15 MINUTES** to assemble with **1 PERSON**.

The fittings pack contains **SMALL ITEMS** which should be **KEPT AWAY FROM YOUNG CHILDREN**.

Read this leaflet in full before commencing assembly.

1010-M

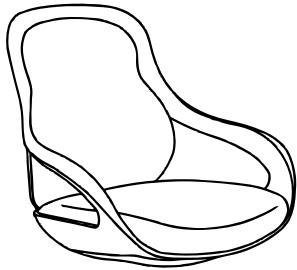

A x1

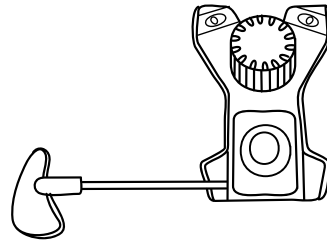

B x1



C x1

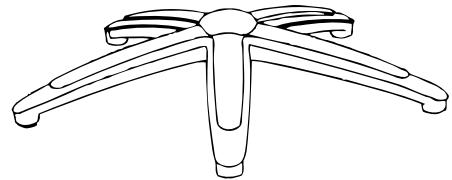

D x1

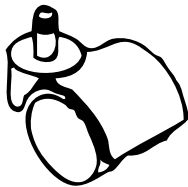

E x5

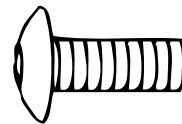

F x4



G x1

1010-M

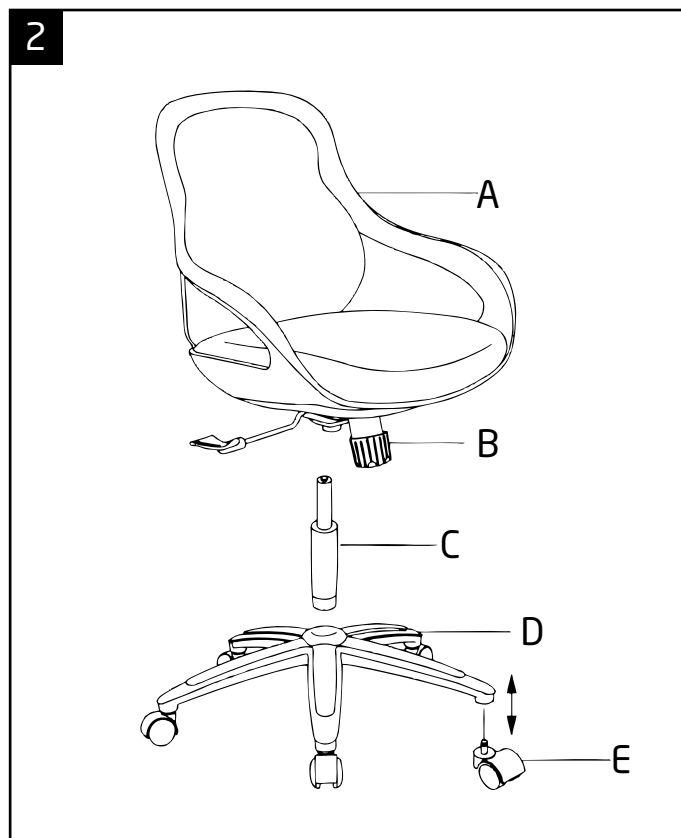
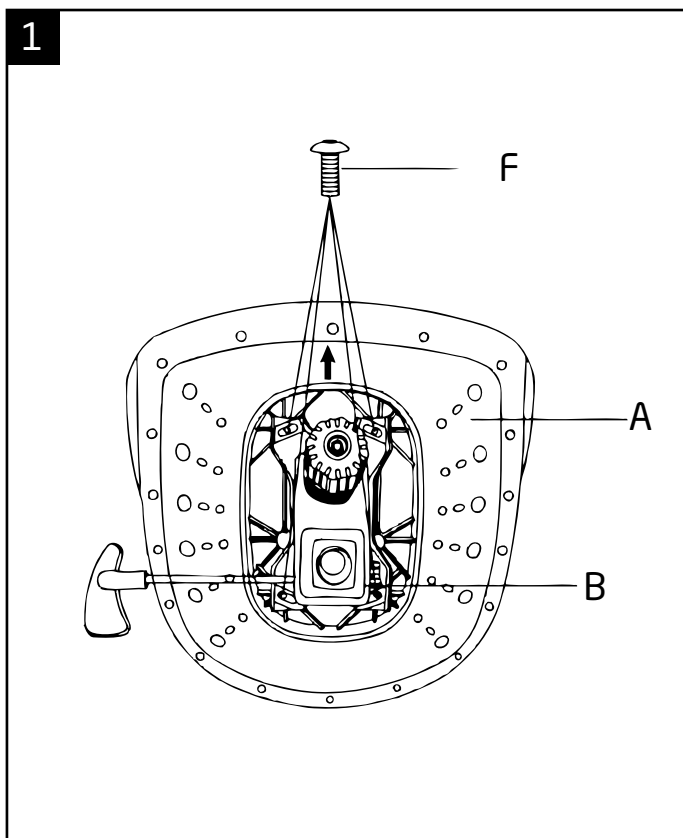

1010-M

Safety Instructions

Periodically check all fixings to ensure none have come loose and re-tighten where necessary.

Please take care when handling or moving the furniture as careless handling may cause damage or injury.

Furniture can be dangerous if incorrectly installed. Assembly should be carried out by a competent person. No liability will be accepted for damage or injury caused by incorrectly installed or assembled furniture.

It is recommended that before moving heavy objects to a new location they are completely dis-assembled to avoid personal injury or damage to the furniture. Please be careful to retain all fittings when doing this.

Never tilt the chair. Ensure the chair is always placed firmly on the ground.

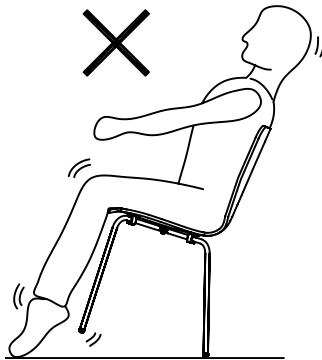

WARNING :

Sit on the chair to use the weight of the body to tighten the joint on the column and the seat.

Please note this is not a permanent fit due to the rise & fall and 360 degree turning action.

Always take care and keep feet clear of base when moving / lifting this product.

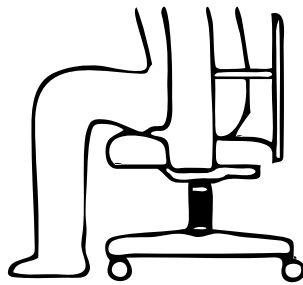

Do not stand on chair or use a ladder as this may cause serious injury.

Do not use the chair if any part appears damaged, broken or missing.

Do not use the chair unless all components are correctly fitted and adjusted.

PLEASE KEEP THESE INSTRUCTIONS FOR FUTURE REFERENCE

Croft



AOC1010-M-

Design Highlights

- Mesh back chair with fabric seat
- Moulded designer frame
- Height adjustment
- Locking tilt mechanism with tension control
- Seat Dims (mm):
H 470-550 x W 470 x D 440
- EAN – Black: 5030752010731
Grey: 5030752017419

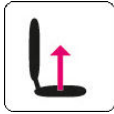
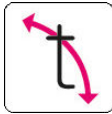

With its distinctive moulded frame with designer back and base, covered in a quality mesh with a generously padded seat, the Croft is not a chair to be missed. The Croft comes complete with height adjustment, tilt mechanism and tension control.

		
Seat Height Adjustment	Traditional Tilt	Weight Tension Control

Black	
Grey	

Croft

Technical Sheet

AOC1010-M-

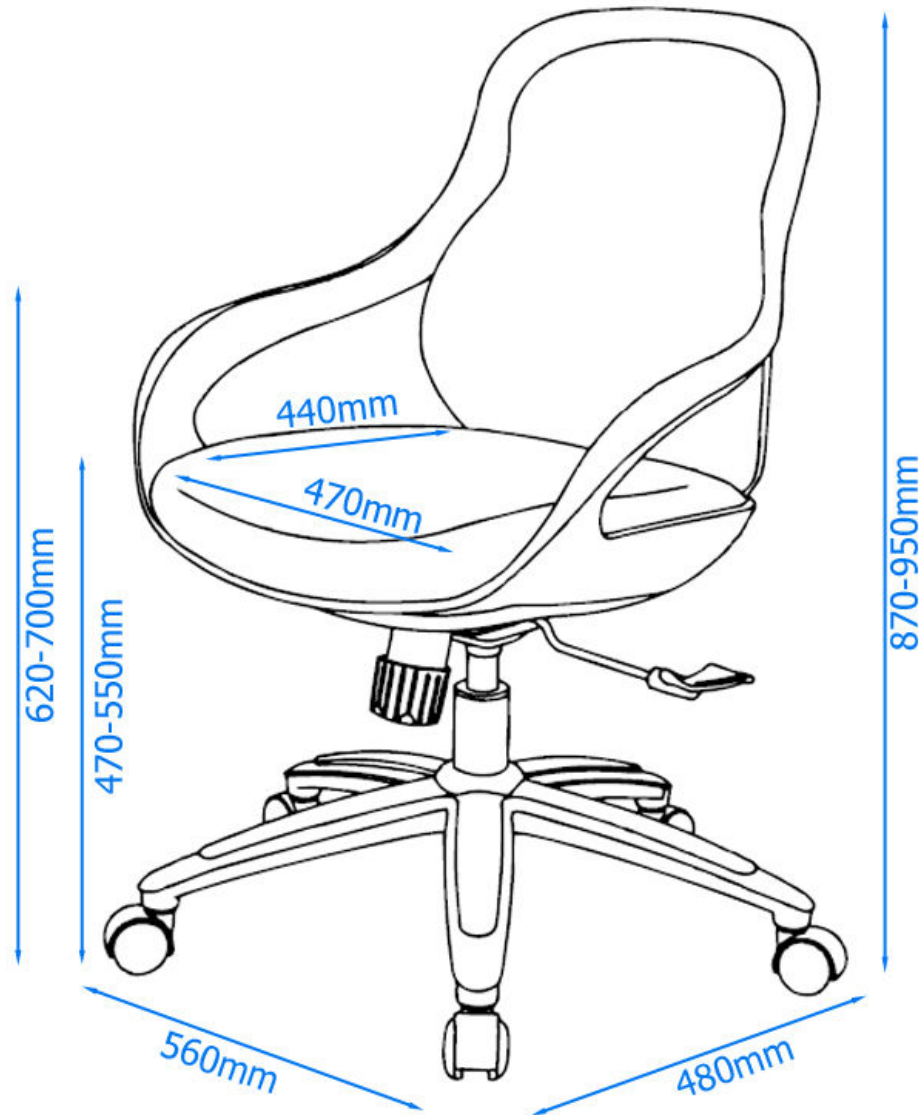

SPECIFYING

Seat Height (mm)	470-550
Max. User Weight (kg)	114
Max. Recommended Use (hours)	6
Product Weight (kg)	11.6
Dims: H 950 x W 560 x D 480 (mm)	

PACKAGING

Number of Boxes	1
Width (mm)	625
Height (mm)	540
Depth (mm)	560
Weight (kg)	13.5



www.alphasondesigns.com



CSEurope@Dorel.com



01942 524100



Dorel Home Furnishings Europe Ltd, 244 Swan Lane, Hindley Green, Wigan, UK, WN2 4EY

alphason