

AOC4125BLK

Design Highlights

- Executive high back mesh chair
- Curved black frame
- Durable arms
- Adjustable headrest
- Locking tilt mechanism with tension control
- Height adjustable
- Seat Dims (mm):
H 430-510 x W 480 x D 470
- EAN: 5030752019727



Made from high quality strong mesh, the Florida is a beautifully crafted chair designed to both look and feel good. The high mesh backrest incorporates posture curvature and the pronounced waterfall seat front further improves your sitting position. The Florida boasts height adjustment, tilt mechanism and tension control, and heavy duty arms, all presented in a simple yet attractive chair.



Seat Height Adjustment

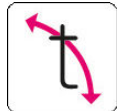

Traditional Tilt



Weight Tension Control

Black



www.alphasondesigns.com



CSEurope@Dorel.com



01942 524100



Dorel Home Furnishings Europe Ltd, 244 Swan Lane, Hindley Green, Wigan, UK, WN2 4EY

alphason

Florida

Technical Sheet

AOC4125BLK

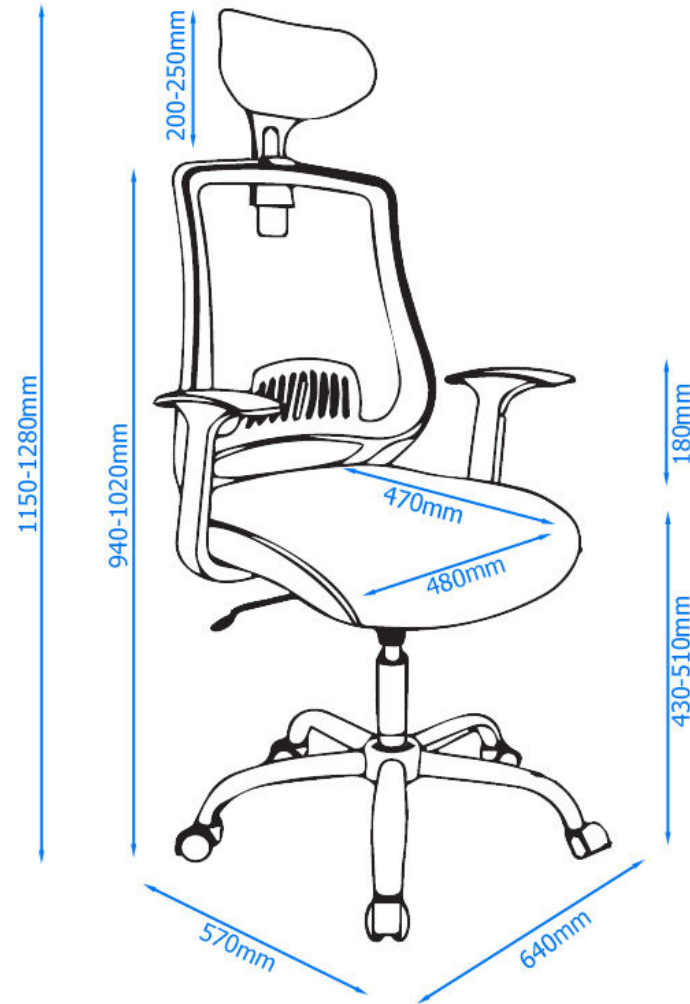

SPECIFYING

Seat Height (mm)	430-510
Max. User Weight (kg)	114
Max. Recommended Use (hours)	8
Product Weight (kg)	13.5
Dims: H 1280 x W 640 x D 570 (mm)	

PACKAGING

Number of Boxes	1
Width (mm)	640
Height (mm)	610
Depth (mm)	280
Weight (kg)	15.5



www.alphasondesigns.com



CSEurope@Dorel.com



01942 524100



Dorel Home Furnishings Europe Ltd, 244 Swan Lane, Hindley Green, Wigan, UK, WN2 4EY

alphason

4125BLK

Q16413-AI_r0



PLACE LABEL
Q14171-SK
HERE



01942 524 100



customer.services@armourhome.co.uk



Armour Home Electronics, Units 7 & 8, Stortford Hall Industrial Park,
Dunmow Road, Bishops Stortford, Hertfordshire, UK, CM23 5GZ

4125BLK

Thank you for purchasing this chair. Please inspect all parts prior to assembly and contact us if there are any damaged or missing components. This must be done before attempting assembly.

Pre-assembly preparation

Please check the pack contents before attempting to assemble this product. A full checklist of components is given in this leaflet. If any components are missing, please contact the retailer from whom you bought this product.

This product is **HEAVY**, it should be assembled as near as possible to the point of use. **TAKE CARE WHEN LIFTING** to avoid personal injury and (or) damage to the product.

This product takes approximately **20 MINUTES** to assemble with **1 PERSON**.

The fittings pack contains **SMALL ITEMS** which should be **KEPT AWAY FROM YOUNG CHILDREN**.

Read this leaflet in full before commencing assembly to ensure safe and satisfactory operation of this product.

Safety Instructions

Never drag furniture when moving it, always lift it.

Periodically check all fixings to ensure none have come loose and re-tighten where necessary.

Please take care when handling or moving the furniture as careless handling may cause damage or injury.

Furniture can be dangerous if incorrectly installed. Assembly should be carried out by a competent person. No liability will be accepted for damage or injury caused by incorrectly installed or assembled furniture.

It is recommended that before moving heavy objects to a new location they are completely dis-assembled to avoid personal injury or damage to the furniture. Please be careful to retain all fittings when doing this.

Never tilt the chair. Ensure the chair is always placed firmly on the ground.

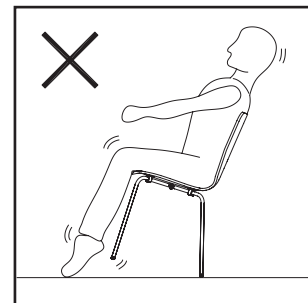

WARNING :

Sit on the chair to use the weight of the body to tighten the joint on the column and the seat.

Please note this is not a permanent fit due to the rise & fall and 360 degree turning action.

Always take care and keep feet clear of base when moving / lifting this product.

Do not stand on chair as this may cause serious injury.

Do not use the chair if any part appears damaged, broken or missing.

Do not use the chair unless all components are correctly fitted and adjusted.

Only trained personnel may replace or repair seat height adjustment components with energy accumulators.

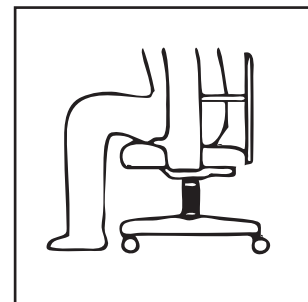

PLEASE KEEP THESE INSTRUCTIONS FOR FUTURE REFERENCE

ARMOUR HOME ACCEPTS NO LIABILITY FOR ANY DAMAGE CAUSED THROUGH INCORRECT OR INAPPROPRIATE USE OF THIS PRODUCT.

4125BLK

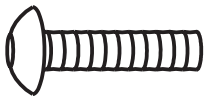
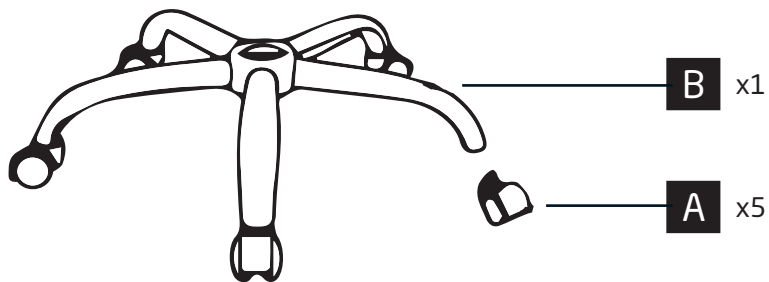
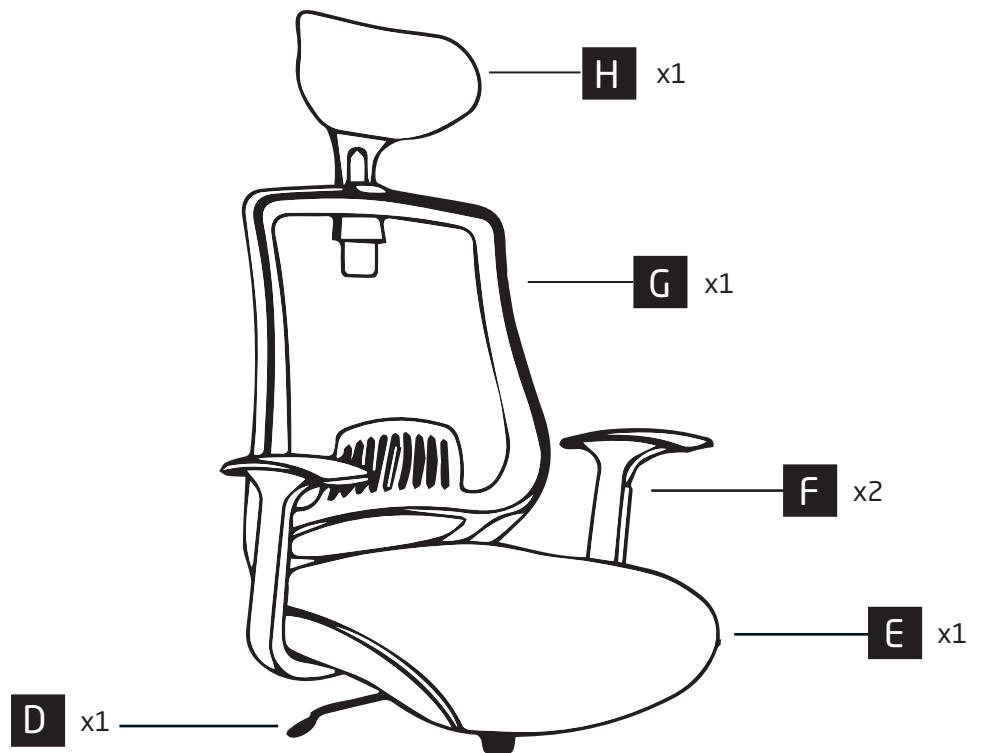

I x8
M6 x 35mm

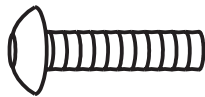

J x2
M6 x 25mm

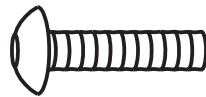

K x2
M6 x 20mm



L x10
M6 x 18x1mm

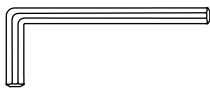

M x1

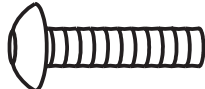

N x2
M6 x 40mm

4125BLK

