

1773096PCOMUK-White

1773196PCOMUK-Black

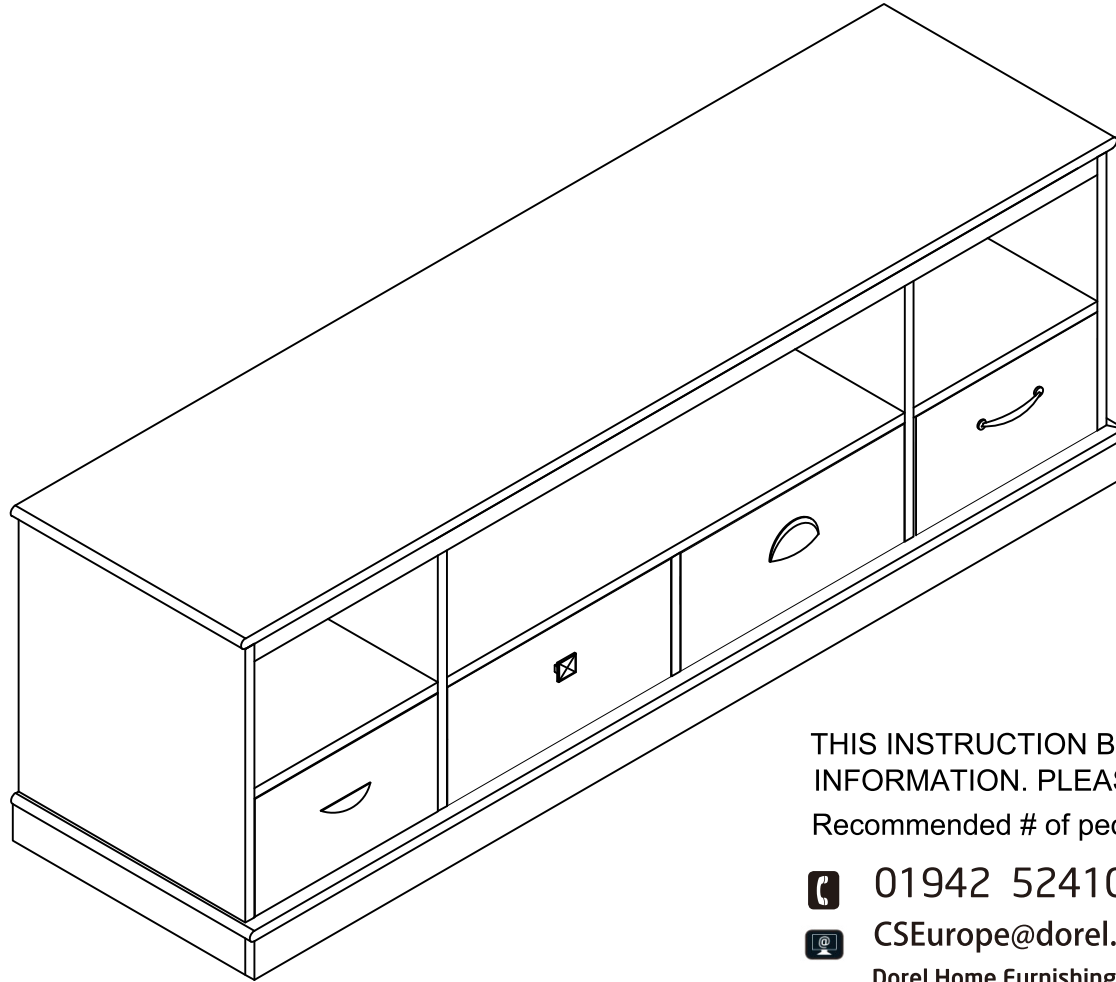

PLACE LABEL
Q16714-SK
HERE

THIS INSTRUCTION BOOKLET CONTAINS
INFORMATION. PLEASE READ AND KEEP FOR FUTURE REFERENCE.

Recommended # of people needed for assembly:2



01942 524100



CSEurope@dorel.com



Dorel Home Furnishings Europe Ltd. Building 4, Imperial Place
Maxwell Road, Borehamwood WD6 1JN, United Kingdom

B341773096PCOM02

Before starting

- ❑ Read each step carefully before starting. It is very important that each step of instruction is performed in the correct order. If these steps are not followed in sequence, assembly difficulties will occur.
- ❑ Make sure all parts are included. Most board parts are labeled or stamped on the raw edge.
- ❑ Work in spacious area, preferably on a carpet, near the place the unit will be used.
- ❑ Have the following tools close at hand.
- ❑ Do not use power tools to assemble your furniture. Power tools may strip or damage the parts.

HELPFUL HINTS

- Identify, sort and count the parts before attempting assembly.
- Call our toll free number if you need assistance identifying parts.
- Compression dowels are tapped in with a hammer.
- Slides have lips only on the right side.
- Cam locks that are properly fastened on a horizontal board will face toward the center of the unit, on a vertical board the point on the lock will face the bottom.
- Back panels provide stability and support. Use all the nails provided.
- When tapping nails into a board, be sure there are equal margins on all sides to square the unit.
- Units without the back panel installed may collapse.
- Clean the product with your favorite furniture polish and a soft cloth. DO NOT USE harsh chemicals or abrasive cleaners.
- Move your new furniture carefully, with two people lift and carry the unit to it's new location.
- Never push, drag or scoot your furniture (especially on carpet).
- Your furniture can be disassembled and reassembled to move.
- Additional parts are available for a nominal fee.

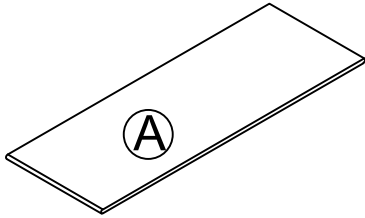

Top shelf

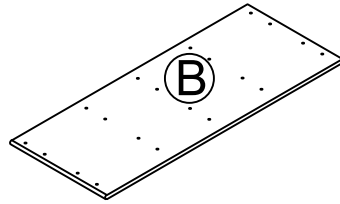

Bottom shelf

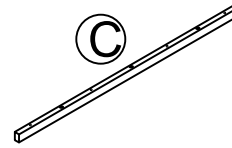

Top shelf apron

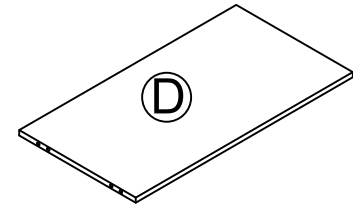

Center fixed shelf

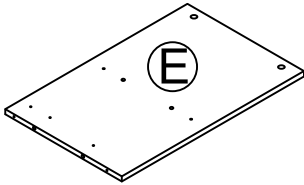

Left side panel

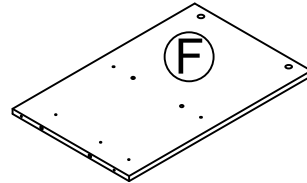

Right side panel

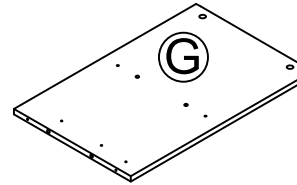

Left partition

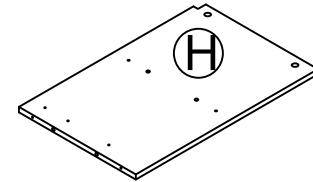

Right partition

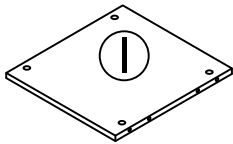

Fixed shelf (2)

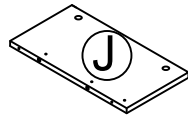

Partition

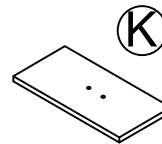

Drawer front

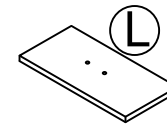

Drawer front

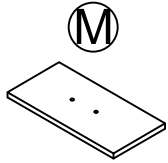

Drawer front

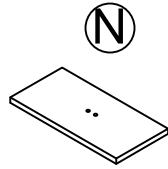

Drawer front

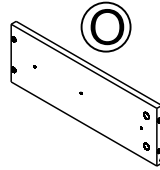

Drawer left side panel (4)

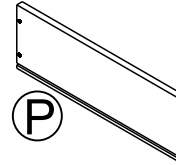

Drawer right side panel (4)

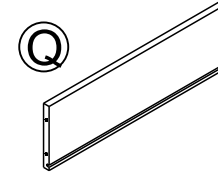

Drawer back panel (4)

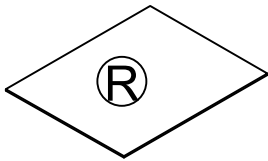

Drawer bottom (4)

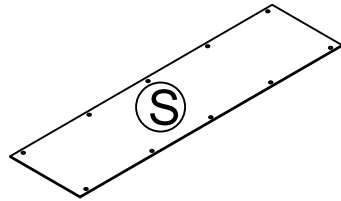

Back panel

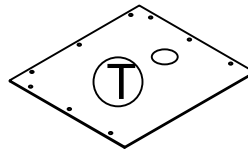

Back panel (2)

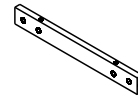

Side panel(2)

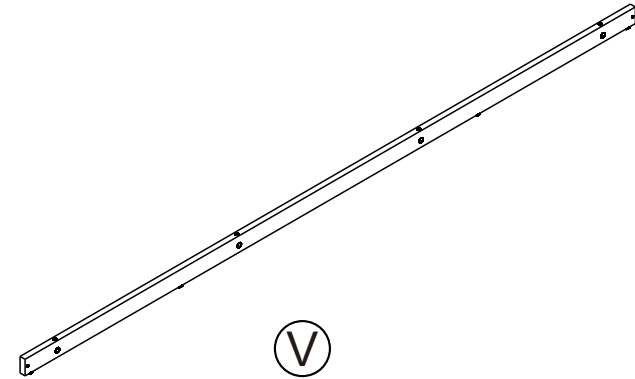

Front and back base panel(2)

PARTS

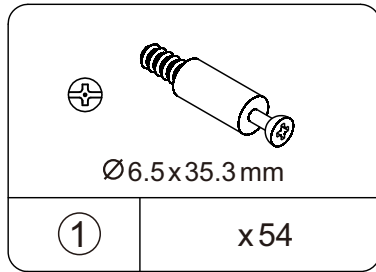

Cam bolt

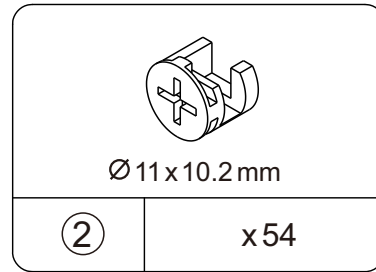

Cam lock

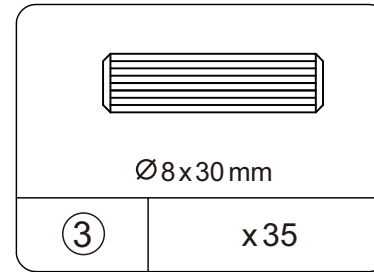

Wooden dowel

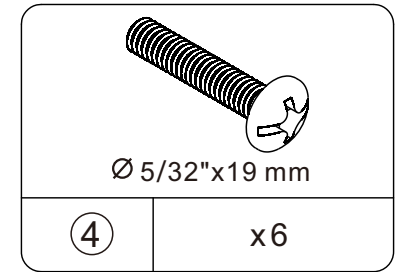

Screw

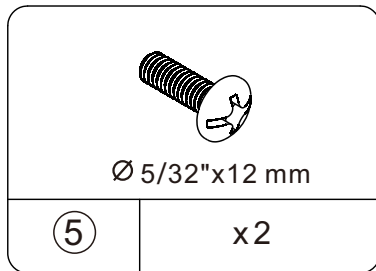

Screw

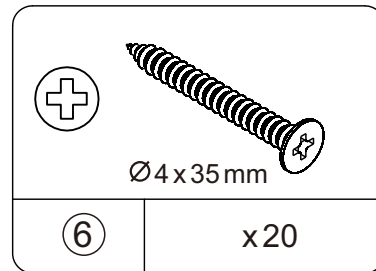

Screw

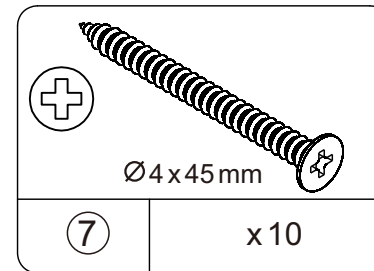

Screw

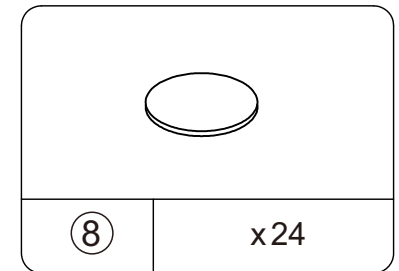

Cover cap

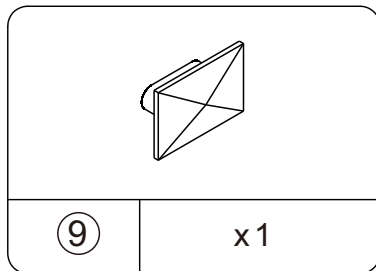

Knob

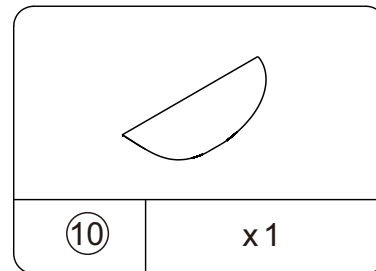

Pull

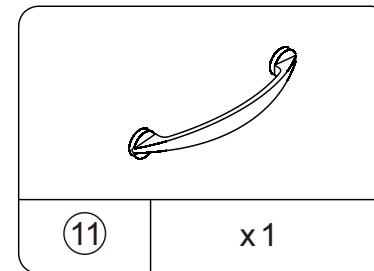

Pull

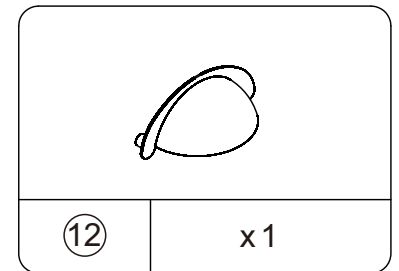

Handle

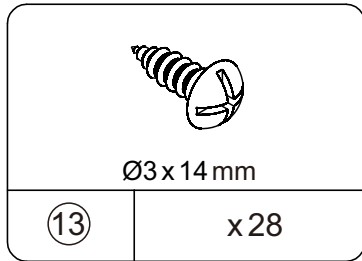

Screw

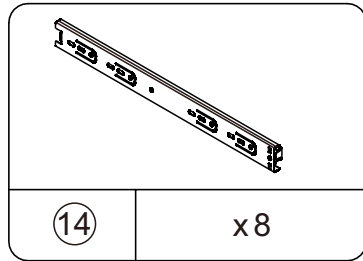

Drawer runner

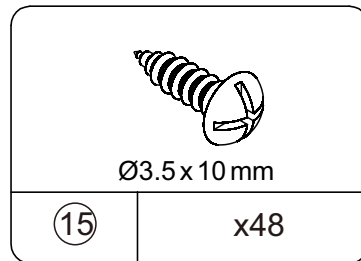

Screw

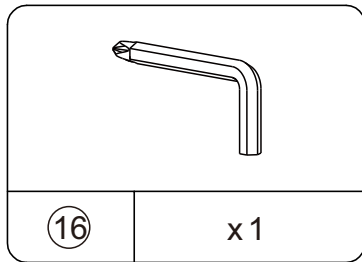

Allen key

This illustration shows how the CAM fastener system works.

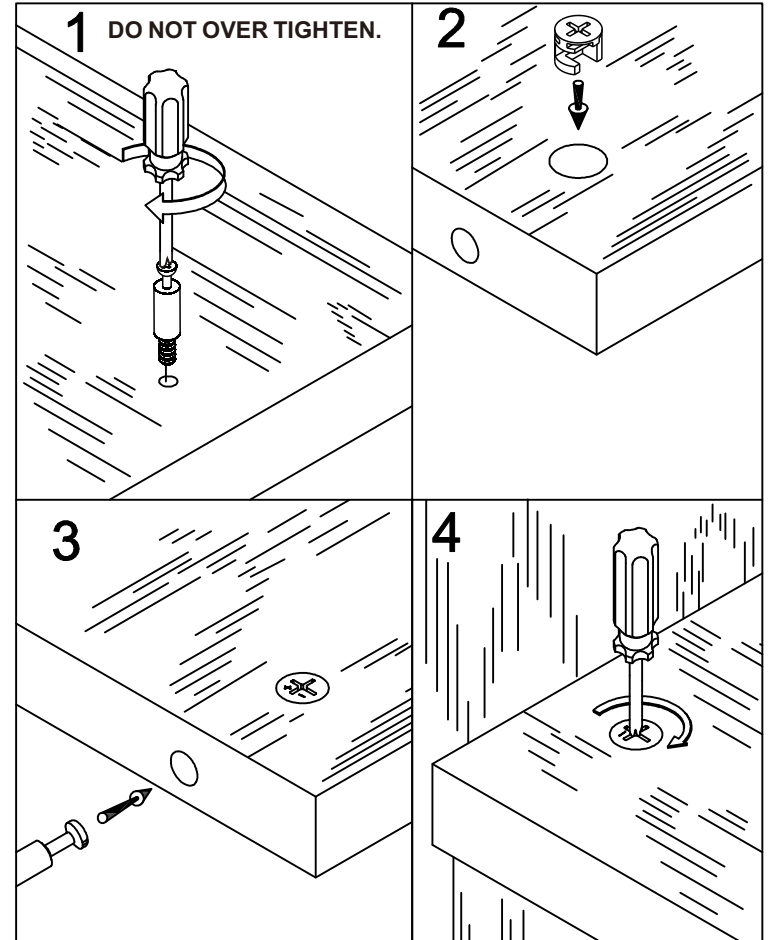

1

Do not over tighten.

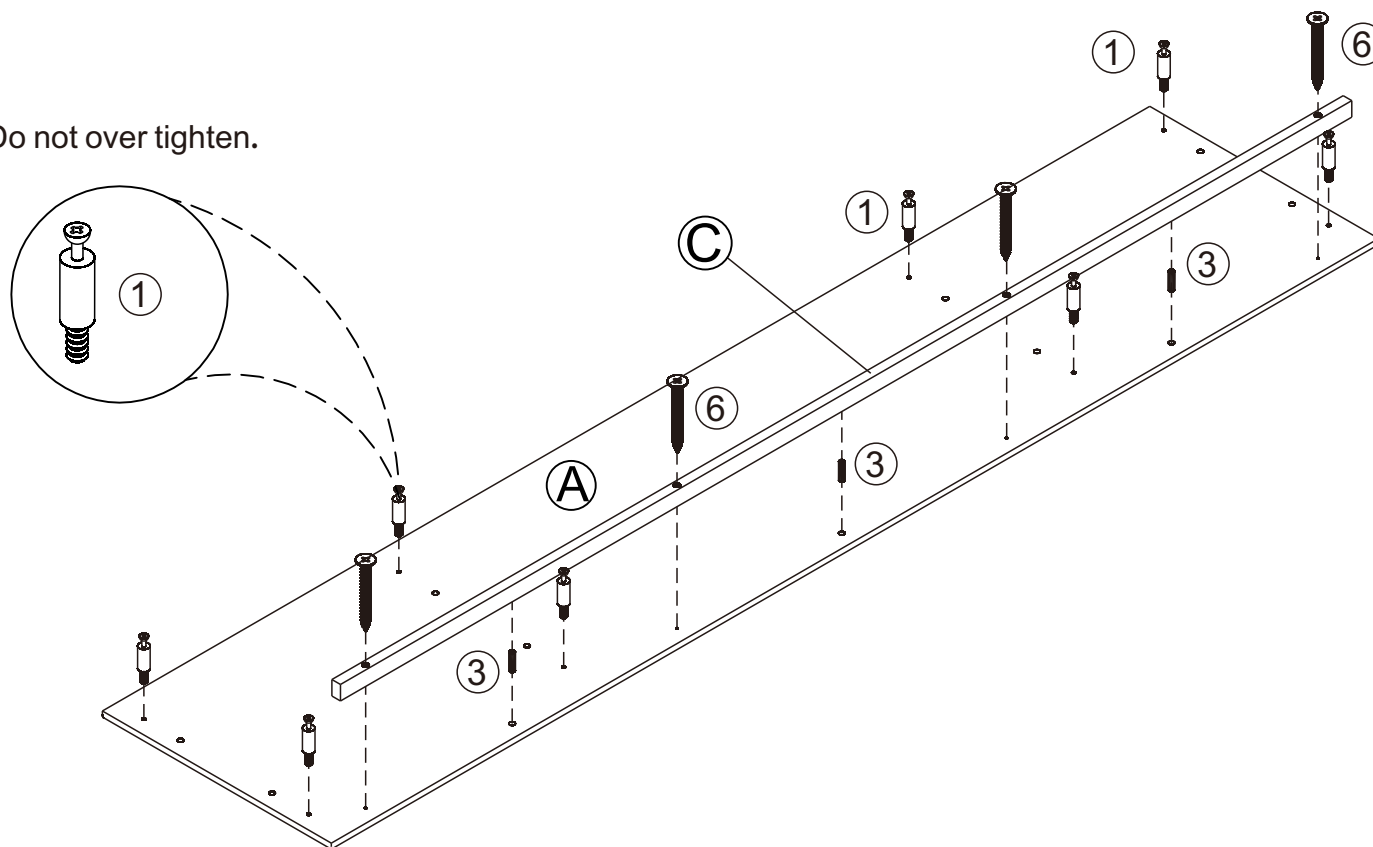
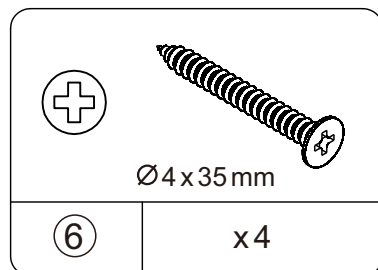
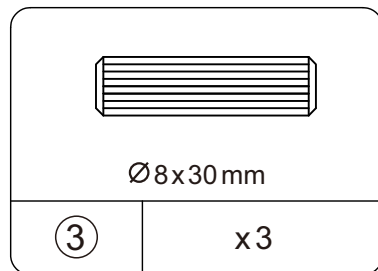
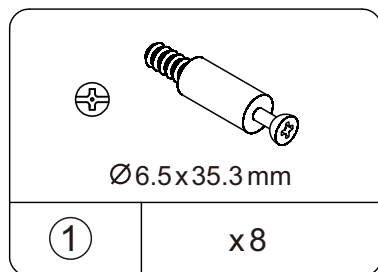

2

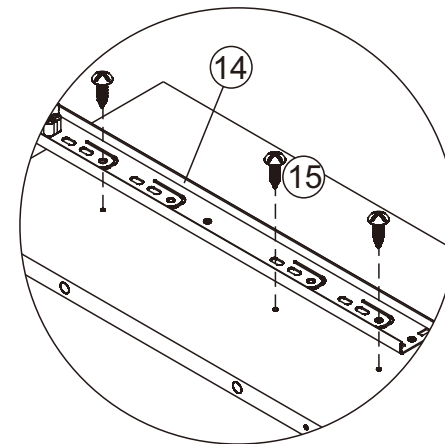
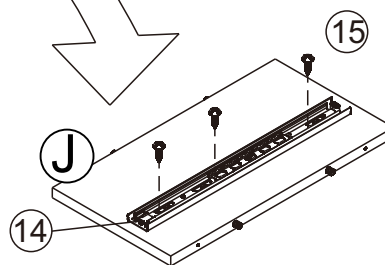
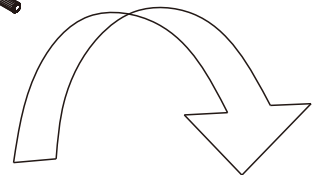
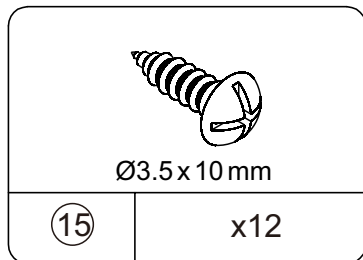
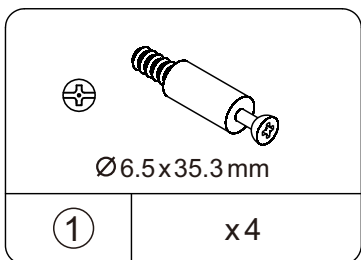
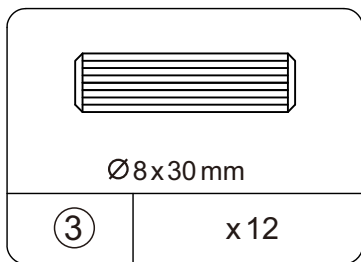
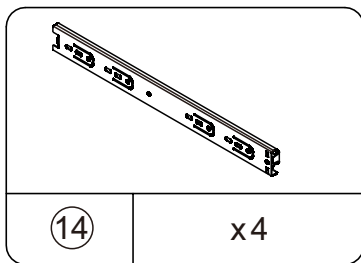
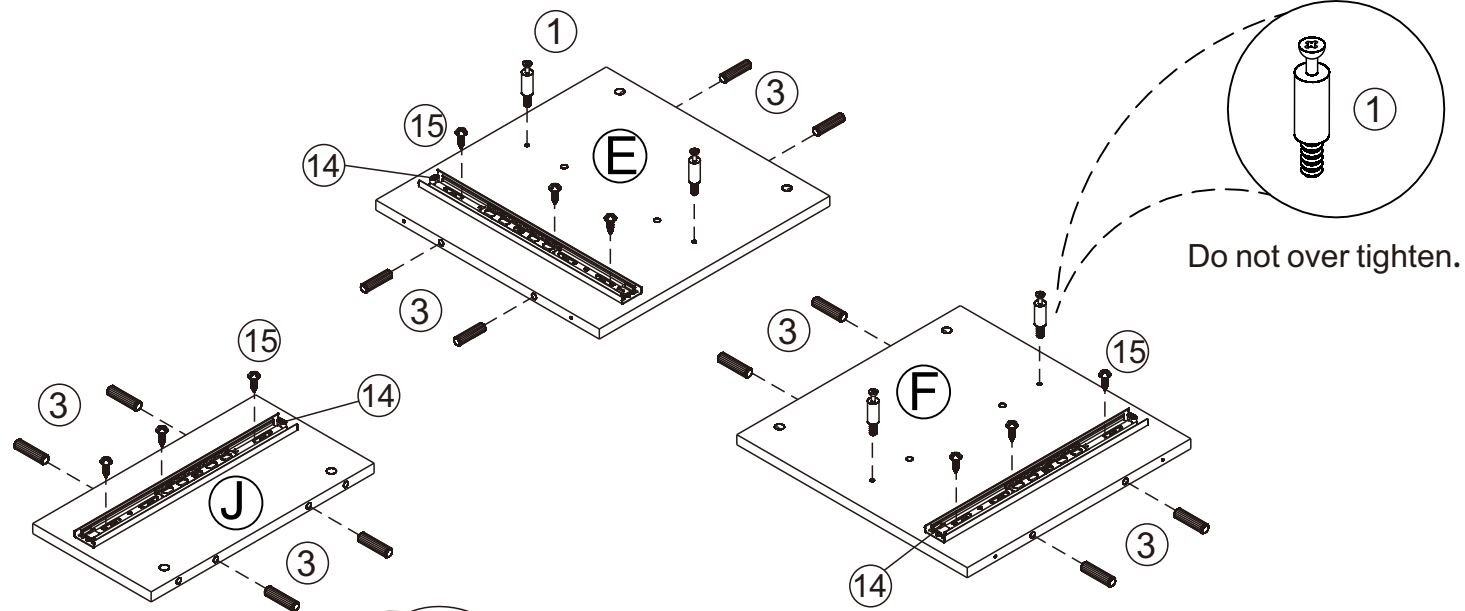

Do not over tighten.

3

Do not over tighten.

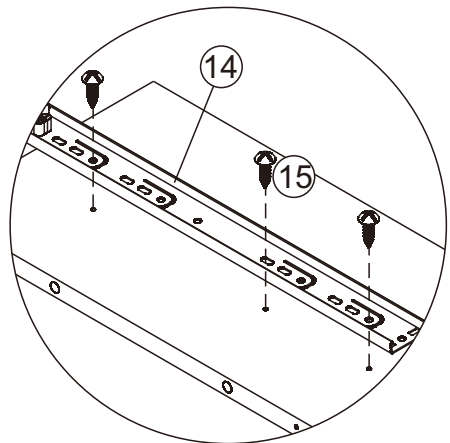
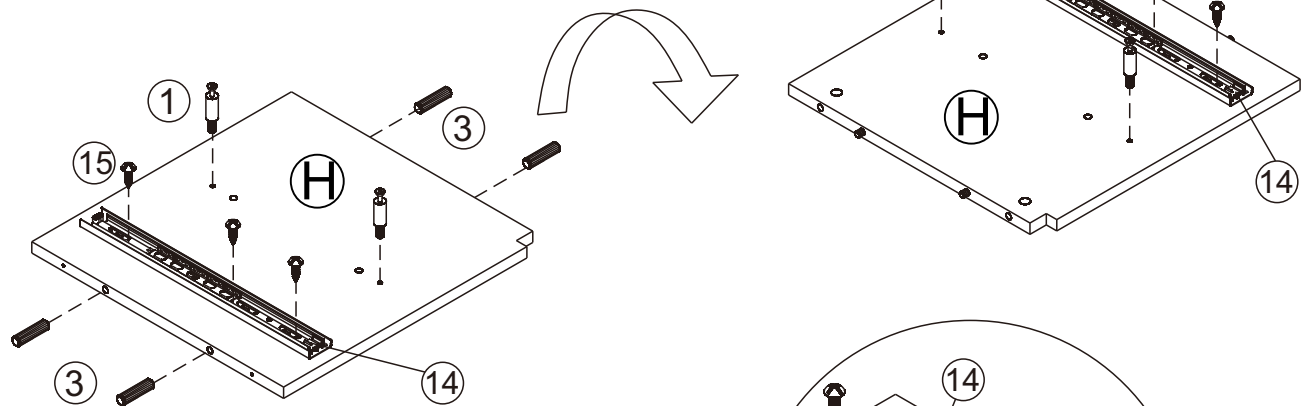
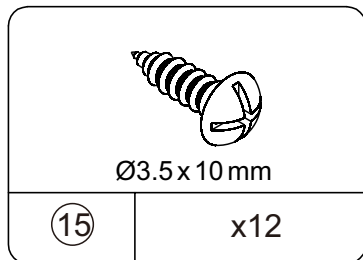
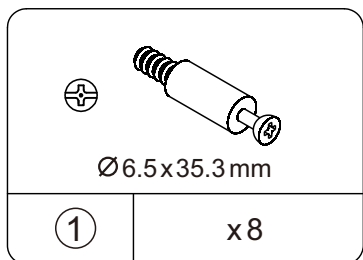
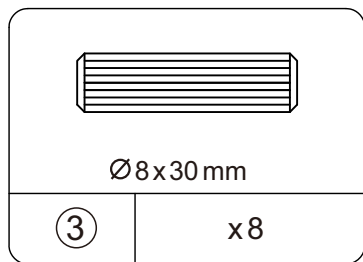
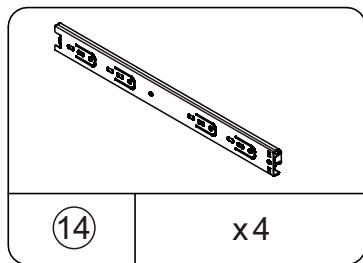
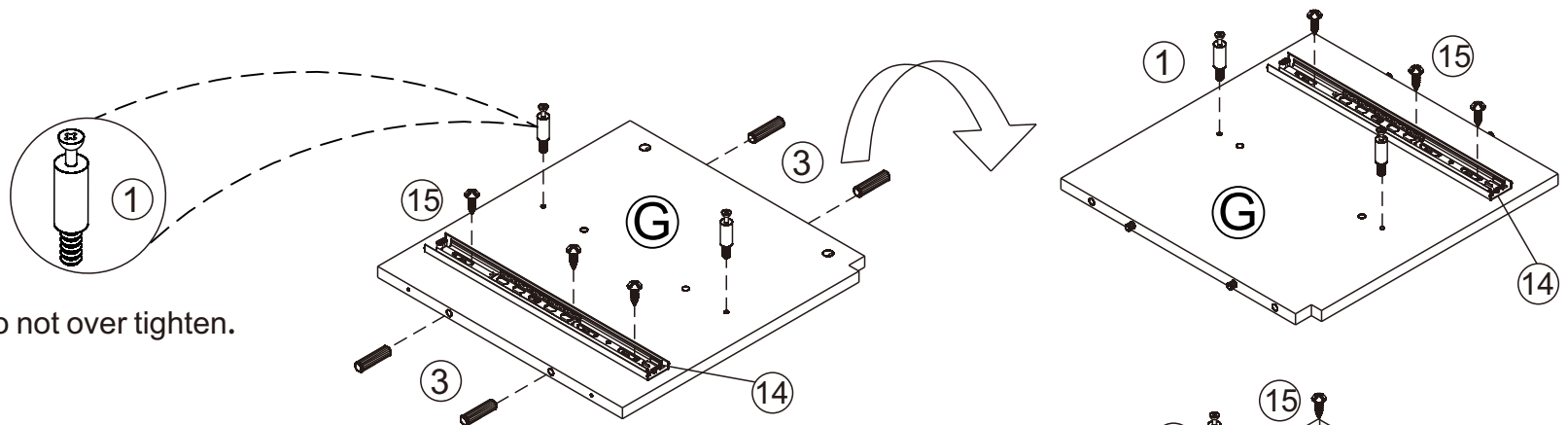

4

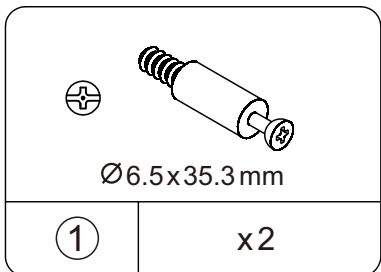
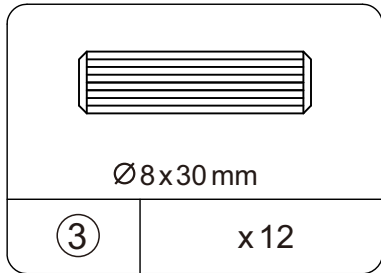
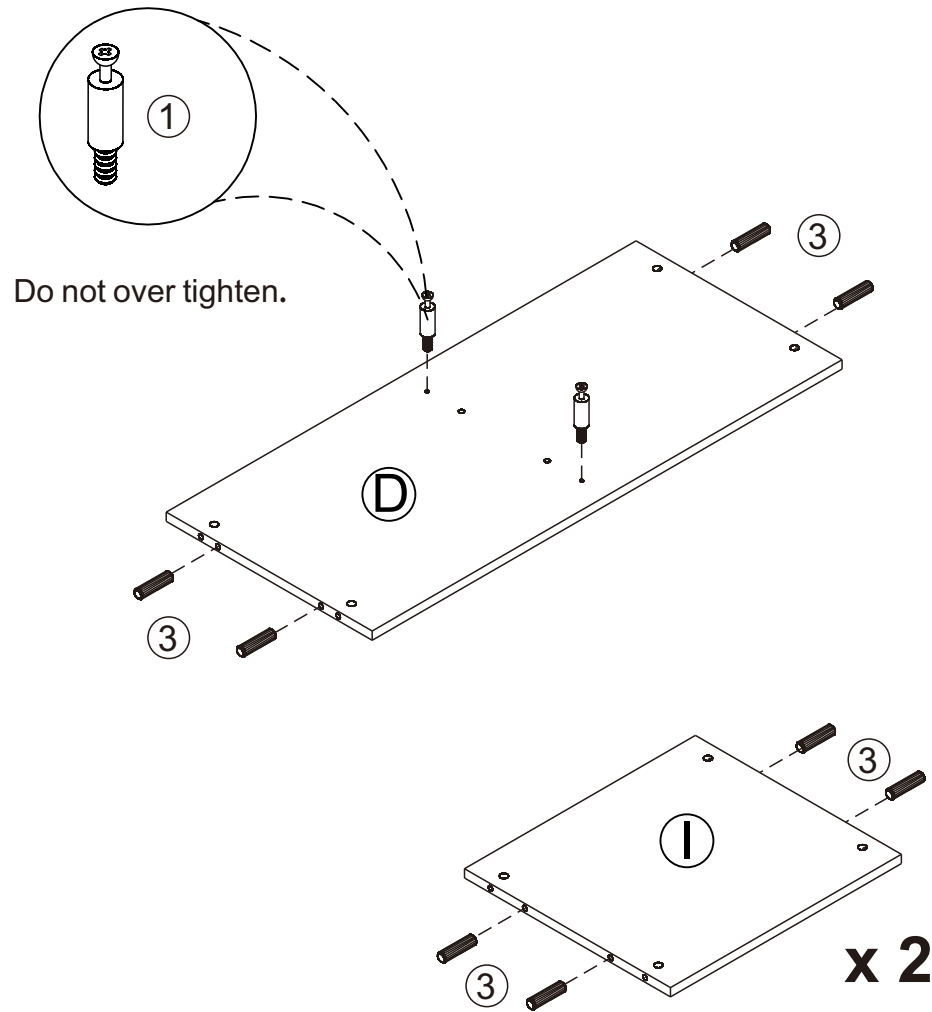

5

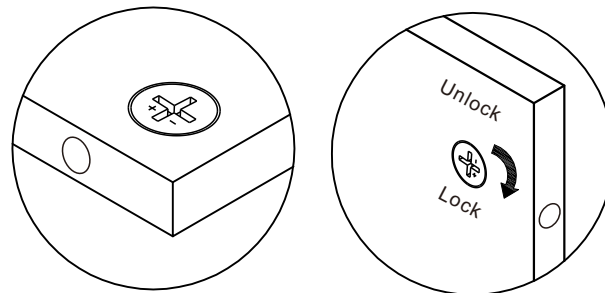
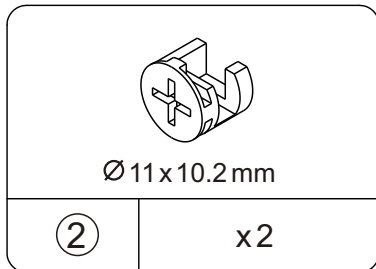
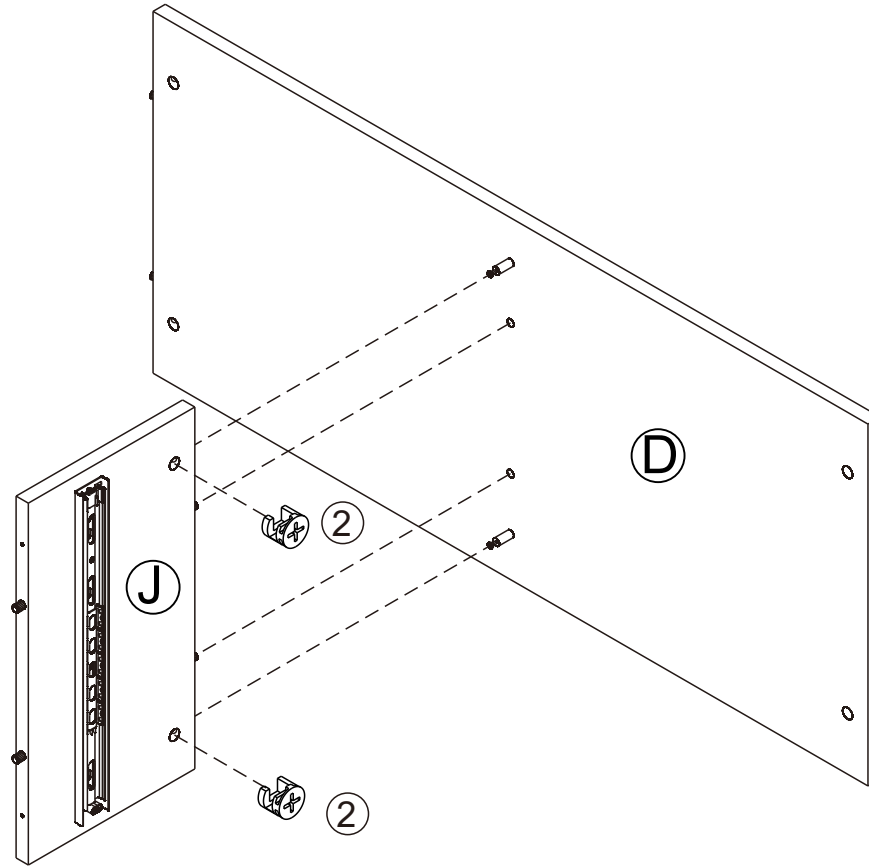

Proper orientation of cam lock.

6

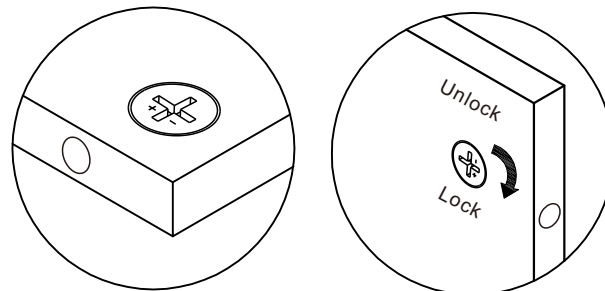
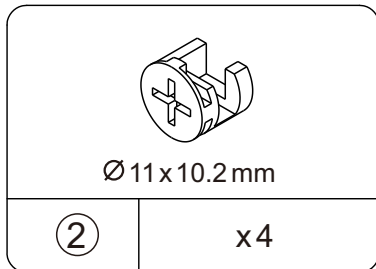
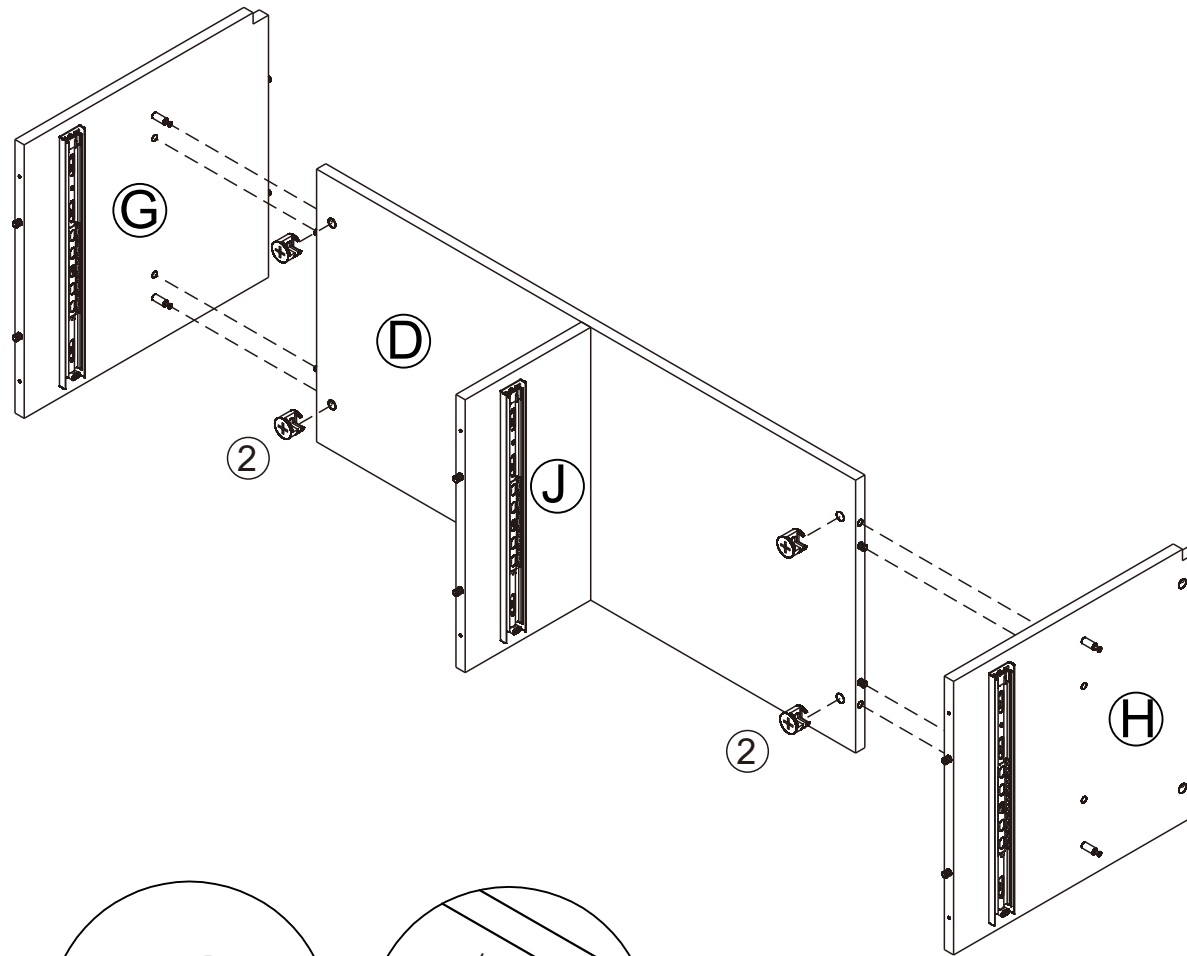

Proper orientation of cam lock.

7

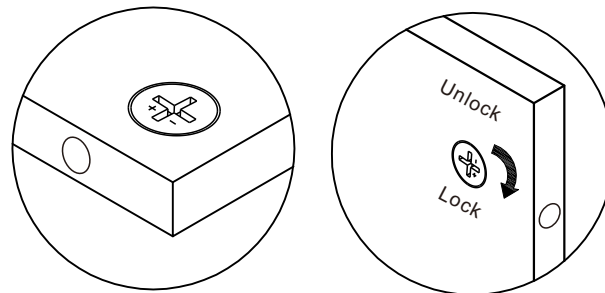
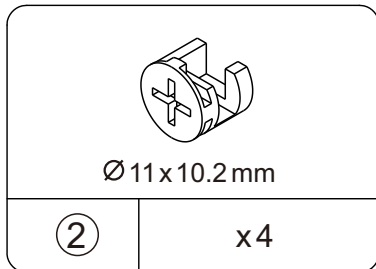
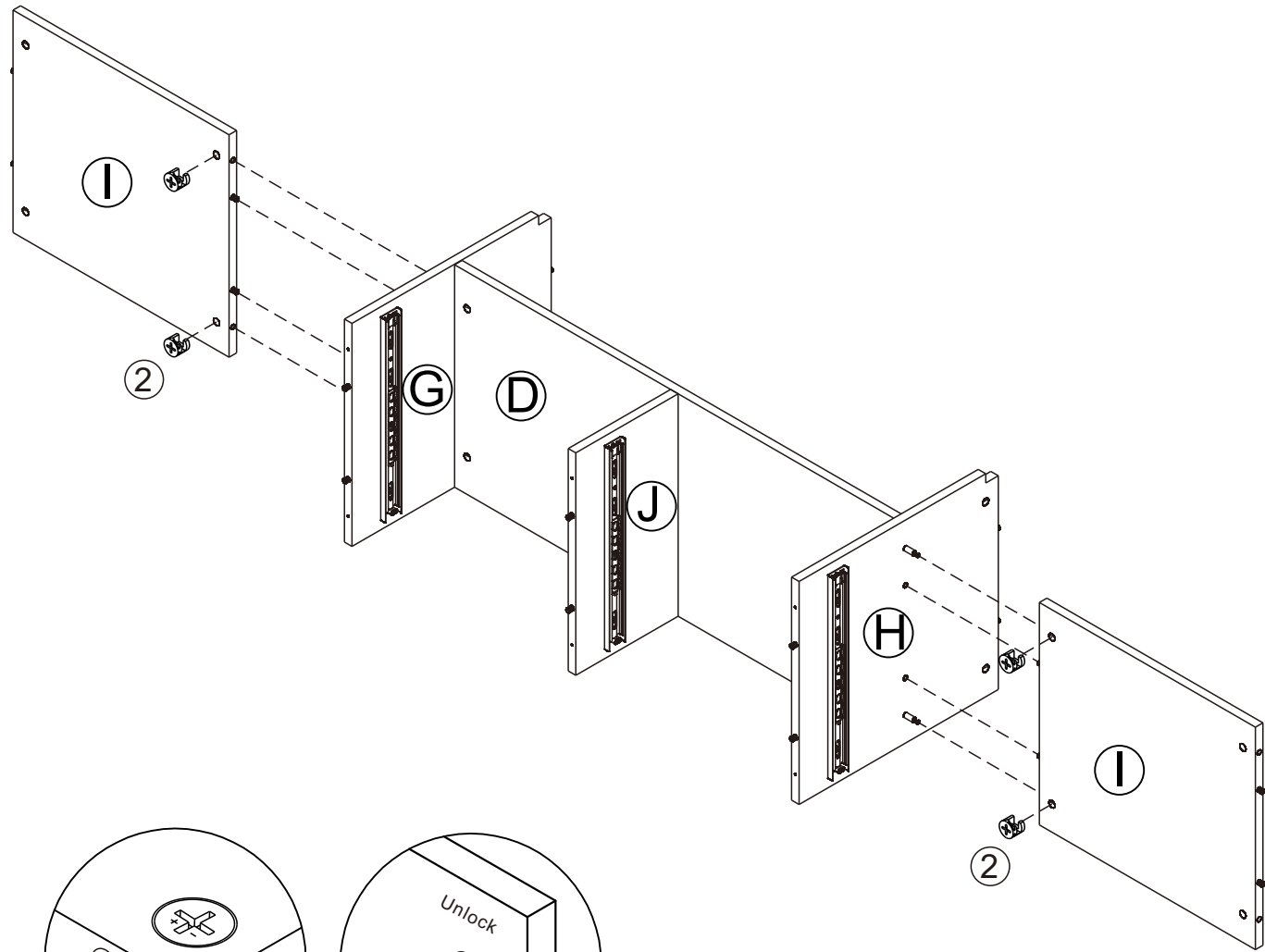

Proper orientation of cam lock.

8

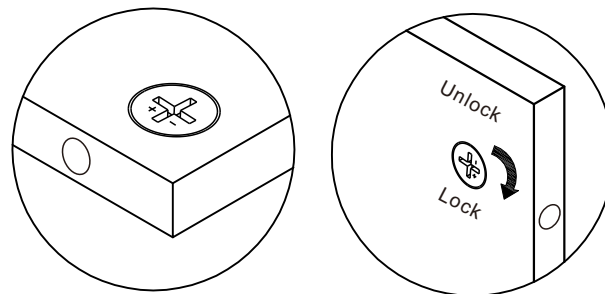
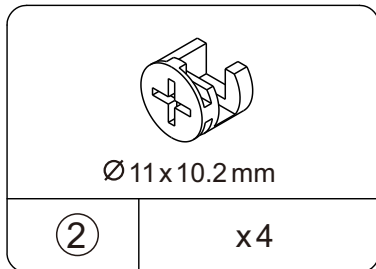
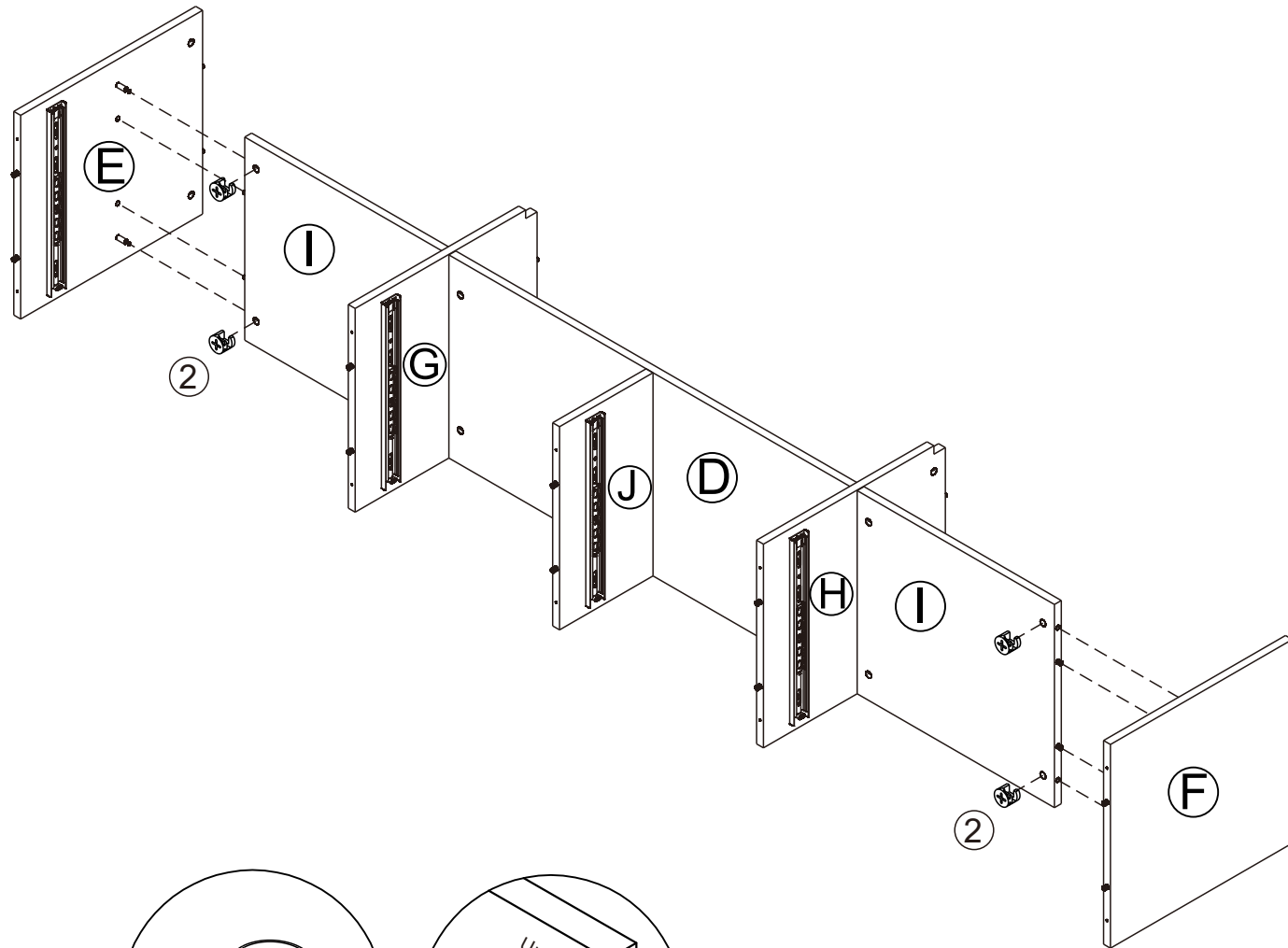

Proper orientation of cam lock.

9

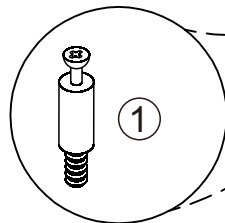
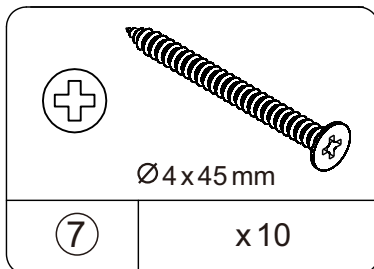
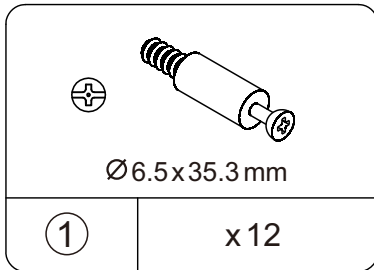
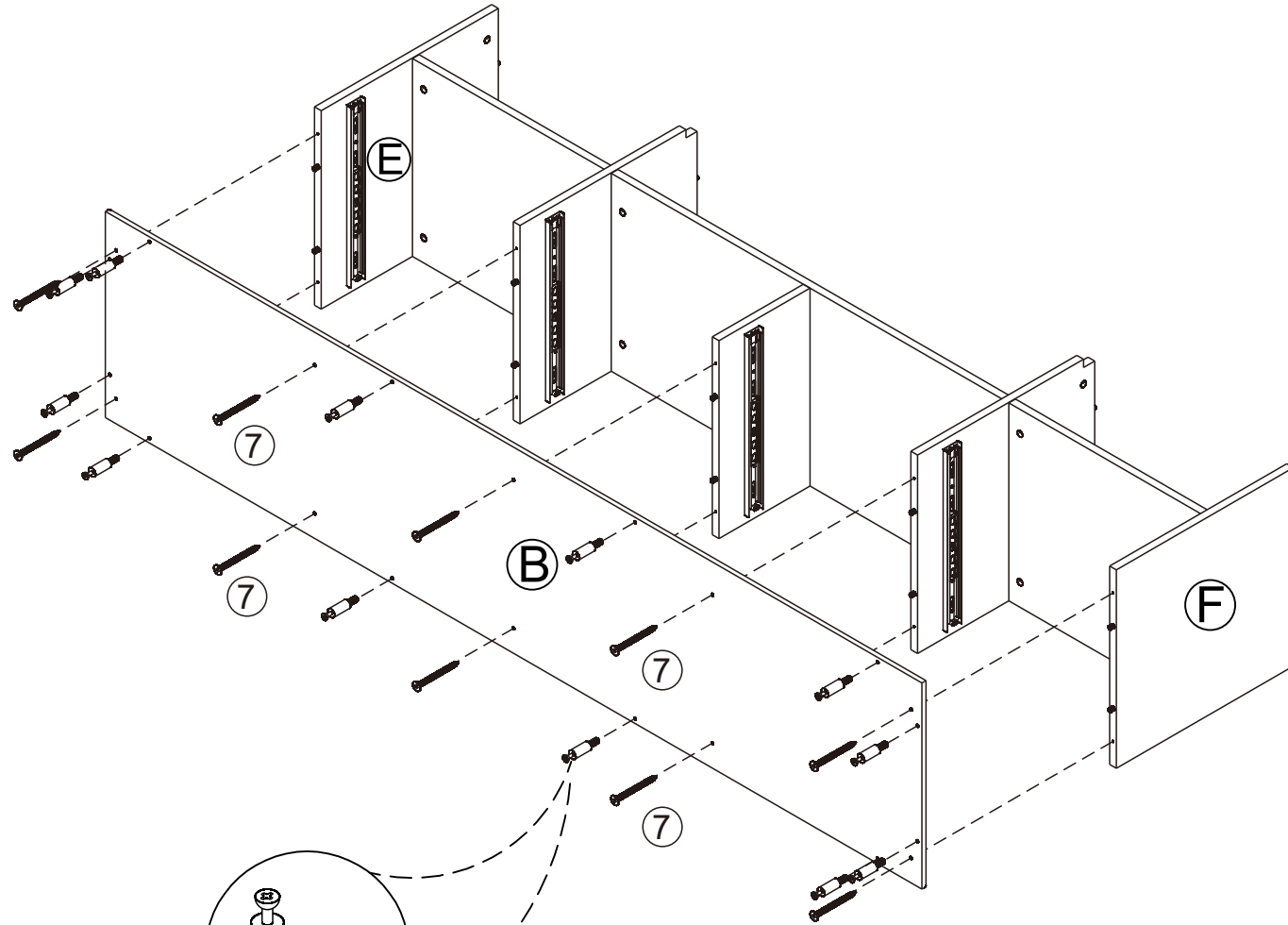

Do not over tighten.

10

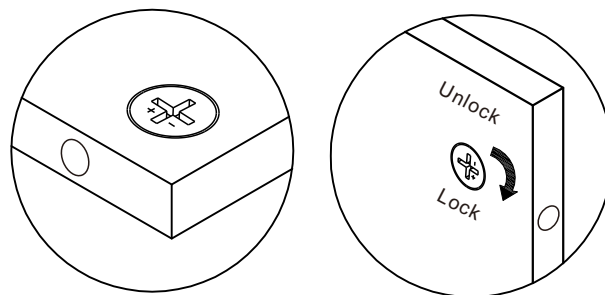
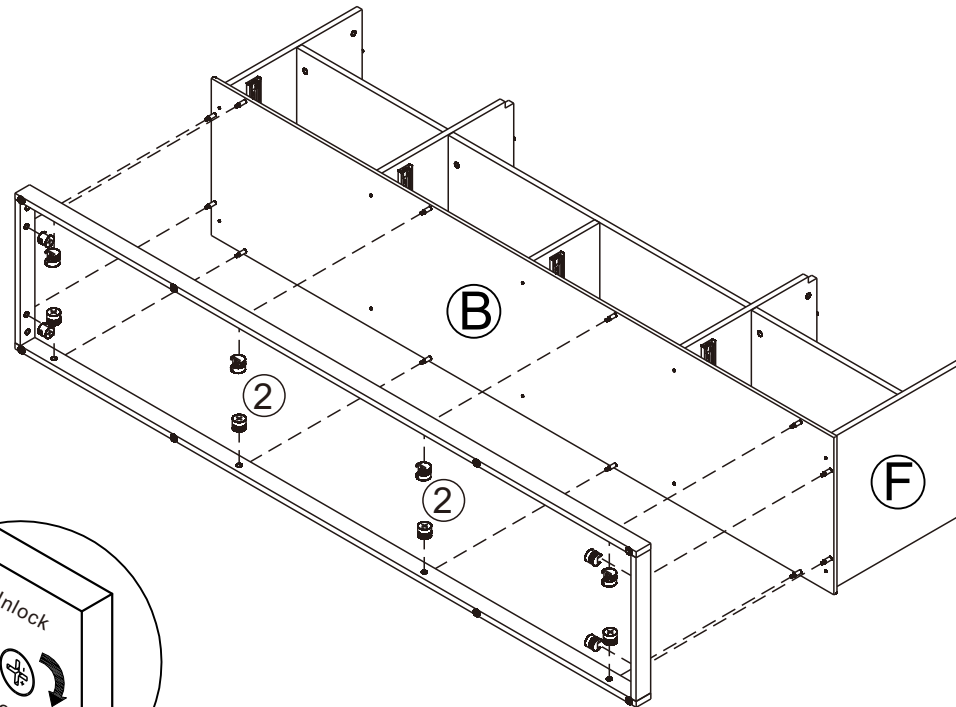
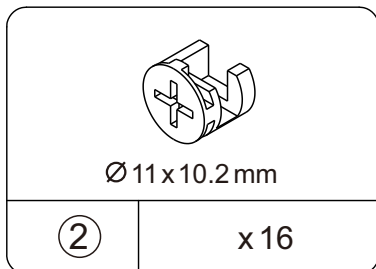
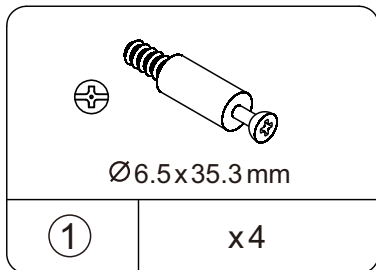
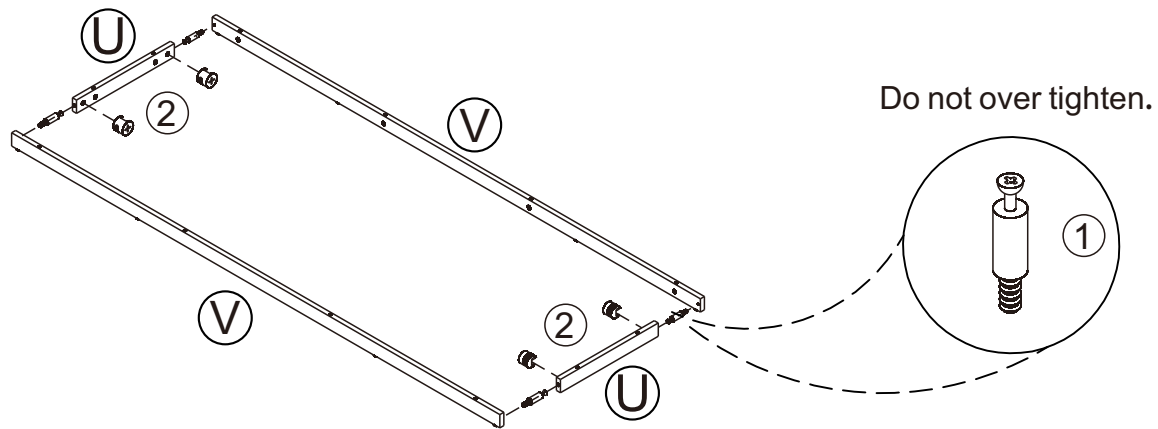

Proper orientation of cam lock.

11

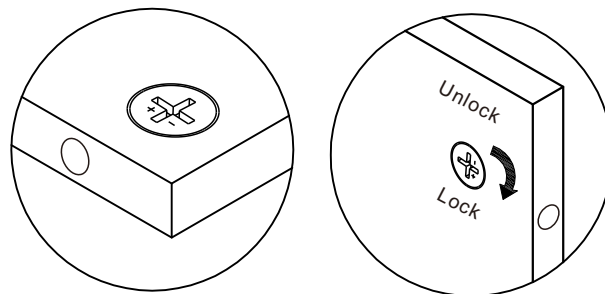
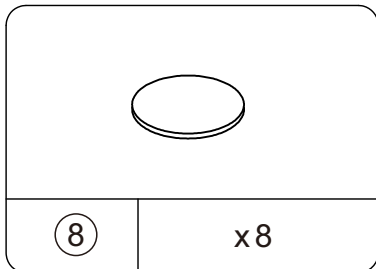
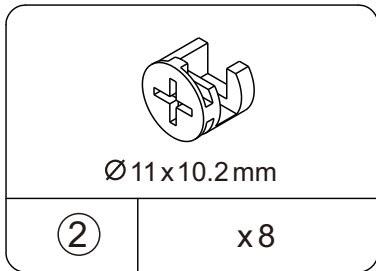
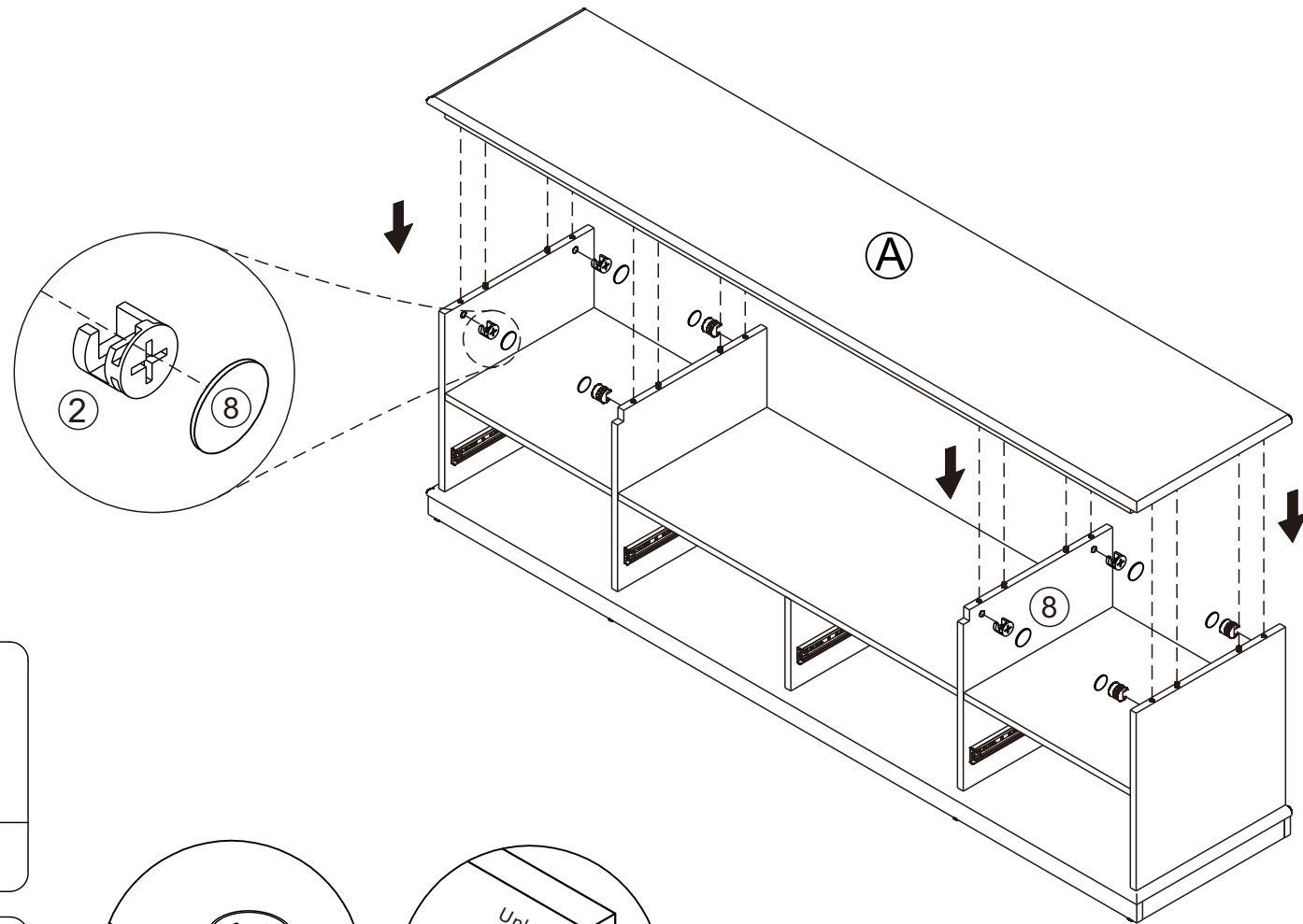

Proper orientation of cam lock.

12

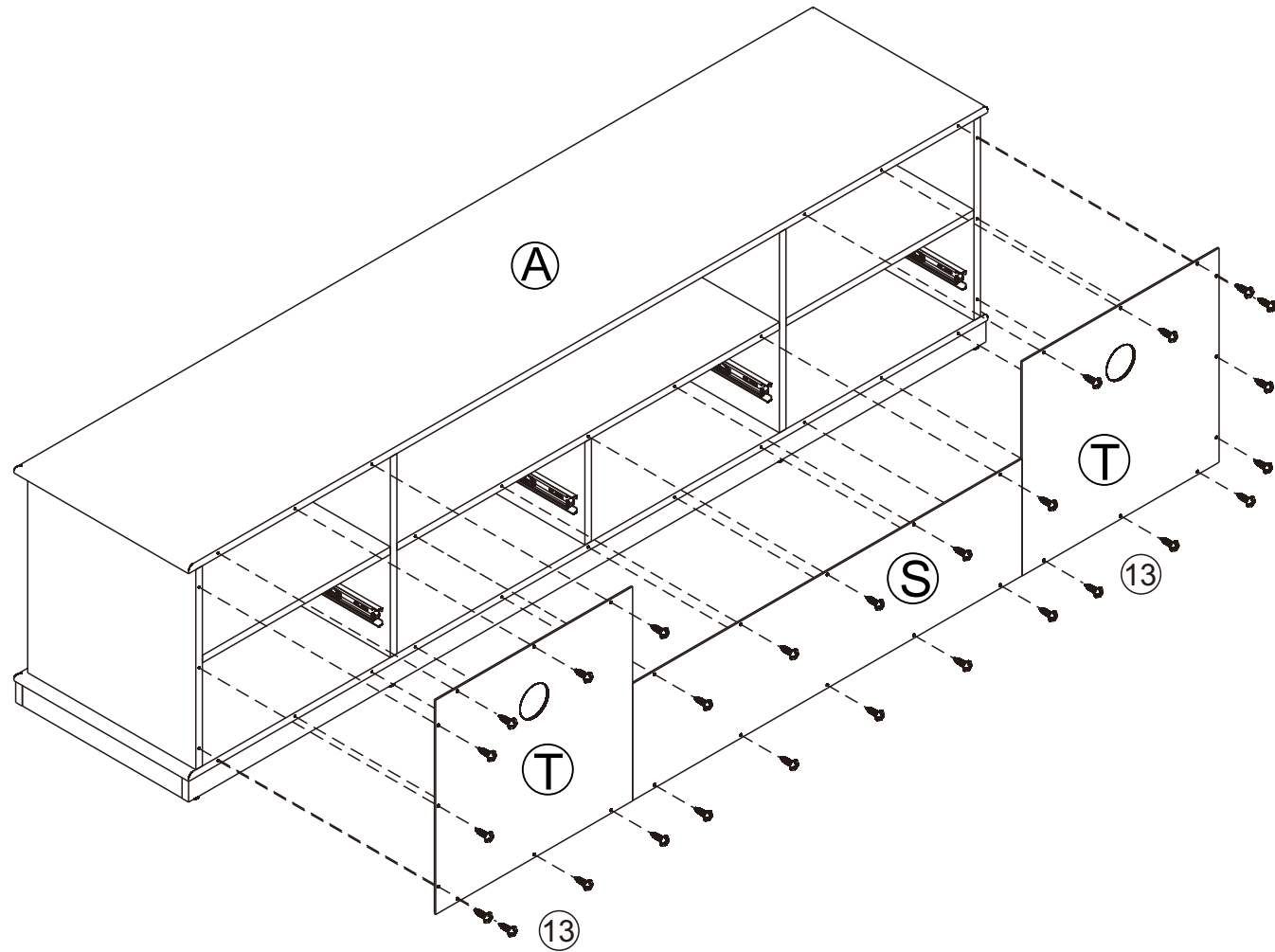

Ø3x14 mm

13

x28

13

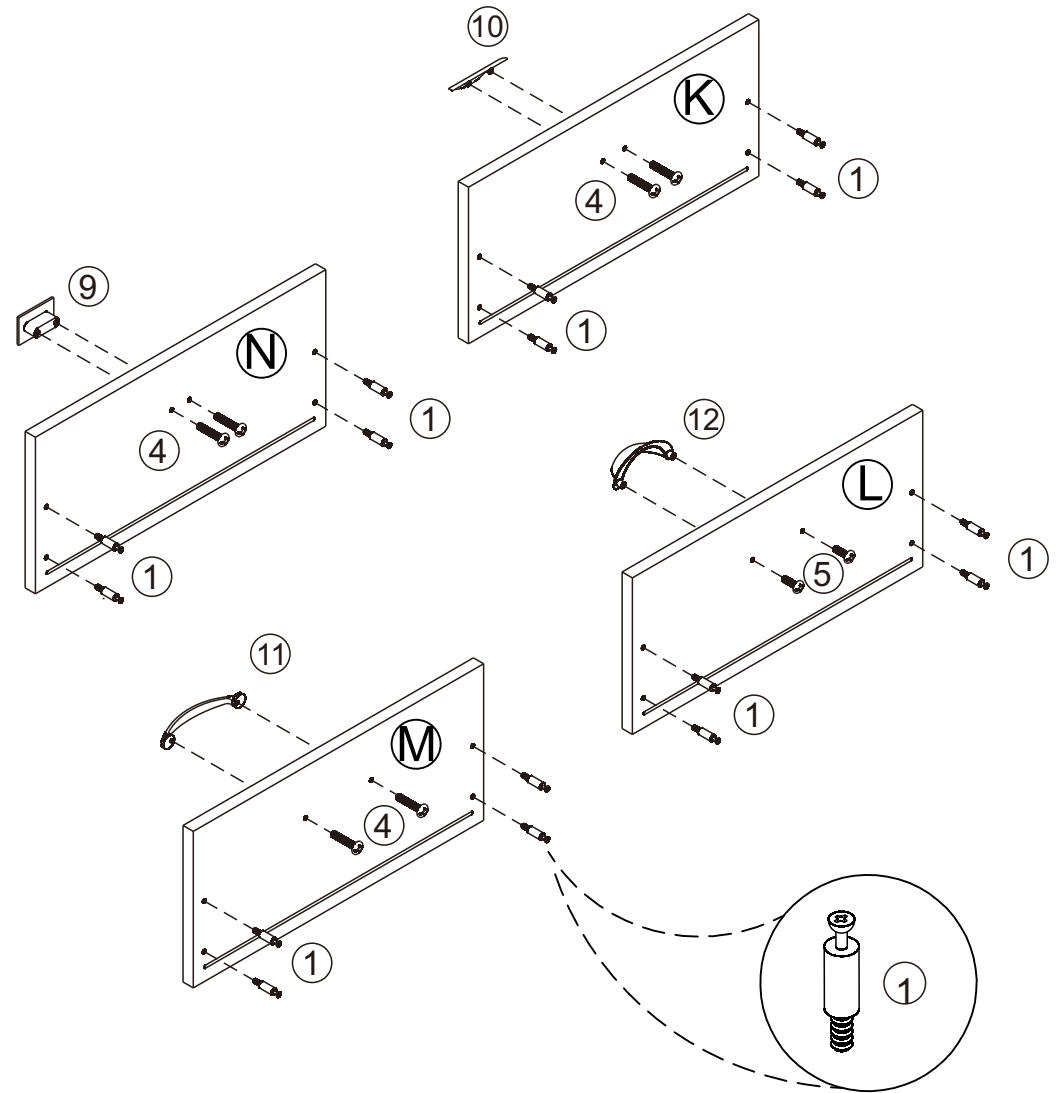
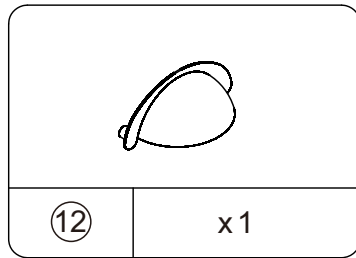
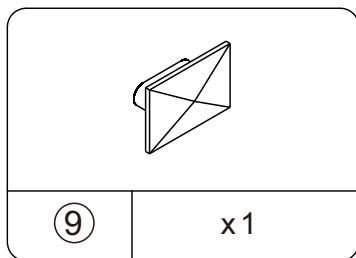
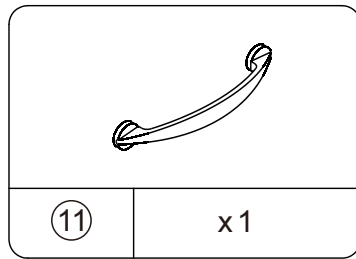
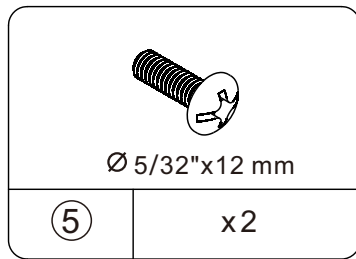
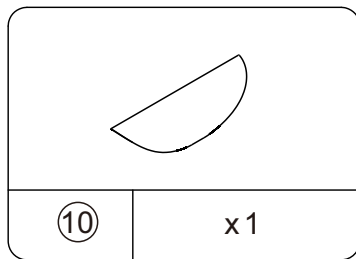
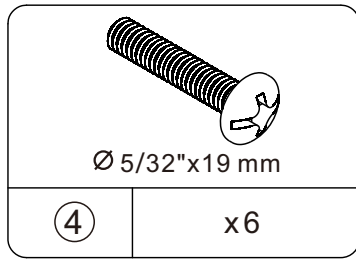
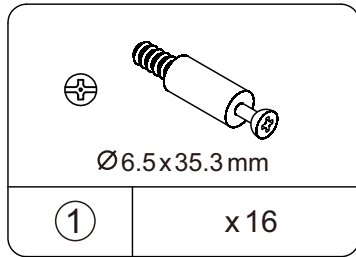

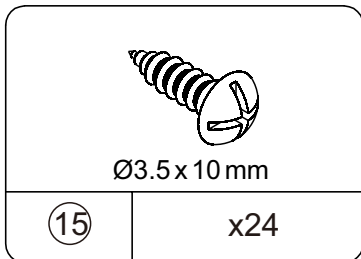
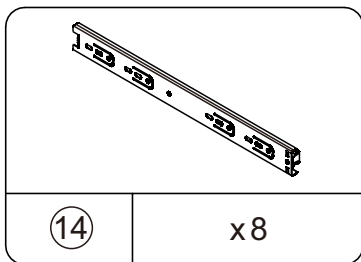
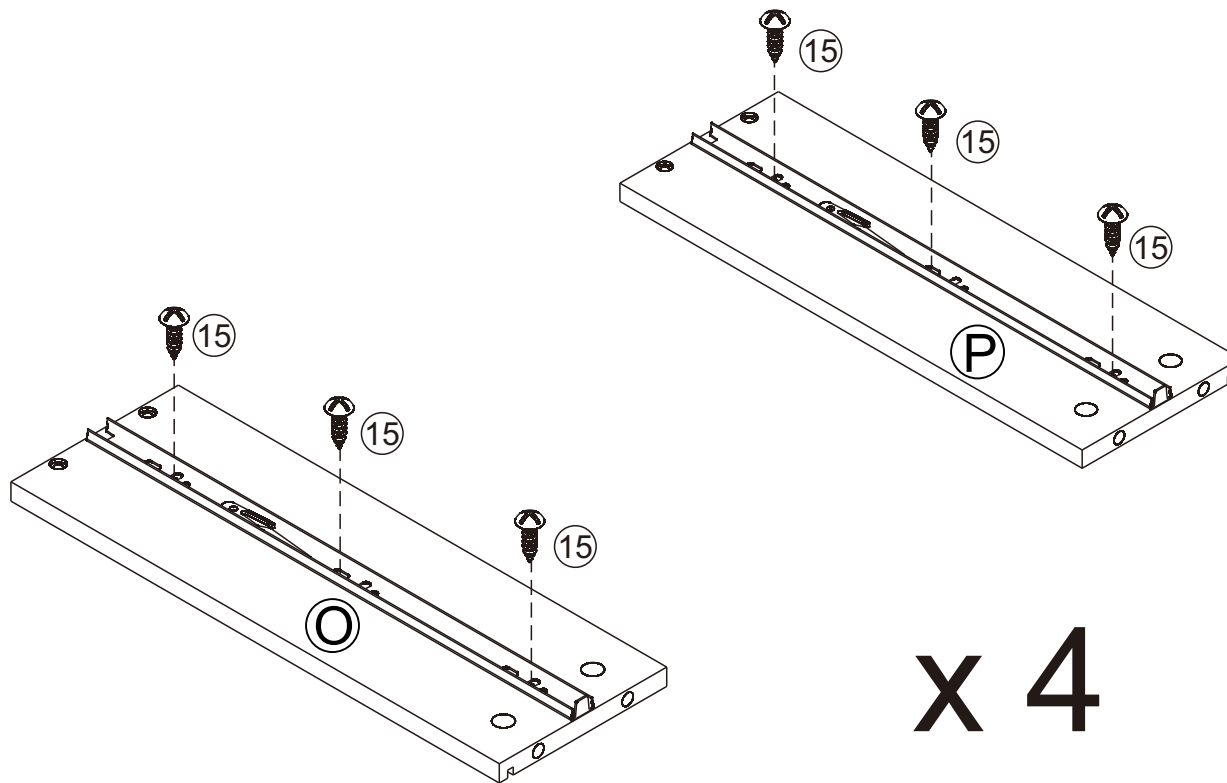

14

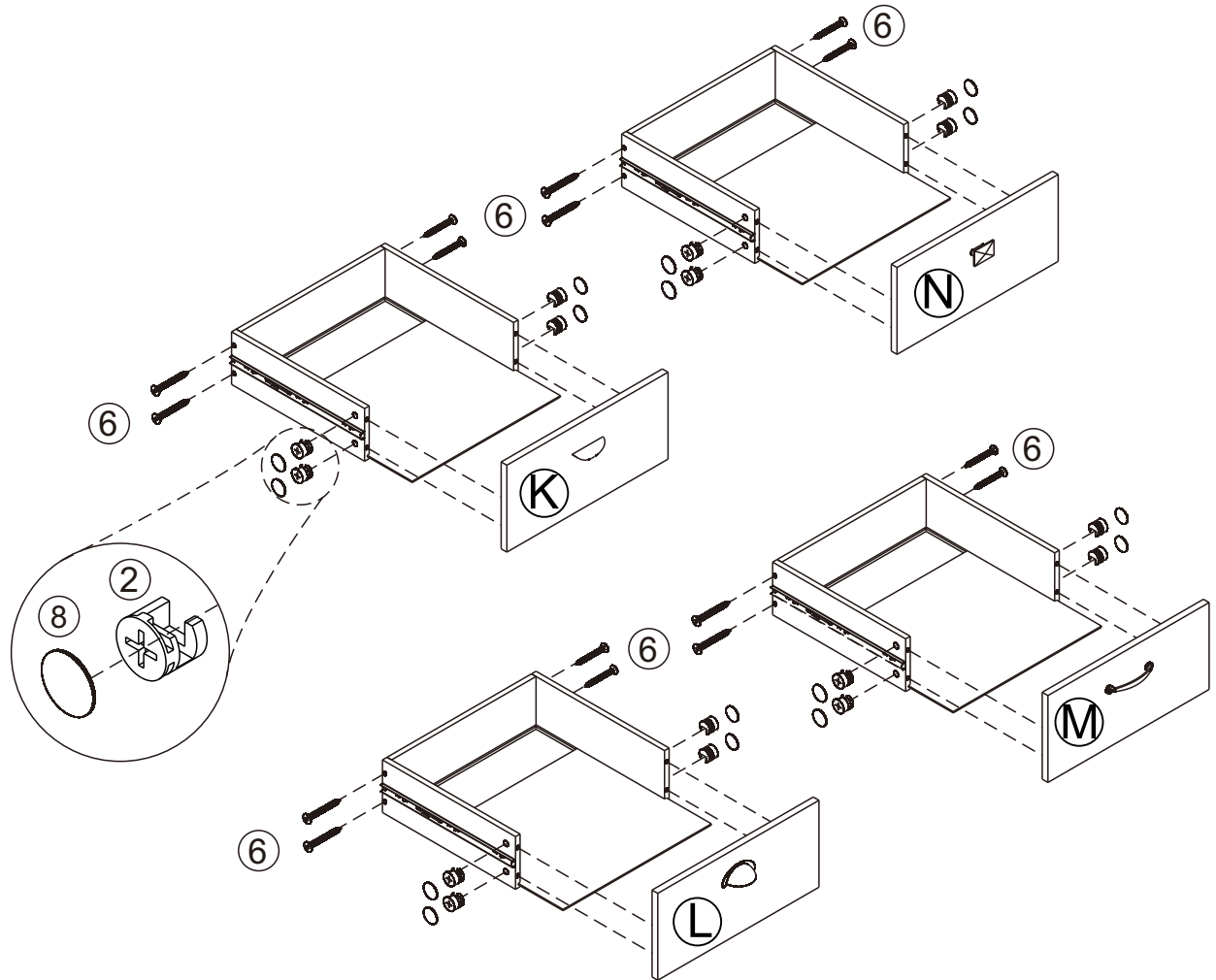

15

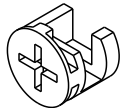

 Ø11x10.2mm	
②	x 16

 Ø4x35mm	
⑥	x 16

	
⑧	x 16

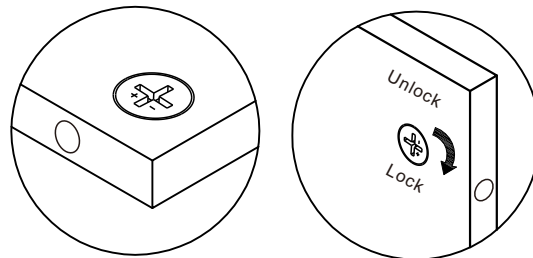

Proper orientation of cam lock.

16

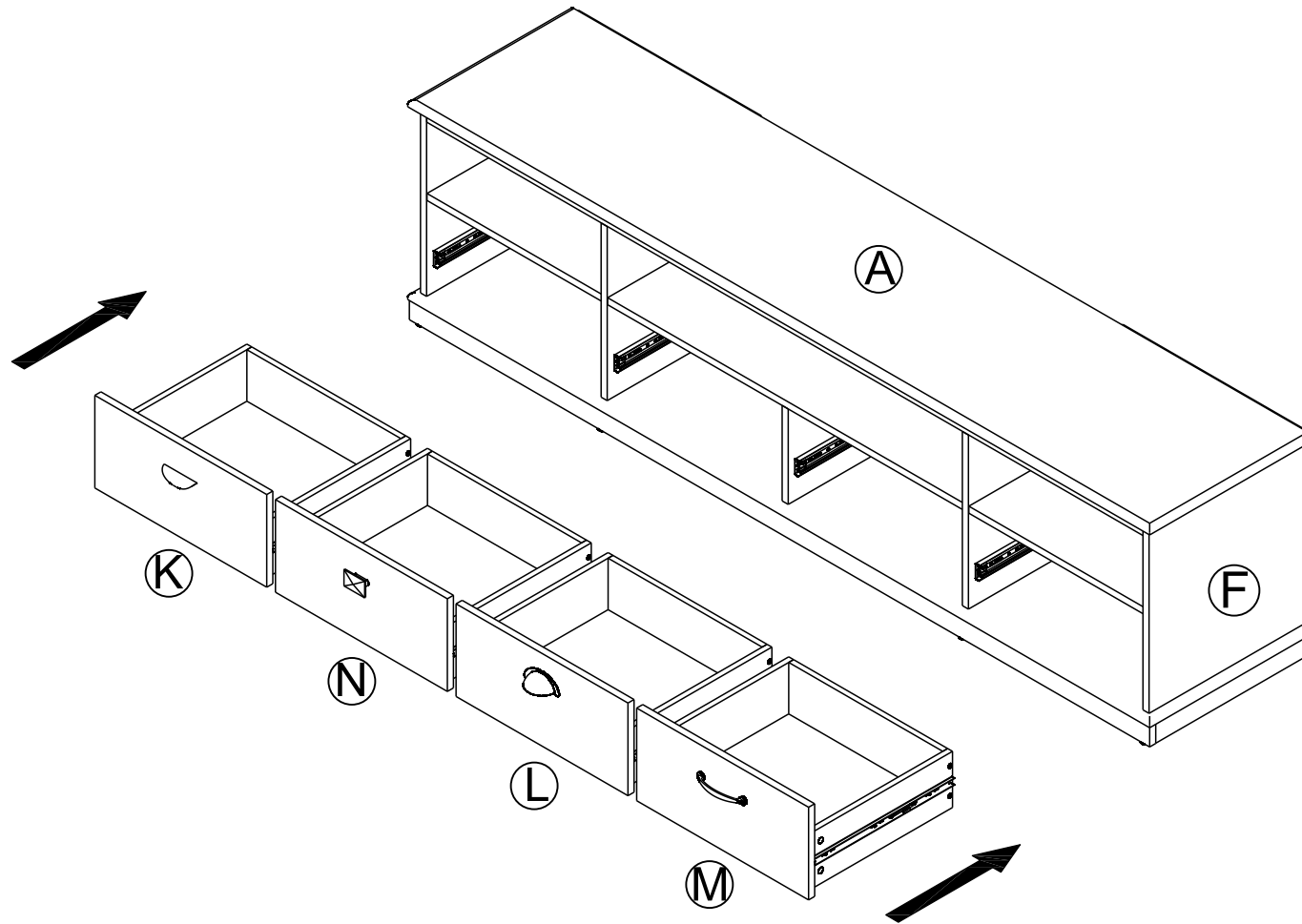

WEIGHT LIMITS:

This unit has been designed to support the maximum loads shown. Exceeding these load limits could cause sagging, instability, product collapse, and/or serious injury.

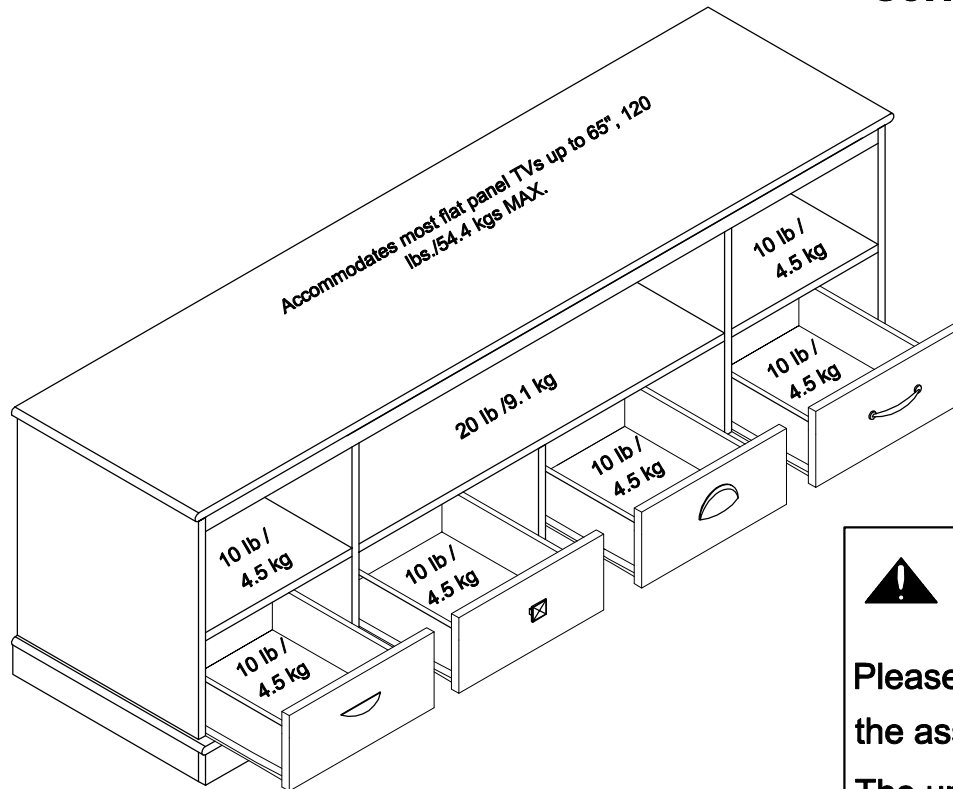

Enjoy Your Furniture

⚠ WARNING

Please make sure that all objects are removed before moving the assembled unit.

The unit must be team lifted, not dragged or pushed.

Failure to do so could cause instability, product collapse, and/or serious injury.

Mercer TV Console for TVs up to 65"



Spruce up your living room with the Ameriwood Home Blackburn TV Console with Multicolored Drawer Fronts. Featuring 4 drawers that are each finished in a different woodgrain and color, this unique TV Console will be the centerpiece of your room.

- Bring an artistic accent to your living room or family room with the Mercer TV Console with Multicolored Drawer Fronts for flat paneled TVs up to 65" wide and 120 lbs.
- This TV Console features 4 multicolored door fronts, each one slightly different than the next that can be arranged in any order and open compartments.
- The TV console has a black or white finish with woodgrain drawer fronts and interchangeable handles.

Mercer TV Console for TVs up to 65"



1773196PCOMUK Black EAN: 5060669110422



1773096PCOMUK White EAN: 5060669110378

Product	Height: 476mm	Shipping	Height: 1920mm
	Width: 1829mm		Width: 492mm
	Depth: 400mm		Depth: 188mm
	Weight: 46 kg		Weight: 49 kg