

Dell EMC PowerEdge T550

Installation and Service Manual

Notes, cautions, and warnings

 **NOTE:** A NOTE indicates important information that helps you make better use of your product.

 **CAUTION:** A CAUTION indicates either potential damage to hardware or loss of data and tells you how to avoid the problem.

 **WARNING:** A WARNING indicates a potential for property damage, personal injury, or death.

Chapter 1: About this document	7
Chapter 2: PowerEdge T550 system overview	8
Front view of the system.....	9
Rear view of the system.....	18
Inside the system	20
Locating the Express Service Code and Service Tag.....	21
System Information Label.....	22
Chapter 3: Initial system setup and configuration	28
Setting up the system.....	28
iDRAC configuration.....	28
Options to set up iDRAC IP address.....	28
Options to log in to iDRAC.....	29
Resources to install operating system.....	30
Options to download firmware	30
Options to download and install OS drivers	31
Downloading drivers and firmware.....	31
Chapter 4: Minimum to POST and system management configuration validation	32
Minimum configuration to POST	32
Configuration validation.....	32
Error messages.....	33
Chapter 5: Installing and removing system components	34
Safety instructions.....	34
Before working inside your system.....	35
After working inside your system.....	35
Recommended tools.....	36
Optional front bezel.....	36
Removing the front bezel.....	36
Installing the front bezel.....	37
System feet.....	37
Removing the system feet.....	37
Installing the system feet.....	38
Optional caster wheels	39
Removing caster wheels.....	39
Installing caster wheels.....	40
System cover.....	41
Removing the system cover.....	41
Installing the system cover.....	42
Air shroud.....	44
Removing the air shroud.....	44
Installing the air shroud.....	44

Cooling fans.....	45
Removing a cooling fan.....	45
Installing a cooling fan.....	46
Cooling fan cage.....	47
Removing the cooling fan cage.....	47
Installing the cooling fan cage.....	48
Fan board tray.....	49
Fan board view.....	49
Removing the fan board tray.....	50
Installing the fan board tray.....	50
Front PERC module.....	51
Removing the front PERC module.....	51
Installing the front PERC module.....	52
Drives.....	54
Removing a drive blank.....	54
Installing a drive blank.....	54
Removing a drive carrier.....	55
Installing a drive carrier.....	56
Removing the drive from the drive carrier.....	57
Installing a drive into the drive carrier.....	58
Removing a 3.5-inch drive adapter from a 3.5-inch drive carrier.....	59
Installing a 3.5-inch drive adapter into the 3.5-inch drive carrier.....	60
Removing a 2.5-inch drive from a 3.5-inch drive adapter.....	61
Installing a 2.5-inch drive into a 3.5-inch drive adapter.....	62
Drive backplane.....	63
Drive backplane.....	63
Removing the 3.5-inch drive backplane.....	64
Installing the 3.5-inch drive backplane.....	65
Removing the 2.5-inch drive backplane.....	66
Installing the 2.5-inch drive backplane.....	67
Drive bays.....	68
Removing the drive bay cage blank.....	68
Installing the drive bay cage blank.....	70
Removing a drive bay.....	71
Installing a drive bay.....	73
Cable routing.....	75
Optional optical drive.....	97
Removing the optical drive blank.....	97
Installing the optical drive blank.....	97
Removing the optical drive.....	98
Installing the optical drive.....	99
Optional tape backup unit.....	100
Removing the tape backup unit blank.....	100
Installing the tape backup unit blank.....	101
Removing the tape backup unit.....	102
Installing the tape backup unit.....	103
Front IO module.....	104
Removing the front IO module.....	104
Installing the front IO module.....	105
System memory.....	107

System memory guidelines.....	107
General memory module installation guidelines.....	108
Removing a memory module.....	108
Installing a memory module.....	109
Optional BOSS S2 module.....	110
Removing the BOSS S2 module.....	110
Installing the BOSS S2 module.....	112
Removing the BOSS S2 card carrier.....	113
Installing the BOSS S2 card carrier.....	115
M.2 BOSS card.....	116
Removing the M.2 SSD module.....	116
Installing the M.2 SSD module.....	116
Optional internal USB card.....	117
Removing the internal USB module.....	117
Installing the internal USB module.....	118
Internal USB memory key.....	119
Removing the internal USB memory key.....	119
Installing the internal USB memory key	119
Optional IDSDM module.....	119
Removing the IDSDM module.....	119
Installing the IDSDM module.....	120
MicroSD card.....	121
Removing the MicroSD card.....	121
Installing the MicroSD card.....	122
Expansion cards.....	123
Expansion card installation guidelines.....	123
Removing a expansion card.....	128
Installing an expansion card.....	129
GPU card holder.....	131
Removing the GPU card holder.....	131
Installing the GPU card holder.....	131
Optional GPU card.....	132
Removing the GPU card.....	132
Installing the GPU card.....	134
GPU riser.....	135
Removing the GPU riser.....	135
Installing the GPU riser.....	136
Processor and heat sink module.....	137
Removing the processor and heat sink module.....	137
Removing the processor.....	139
Installing the processor.....	141
Installing the processor and heat sink module.....	145
Optional OCP card.....	147
Removing the OCP card.....	147
Installing the OCP card.....	149
Optional serial COM port.....	151
Removing the serial COM port.....	151
Installing the serial COM port.....	152
System battery	153
Replacing the system battery.....	153

Intrusion switch module.....	154
Removing the intrusion switch module.....	154
Installing the intrusion switch module.....	155
Power supply unit.....	156
Hot spare feature.....	156
Removing a power supply unit blank.....	157
Installing a power supply unit blank.....	157
Removing a power supply unit adapter.....	158
Installing a power supply unit adapter.....	158
Removing a AC power supply unit.....	159
Installing a AC power supply unit.....	160
Power interposer board.....	162
PIB board view.....	162
Removing the power interposer board.....	162
Installing the power interposer board.....	163
System board.....	164
Removing the system board.....	164
Installing the system board.....	165
Restoring Service Tag using Easy Restore.....	167
Trusted Platform Module.....	168
Upgrading the Trusted Platform Module.....	168
Initializing TPM for users.....	169
Initializing the TPM 1.2 for users.....	169
Initializing the TPM 2.0 for users.....	169
Chapter 6: Jumpers and connectors.....	170
System board connectors.....	170
System board jumper settings.....	172
Disabling a forgotten password.....	172
Chapter 7: System diagnostics and indicator codes.....	174
Status LED indicators.....	174
System health and system ID indicator codes.....	175
iDRAC Quick Sync 2 indicator codes.....	175
iDRAC Direct LED indicator codes.....	176
NIC indicator codes.....	177
Power supply unit indicator codes.....	177
Drive indicator codes.....	179
Using system diagnostics.....	180
Dell Embedded System Diagnostics.....	180
Chapter 8: Getting help.....	182
Recycling or End-of-Life service information.....	182
Contacting Dell Technologies.....	182
Accessing system information by using QRL.....	182
Quick Resource Locator for PowerEdge T550 system.....	183
Receiving automated support with SupportAssist	183
Chapter 9: Documentation resources.....	184

About this document

This document provides an overview about the system, information about installing and replacing components, diagnostic tools, and guidelines to be followed while installing certain components.

PowerEdge T550 system overview

The PowerEdge T550 system is a 5U tower server that supports:

- Two Intel Xeon Scalable processors
- Sixteen DIMM slots
- Two redundant AC power supply units
- Up to 24 universal U.2/SAS/SATA hot swap drives (maximum eight NVMe drives)

i **NOTE:** All instances of SAS, SATA, and NVMe drives are seen as drives in this document, unless specified otherwise.

i **NOTE:** For more information about how to hot swap NVMe PCIe SSD U.2 device, see the *Dell Express Flash NVMe PCIe SSD User's Guide* at <https://www.dell.com/support> > **Browse all Products** > **Data Center Infrastructure** > **Storage Adapters & Controllers** > **Dell PowerEdge Express Flash NVMe PCIe SSD** > **Documentation** > **Manuals and Documents**.

△ CAUTION: Do not install GPUs, network cards, or other PCIe devices on your system that are not validated and tested by Dell. Damage caused by unauthorized and invalidated hardware installation will null and void the system warranty.

i **NOTE:** For more information, see the *Dell EMC PowerEdge T550 Technical Specifications* on the product documentation page.

Topics:

- [Front view of the system](#)
- [Rear view of the system](#)
- [Inside the system](#)
- [Locating the Express Service Code and Service Tag](#)
- [System Information Label](#)

Front view of the system

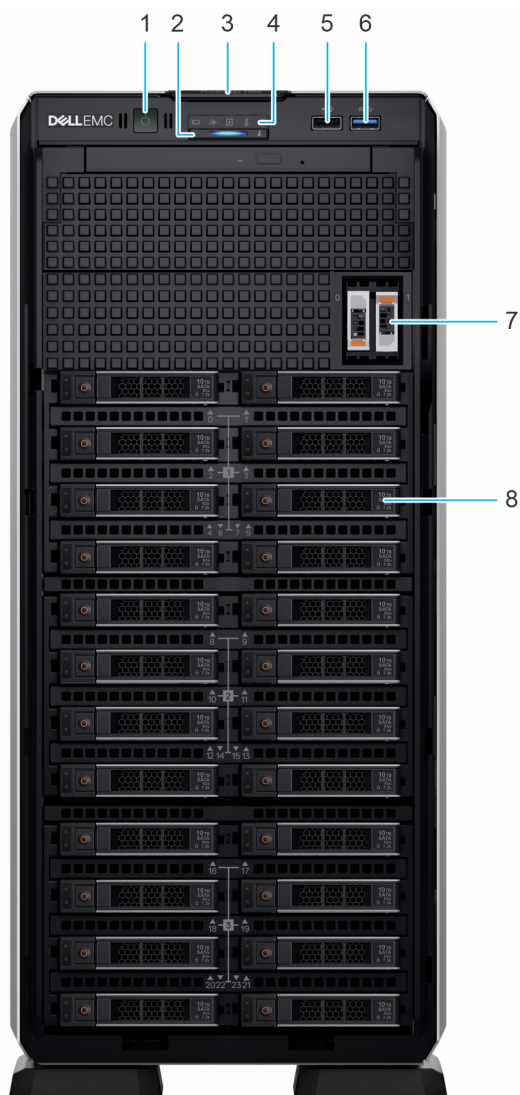



Figure 1. Front view of 24 x 2.5-inch drive system

Table 1. Features available on the front of the system

Item	Ports, panels, and slots	Icon	Description
1	Power button		Indicates if the system is powered on or off. Press the power button to manually power on or off the system. NOTE: Press the power button to gracefully shut down an ACPI-compliant operating system.
2	System health and ID indicator		Indicates the status of the system. For more information about System health and system ID indicator codes, see the www.dell.com/poweredgemanuals .
3	Information tag	N/A	The Information tag is a slide-out label panel that contains system information such as Service Tag, NIC, MAC address, and so on. If you have opted for the secure default access to iDRAC, then the Information tag also contains the iDRAC secure default password.
4	Status LED indicators	N/A	Enables you to identify any failed hardware components. There are up to five status LEDs and an overall system health LED bar. For

Table 1. Features available on the front of the system (continued)

Item	Ports, panels, and slots	Icon	Description
			more information about Status LED indicators, see the www.dell.com/poweredgemanuals .
5	USB 2.0 port		The USB ports are 4-pin, 2.0-compliant. These ports enable you to connect USB devices to the system.
6	USB 3.0 port		The USB ports are 9-pin and 3.0-compliant. These ports enable you to connect USB devices to the system.
7	BOSS S2 module (optional)	N/A	This slot supports the BOSS S2 module.
8	Drive	N/A	Enables you to install SAS/SATA drives that are supported on your system.

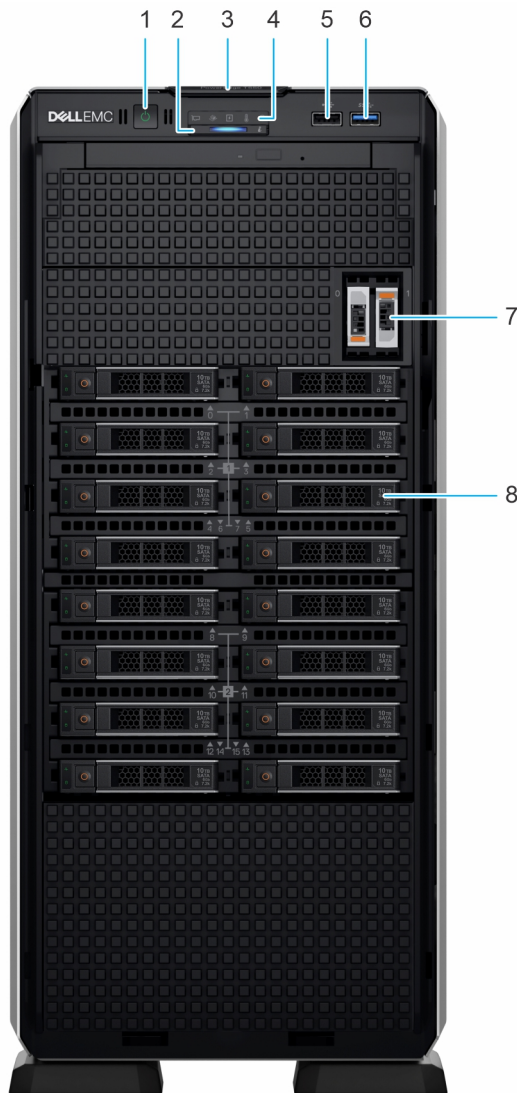

Figure 2. Front view of 16 x 2.5-inch drive system

Table 2. Features available on the front of the system





Item	Ports, panels, and slots	Icon	Description
1	Power button		Indicates if the system is powered on or off. Press the power button to manually power on or off the system.

Table 2. Features available on the front of the system (continued)

Item	Ports, panels, and slots	Icon	Description
			 NOTE: Press the power button to gracefully shut down an ACPI-compliant operating system.
2	System health and ID indicator		Indicates the status of the system. For more information about System health and system ID indicator codes, see the www.dell.com/poweredgemanuals .
3	Information tag	N/A	The Information tag is a slide-out label panel that contains system information such as Service Tag, NIC, MAC address, and so on. If you have opted for the secure default access to iDRAC, then the Information tag also contains the iDRAC secure default password.
4	Status LED indicators	N/A	Enables you to identify any failed hardware components. There are up to five status LEDs and an overall system health LED bar. For more information about Status LED indicators, see the www.dell.com/poweredgemanuals .
5	USB 2.0 port		The USB ports are 4-pin, 2.0-compliant. These ports enable you to connect USB devices to the system.
6	USB 3.0 port		The USB ports are 9-pin and 3.0-compliant. These ports enable you to connect USB devices to the system.
7	BOSS S2 module (optional)	N/A	This slot supports the BOSS S2 module.
8	Drive	N/A	Enables you to install SAS/SATA drives that are supported on your system.

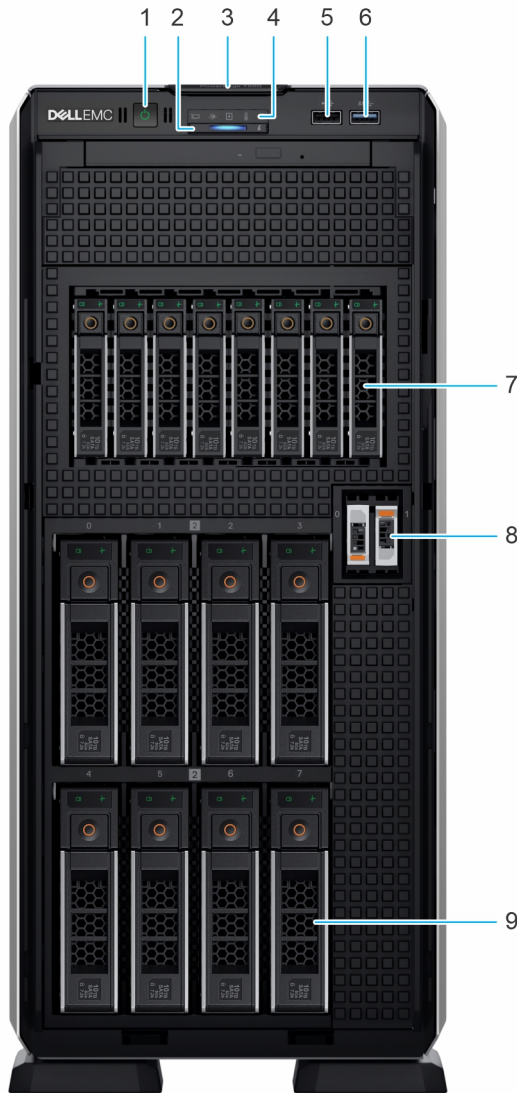

Figure 3. Front view of 8 x 3.5-inch + 8 x 2.5-inch drive system

Table 3. Features available on the front of the system



Item	Ports, panels, and slots	Icon	Description
1	Power button		Indicates if the system is powered on or off. Press the power button to manually power on or off the system. NOTE: Press the power button to gracefully shut down an ACPI-compliant operating system.
2	System health and ID indicator		Indicates the status of the system. For more information about System health and system ID indicator codes, see the www.dell.com/poweredgemanuals .
3	Information tag	N/A	The Information tag is a slide-out label panel that contains system information such as Service Tag, NIC, MAC address, and so on. If you have opted for the secure default access to iDRAC, then the Information tag also contains the iDRAC secure default password.
4	Status LED indicators	N/A	Enables you to identify any failed hardware components. There are up to five status LEDs and an overall system health LED bar. For more information about Status LED indicators, see the www.dell.com/poweredgemanuals .

Table 3. Features available on the front of the system (continued)



Item	Ports, panels, and slots	Icon	Description
5	USB 2.0 port		The USB ports are 4-pin, 2.0-compliant. These ports enable you to connect USB devices to the system.
6	USB 3.0 port		The USB ports are 9-pin and 3.0-compliant. These ports enable you to connect USB devices to the system.
7	NVMe drives	N/A	Enables you to install NVMe drives that are supported on your system.
8	BOSS S2 module (optional)	N/A	This slot supports the BOSS S2 module.
9	Drive	N/A	Enables you to install SAS/SATA drives that are supported on your system.



Figure 4. Front view of 8 x 3.5-inch drive system

Table 4. Features available on the front of the system





Item	Ports, panels, and slots	Icon	Description
1	Power button		Indicates if the system is powered on or off. Press the power button to manually power on or off the system.

Table 4. Features available on the front of the system (continued)

Item	Ports, panels, and slots	Icon	Description
			 NOTE: Press the power button to gracefully shut down an ACPI-compliant operating system.
2	System health and ID indicator		Indicates the status of the system. For more information about System health and system ID indicator codes, see the www.dell.com/poweredgemanuals .
3	Information tag	N/A	The Information tag is a slide-out label panel that contains system information such as Service Tag, NIC, MAC address, and so on. If you have opted for the secure default access to iDRAC, then the Information tag also contains the iDRAC secure default password.
4	Status LED indicators	N/A	Enables you to identify any failed hardware components. There are up to five status LEDs and an overall system health LED bar. For more information about Status LED indicators, see the www.dell.com/poweredgemanuals .
5	USB 2.0 port		The USB ports are 4-pin, 2.0-compliant. These ports enable you to connect USB devices to the system.
6	USB 3.0 port		The USB ports are 9-pin and 3.0-compliant. These ports enable you to connect USB devices to the system.
7	BOSS S2 module (optional)	N/A	This slot supports the BOSS S2 module.
8	Drive	N/A	Enables you to install SAS/SATA drives that are supported on your system.

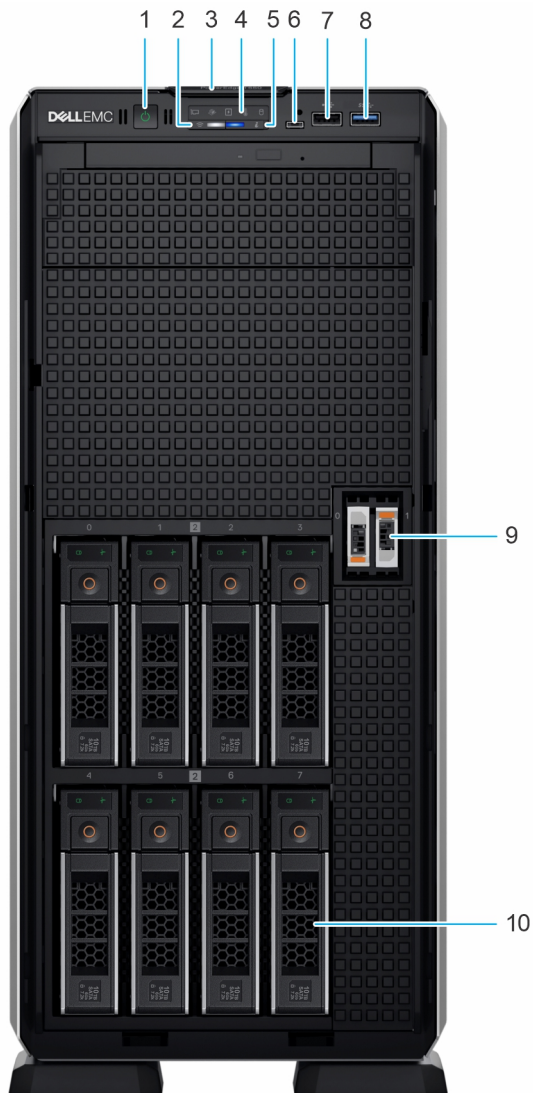

Figure 5. Front view of 8 x 3.5-inch drive system (upsell configuration)

Table 5. Features available on the front of the system





Item	Ports, panels, and slots	Icon	Description
1	Power button		Indicates if the system is powered on or off. Press the power button to manually power on or off the system. NOTE: Press the power button to gracefully shut down an ACPI-compliant operating system.
2	iDRAC Quick Sync 2 wireless indicator (optional)	N/A	Quick Sync 2 (wireless): Indicates a Quick Sync enabled system. The Quick Sync feature is optional. This feature allows management of the system by using mobile devices called as OpenManage Mobile (OMM) feature. Using iDRAC Quick Sync 2 with OpenManage Mobile (OMM) aggregates hardware or firmware inventory and various system level diagnostic and error information that can be used in troubleshooting the system. For more information, see the iDRAC User's Guide available at https://www.dell.com/idracmanuals NOTE: The iDRAC Quick Sync 2 indicator is available only on certain configurations.
3	Information tag	N/A	The Information tag is a slide-out label panel that contains system information such as Service Tag, NIC, MAC address, and so on. If

Table 5. Features available on the front of the system (continued)

Item	Ports, panels, and slots	Icon	Description
			you have opted for the secure default access to iDRAC, then the Information tag also contains the iDRAC secure default password.
4	Status LED indicators	N/A	Enables you to identify any failed hardware components. There are up to five status LEDs and an overall system health LED bar. For more information about Status LED indicators, see the www.dell.com/poweredgemanuals .
5	System health and ID indicator		Indicates the status of the system. For more information about System health and system ID indicator codes, see the www.dell.com/poweredgemanuals .
6	iDRAC Direct port (Micro-AB USB)		<p>The iDRAC Direct port (Micro-AB USB) enables you to access the iDRAC direct Micro-AB USB features. For more information, see the https://www.dell.com/idracmanuals.</p> <p>NOTE: You can configure iDRAC Direct by using a USB to micro USB (type AB) cable, which you can connect to your laptop or tablet. Cable length should not exceed 3 feet (0.91 meters). Performance could be affected by cable quality.</p>
7	USB 2.0 port		The USB ports are 4-pin, 2.0-compliant. These ports enable you to connect USB devices to the system.
8	USB 3.0 port		The USB ports are 9-pin and 3.0-compliant. These ports enable you to connect USB devices to the system.
9	BOSS S2 module (optional)	N/A	This slot supports the BOSS S2 module.
10	Drive	N/A	Enables you to install SAS/SATA drives that are supported on your system.

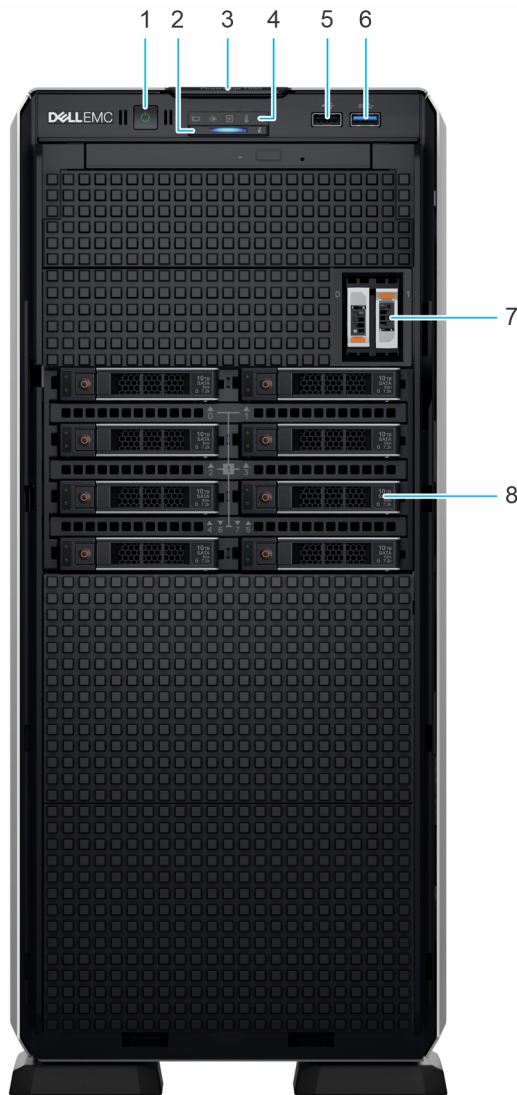

Figure 6. Front view of 8 x 2.5-inch drive system

Table 6. Features available on the front of the system





Item	Ports, panels, and slots	Icon	Description
1	Power button		Indicates if the system is powered on or off. Press the power button to manually power on or off the system. NOTE: Press the power button to gracefully shut down an ACPI-compliant operating system.
2	System health and ID indicator		Indicates the status of the system. For more information about System health and system ID indicator codes, see the www.dell.com/poweredgemanuals .
3	Information tag	N/A	The Information tag is a slide-out label panel that contains system information such as Service Tag, NIC, MAC address, and so on. If you have opted for the secure default access to iDRAC, then the Information tag also contains the iDRAC secure default password.
4	Status LED indicators	N/A	Enables you to identify any failed hardware components. There are up to five status LEDs and an overall system health LED bar. For more information about Status LED indicators, see the www.dell.com/poweredgemanuals .

Table 6. Features available on the front of the system (continued)

Item	Ports, panels, and slots	Icon	Description
5	USB 2.0 port		The USB ports are 4-pin, 2.0-compliant. These ports enable you to connect USB devices to the system.
6	USB 3.0 port		The USB ports are 9-pin and 3.0-compliant. These ports enable you to connect USB devices to the system.
7	BOSS S2 module (optional)	N/A	This slot supports the BOSS S2 module.
8	Drive	N/A	Enables you to install SAS/SATA drives that are supported on your system.

NOTE: For more information, see the *Dell EMC PowerEdge T550 Technical Specifications* on the product documentation page.

Rear view of the system

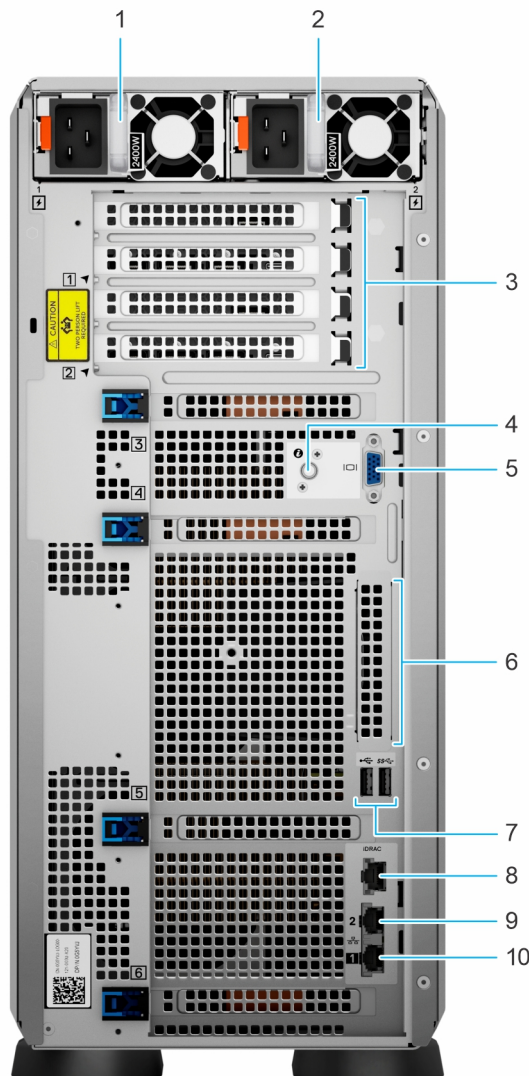







Figure 7. Rear view of the system

Table 7. Rear view of the system

Item	Ports, panels, or slots	Icon	Description
1	Power supply unit (PSU 1)	N/A	This is the primary PSU of the system. For more information about the PSU configurations, see www.dell.com/poweredgemanuals .
2	Power supply unit (PSU 2)	N/A	This PSU provides redundancy to the system. For more information about the PSU configurations, see www.dell.com/poweredgemanuals .
3	PCIe expansion card slots (4)	N/A	Enables you to connect PCI Express expansion cards.
4	System identification button		<p>Press the system ID button:</p> <ul style="list-style-type: none"> To locate a particular system within a rack. To turn the system ID on or off. <p>To reset iDRAC, press and hold the button for 16 seconds.</p> <p>NOTE:</p> <ul style="list-style-type: none"> To reset iDRAC using system ID, ensure that the system ID button is enabled in the iDRAC setup. If the system stops responding during POST, press and hold the system ID button (for more than five seconds) to enter the BIOS progress mode.
5	VGA port		Enables you to connect a display device to the system.
6	OCP NIC port (optional)	N/A	This port supports OCP 3.0. The NIC ports are integrated on the OCP card which is connected to the system board
7	USB ports (2)		These ports are USB Type A compliant.
8	iDRAC dedicated port	iDRAC	This RJ-45 port enables you to remotely access iDRAC. For more information, see the iDRAC User's Guide at www.dell.com/poweredgemanuals .
9	NIC ports (2)		The NIC ports that are integrated on the system board provide network connectivity. These NIC ports can also be shared with iDRAC when iDRAC network settings is set to shared mode.
10	NIC ports (1)		The NIC ports that are integrated on the system board provide network connectivity. These NIC ports can also be shared with iDRAC when iDRAC network settings is set to shared mode.

NOTE: For more information, see the *Dell EMC PowerEdge T550 Technical Specifications* on the product documentation page.

Inside the system

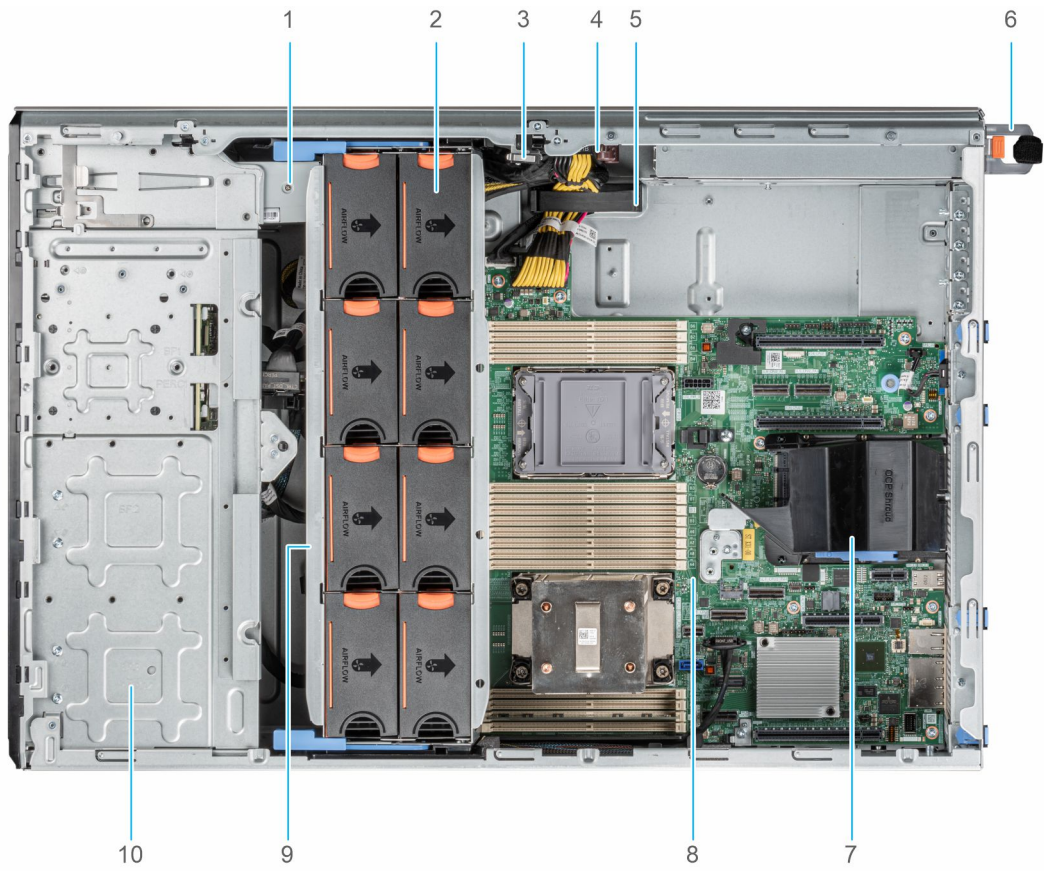

Figure 8. Inside the system for 24 x 2.5-inch configuration

- 1. Tape backup unit
- 2. Cooling fan
- 3. Intrusion switch
- 4. Power interposer board
- 5. Cable retention clip
- 6. PSU 1
- 7. OCP air shroud
- 8. System board
- 9. Cooling fan cage
- 10. 2.5-inch drive bay

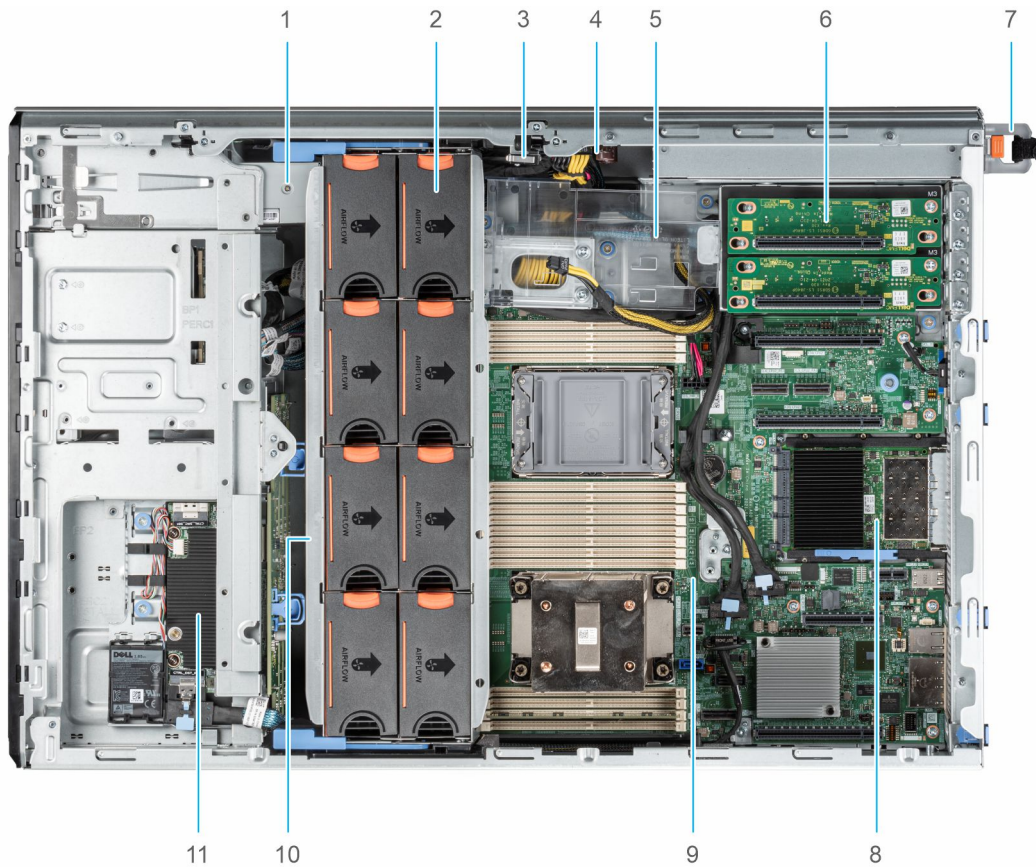

Figure 9. Inside the system for 8 x 3.5-inch + 8 x 2.5-inch configuration

- | | |
|-----------------------|---------------------------|
| 1. Tape backup unit | 2. Cooling fan |
| 3. Intrusion switch | 4. Power interposer board |
| 5. GPU card holder | 6. GPU riser |
| 7. PSU 1 | 8. OCP card |
| 9. System board | 10. Cooling fan cage |
| 11. Front PERC module | |

Locating the Express Service Code and Service Tag

The unique Express Service Code and Service Tag are used to identify the system.

of the system that If you have opted for the secure default access to iDRAC, the Information tag also contains the iDRAC secure default password. If you have opted for iDRAC Quick Sync 2, the Information tag also contains the OpenManage Mobile (OMM) label, where administrators can configure, monitor, and troubleshoot the PowerEdge servers.

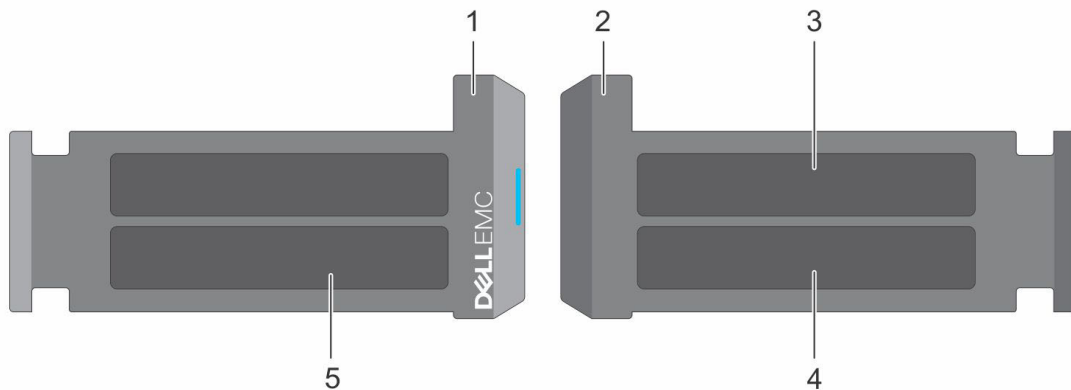

Figure 10. Locating the Express Service Code and Service tag

1. Information tag (front view)
2. Information tag (back view)
3. OpenManage Mobile (OMM) label
4. iDRAC MAC address and iDRAC secure password label
5. Service Tag, Express Service Code, QRL label

The Mini Enterprise Service Tag (MEST) label is located on the rear of the system that includes the Service Tag (ST), Express Service Code (Exp Svc Code), and Manufacture Date (Mfg. Date). The Exp Svc Code is used by Dell EMC to route support calls to the appropriate personnel.

Alternatively, the Service Tag information is located on a label on the left wall of the chassis.

System Information Label

PowerEdge T550 system information label

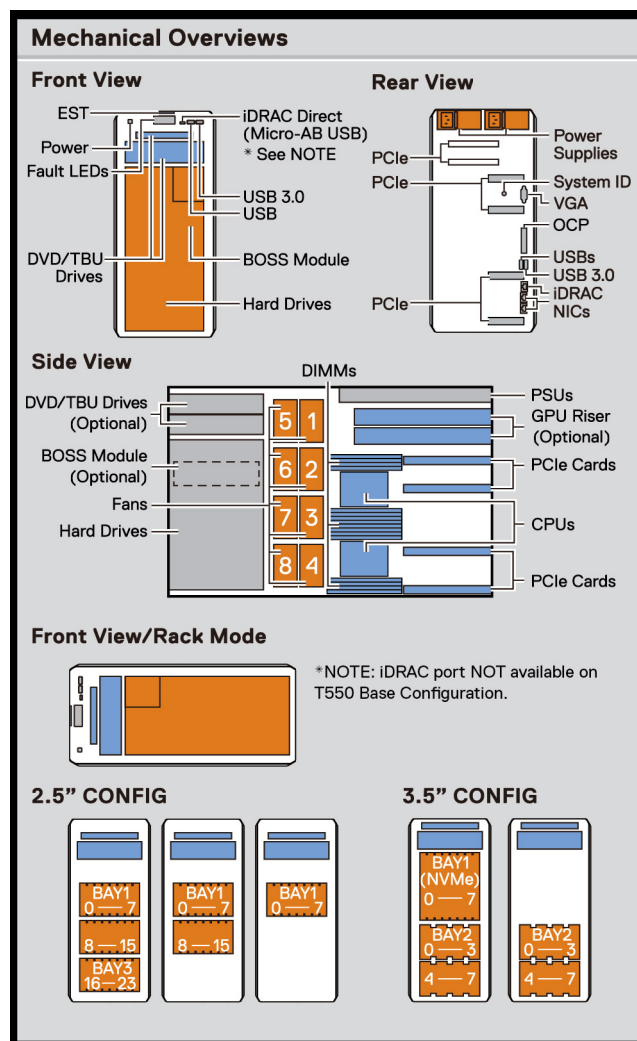

Figure 11. Service information

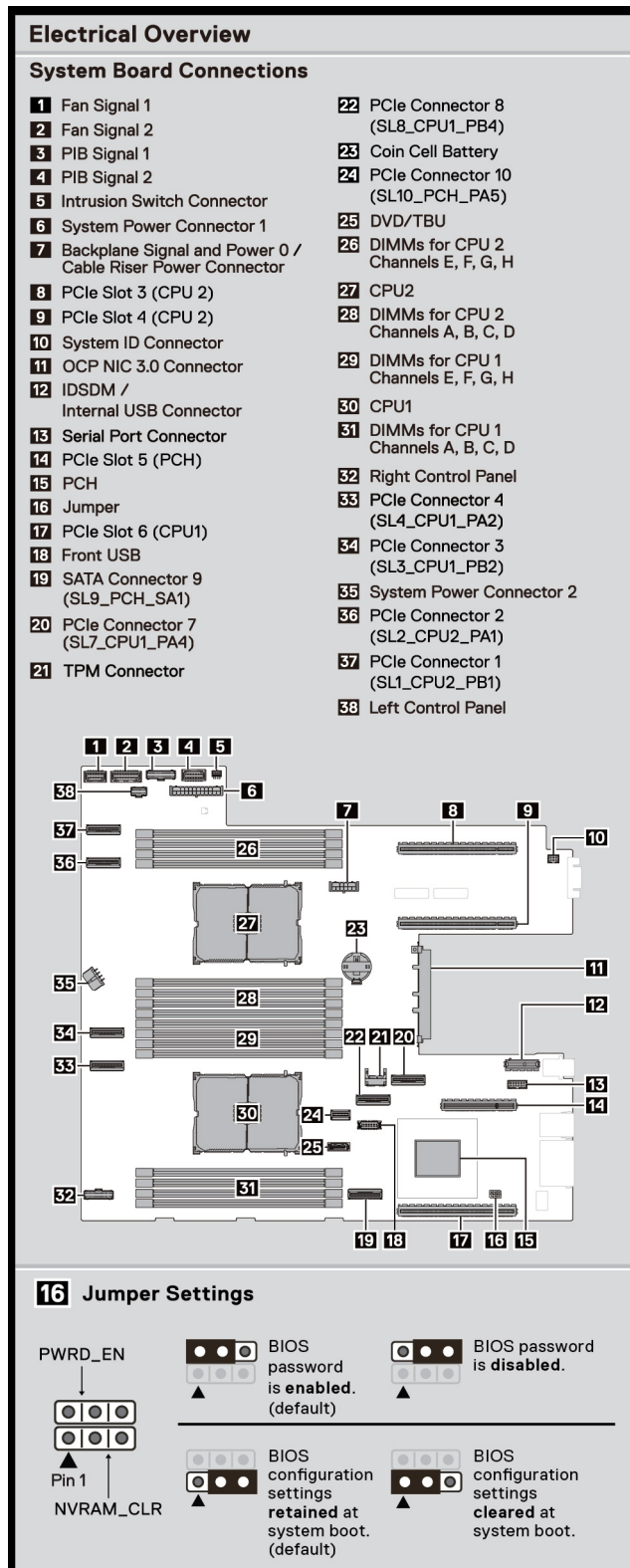

Figure 12. Service information

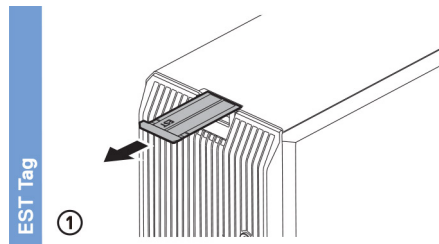

Figure 13. Express Service Tag

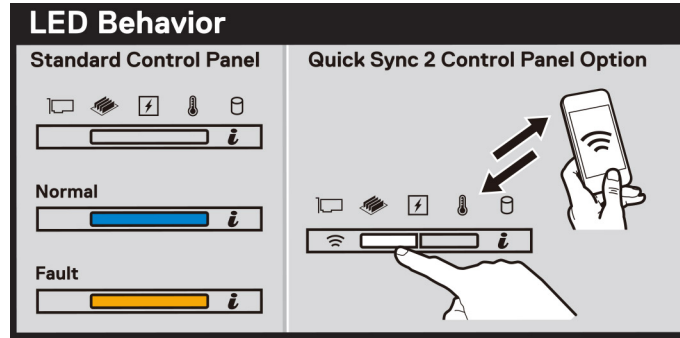

Figure 14. LED behavior

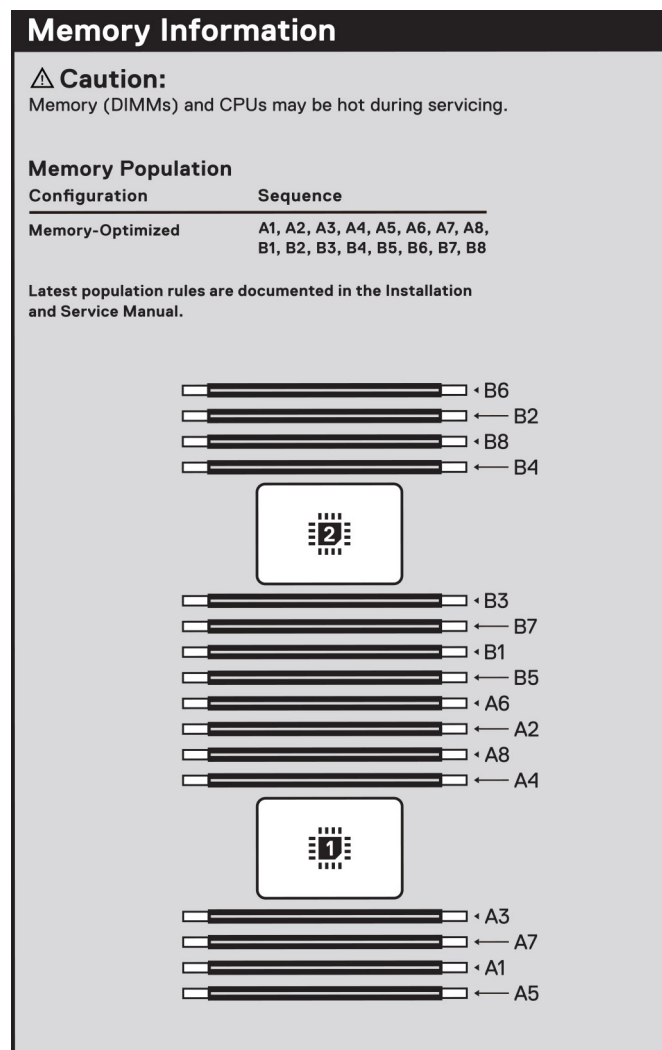

Figure 15. Memory information

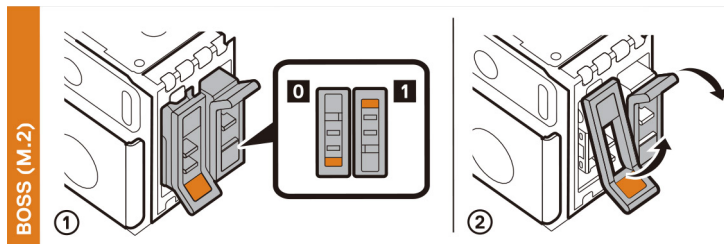

Figure 16. BOSS S2 module

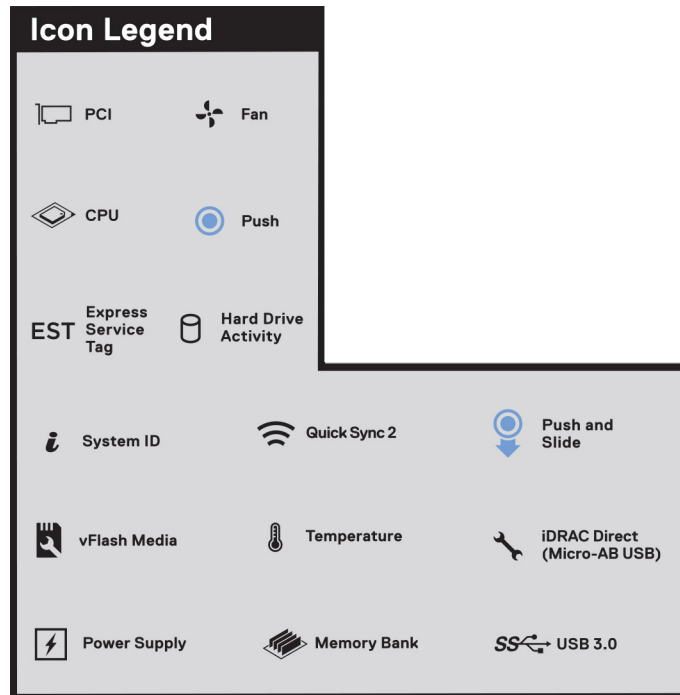

Figure 17. Icon legend

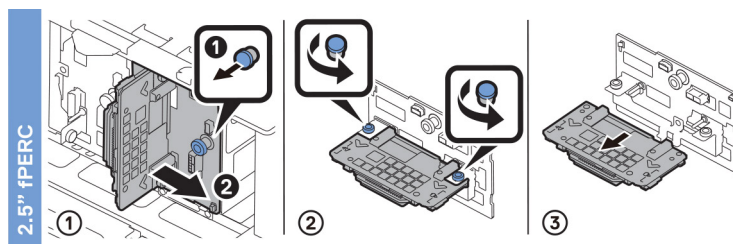

Figure 18. 2.5-inch fPERC

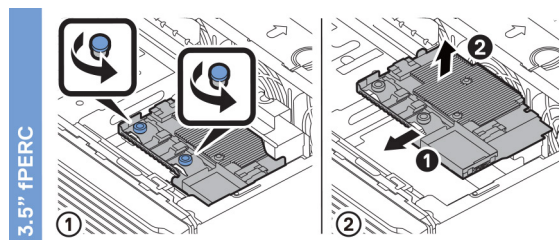

Figure 19. 3.5-inch fPERC

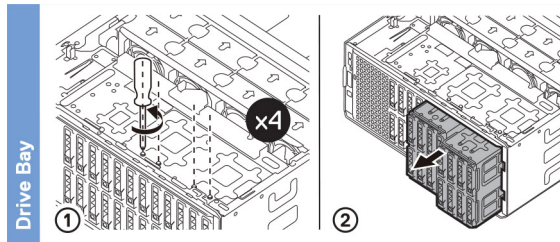

Figure 20. Drive bay

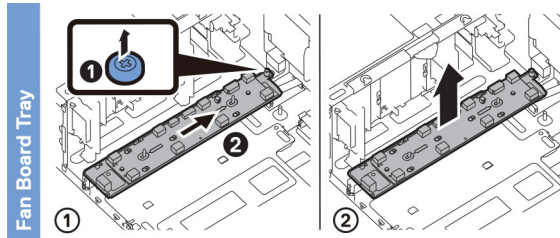

Figure 21. Fan board tray

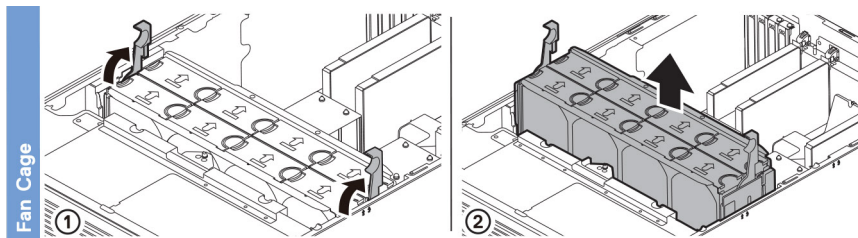

Figure 22. Fan cage

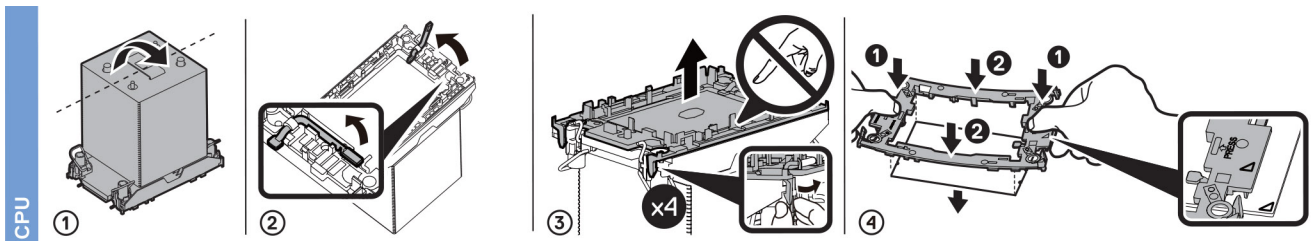

Figure 23. Processor

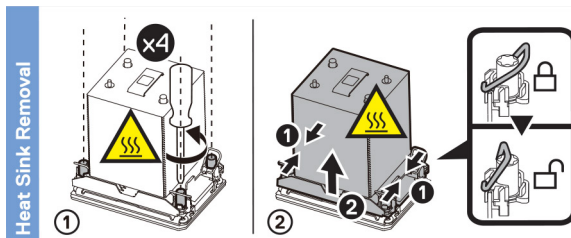

Figure 24. Heat sink removal

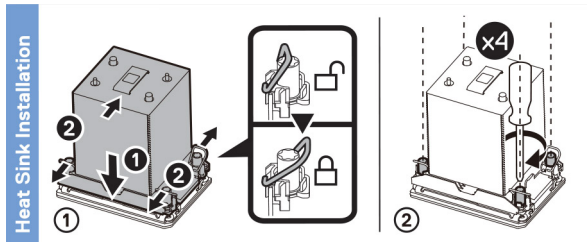

Figure 25. Heat sink installation

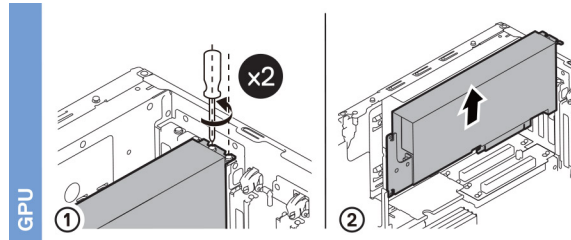

Figure 26. GPU

Initial system setup and configuration

This section describes the tasks for initial setup and configuration of the Dell EMC system. The section also provides general steps to set up the system and the reference guides for detailed information.

Topics:

- [Setting up the system](#)
- [iDRAC configuration](#)
- [Resources to install operating system](#)

Setting up the system

Perform the following steps to set up the system:

Steps

1. Unpack the system.
2. Connect the peripherals to the system and the system to the electrical outlet.
3. Power on the system.

For more information about setting up the system, see the *Getting Started Guide* that is shipped with your system.

i **NOTE:** For information about managing the basic settings and features of the system, see the *Dell EMC PowerEdge T550 BIOS and UEFI Reference Guide* on the product documentation page.

iDRAC configuration

The Integrated Dell Remote Access Controller (iDRAC) is designed to make you more productive as a system administrator and improve the overall availability of Dell EMC servers. iDRAC alerts you to system issues, helps you to perform remote management, and reduces the need for physical access to the system.

Options to set up iDRAC IP address

To enable communication between your system and iDRAC, you must first configure the network settings based on your network infrastructure. The network settings option is set to **DHCP**, by default.

i **NOTE:** For static IP configuration, you must request for the settings at the time of purchase.

You can set up the iDRAC IP address using one of the interfaces in the table below. For information about setting up iDRAC IP address, see the documentation links provided in the table below.

Table 8. Interfaces to set up iDRAC IP address

Interface	Documentation links
iDRAC Settings utility	<p><i>Integrated Dell Remote Access Controller User's Guide</i> at https://www.dell.com/idracmanuals or for system specific <i>Integrated Dell Remote Access Controller User's Guide</i>, go to https://www.dell.com/poweredgemanuals > Product Support page of your system > Documentation.</p> <p>i NOTE: To determine the most recent iDRAC release for your platform and for latest documentation version,</p>

Table 8. Interfaces to set up iDRAC IP address (continued)

Interface	Documentation links
	see KB article https://www.dell.com/support/article/sln308699 .
OpenManage Deployment Toolkit	<i>Dell EMC OpenManage Deployment Toolkit User's Guide</i> available at https://www.dell.com/openmanagemanuals > Open Manage Deployment Toolkit.
iDRAC Direct	<i>Integrated Dell Remote Access Controller User's Guide</i> at https://www.dell.com/idracmanuals or for system specific <i>Integrated Dell Remote Access Controller User's Guide</i> , go to https://www.dell.com/poweredgemanuals > Product Support page of your system > Documentation . <i>i</i> NOTE: To determine the most recent iDRAC release for your platform and for latest documentation version, see KB article https://www.dell.com/support/article/sln308699 .
Lifecycle Controller	<i>Dell Lifecycle Controller User's Guide</i> at https://www.dell.com/idracmanuals or for system specific <i>Dell Lifecycle Controller User's Guide</i> , go to https://www.dell.com/poweredgemanuals > Product Support page of your system > Documentation . <i>i</i> NOTE: To determine the most recent iDRAC release for your platform and for latest documentation version, see KB article https://www.dell.com/support/article/sln308699 .
iDRAC Direct and Quick Sync 2 (optional)	<i>Integrated Dell Remote Access Controller User's Guide</i> at https://www.dell.com/idracmanuals or for system specific <i>Integrated Dell Remote Access Controller User's Guide</i> , go to https://www.dell.com/poweredgemanuals > Product Support page of your system > Documentation . <i>i</i> NOTE: To determine the most recent iDRAC release for your platform and for latest documentation version, see KB article https://www.dell.com/support/article/sln308699 .

i **NOTE:** iDRAC direct port and Quick Sync 2 are optional for PowerEdge T550 and are available only with the upsell configuration.

i **NOTE:** To access iDRAC, ensure that you connect the ethernet cable to the iDRAC dedicated network port or use the iDRAC Direct port by using the USB cable. You can also access iDRAC through the shared LOM mode, if you have opted for a system that has the shared LOM mode enabled.

Options to log in to iDRAC

To log in to the iDRAC Web User Interface, open a browser and enter the IP address.

You can log in to iDRAC as:

- iDRAC user
- Microsoft Active Directory user
- Lightweight Directory Access Protocol (LDAP) user

In the login screen displayed, if you have opted for secure default access to iDRAC, enter the iDRAC secure default password available on back of the Information Tag. If you have not opted for secure default access to iDRAC, enter the default user name and password – `root` and `calvin`. You can also log in by using your Single Sign-On or Smart Card.

i **NOTE:** Ensure that you change the default username and password after setting up the iDRAC IP address.

For more information about logging in to the iDRAC and iDRAC licenses, see the latest *Integrated Dell Remote Access Controller User's Guide* at www.dell.com/idracmanuals.

NOTE: To determine the most recent iDRAC release for your platform and for latest documentation version, see KB article <https://www.dell.com/support/article/sln308699>.

You can also access iDRAC using command-line protocol - RACADM. For more information, see the *Integrated Dell Remote Access Controller RACADM CLI Guide* available at <https://www.dell.com/idracmanuals>.

You can also access iDRAC using automation tool - Redfish API. For more information, see the *Integrated Dell Remote Access Controller User's Guide Redfish API Guide* available at <https://developer.dell.com>.

Resources to install operating system

If the system is shipped without an operating system, you can install a supported operating system by using one of the resources provided in the table below. For information about how to install the operating system, see the documentation links provided in the table below.

Table 9. Resources to install the operating system

Resource	Documentation links
iDRAC	<i>Integrated Dell Remote Access Controller User's Guide</i> at https://www.dell.com/idracmanuals or for system specific <i>Integrated Dell Remote Access Controller User's Guide</i> , go to https://www.dell.com/poweredgemanuals > Product Support page of your system > Documentation . NOTE: To determine the most recent iDRAC release for your platform and for latest documentation version, see KB article at https://www.dell.com/support/article/sln308699 .
Lifecycle Controller	<i>Dell Lifecycle Controller User's Guide</i> at https://www.dell.com/idracmanuals or for system specific <i>Dell Lifecycle Controller User's Guide</i> , go to https://www.dell.com/poweredgemanuals > Product Support page of your system > Documentation . Dell recommends using Lifecycle Controller to install the OS, since all required drivers are installed on the system. NOTE: To determine the most recent iDRAC release for your platform and for latest documentation version, see KB article at https://www.dell.com/support/article/sln308699 .
OpenManage Deployment Toolkit	www.dell.com/openmanagemanuals > OpenManage Deployment Toolkit
Dell certified VMware ESXi	www.dell.com/virtualizationsolutions

NOTE: For more information about installation and how-to videos for operating systems supported on PowerEdge systems, see [Supported Operating Systems for Dell EMC PowerEdge systems](#).

Options to download firmware

You can download firmware from the Dell support site. For information about downloading firmware, see the [Downloading drivers and firmware](#) section.

You can also choose any one of the following options to download the firmware. For information about how to download the firmware, see the documentation links provided in the table below.

Table 10. Options to download firmware

Option	Documentation link
Using Integrated Dell Remote Access Controller Lifecycle Controller (iDRAC with LC)	www.dell.com/idracmanuals
Using Dell Repository Manager (DRM)	www.dell.com/openmanagemanuals > Repository Manager
Using Dell Server Update Utility (SUU)	www.dell.com/openmanagemanuals > Server Update Utility
Using Dell OpenManage Deployment Toolkit (DTK)	www.dell.com/openmanagemanuals > OpenManage Deployment Toolkit

Table 10. Options to download firmware (continued)

Option	Documentation link
Using iDRAC virtual media	www.dell.com/idracmanuals

Options to download and install OS drivers

You can choose any one of the following options to download and install OS drivers. For information about how to download or install OS drivers, see the documentation links provided in the table below.

Table 11. Options to download and install OS drivers

Option	Documentation
Dell EMC support site	Downloading drivers and firmware section.
iDRAC virtual media	<i>Integrated Dell Remote Access Controller User's Guide</i> at https://www.dell.com/idracmanuals or for system specific <i>Integrated Dell Remote Access Controller User's Guide</i> , go to https://www.dell.com/poweredgemanuals > Product Support page of your system > Documentation . i NOTE: To determine the most recent iDRAC release for your platform and for latest documentation version, see https://www.dell.com/support/article/sln308699 .

Downloading drivers and firmware

It is recommended that you download and install the latest BIOS, drivers, and systems management firmware on the system.

Prerequisites

Ensure that you clear the web browser cache before downloading the drivers and firmware.

Steps

1. Go to www.dell.com/support/drivers.
2. Enter the Service Tag of the system in the **Enter a Dell Service Tag, Dell EMC Product ID or Model** field, and then press Enter.

i **NOTE:** If you do not have the Service Tag, click **Browse all products**, and navigate to your product.

3. On the displayed product page, click **Drivers & Downloads**.
On the **Drivers & Downloads** page, all drivers that are applicable to the system are displayed.
4. Download the drivers to a USB drive, CD, or DVD.

Minimum to POST and system management configuration validation

This section describes the minimum to POST system requirement and system management configuration validation of the Dell EMC system.

Topics:

- [Minimum configuration to POST](#)
- [Configuration validation](#)

Minimum configuration to POST

- One processor in socket processor 1
- One memory module (DIMM) in socket A1
- Power Interposer Board (PIB) and cables
- One power supply unit
- System board

Configuration validation

The new generation of PowerEdge systems have added interconnect flexibility and advanced iDRAC management features to collect precise system configuration information and report configuration errors.

When the system is powered on, information about installed cables, backplanes, and processor is obtained from the CPLD and backplane memory maps is analyzed. This information forms a unique configuration, which is compared with one of the qualified configurations stored in a table maintained by iDRAC.

One or more sensors are assigned to each of the configuration elements. During POST, any configuration validation error is logged in the System Event Log (SEL)/LifeCycle (LC) log. The reported events are categorized in the configuration validation error table.

Table 12. Configuration validation error

Error	Description	Possible cause and recommendations	Example
Config Error	A configuration element within the closest match contains something that is unexpected and does not match any Dell qualified configuration.	Wrong configuration	Config Error: Backplane cable CTRS_SRC_SA1 and BP-DST_SA1
		The element reported in HWC8010 errors are assembled incorrectly. Verify element (cable, etc) placement in the system.	Config Error : SL Cable PLANAR_SL7 and CTRL_DST_PA1
Config Missing	iDRAC found a configuration element missing within the closest match detected.	Missing or damaged cable, device, or part	Config Missing:
		Missing element or cable is reported in HWC8010 error logs. Install the missing element (cable, etc).	Config Missing : SL cable PLANAR_SL8 and CTRL_DST_PA1

Table 12. Configuration validation error (continued)

Error	Description	Possible cause and recommendations	Example
Comm Error	A configuration element is not responding to iDRAC using the management interface while running an inventory check.	System management sideband communication Unplug AC Power, reset the element and replace the element if the problem persists.	Comm Error: Backplane 2

Error messages

This section describes the error messages displayed on the screen during POST or captured in the system event log (SEL)/ LifeCycle (LC) log.

Table 13. Error message HWC8010

Error code	HWC8010
Message	The System Configuration Check operation resulted in the following issue involving the indicated component type
Arguments	backplane, processor, cable, or other components
Detailed Description	The issue identified in the message is observed in the System Configuration Check operation.
Recommended Response Action	Do the following and retry the operation: <ol style="list-style-type: none"> 1. Disconnect the input power. 2. Check for proper cable connection and component placement. If the issue persists, contact the service provider.
Category	System Health (HWC = Hardware Config)
Severity	Critical
Trap/EventID	2329

Table 14. Error message HWC8011

Error code	HWC8011
Message	The System Configuration Check operation resulted in multiple issues involving the indicated component type
Arguments	backplane, processor, cable, or other components
Detailed Description	Multiple issues are observed in the System Configuration Check operation.
Recommended Response Action	Do the following and retry the operation: <ol style="list-style-type: none"> 1. Disconnect the input power. 2. Check for proper cable connection and component placement. If the issue persists, contact the service provider.
Category	System Health (HWC = Hardware Config)
Severity	Critical

Installing and removing system components

Topics:

- Safety instructions
- Before working inside your system
- After working inside your system
- Recommended tools
- Optional front bezel
- System feet
- Optional caster wheels
- System cover
- Air shroud
- Cooling fans
- Cooling fan cage
- Fan board tray
- Front PERC module
- Drives
- Drive backplane
- Drive bays
- Cable routing
- Optional optical drive
- Optional tape backup unit
- Front IO module
- System memory
- Optional BOSS S2 module
- M.2 BOSS card
- Optional internal USB card
- Internal USB memory key
- Optional IDSDM module
- MicroSD card
- Expansion cards
- GPU card holder
- Optional GPU card
- GPU riser
- Processor and heat sink module
- Optional OCP card
- Optional serial COM port
- System battery
- Intrusion switch module
- Power supply unit
- Power interposer board
- System board
- Trusted Platform Module

Safety instructions

 **NOTE:** Whenever you need to lift the system, get others to assist you. To avoid injury, do not attempt to lift the system by yourself.

- CAUTION:** Ensure that two or more people lift the system horizontally from the box and place it on a flat surface, rack lift, or into the rails.
- WARNING:** Opening or removing the system cover while the system is powered on may expose you to a risk of electric shock.
- WARNING:** Do not operate the system without the cover for a duration exceeding five minutes. Operating the system without the system cover can result in component damage.
- CAUTION:** Many repairs may only be done by a certified service technician. You should only perform troubleshooting and simple repairs as authorized in your product documentation, or as directed by the online or telephone service and support team. Damage due to servicing that is not authorized by Dell is not covered by your warranty. Read and follow the safety instructions that are shipped with your product.
- NOTE:** It is recommended that you always use an antistatic mat and antistatic strap while working on components inside the system.
- CAUTION:** To ensure proper operation and cooling, all system bays and fans must always be populated with a component or a blank.
- NOTE:** While replacing the hot swappable PSU, after next server boot; the new PSU automatically updates to the same firmware and configuration of the replaced one. For updating to the latest firmware and changing the configuration, see the *Lifecycle Controller User's Guide* at <https://www.dell.com/idracmanuals>.
- NOTE:** While replacing faulty storage controller, FC, or NIC card with the same type of card, after you power on the system; the new card automatically updates to the same firmware and configuration of the faulty one. For updating to the latest firmware and changing the configuration, see the *Lifecycle Controller User's Guide* at <https://www.dell.com/idracmanuals>.
- CAUTION:** Do not install GPUs, network cards, or other PCIe devices on your system that are not validated and tested by Dell. Damage caused by unauthorized and invalidated hardware installation will null and void the system warranty.

Before working inside your system

Prerequisites

Follow the safety guidelines listed in the [Safety instructions](#).

Steps

1. Power off the system and all attached peripherals.
2. Disconnect the system from the electrical outlet, and disconnect the peripherals.
3. If applicable, remove the system from the rack.
For more information, see the *Rail Installation Guide* relevant to your rail solutions at www.dell.com/poweredgemanuals.
4. Remove the system cover.

After working inside your system

Prerequisites

Follow the safety guidelines listed in [Safety instructions](#).

Steps

1. Replace the system cover.
2. Reconnect the peripherals and connect the system to the electrical outlet, and then power on the system.

Recommended tools

You may need any or combination of the following tools to perform the removal and installation procedures:

- Key to the bezel lock. The key is required only if your system includes a bezel.
- Phillips 1 screwdriver
- Phillips 2 screwdriver
- Torx T30 screwdriver
- 5 mm hex nut screwdriver
- Plastic scribe
- 1/4-inch flat blade screwdriver
- Wrist grounding strap connected to the ground
- ESD mat
- Needle-nose pliers

Optional front bezel

Removing the front bezel

Prerequisites

1. Follow the safety guidelines listed in [Safety instructions](#).
2. Keep the bezel key handy.

i **NOTE:** The bezel key is part of the security bezel package.

Steps

1. Unlock the bezel.
2. Pull the top end of the bezel away from the system.
3. Unhook the bezel tabs from the slots at the bottom of the system, and lift the bezel away.



Figure 27. Removing the front bezel

Next steps

Replacing the front bezel.

Installing the front bezel

Prerequisites

1. Follow the safety guidelines listed in [Safety instructions](#).
2. Locate and remove the bezel key.

NOTE: The bezel key is part of the security bezel package.

Steps

1. Insert the bezel tabs into the slots on the system.
2. Push the bezel toward the system until the bezel locks into place.
3. Lock the bezel.



Figure 28. Installing the front bezel

System feet

Removing the system feet

Prerequisites

1. Follow the safety guidelines listed in [Safety instructions](#).
2. Place the system on its side on a flat, stable surface.
3. Rotate the system feet inward.

Steps

1. Using the Phillips 2 screwdriver, remove the screw that secures the foot to the base of the system.

2. Repeat the preceding step to remove the remaining system feet.

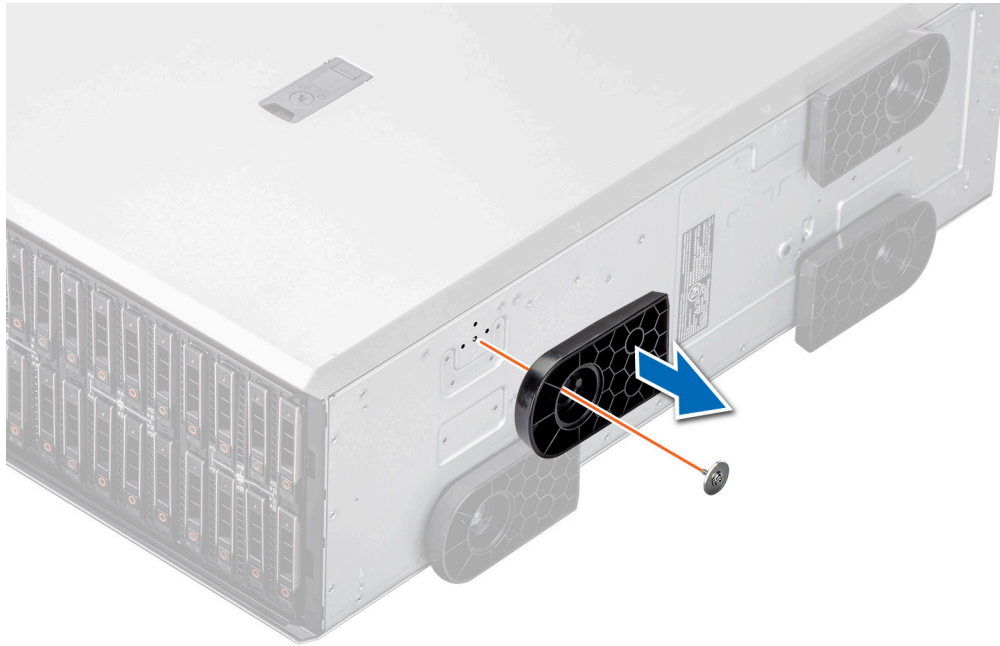

Figure 29. Removing the system feet

Next steps

Replace the system feet or install the caster wheels.

Installing the system feet

Prerequisites

CAUTION: Install the feet on a stand-alone tower system to provide stability to the system. An unstable system might tip over and cause injury to the user or damage to the system.

1. Follow the safety guidelines listed in [Safety instructions](#).
2. Place the system on its side, on a flat, stable surface.

Steps

1. Align the three tabs on the system foot with the three slots on the base of the system.
2. Using the Phillips 2 screwdriver, secure the screw that secures the foot to the base of the system.
3. Repeat step 2 to install the remaining system feet.

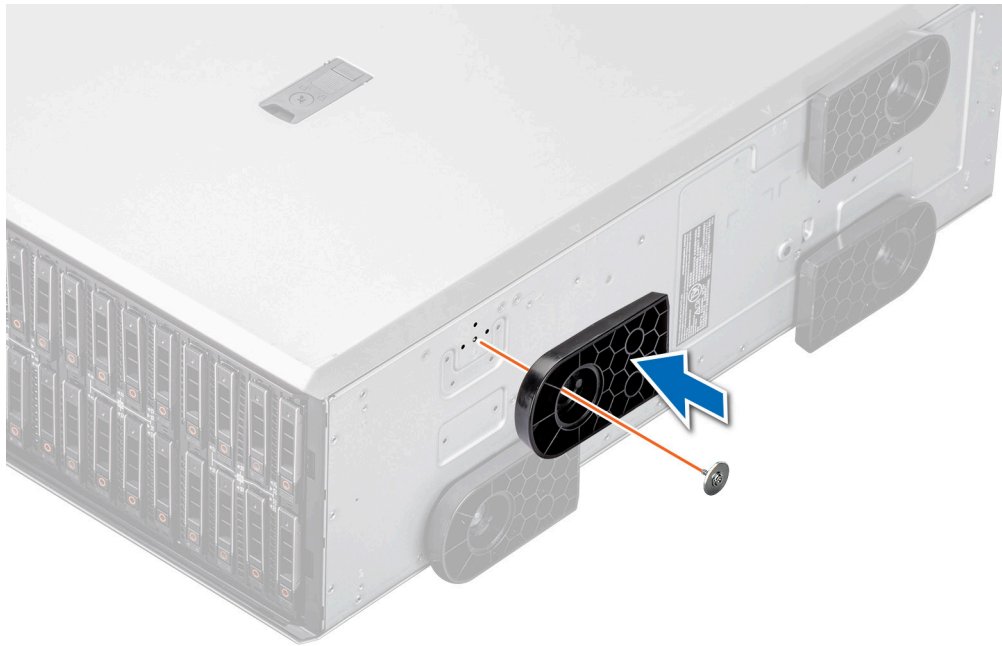

Figure 30. Installing the system feet

Next steps

1. Place the system upright on a flat, stable surface, and rotate the system feet outward.
2. Follow the procedure listed in [After working inside your system](#).

Optional caster wheels

Removing caster wheels

Prerequisites

1. Follow the safety guidelines listed in [Safety instructions](#).
2. If installed, [remove the system feet](#).
3. Place the system on a flat, stable surface.

Steps

Using the Phillips 2 screwdriver, loosen the captive screw and remove the caster wheel from the base of the system.



Figure 31. Removing caster wheels

Next steps

Replace the [caster wheels](#) or [Install the system feet](#).

Installing caster wheels

Prerequisites

1. Follow the safety guidelines listed in [Safety instructions](#).
2. Place the system on its side on a flat, stable surface.
3. If installed, [remove the system feet](#).

⚠ CAUTION: Install the **caster wheels on a stand-alone tower system to provide stability to the system. An unstable system might tip over and cause injury or damage to the system.**

ℹ NOTE: This T series server only uses Dell EMC caster wheels.

Steps

Align the caster wheel to the base of system and tighten the captive screw to secure the caster wheel into place.



Figure 32. Installing caster wheels

Next steps

Follow the procedure listed in [After working inside your system](#).

System cover

Removing the system cover

Prerequisites

1. Follow the safety guidelines listed in [Safety instructions](#).
2. Power off the system, and any attached peripherals.
3. Disconnect the system from the electrical outlet and peripherals.
4. If installed, [remove the front bezel](#).

Steps

1. Use a 1/4-inch flat head or a Phillips 2 screwdriver to turn the cover release latch lock counterclockwise to the unlock position.
2. Lift the release latch until the system cover slides back.
3. Lift the cover from the system.

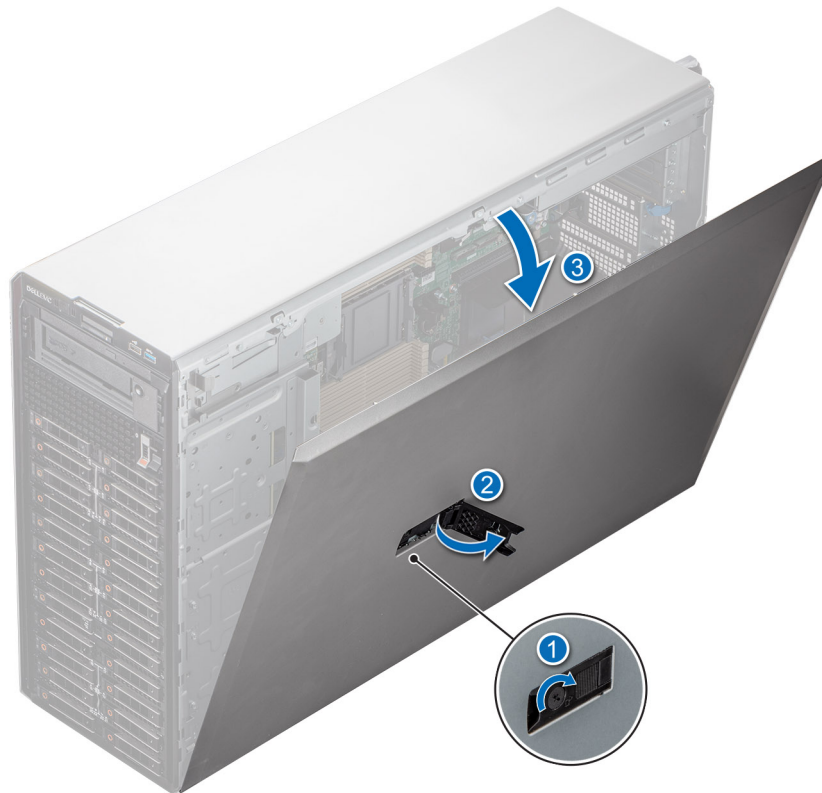

Figure 33. Removing the system cover

Next steps

Replace the system cover.

Installing the system cover

Prerequisites

Follow the safety guidelines listed in [Safety instructions](#).

i **NOTE:** Ensure that all internal cables are connected and placed out of the way and no tools or extra parts are left inside the system.

Steps

1. Align the tabs on the system cover with the guide slots on the system and slide the system cover.
2. Close the system cover release latch.
i **NOTE:** Ensure that the system cover closes without obstruction or unnecessary force. Reseat any cables or components or realign the system cover if necessary.
3. Using a 1/4-inch flat head or Phillips 2 screwdriver, rotate the lock clockwise to the lock position.

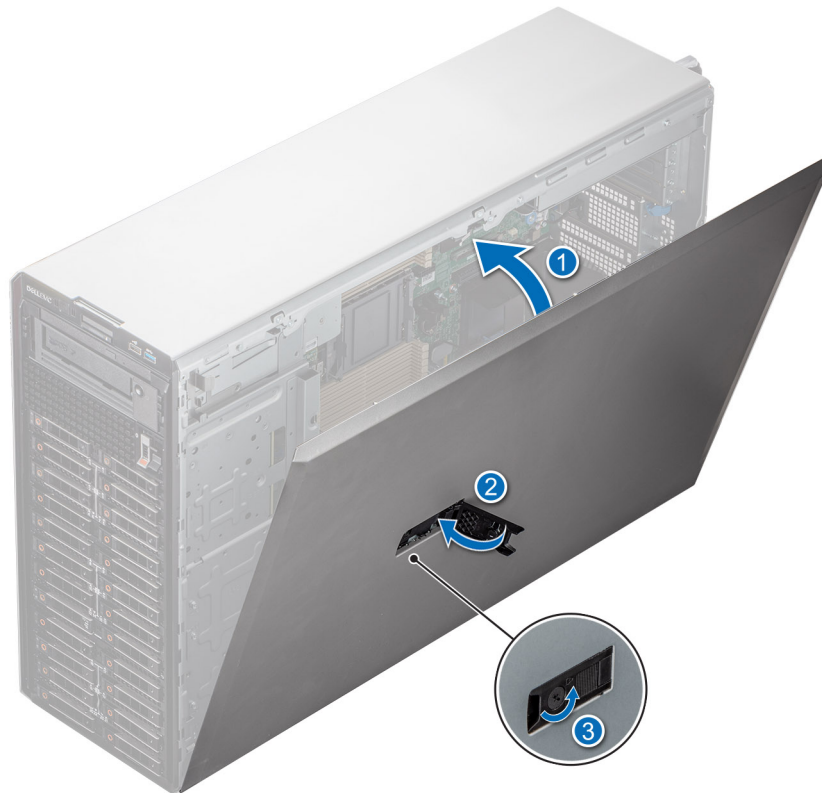

Figure 34. Installing the system cover

Next steps

1. If removed, [install the front bezel](#).
2. Reconnect the peripherals and connect the system to the electrical outlet.
3. Power on the system, including all attached peripherals.

Air shroud

Removing the air shroud

Prerequisites

CAUTION: Never operate your system with the air shroud removed. The system may get overheated quickly, resulting in shutdown of the system and loss of data.

1. Follow the safety guidelines listed in [Safety instructions](#).
2. Follow the procedure listed in [Before working inside your system](#).

Steps

Hold the edges of the air shroud, and lift the air shroud out of the system.

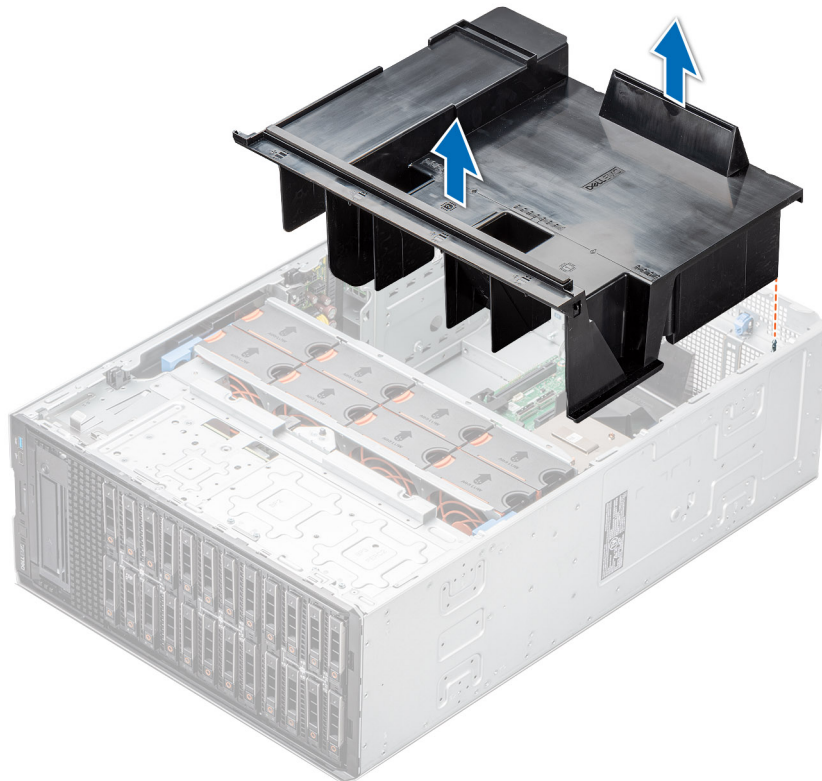

Figure 35. Removing the air shroud

Next steps

Replace the air shroud.

Installing the air shroud

Prerequisites

1. Follow the safety guidelines listed in [Safety instructions](#).
2. Follow the procedure listed in [Before working inside your system](#).
3. If applicable, route the cables inside the system along the chassis wall and secure the cables by using the cable-securing bracket.

Steps

1. Align the tabs on the air shroud with the guide pins on the system.
2. Lower the air shroud into the system, until firmly seated.

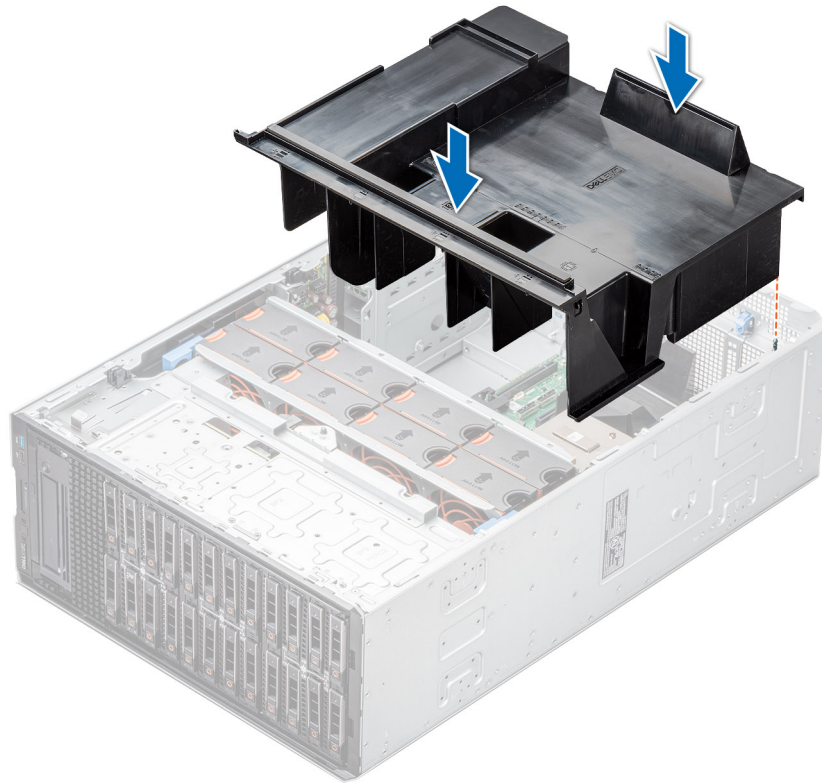

Figure 36. Installing the air shroud

Next steps

Follow the procedure listed in [After working inside your system](#).

Cooling fans

Removing a cooling fan

The procedure for removing a standard and a high-performance fan is identical.

Prerequisites

NOTE: Opening or removing the system cover when the system is on may expose you to a risk of electric shock. Exercise utmost care while removing or installing cooling fans.

CAUTION: The cooling fans are hot swappable. To maintain proper cooling while the system is on, replace only one fan at a time.

1. Follow the safety guidelines listed in [Safety instructions](#).
2. Follow the procedure that is listed in [Before working inside your system](#).

Steps

Press the release tab and lift the cooling fan out of the cooling fan cage.

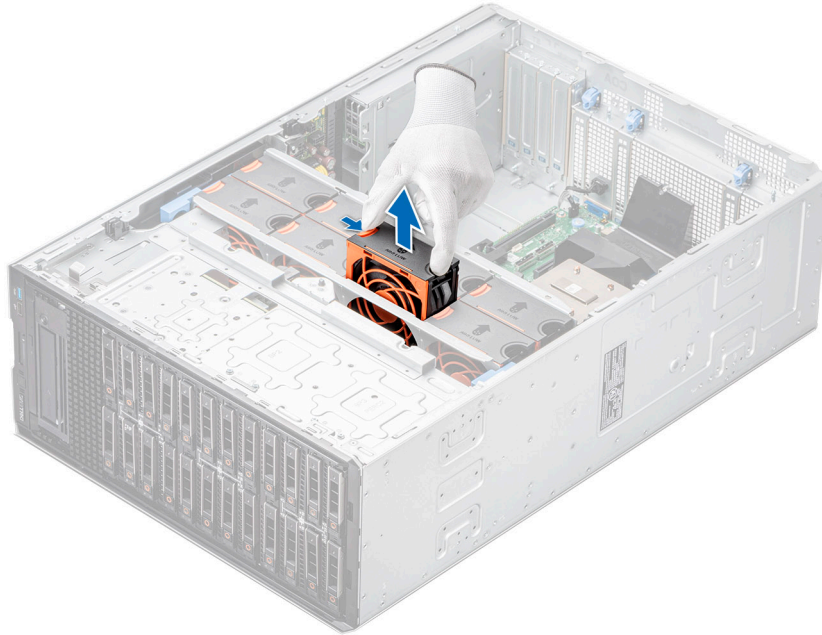

Figure 37. Removing a cooling fan

Next steps

Replace a cooling fan.

Installing a cooling fan

The procedure for installing a standard and a high-performance fan is identical.

Prerequisites

NOTE: Opening or removing the system cover when the system is on may expose you to a risk of electric shock. Exercise utmost care while removing or installing cooling fans.

CAUTION: The cooling fans are hot swappable. To maintain proper cooling while the system is on, replace only one fan at a time.

1. Follow the safety guidelines listed in [Safety instructions](#).
2. Follow the procedure that is listed in [Before working inside your system](#).

Steps

Align and slide the cooling fan in the slot in the cooling fan cage, until it clicks into place.

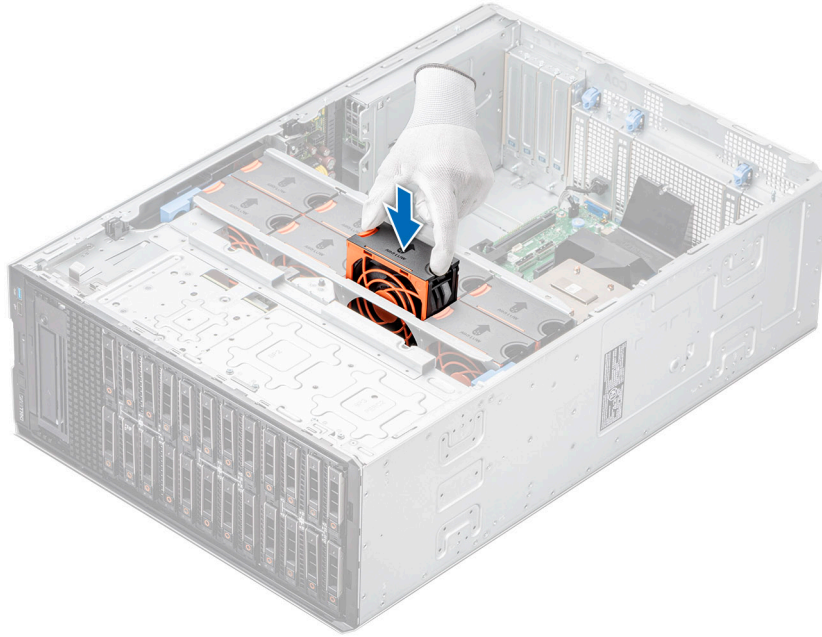

Figure 38. Installing a cooling fan

Next steps

1. [Install the air shroud.](#)
2. Follow the procedure listed in [After working inside your system.](#)

Cooling fan cage

Removing the cooling fan cage

Prerequisites

1. Follow the safety guidelines listed in [Safety instructions.](#)
2. Follow the procedure that is listed in [Before working inside your system.](#)
3. [Remove the air shroud.](#)

Steps

1. Lift the blue release levers to disengage the cooling fan cage from the system.
2. Hold the blue release levers, and lift the cooling fan cage from the system.

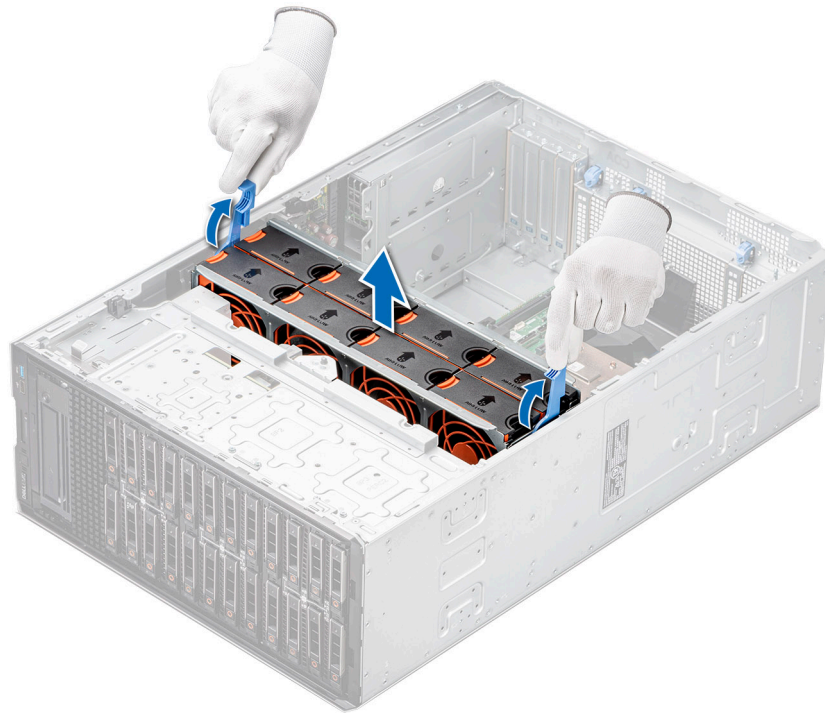

Figure 39. Removing the cooling fan cage

Next steps

Replace the cooling fan cage.

Installing the cooling fan cage

Prerequisites

Follow the safety guidelines listed in [Safety instructions](#).

CAUTION: Ensure that the cables inside the system are correctly installed and retained by the cable retention bracket before installing the cooling fan cage. Incorrectly installed cables may get damaged.

Steps

1. Holding the blue release levers, align the guide rails on the cooling fan cage with the standoffs on the system.
2. Lower the cooling fan cage into the system until the cooling fan connectors engage with the connectors on the system board.
3. Press the blue release levers to lock the cooling fan cage into the system.



Figure 40. Installing the cooling fan cage

Next steps

1. Install the air shroud.
2. Follow the procedure listed in [After working inside your system.](#)

Fan board tray

Fan board view

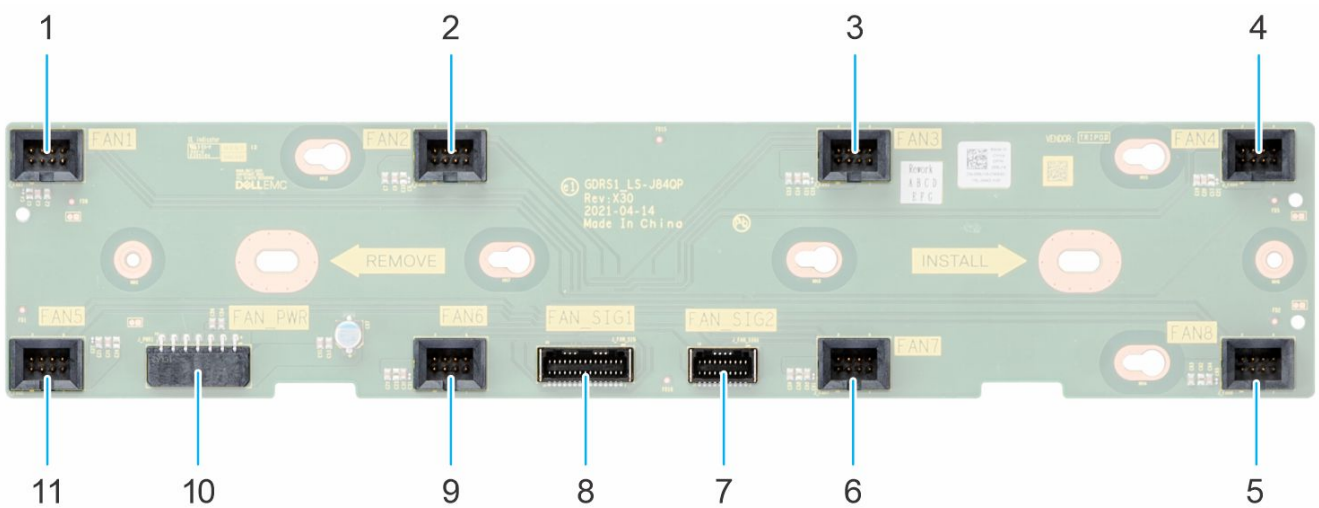

Figure 41. Fan board connectors

- | | |
|---------|---------|
| 1. FAN1 | 2. FAN2 |
| 3. FAN3 | 4. FAN4 |
| 5. FAN8 | 6. FAN7 |

- 7. FAN_SIG2
- 9. FAN6
- 11. FAN5

- 8. FAN_SIG1
- 10. FAN_PWR

Removing the fan board tray

Prerequisites

- 1. Follow the safety guidelines listed in [Safety instructions](#).
- 2. Follow the procedure that is listed in [Before working inside your system](#).
- 3. [Remove the air shroud](#).
- 4. [Remove the cooling fan cage](#).
- 5. Disconnect the cables that are connected to the fan board.

Steps

- 1. Loosen the captive screw and slide the fan board tray to the right of the system to disengage it from the chassis.
- 2. Lift the fan board tray out of the system.

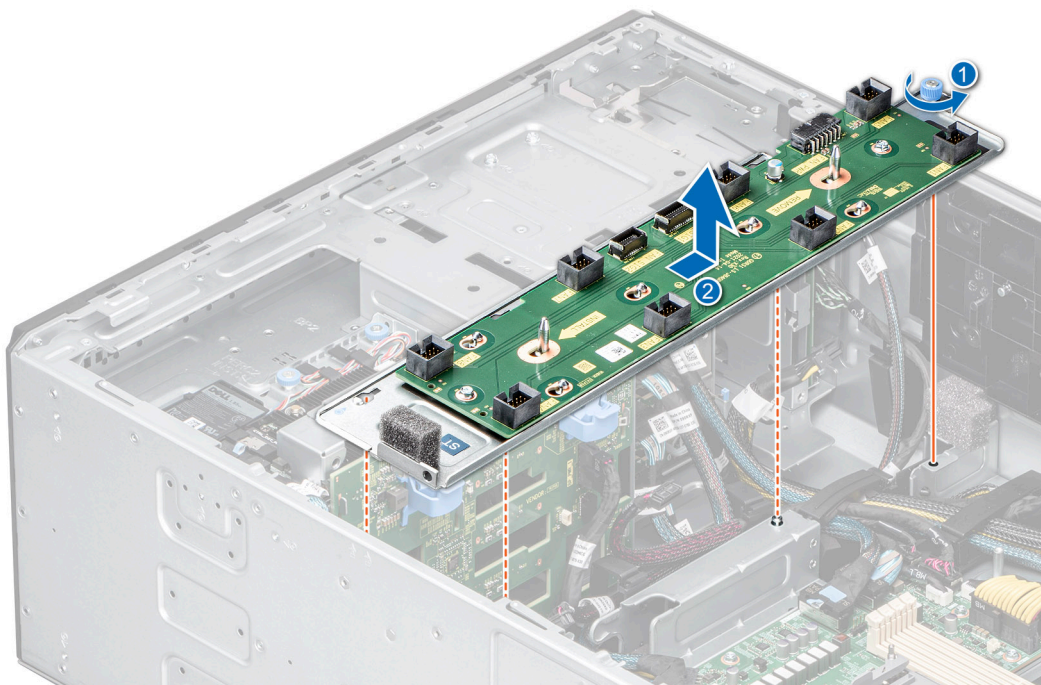

Figure 42. Removing the fan board tray

Next steps

Replace the fan board tray.

Installing the fan board tray

Prerequisites

- 1. Follow the safety guidelines listed in [Safety instructions](#).
- 2. Follow the procedure that is listed in [Before working inside your system](#).
- 3. [Remove the air shroud](#).
- 4. [Remove the cooling fan cage](#).
- 5. Disconnect the cables that are connected to the fan board.

Steps

1. Align the fan board tray to the guide pins on the system, slide the tray to the left of the system to lock it in place.
2. Tighten the captive screw to secure the fan board tray to the system.

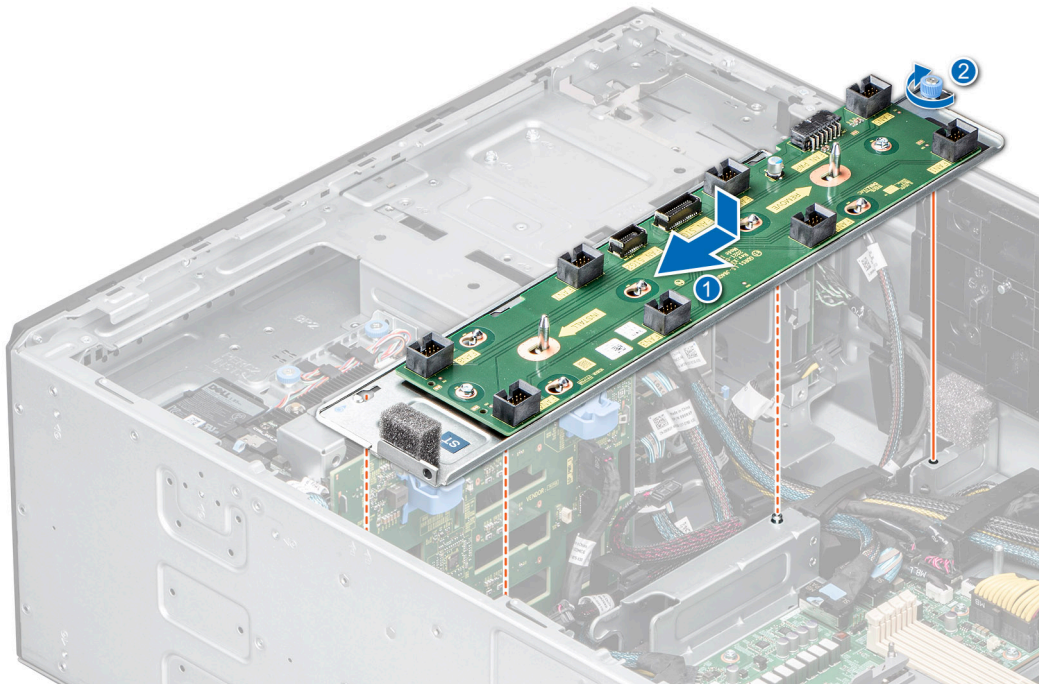

Figure 43. Installing the fan board tray

Next steps

1. Connect the cables to the fan board.
2. [Install the cooling fan cage.](#)
3. [Install the air shroud.](#)
4. Follow the procedure listed in [After working inside your system.](#)

Front PERC module

Removing the front PERC module

Prerequisites

1. Follow the safety guidelines listed in [Safety instructions.](#)
2. Follow the procedure that is listed in [Before working inside your system.](#)
3. Disconnect all the cables connected to the front PERC module.

Steps

1. Using a Phillips 2 screwdriver, loosen the captive screws on the front PERC module.
2. Slide the front PERC module to disengage from the connector on the drive backplane.

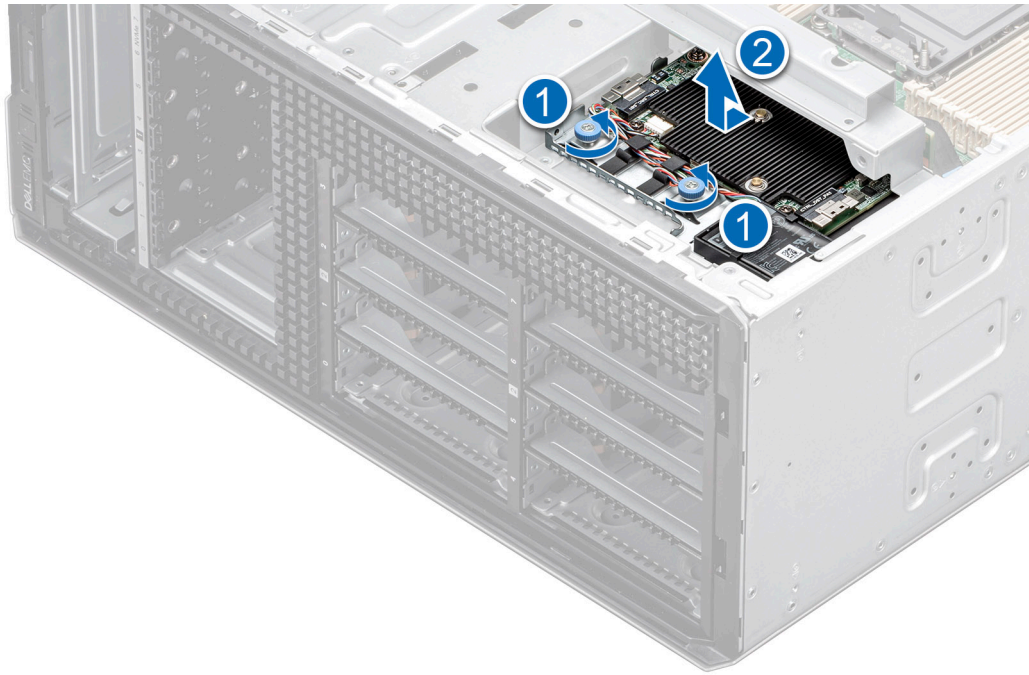

Figure 44. Removing the front PERC module for 3.5-inch drive backplane

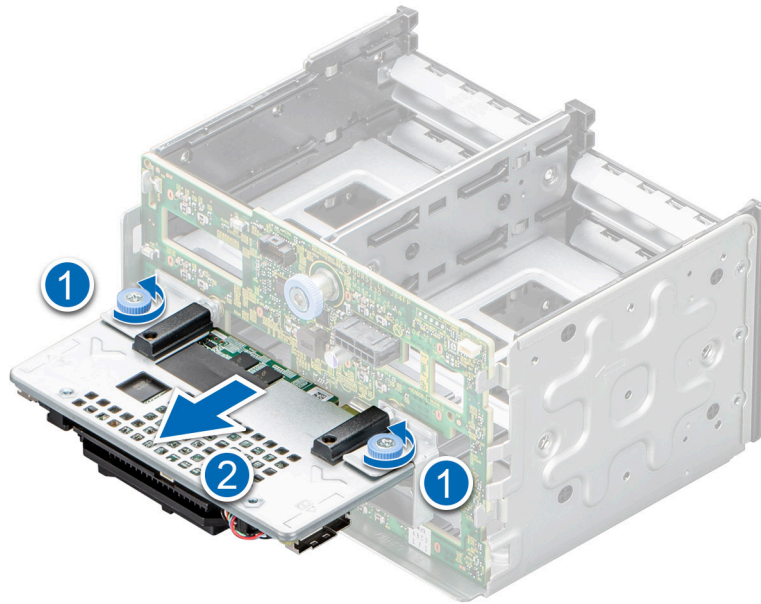

Figure 45. Removing the front PERC module for 2.5-inch drive backplane.

Next steps

Replace the front PERC module.

Installing the front PERC module

Prerequisites

1. Follow the safety guidelines listed in [Safety instructions](#).
2. Follow the procedure that is listed in [Before working inside your system](#).

3. Disconnect all the cables connected to the front PERC module.

Steps

1. Align the connectors and guide slots on the front PERC module with the connectors and guide pins on the drive backplane.
2. Slide the front PERC module until the module is connected to the drive backplane.
3. Using a Phillips 2 screwdriver, tighten the captive screws on the front PERC module.

NOTE: The numbers on the image do not depict the exact steps. The numbers are for representation of sequence.

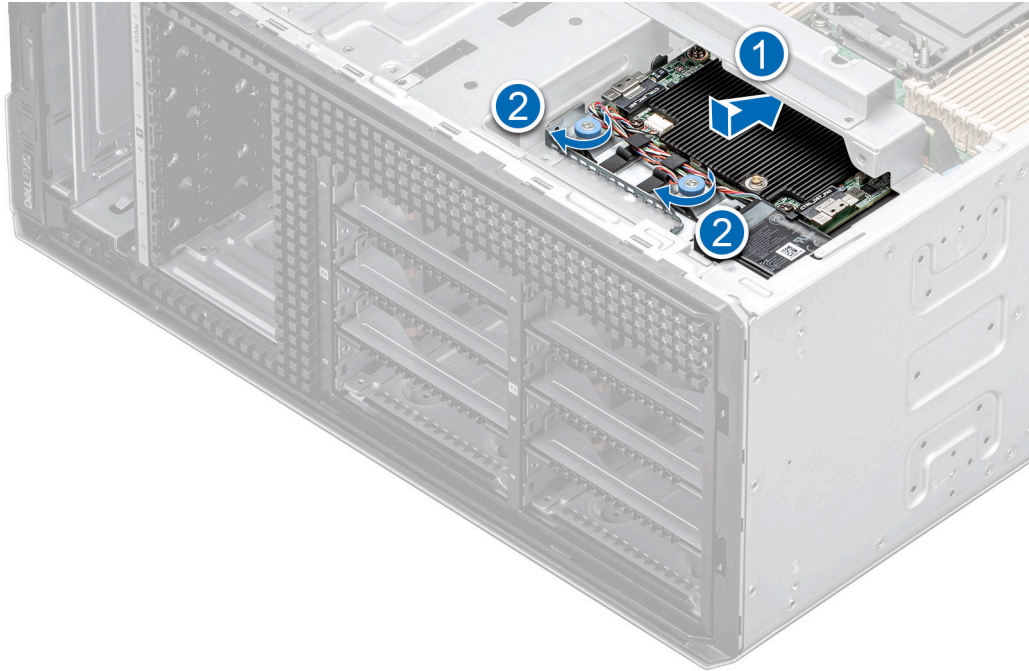

Figure 46. Installing the front PERC module for 3.5-inch drive backplane.

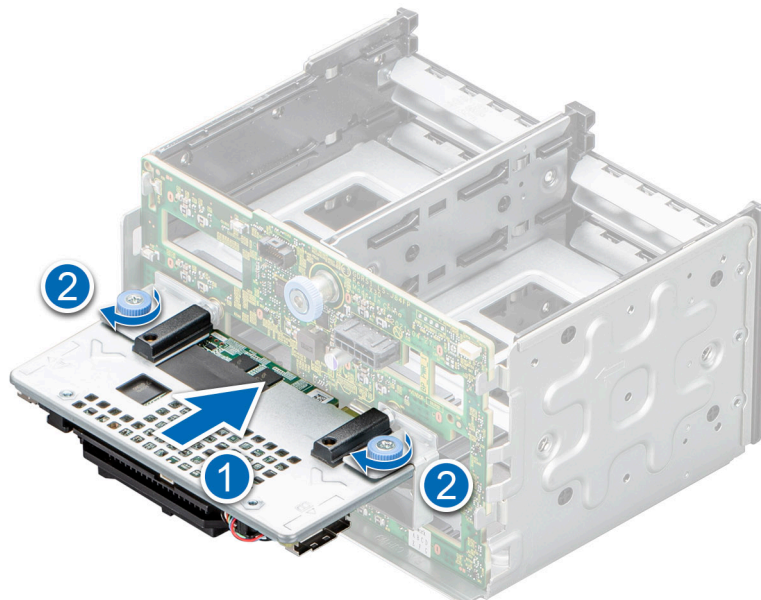

Figure 47. Installing the front PERC module for 2.5-inch drive backplane.

Next steps

1. Connect the cables to the front PERC module.
2. Follow the procedure listed in [After working inside your system](#).

Drives

Removing a drive blank

The procedure for removing 2.5 inch and 3.5-inch drive blanks is identical.

Prerequisites

1. Follow the safety guidelines listed in [Safety instructions](#).
2. If installed, [remove the front bezel](#).

CAUTION: To maintain proper system cooling, drive blanks must be installed in all empty drive slots.

CAUTION: Mixing drive blanks from previous generations of PowerEdge servers is not supported.

Steps

Press the release button, and slide the drive blank out of the drive slot.

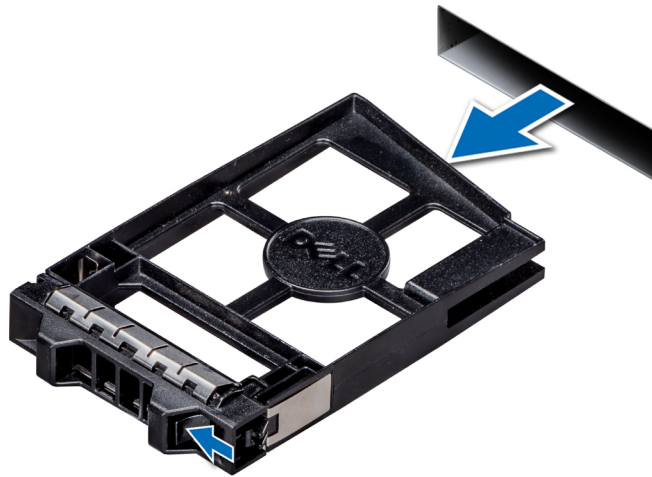

Figure 48. Removing a drive blank

Next steps

Install a drive or drive blank.

Installing a drive blank

The procedure for installing 2.5 inch and 3.5-inch drive blanks is identical.

Prerequisites

1. Follow the safety guidelines listed in [Safety instructions](#).
2. If installed, [remove the front bezel](#).

CAUTION: Mixing drive blanks from previous generations of PowerEdge servers is not supported.

Steps

Insert the drive blank into the drive slot, and push the blank until the release button clicks into place.

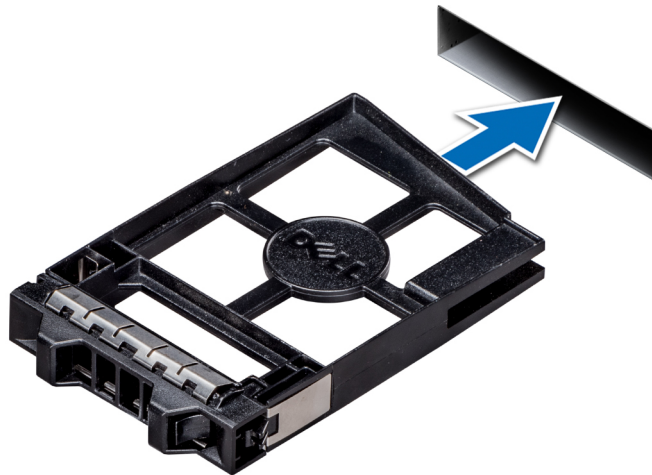

Figure 49. Installing a drive blank

Next steps

If removed, [install the front bezel](#).

Removing a drive carrier

Prerequisites

1. Follow the safety guidelines listed in [Safety instructions](#).
2. If applicable, [remove the front bezel](#).
3. Using the management software, prepare the drive for removal.

If the drive is online, the green activity or fault indicator flashes while the drive is turning off. When the drive indicators are off, the drive is ready for removal. For more information, see the documentation for the storage controller.

CAUTION: Before attempting to remove or install a drive while the system is running, see the documentation for the storage controller card to ensure that the host adapter is configured correctly to support drive removal and insertion.

CAUTION: Mixing drives from previous generations of PowerEdge servers is not supported.

CAUTION: To prevent data loss, ensure that your operating system supports drive installation. See the documentation supplied with your operating system.

Steps

1. Press the release button to open the drive carrier release handle.
2. Holding the handle, slide the drive carrier out of the drive slot.

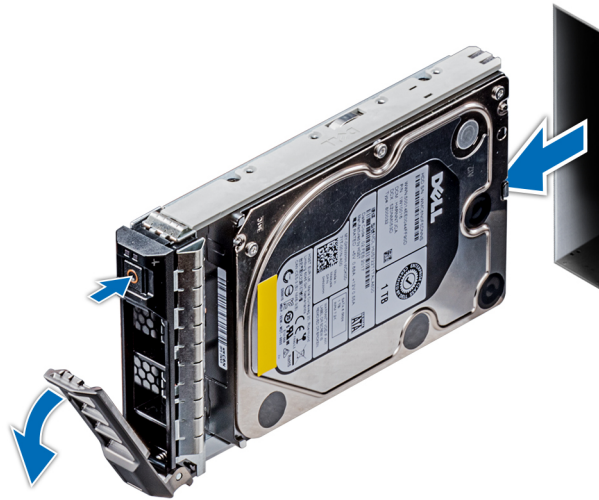

Figure 50. Removing a drive carrier

Next steps

1. [Installing a drive carrier](#).
2. If you are not replacing the drive immediately, [install a drive blank](#) in the empty drive slot to maintain proper system cooling.

Installing a drive carrier

Prerequisites

- ⚠ **CAUTION:** Before attempting to remove or install a drive while the system is running, see the documentation for the storage controller card to ensure that the host adapter is configured correctly to support drive removal and insertion.
- ⚠ **CAUTION:** Mixing drives from previous generations of PowerEdge servers is not supported.
- ⚠ **CAUTION:** Combining SAS and SATA drives in the same RAID volume is not supported.
- ⚠ **CAUTION:** When installing a drive, ensure that the adjacent drives are fully installed. Inserting a drive carrier and attempting to lock its handle next to a partially installed carrier can damage the partially installed carrier's shield spring and make it unusable.
- ⚠ **CAUTION:** To prevent data loss, ensure that your operating system supports hot-swap drive installation. See the documentation supplied with your operating system.
- ⚠ **CAUTION:** When a replacement hot swappable drive is installed and the system is powered on, the drive automatically begins to rebuild. Ensure that the replacement drive is blank or contains data that you wish to overwrite. Any data on the replacement drive is immediately lost after the drive is installed.

1. Follow the safety guidelines listed in [Safety instructions](#).
2. If installed, [remove the drive blank](#).

Steps

1. Press the release button on the front of the drive carrier to open the release handle.
2. Insert the drive carrier into the drive slot and slide until the drive connects with the backplane.
3. Close the drive carrier release handle to lock the drive in place.

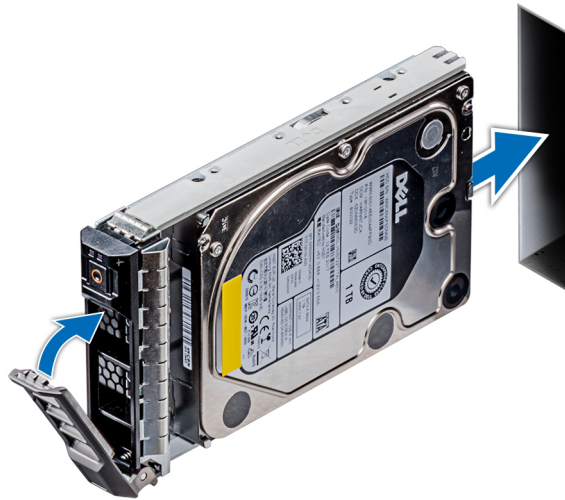

Figure 51. Installing a drive carrier

Next steps

If removed, [install the front bezel](#).

Removing the drive from the drive carrier

Prerequisites

Follow the safety guidelines listed in [Safety instructions](#).

CAUTION: Mixing drives from previous generations of PowerEdge servers is not supported.

Steps

1. Using a Phillips 1 screwdriver, remove the screws from the slide rails on the drive carrier.
 - NOTE:** If the drive carrier has Torx screw, use Torx 6 (for 2.5-inch drive) or Torx 8 (for 3.5-inch drive) screwdriver to remove the drive. 
2. Lift the drive out of the drive carrier.

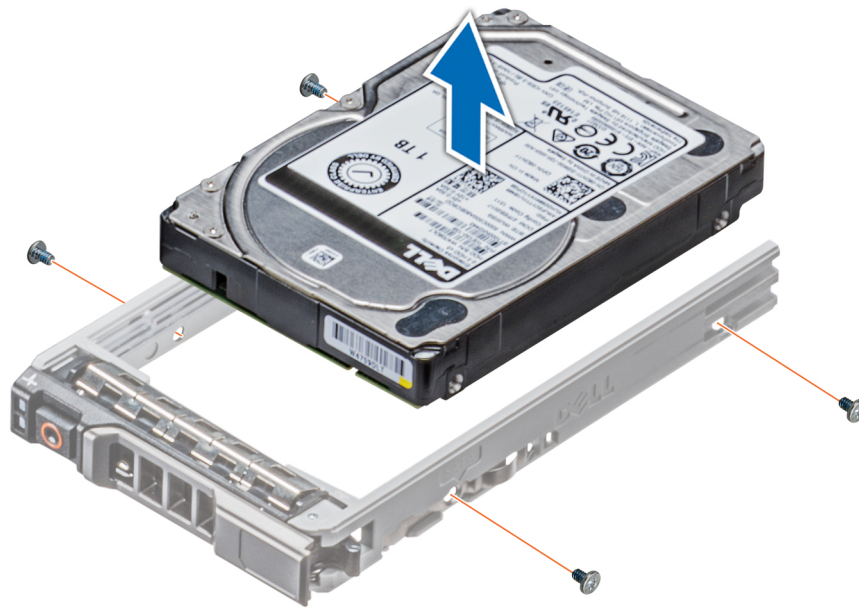

Figure 52. Removing the drive from the drive carrier

Next steps

Replacing the drive into the drive carrier.

Installing a drive into the drive carrier

Prerequisites

Follow the safety guidelines listed in [Safety instructions](#).

CAUTION: Mixing drive carriers from other generations of PowerEdge servers is not supported.

NOTE: When installing a drive into the drive carrier, ensure that the screws are torqued to 4 in-lbs.

Steps

1. Insert the drive into the drive carrier with the connector end of the drive towards the back of the carrier.
2. Align the screw holes on the drive with the screws holes on the drive carrier.
When aligned correctly, the back of the drive is flush with the back of the drive carrier.
3. Using a Phillips 1 screwdriver, secure the drive to the drive carrier with screws.

NOTE: If the drive carrier has Torx screw, use Torx 6 (for 2.5-inch drive) or Torx 8 (for 3.5-inch drive) screwdriver to install the drive. 

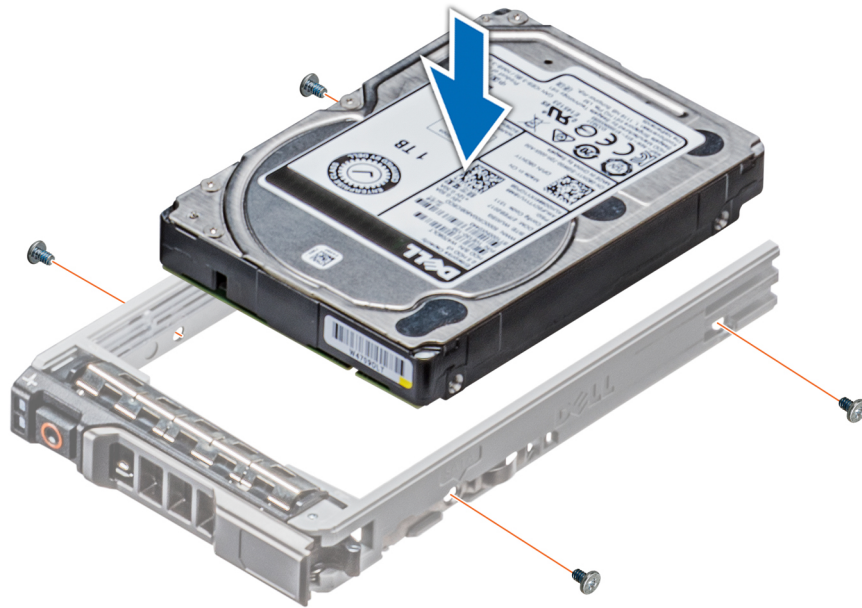

Figure 53. Installing a drive into the drive carrier

Removing a 3.5-inch drive adapter from a 3.5-inch drive carrier

Prerequisites

1. Follow the safety guidelines listed in [Safety instructions](#).
2. If installed, [remove the front bezel](#).
3. [Remove the drive carrier](#).

Steps

1. Using a Phillips 1 screwdriver, remove the screws from the rails on the drive carrier.

i **NOTE:** If the drive carrier has Torx screw, use Torx 6 (for 2.5-inch drive) or Torx 8 (for 3.5-inch drive) screwdriver to remove the drive. 

2. Lift the 3.5-inch drive adapter out of the 3.5-inch drive carrier.

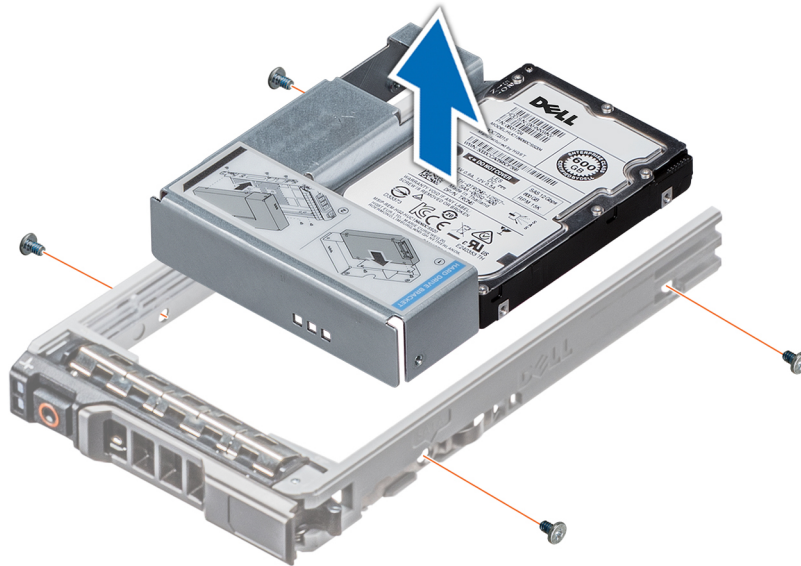

Figure 54. Removing a 3.5-inch drive adapter from a 3.5-inch drive carrier

Next steps

Replace the 3.5-inch drive adapter into the 3.5-inch drive carrier.

Installing a 3.5-inch drive adapter into the 3.5-inch drive carrier

Prerequisites

1. Follow the safety guidelines listed in [Safety instructions](#).
2. [Install the 2.5 inch drive into the 3.5-inch drive adapter](#).

Steps

1. Insert the 3.5-inch drive adapter into the 3.5-inch drive carrier with the connector end of the drive toward the back of the 3.5-inch drive carrier.
2. Align the screw holes on the 3.5-inch drive adapter with the holes on the 3.5-inch drive carrier.
3. Using a Phillips 1 screwdriver, secure the 3.5-inch drive adapter to the 3.5-inch carrier.

NOTE: If the drive carrier has Torx screw, use Torx 6 (for 2.5-inch drive) or Torx 8 (for 3.5-inch drive) screwdriver to install the drive. 

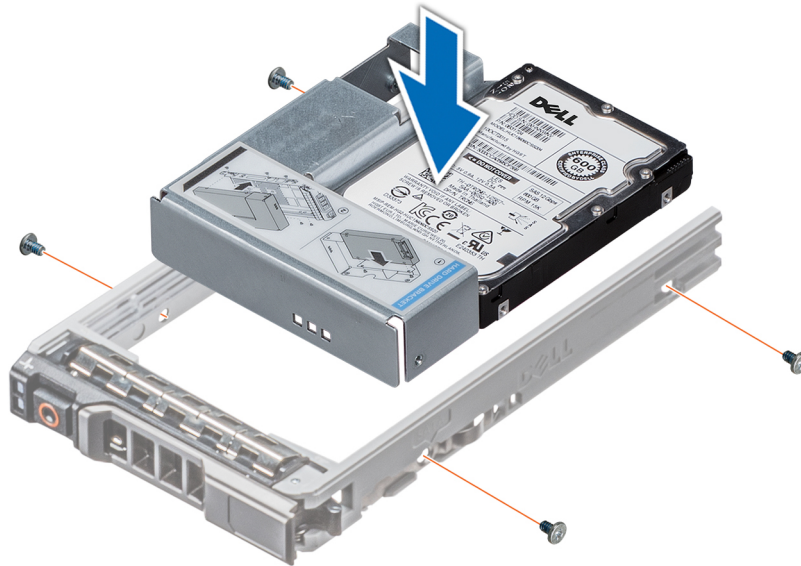

Figure 55. Installing a 3.5-inch drive adapter into the 3.5-inch drive carrier

Next steps

1. [Install the drive carrier.](#)
2. If removed, [install the front bezel.](#)

Removing a 2.5-inch drive from a 3.5-inch drive adapter

Prerequisites

1. Follow the safety guidelines listed in [Safety instructions](#).
2. [Remove the 3.5-inch drive adapter from the 3.5-inch drive carrier.](#)

i **NOTE:** A 2.5-inch drive is installed in a 3.5-inch drive adapter, which is then installed in the 3.5-inch drive carrier.

Steps

1. Using a Phillips 2 screwdriver, remove the screws from the side of the 3.5-inch drive adapter.

i **NOTE:** If the drive carrier has Torx screw, use Torx 6 screwdriver to remove the drive. 

2. Remove the 2.5-inch drive from the 3.5-inch drive adapter.

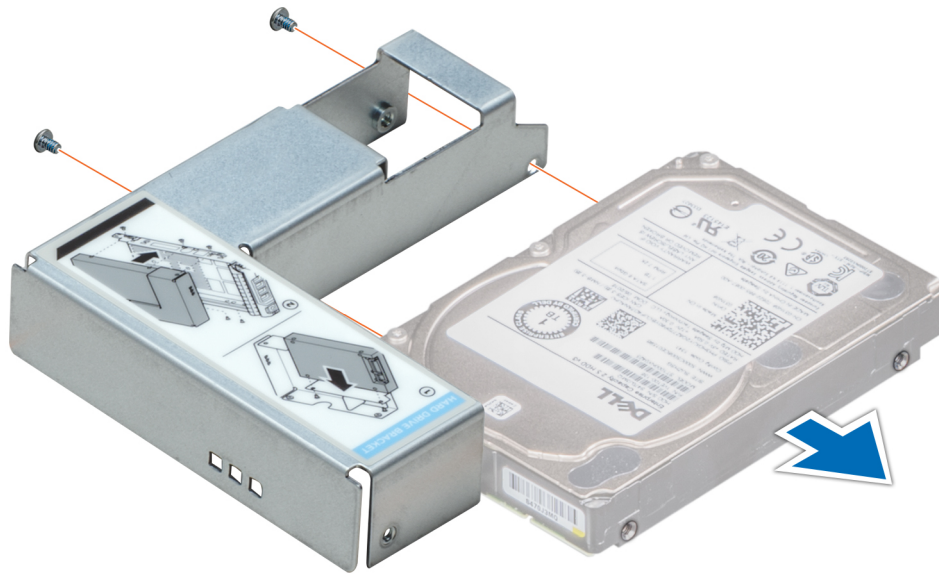

Figure 56. Removing a 2.5-inch drive from a 3.5-inch drive adapter

Next steps

Install a 2.5-inch drive into a 3.5-inch drive adapter.

Installing a 2.5-inch drive into a 3.5-inch drive adapter

Prerequisites

1. Follow the safety guidelines listed in [Safety instructions](#).
2. Remove the 3.5-inch drive adapter from the 3.5-inch hot swappable drive carrier.

Steps

1. Align the screw holes on the 2.5-inch drive with the screw holes on the 3.5-inch drive adapter.
2. Using a Phillips 2 screwdriver, secure the 2.5-inch drive to the 3.5-inch drive adapter.

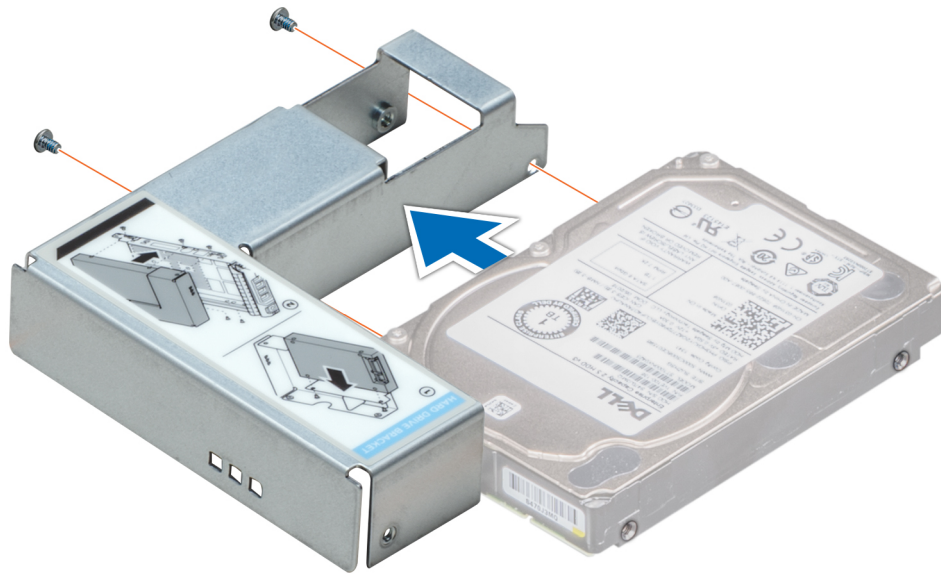

Figure 57. Installing a 2.5-inch drive into a 3.5-inch drive adapter

Next steps

Install the 3.5-inch drive adapter into the 3.5-inch hot swappable drive carrier.

Drive backplane

Drive backplane

The PowerEdge T550 supports a 3.5-inch SAS/SATA and 2.5-inch SAS/SATA/NVMe drive backplane.

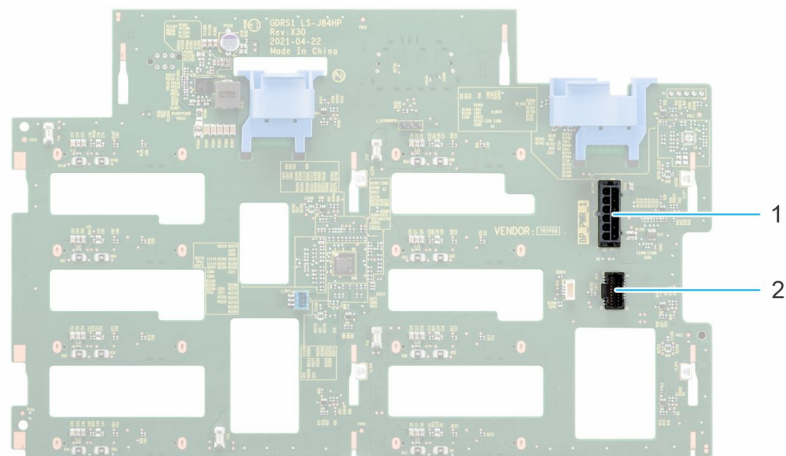

Figure 58. 3.5-inch drive backplane

1. BP_PWR_1
2. BP_SIG

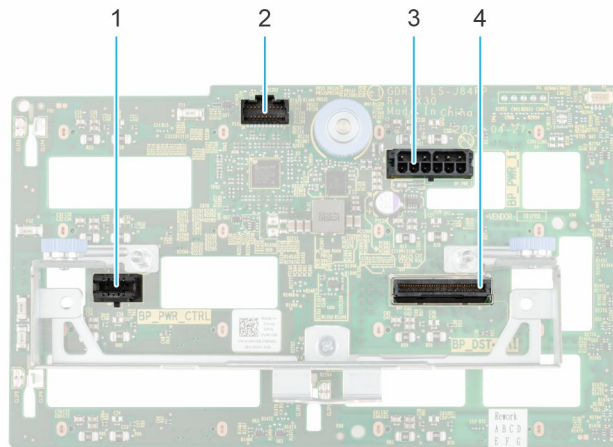

Figure 59. 2.5-inch drive backplane

- | | |
|----------------|---------------|
| 1. BP_PWR_CTRL | 2. BP_SIG |
| 3. BP_PWR_1 | 4. BP_DST_PA1 |

Removing the 3.5-inch drive backplane

Prerequisites

CAUTION: To prevent damage to the drives and backplane, remove the drives from the system before removing the backplane.

CAUTION: Note the number of each drive and temporarily label them before you remove the drive so that you can reinstall them in the same location.

NOTE: The procedure to remove the backplane is similar for all backplane configurations.

1. Follow the safety guidelines listed in [Safety instructions](#).
2. Follow the procedure that is listed in [Before working inside your system](#).
3. [Remove the cooling fan cage](#).
4. [Remove the drives](#).
5. [Remove the front PERC module](#).
6. Disconnect the drive backplane cables from the connector on the backplane.

Steps

1. Press the blue release tabs to disengage the drive backplane from the hooks on the system.
2. Lift and pull the drive backplane out of the system.

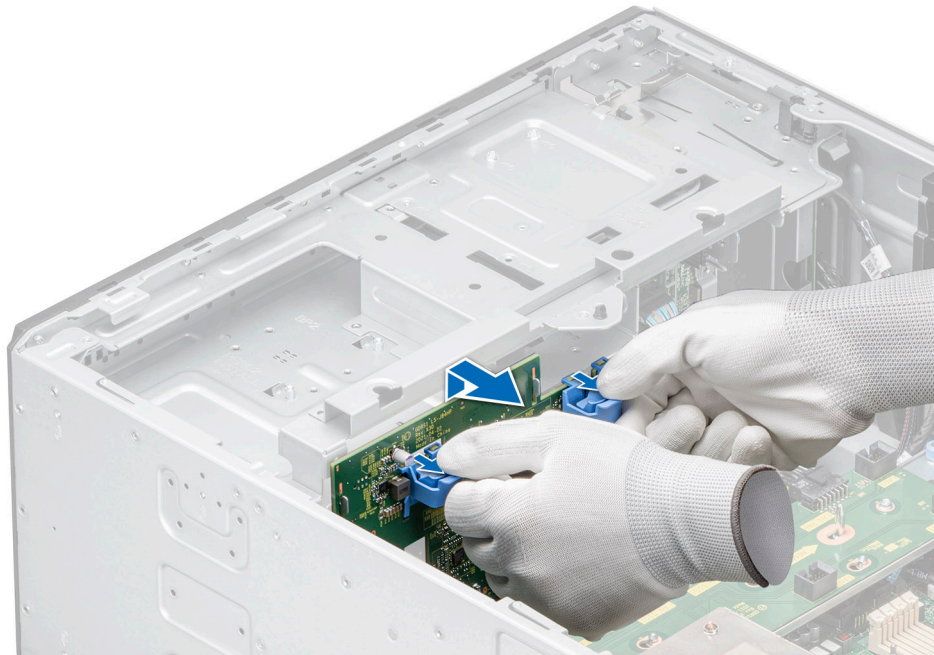

Figure 60. Removing the 3.5-inch drive backplane

Next steps

Replace the 3.5-inch drive backplane.

Installing the 3.5-inch drive backplane

Prerequisites

1. Follow the safety guidelines listed in [Safety instructions](#).
2. Follow the procedure that is listed in [Before working inside your system](#).
3. [Remove the cooling fan cage](#).
4. [Remove the drives](#).
5. [Remove the front PERC module](#).

NOTE: To avoid damaging the backplane, ensure to move the control panel cables from the cable routing clips before removing the backplane.

NOTE: Route the cable properly when you replace it to prevent the cable from being pinched or crimped.

Steps

1. Align the guides on the system with the slots on the backplane.
2. Insert the backplane into the guides and lower the backplane until the blue release tabs clicks into place.
3. Route the cables properly through the cable guide and connect the cables to the connector on the system board.

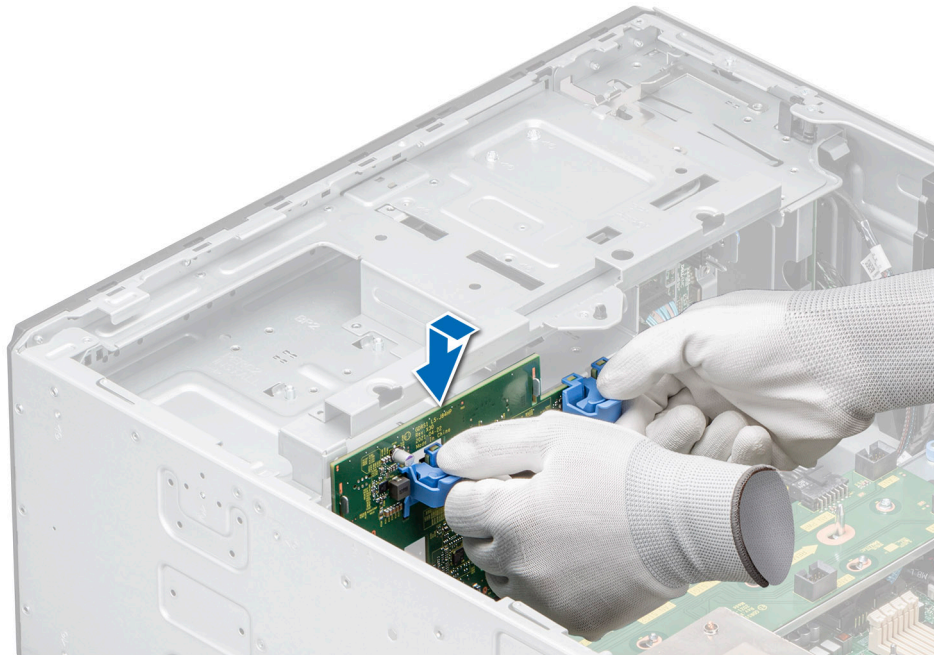

Figure 61. Installing the 3.5-inch drive backplane

Next steps

1. [Install the drives.](#)
2. Connect the drive backplane cables to the connector on the backplane.
3. [Install the cooling fan cage.](#)
4. [Install the front PERC module.](#)
5. Follow the procedure listed in [After working inside your system.](#)

Removing the 2.5-inch drive backplane

Prerequisites

CAUTION: To prevent damage to the drives and backplane, remove the drives from the system before removing the backplane.

CAUTION: Note the number of each drive and temporarily label them before you remove the drive so that you can reinstall them in the same location.

NOTE: The procedure to remove the backplane is similar for all backplane configurations.

1. Follow the safety guidelines listed in [Safety instructions.](#)
2. Follow the procedure that is listed in [Before working inside your system.](#)
3. [Remove the cooling fan cage.](#)
4. [Remove the drives.](#)
5. [Remove the front PERC module.](#)
6. Disconnect the drive backplane cables from the connectors on the backplane.

Steps

1. Pull the blue release stand-off to disengage the drive backplane from the hooks on the system.
2. Lift and pull the drive backplane out of the system.

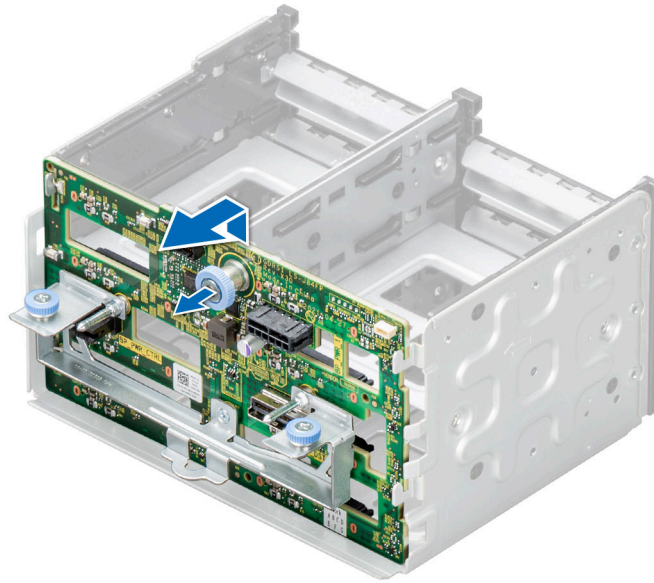

Figure 62. Removing the 2.5-inch drive backplane

Next steps

Replace the 2.5-inch drive backplane.

Installing the 2.5-inch drive backplane

Prerequisites

1. Follow the safety guidelines listed in [Safety instructions](#).
2. Follow the procedure that is listed in [Before working inside your system](#).
3. [Remove the cooling fan cage](#).
4. [Remove the drives](#).
5. [Remove the front PERC module](#).

NOTE: Route the cable properly when you replace it to prevent the cable from being pinched or crimped.

Steps

1. Align the guides on the system with the slots on the backplane.
2. Insert the backplane into the guides and lower the backplane until the blue release stand-off clicks into place.

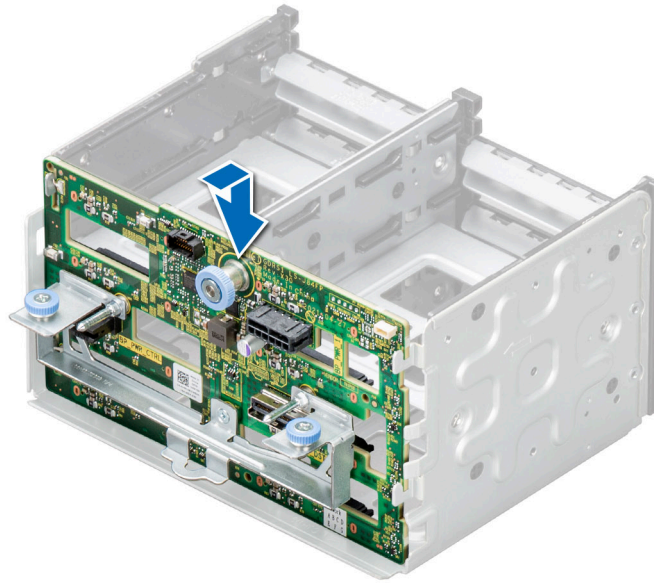

Figure 63. Installing the 2.5-inch drive backplane

Next steps

1. [Install the drives.](#)
2. Connect the drive backplane cables to the connector on the backplane.
3. [Install the cooling fan cage.](#)
4. [Install the front PERC module.](#)
5. Follow the procedure listed in [After working inside your system.](#)

Drive bays

Removing the drive bay cage blank

Prerequisites

1. Follow the safety guidelines listed in the [Safety instructions.](#)
2. If installed, [remove the front bezel.](#)

Steps

Using a flat head screwdriver, remove the drive bay cage blank.

i **NOTE:** The procedure to remove the drive cage blanks are similar.

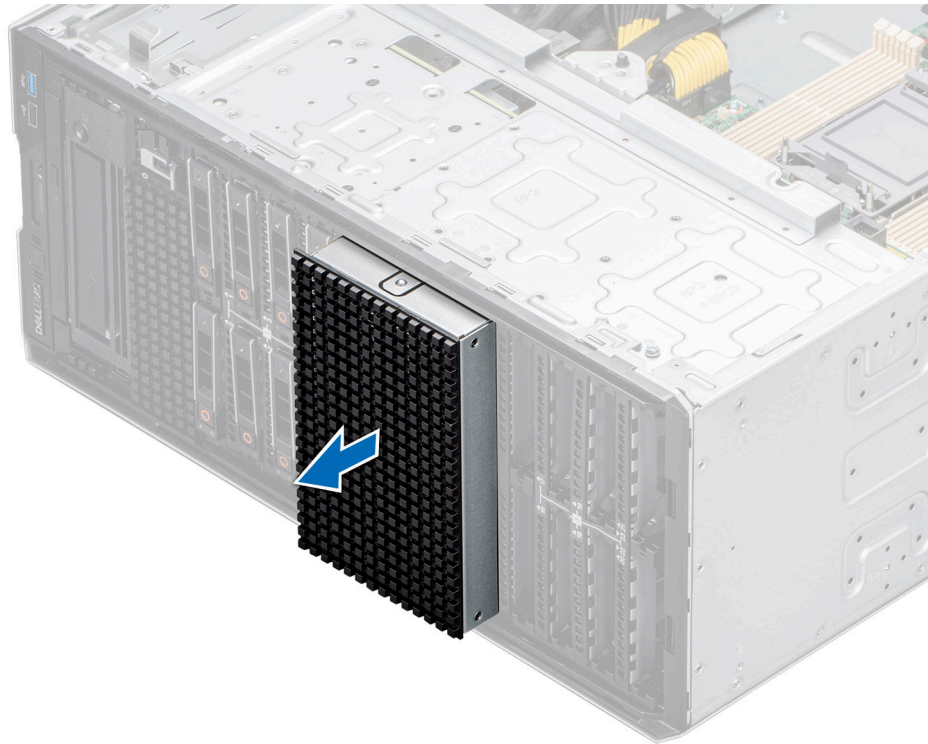

Figure 64. Removing the drive bay cage blank

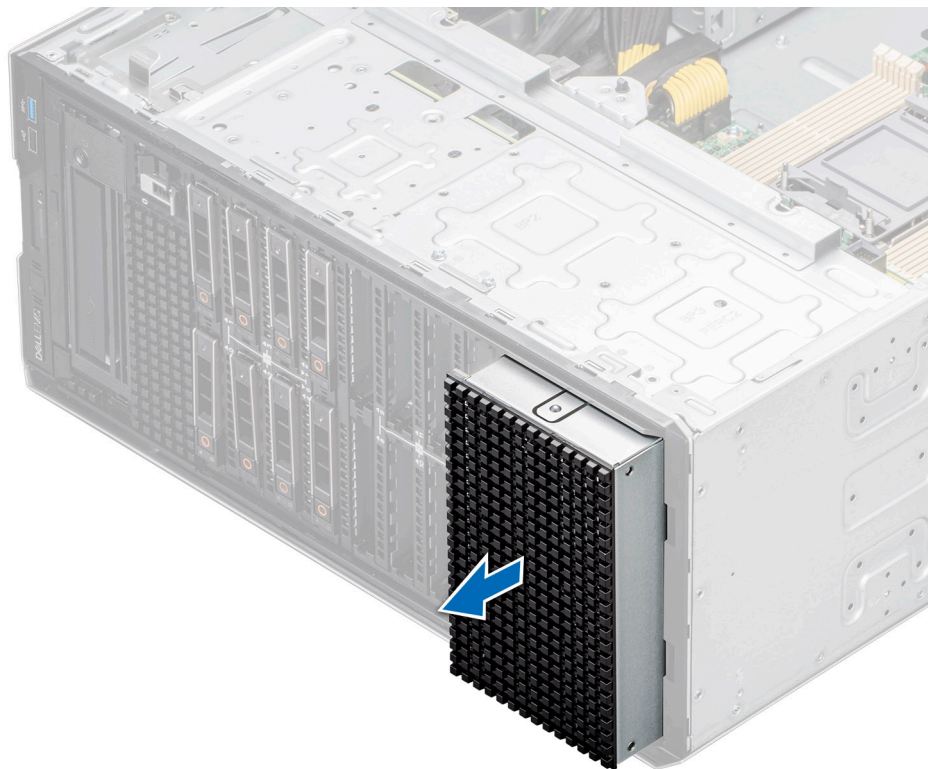

Figure 65. Removing the drive bay cage blank

Next steps

Replace the drive bay cage blank or install drive bay cage.

Installing the drive bay cage blank

Prerequisites

Follow the safety guidelines listed in the [Safety instructions](#).

Steps

Align and push the blank into the drive bay slot, until it clicks into place.

i **NOTE:** The procedure to install the drive cage blanks are similar.

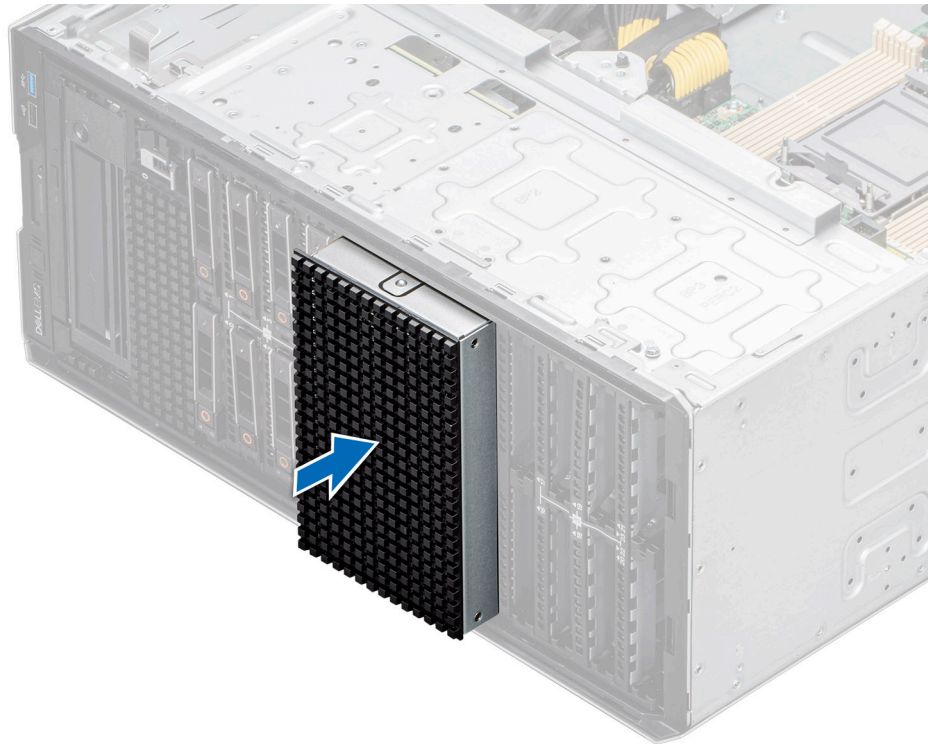

Figure 66. Installing the drive bay cage blank

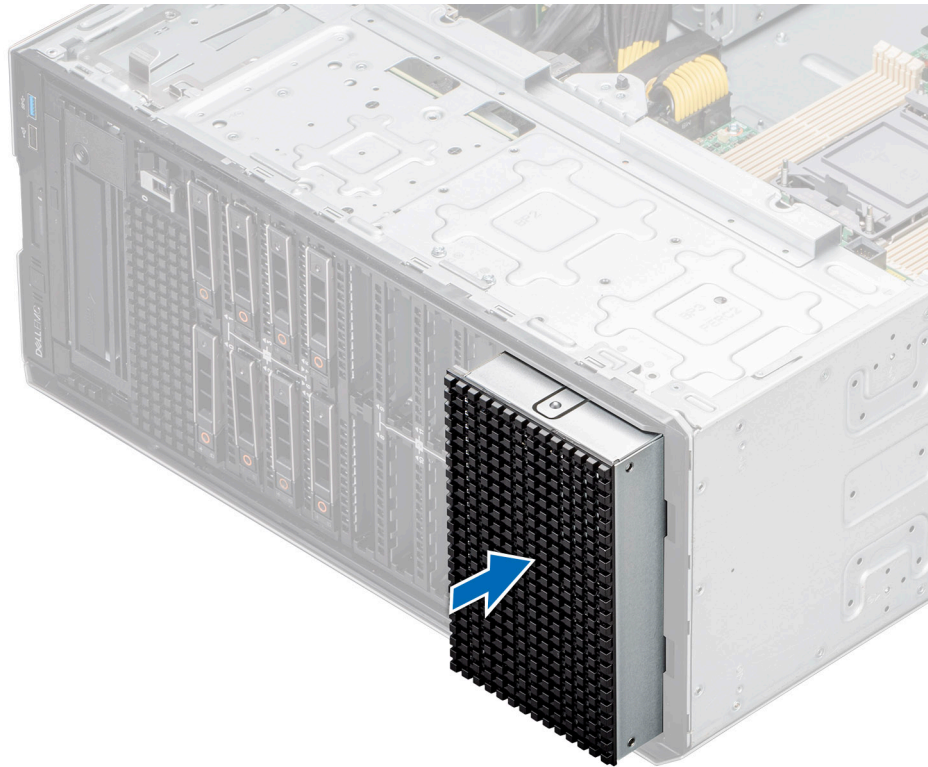

Figure 67. Installing the drive bay cage blank

Next steps

1. If removed, [install the front bezel](#).
2. Follow the procedure listed in [After working inside your system](#).

Removing a drive bay

Prerequisites

1. Follow the safety guidelines listed in [Safety instructions](#).
2. Follow the procedure that is listed in [Before working inside your system](#).
3. [Remove all the drives](#).
4. [Remove the backplane from drive bay](#).

Steps

1. Using the Phillips 2 screwdriver, remove the screws securing the drive bay to the system.
2. Slide the drive bay out of the system.

i **NOTE:** The procedure to remove the drive bays is similar for all configurations.

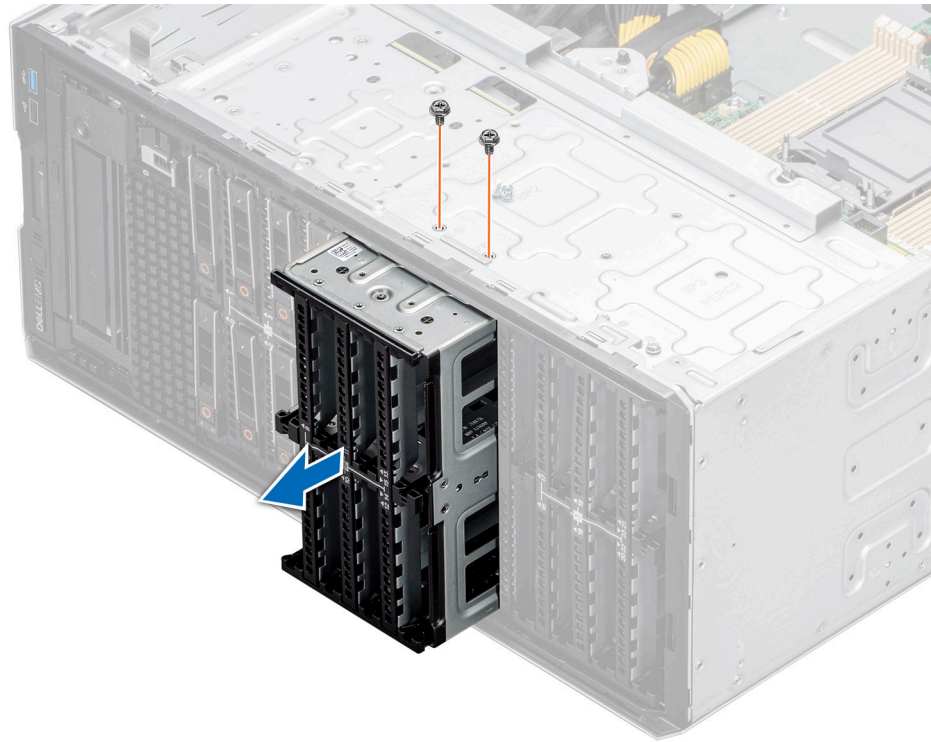

Figure 68. Removing a drive bay

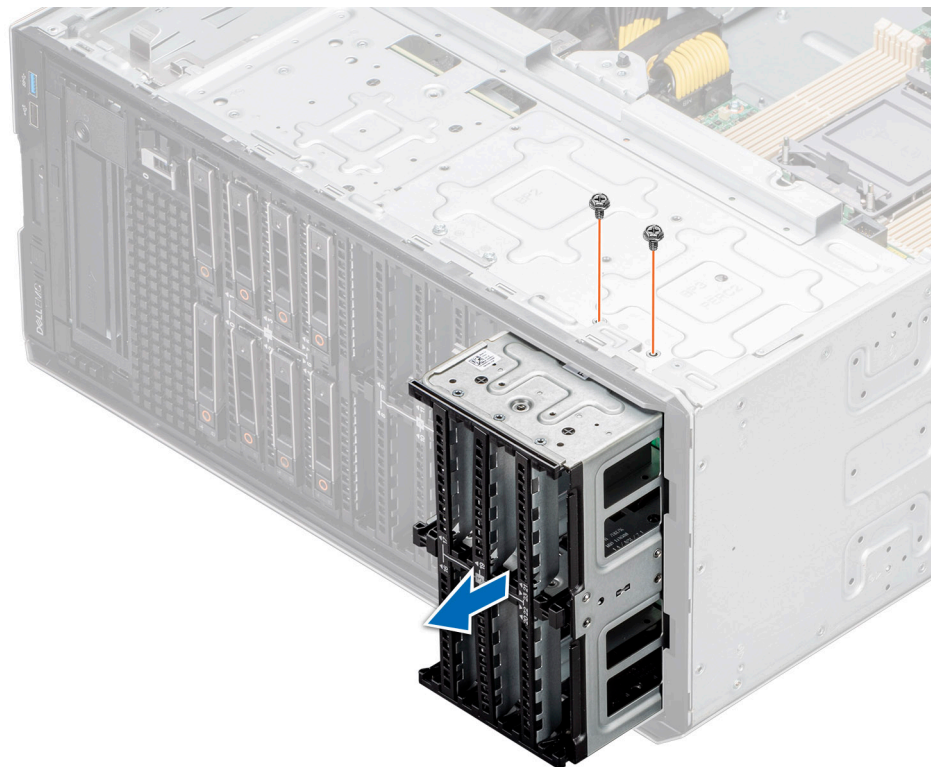

Figure 69. Removing a drive bay

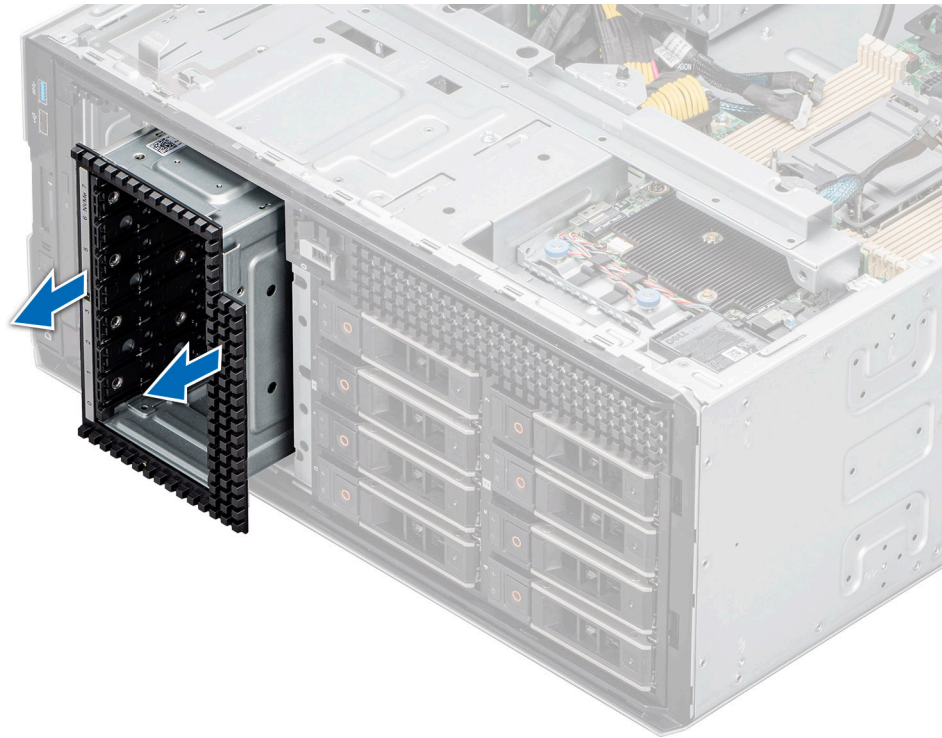

Figure 70. Removing a NVMe drive bay

Next steps

Replacing the drive bay.

Installing a drive bay

Prerequisites

1. Follow the safety guidelines listed in [Safety instructions](#).
2. Follow the procedure that is listed in [Before working inside your system](#).
3. [Remove all the drives](#).
4. [Remove the backplane from drive bay](#).

Steps

1. Insert the drive bay into the drive bay slot in the system.
2. Using the Phillips 2 screwdriver secure the drive bay to the system.

i **NOTE:** The procedure to install the drive bays is similar for all configurations.

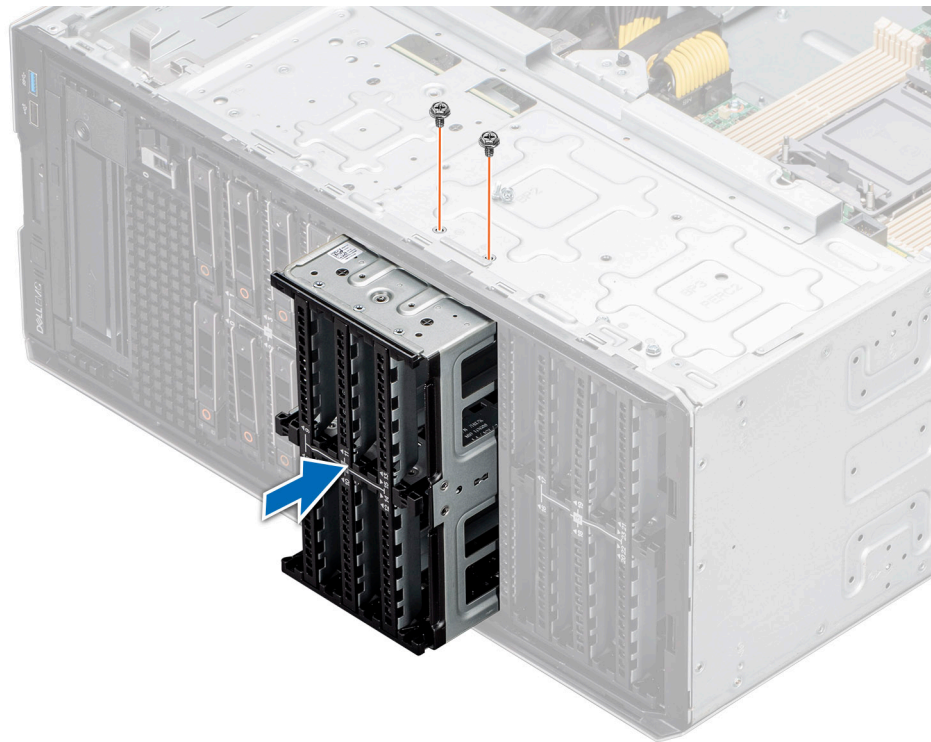

Figure 71. Installing a drive bay

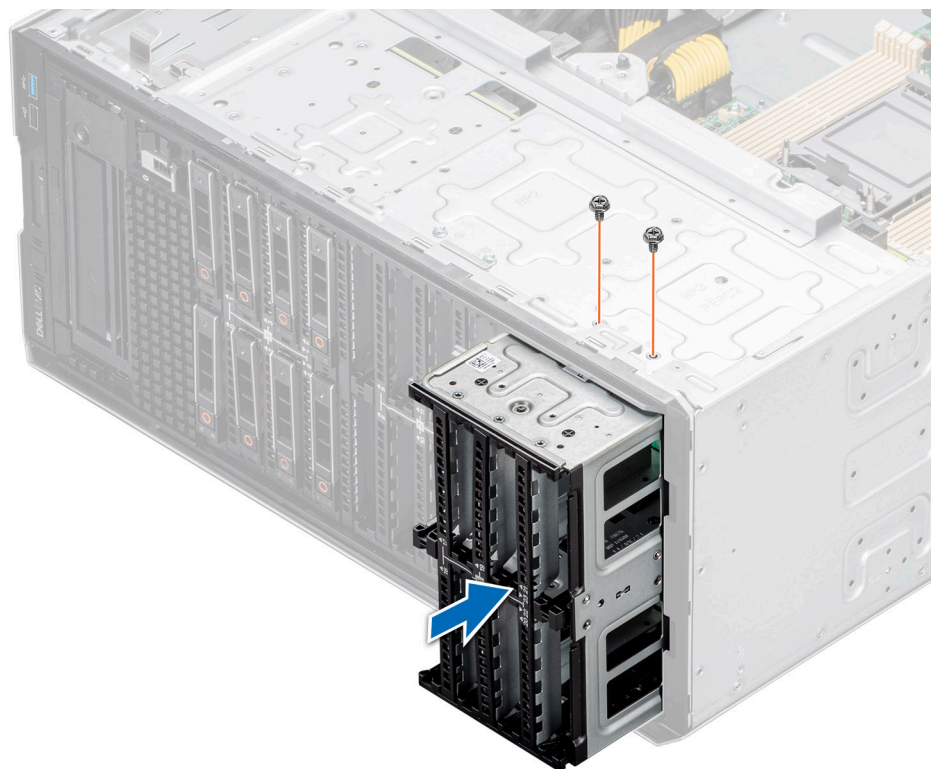

Figure 72. Installing a drive bay

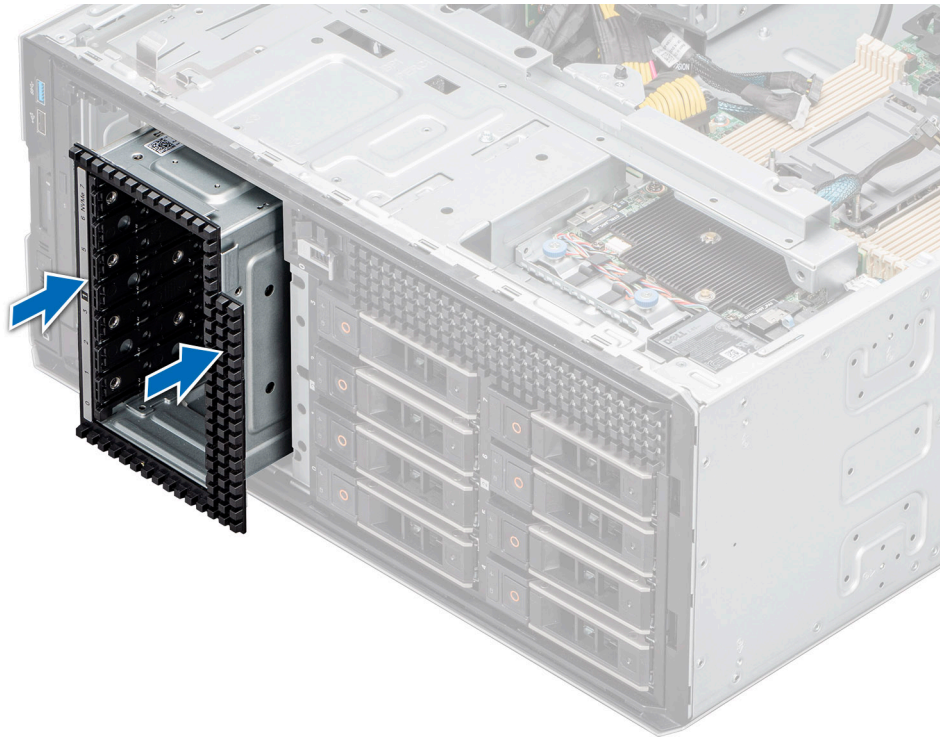

Figure 73. Installing a NVME drive bay

Next steps

1. [Install the backplane to the drive bay.](#)
2. [Install the drives.](#)
3. Follow the procedure listed in [After working inside your system.](#)

Cable routing

NOTE: The cable routing shown for the connectors PIB_SIG_1, PIB_SIG_2 and SYS_PWR_1 are same for all configurations.

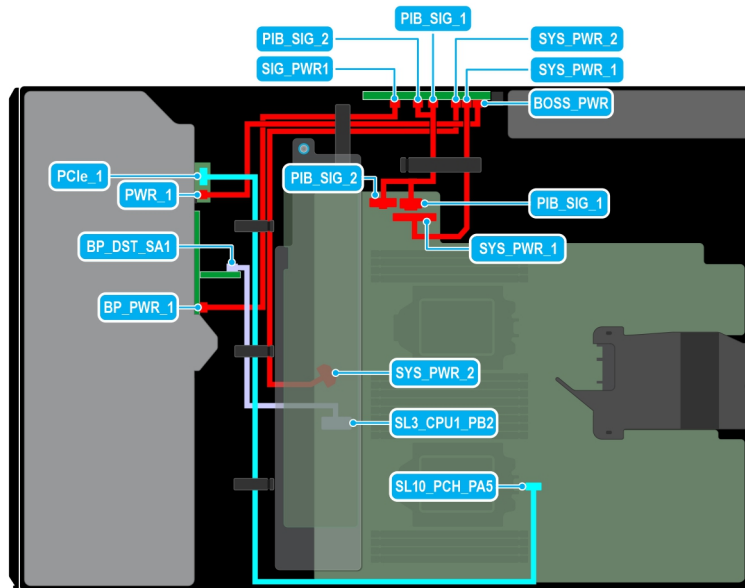

Figure 74. Cable routing - 8 x 2.5-inch SAS with BOSS S2 module

Table 15. Cable routing - 8 x 2.5-inch SAS with BOSS S2 module

From	To
PCIe_1 (Signal connector on BOSS S2 module)	SL10_PCH_PA5 (Signal connector on system board)
PWR_1 (Power connector on BOSS S2 module)	BOSS_PWR (Power connector on PIB)
CTRL_DST_PA1 (Signal connector on PERC)	SL3_CPU1_PB2 (Signal connector on system board)
BP_PWR_1 (Power connector on backplane)	SIG_PWR_1 (Power connector on PIB)
SYS_PWR_1 (Power connector on system board)	SYS_PWR_1 (Power connector on PIB)
SYS_PWR_2 (Power connector on system board)	SYS_PWR_2 (Power connector on PIB)
PIB_SIG_1 (Power connector on system board)	PIB_SIG_1 (Power connector on PIB)
PIB_SIG_2 (Power connector on system board)	PIB_SIG_2 (Power connector on PIB)

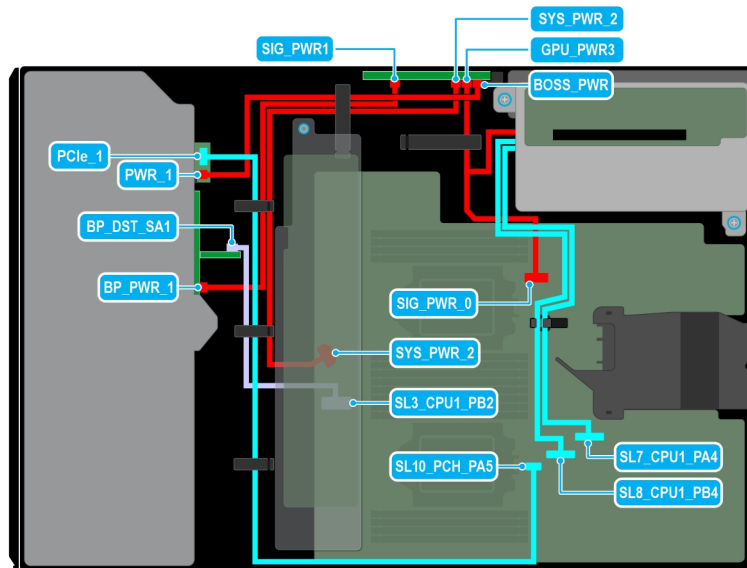

Figure 75. Cable routing - 8 x 2.5-inch SAS with GPU riser

Table 16. Cable routing - 8 x 2.5-inch SAS with GPU riser

From	To
PCIe_1 (Signal connector on BOSS S2 module)	SL10_PCH_PA5 (Signal connector on system board)
PWR_1 (Power connector on BOSS S2 module)	BOSS_PWR (Power connector on PIB)
CTRL_DST_PA1 (Signal connector on PERC)	SL3_CPU1_PB2 (Signal connector on system board)
BP_PWR_1 (Power connector on backplane)	SIG_PWR_1 (Power connector on PIB)
SIG_PWR_0 (Power connector on system board)	RISER_PWR_1 (Power connector on GPU riser)
GPU_PWR_3 (Power connector on PIB)	RISER_PWR_1 (Power connector on GPU riser)
SL7_CPU1_PA4 (Signal connector on system board)	RISER_DST_PA1 (Signal connector on GPU riser 1)
SL8_CPU1_PB4 (Signal connector on system board)	RISER_DST_PB1 (Signal connector on GPU riser 1)

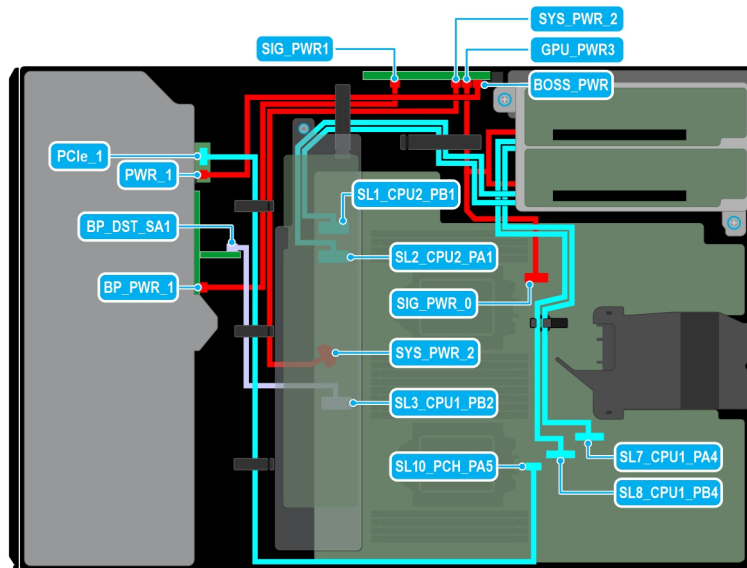

Figure 76. Cable routing - 8 x 2.5-inch SAS with two GPU risers

Table 17. Cable routing - 8 x 2.5-inch SAS with two GPU risers

From	To
PCIe_1 (Signal connector on BOSS S2 module)	SL10_PCH_PA5 (Signal connector on system board)
PWR_1 (Power connector on BOSS S2 module)	BOSS_PWR (Power connector on PIB)
CTRL_DST_PA1 (Signal connector on PERC)	SL3_CPU1_PB2 (Signal connector on system board)
BP_PWR_1 (Power connector on backplane)	SIG_PWR_1 (Power connector on PIB)
SIG_PWR_0 (Power connector on system board)	RISER_PWR_1 (Power connector on GPU riser)
GPU_PWR_3 (Power connector on PIB)	RISER_PWR_1 (Power connector on GPU riser)
SL7_CPU1_PA4 (Signal connector on system board)	RISER_DST_PA1 (Signal connector on GPU riser 1)
SL8_CPU1_PB4 (Signal connector on system board)	RISER_DST_PB1 (Signal connector on GPU riser 1)
SL1_CPU2_PB1 (Signal connector on system board)	RISER_DST_PB1 (Signal connector on GPU riser 2)
SL2_CPU2_PA1 (Signal connector on system board)	RISER_DST_PA1 (Signal connector on GPU riser 2)

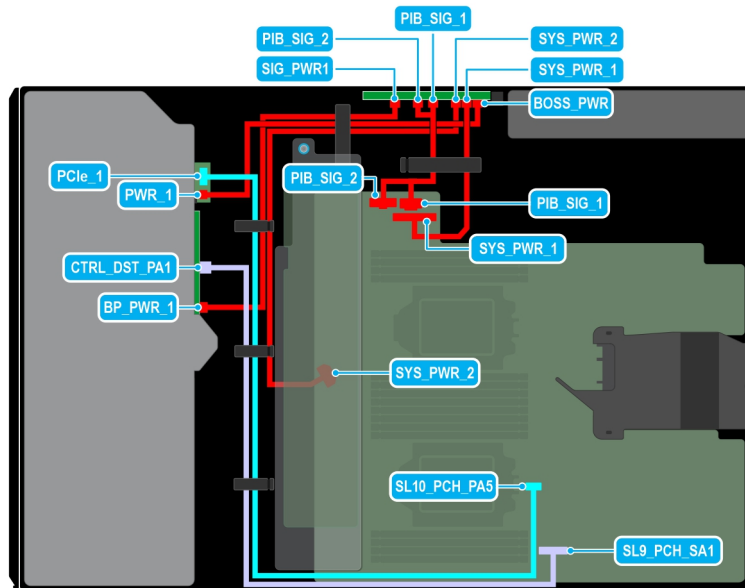

Figure 77. Cable routing - 8 x 2.5-inch SATA with BOSS S2 module

Table 18. Cable routing - 8 x 2.5-inch SATA with BOSS S2 module

From	To
PCIe_1 (Signal connector on BOSS S2 module)	SL10_PCH_PA5 (Signal connector on system board)
PWR_1 (Power connector on BOSS S2 module)	BOSS_PWR (Power connector on PIB)
BP_DST_SA1 (Signal connector on backplane)	SL9_PCH_SA1 (Signal connector on system board)
BP_PWR_1 (Power connector on backplane)	SIG_PWR_1 (Power connector on PIB)
SYS_PWR_1 (Power connector on system board)	SYS_PWR_1 (Power connector on PIB)
SYS_PWR_2 (Power connector on system board)	SYS_PWR_2 (Power connector on PIB)
PIB_SIG_1 (Power connector on system board)	PIB_SIG_1 (Power connector on PIB)
PIB_SIG_2 (Power connector on system board)	PIB_SIG_2 (Power connector on PIB)

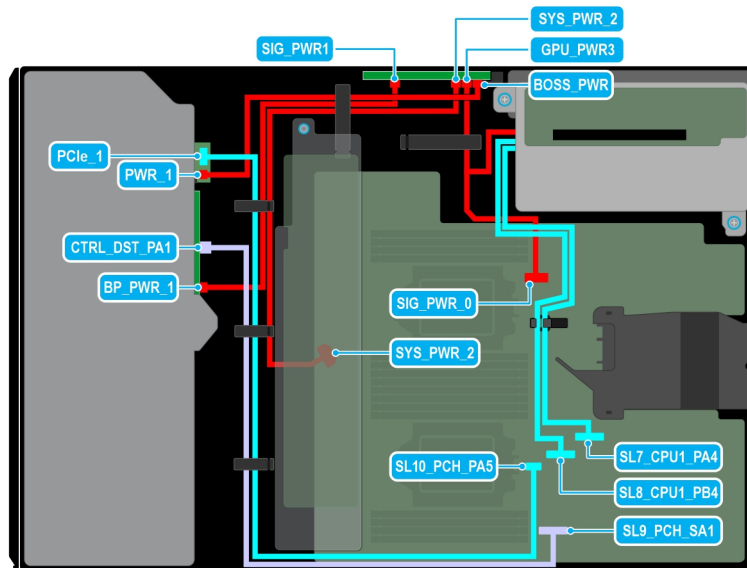

Figure 78. Cable routing - 8 x 2.5-inch SATA with GPU riser

Table 19. Cable routing - 8 x 2.5-inch SATA with GPU riser

From	To
PCIe_1 (Signal connector on BOSS S2 module)	SL10_PCH_PA5 (Signal connector on system board)
PWR_1 (Power connector on BOSS S2 module)	BOSS_PWR (Power connector on PIB)
BP_DST_SA1 (Signal connector on backplane)	SL9_PCH_SA1 (Signal connector on system board)
BP_PWR_1 (Power connector on backplane)	SIG_PWR_1 (Power connector on PIB)
SIG_PWR_0 (Power connector on system board)	RISER_PWR_1 (Power connector on GPU riser)
GPU_PWR_3 (Power connector on PIB)	RISER_PWR_1 (Power connector on GPU riser)
SL7_CPU1_PA4 (Signal connector on system board)	RISER_DST_PA1 (Signal connector on GPU riser 1)
SL8_CPU1_PB4 (Signal connector on system board)	RISER_DST_PB1 (Signal connector on GPU riser 1)

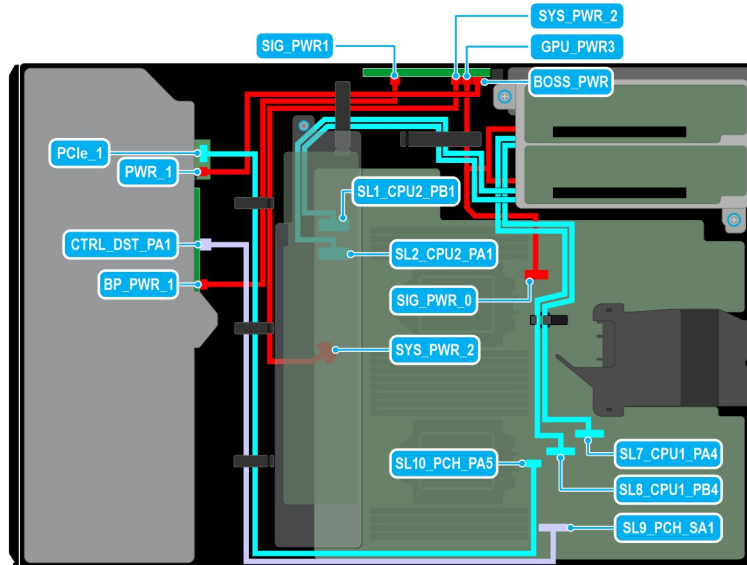

Figure 79. Cable routing - 8 x 2.5-inch SATA with two GPU risers

Table 20. Cable routing - 8 x 2.5-inch SATA with two GPU risers

From	To
PCIe_1 (Signal connector on BOSS S2 module)	SL10_PCH_PA5 (Signal connector on system board)
PWR_1 (Power connector on BOSS S2 module)	BOSS_PWR (Power connector on PIB)
BP_DST_SA1 (Signal connector on backplane)	SL9_PCH_SA1 (Signal connector on system board)
BP_PWR_1 (Power connector on backplane)	SIG_PWR_1 (Power connector on PIB)
SIG_PWR_0 (Power connector on system board)	RISER_PWR_1 (Power connector on GPU riser)
GPU_PWR_3 (Power connector on PIB)	RISER_PWR_1 (Power connector on GPU riser)
SL7_CPU1_PA4 (Signal connector on system board)	RISER_DST_PA1 (Signal connector on GPU riser 1)
SL8_CPU1_PB4 (Signal connector on system board)	RISER_DST_PB1 (Signal connector on GPU riser 1)
SL1_CPU2_PB1 (Signal connector on system board)	RISER_DST_PB1 (Signal connector on GPU riser 2)
SL2_CPU2_PA1 (Signal connector on system board)	RISER_DST_PA1 (Signal connector on GPU riser 2)

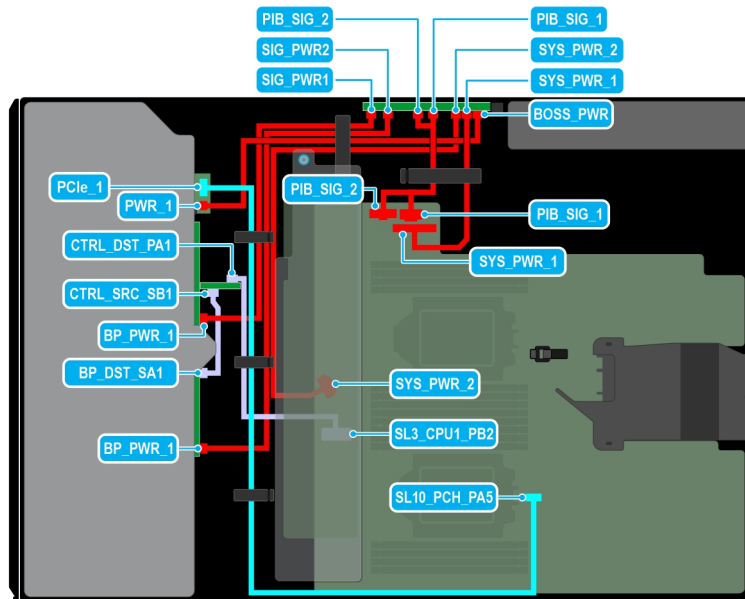

Figure 80. Cable routing - 16 x 2.5-inch SAS with BOSS S2 module

Table 21. Cable routing - 16 x 2.5-inch SAS with BOSS S2 module

From	To
PCIe_1 (Signal connector on BOSS S2 module)	SL10_PCH_PA5 (Signal connector on system board)
PWR_1 (Power connector on BOSS S2 module)	BOSS_PWR (Power connector on PIB)
CTRL_DST_PA1 (Signal connector on PERC)	SL3_CPU1_PB2 (Signal connector on system board)
CTRL_SRC_SB1 (Signal connector on PERC)	BP_DST_SA1 (Signal connector on backplane)
BP_PWR_1 (Power connector on backplane)	SIG_PWR_1 (Power connector on PIB)
BP_PWR_1 (Power connector on backplane)	SIG_PWR_2 (Power connector on PIB)
SYS_PWR_1 (Power connector on system board)	SYS_PWR_1 (Power connector on PIB)
SYS_PWR_2 (Power connector on system board)	SYS_PWR_2 (Power connector on PIB)
PIB_SIG_1 (Power connector on system board)	PIB_SIG_1 (Power connector on PIB)
PIB_SIG_2 (Power connector on system board)	PIB_SIG_2 (Power connector on PIB)

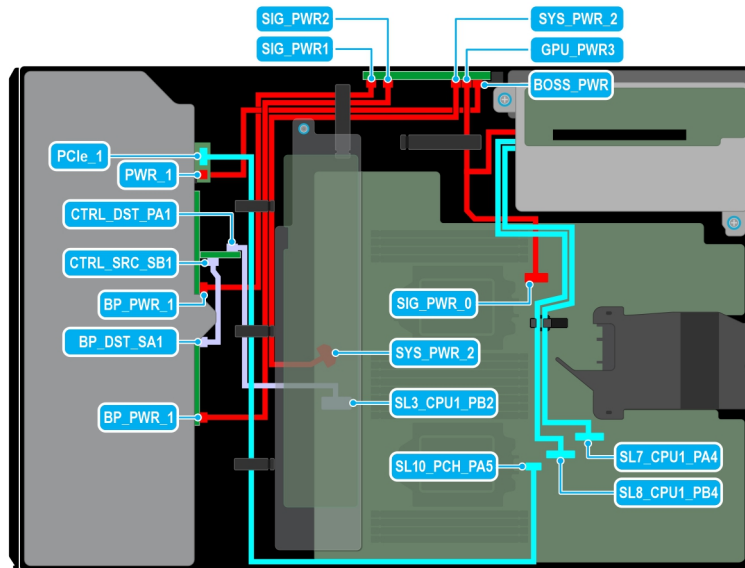

Figure 81. Cable routing - 16 x 2.5-inch SAS with GPU riser

Table 22. Cable routing - 16 x 2.5-inch SAS with GPU riser

From	To
PCIe_1 (Signal connector on BOSS S2 module)	SL10_PCH_PA5 (Signal connector on system board)
PWR_1 (Power connector on BOSS S2 module)	BOSS_PWR (Power connector on PIB)
CTRL_DST_PA1 (Signal connector on PERC)	SL3_CPU1_PB2 (Signal connector on system board)
CTRL_SRC_SB1 (Signal connector on PERC)	BP_DST_SA1 (Signal connector on backplane)
BP_PWR_1 (Power connector on backplane)	SIG_PWR_1 (Power connector on PIB)
SYS_PWR_2 (Power connector on system board)	SYS_PWR_2 (Power connector on PIB)
SIG_PWR_0 (Power connector on system board)	RISER_PWR_1 (Power connector on GPU riser)
GPU_PWR_3 (Power connector on PIB)	RISER_PWR_1 (Power connector on GPU riser)
SL7_CPU1_PA4 (Signal connector on system board)	RISER_DST_PA1 (Signal connector on GPU riser 1)
SL8_CPU1_PB4 (Signal connector on system board)	RISER_DST_PB1 (Signal connector on GPU riser 1)

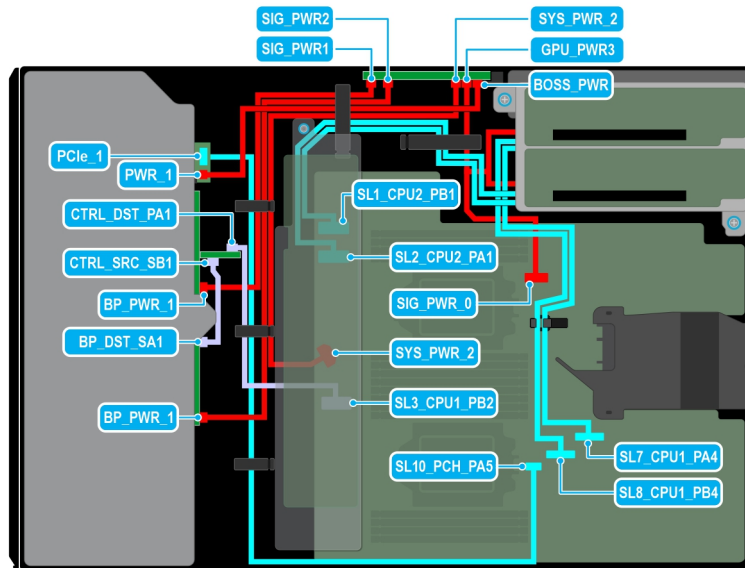

Figure 82. Cable routing - 16 x 2.5-inch SAS with two GPU risers

Table 23. Cable routing - 16 x 2.5-inch SAS with two GPU risers

From	To
PCIe_1 (Signal connector on BOSS S2 module)	SL10_PCH_PA5 (Signal connector on system board)
PWR_1 (Power connector on BOSS S2 module)	BOSS_PWR (Power connector on PIB)
CTRL_DST_PA1 (Signal connector on PERC)	SL3_CPU1_PB2 (Signal connector on system board)
CTRL_SRC_SB1 (Signal connector on PERC)	BP_DST_SA1 (Signal connector on backplane)
BP_PWR_1 (Power connector on backplane)	SIG_PWR_1 (Power connector on PIB)
BP_PWR_1 (Power connector on backplane)	SIG_PWR_2 (Power connector on PIB)
SYS_PWR_2 (Power connector on system board)	SYS_PWR_2 (Power connector on PIB)
SIG_PWR_0 (Power connector on system board)	RISER_PWR_1 (Power connector on GPU riser)
GPU_PWR_3 (Power connector on PIB)	RISER_PWR_1 (Power connector on GPU riser)
SL7_CPU1_PA4 (Signal connector on system board)	RISER_DST_PA1 (Signal connector on GPU riser 1)
SL8_CPU1_PB4 (Signal connector on system board)	RISER_DST_PB1 (Signal connector on GPU riser 1)
SL1_CPU2_PB1 (Signal connector on system board)	RISER_DST_PB1 (Signal connector on GPU riser 2)
SL2_CPU2_PA1 (Signal connector on system board)	RISER_DST_PA1 (Signal connector on GPU riser 2)

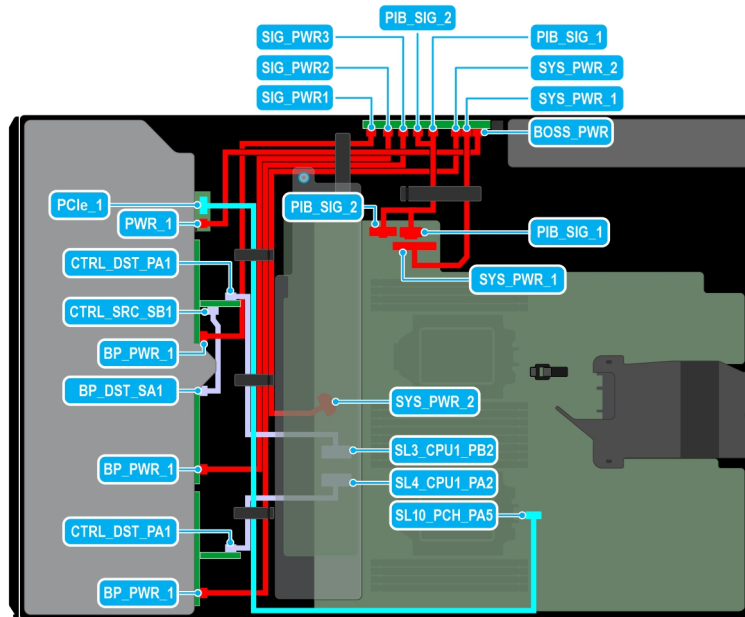

Figure 83. Cable routing - 24 x 2.5-inch SAS with BOSS S2 module

Table 24. Cable routing - 24 x 2.5-inch SAS with BOSS S2 module

From	To
PCIe_1 (Signal connector on BOSS S2 module)	SL10_PCH_PA5 (Signal connector on system board)
PWR_1 (Power connector on BOSS S2 module)	BOSS_PWR (Power connector on PIB)
CTRL_DST_PA1 (Signal connector on PERC)	SL3_CPU1_PB2 (Signal connector on system board)
CTRL_SRC_SB1 (Signal connector on PERC)	BP_DST_SA1 (Signal connector on backplane)
BP_PWR_1 (Power connector on backplane)	SIG_PWR_1 (Power connector on PIB)
BP_PWR_1 (Power connector on backplane)	SIG_PWR_2 (Power connector on PIB)
BP_PWR_1 (Power connector on backplane)	SIG_PWR_3 (Power connector on PIB)
CTRL_DST_PA1 (Signal connector on PERC)	SL4_CPU1_PA2 (Signal connector on system board)
SYS_PWR_1 (Power connector on system board)	SYS_PWR_1 (Power connector on PIB)
SYS_PWR_2 (Power connector on system board)	SYS_PWR_2 (Power connector on PIB)
PIB_SIG_1 (Power connector on system board)	PIB_SIG_1 (Power connector on PIB)
PIB_SIG_2 (Power connector on system board)	PIB_SIG_2 (Power connector on PIB)

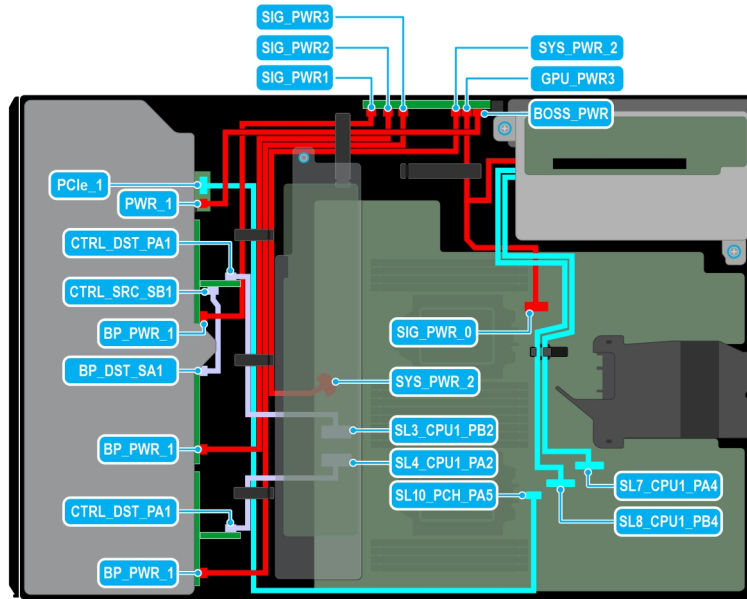

Figure 84. Cable routing - 24 x 2.5-inch SAS with GPU riser

Table 25. Cable routing - 24 x 2.5-inch SAS with GPU riser

From	To
PCle_1 (Signal connector on BOSS S2 module)	SL10_PCH_PA5 (Signal connector on system board)
PWR_1 (Power connector on BOSS S2 module)	BOSS_PWR (Power connector on PIB)
CTRL_DST_PA1 (Signal connector on PERC)	SL3_CPU1_PB2 (Signal connector on system board)
CTRL_SRC_SB1 (Signal connector on PERC)	BP_DST_SA1 (Signal connector on backplane)
BP_PWR_1 (Power connector on backplane)	SIG_PWR_1 (Power connector on PIB)
BP_PWR_1 (Power connector on backplane)	SIG_PWR_2 (Power connector on PIB)
BP_PWR_1 (Power connector on backplane)	SIG_PWR_3 (Power connector on PIB)
CTRL_DST_PA1 (Signal connector on PERC)	SL4_CPU1_PA2 (Signal connector on system board)
SYS_PWR_2 (Power connector on system board)	SYS_PWR_2 (Power connector on PIB)
SIG_PWR_0 (Power connector on system board)	RISER_PWR_1 (Power connector on GPU riser)
GPU_PWR_3 (Power connector on PIB)	RISER_PWR_1 (Power connector on GPU riser)
SL7_CPU1_PA4 (Signal connector on system board)	RISER_DST_PA1 (Signal connector on GPU riser 1)
SL8_CPU1_PB4 (Signal connector on system board)	RISER_DST_PB1 (Signal connector on GPU riser 1)

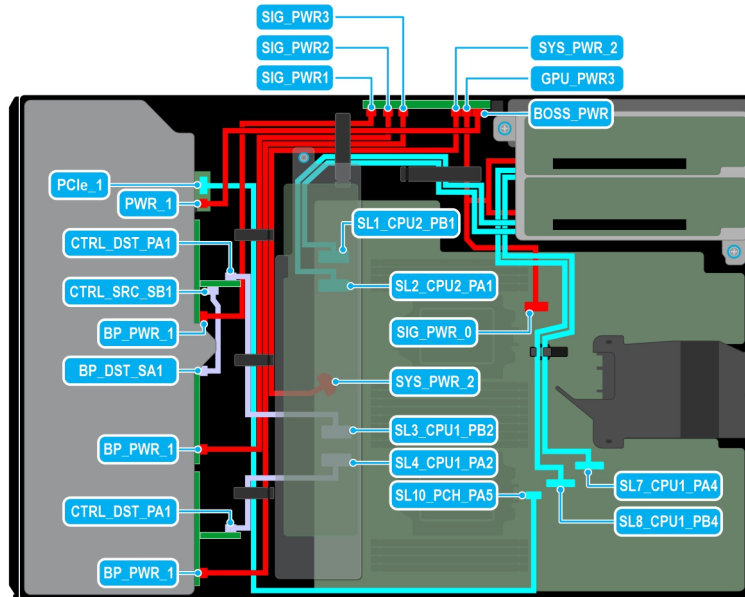

Figure 85. Cable routing - 24 x 2.5-inch SAS with two GPU risers

Table 26. Cable routing - 24 x 2.5-inch SAS with two GPU risers

From	To
PCIe_1 (Signal connector on BOSS S2 module)	SL10_PCH_PA5 (Signal connector on system board)
PWR_1 (Power connector on BOSS S2 module)	BOSS_PWR (Power connector on PIB)
CTRL_DST_PA1 (Signal connector on PERC)	SL3_CPU1_PB2 (Signal connector on system board)
CTRL_SRC_SB1 (Signal connector on PERC)	BP_DST_SA1 (Signal connector on backplane)
BP_PWR_1 (Power connector on backplane)	SIG_PWR_1 (Power connector on PIB)
BP_PWR_1 (Power connector on backplane)	SIG_PWR_2 (Power connector on PIB)
BP_PWR_1 (Power connector on backplane)	SIG_PWR_3 (Power connector on PIB)
CTRL_DST_PA1 (Signal connector on PERC)	SL4_CPU1_PA2 (Signal connector on system board)
SYS_PWR_2 (Power connector on system board)	SYS_PWR_2 (Power connector on PIB)
SIG_PWR_0 (Power connector on system board)	RISER_PWR_1 (Power connector on GPU riser)
GPU_PWR_3 (Power connector on PIB)	RISER_PWR_1 (Power connector on GPU riser)
SL7_CPU1_PA4 (Signal connector on system board)	RISER_DST_PA1 (Signal connector on GPU riser 1)
SL8_CPU1_PB4 (Signal connector on system board)	RISER_DST_PB1 (Signal connector on GPU riser 1)
SL1_CPU2_PB1 (Signal connector on system board)	RISER_DST_PB1 (Signal connector on GPU riser 2)
SL2_CPU2_PA1 (Signal connector on system board)	RISER_DST_PA1 (Signal connector on GPU riser 2)

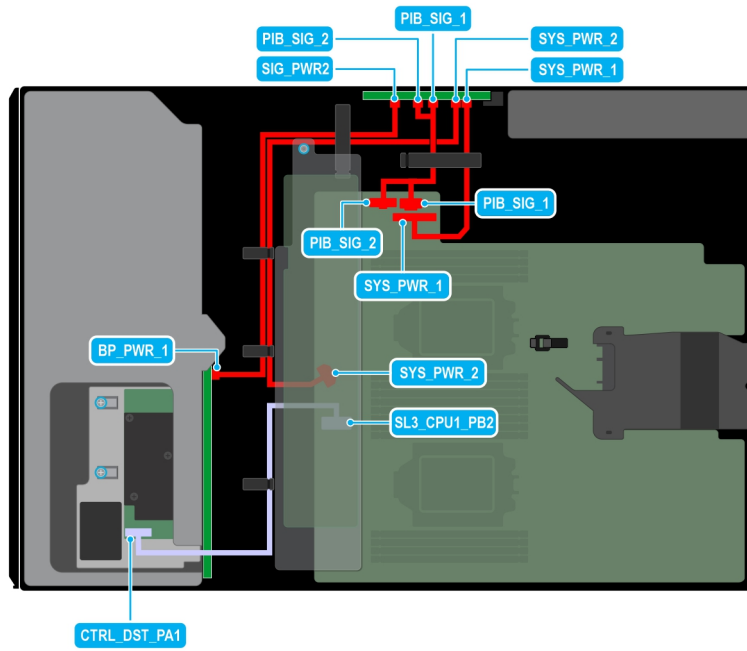

Figure 86. Cable routing - 8 x 3.5-inch SAS

Table 27. Cable routing - 8 x 3.5-inch SAS

From	To
CTRL_DST_PA1 (Signal connector on PERC)	SL3_CPU1_PB2 (Signal connector on system board)
BP_PWR_1 (Power connector on backplane)	SIG_PWR_1 (Power connector on PIB)
SYS_PWR_1 (Power connector on system board)	SYS_PWR_1 (Power connector on PIB)
SYS_PWR_2 (Power connector on system board)	SYS_PWR_2 (Power connector on PIB)
PIB_SIG_1 (Power connector on system board)	PIB_SIG_1 (Power connector on PIB)
PIB_SIG_2 (Power connector on system board)	PIB_SIG_2 (Power connector on PIB)

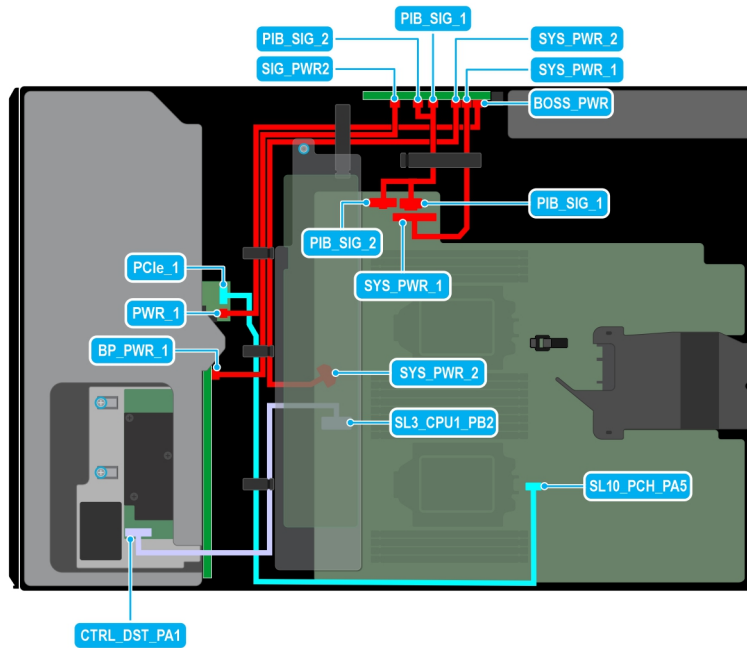

Figure 87. Cable routing - 8 x 3.5-inch SAS with BOSS S2 module

Table 28. Cable routing - 8 x 3.5-inch SAS with BOSS S2 module

From	To
PCIe_1 (Signal connector on BOSS S2 module)	SL10_PCH_PA5 (Signal connector on system board)
PWR_1 (Power connector on BOSS S2 module)	BOSS_PWR (Power connector on PIB)
CTRL_DST_PA1 (Signal connector on PERC)	SL3_CPU1_PB2 (Signal connector on system board)
BP_PWR_1 (Power connector on backplane)	SIG_PWR_2 (Power connector on PIB)
SYS_PWR_1 (Power connector on system board)	SYS_PWR_1 (Power connector on PIB)
SYS_PWR_2 (Power connector on system board)	SYS_PWR_2 (Power connector on PIB)
PIB_SIG_1 (Power connector on system board)	PIB_SIG_1 (Power connector on PIB)
PIB_SIG_2 (Power connector on system board)	PIB_SIG_2 (Power connector on PIB)

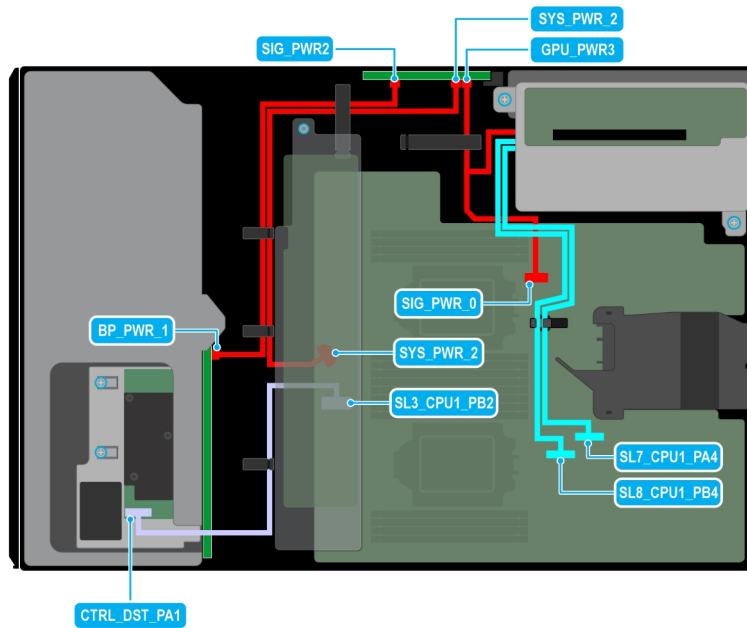

Figure 88. Cable routing - 8 x 3.5-inch SAS with GPU riser

Table 29. Cable routing - 8 x 3.5-inch SAS with GPU riser

From	To
CTRL_DST_PA1 (Signal connector on PERC)	SL3_CPU1_PB2 (Signal connector on system board)
BP_PWR_1 (Power connector on backplane)	SIG_PWR_2 (Power connector on PIB)
SYS_PWR_2 (Power connector on system board)	SYS_PWR_2 (Power connector on PIB)
SIG_PWR_0 (Power connector on system board)	RISER_PWR_1 (Power connector on GPU riser)
GPU_PWR_3 (Power connector on PIB)	RISER_PWR_1 (Power connector on GPU riser)
SL7_CPU1_PA4 (Signal connector on system board)	RISER_DST_PA1 (Signal connector on GPU riser 1)
SL8_CPU1_PB4 (Signal connector on system board)	RISER_DST_PB1 (Signal connector on GPU riser 1)

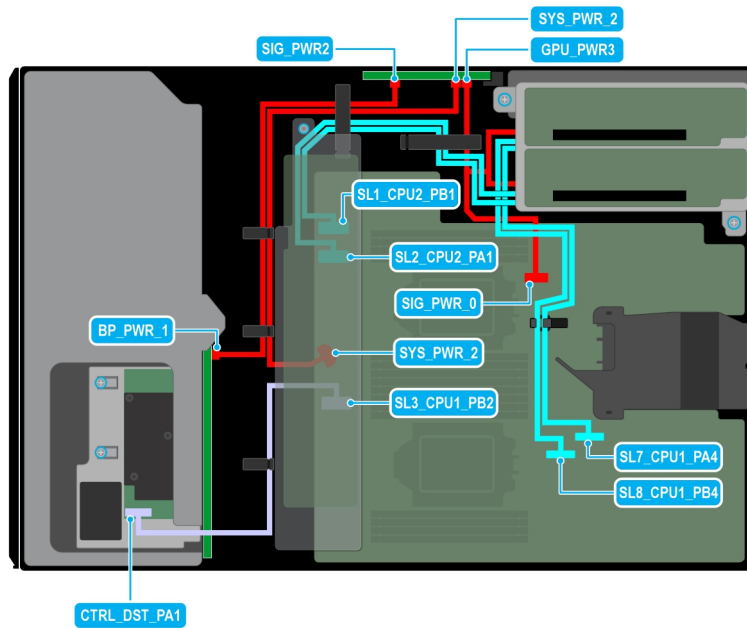

Figure 89. Cable routing - 8 x 3.5-inch SAS with two GPU risers

Table 30. Cable routing - 8 x 3.5-inch SAS with two GPU risers

From	To
CTRL_DST_PA1 (Signal connector on backplane)	SL3_CPU1_PB2 (Signal connector on system board)
BP_PWR_1 (Power connector on backplane)	SIG_PWR_2 (Power connector on PIB)
SYS_PWR_2 (Power connector on system board)	SYS_PWR_2 (Power connector on PIB)
SIG_PWR_0 (Power connector on system board)	RISER_PWR_1 (Power connector on GPU riser)
GPU_PWR_3 (Power connector on PIB)	RISER_PWR_1 (Power connector on GPU riser)
SL7_CPU1_PA4 (Signal connector on system board)	RISER_DST_PA1 (Signal connector on GPU riser 1)
SL8_CPU1_PB4 (Signal connector on system board)	RISER_DST_PB1 (Signal connector on GPU riser 1)
SL1_CPU2_PB1 (Signal connector on system board)	RISER_DST_PB1 (Signal connector on GPU riser 2)
SL2_CPU2_PA1 (Signal connector on system board)	RISER_DST_PA1 (Signal connector on GPU riser 2)

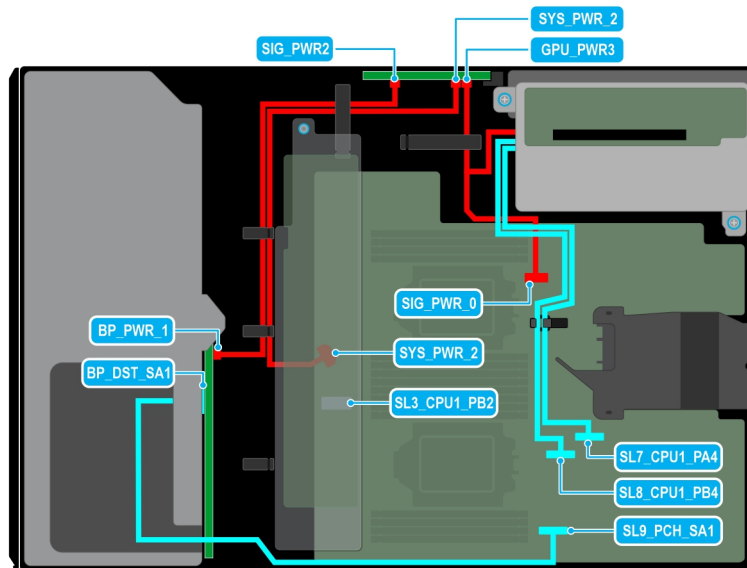

Figure 90. Cable routing - 8 x 3.5-inch SATA with GPU riser

Table 31. Cable routing - 8 x 3.5-inch SATA with GPU riser

From	To
CTRL_DST_PA1 (Signal connector on backplane)	SL9_PCH_SA1 (Signal connector on system board)
BP_PWR_1 (Power connector on backplane)	SIG_PWR_2 (Power connector on PIB)
SYS_PWR_2 (Power connector on system board)	SYS_PWR_2 (Power connector on PIB)
SIG_PWR_0 (Power connector on system board)	RISER_PWR_1 (Power connector on GPU riser)
GPU_PWR_3 (Power connector on PIB)	RISER_PWR_1 (Power connector on GPU riser)
SL7_CPU1_PA4 (Signal connector on system board)	RISER_DST_PA1 (Signal connector on GPU riser 1)
SL8_CPU1_PB4 (Signal connector on system board)	RISER_DST_PB1 (Signal connector on GPU riser 1)

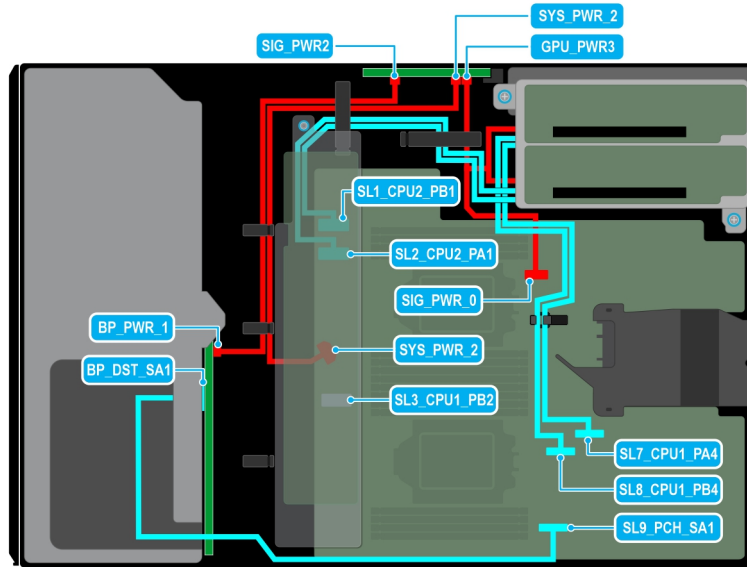

Figure 91. Cable routing - 8 x 3.5-inch SATA with two GPU risers

Table 32. Cable routing - 8 x 3.5-inch SATA with two GPU risers

From	To
CTRL_DST_PA1 (Signal connector on backplane)	SL3_CPU1_PB2 (Signal connector on system board)
BP_PWR_1 (Power connector on backplane)	SIG_PWR_2 (Power connector on PIB)
SYS_PWR_2 (Power connector on system board)	SYS_PWR_2 (Power connector on PIB)
SIG_PWR_0 (Power connector on system board)	RISER_PWR_1 (Power connector on GPU riser)
GPU_PWR_3 (Power connector on PIB)	RISER_PWR_1 (Power connector on GPU riser)
SL7_CPU1_PA4 (Signal connector on system board)	RISER_DST_PA1 (Signal connector on GPU riser 1)
SL8_CPU1_PB4 (Signal connector on system board)	RISER_DST_PB1 (Signal connector on GPU riser 1)
SL1_CPU2_PB1 (Signal connector on system board)	RISER_DST_PB1 (Signal connector on GPU riser 2)
SL2_CPU2_PA1 (Signal connector on system board)	RISER_DST_PA1 (Signal connector on GPU riser 2)

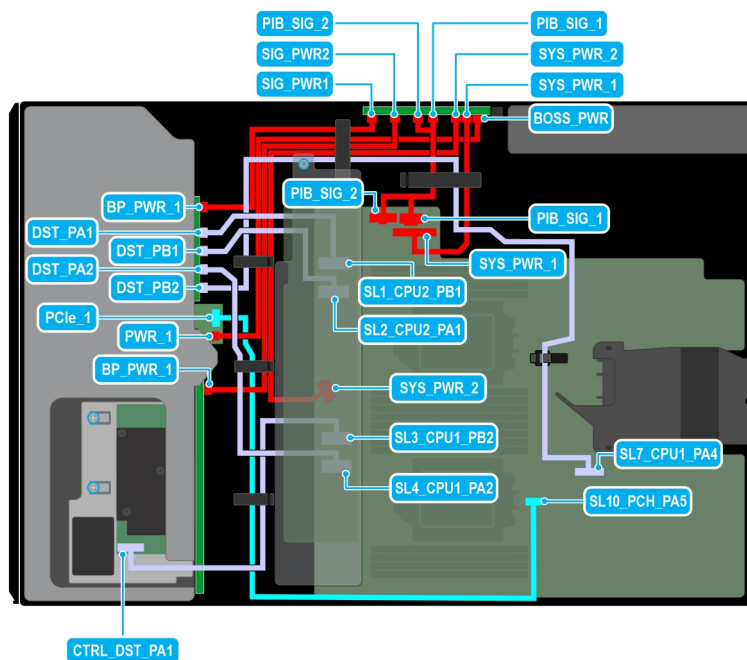

Figure 92. Cable routing - 8 x 3.5-inch + 8 x 2.5-inch NVMe with BOSS S2 module

Table 33. Cable routing - 8 x 3.5-inch + 8 x 2.5-inch NVMe with BOSS S2 module

From	To
PCIe_1 (Signal connector on BOSS S2 module)	SL10_PCH_PA5 (Signal connector on system board)
PWR_1 (Power connector on BOSS S2 module)	BOSS_PWR (Power connector on PIB)
CTRL_DST_PA1 (Signal connector on PERC)	SL3_CPU1_PB2 (Signal connector on system board)
BP_PWR_1 (Power connector on backplane)	SIG_PWR_1 (Power connector on PIB)
DST_PA1 (Signal connector on backplane)	SL1_CPU2_PB1 (Signal connector on system board)
DST_PB1 (Signal connector on backplane)	SL2_CPU2_PA1 (Signal connector on system board)
DST_PA2 (Signal connector on backplane)	SL4_CPU1_PB2 (Signal connector on system board)
DST_PB2 (Signal connector on backplane)	SL7_CPU1_PA4 (Signal connector on system board)
BP_PWR_1 (Power connector on backplane)	SIG_PWR_2 (Power connector on PIB)
SYS_PWR_1 (Power connector on system board)	SYS_PWR_1 (Power connector on PIB)
SYS_PWR_2 (Power connector on system board)	SYS_PWR_2 (Power connector on PIB)
PIB_SIG_1 (Power connector on system board)	PIB_SIG_1 (Power connector on PIB)
PIB_SIG_2 (Power connector on system board)	PIB_SIG_2 (Power connector on PIB)

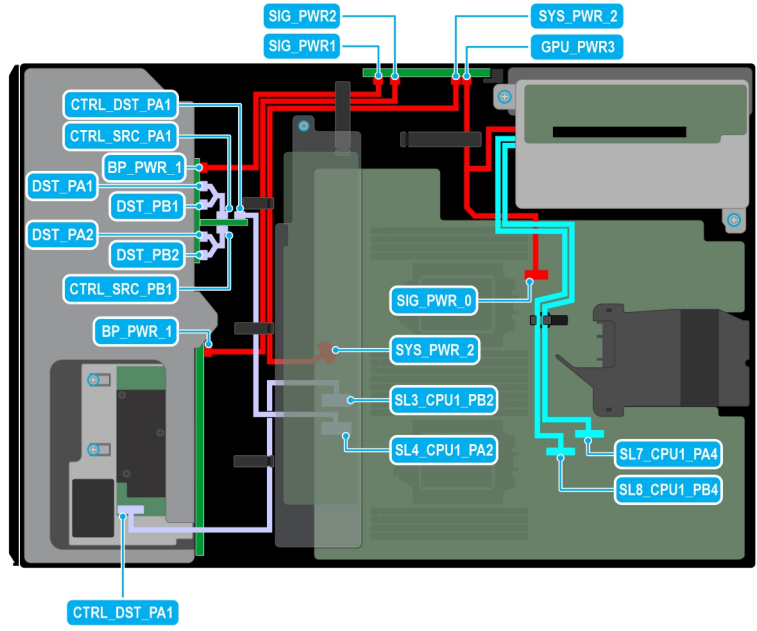

Figure 93. Cable routing - 8 x 3.5-inch + 8 x 2.5-inch NVMe with GPU riser

Table 34. Cable routing - 8 x 3.5-inch + 8 x 2.5-inch NVMe with GPU riser

From	To
PCIe_1 (Signal connector on BOSS S2 module)	SL10_PCH_PA5 (Signal connector on system board)
PWR_1 (Power connector on BOSS S2 module)	BOSS_PWR (Power connector on PIB)
CTRL_DST_PA1 (Signal connector on PERC)	SL3_CPU1_PB2 (Signal connector on system board)
CTRL_DST_PA1 (Signal connector on PERC)	SL4_CPU1_PA2 (Signal connector on system board)
BP_PWR_1 (Power connector on backplane)	SIG_PWR_1 (Power connector on PIB)
DST_PA1 (Signal connector on backplane)	CTRL_SRC_PA1 (Signal connector on PERC)
DST_PB1 (Signal connector on backplane)	CTRL_SRC_PA1 (Signal connector on PERC)
DST_PA2 (Signal connector on backplane)	CTRL_SRC_PB1 (Signal connector on PERC)
DST_PB2 (Signal connector on backplane)	CTRL_SRC_PB1 (Signal connector on PERC)
BP_PWR_1 (Power connector on backplane)	SIG_PWR_2 (Power connector on PIB)
SYS_PWR_2 (Power connector on system board)	SYS_PWR_2 (Power connector on PIB)
SIG_PWR_0 (Power connector on system board)	RISER_PWR_1 (Power connector on GPU riser)
GPU_PWR_3 (Power connector on PIB)	RISER_PWR_1 (Power connector on GPU riser)
SL7_CPU1_PA4 (Signal connector on system board)	RISER_DST_PA1 (Signal connector on GPU riser 1)
SL8_CPU1_PB4 (Signal connector on system board)	RISER_DST_PB1 (Signal connector on GPU riser 1)

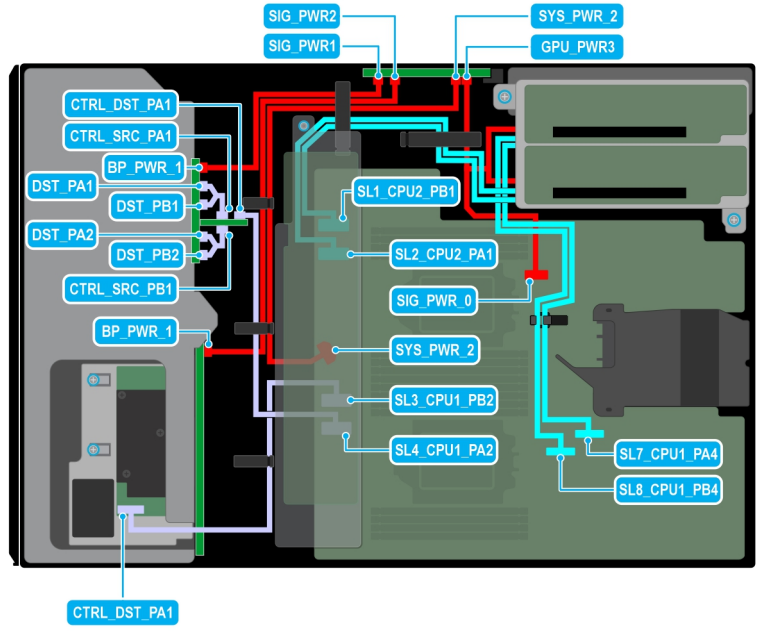

Figure 94. Cable routing - 8 x 3.5-inch + 8 x 2.5-inch NVMe with two GPU risers

Table 35. Cable routing - 8 x 3.5-inch + 8 x 2.5-inch NVMe with two GPU risers

From	To
PCIe_1 (Signal connector on BOSS S2 module)	SL10_PCH_PA5 (Signal connector on system board)
PWR_1 (Power connector on BOSS S2 module)	BOSS_PWR (Power connector on PIB)
CTRL_DST_PA1 (Signal connector on PERC)	SL3_CPU1_PB2 (Signal connector on system board)
CTRL_DST_PA1 (Signal connector on PERC)	SL4_CPU1_PA2 (Signal connector on system board)
BP_PWR_1 (Power connector on backplane)	SIG_PWR_1 (Power connector on PIB)
DST_PA1 (Signal connector on backplane)	CTRL_SRC_PA1 (Signal connector on PERC)
DST_PB1 (Signal connector on backplane)	CTRL_SRC_PA1 (Signal connector on PERC)
DST_PA2 (Signal connector on backplane)	CTRL_SRC_PB1 (Signal connector on PERC)
DST_PB2 (Signal connector on backplane)	CTRL_SRC_PB1 (Signal connector on PERC)
BP_PWR_1 (Power connector on backplane)	SIG_PWR_2 (Power connector on PIB)
SYS_PWR_2 (Power connector on system board)	SYS_PWR_2 (Power connector on PIB)
SIG_PWR_0 (Power connector on system board)	RISER_PWR_1 (Power connector on GPU riser)
GPU_PWR_3 (Power connector on PIB)	RISER_PWR_1 (Power connector on GPU riser)
SL7_CPU1_PA4 (Signal connector on system board)	RISER_DST_PA1 (Signal connector on GPU riser 1)
SL8_CPU1_PB4 (Signal connector on system board)	RISER_DST_PB1 (Signal connector on GPU riser 1)
SL1_CPU2_PB1 (Signal connector on system board)	RISER_DST_PB1 (Signal connector on GPU riser 2)
SL2_CPU2_PA1 (Signal connector on system board)	RISER_DST_PA1 (Signal connector on GPU riser 2)

Optional optical drive

This is a service technician replaceable part only.

Removing the optical drive blank

Prerequisites

1. Follow the safety guidelines listed in [Safety instructions](#).
2. Follow the procedure that is listed in [Before working inside your system](#).
3. If installed, [remove the front bezel](#).

Steps

Press the release tab and slide the optical drive blank out of the system.



Figure 95. Removing the optical drive blank

Next steps

Replace the optical drive blank or install the optical drive.

Installing the optical drive blank

Prerequisites

1. Follow the safety guidelines listed in [Safety instructions](#).
2. Follow the procedure that is listed in [Before working inside your system](#).
3. If installed, [remove the front bezel](#).

Steps

Hold the tabs on the optical drive blank and push the optical drive blank into the optical drive slot.



Figure 96. Installing the optical drive blank

Next steps

1. If removed, [install the front bezel](#).
2. Follow the procedure that is listed in [After working inside your system](#).

Removing the optical drive

Prerequisites

1. Follow the safety guidelines listed in [Safety instructions](#).
2. Follow the procedure that is listed in [Before working inside your system](#).
3. If installed, [remove the front bezel](#).
4. Disconnect the power and data cables from the optical drive.

NOTE: Ensure that you note the routing of the power and data cable on the side of the system as you remove them from the system board and drive.

Steps

Press the release tab and slide the optical drive towards the front of the system.

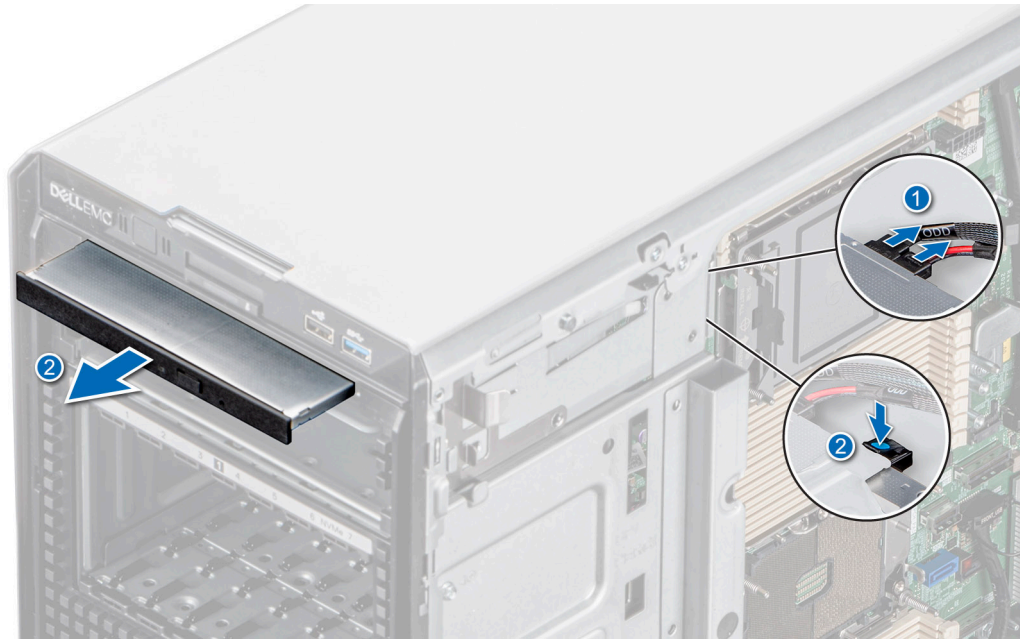

Figure 97. Removing the optical drive

Next steps

Replace the optical drive or install the optical drive blank.

Installing the optical drive

Prerequisites

i **NOTE:** Only slim 9.5-mm SATA DVD-ROM drive or DVD+/-RW drive can be installed in your system. External optical drives can be connected through USB ports.

1. Follow the safety guidelines listed in [Safety instructions](#).
2. Follow the procedure that is listed in [Before working inside your system](#).
3. If installed, [remove the front bezel](#).

Steps

1. Align the optical drive with the slot on the system.
2. Slide the optical drive into the slot until the release tab clicks into place.



Figure 98. Installing the optical drive

Next steps

1. If removed, [install the front bezel](#).
2. Connect the power cable and the data cable to the optical drive.
i **NOTE:** Route the cables properly to prevent them from being pinched or crimped.
3. Follow the procedure that is listed in [After working inside your system](#).

Optional tape backup unit

This is a service technician replaceable part only.

Removing the tape backup unit blank

Prerequisites

1. Follow the safety guidelines listed in [Safety instructions](#).
2. Follow the procedure that is listed in [Before working inside your system](#).
3. If installed, [remove the front bezel](#).

Steps

Push the protrusion at the rear of the tape backup unit blank and slide it towards the front of the system.

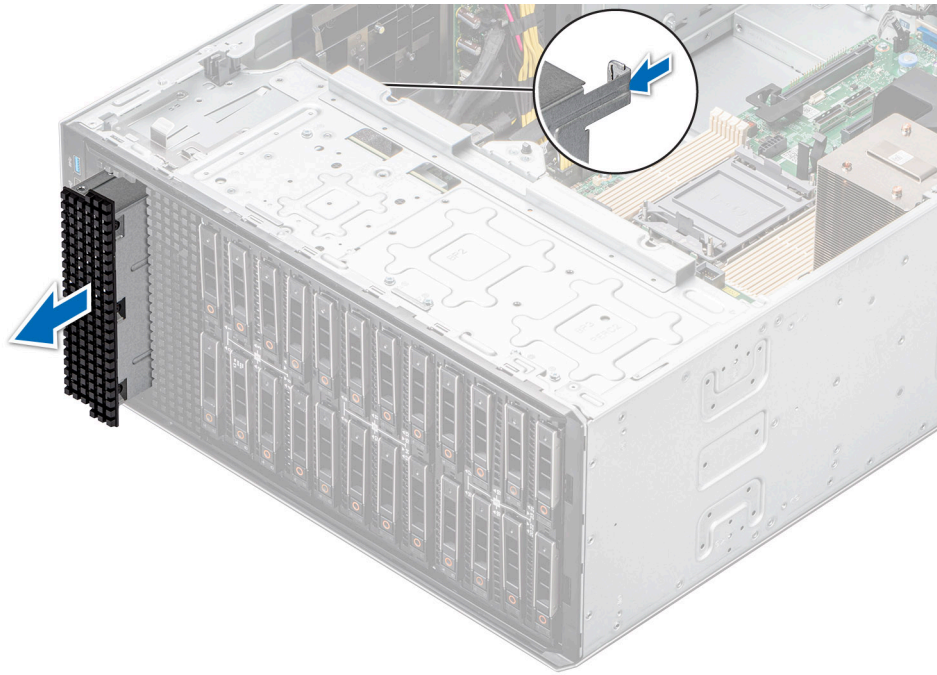

Figure 99. Removing the tape backup unit blank

Next steps

Replace the tape backup unit blank or install the tape backup unit.

Installing the tape backup unit blank

Prerequisites

1. Follow the safety guidelines listed in [Safety instructions](#).
2. Follow the procedure that is listed in [Before working inside your system](#).
3. If installed, [remove the front bezel](#).

Steps

Align and slide the tape backup unit blank into the slot on the system until it clicks into place.

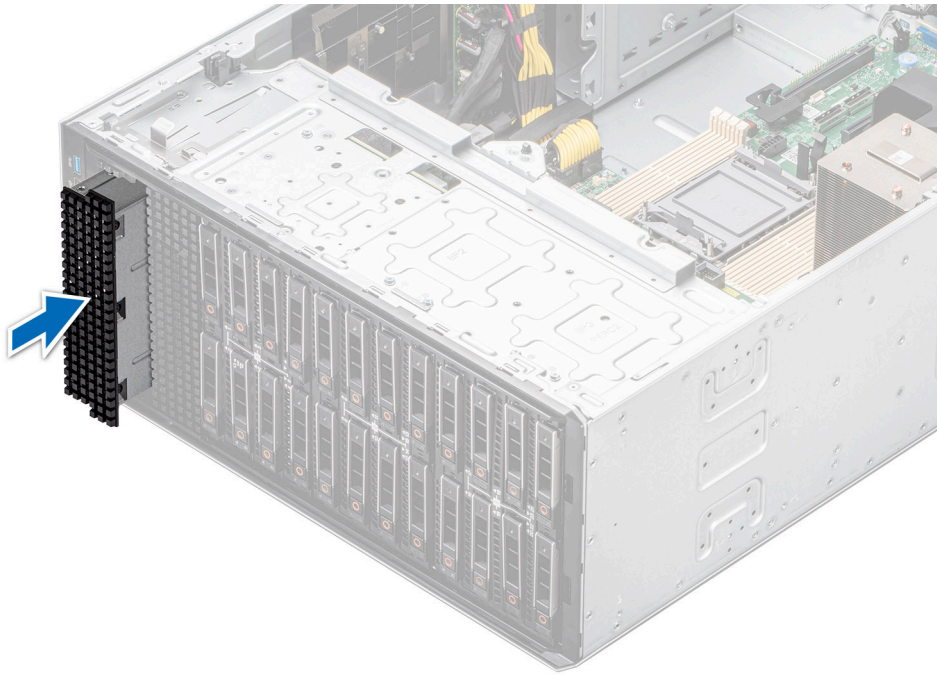

Figure 100. Installing the tape backup unit blank

Next steps

1. If removed, [install the front bezel](#).
2. Follow the procedure that is listed in [After working inside your system](#).

Removing the tape backup unit

Prerequisites

1. Follow the safety guidelines listed in [Safety instructions](#).
2. Follow the procedure that is listed in [Before working inside your system](#).
3. [Remove the air shroud](#).
4. If installed, [remove the front bezel](#).
5. Disconnect the power and data cables from the tape backup unit.

NOTE: Ensure that you note the routing of the power and data cable on the side of the system as you remove them from the system board and drive.

Steps

1. Using a Phillips 2 screwdriver, remove the screw securing the tape backup unit to the system.
2. Slide the tape backup unit towards the front of the system.

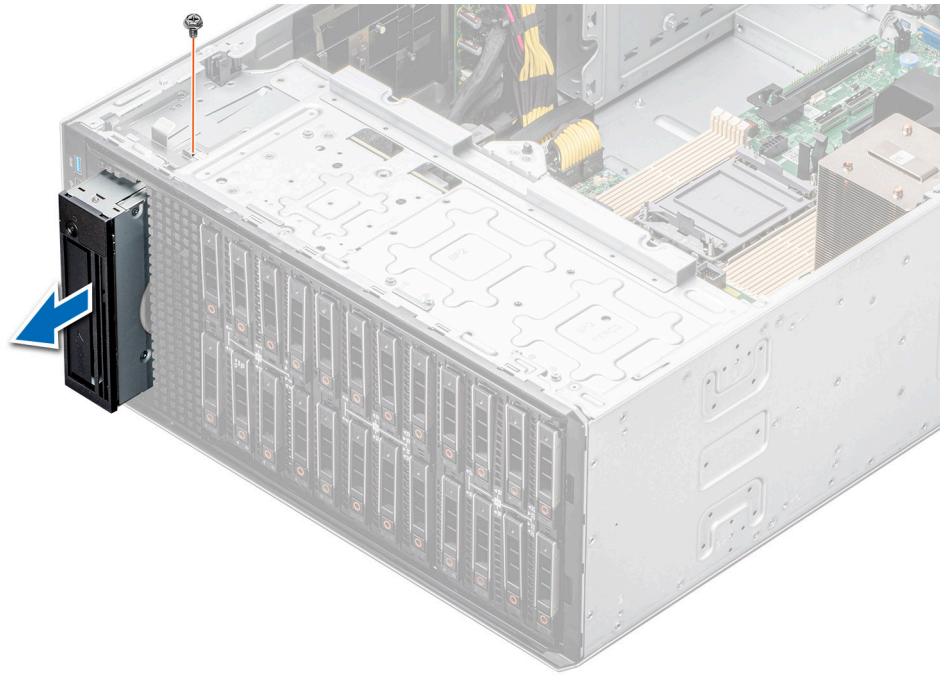

Figure 101. Removing the tape backup unit

Next steps

Replace the tape backup unit or install the tape backup unit blank.

Installing the tape backup unit

Prerequisites

1. Follow the safety guidelines listed in [Safety instructions](#).
2. Follow the procedure that is listed in [Before working inside your system](#).
3. [Remove the air shroud](#).
4. If installed, [remove the front bezel](#).

Steps

1. Align and slide the tape backup unit in the slot on the system.
2. Using a Phillips 2 screwdriver, secure the tape backup unit to the system.

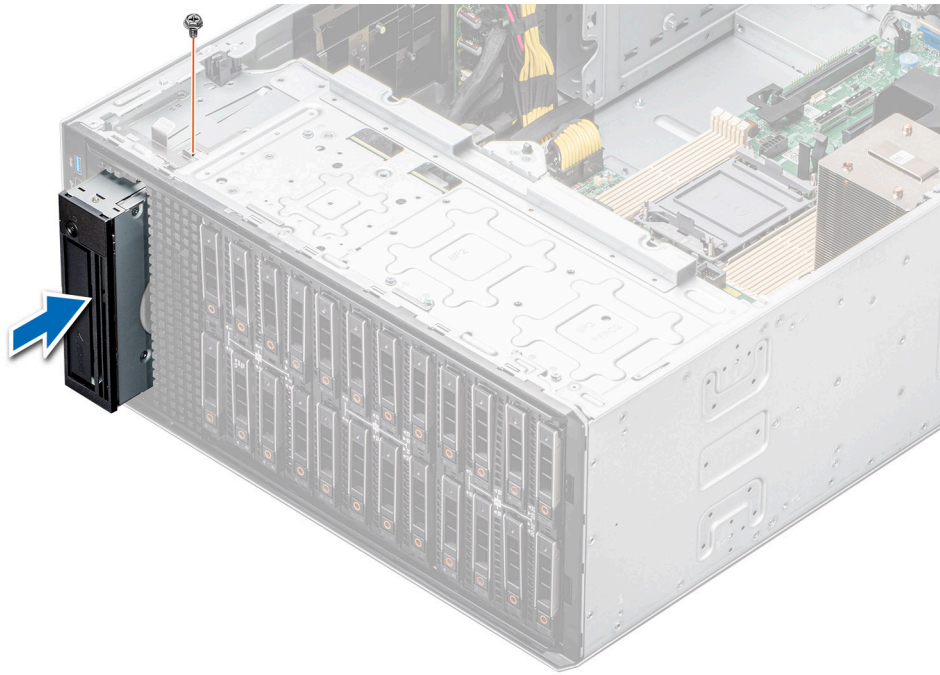

Figure 102. Installing the tape backup unit

Next steps

1. Connect the power cable and the data cable to the tape backup unit.
i **NOTE:** Route the cables properly to prevent them from being pinched or crimped.
2. [Install the air shroud.](#)
3. If removed, [install the front bezel.](#)
4. Follow the procedure that is listed in [After working inside your system.](#)

Front IO module

This is a service technician replaceable part only.

Removing the front IO module

Prerequisites

1. Follow the safety guidelines listed in [Safety instructions.](#)
 2. Follow the procedure that is listed in [Before working inside your system.](#)
 3. [Remove the air shroud.](#)
 4. [Remove the front bezel.](#)
 5. Disconnect the power and data cables from the front IO module.
- i** **NOTE:** The procedure to remove the front IO module is similar for base and upsell configurations.

Steps

Pull the metal release bracket and slide the front IO module towards the front of the system.

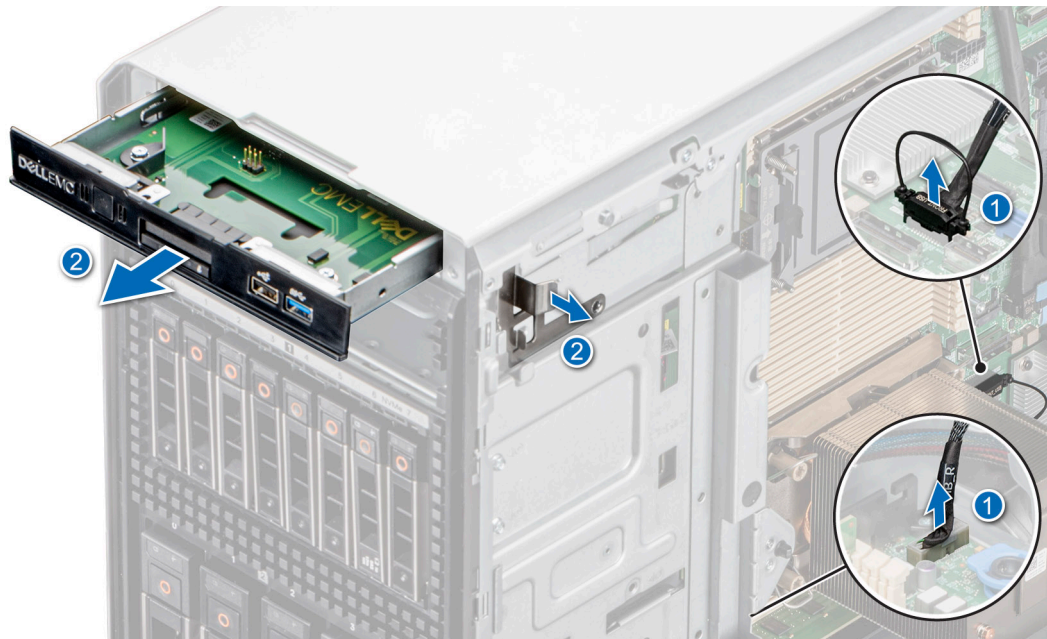

Figure 103. Removing the front IO module for base configuration



Figure 104. Removing the front IO module for upsell configuration

Next steps

Replace the front IO module.

Installing the front IO module

Prerequisites

1. Follow the safety guidelines listed in [Safety instructions](#).
2. Follow the procedure that is listed in [Before working inside your system](#).
3. [Remove the air shroud](#).

4. Remove the front bezel.
5. Disconnect the power and data cables from the front IO module.

Steps

1. **NOTE:** The procedure to remove the front IO module is similar for base and upsell configurations.

Align the front IO module with the slot on the system.

2. Slide the front IO module into the slot until the release bracket clicks into place.

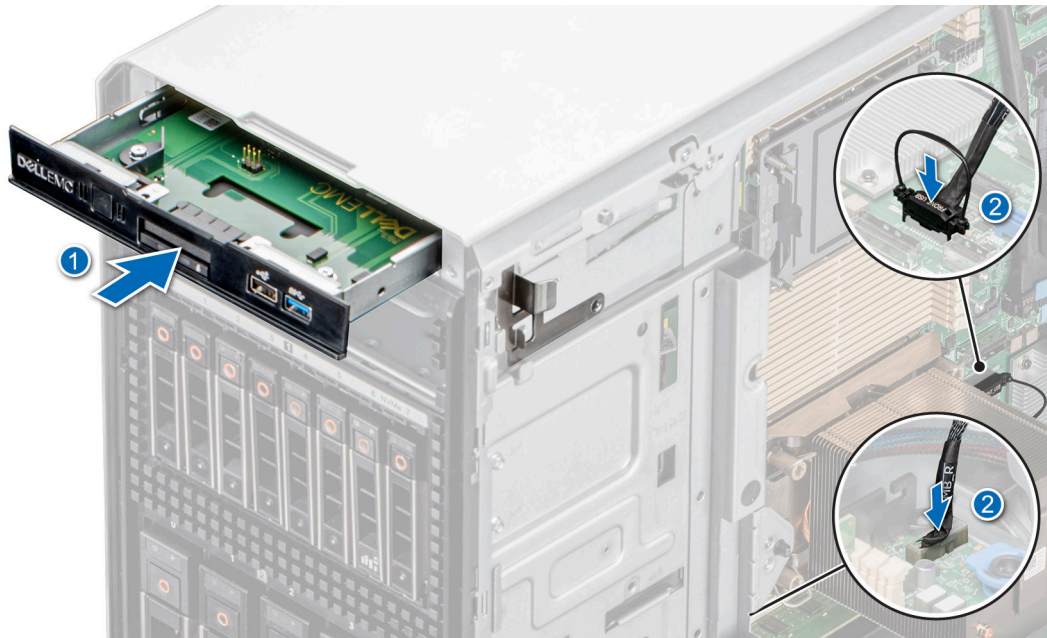

Figure 105. Installing the front IO module for base configuration

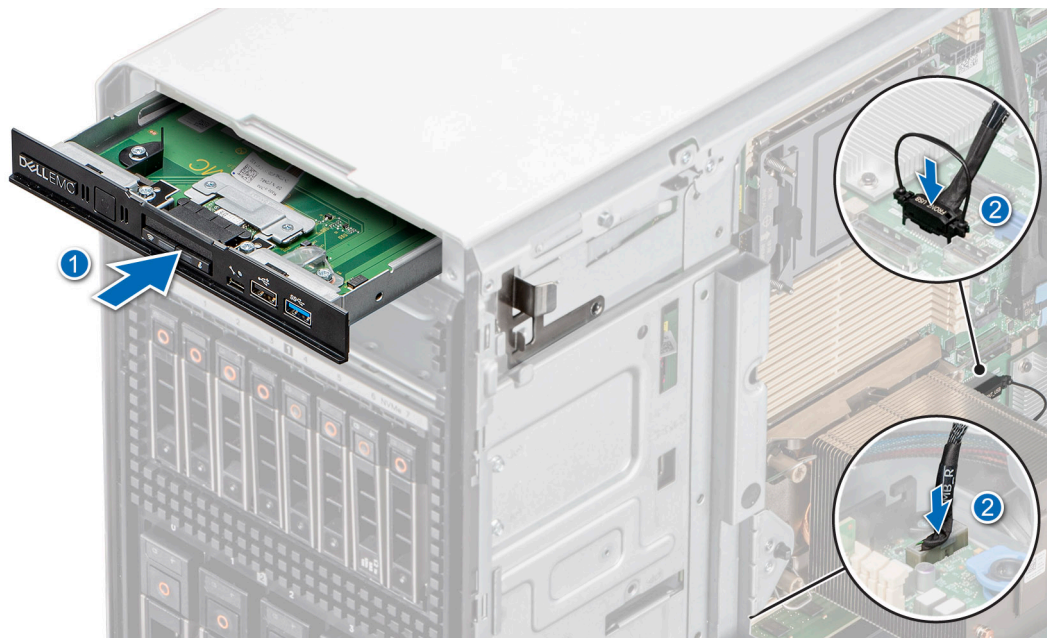

Figure 106. Installing the front IO module for upsell configuration

Next steps

1. Connect the power cable and the data cable to the front IO module.

NOTE: Route the cables properly to prevent them from being pinched or crimped.

2. Install the front bezel.
3. Install the air shroud.
4. Follow the procedure that is listed in [After working inside your system](#).

System memory

System memory guidelines

The PowerEdge T550 system supports DDR4 registered DIMMs (RDIMMs). System memory holds the instructions that are executed by the processor.

Your system contains 16 memory sockets organized into 8 channels per processor.

Memory channels are organized as follows:

Table 36. Memory channels

Processor	Channel A	Channel B	Channel C	Channel D	Channel E	Channel F	Channel G	Channel H
Processor 1	A1	A5	A3	A7	A2	A6	A4	A8
Processor 2	B1	B5	B3	B7	B2	B6	B4	B8

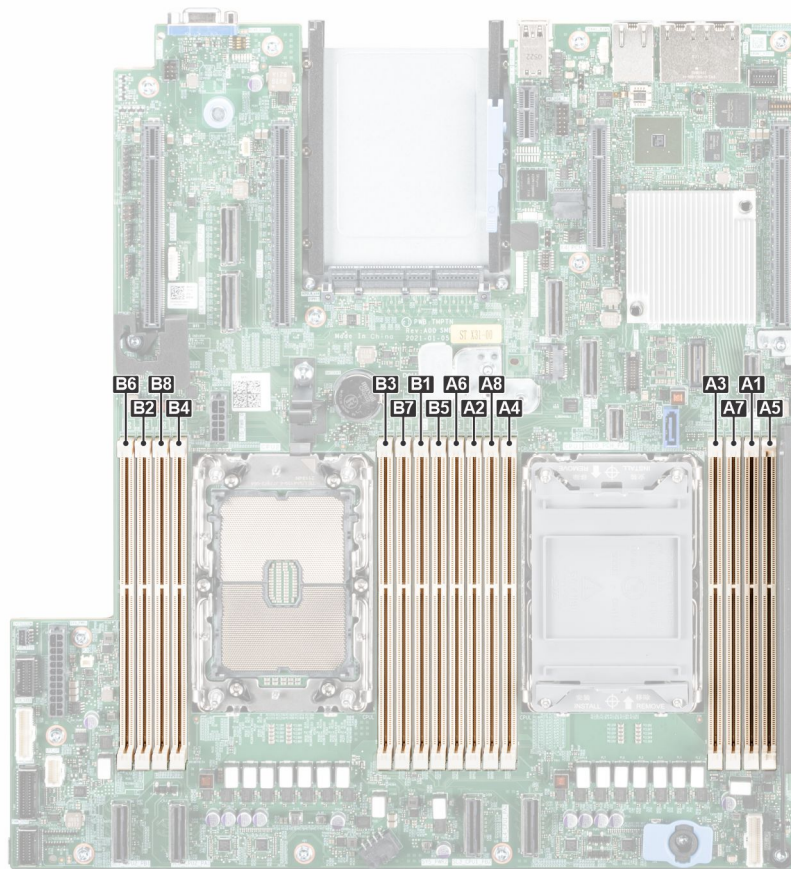

Figure 107. Memory channels

Single processor : Optimized population order: A1, A2, A3, A4, A5, A6, A7, A8 > Populate in this order.

Dual processor (populate round robin starting with processor1. Processor1 and processor2 DIMM population must be identical);Optimized population order: A1, B1, A2, B2, A3, B3, A4, B4, A5, B5, A6, B6, A7, B7, A8, B8.

 **NOTE:** For best performance, populate all memory channels equally 8 DIMMs.

Table 37. Supported memory matrix

DIMM type	Rank	Capacity	DIMM rated voltage and speed	Operating speed for DIMMs per Channel (DPC)
RDIMM	1R	8 GB	DDR4 (1.2V), 3200 MT/s	3200 MT/s
	2R	16 GB, 32 GB, 64 GB	DDR4 (1.2V), 3200 MT/s	3200 MT/s

General memory module installation guidelines

To ensure optimal performance of your system, observe the following general guidelines when configuring your system memory. If your system's memory configurations fail to observe these guidelines, your system might not boot, stop responding during memory configuration, or operate with reduced memory.

The memory bus may operate at speeds of 3200 MT/s, 2933 MT/s depending on the following factors:

- System profile selected (for example, Performance Optimized, or Custom [can be run at high speed or lower])
- Maximum supported DIMM speed of the processors
- Maximum supported speed of the DIMMs

 **NOTE:** MT/s indicates DIMM speed in MegaTransfers per second.

The system supports Flexible Memory Configuration, enabling the system to be configured and run in any valid chipset architectural configuration. The following are the recommended guidelines for installing memory modules:

- All DIMMs must be DDR4.
- x4 and x8 DRAM based memory modules can be mixed.
- If memory modules with different speeds are installed, they operate at the speed of the slowest installed memory module(s).
- Populate memory module sockets only if a processor is installed.
- In **Optimizer Mode**, the DRAM controllers operate independently in the 64-bit mode and provide optimized memory performance.
- Memory modules of different capacities can be mixed provided other memory population rules are followed.
- Mixing of more than two memory module capacities in a system is not supported.
- Unbalanced or odd memory configuration results in a performance loss and system may not identify the memory modules being installed, so always populate memory channels identically with equal DIMMs for best performance.

Table 38. Memory population configurations for RDIMM

Processor	Configuration	Memory population	Memory population information
Single processor	Optimizer (Independent channel) population order	A{1}, A{2}, A{3}, A{4}, A{5}, A{6}, A{7}, A{8}	1, 2, 4, 6, and 8 DIMMs are allowed.
Dual processor (Start with processor 1. Processor 1 and processor 2 population should match)	Optimizer (Independent channel) population order	A{1}, B{1}, A{2}, B{2}, A{3}, B{3}, A{4}, B{4}, A{5}, B{5}, A{6}, B{6}, A{7}, B{7}, A{8}, B{8}	2, 4, 8, 12, and 16 DIMMs are supported per system.  NOTE: Optimizer population order is not traditional for 8 and 16 DIMMs installations for dual processor.

Removing a memory module

Prerequisites

1. Follow the safety guidelines listed in [Safety instructions](#).
2. Follow the procedure that is listed in [Before working inside your system](#).
3. [Remove the air shroud](#).

 **WARNING:** The memory modules are hot to touch for some time after the system has been powered off. Allow the memory modules to cool before handling them.

Steps

1. Locate the appropriate memory module socket.
2. To release the memory module from the socket, simultaneously press the ejectors on both ends of the memory module socket to fully open.

CAUTION: Handle each memory module only by the card edges, ensuring not to touch the middle of the memory module or metallic contacts.

3. Lift the memory module away from the system.

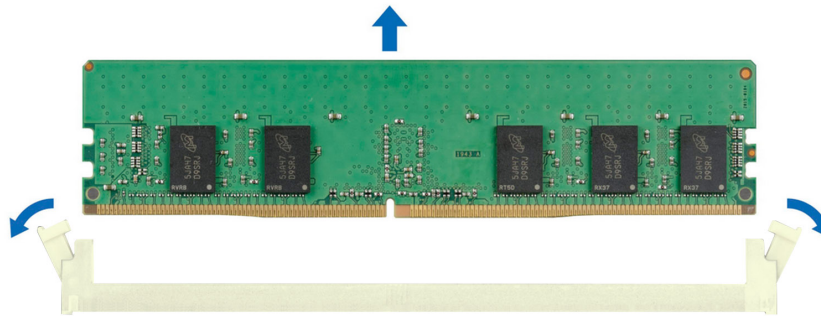

Figure 108. Removing a memory module

Next steps

Replace the memory module.

Installing a memory module

Prerequisites

1. Follow the safety guidelines listed in [Safety instructions](#).
2. Follow the procedure that is listed in [Before working inside your system](#).
3. [Remove the air shroud](#).

Steps

1. Locate the appropriate memory module socket.

CAUTION: Handle each memory module only by the card edges, ensuring not to touch the middle of the memory module or metallic contacts.

2. If a memory module is installed in the socket, remove it.

NOTE: Ensure the socket ejector latches are fully open, before installing the memory module.

3. Align the edge connector of the memory module with the alignment key of the memory module socket, and insert the memory module in the socket.

CAUTION: To prevent damage to the memory module or the memory module socket during installation, do not bend or flex the memory module; insert both ends of the memory module simultaneously.

NOTE: The memory module socket has an alignment key that enables you to install the memory module in the socket in only one orientation.

CAUTION: Do not apply pressure at the center of the memory module; apply pressure at both ends of the memory module evenly.

4. Press the memory module with your thumbs until the ejectors firmly click into place. When the memory module is properly seated in the socket, the levers on the memory module socket align with the levers on the other sockets that have memory modules installed.

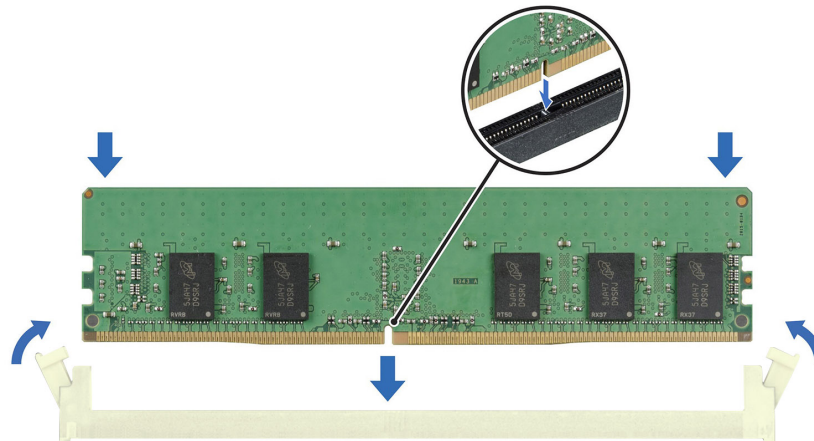

Figure 109. Installing a memory module

Next steps

1. [Install the air shroud.](#)
2. Follow the procedure listed in [After working inside your system.](#)
3. To verify if the memory module has been installed properly, press F2 and navigate to **System Setup Main Menu > System BIOS > Memory Settings**. In the **Memory Settings** screen, the System Memory Size must reflect the updated capacity of the installed memory.
4. If the System Memory Size is incorrect, one or more of the memory modules may not be installed properly. Ensure that the memory modules are firmly seated in their sockets.
5. Run the system memory test in system diagnostics.

Optional BOSS S2 module

Removing the BOSS S2 module

Prerequisites

1. Follow the safety guidelines listed in [Safety instructions.](#)
2. Follow the procedure that is listed in [Before working inside your system.](#)
3. [Remove the air shroud.](#)
4. If installed, [remove the front bezel.](#)
5. Disconnect the cables connected to the system board.

Steps

1. Using a Phillips 2 screwdriver, remove the screw securing the BOSS S2 module to the system.
2. Slide the BOSS S2 module out of the system.

i **NOTE:** The procedure to remove the BOSS S2 module is similar for all configurations.

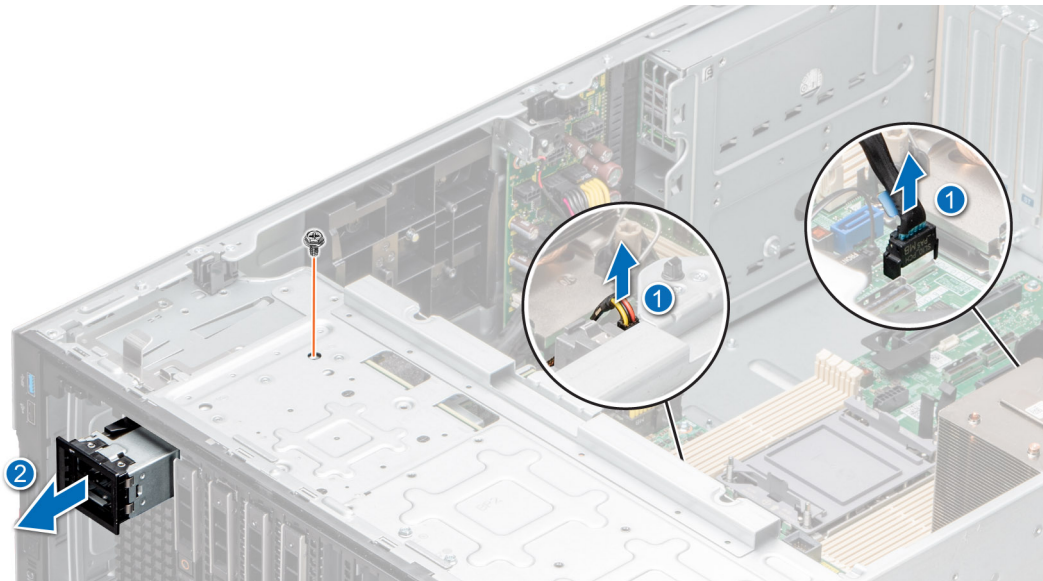

Figure 110. Removing the BOSS S2 module

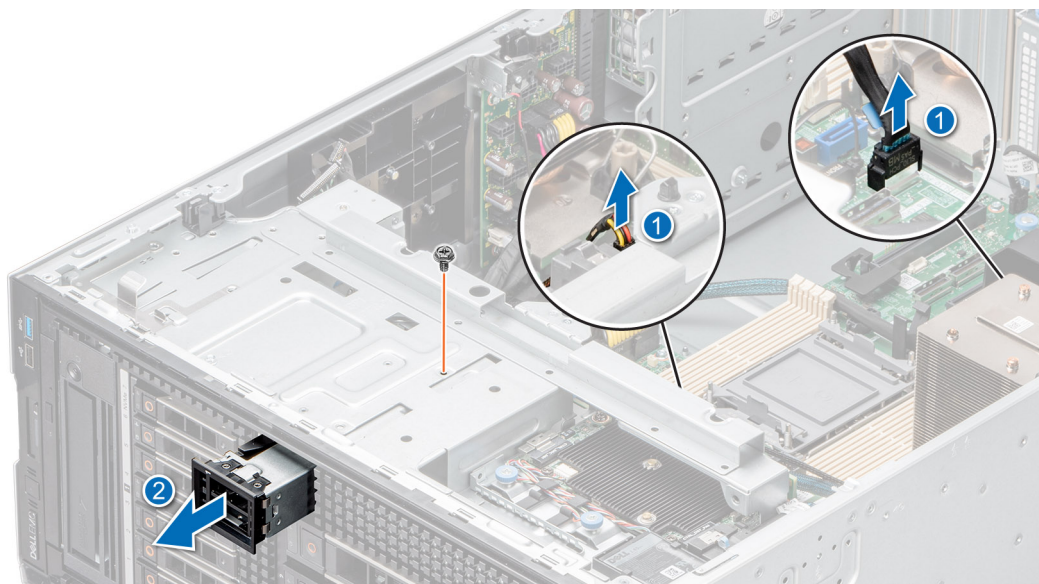

Figure 111. Removing the BOSS S2 module

3. Align the blank with the BOSS S2 module slot and push it into the bay until it clicks into place.

i **NOTE:** Blanks must be installed in empty slots to maintain FCC certification of the system. The blanks also keep dust and dirt out of the system and aid in proper cooling and airflow inside the system.

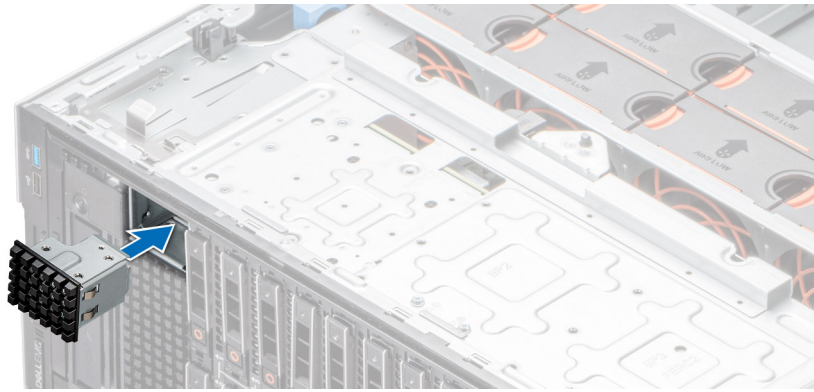

Figure 112. Installing the BOSS S2 module blank

Next steps

Replace the BOSS S2 module.

Installing the BOSS S2 module

Prerequisites

1. Follow the safety guidelines listed in [Safety instructions](#).
2. Follow the procedure that is listed in [Before working inside your system](#).
3. [Remove the air shroud](#).
4. If installed, [remove the front bezel](#).
5. Disconnect the cables connected to the system board.

Steps

1. If installed, remove the BOSS S2 module blank using a flat head screwdriver.

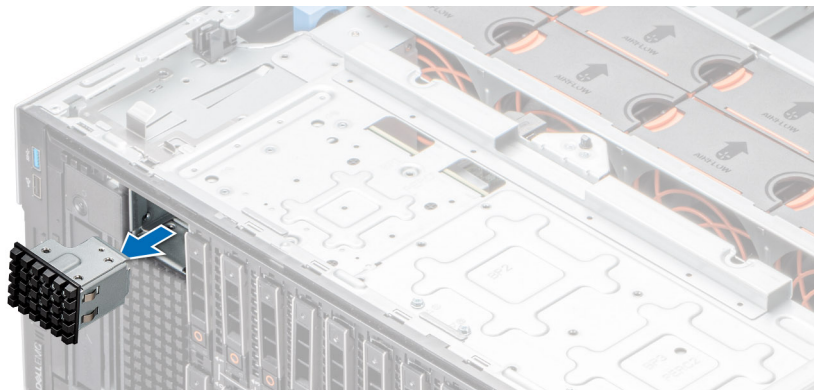

Figure 113. Removing the BOSS S2 module blank

2. Align the BOSS S2 module to the BOSS S2 slot on the chassis and push it into the slot.
3. Using a Phillips 2 screwdriver, secure the BOSS S2 module to the system.

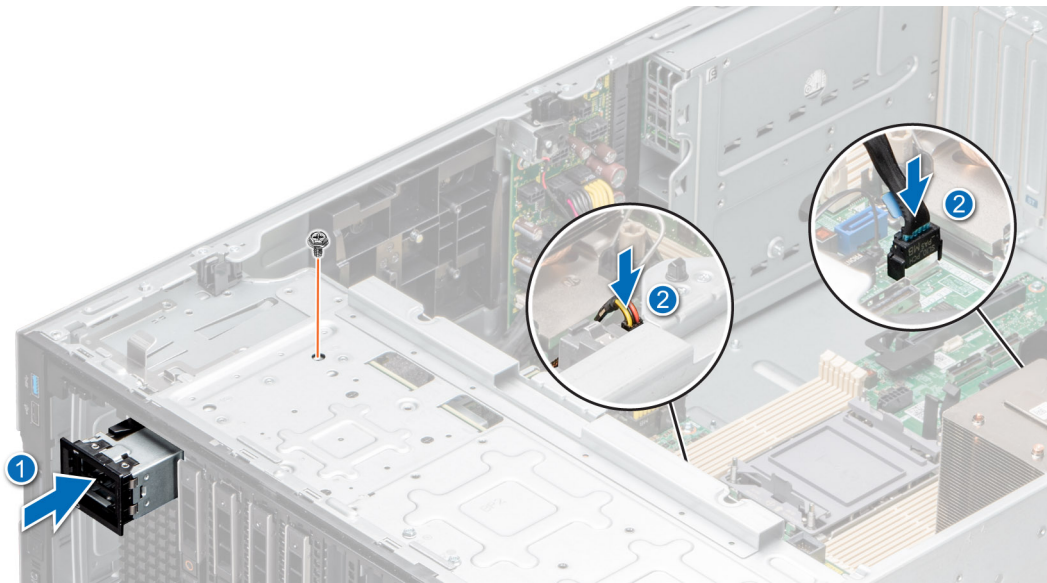

Figure 114. Installing the BOSS S2 module

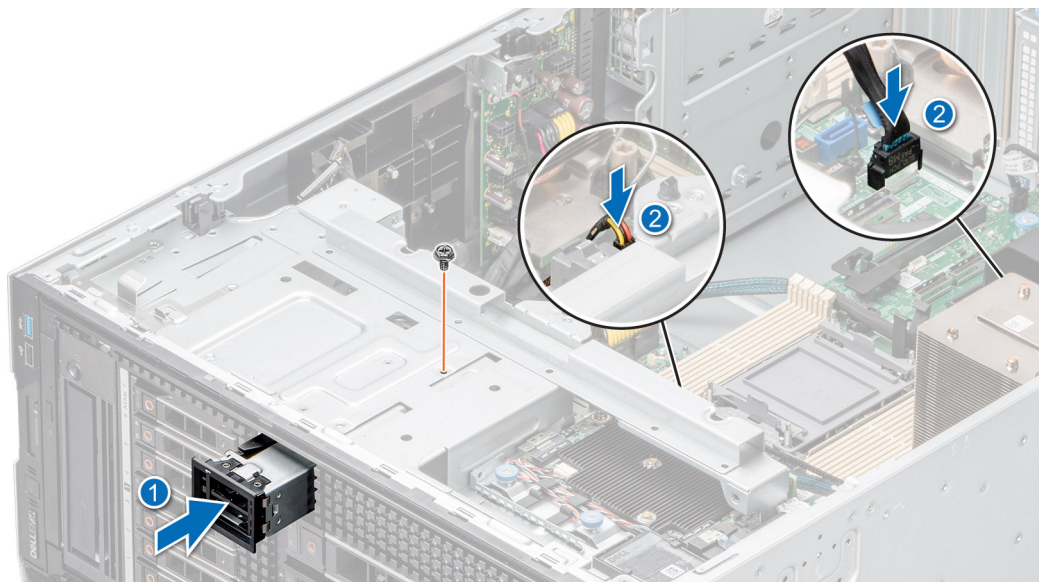

Figure 115. Installing the BOSS S2 module

Next steps

1. Connect the cables to the system board connectors.
i **NOTE:** Route the cables properly to prevent them from being pinched or crimped.
2. If removed, [install the front bezel](#).
3. [Install the air shroud](#).
4. Follow the procedure that is listed in [After working inside your system](#).

Removing the BOSS S2 card carrier

Prerequisites

1. Follow the safety guidelines listed in [Safety instructions](#).
2. Follow the procedure that is listed in [Before working inside your system](#).

3. If installed, [remove the front bezel](#).

Steps

1. Open the release latch and slide the BOSS S2 card carrier out of the BOSS S2 module.

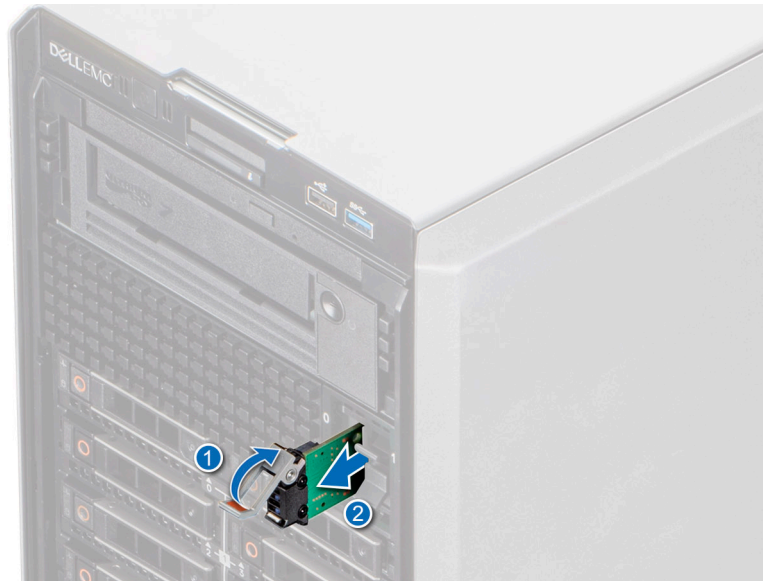

Figure 116. Removing the BOSS S2 card carrier

2. If not installing the BOSS S2 card carrier, align and push the BOSS S2 card carrier blank into the BOSS S2 module to fill the empty BOSS S2 card carrier slot.



Figure 117. Installing the BOSS S2 card carrier blank

Next steps

[Replace the BOSS S2 card carrier](#)

Installing the BOSS S2 card carrier

Prerequisites

1. Follow the safety guidelines listed in [Safety instructions](#).
2. Follow the procedure that is listed in [Before working inside your system](#).
3. If installed, [remove the front bezel](#).

Steps

1. Press the release clip and pull the BOSS S2 card carrier blank out of the system.



Figure 118. Removing the BOSS S2 card carrier blank

2. Align and push the BOSS S2 card carrier into the slot in the BOSS S2 module.
3. Close the release latch to secure the BOSS S2 card carrier.

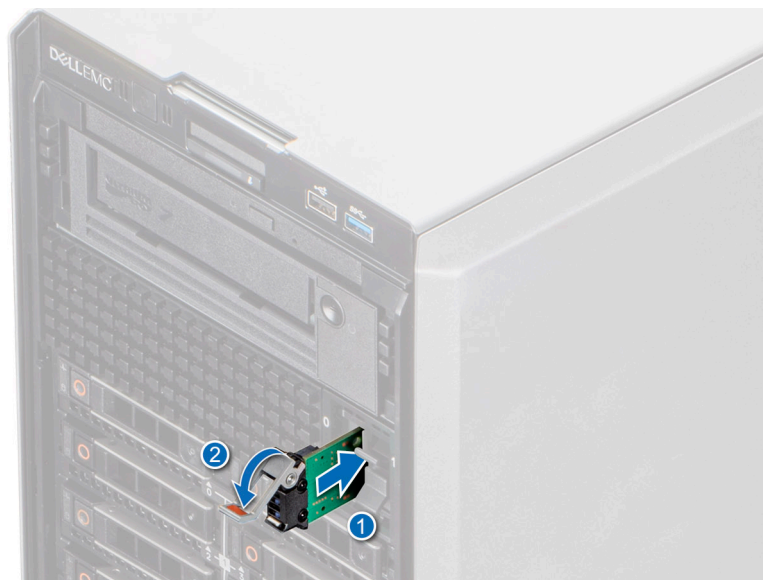

Figure 119. Installing the BOSS S2 card carrier

Next steps

1. [Install the air shroud.](#)
2. If removed, [install the front bezel.](#)
3. Follow the procedure that is listed in [After working inside your system.](#)

M.2 BOSS card

Removing the M.2 SSD module

Prerequisites

1. Follow the safety guidelines listed in [Safety instructions.](#)
2. Follow the procedure that is listed in [Before working inside your system.](#)
3. [Remove the BOSS S2 module.](#)

Steps

1. Using the Phillips #1 screwdriver, remove the screws securing the M.2 SSD module to the BOSS card.
2. Pull the M.2 SSD module to disconnect from the BOSS card connector.

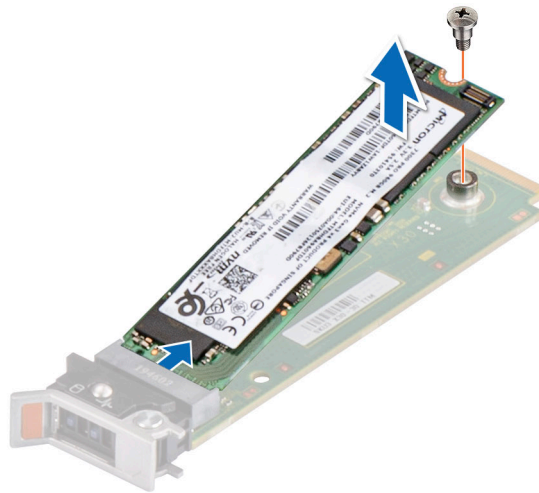

Figure 120. Removing the M.2 SSD

Next steps

[Replace the M.2 SSD module.](#)

Installing the M.2 SSD module

Prerequisites

1. Follow the safety guidelines listed in the [Safety instructions.](#)
2. Follow the procedure listed in the [Before working inside your system.](#)
3. [Remove the BOSS S2 module.](#)

i **NOTE:** The procedure to remove the BOSS card is similar to the removing an expansion card.

Steps

1. Align the M.2 SSD module at an angle with the BOSS card connector.
2. Insert the M.2 SSD module until it is firmly seated in the BOSS card connector.

- Using the Phillips #1 screwdriver, secure the M.2 SSD module on the BOSS card with the screw.

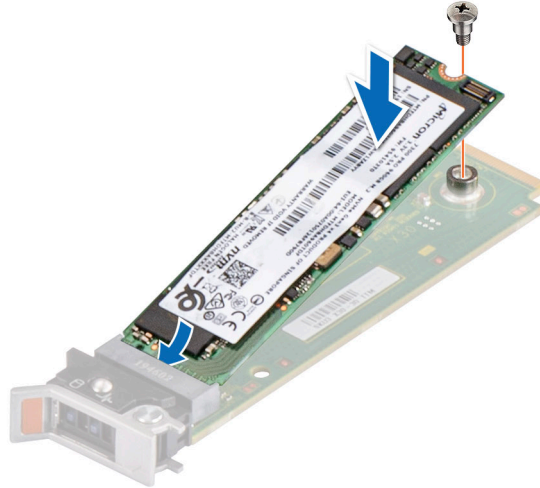

Figure 121. Installing the M.2 SSD

Next steps

- Install the BOSS S2 module.
- Follow the procedure listed in [After working inside your system](#).

Optional internal USB card

NOTE: To locate the internal USB port on the system board, see the [System board jumpers and connectors](#) section.

Removing the internal USB module

Prerequisites

- Follow the safety guidelines listed in [Safety instructions](#).
- Follow the procedure that is listed in [Before working inside your system](#).
- Remove the air shroud.
- If you are replacing the internal USB module, [remove the internal USB key](#).

Steps

Holding the blue pull tab, lift the internal USB module out of the system.

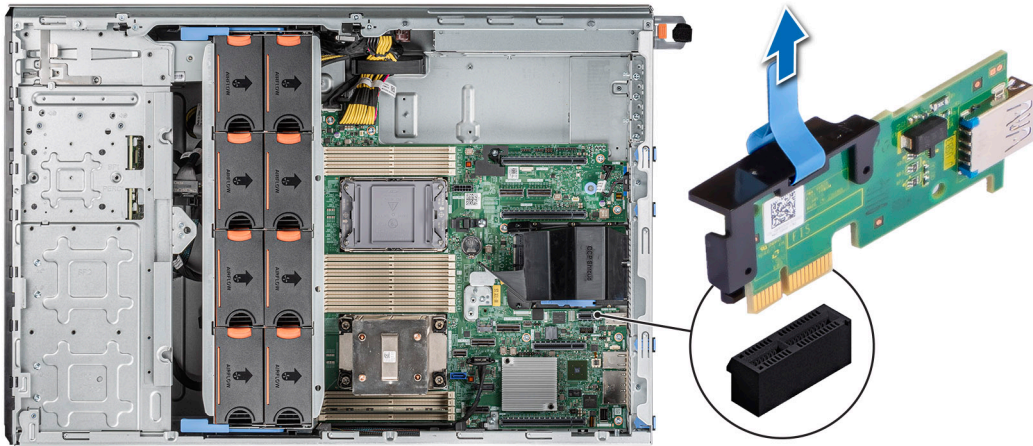

Figure 122. Removing the internal USB module

Next steps

Replace the internal USB module.

Installing the internal USB module

Prerequisites

1. Follow the safety guidelines listed in [Safety instructions](#).
2. Follow the procedure that is listed in [Before working inside your system](#).
3. [Remove the air shroud](#).

Steps

1. Locate the internal USB connector on the system board.

NOTE: For information on the exact location of internal USB on system board, see [System board jumpers and connector](#) section.

2. Align internal USB module with the connector on the system board.
3. Press the internal USB module until firmly seated on the system board.

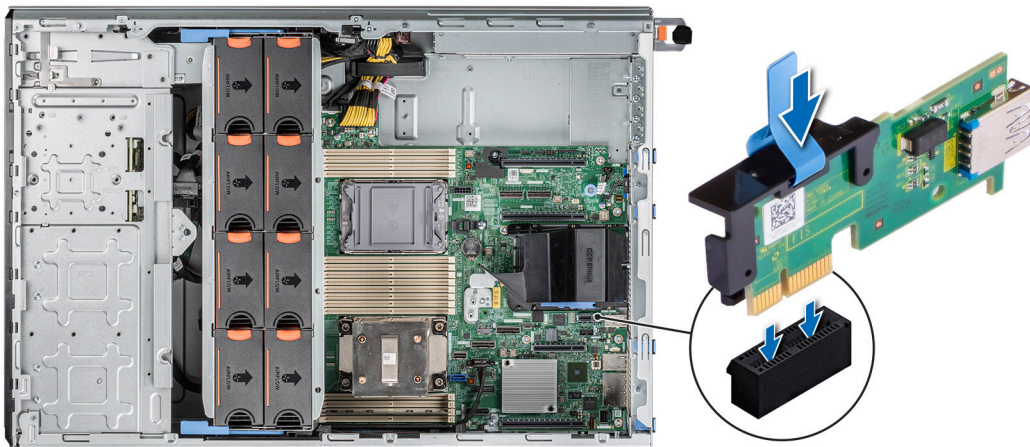

Figure 123. Installing the internal USB module

Next steps

1. [Install the internal USB key.](#)
2. [Install the air shroud.](#)
3. Follow the procedure listed in [After working inside your system.](#)

Internal USB memory key

Removing the internal USB memory key

Prerequisites

 **CAUTION:** To avoid interference with other components in the server, the maximum permissible dimensions of the USB memory key are 15.9 mm width x 57.15 mm length x 7.9 mm height.

1. Follow the safety guidelines listed in [Safety instructions.](#)
2. Follow the procedure that is listed in [Before working inside your system.](#)

Steps

Remove the USB memory key from the internal USB port.

Figure 124. Removing the internal USB memory key

Next steps

[Replace the internal USB memory key.](#)

Installing the internal USB memory key

Prerequisites

1. Follow the safety guidelines listed in [Safety instructions.](#)
2. Follow the procedure that is listed in [Before working inside your system.](#)

Steps

Connect the USB memory key into the internal USB port.

Figure 125. Installing the internal USB memory key

Next steps

1. Follow the procedure listed in [After working inside your system.](#)
2. While booting, press F2 to enter **System Setup** and verify that the system detects the USB memory key.

Optional IDSDM module

Removing the IDSDM module

Prerequisites

1. Follow the safety guidelines listed in [Safety instructions.](#)
2. Follow the procedure that is listed in [Before working inside your system.](#)
3. [Remove the air shroud.](#)

4. If you are replacing the IDSDM module, [remove the MicroSD cards](#).

i **NOTE:** Temporarily label each SD card with its corresponding slot number before removal. Reinstall the SD cards into the corresponding slots.

Steps

Holding the blue pull tab, lift the IDSDM module out of the system.

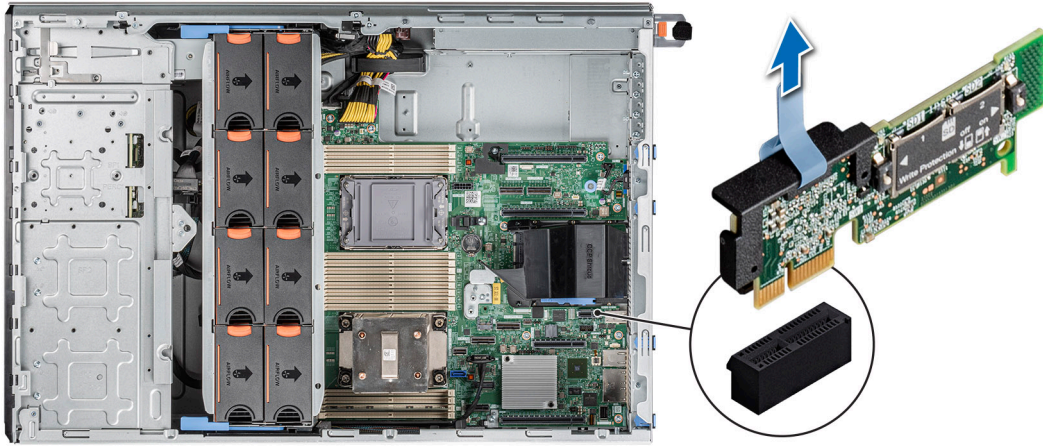

Figure 126. Removing the IDSDM module

Next steps

[Replace the IDSDM module.](#)

Installing the IDSDM module

Prerequisites

1. Follow the safety guidelines listed in [Safety instructions](#).
2. Follow the procedure that is listed in [Before working inside your system](#).
3. [Remove the air shroud](#).

Steps

1. Locate the IDSDM connector on the system board.

i **NOTE:** For information on the exact location of IDSDM on system board, see [System board jumpers and connector](#) section.

2. Align IDSDM module with the connector on the system board.
3. Press the IDSDM module until firmly seated on the system board.

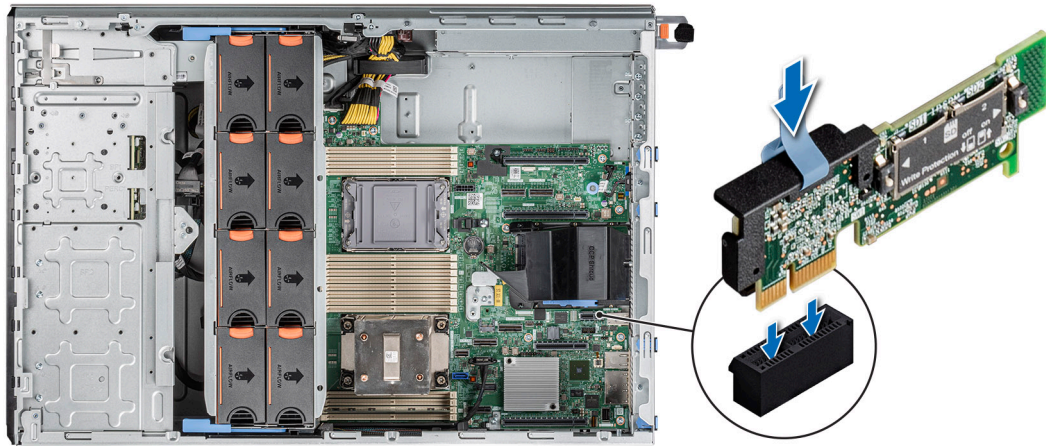

Figure 127. Installing the IDSDM module

Next steps

1. Install the MicroSD cards.
i **NOTE:** Reinstall the Micro-SD cards into the same slots based on the labels you had marked on the cards during removal.
2. Install the air shroud.
3. Follow the procedure listed in [After working inside your system](#).

MicroSD card

Removing the MicroSD card

Prerequisites

1. Follow the safety guidelines listed in [Safety instructions](#).
2. Follow the procedure that is listed in [Before working inside your system](#).
3. [Remove the IDSDM module](#).

Steps

1. Locate the MicroSD slot on the IDSDM module, and press the card to partially release it from the slot. For more information on the IDSDM module location, see [System board jumpers and connectors](#) section.
2. Hold the MicroSD card, and remove them from the IDSDM module.
i **NOTE:** Temporarily label each MicroSD card with the corresponding slot number after removal.

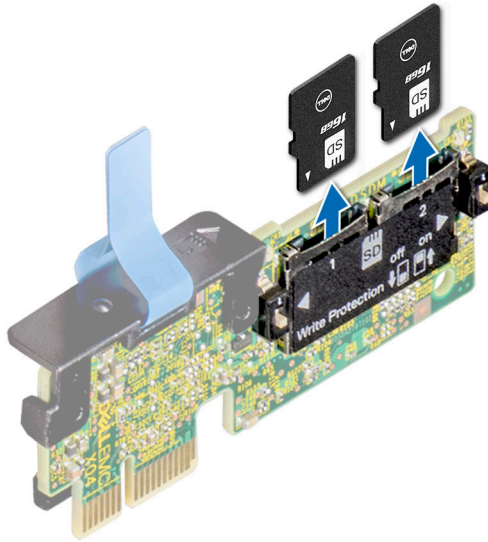

Figure 128. Removing the MicroSD card

Next steps

Replace the MicroSD cards.

Installing the MicroSD card

Prerequisites

1. Follow the safety guidelines listed in the [Safety instructions](#).
2. Follow the procedure listed in [Before working inside your system](#).

NOTE: To use an MicroSD card with your system, ensure that the **Internal SD Card Port** is enabled in System Setup.

NOTE: Ensure that you install the MicroSD cards into the same slots based on the labels you had marked on the cards during removal.

Steps

1. Locate the MicroSD card slot on the IDSDM module. Orient the MicroSD card appropriately and insert the contact-pin end of the card into the slot. To locate IDSDM, see the [System board jumpers and connectors](#) section.

NOTE: The slot is keyed to ensure correct insertion of the card.

2. Press the card into the slot to lock it into place.

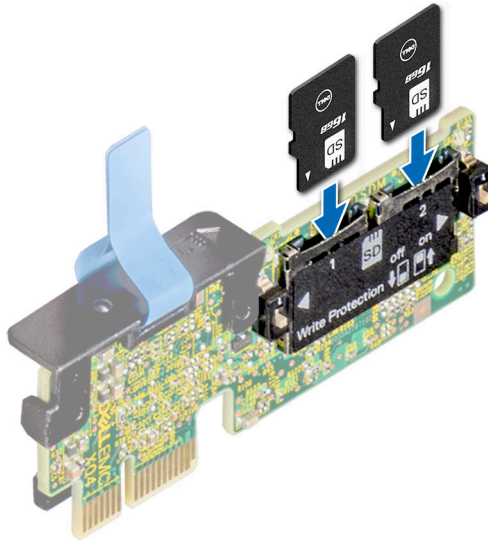

Figure 129. Installing the MicroSD card

Next steps

1. [Install the IDSDM module.](#)
2. Follow the procedure listed in [After working inside your system.](#)

Expansion cards

NOTE: When an expansion card is not supported or missing, the iDRAC and Lifecycle Controller logs an event. This does not prevent your system from booting. However, if a F1/F2 pause occurs with an error message, see *Troubleshooting expansion cards* section in the *Dell EMC PowerEdge Servers Troubleshooting Guide* at www.dell.com/poweredgemanuals.

Expansion card installation guidelines

Table 39. Supported riser configurations

Configuration Type	Riser configuration	Processors	x16 Processor 1 Slot 1 (FHFL)	x16 Processor 2 Slot 2 (FHFL)	x16 Processor 2 Slot 3 (FHFL)	x16 Processor 2 Slot 4 (FHHL)	X4 PCH Slot 5 (FHHL)	x16 Processor 1 Slot 6 (FHHL)
C0	N/A	2	0	0	1	1	1	1
C0-1	N/A	1	0	0	0	0	1	1
C1	1 x GPU riser	2	1	0	1	1	1	1
C1-1	1 x GPU riser	1	1	0	0	0	1	1
C2	2 x GPU riser	2	1	1	1	1	1	1

Table 40. Configuration type C0

Card Type	Slot priority	Maximum number of cards
FPERC 10.15 H345	Internal	2

Table 40. Configuration type C0 (continued)

Card Type	Slot priority	Maximum number of cards
PERC/HBA 10.15G H745	Internal	2
FPERC 11 H755N	Internal	1
FPERC 11 H755	Internal	2
FPERC HBA11 HBA355i	Internal	2
FPERC 11 H355	Internal	2
NIC 25 Gb: Broadcom, Intel, Mellanox	4, 6, 3	3
HBA: FC16: Qlogic, Avago	4, 6, 3	3
NIC 10 Gb: Broadcom, Intel	4, 6, 3	3
NIC 1 Gb: Broadcom, Intel	4, 6, 3, 5	4
OCP 25 Gb: Broadcom, Intel, Mellanox	Internal	1
OCP 10 Gb: Broadcom, Intel, Mellanox	Internal	1
OCP 1 Gb: Broadcom, Intel, Mellanox	Internal	1
BOSS S2: Inventec	Internal	1
PCIe SSD Gen3: Intel	4, 6, 3, 5	4
PCIe SSD Gen4: Samsung	4, 6, 3	3
GPU: Nvidia T4	4, 6, 3	3
Serial port module: Inventec	5	1
Foxconn external adapter H840	4, 6, 3	3
Foxconn external adapter HBA355e	4, 6, 3	3
aPERC HBA11 HBA355i	6	1

Table 41. Configuration type C0-1

Card Type	Slot priority	Maximum number of cards
FPERC 10.15 H345	Internal	2
PERC/HBA 10.15G H745	Internal	2
FPERC 11 H755N	Internal	1
FPERC 11 H755	Internal	2
FPERC HBA11 HBA355i	Internal	2
FPERC 11 H355	Internal	2
NIC 25 Gb: Broadcom, Intel, Mellanox	6	1

Table 41. Configuration type C0-1 (continued)

Card Type	Slot priority	Maximum number of cards
HBA: FC16: Qlogic, Avago	6	1
NIC 10 Gb: Broadcom, Intel	6	1
NIC 1 Gb: Broadcom, Intel	6, 5	2
OCP 25 Gb: Broadcom, Intel, Mellanox	Internal	1
OCP 10 Gb: Broadcom, Intel, Mellanox	Internal	1
OCP 1 Gb: Broadcom, Intel, Mellanox	Internal	1
BOSS S2: Inventec	Internal	1
PCIe SSD Gen3: Intel	6, 5	2
PCIe SSD Gen4: Samsung	6, 5	2
GPU: Nvidia T4	6	1
Serial port module: Inventec	5	1
Foxconn external adapter H840	4, 6, 3	3
Foxconn external adapter HBA355e	4, 6, 3	3
aPERC HBA11 HBA355i	6	1

Table 42. Configuration type C1

Card Type	Slot priority	Maximum number of cards
FPERC 10.15 H345	Internal	2
PERC/HBA 10.15G H745	Internal	2
FPERC 11 H755N	Internal	1
FPERC 11 H755	Internal	2
FPERC HBA11 HBA355i	Internal	2
FPERC 11 H355	Internal	2
NIC 25 Gb: Broadcom, Intel, Mellanox	1, 4, 6, 3	4
HBA: FC16: Qlogic, Avago	1, 4, 6, 3	4
NIC 10 Gb: Broadcom, Intel	1, 4, 6, 3	4
NIC 1 Gb: Broadcom, Intel	1, 4, 6, 3, 5	5
OCP 25 Gb: Broadcom, Intel, Mellanox	Internal	1

Table 42. Configuration type C1 (continued)

Card Type	Slot priority	Maximum number of cards
OCP 10 Gb: Broadcom, Intel, Mellanox	Internal	1
OCP 1 Gb: Broadcom, Intel, Mellanox	Internal	1
BOSS S2: Inventec	Internal	1
PCIe SSD Gen3: Intel	1, 4, 6, 3, 5	5
PCIe SSD Gen4: Samsung	1, 4, 6, 3	4
GPU: Nvidia A10, A30, A40	1	1
GPU: Nvidia T4	1, 4, 6, 3	4
Serial port module: Inventec	5	1
Foxconn external adapter H840	1, 4, 6, 3	4
Foxconn external adapter HBA355e	1, 4, 6, 3	4
Foxconn external adapter HBA355e	6	1

Table 43. Configuration type C1-1

Card Type	Slot priority	Maximum number of cards
FPERC 10.15 H345	Internal	2
PERC/HBA 10.15G H745	Internal	2
FPERC 11 H755N	Internal	1
FPERC 11 H755	Internal	2
FPERC HBA11 HBA355i	Internal	2
FPERC 11 H355	Internal	2
NIC 25 Gb: Broadcom, Intel, Mellanox	1, 6	2
HBA: FC16: Qlogic, Avago	1, 6	2
NIC 10 Gb: Broadcom, Intel	1, 6	2
NIC 1 Gb: Broadcom, Intel	1, 6, 5	3
OCP 25 Gb: Broadcom, Intel, Mellanox	Internal	1
OCP 10 Gb: Broadcom, Intel, Mellanox	Internal	1
OCP 1 Gb: Broadcom, Intel, Mellanox	Internal	1
BOSS S2: Inventec	Internal	1
PCIe SSD Gen3: Intel	1, 6, 5	3

Table 43. Configuration type C1-1 (continued)

Card Type	Slot priority	Maximum number of cards
PCIe SSD Gen4: Samsung	1, 6	2
GPU: Nvidia A10, A30, A40	1	1
GPU: Nvidia T4	1, 6	2
Serial port module: Inventec	5	1
Foxconn external adapter H840	1, 6	2
Foxconn external adapter HBA355e	1, 6	2
aPERC HBA11 HBA355i	6	1

Table 44. Configuration type C2

Card Type	Slot priority	Maximum number of cards
FPERC 10.15 H345	Internal	2
PERC/HBA 10.15G H745	Internal	2
FPERC 11 H755N	Internal	1
FPERC 11 H755	Internal	2
FPERC HBA11 HBA355i	Internal	2
FPERC 11 H355	Internal	2
NIC 25 Gb: Broadcom, Intel, Mellanox	1, 2, 4, 6, 3	5
HBA: FC16: Qlogic, Avago	1, 2, 4, 6, 3	5
NIC 10 Gb: Broadcom, Intel	1, 2, 4, 6, 3	5
NIC 1 Gb: Broadcom, Intel	1, 2, 4, 6, 3, 5	6
OCP 25 Gb: Broadcom, Intel, Mellanox	Internal	1
OCP 10 Gb: Broadcom, Intel, Mellanox	Internal	1
OCP 1 Gb: Broadcom, Intel, Mellanox	Internal	1
BOSS S2: Inventec	Internal	1
PCIe SSD Gen3: Intel	1, 2, 4, 6, 3, 5	6
PCIe SSD Gen4: Samsung	1, 2, 4, 6, 3	5
GPU: Nvidia A10, A30, A40	1, 2	2
GPU: Nvidia T4	1, 2, 4, 6, 3	5
Serial port module: Inventec	5	1

Table 44. Configuration type C2 (continued)

Card Type	Slot priority	Maximum number of cards
Foxconn external adapter H840	1, 2, 4, 6, 3	5
Foxconn external adapter HBA355e	1, 2, 4, 6, 3	5
aPERC HBA11 HBA355i	6	1

Removing an expansion card

Prerequisites

1. Follow the safety guidelines listed in [Safety instructions](#).
2. Follow the procedure that is listed in [Before working inside your system](#).
3. [Remove the air shroud](#).

Steps

1. Disconnect the cables from the expansion card.
2. Press the expansion card latch and push down the latch to open it.
3. Hold the expansion card by the edge, and pull the card up to remove it from the expansion card connector and the system.

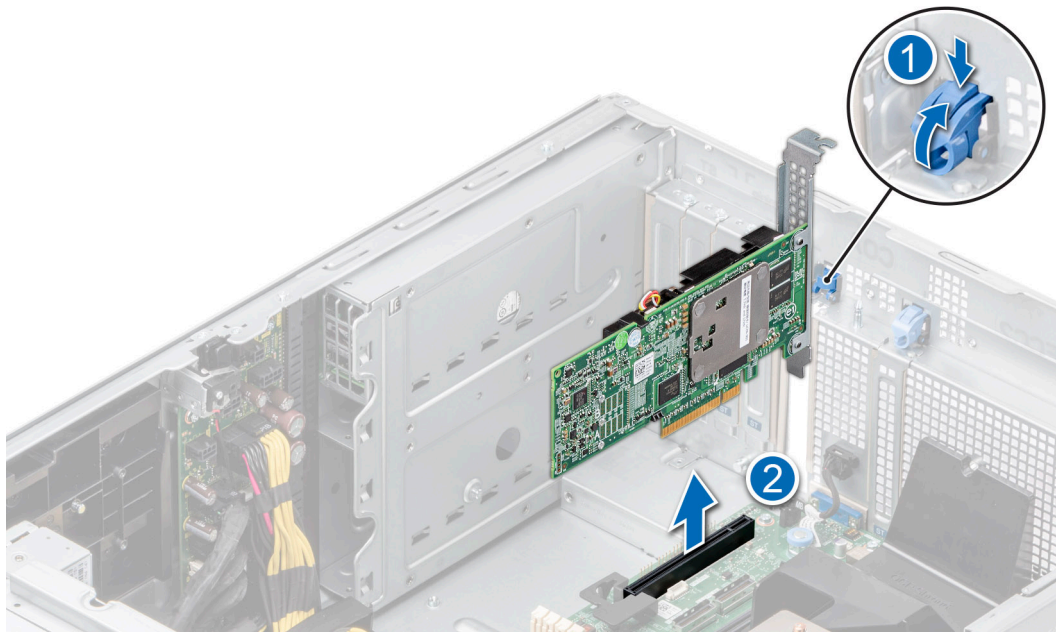

Figure 130. Removing an expansion card

4. Install the filler brackets by performing the following steps:
 - a. Align the slot on the filler bracket with the tab on the expansion card slot.
 - b. Press the expansion card latch till the filler bracket locks into place.
- NOTE:** Filler brackets must be installed in empty expansion-card slots to maintain FCC certification of the system. The brackets also keep dust and dirt out of the system and aid in proper cooling and airflow inside the system.

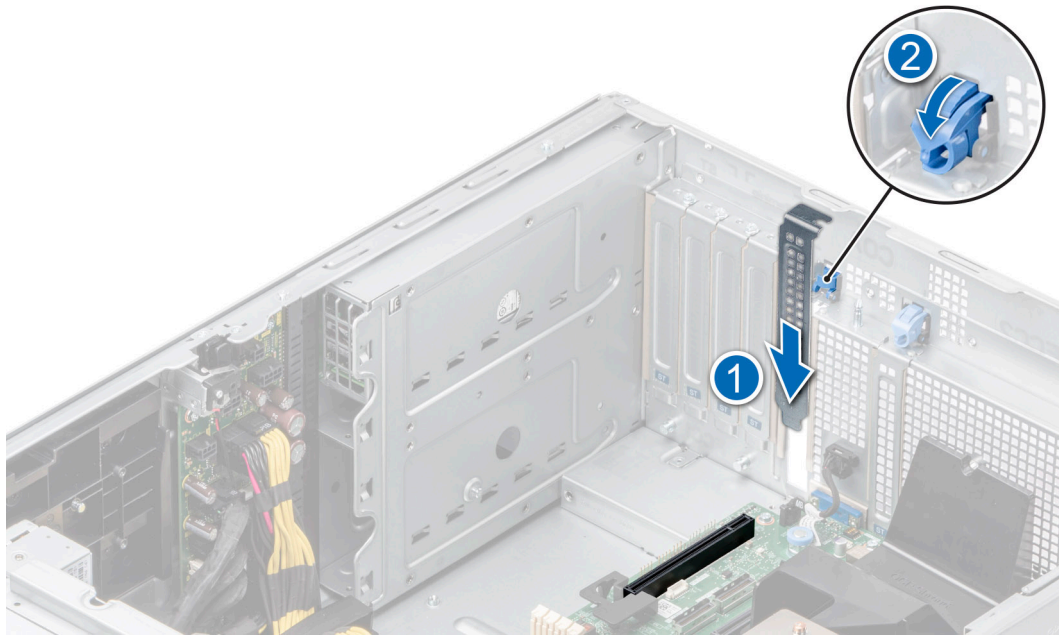

Figure 131. Installing the filler bracket

Next steps

Replace the expansion card.

Installing an expansion card

Prerequisites

1. Follow the safety guidelines listed in [Safety instructions](#).
2. Follow the procedure that is listed in [Before working inside your system](#).
3. [Remove the air shroud](#).

Steps

1. Unpack the expansion card and prepare it for installation.
For instructions, see the documentation accompanying the card.
2. Open the expansion card latch adjacent to the slot you want to install the expansion card.
3. Remove the existing expansion card or filler bracket from the expansion card holder.

i NOTE: Store this bracket for future use. Filler brackets must be installed in empty expansion-card slots to maintain FCC certification of the system. The brackets also keep dust and dirt out of the system and aid in proper cooling and airflow inside the system.

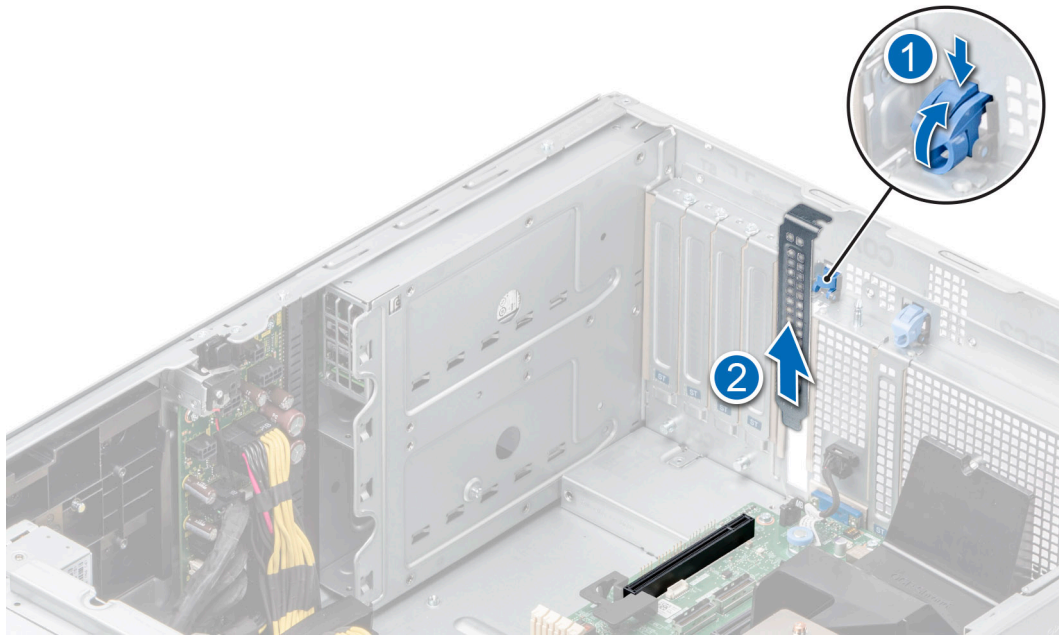

Figure 132. Removing the filler bracket

4. Holding the card by the edges, position the card so that the card aligns with the expansion card connector.
5. Insert the card firmly into the expansion card connector until the card is fully seated.
6. Close the expansion card latch by pushing the latch up until the latch snaps into place.

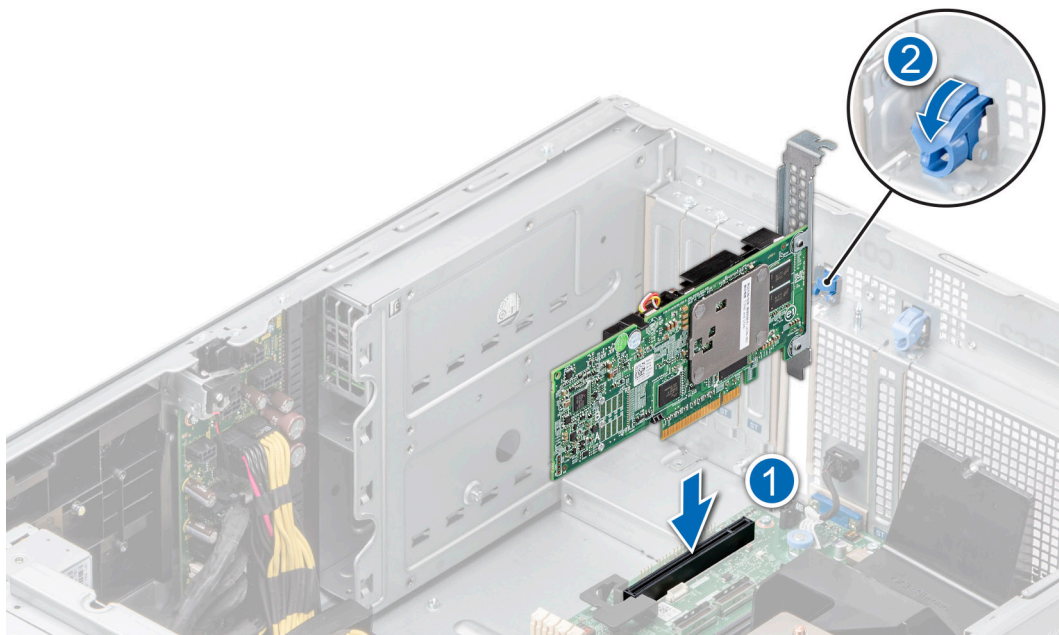

Figure 133. Installing an expansion card

7. Connect the cables to the expansion card.

Next steps

1. [Install the air shroud.](#)
2. Follow the procedure listed in [After working inside your system.](#)

GPU card holder

Removing the GPU card holder

Prerequisites

1. Follow the safety guidelines listed in [Safety instructions](#).
2. Follow the procedure that is listed in [Before working inside your system](#).
3. [Remove the air shroud](#).

Steps

Loosen the captive screws and pull the GPU card holder from the system.

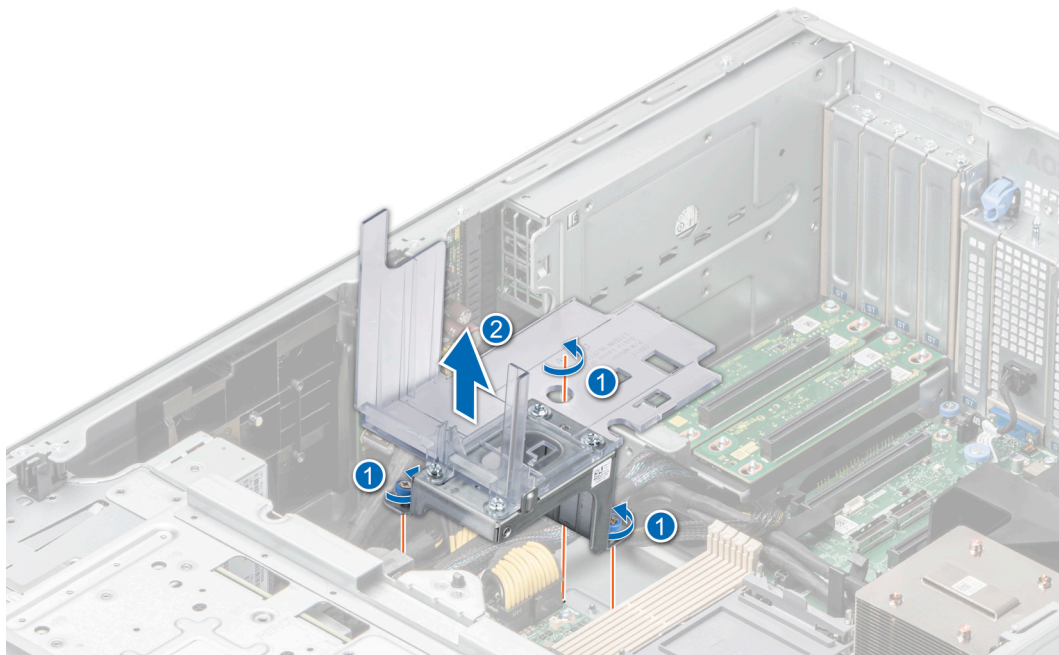

Figure 134. Removing GPU card holder

Next steps

Replace the GPU card holder.

Installing the GPU card holder

Prerequisites

1. Follow the safety guidelines listed in [Safety instructions](#).
2. Follow the procedure that is listed in [Before working inside your system](#).
3. [Remove the air shroud](#).

Steps

1. Align and lower the GPU card holder to the guide pin on the system.
2. Tighten the captive screws, until the GPU card holder is firmly seated.

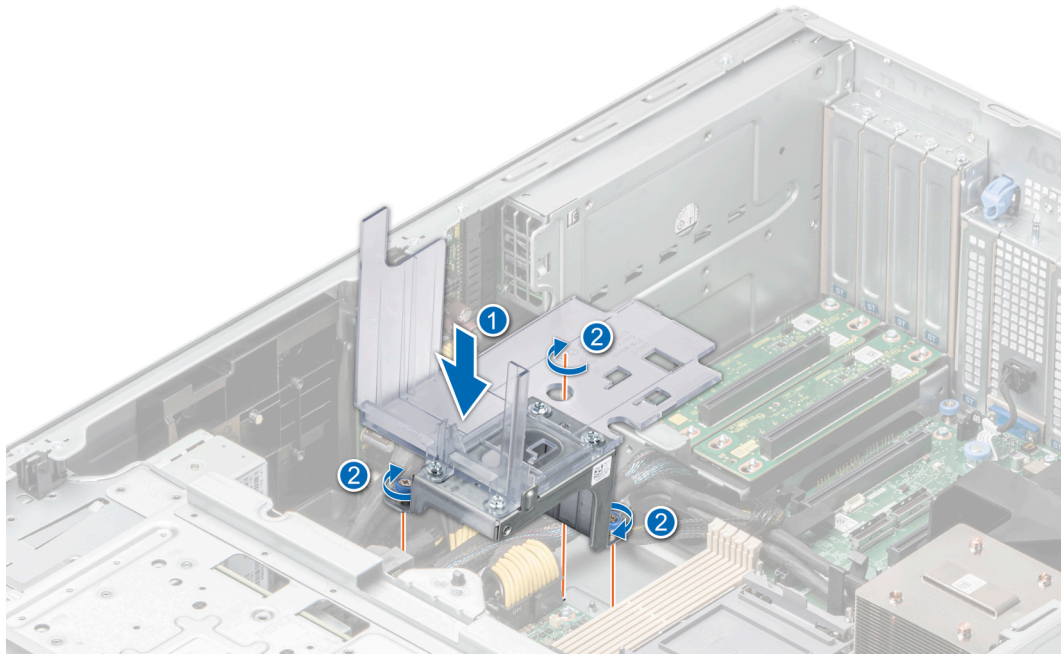

Figure 135. Installing the GPU card holder

Next steps

1. [Install the air shroud.](#)
2. Follow the procedure listed in [After working inside your system.](#)

Optional GPU card

Removing the GPU card

Prerequisites

1. Follow the safety guidelines listed in [Safety instructions.](#)
2. Follow the procedure that is listed in [Before working inside your system.](#)
3. [Remove the air shroud.](#)

i **NOTE:** The GPU card images below are representative and may not match the actual GPU card to remove.

Steps

1. Remove the screws securing the GPU card.
2. Hold the GPU card by the edges, and pull the card until the card edge connector disengages from the connector on the expansion card slot.

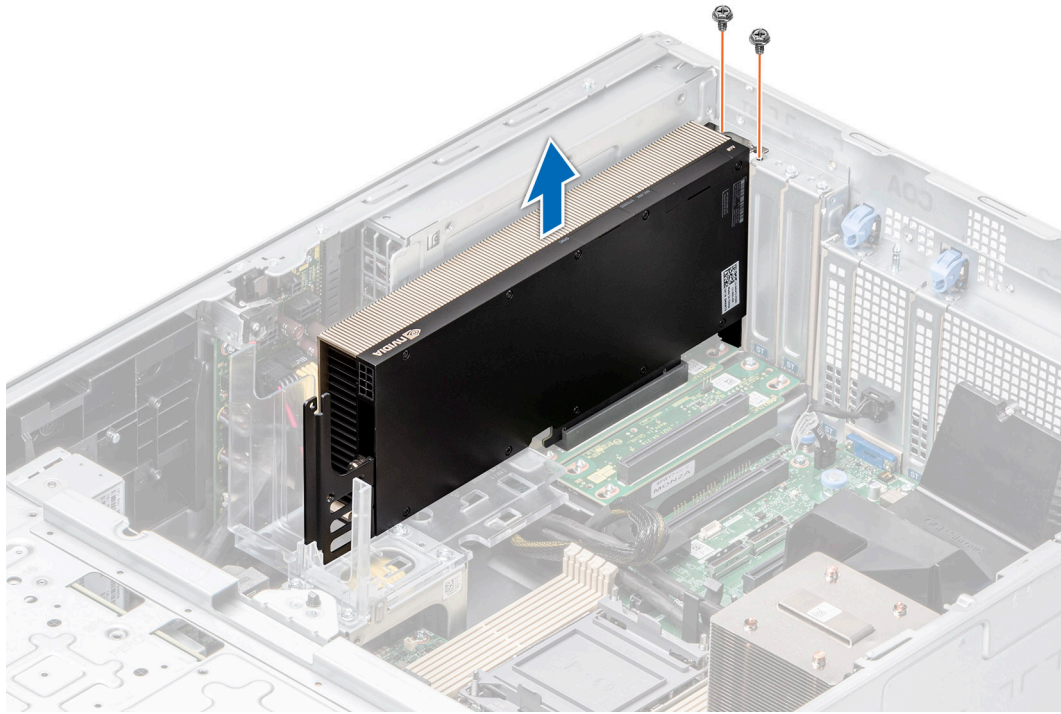

Figure 136. Removing the GPU card

3. If you are removing the GPU card permanently, install filler brackets over the empty slot openings, and use the screws to secure the filler brackets to the system.

i **NOTE:** You must install a filler bracket over an empty expansion card slot to maintain Federal Communications Commission (FCC) certification of the system. The brackets also keep dust and dirt out of the system and aid in proper cooling and airflow inside the system. The filler bracket is necessary to maintain proper thermal conditions.

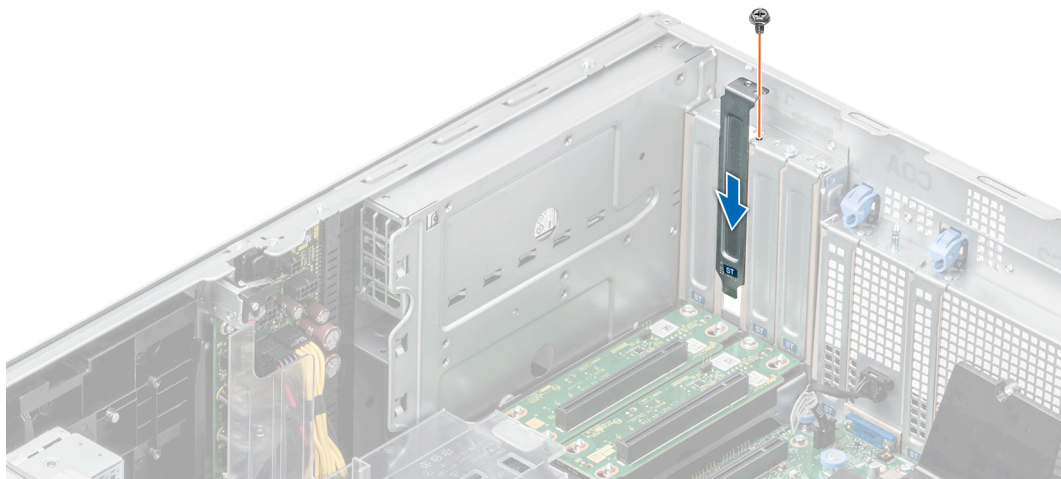

Figure 137. Installing a filler bracket

Next steps

Replace the GPU card.

Installing the GPU card

Prerequisites

1. Follow the safety guidelines listed in [Safety instructions](#).
2. Follow the procedure that is listed in [Before working inside your system](#).
3. If installing a new GPU card, unpack it and prepare the card for installation.
 - i** **NOTE:** For instructions, see the documentation accompanying the card.
4. [Remove the air shroud](#).
5. [Install GPU card holder](#), if required.

i **NOTE:** The GPU card images below are representative and may not match the actual GPU card to install.

Steps

1. If installed, remove the filler brackets.

i **NOTE:** Store the filler bracket for future use. Filler brackets must be installed in empty expansion card slots to maintain Federal Communications Commission (FCC) certification of the system. The brackets also keep dust and dirt out of the system and aid in proper cooling and airflow inside the system.

2. Remove the screws securing the filler brackets and remove the filler brackets from the system.

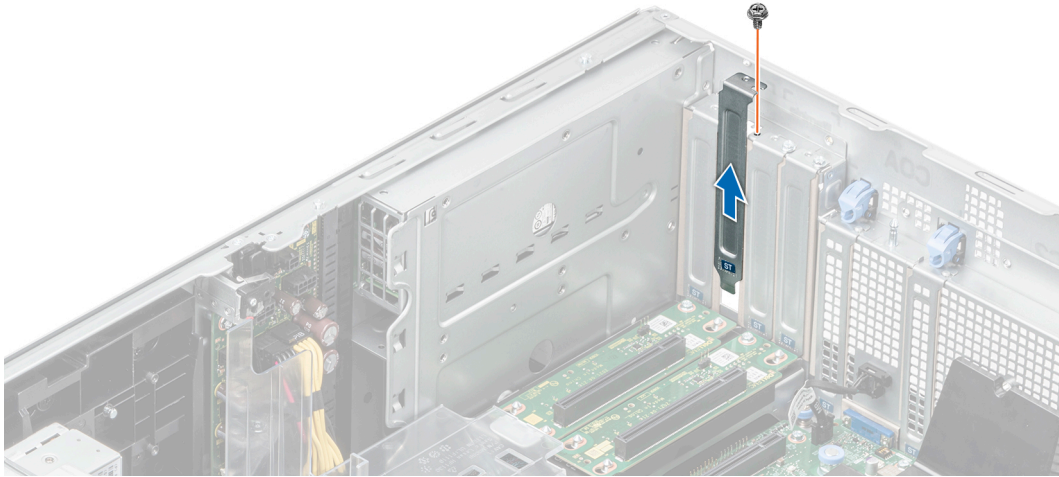

Figure 138. Removing the filler bracket

3. Hold the GPU card by the edges, and align the card edge connector with the expansion card connector on the system board.
4. Insert the GPU card into the expansion card slot on the system board, until it is firmly seated.
5. Use the screws to secure the GPU card to the system.

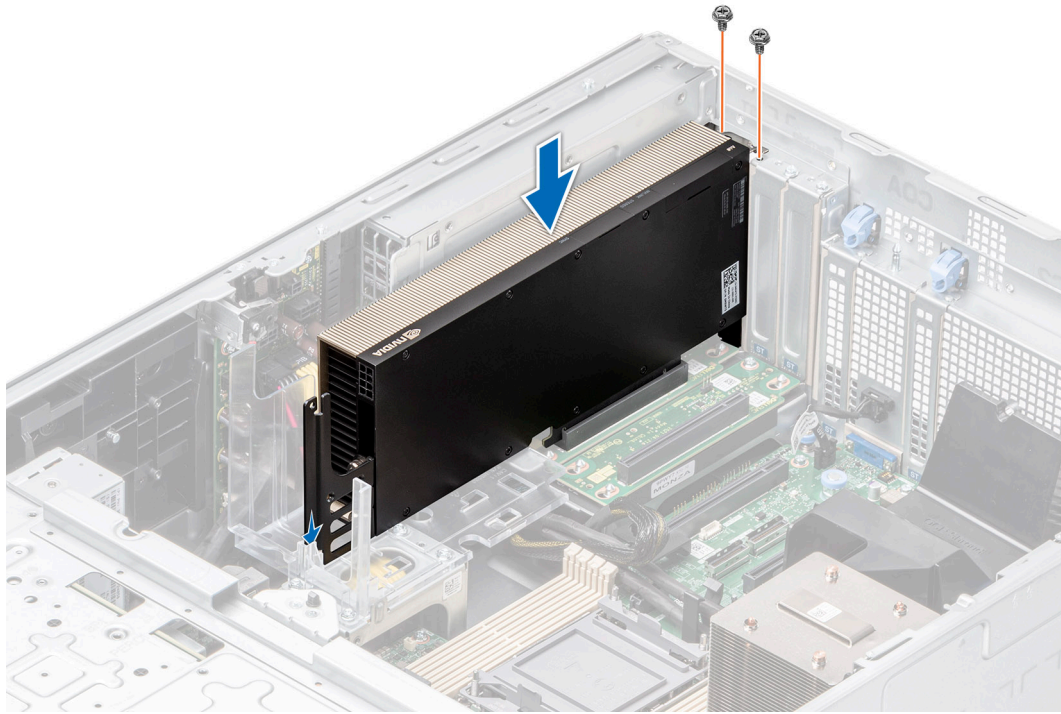

Figure 139. Installing the GPU card

Next steps

1. [Install the air shroud.](#)
2. Follow the procedure listed in [After working inside your system.](#)

GPU riser

Removing the GPU riser

Prerequisites

1. Follow the safety guidelines listed in [Safety instructions.](#)
2. Follow the procedure that is listed in [Before working inside your system.](#)
3. [Remove the air shroud.](#)

Steps

1. Disconnect the cables from the GPU riser connected to the system board.
2. Loosen the captive screws and pull the GPU riser from the system.

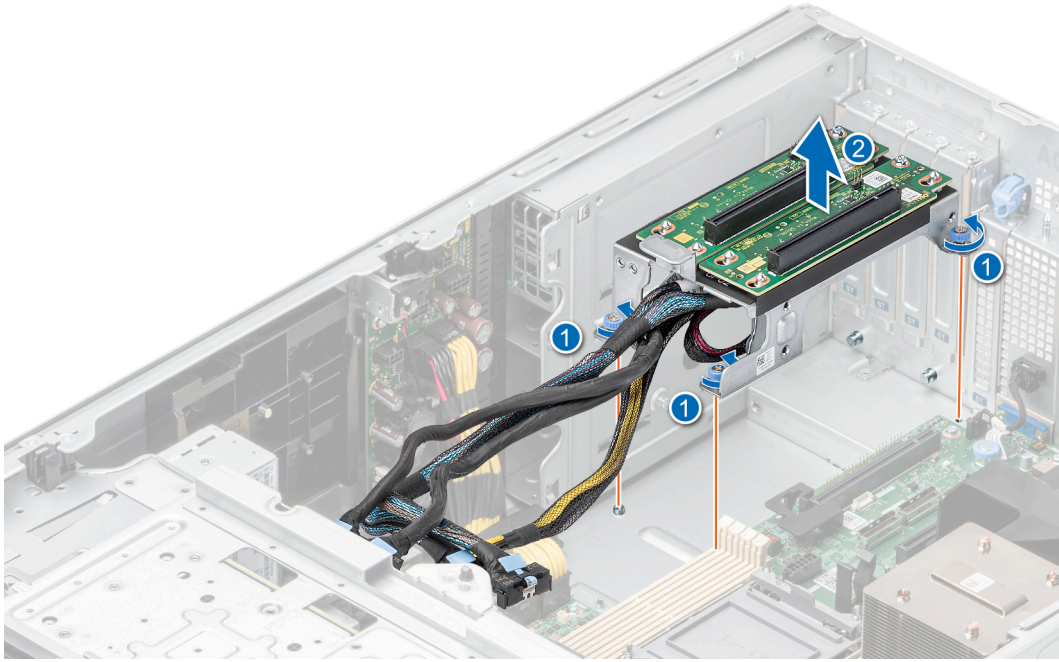

Figure 140. Removing the GPU riser

Next steps

Replace the GPU riser.

Installing the GPU riser

Prerequisites

1. Follow the safety guidelines listed in [Safety instructions](#).
2. Follow the procedure that is listed in [Before working inside your system](#).
3. [Remove the air shroud](#).

Steps

1. Align the GPU riser to the guide pins and lower the GPU riser in the system.
2. Tighten the captive screws, until the GPU riser is firmly seated.

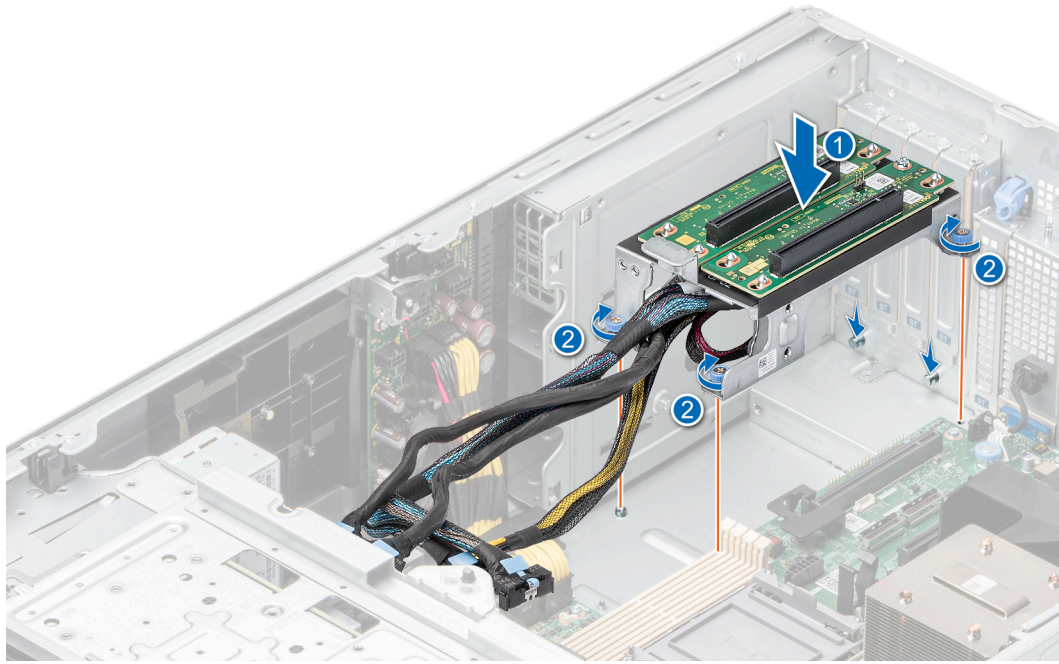

Figure 141. Installing the GPU riser

Next steps

1. Connect the cables to the system board connectors.
2. [Install the air shroud.](#)
3. Follow the procedure listed in [After working inside your system.](#)

Processor and heat sink module

This is a service technician replaceable part only.

Removing the processor and heat sink module

Prerequisites

1. Follow the safety guidelines listed in [Safety instructions.](#)
2. Follow the procedure that is listed in [Before working inside your system.](#)
3. [Remove the air shroud.](#)

i **NOTE:** The heat sink and processor are hot to touch for some time after the system has been powered down. Allow the heat sink and processor to cool down before handling them.

Steps

1. Ensure all four anti-tilt wires are in the locked position (outward position), and then using a Torx T30 tool, loosen the captive nuts on the processor heat sink module (PHM) in the order that is mentioned below:
 - a. Loosen the first nut three turns.
 - b. Loosen the nut diagonally opposite to the nut you loosened first.
 - c. Repeat the procedure for the remaining two nuts.
 - d. Return to the first nut and loosen it completely.

i **NOTE:** Ensure that the anti-tilt wires on the PHM are in locked position when loosening the captive nuts.
2. Set all the anti-tilt wires to unlocked position (inward position).

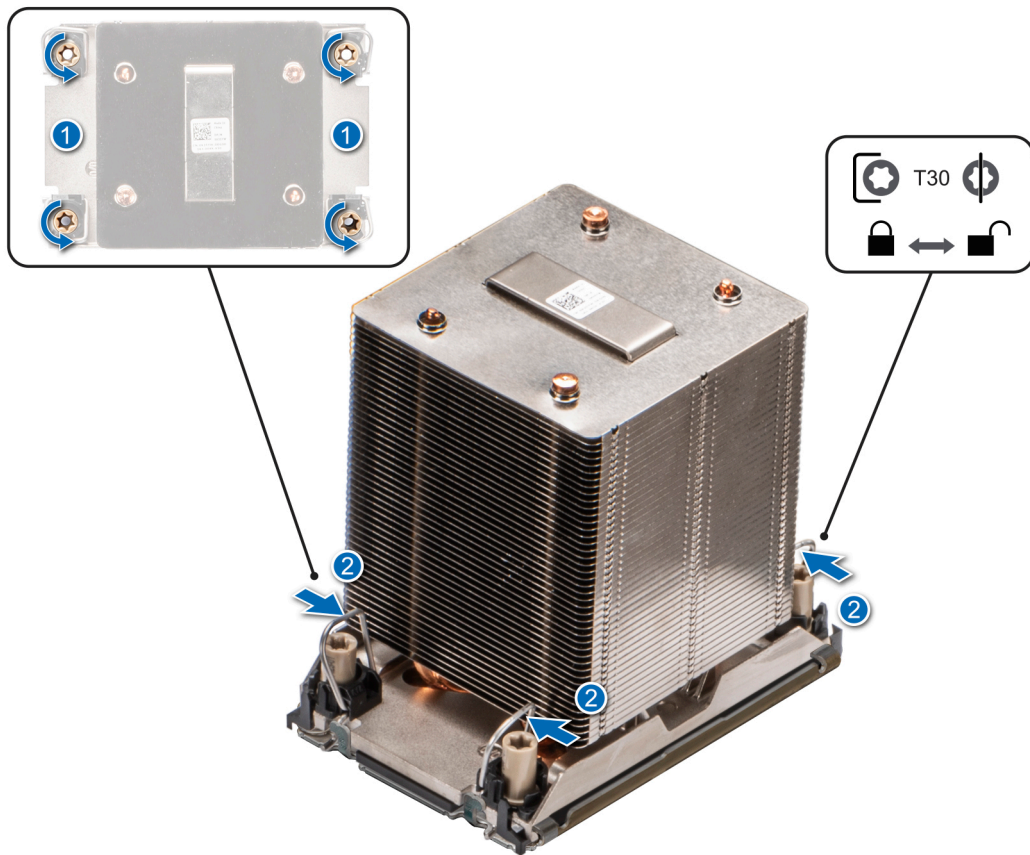

Figure 142. Removing the processor heat sink module

3. Lift the PHM from the system and set the PHM aside with the processor side facing up.

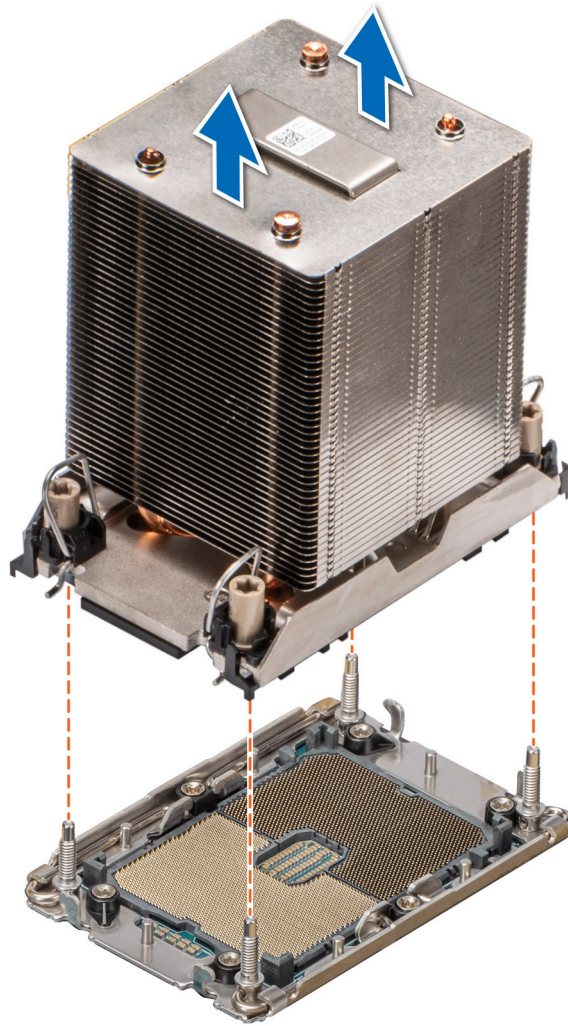

Figure 143. Removing a heat sink

Next steps

If you are removing a faulty heat sink, [replace the heat sink](#), if not, [remove the processor](#).

Removing the processor

Prerequisites

⚠ WARNING: Remove the processor from processor and heat sink module (PHM) only if you are replacing the processor or heat sink.

1. Follow the safety guidelines listed in [Safety instructions](#).
2. Follow the procedure that is listed in [Before working inside your system](#).
3. [Remove the air shroud](#).
4. [Remove the processor heat sink module](#).

⚠ CAUTION: You may find the CMOS battery loss or CMOS checksum error displayed during the first instance of powering on the system after the processor or system board replacement which is expected. To fix this, simply go to setup option to configure the system settings.

Steps

1. Place the heat sink with the processor side facing up.

2. Using your thumb, lift up the thermal interface material (TIM) break lever to release the processor from the TIM and retaining clip.
 3. Holding the processor by the edges, lift the processor away from the retaining clip.
- i** **NOTE:** Ensure to hold the retaining clip to the heat sink as you lift the TIM break lever.

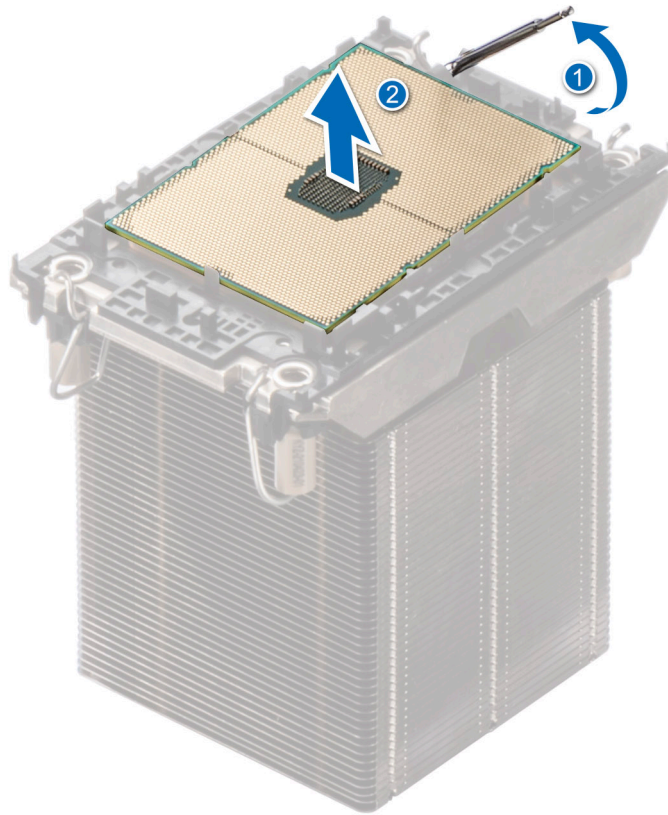

Figure 144. Lift up the TIM break lever

i **NOTE:** Ensure to return the TIM break lever back to original position.

4. Using your thumb and index finger, first hold the retaining clip release tab at the pin 1 connector, pull out the tip of the retaining clip release tab, and then lift the retaining clip partially from the heat sink.
5. Repeat the procedure at the remaining three corners of the retaining clip.
6. After all the corners are released from the heat sink, lift the retaining clip from the pin 1 corner of the heat sink.

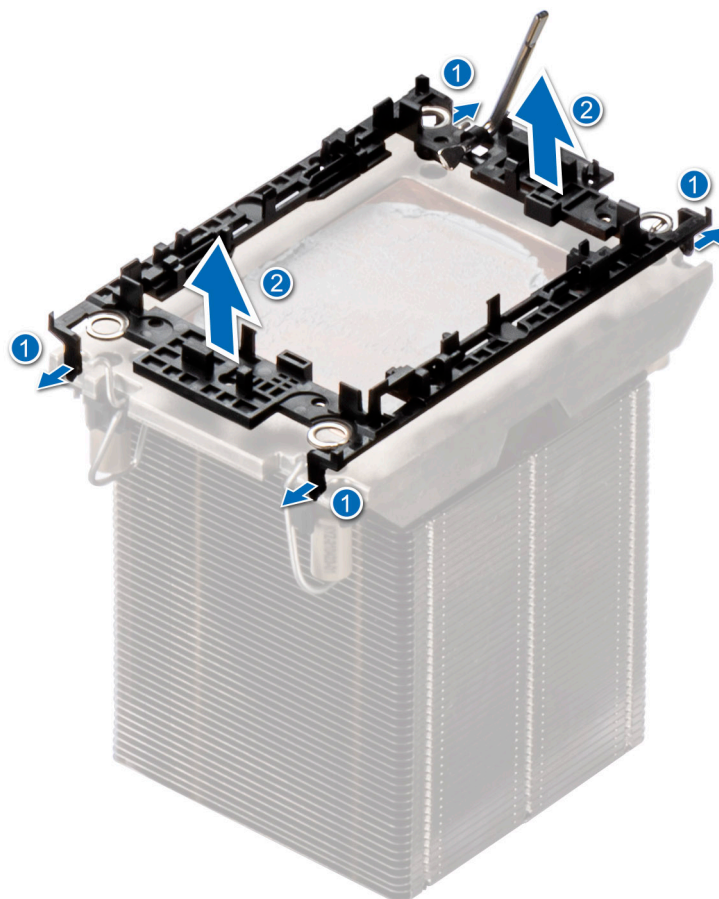

Figure 145. Removing the retaining clip

Next steps

Replace the processor.

Installing the processor

Prerequisites

1. Follow the safety guidelines listed in [Safety instructions](#).
2. Follow the procedure that is listed in [Before working inside your system](#).
3. [Remove the air shroud](#).
4. [Remove the processor heat sink module](#).

Steps

1. Place the processor in the processor tray.

NOTE: Ensure the pin 1 indicator on the processor tray is aligned with the pin 1 indicator on the processor.

2. Place the retaining clip on top of the processor in the processor tray aligning pin 1 indicator on the processor.

NOTE: Ensure the pin 1 indicator on the retaining clip is aligned with the pin 1 indicator on the processor before placing the retaining clip on the processor.

NOTE: Before you install the heat sink, ensure to place the processor and retaining clip in the tray.

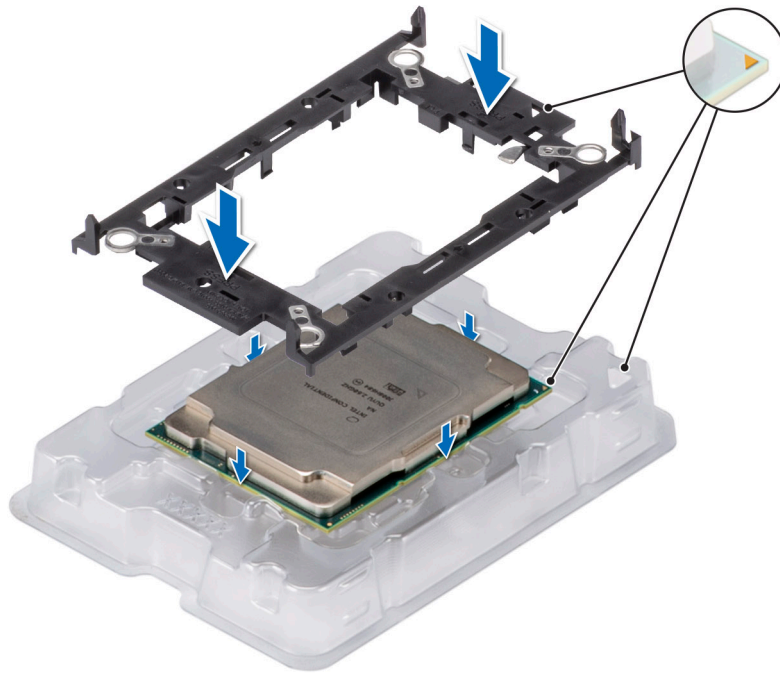

Figure 146. Installing the retaining clip

3. Align the processor with retaining clip, by using the fingers press the retaining clip on all the four sides until it clicks into place.

NOTE: Ensure the processor is securely latched to the retaining clip.

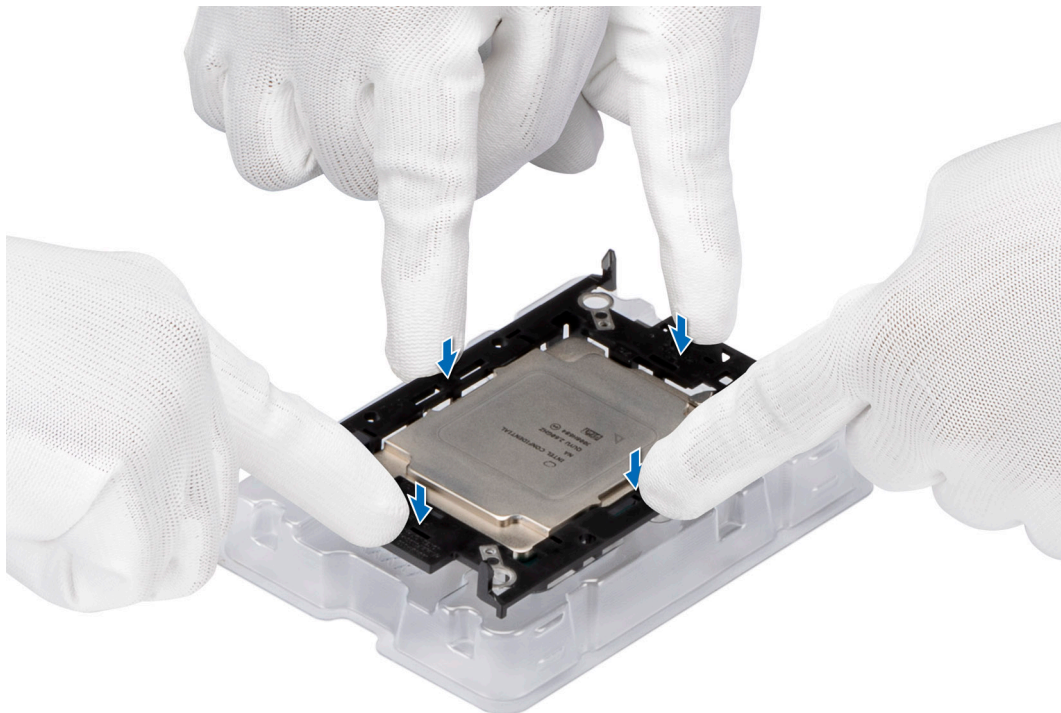

Figure 147. Press the retaining clip on the four sides

4. If you are using an existing heat sink, remove the thermal grease from the heat sink by using a clean lint-free cloth.
5. Use the thermal grease syringe included with your processor kit to apply the grease in a thin spiral design on the bottom of the heat sink.

CAUTION: Applying too much thermal grease can result in excess grease coming in contact with and contaminating the processor socket.

NOTE: The thermal grease syringe is intended for single use only. Dispose the syringe after you use it.

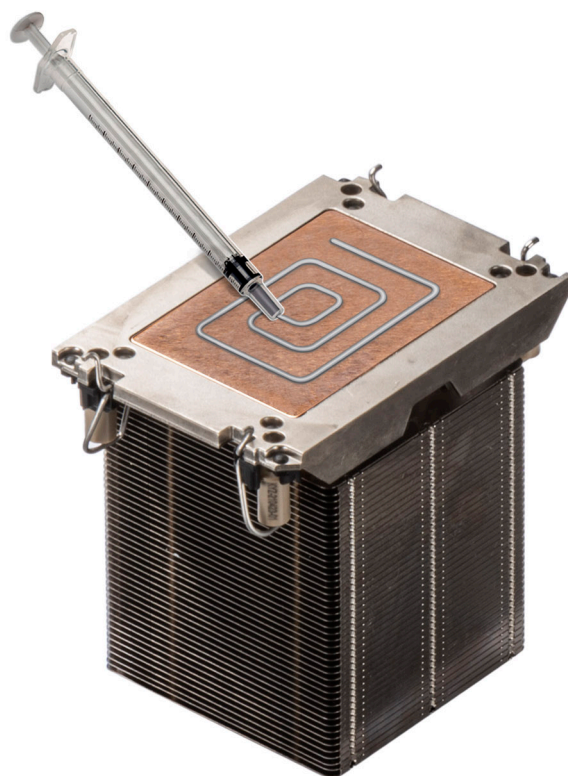

Figure 148. Applying thermal grease

6. For new heat sink, remove the Thermal Interface Material (TIM) protective film from the base of heat sink.



Figure 149. Removing the Thermal Interface Material (TIM) protective film

7. Place the heat sink on the processor and press the base of the heat sink until the retaining clip locks onto the heat sink at all the four corners.

CAUTION: To avoid damaging the fins on the heat sink, do not press down on the heat sink fins.

NOTE:

- Ensure latching features on retaining clip and heat sink are aligned during assembly.
- Ensure that the pin 1 indicator on the heat sink is aligned with the pin 1 indicator on the retaining clip before placing the heat sink onto the retaining clip.

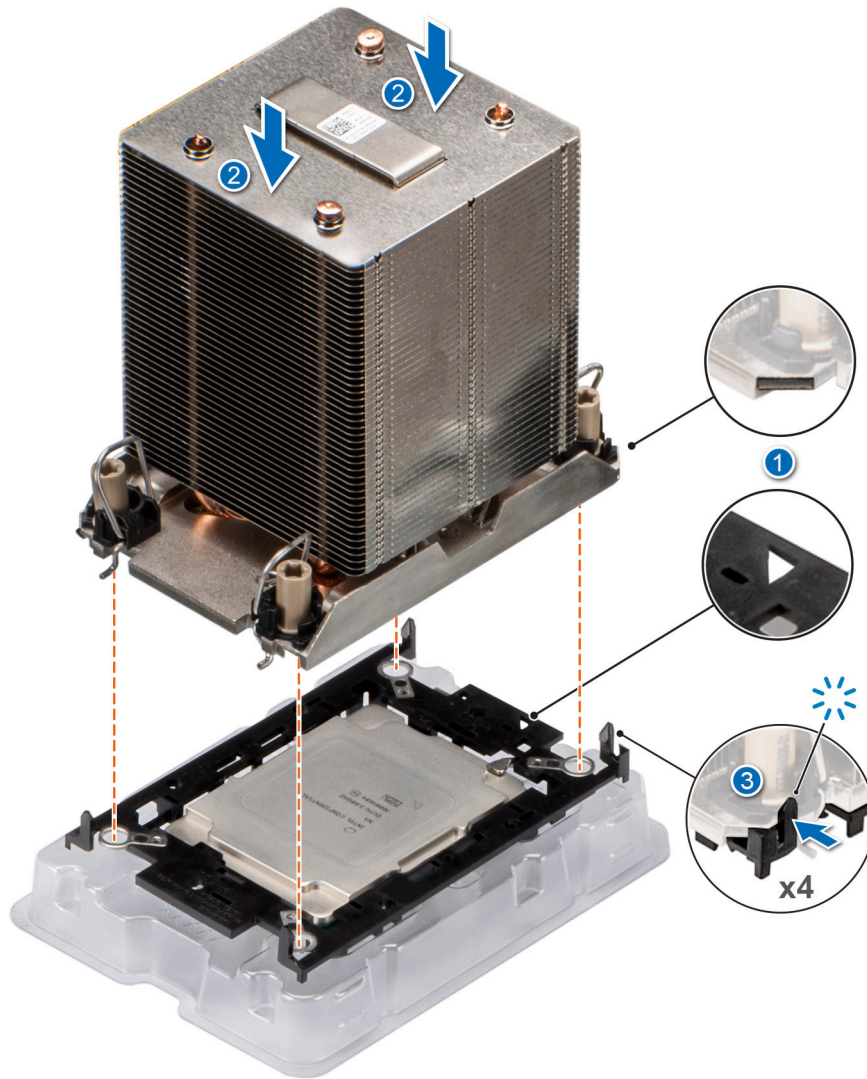

Figure 150. Installing the heat sink onto the processor

Next steps

1. [Install the processor heat sink module.](#)
2. [Install the air shroud.](#)
3. Follow the procedure listed in [After working inside your system.](#)

Installing the processor and heat sink module

Prerequisites

Never remove the heat sink from a processor unless you intend to replace the processor or system board. The heat sink is necessary to maintain proper thermal conditions.

1. Follow the safety guidelines listed in [Safety instructions.](#)
2. Follow the procedure that is listed in [Before working inside your system.](#)
3. [Remove the air shroud.](#)
4. If installed, remove the processor dust cover.

Steps

1. Set the anti-tilt wires to the unlocked position on the heat sink (inward position).

2. Align the pin 1 indicator of the heat sink to the system board, and then place the processor heat sink module (PHM) on the processor socket.

CAUTION: To avoid damaging the fins on the heat sink, do not press down on the heat sink fins.

NOTE: Ensure that the PHM is held parallel to the system board to prevent damaging the components.

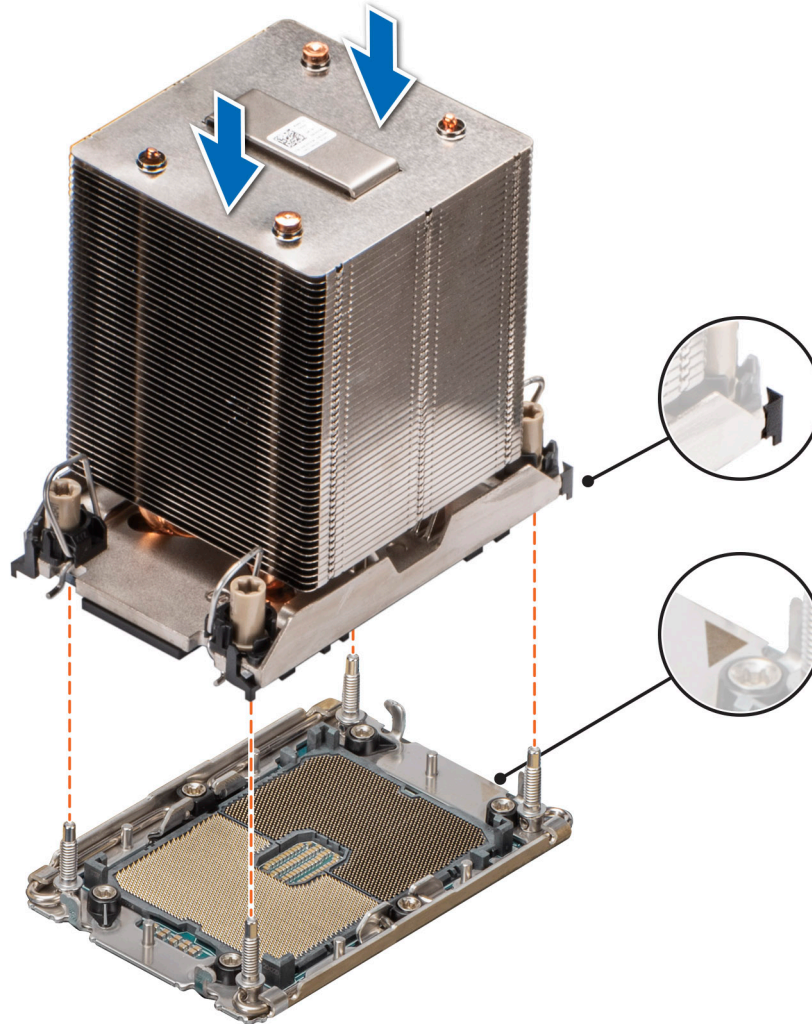

Figure 151. Installing the processor heat sink

3. Set the anti-tilt wires to the locked position (outward position), and then using the Torx T30 tool, tighten the nuts (12 in-lbf) on the PHM:
 - a. Tighten the first nut three turns.
 - b. Tighten the nut diagonally opposite to the nut you tighten first.
 - c. Repeat the procedure for the remaining two nuts.
 - d. Return to the first nut to tighten it completely.

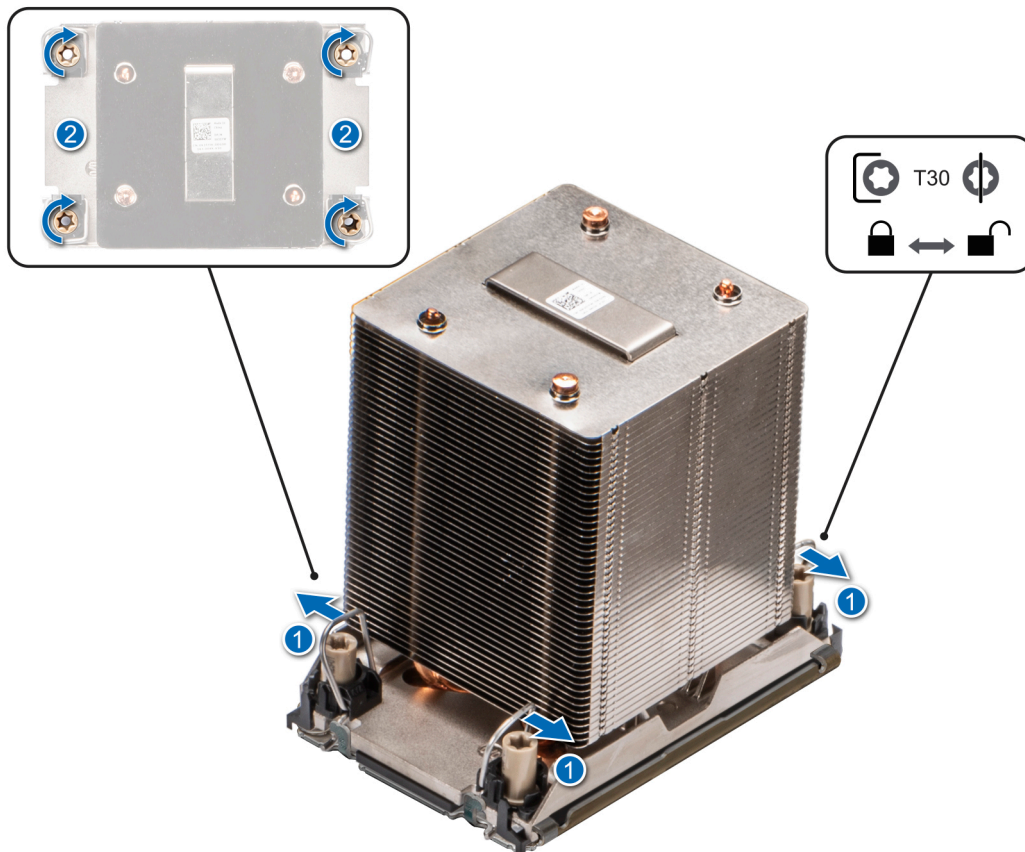

Figure 152. Set the anti-tilt wires to the locked position and tightening the nuts

Next steps

1. [Install the air shroud.](#)
2. Follow the procedure listed in [After working inside your system.](#)

Optional OCP card

Removing the OCP card

Prerequisites

1. Follow the safety guidelines listed in [Safety instructions.](#)
2. Follow the procedure that is listed in [Before working inside your system.](#)
3. [Remove the air shroud.](#)

Steps

1. Slide the OCP air shroud toward the front of the system and lift the OCP air shroud out of the system.



Figure 153. Removing the OCP air shroud

2. Open the blue latch to disengage the OCP card.
3. Push the OCP card towards the rear end of the system to disconnect from the connector on the system board.
4. Slide the OCP card out of the slot on the system.

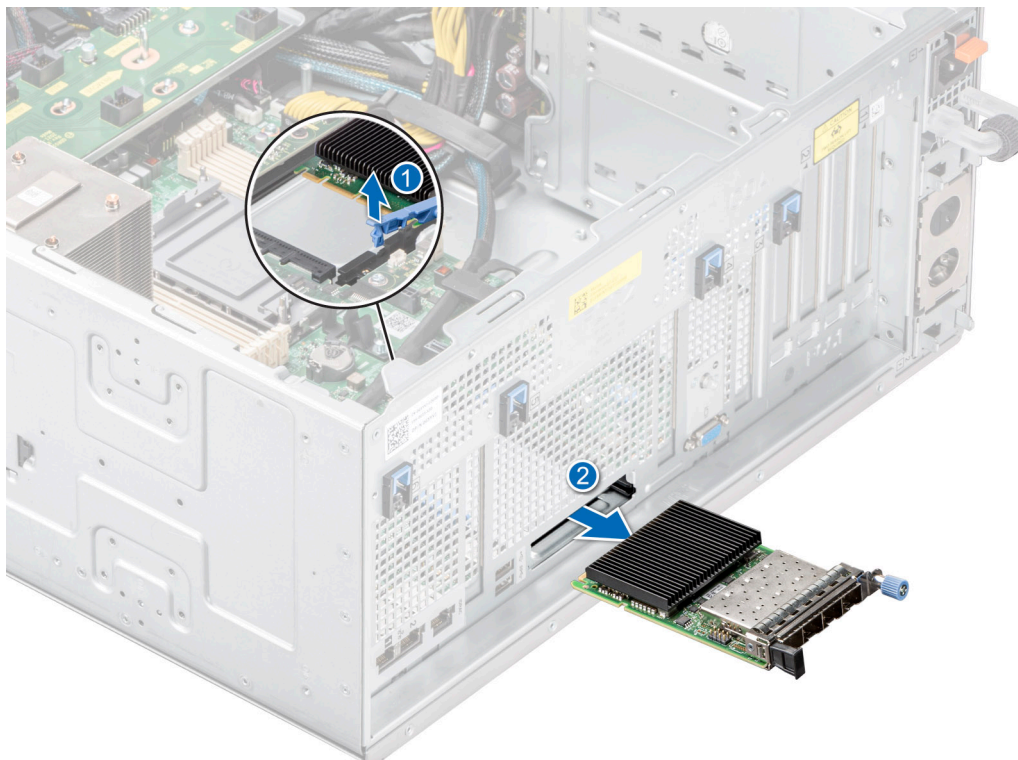

Figure 154. Removing the OCP card

5. If the OCP card is not going to be replaced, install a filler bracket .

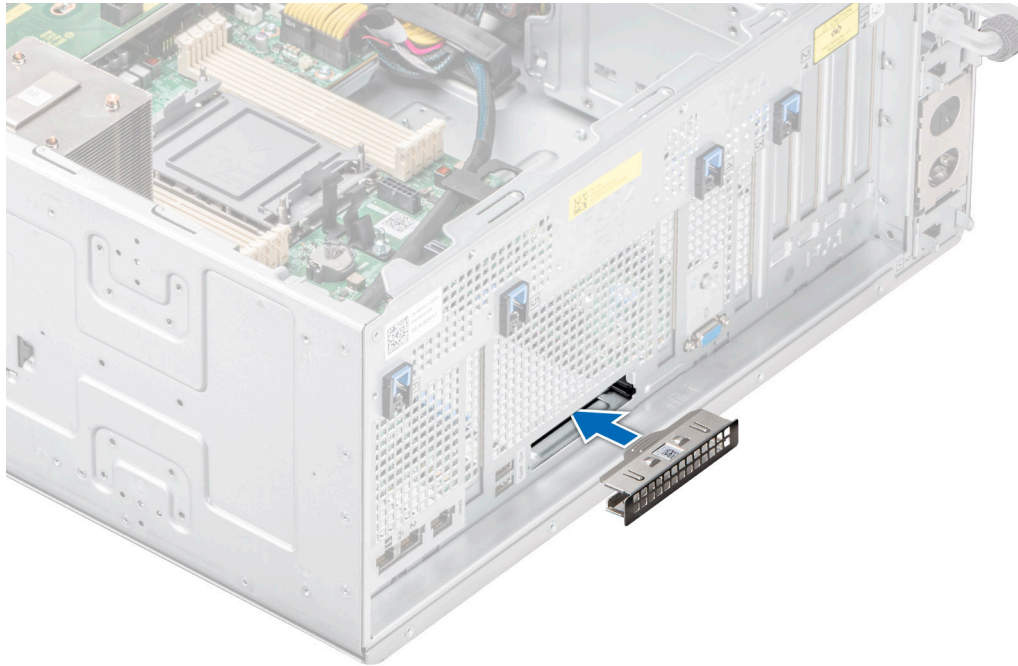

Figure 155. Installation of filler bracket

Next steps

Replace the OCP card.

Installing the OCP card

Prerequisites

1. Follow the safety guidelines listed in [Safety instructions](#).
2. Follow the procedure that is listed in [Before working inside your system](#).
3. [Remove the air shroud](#).

CAUTION: Do not install GPUs, network cards, or other PCIe devices on your system that are not validated and tested by Dell. Damage caused by unauthorized and invalidated hardware installation will null and void the system warranty.

Steps

1. If installed, remove the filler bracket.

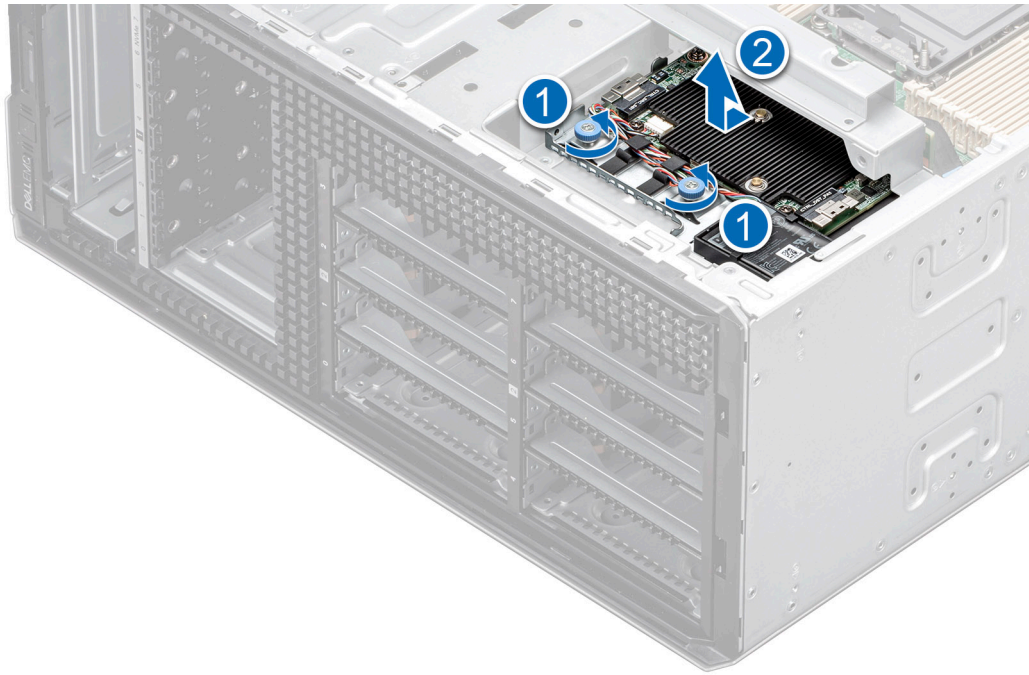

Figure 156. Removal of filler bracket

2. Open the blue latch on the system board.
3. Slide the OCP card into the slot in the system.
4. Push until the OCP card is connected to the connector on the system board.
5. Close the blue latch to lock the OCP card to the system.

NOTE: The numbers on the image do not depict the exact steps. The numbers are for representation of sequence.

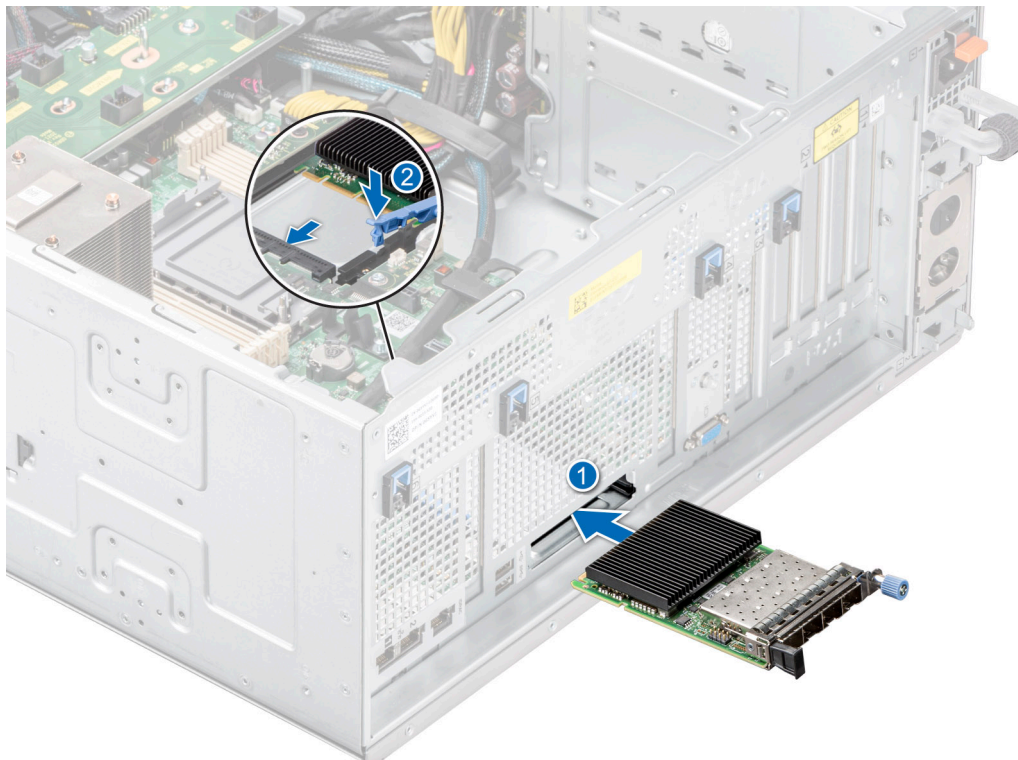

Figure 157. Installing the OCP card

6. Align the OCP air shroud to the guide pins on the chassis and lower the OCP air shroud.

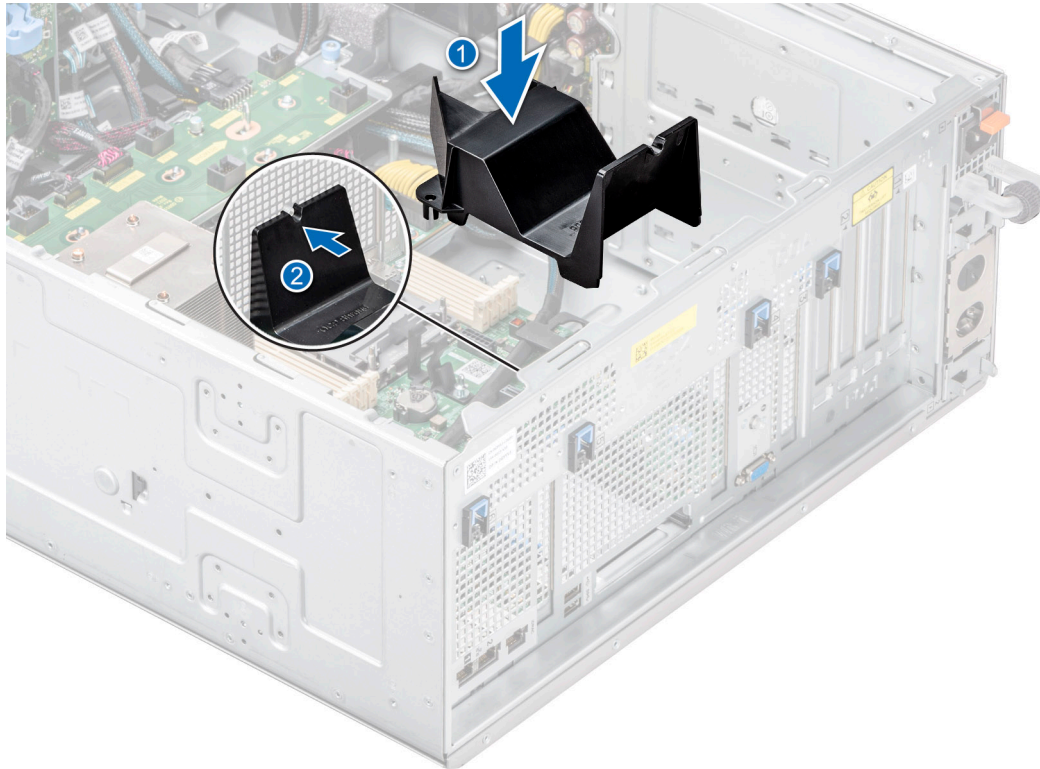

Figure 158. Installing the OCP air shroud.

Next steps

1. [Install the air shroud.](#)
2. Follow the procedure listed in [After working inside your system.](#)

Optional serial COM port

This is a service technician replaceable part only.

Removing the serial COM port

Prerequisites

1. Follow the safety guidelines listed in [Safety instructions.](#)
2. Follow the procedure that is listed in [Before working inside your system.](#)
3. [Remove the air shroud.](#)
4. Disconnect the cable connected to the serial COM port.

Steps

1. Open the blue latch and slide the serial COM port out of the system.

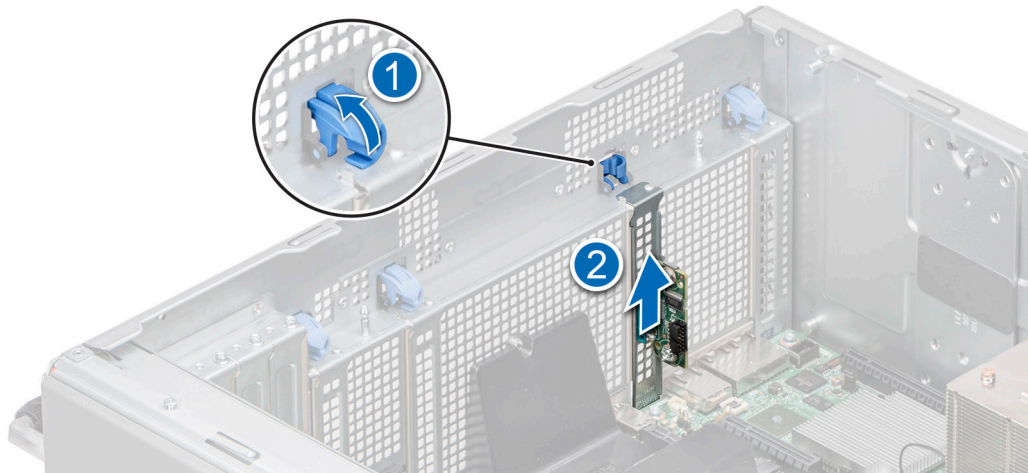

Figure 159. Removing the serial COM port

2. Install the filler bracket if not replacing the serial COM port.

Next steps

Replace the serial COM port.

Installing the serial COM port

Prerequisites

1. Follow the safety guidelines listed in [Safety instructions](#).
2. Follow the procedure that is listed in [Before working inside your system](#).
3. [Remove the air shroud](#).

Steps

1. Open the blue latch and remove the filler bracket from the system.
2. Slide the serial COM port and close the blue latch, until it snaps into place.

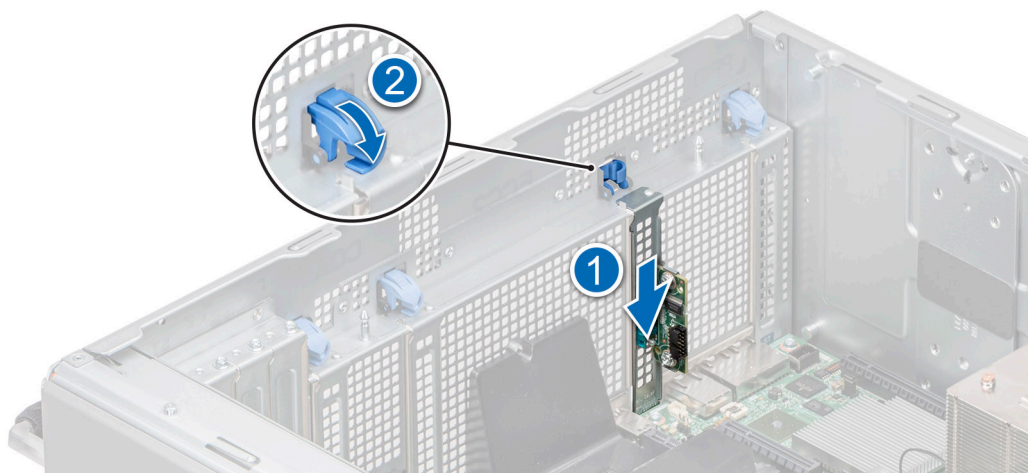

Figure 160. Installing the serial COM port

Next steps

1. Connect the cable to serial COM port.

2. Install the air shroud.
3. Follow the procedure listed in [After working inside your system](#).

System battery

This is a service technician replaceable part only.

Replacing the system battery

Prerequisites

⚠ WARNING: There is a danger of a new battery exploding if it is incorrectly installed. Replace the battery only with the same or equivalent type That is recommended by the manufacturer. Discard used batteries according to the manufacturer's instructions. See the Safety instructions. that came with your system for more information.

1. Follow the safety guidelines listed in [Safety instructions](#).
2. Follow the procedure that is listed in [Before working inside your system](#).
3. [Remove the air shroud](#).

Steps

1. To remove the battery:
 - a. Use a plastic scribe to pry out the system battery.

⚠ CAUTION: To avoid damage to the battery connector, you must firmly support the connector while installing or removing a battery.

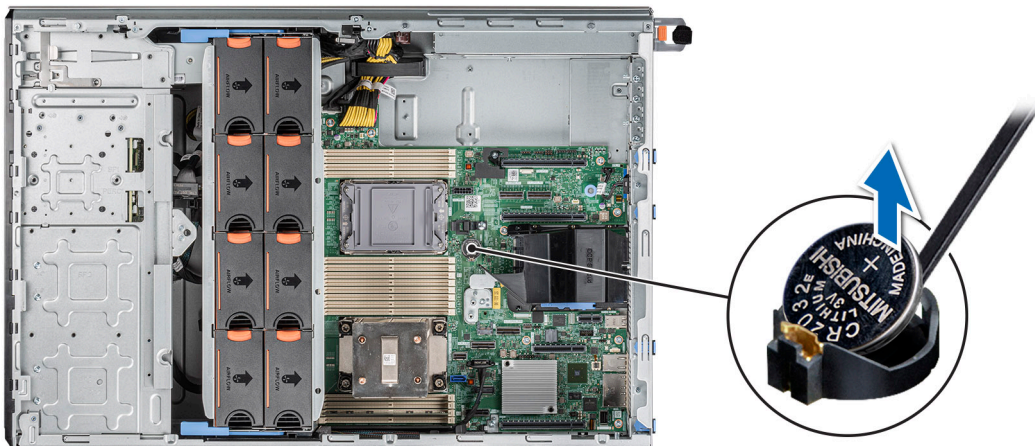

Figure 161. Removing the system battery

2. To install a new system battery:
 - a. Hold the battery with the positive side facing up and slide it under the securing tabs.
 - b. Press the battery into the connector until it snaps into place.

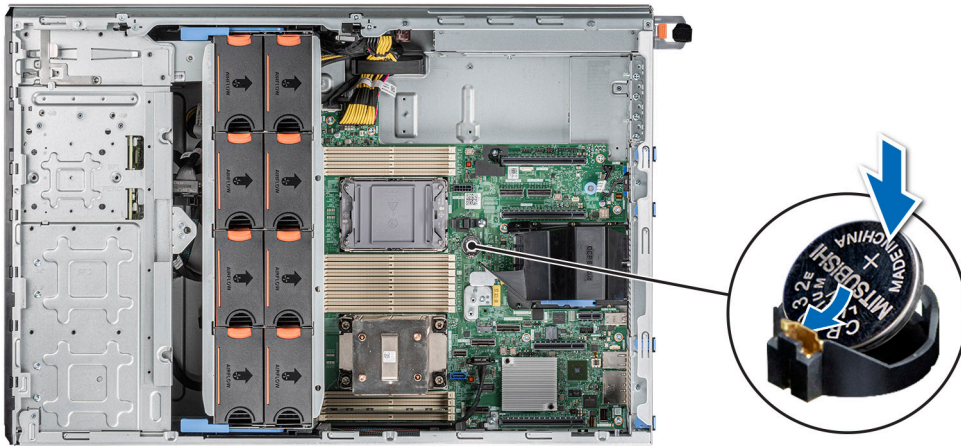

Figure 162. Installing the system battery

Next steps

1. [Install the air shroud.](#)
2. Follow the procedure listed in [After working inside your system.](#)
3. Confirm that the battery is operating properly, by performing the following steps:
 - a. Enter the System Setup, while booting, by pressing F2.
 - b. Enter the correct time and date in the System Setup **Time** and **Date** fields.
 - c. **Exit** the System Setup.
 - d. To test the newly installed battery, remove the system from the enclosure for at least an hour.
 - e. Reinstall the system into the enclosure after an hour.
 - f. Enter the System Setup and if the time and date are still incorrect, see [Getting help](#) section.

Intrusion switch module

This is a service technician replaceable part only.

Removing the intrusion switch module

Prerequisites

1. Follow the safety guidelines listed in [Safety instructions.](#)
2. Follow the procedure that is listed in [Before working inside your system.](#)
3. [Remove the air shroud.](#)

i **NOTE:** Ensure that you note the routing of the cables as you remove them from the system board. Route the cable properly when you replace it to prevent the cable from being pinched or crimped.

Steps

1. Disconnect the intrusion switch cable from the connector on the system board.
2. Using a Phillips 2 screwdriver, remove the screw securing the intrusion switch to the system.
3. Slide the intrusion switch module out of the slot on the system.

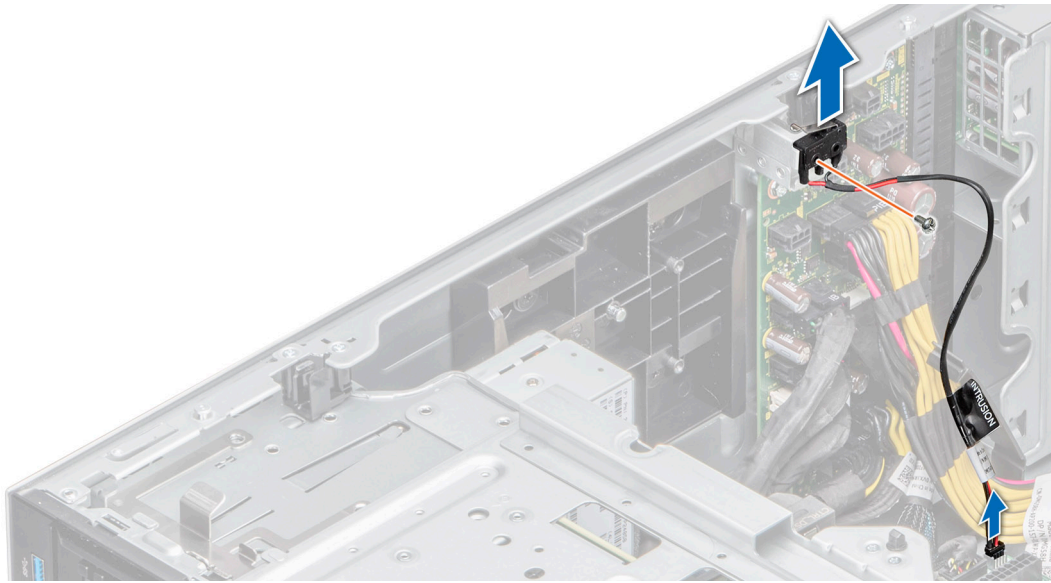

Figure 163. Removing the intrusion switch module

Next steps

Replace the intrusion switch module.

Installing the intrusion switch module

Prerequisites

1. Follow the safety guidelines listed in [Safety instructions](#).
2. Follow the procedure that is listed in [Before working inside your system](#).
3. [Remove the air shroud](#).

NOTE: Ensure that you note the routing of the cables as you remove them from the system board. Route the cable properly when you replace it to prevent the cable from being pinched or crimped.

Steps

1. Align the intrusion switch module with the slot on the system.
2. Slide the intrusion switch module into the slot in the system until firmly seated.
3. Using a Phillips 2 screwdriver, secure the intrusion switch to the system.
4. Connect the intrusion switch cable to the connector on the system board.

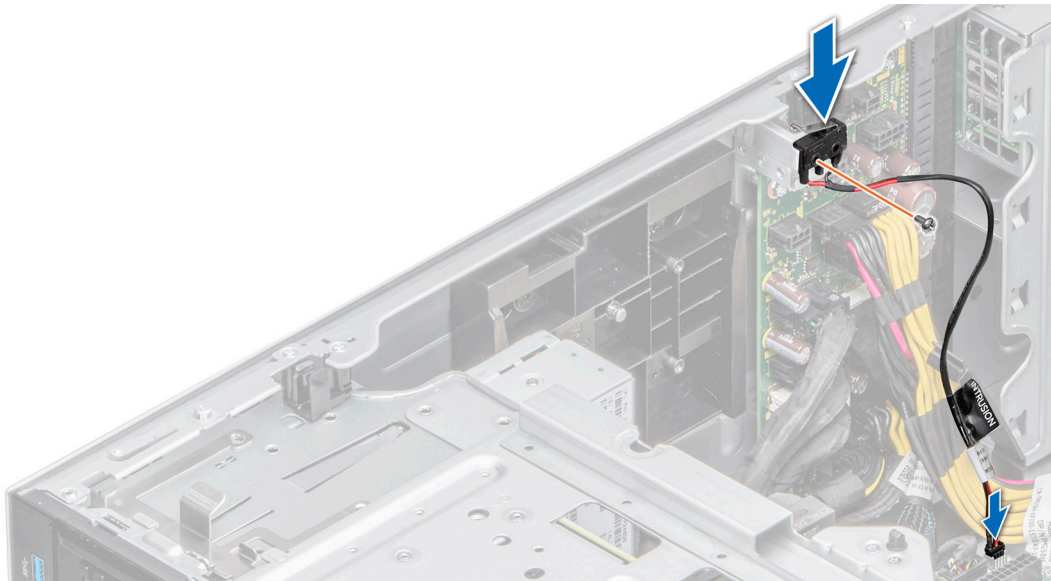

Figure 164. Installing the intrusion switch module

Next steps

1. [Install the air shroud.](#)
2. Follow the procedure listed in [After working inside your system.](#)

Power supply unit

i **NOTE:** While replacing the hot swappable PSU, after next server boot; the new PSU automatically updates to the same firmware and configuration of the replaced one. For updating to the latest firmware and changing the configuration, see the *Lifecycle Controller User's Guide* at <https://www.dell.com/idracmanuals>.

Hot spare feature

Your system supports the hot spare feature that significantly reduces the power overhead associated with the power supply unit (PSU) redundancy.

When the hot spare feature is enabled, one of the redundant PSUs is switched to the sleep state. The active PSU supports 100 percent of the system load, thus operating at higher efficiency. The PSU in the sleep state monitors output voltage of the active PSU. If the output voltage of the active PSU drops, the PSU in the sleep state returns to an active output state.

If having both PSUs active is more efficient than having one PSU in the sleep state, the active PSU can also activate the sleeping PSU.

The default PSU settings are as follows:

- If the load on the active PSU is more than 50 percent of PSU rated power wattage, then the redundant PSU is switched to the active state.
- If the load on the active PSU falls below 20 percent of PSU rated power wattage, then the redundant PSU is switched to the sleep state.

You can configure the hot spare feature by using the iDRAC settings. For more information, see the *iDRAC User's Guide* available at www.dell.com/poweredgemanuals.

Removing a power supply unit blank

Prerequisites

Follow the safety guidelines listed in the [Safety instructions](#).

Steps

Pull the blank out of the system.

CAUTION: To ensure proper system cooling, the PSU blank must be installed in the second PSU bay in a non-redundant configuration. Remove the PSU blank only if you are installing a second PSU.

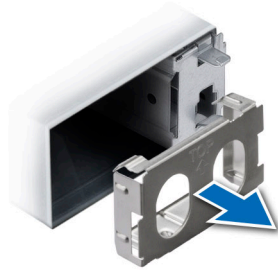

Figure 165. Removing a 60 mm power supply unit blank

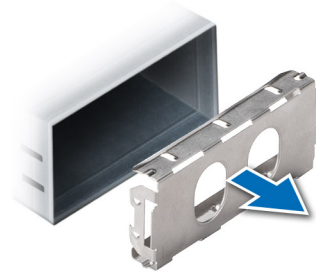

Figure 166. Removing a 86 mm power supply unit blank

Next steps

Replace the PSU blank or install the PSU.

Installing a power supply unit blank

Prerequisites

1. Follow the safety guidelines listed in the [Safety instructions](#).
NOTE: Install the power supply unit (PSU) blank only in the second PSU bay.
2. If required, [remove the PSU](#).

Steps

Align the PSU blank with the PSU bay and push it into the PSU bay until it clicks into place.

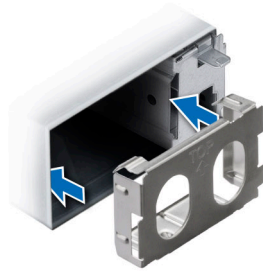

Figure 167. Installing a 60 mm power supply unit blank

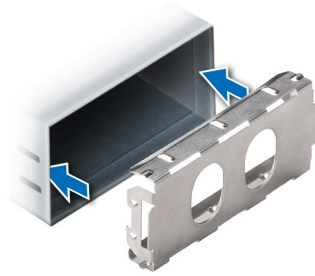

Figure 168. Installing a 86 mm power supply unit blank

Removing a power supply unit adapter

Remove the PSU adapter, when installing PSU with 86 mm wide form factor.

Prerequisites

Follow the safety guidelines listed in the [Safety instructions](#).

Steps

Press release latch and remove the power supply unit adapter.

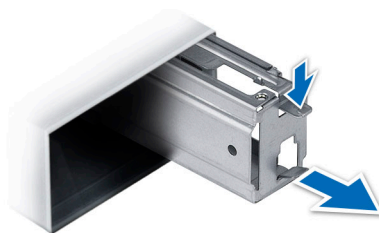

Figure 169. Removing a power supply unit adapter

Next steps

Replace the PSU adapter or install an 86 mm PSU.

Installing a power supply unit adapter

Prerequisites

1. Follow the safety guidelines listed in the [Safety instructions](#).
2. If required, [remove the PSU](#).

NOTE: Remove the PSU adapter, when installing PSU with 86 mm wide form factor.

Steps

Align and insert the power supply unit adapter, until the adapter clicks into place.

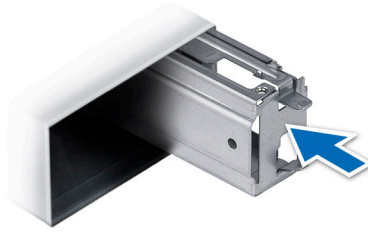

Figure 170. Installing a power supply unit adapter

Removing a AC power supply unit

Prerequisites

CAUTION: The system needs one power supply unit (PSU) for normal operation. On power-redundant systems, remove and replace only one PSU at a time in a system that is powered on.

1. Follow the safety guidelines listed in [Safety instructions](#).
2. Disconnect the power cable from the power source and from the PSU you intend to remove, and then remove the cable from the strap on the PSU handle.

Steps

Press the orange release latch and slide the PSU out of the system by using the PSU handle.



Figure 171. Removing a 60 mm power supply unit

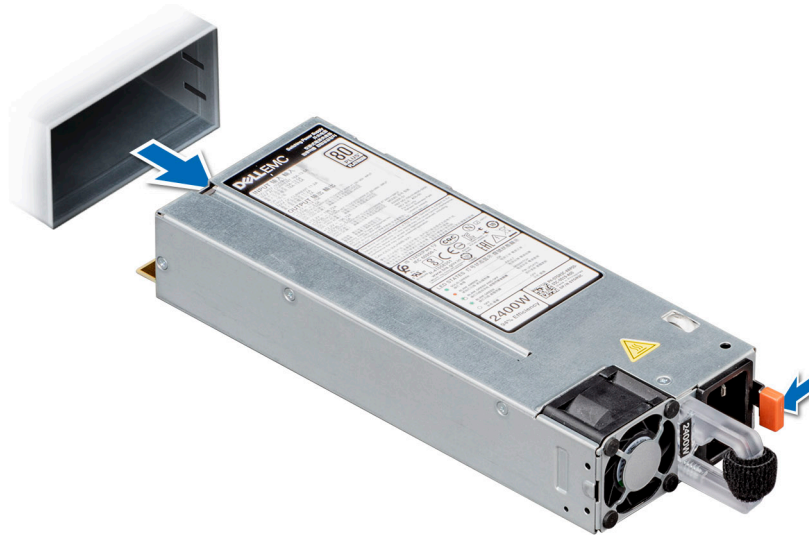

Figure 172. Removing a 86 mm power supply unit

Next steps

Install the PSU.

Installing a AC power supply unit

Prerequisites

1. Follow the safety guidelines listed in [Safety instructions](#).
2. For systems that support redundant PSU, ensure that both the PSUs are of the same type and have the same maximum output power.

i **NOTE:** The maximum output power (shown in watts) is listed on the PSU label.

Steps

Slide the PSU into the system until the PSU is fully seated and the release latch snaps into place.

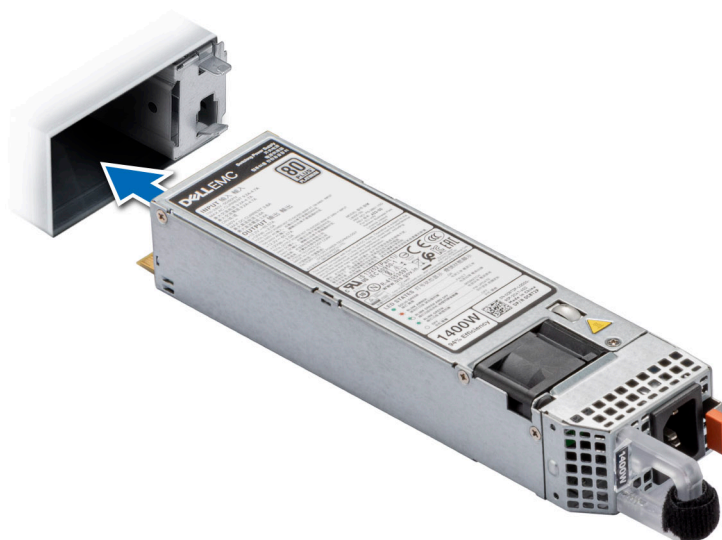

Figure 173. Installing a 60 mm power supply unit

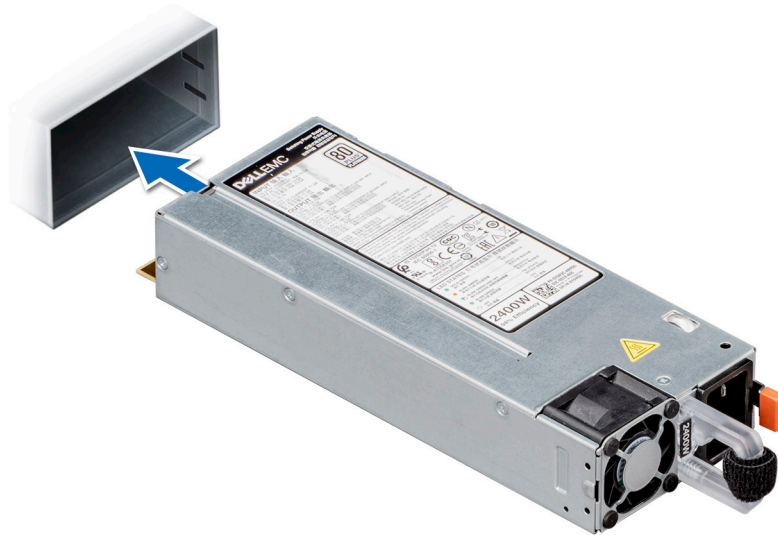

Figure 174. Installing a 86 mm power supply unit

Next steps

1. Connect the power cable to the PSU, and plug the cable into a power outlet.

CAUTION: When connecting the power cable to the PSU, secure the cable to the PSU with the strap.

NOTE: When installing, hot swapping, or hot adding a new PSU, wait for 15 seconds for the system to recognize the PSU and determine its status. The PSU redundancy may not occur until discovery is complete. Wait until the new PSU is discovered and enabled before you remove the other PSU. The PSU status indicator turns green to signify that the PSU is functioning properly.

Power interposer board

This is a service technician replaceable part only.

PIB board view

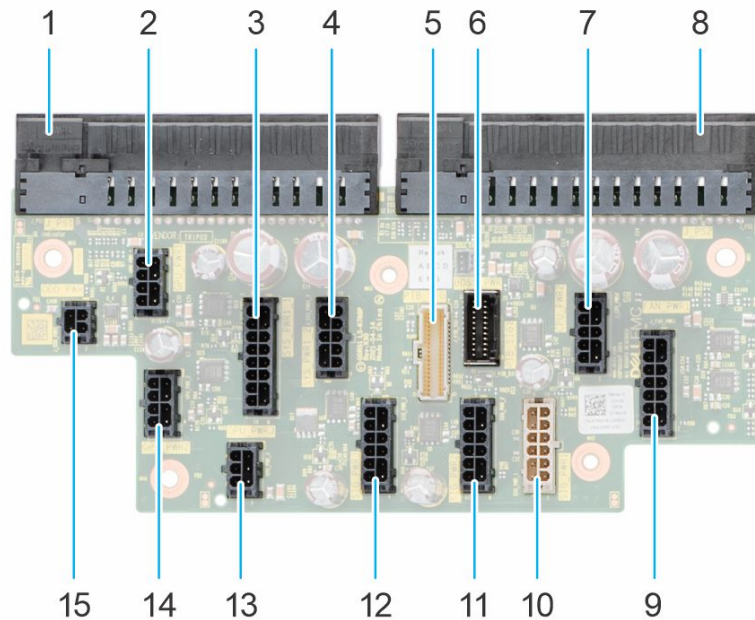

Figure 175. PIB connectors

- | | |
|---------------|---------------|
| 1. J_PS1 | 2. GPU_PWR1 |
| 3. SYS_PWR1_1 | 4. SYS_PWR1_2 |
| 5. PIB_SIG | 6. PIB_SIG1 |
| 7. CPU_PWR2 | 8. J_PS2 |
| 9. FAN_PWR1 | 10. SIG_PWR_1 |
| 11. SIG_PWR_2 | 12. SIG_PWR_3 |
| 13. GPU_PWR_3 | 14. GPU_PWR_2 |
| 15. ODD_PWR | |

Removing the power interposer board

Prerequisites

1. Follow the safety guidelines listed in [Safety instructions](#).
2. Follow the procedure that is listed in [Before working inside your system](#).
3. [Remove the air shroud](#).
4. [Remove the PSU](#).

Steps

1. Disconnect all the power cables from the PIB.
2. Using the Phillips 2 screwdriver, remove the screws that secure the PIB to the system.
3. Lift the PIB out of the system.

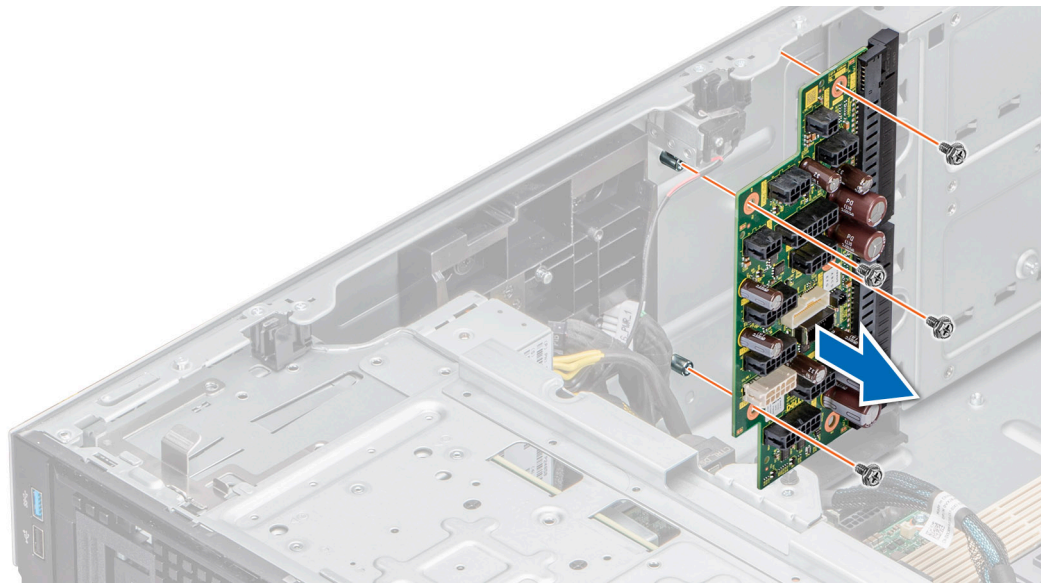

Figure 176. Removing the PIB

Next steps

Replace the power interposer board.

Installing the power interposer board

Prerequisites

1. Follow the safety guidelines listed in [Safety instructions](#).
2. Follow the procedure that is listed in [Before working inside your system](#).
3. [Remove the air shroud](#).
4. [Remove the PSU](#).

Steps

1. Align the screw holes on the power interposer board (PIB) with the holes on the system.
2. Using the Phillips 2 screwdriver, secure the PIB to the system using the screws.
3. Connect all the disconnected power cables to the PIB.

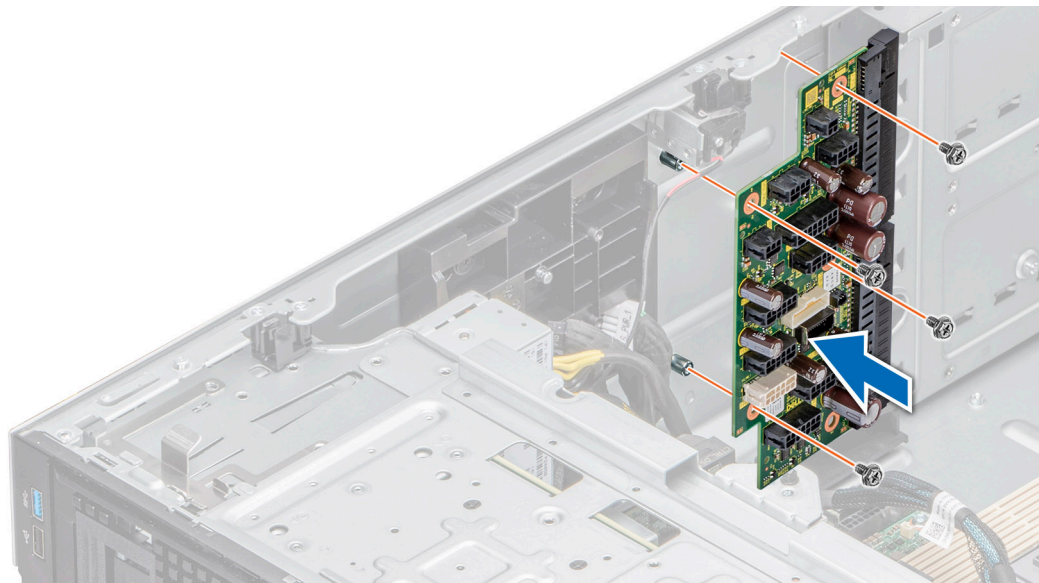

Figure 177. Installing the power interposer board

Next steps

1. [Install the PSUs.](#)
2. [Install the air shroud.](#)
3. Follow the procedure listed in [After working inside your system.](#)

System board

This is a service technician replaceable part only.

Removing the system board

Prerequisites

CAUTION: If you are using the Trusted Platform Module (TPM) with an encryption key, you may be prompted to create a recovery key during program or System Setup. Be sure to create and safely store this recovery key. If you replace this system board, you must supply the recovery key when you restart your system or program before you can access the encrypted data on your hard drives.

CAUTION: Do not attempt to remove the TPM plug-in module from the system board. Once the TPM plug-in module is installed, it is cryptographically bound to that specific system board. Any attempt to remove an installed TPM plug-in module breaks the cryptographic binding, and it cannot be reinstalled or installed on another system board.

1. Follow the safety guidelines listed in [Safety instructions.](#)
2. Follow the procedure that is listed in [Before working inside your system.](#)
3. Remove the following:
 - a. [Air shroud](#)
 - b. [Cooling fan cage](#)
 - c. [Expansion cards](#), if installed
 - d. [GPU card](#), if installed
 - e. [GPU card holder](#), if installed
 - f. [IDSDM module](#), if installed
 - g. [Internal USB module](#), if installed
 - h. [OCP card](#), if installed

- i. [Memory modules](#)
- j. [Processors and heat sink modules](#)
- k. [Trusted Platform Module \(TPM\)](#)

CAUTION: To prevent damage to the processor pins when replacing a faulty system board, ensure that you cover the processor socket with the processor protective cap.

Steps

1. Disconnect all cables from the system board.

CAUTION: Take care not to damage the system identification button while removing the system board from the chassis.

CAUTION: Do not lift the system board by holding a memory module, processor, or other components.

2. Using the system board holder and plunger, slide the system board towards the front of the system.
3. Lift the system board out of the chassis.

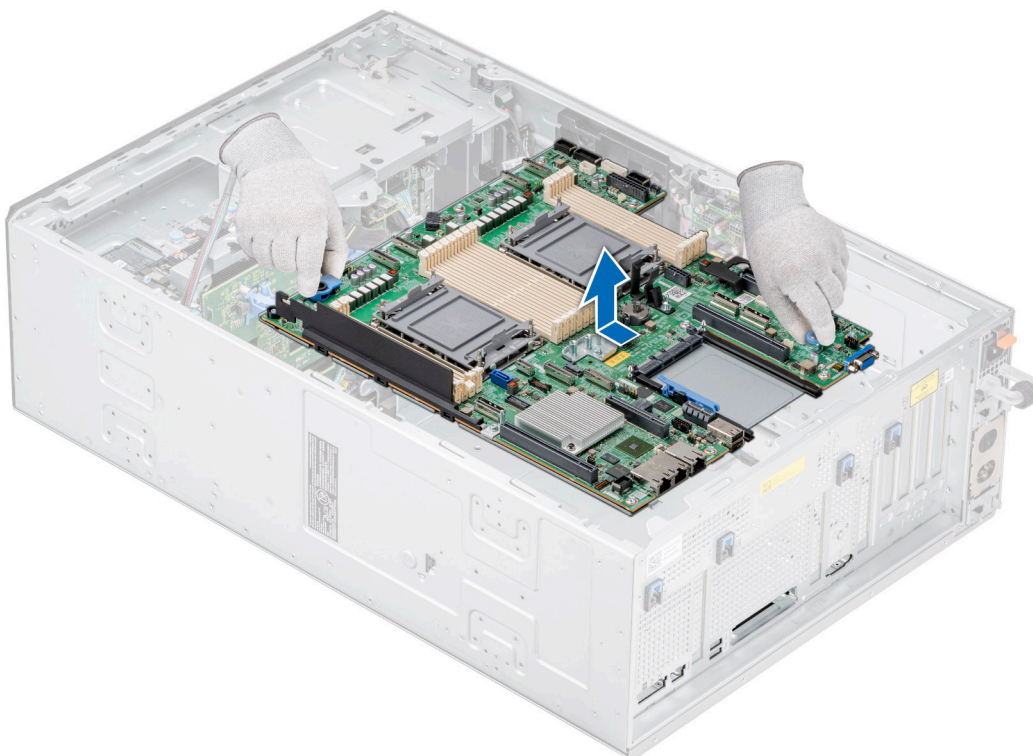

Figure 178. Removing the system board

Next steps

Install the system board.

Installing the system board

Prerequisites

NOTE: Before replacing the system board, replace the old iDRAC MAC address label in the Information tag with the iDRAC MAC address label of the replacement system board.

1. Follow the safety guidelines listed in [Safety instructions](#).
2. Follow the procedure that is listed in [Before working inside your system](#).
3. If you are replacing the system board, remove all the components that are listed in the removing the system board section.

Steps

1. Unpack the new system board assembly.

CAUTION: Do not lift the system board by holding a memory module, processor, or other components.

CAUTION: Take care not to damage the system identification button while placing the system board into the chassis.

2. Holding the system board holder and plunger, lower the system board into the system.
3. Slide the system board towards the rear of the chassis until the connectors are firmly seated in the slots.

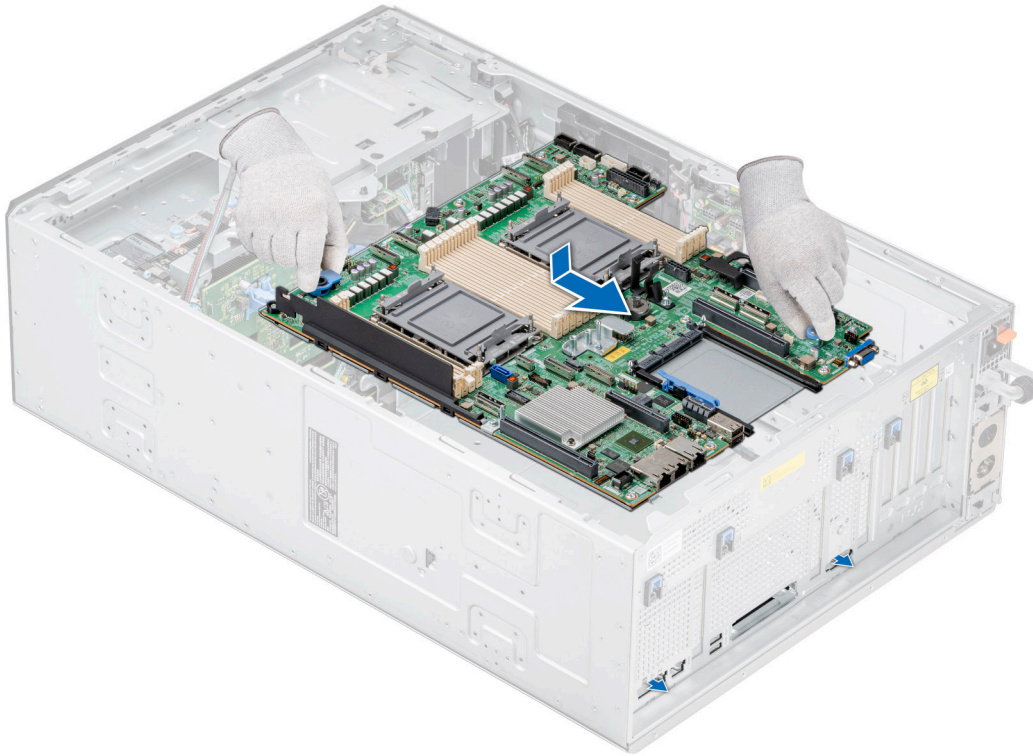

Figure 179. Installing the system board

Next steps

1. Replace the following components:
 - a. [Trusted Platform Module \(TPM\)](#)
 - b. [Processors and heat sink modules](#)
 - c. [Memory modules](#)
 - d. [OCP card](#), if removed
 - e. [Internal USB module](#), if removed
 - f. [IDSDM module](#), if removed
 - g. [GPU card holder](#), if removed
 - h. [GPU card](#), if removed
 - i. [Expansion cards](#), if removed
 - j. [Cooling fan cage](#)
 - k. [Air shroud](#)
2. Reconnect all cables to the system board.

NOTE: Ensure that the cables inside the system are routed along the chassis wall and secured using the cable securing bracket.
3. Ensure that you perform the following steps:
 - a. Use the Easy Restore feature to restore the Service Tag. See the [Restoring the system by using the Easy Restore feature](#) section.

- b. If the service tag is not backed up in the backup flash device, enter the system service tag manually. See the [Manually update the Service Tag by using System Setup](#) section.
- c. Update the BIOS and iDRAC versions.

Reenable the Trusted Platform Module (TPM). See the [Upgrading the Trusted Platform Module](#) section.

4. If you are not using Easy restore, import your new or existing iDRAC Enterprise license. For more information, see the *Integrated Dell Remote Access Controller User's Guide* available at <https://www.dell.com/idracmanuals>.
5. Follow the procedure listed in [After working inside your system](#).

Restoring Service Tag using Easy Restore

The Easy Restore feature allows you to restore your Service Tag, iDRAC license, UEFI configuration, and the system configuration data after replacing the system board. All data is backed up in a backup Flash drive device automatically. If BIOS detects a new system board, and the Service Tag in the backup Flash drive device is different, BIOS prompts the user to restore the backup information.

About this task

Below is a list of options available:

1. Restore the Service Tag, license, and diagnostics information, press **Y**.
2. Go to the Lifecycle Controller based restore options, press **N**.
3. Restore data from a previously created **Hardware Server Profile**, press **F10**.

 **NOTE:** When the restore process is complete, BIOS prompts to restore the system configuration data.

4. To restore the system configuration data, press **Y**
5. To use the default configuration settings, press **N**

 **NOTE:** After the restore process is complete, system reboots.

 **NOTE:** If restoring the Service Tag is successful, you can check the Service Tag information in the **System Information** screen and compare it with the Service Tag on the system.

Manually updating Service Tag

After replacing a system board, if Easy Restore fails, follow this process to manually enter the Service Tag, using **System Setup**.

About this task

If you know the system Service Tag, use the **System Setup** menu to enter the Service Tag.

Steps

1. Turn on the system.
2. To enter the **System Setup**, press **F2**.
3. Click **Service Tag Settings**.
4. Enter the Service Tag.

 **NOTE:** You can enter the Service Tag only when the **Service Tag** field is empty. Ensure that you enter the correct Service Tag. After the Service Tag is entered, it cannot be updated or changed.

5. Click **OK**.

Trusted Platform Module

This is a service technician replaceable part only.

Upgrading the Trusted Platform Module

Removing the TPM

Prerequisites

NOTE:

- Ensure the operating system is compatible with the TPM version you are installing.
- Ensure that you download and install the latest BIOS firmware on your system.
- Ensure that the BIOS is configured to enable UEFI boot mode.

 **CAUTION:** The TPM plug-in module is cryptographically bound to that particular system board after it is installed. When the system is powered on, any attempt to remove an installed TPM plug-in module breaks the cryptographic binding, and the removed TPM cannot be installed on another system board. Ensure any keys you have stored on the TPM have been securely transferred.

Steps

1. Locate the TPM connector on the system board. For more information, see [System board connectors](#).
2. Press to hold the module down and remove the screw using the security Torx 8-bit shipped with the TPM module.
3. Slide the TPM module out from its connector.
4. Push the plastic rivet away from the TPM connector and rotate it 90° counterclockwise to release it from the system board.
5. Pull the plastic rivet out of its slot on the system board.

Installing the TPM

Steps

1. To install the TPM, align the edge connectors on the TPM with the slot on the TPM connector.
2. Insert the TPM into the TPM connector such that the plastic rivet aligns with the slot on the system board.
3. Press the plastic rivet until the rivet snaps into place.
4. Replace the screw that secures the TPM to the system board.

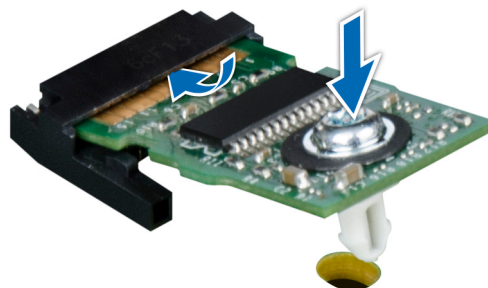

Figure 180. Installing the TPM

Initializing TPM for users

Steps

1. Initialize the TPM.
For more information, see [Initializing the TPM for users](#).
2. The **TPM Status** changes to **Enabled, Activated**.

Initializing the TPM 1.2 for users

Steps

1. While booting your system, press F2 to enter System Setup.
2. On the **System Setup Main Menu** screen, click **System BIOS > System Security Settings**.
3. From the **TPM Security** option, select **On with Preboot Measurements**.
4. From the **TPM Command** option, select **Activate**.
5. Save the settings.
6. Restart your system.

Initializing the TPM 2.0 for users

Steps

1. While booting your system, press F2 to enter System Setup.
2. On the **System Setup Main Menu** screen, click **System BIOS > System Security Settings**.
3. From the **TPM Security** option, select **On**.
4. Save the settings.
5. Restart your system.

Jumpers and connectors

This section provides essential and specific information about jumpers and switches. It also describes the connectors on the various boards in the system. Jumpers on the system board help to disable the system and reset the passwords. To install components and cables correctly, you must be able to identify the connectors on the system board.

Topics:

- System board connectors
- System board jumper settings
- Disabling a forgotten password

System board connectors

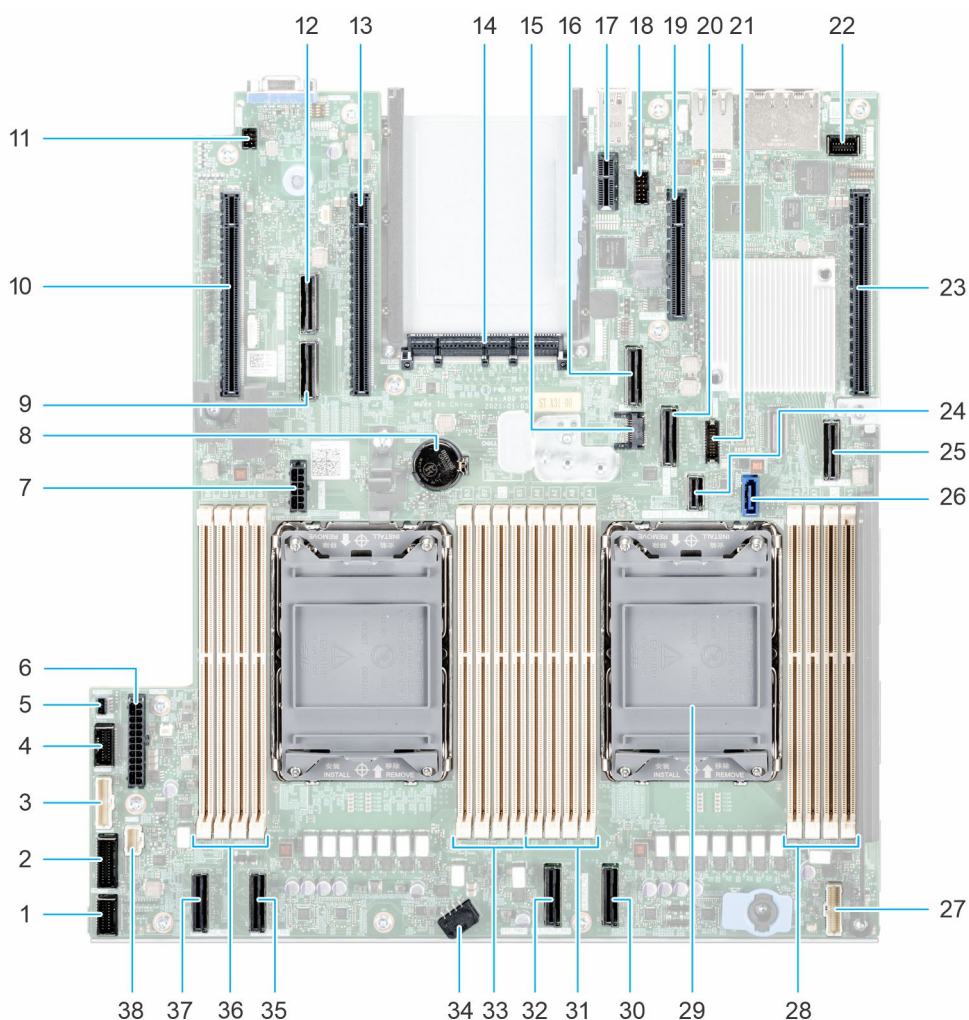

Figure 181. System board jumpers and connectors

Table 45. System board jumpers and connectors

Item	Connector	Description
1.	FAN_SIG1	Fan Signal 1
2.	FAN_SIG2	Fan Signal 2
3.	PIB_SIG1	PIB Signal 1
4.	PIB_SIG2	PIB Signal 2
5.	INTRUSION	Intrusion Switch Connector
6.	SYS_PWR1	System Power Connector 1
7.	SIG_PWR_0	Power connector for cable riser
8.	Coin cell battery	Coin cell battery
9.	SL6_CPU2_PB3	PCIe cable connector 6 (Processor 2)
10.	x16 (CPU2)	x16 PCIe slot 3 (Processor 2)
11.	SYS_ID	System ID Connector
12.	SL5_CPU2_PA3	PCIe cable connector 5 (Processor 2)
13.	x16 (CPU2)	x16 PCIe slot 4 (Processor 2)
14.	OCP 3.0 x16	OCP NIC 3.0 Connector
15.	J_TPM	TPM Connector
16.	SL7_CPU1_PA4	PCIe cable connector 7 (Processor 1)
17.	IDSDM/Internal USB connector	IDSDM/Internal USB connector
18.	REAR_SERIAL	Serial Port Connector
19.	x4 (PCH)	x4 PCIe slot 5 (PCH)
20.	SL8_CPU1_PB4	PCIe cable connector 8 (Processor 1)
21.	FRONT_USB	Front USB
22.	FRONT_VIDEO	Front VGA
23.	x16 (CPU1)	x16 PCIe slot 6 (Processor 1)
24.	SL10_PCH_PA5	BOSS signal connector (PCH)
25.	SL9_PCH_SA1	SATA Connector S9 (PCH)
26.	ODD	Optical disk drive connector
27.	RGT_CP	Right Control Panel
28.	A3, A7, A1, A5	DIMMs for processor 1 Channels A, B, C, D
29.	CPU 1	Processor 1
30.	SL4_CPU1_PA2	PCIe cable connector 4 (Processor 1)
31.	A6, A2, A8, A4	DIMMs for processor 1 Channels A, B, C, D
32.	SL3_CPU1_PB2	PCIe cable connector 3 (Processor 1)
33.	B3, B7, B1, B5	DIMMs for processor 2 Channels E, F, G, H
34.	SYS_PWR2	System Power Connector 2
35.	SL2_CPU2_PA1	PCIe cable connector 2 (Processor 2)





Table 45. System board jumpers and connectors (continued)

Item	Connector	Description
36.	B6, B2, B8, B4	DIMMs for processor 2 Channels E, F, G, H
37.	SL1_CPU2_PB1	PCIe cable connector 1(Processor 2)
38.	LFT_CP	Left Control Panel

System board jumper settings

For information about resetting the password jumper to disable a password, see the [Disabling a forgotten password](#) section.

Table 46. System board jumper settings

Jumper	Setting	Description
PWRD_EN	 2 4 6 (default)	The BIOS password feature is enabled.
	 2 4 6	The BIOS password feature is disabled. The BIOS password is now disabled and you are not allowed to set a new password.
NVRAM_CLR	 1 3 5 (default)	The BIOS configuration settings are retained at system boot.
	 1 3 5	The BIOS configuration settings are cleared at system boot.

CAUTION: You should be cautious when changing the BIOS settings. The BIOS interface is designed for advanced users. Any changes in the setting might prevent your system from starting correctly and may even result in data loss.

Disabling a forgotten password

The software security features of the system include a system password and a setup password. The password jumper enables or disables password features and clears any password(s) currently in use.

Prerequisites

CAUTION: Many repairs may only be done by a certified service technician. You should only perform troubleshooting and simple repairs as authorized in your product documentation, or as directed by the online or telephone service and support team. Damage due to servicing that is not authorized by Dell is not covered by your warranty. Read and follow the safety instructions that are shipped with your product.

Steps

- Power off the system and all attached peripherals. Disconnect the system from the electrical outlet, and disconnect the peripherals.
- Remove the system cover.
- Move the jumper on the system board from pins 2 and 4 to pins 4 and 6.
- Replace the system cover.
 - NOTE:** The existing passwords are not disabled (erased) until the system boots with the jumper on pins 4 and 6. However, before you assign a new system and/or setup password, you must move the jumper back to pins 2 and 4.
 - NOTE:** If you assign a new system and/or setup password with the jumper on pins 4 and 6, the system disables the new password(s) the next time it boots.
- Reconnect the peripherals and connect the system to the electrical outlet, and then power on the system.

6. Power off the system.
7. Remove the system cover.
8. Move the jumper on the system board from pins 4 and 6 to pins 2 and 4.
9. Replace the system cover.
10. Reconnect the peripherals and connect the system to the electrical outlet, and then power on the system.
11. Assign a new system and/or setup password.

System diagnostics and indicator codes

This section describes the diagnostic indicators on the system front panel that displays the system status during system startup.

Topics:

- Status LED indicators
- System health and system ID indicator codes
- iDRAC Quick Sync 2 indicator codes
- iDRAC Direct LED indicator codes
- NIC indicator codes
- Power supply unit indicator codes
- Drive indicator codes
- Using system diagnostics

Status LED indicators

 **NOTE:** The indicators display solid amber if any error occurs.

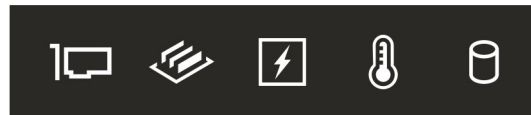

Figure 182. Status LED indicators

Table 47. Status LED indicators and descriptions





Icon	Description	Condition	Corrective action
	Drive indicator	The indicator turns solid amber if there is a drive error.	<ul style="list-style-type: none"> • Check the System Event Log to determine if the drive has an error. • Run the appropriate Online Diagnostics test. Restart the system and run embedded diagnostics (ePSA). • If the drives are configured in a RAID array, restart the system, and enter the host adapter configuration utility program.
	Temperature indicator	The indicator turns solid amber if the system experiences a thermal error (for example, the ambient temperature is out of range or there is a fan failure).	<p>Ensure that none of the following conditions exist:</p> <ul style="list-style-type: none"> • A cooling fan has been removed or has failed. • System cover, air shrouds, or back filler bracket has been removed. • Ambient temperature is too high. • External airflow is obstructed. <p>If the problem persists, see the Getting help section.</p>
	Electrical indicator	The indicator turns solid amber if the system experiences an electrical error (for example, voltage out of range, or a failed power supply unit (PSU) or voltage regulator).	<p>Check the System Event Log or system messages for the specific issue. If it is due to a problem with the PSU, check the LED on the PSU. Reseat the PSU.</p> <p>If the problem persists, see the Getting help section.</p>

Table 47. Status LED indicators and descriptions (continued)

Icon	Description	Condition	Corrective action
	Memory indicator	The indicator turns solid amber if a memory error occurs.	Check the System Event Log or system messages for the location of the failed memory. Reseat the memory module. If the problem persists, see the Getting help section.
	PCIe indicator	The indicator turns solid amber if a PCIe card experiences an error.	Restart the system. Update any required drivers for the PCIe card. Reinstall the card. If the problem persists, see the Getting help section.

NOTE: For more information about the supported PCIe cards, see the Expansion card installation guidelines section.

System health and system ID indicator codes

The system health and system ID indicator is located on the front panel of the system.



Figure 183. System health and system ID indicator

Table 48. System health and system ID indicator codes

System health and system ID indicator code	Condition
Solid blue	Indicates that the system is powered on, is healthy, and system ID mode is not active. Press the system health and system ID button to switch to system ID mode.
Blinking blue	Indicates that the system ID mode is active. Press the system health and system ID button to switch to system health mode.
Solid amber	Indicates that the system is in fail-safe mode. If the problem persists, see the Getting help section.
Blinking amber	Indicates that the system is experiencing a fault. Check the System Event Log for specific error messages. For information about the event and error messages generated by the system firmware and agents that monitor system components, go to qrl.dell.com > Look Up > Error Code , type the error code, and then click Look it up .

iDRAC Quick Sync 2 indicator codes

iDRAC Quick Sync 2 module (optional) is located on the front IO panel of the system.



Table 49. iDRAC Quick Sync 2 indicators and descriptions

iDRAC Quick Sync 2 indicator code	Condition	Corrective action
Off (default state)	Indicates that the iDRAC Quick Sync 2 feature is powered off. Press the iDRAC Quick Sync 2 button to power on the iDRAC Quick Sync 2 feature.	If the LED fails to power on, reseal the front IO panel cable and check. If the problem persists, see the Getting help section.
Solid white	Indicates that iDRAC Quick Sync 2 is ready to communicate. Press the iDRAC Quick Sync 2 button to power off.	If the LED fails to power off, restart the system. If the problem persists, see the Getting help section.
Blinks white rapidly	Indicates data transfer activity.	If the indicator continues to blink indefinitely, see the Getting help section.
Blinks white slowly	Indicates that firmware update is in progress.	If the indicator continues to blink indefinitely, see the Getting help section.
Blinks white five times rapidly and then powers off	Indicates that the iDRAC Quick Sync 2 feature is disabled.	Check if iDRAC Quick Sync 2 feature is configured to be disabled by iDRAC. If the problem persists, see the Getting help section. www.dell.com/poweredge/manuals or <i>Dell OpenManage Server Administrator User's Guide</i> at https://www.dell.com/openmanagemanuals .
Solid amber	Indicates that the system is in fail-safe mode.	Restart the system. If the problem persists, see the Getting help section.
Blinking amber	Indicates that the iDRAC Quick Sync 2 hardware is not responding properly.	Restart the system. If the problem persists, see the Getting help section.

iDRAC Direct LED indicator codes

The iDRAC Direct LED indicator lights up to indicate that the port is connected and is being used as a part of the iDRAC subsystem.

You can configure iDRAC Direct by using a USB to micro USB (type AB) cable, which you can connect to your laptop or tablet. Cable length should not exceed 3 feet (0.91 meters). Performance could be affected by cable quality. The following table describes iDRAC Direct activity when the iDRAC Direct port is active:

Table 50. iDRAC Direct LED indicator codes

iDRAC Direct LED indicator code	Condition
Solid green for two seconds	Indicates that the laptop or tablet is connected.
Blinking green (on for two seconds and off for two seconds)	Indicates that the laptop or tablet connected is recognized.
LED Indicator off	Indicates that the laptop or tablet is unplugged.

NIC indicator codes

Each NIC on the back of the system has indicators that provide information about the activity and link status. The activity LED indicator indicates if data is flowing through the NIC, and the link LED indicator indicates the speed of the connected network.

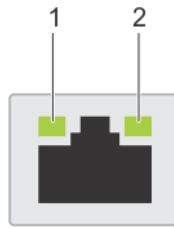

Figure 184. NIC indicator codes

1. Link LED indicator
2. Activity LED indicator

Table 51. NIC indicator codes

NIC indicator codes	Condition
Link and activity indicators are off.	Indicates that the NIC is not connected to the network.
Link indicator is green, and activity indicator is blinking green.	Indicates that the NIC is connected to a valid network at its maximum port speed, and data is being sent or received.
Link indicator is amber, and activity indicator is blinking green.	Indicates that the NIC is connected to a valid network at less than its maximum port speed, and data is being sent or received.
Link indicator is green, and activity indicator is off.	Indicates that the NIC is connected to a valid network at its maximum port speed, and data is not being sent or received.
Link indicator is amber, and activity indicator is off.	Indicates that the NIC is connected to a valid network at less than its maximum port speed, and data is not being sent or received.
Link indicator is blinking green, and activity is off.	Indicates that the NIC identity is enabled through the NIC configuration utility.

Power supply unit indicator codes

AC and DC power supply units (PSUs) have an illuminated translucent handle that serves as an indicator. The indicator shows if power is present or if a power fault has occurred.

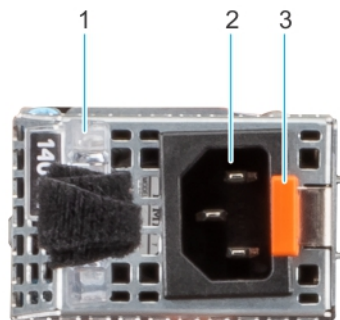

Figure 185. AC PSU status indicator

1. AC PSU handle
2. Socket
3. Release latch

Table 52. AC PSU status indicator codes





Power indicator codes	Condition
Green	Indicates that a valid power source is connected to the PSU and the PSU is operational.
Blinking amber	Indicates an issue with the PSU.
Not powered on	Indicates that the power is not connected to the PSU.
Blinking green	Indicates that the firmware of the PSU is being updated.  CAUTION: Do not disconnect the power cord or unplug the PSU when updating firmware. If firmware update is interrupted, the PSUs will not function.
Blinking green and powers off	When hot-plugging a PSU, it blinks green five times at a rate of 4 Hz and powers off. This indicates a PSU mismatch due to efficiency, feature set, health status, or supported voltage.  CAUTION: If two PSUs are installed, both the PSUs must have the same type of label; for example, Extended Power Performance (EPP) label. Mixing PSUs from previous generations of PowerEdge servers is not supported, even if the PSUs have the same power rating. This results in a PSU mismatch condition or failure to power on the system.  CAUTION: If two PSUs are used, they must be of the same type and have the same maximum output power.  CAUTION: When correcting a PSU mismatch, replace the PSU with the blinking indicator. Swapping the PSU to make a matched pair can result in an error condition and an unexpected system shutdown. To change from a high output configuration to a low output configuration or vice versa, you must power off the system.  CAUTION: AC PSUs support both 240 V and 120 V input voltages with the exception of Titanium PSUs, which support only 240 V. When two identical PSUs receive different input voltages, they can output different wattages, and trigger a mismatch.

Table 53. DC PSU status indicator codes

Power indicator codes	Condition
Green	Indicates that a valid power source is connected to the PSU, and the PSU is operational.
Blinking amber	Indicates an issue with the PSU.
Not powered on	Indicates that the power is not connected to the PSU.
Blinking green	When hot-plugging a PSU, it blinks green five times at a rate of 4 Hz and powers off. This indicates a PSU mismatch due to efficiency, feature set, health status, or supported voltage.  CAUTION: If two PSUs are installed, both the PSUs must have the same type of label; for example, Extended Power Performance (EPP) label. Mixing PSUs from previous generations of PowerEdge servers is not supported, even if the PSUs have the

Table 53. DC PSU status indicator codes (continued)

Power indicator codes	Condition
	<p>same power rating. This results in a PSU mismatch condition, or failure to power on the system.</p> <p>⚠ CAUTION: If two PSUs are used, they must be of the same type and have the same maximum output power.</p> <p>⚠ CAUTION: When correcting a PSU mismatch, replace the PSU with the blinking indicator. Swapping the PSU to make a matched pair can result in an error condition and an unexpected system shutdown. To change from a High Output configuration to a Low Output configuration or conversely, you must power off the system.</p> <p>⚠ CAUTION: Combining AC and DC PSUs is not supported.</p>

Drive indicator codes

The LEDs on the drive carrier indicate the state of each drive. Each drive carrier has two LEDs: an activity LED (green) and a status LED (bicolor, green/amber). The activity LED blinks whenever the drive is accessed.



Figure 186. Drive indicators on the drive and the mid drive tray backplane

1. Drive activity LED indicator
2. Drive status LED indicator
3. Drive capacity label



Figure 187. Drive indicators

1. Drive activity LED indicator

2. Drive status LED indicator
3. Drive capacity label

NOTE: If the drive is in the Advanced Host Controller Interface (AHCI) mode, the status LED indicator does not power on.

NOTE: Drive status indicator behavior is managed by Storage Spaces Direct. Not all drive status indicators may be used.

Table 54. Drive indicator codes

Drive status indicator code	Condition
Blinks green twice per second	Indicates that the drive is being identified or preparing for removal.
Off	Indicates that the drive is ready for removal. NOTE: The drive status indicator remains off until all drives are initialized after the system is powered on. Drives are not ready for removal during this time.
Blinks green, amber, and then powers off	Indicates that there is an unexpected drive failure.
Blinks amber four times per second	Indicates that the drive has failed.
Blinks green slowly	Indicates that the drive is rebuilding.
Solid green	Indicates that the drive is online.
Blinks green for three seconds, amber for three seconds, and then powers off after six seconds	Indicates that the rebuild has stopped.

Using system diagnostics

If you experience an issue with the system, run the system diagnostics before contacting Dell for technical assistance. The purpose of running system diagnostics is to test the system hardware without using additional equipment or risking data loss. If you are unable to fix the issue yourself, service and support personnel can use the diagnostics results to help you solve the issue.

Dell Embedded System Diagnostics

NOTE: The Dell Embedded System Diagnostics is also known as Enhanced Pre-boot System Assessment (ePSA) diagnostics.

The Embedded System Diagnostics provide a set of options for particular device groups or devices allowing you to:

- Run tests automatically or in an interactive mode
- Repeat tests
- Display or save test results
- Run thorough tests to introduce additional test options to provide extra information about the failed device(s)
- View status messages that inform you if tests are completed successfully
- View error messages that inform you of issues encountered during testing

Running the Embedded System Diagnostics from the Dell Lifecycle Controller

Steps

1. When the system is booting, press F10.
2. Select **Hardware Diagnostics** → **Run Hardware Diagnostics**.
The **ePSA Pre-boot System Assessment** window is displayed, listing all devices detected in the system. The diagnostics start executing the tests on all the detected devices.

Running the Embedded System Diagnostics from Boot Manager

Run the Embedded System Diagnostics (ePSA) if your system does not boot.

Steps

1. When the system is booting, press F11.
2. Use the up arrow and down arrow keys to select **System Utilities > Launch Diagnostics**.
3. Alternatively, when the system is booting, press F10, select **Hardware Diagnostics > Run Hardware Diagnostics**.
The **ePSA Pre-boot System Assessment** window is displayed, listing all devices detected in the system. The diagnostics starts executing the tests on all the detected devices.

System diagnostic controls

Table 55. System diagnostic controls

Menu	Description
Configuration	Displays the configuration and status information of all detected devices.
Results	Displays the results of all tests that are run.
System health	Provides the current overview of the system performance.
Event log	Displays a time-stamped log of the results of all tests run on the system. This is displayed if at least one event description is recorded.

Getting help

Topics:

- [Recycling or End-of-Life service information](#)
- [Contacting Dell Technologies](#)
- [Accessing system information by using QRL](#)
- [Receiving automated support with SupportAssist](#)

Recycling or End-of-Life service information

Take back and recycling services are offered for this product in certain countries. If you want to dispose of system components, visit www.dell.com/recyclingworldwide and select the relevant country.

Contacting Dell Technologies

Dell provides online and telephone based support and service options. If you do not have an active internet connection, you can find Dell contact information on your purchase invoice, packing slip, bill or Dell product catalog. The availability of services varies depending on the country and product, and some services may not be available in your area. To contact Dell for sales, technical assistance, or customer service issues follow these steps:

Steps

1. Go to www.dell.com/support/home.
2. Select your country from the drop-down menu on the lower right corner of the page.
3. For customized support:
 - a. Enter the system Service Tag in the **Enter a Service Tag, Serial Number, Service Request, Model, or Keyword** field.
 - b. Click **Search**.
The support page that lists the various support categories is displayed.
4. For general support:
 - a. Select your product category.
 - b. Select your product segment.
 - c. Select your product.
The support page that lists the various support categories is displayed.
5. For contact details of Dell Global Technical Support:
 - a. Click [Contact Technical Support](#).
 - b. The **Contact Technical Support** page is displayed with details to call, chat, or e-mail the Dell Global Technical Support team.

Accessing system information by using QRL

You can use the Quick Resource Locator (QRL) located on the information tag in the front of the T550 system, to access information about Dell EMC PowerEdge T550. There is also another QRL for accessing product information located on the back of the system cover.

Prerequisites

Ensure that your smartphone or tablet has a QR code scanner installed.

The QRL includes the following information about your system:

- How-to videos
- Reference materials, including the Installation and Service Manual, LCD diagnostics, and mechanical overview
- The system service tag to quickly access the specific hardware configuration and warranty information
- A direct link to Dell to contact technical assistance and sales teams

Steps

1. Go to www.dell.com/qrl, and navigate to your specific product or
2. Use your smart phone or tablet to scan the model-specific Quick Resource (QR) code on your system or in the Quick Resource Locator section.

Quick Resource Locator for PowerEdge T550 system



Figure 188. Quick Resource Locator for PowerEdge T550 system

Receiving automated support with SupportAssist

Dell EMC SupportAssist is an optional Dell EMC Services offering that automates technical support for your Dell EMC server, storage, and networking devices. By installing and setting up a SupportAssist application in your IT environment, you can receive the following benefits:

- Automated issue detection — SupportAssist monitors your Dell EMC devices and automatically detects hardware issues, both proactively and predictively.
- Automated case creation — When an issue is detected, SupportAssist automatically opens a support case with Dell EMC Technical Support.
- Automated diagnostic collection — SupportAssist automatically collects system state information from your devices and uploads it securely to Dell EMC. This information is used by Dell EMC Technical Support to troubleshoot the issue.
- Proactive contact — A Dell EMC Technical Support agent contacts you about the support case and helps you resolve the issue.

The available benefits vary depending on the Dell EMC Service entitlement purchased for your device. For more information about SupportAssist, go to www.dell.com/supportassist.

Documentation resources

This section provides information about the documentation resources for your system.

To view the document that is listed in the documentation resources table:

- From the Dell EMC support site:
 1. Click the documentation link that is provided in the Location column in the table.
 2. Click the required product or product version.
-  **NOTE:** To locate the model number, see the front of your system.
- 3. On the Product Support page, click **Documentation**.
- Using search engines:
 - Type the name and version of the document in the search box.

Table 56. Additional documentation resources for your system

Task	Document	Location
Setting up your system	For information about setting up your system, see the <i>Getting Started Guide</i> document that is shipped with your system.	www.dell.com/poweredgemanuals
Configuring your system	For information about the iDRAC features, configuring and logging in to iDRAC, and managing your system remotely, see the Integrated Dell Remote Access Controller User's Guide.	www.dell.com/poweredgemanuals
	For information about understanding Remote Access Controller Admin (RACADM) subcommands and supported RACADM interfaces, see the RACADM CLI Guide for iDRAC.	
	For information about Redfish and its protocol, supported schema, and Redfish Eventing implemented in iDRAC, see the Redfish API Guide.	
	For information about iDRAC property database group and object descriptions, see the Attribute Registry Guide.	
	For information about Intel QuickAssist Technology, see the Integrated Dell Remote Access Controller User's Guide.	
	For information about earlier versions of the iDRAC documents. To identify the version of iDRAC available on your system, on the iDRAC web interface, click ? > About .	www.dell.com/idracmanuals
	For information about installing the operating system, see the operating system documentation.	www.dell.com/operatingsystemmanuals
	For information about updating drivers and firmware, see the Methods to download firmware and drivers section in this document.	www.dell.com/support/drivers

Table 56. Additional documentation resources for your system (continued)

Task	Document	Location
Managing your system	For information about systems management software offered by Dell, see the Dell OpenManage Systems Management Overview Guide.	www.dell.com/poweredgemanuals
	For information about setting up, using, and troubleshooting OpenManage, see the Dell OpenManage Server Administrator User's Guide.	www.dell.com/openmanagemanuals > OpenManage Server Administrator
	For information about installing and using Dell SupportAssist, see the Dell EMC SupportAssist Enterprise User's Guide.	https://www.dell.com/serviceabilitytools
	For information about partner programs enterprise systems management, see the OpenManage Connections Enterprise Systems Management documents.	www.dell.com/openmanagemanuals
Working with the Dell PowerEdge RAID controllers	For information about understanding the features of the Dell PowerEdge RAID controllers (PERC), Software RAID controllers, or BOSS card and deploying the cards, see the Storage controller documentation.	www.dell.com/storagecontrollermanuals
Understanding event and error messages	For information about the event and error messages generated by the system firmware and agents that monitor system components, go to qrl.dell.com > Look Up > Error Code , type the error code, and then click Look it up .	www.dell.com/qrl
Troubleshooting your system	For information about identifying and troubleshooting the PowerEdge server issues, see the Server Troubleshooting Guide.	www.dell.com/poweredgemanuals