

**EPSON**<sup>®</sup>  
EXCEED YOUR VISION

androidtv



# User's Guide

Home Projector

EH-TW6250

## **Notations Used in This Guide** **5**

---

### **Using the Manual to Search for Information** ..... **6**

- Searching by Keyword ..... 6
- Jumping Directly from Bookmarks..... 6
- Printing Only the Pages You Need..... 6

### **Getting the Latest Version of the Documents**..... **7**

## **Introduction to Your Projector** **8**

---

### **Projector Parts and Functions** ..... **9**

- Projector Parts - Front ..... 9
- Projector Parts - Rear..... 10
- Projector Parts - Base ..... 11
- Projector Parts - Projector Remote Control..... 11
- Projector Parts - Remote Control for Streaming Media Player ..... 13

## **Setting Up the Projector** **15**

---

### **Projector Placement** ..... **16**

- Precautions on Installation ..... 17
- Projector Setup and Installation Options..... 17
- Projection Distance..... 18

### **Installing the Safety Wire** ..... **19**

### **Projector Connections** ..... **20**

- Connecting to an HDMI Video Source ..... 20
- Connecting to a Computer for HDMI Video and Audio ..... 20
- Connecting to an iPad/iPhone..... 21
- Connecting to External Devices..... 21
  - Connecting to an ARC Compatible AV System..... 21
  - Connecting to External Speakers ..... 21

### **Installing Batteries in the Remote Control**..... **23**

Remote Control Operation ..... 23

## **Using Basic Projector Features** **25**

---

### **Turning On the Projector** ..... **26**

Setting Up Android TV on the Streaming Media Player..... 28

### **Turning Off the Projector** ..... **30**

### **Selecting the Language for the Projector Menus** ..... **31**

### **Projection Modes** ..... **32**

Changing the Projection Mode Using the Menus ..... 32

### **Adjusting the Image Position Using Lens Shift**..... **33**

### **Adjusting the Image Height**..... **35**

### **Image Shape** ..... **36**

- Auto V-Keystone ..... 36
- Correcting the Image Shape with the Horizontal Keystone Slider..... 36
- Correcting the Image Shape with the Keystone Button ..... 37
- Correcting the Image Shape with Quick Corner ..... 38

### **Resizing the Image with the Zoom Slider**..... **40**

### **Focusing the Image Using the Focus Slider** ..... **41**

### **Selecting an Image Source** ..... **42**

### **Image Aspect Ratio** ..... **43**

- Changing the Image Aspect Ratio ..... 43
- Available Image Aspect Ratios ..... 43

### **Adjusting Image Quality (Color Mode)** ..... **45**

- Changing the Color Mode ..... 45
- Available Color Modes..... 45

### **Adjusting the Image Quality**..... **46**

- Adjusting the Sharpness..... 46
- Adjusting the Image Resolution (Image Enhancement) ..... 46
  - Image Enhancement Options..... 47

Setting Frame Interpolation .....	47
Adjusting the Scene Adaptive Gamma.....	48
Adjusting the Projector Lamp Brightness .....	49
Setting Auto Iris .....	50
<b>Adjusting the Image Color .....</b>	<b>51</b>
Adjusting the Color Temperature .....	51
Adjusting the RGB Offset and Gain .....	51
Adjusting the Hue, Saturation, and Brightness.....	52
Adjusting the Gamma .....	53
<b>Saving Settings to Memory and Using Saved Settings .....</b>	<b>55</b>
<b>Controlling the Volume with the Volume Buttons .....</b>	<b>56</b>
<b>Changing the Sound Mode .....</b>	<b>57</b>
Available Sound Modes .....	57
<b>Adjusting Projector Features .....</b>	<b>58</b>
<hr/>	
<b>HDMI Link Features .....</b>	<b>59</b>
Operating the Connected Devices Using the HDMI Link Features.....	59
<b>Shutting Off the Image and Sound Temporarily (A/V Mute).....</b>	<b>62</b>
<b>Projector Security Features.....</b>	<b>63</b>
Using the Child Lock Feature.....	63
Installing a Security Cable.....	63
<b>Adjusting the Menu Settings .....</b>	<b>64</b>
<hr/>	
<b>Using the Projector's Menus .....</b>	<b>65</b>
<b>Using the Displayed Keyboard .....</b>	<b>66</b>
Available Text Using the Displayed Keyboard .....	66
<b>Image Quality Settings - Image Menu.....</b>	<b>67</b>
<b>Input Signal Settings - Signal Menu.....</b>	<b>69</b>

<b>Projector Feature Settings - Settings Menu .....</b>	<b>70</b>
<b>Projector Setup Settings - Extended Menu .....</b>	<b>72</b>
<b>Projector Information Display - Info Menu .....</b>	<b>74</b>
Info Menu - Projector Info Menu.....	74
<b>Projector Reset Options - Reset Menu .....</b>	<b>76</b>
<b>Maintaining the Projector .....</b>	<b>77</b>
<hr/>	
<b>Projector Maintenance .....</b>	<b>78</b>
<b>Cleaning the Lens.....</b>	<b>79</b>
<b>Cleaning the Projector Case.....</b>	<b>80</b>
<b>Air Filter and Vent Maintenance .....</b>	<b>81</b>
Cleaning the Air Filters and Intake Vents .....	81
Replacing the Air Filter.....	81
<b>Projector Lamp Maintenance.....</b>	<b>83</b>
Replacing the Lamp.....	83
Resetting the Lamp Timer.....	86
<b>Disconnecting a Streaming Media Player.....</b>	<b>87</b>
Remote Control for Streaming Media Player.....	88
Pairing the Remote Control for the Streaming Media Player.....	89
<b>Adjusting the Color Convergence (Panel Alignment) .....</b>	<b>90</b>
<b>Solving Problems .....</b>	<b>92</b>
<hr/>	
<b>Projection Problems.....</b>	<b>93</b>
<b>Projector Indicator Status .....</b>	<b>94</b>
<b>Solving Projector Power-On or Power-Off Problems .....</b>	<b>96</b>
Solving Projector Power Problems .....	96
Solving Projector Shutdown Problems.....	96

- Solving Image Problems ..... 97**
  - Solving Missing Image Problems ..... 97
  - Adjusting an Image that is not Rectangular ..... 97
  - Adjusting a Fuzzy or Blurry Image ..... 98
  - Fixing Partial Image Problems ..... 98
  - Adjusting an Image that Contains Noise or Static ..... 98
  - Adjusting an Image with Incorrect Brightness or Colors ..... 99
  - Adjusting an Upside-down Image ..... 99
- Solving Sound Problems ..... 100**
- Solving Remote Control Operation Problems ..... 101**
- Solving HDMI Link Problems ..... 102**

## **Appendix ..... 103**

---

- Optional Accessories and Replacement Parts ..... 104**
  - Mounts ..... 104
  - External Devices ..... 104
  - Replacement Parts ..... 104
- Screen Size and Projection Distance ..... 105**
- Supported Monitor Display Resolutions ..... 107**
- Projector Specifications ..... 108**
  - Connector Specifications ..... 109
- External Dimensions ..... 110**
- Warning Labels ..... 111**
- List of Safety Symbols and Instructions ..... 112**
- Glossary ..... 114**
- Notices ..... 116**
  - FCC Compliance Statement ..... 116
  - How to Dispose of the Projector ..... 117



- Indication of the manufacturer and the importer in accordance with requirements of EU directive ..... 117
- Indication of the manufacturer and the importer in accordance with requirements of United Kingdom directive ..... 117
- Restriction of Use ..... 117
- Operating System References ..... 118
- Trademarks ..... 118
- Copyright Notice ..... 118
- Copyright Attribution ..... 119

# Notations Used in This Guide







## Safety Symbols

The projector and its manuals use graphical symbols and labels to indicate content that tells you how to use the projector safely.

Read and carefully follow the instructions that are marked with these symbols and labels to avoid injury to persons or damage to property.

 <b>Warning</b>	<p>This symbol indicates information that, if ignored, could possibly result in personal injury or even death.</p>
 <b>Caution</b>	<p>This symbol indicates information that, if ignored, could possibly result in personal injury or physical damage due to incorrect handling.</p>

## General Information Notations

 <b>Attention</b>	<p>This label indicates procedures that may result in damage or injury if sufficient care is not taken.</p>
	<p>This label indicates additional information that may be useful to know.</p>
 button	<p>Indicates the buttons on the remote control or the control panel. Example:  button</p>
<b>Menu/Setting name</b>	<p>Indicates projector menu and setting names. Example: Select the <b>Image</b> menu.  <b>Image &gt; Color</b></p>
	<p>This label indicates links to the related pages.</p>
	<p>This label indicates the projector's current menu level.</p>

## » Related Links

- "Using the Manual to Search for Information" [p.6](#)
- "Getting the Latest Version of the Documents" [p.7](#)

The PDF manual allows you to search for information you are looking for by keyword, or jump directly to specific sections using the bookmarks. You can also print only the pages you need. This section explains how to use a PDF manual that has been opened in Adobe Reader X on your computer.

### ► Related Links

- "Searching by Keyword" p.6
- "Jumping Directly from Bookmarks" p.6
- "Printing Only the Pages You Need" p.6

- Mac OS: Hold down the command key, and then press ←.

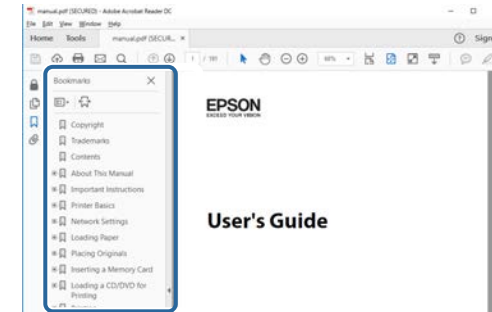

## Searching by Keyword

Click **Edit > Advanced Search**. Enter the keyword (text) for information you want to find in the search window, and then click **Search**. Hits are displayed as a list. Click one of the displayed hits to jump to that page.

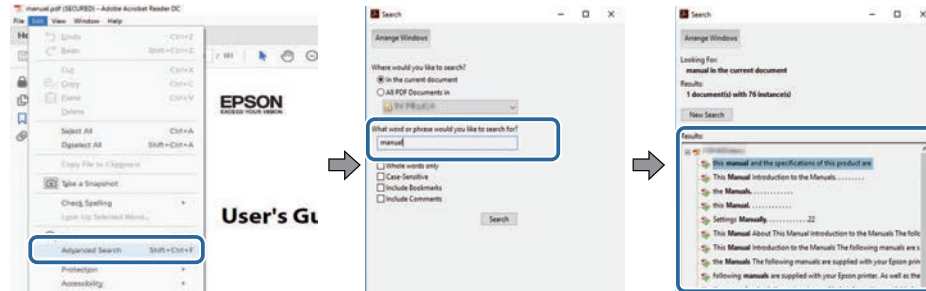

## Printing Only the Pages You Need

You can extract and print only the pages you need. Click **Print** in the **File** menu, and then specify the pages you want to print in **Pages in Pages to Print**.

- To specify a series of pages, enter a hyphen between the start page and the end page.  
Example: 20-25
- To specify pages that are not in series, divide the pages with commas.  
Example: 5, 10, 15

## Jumping Directly from Bookmarks

Click a title to jump to that page. Click + or > to view the lower level titles in that section. To return to the previous page, perform the following operation on your keyboard.

- Windows: Hold down **Alt**, and then press ←.

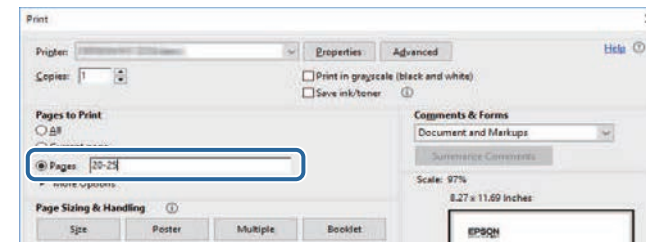

You can get the latest version of the manuals and specifications on the Epson Web site.

Visit [epson.sn](http://epson.sn), and enter your model name.

# Introduction to Your Projector

Refer to these sections to learn more about your projector's features and part names.

## ► **Related Links**

- "Projector Parts and Functions" [p.9](#)



The following sections explain the projector parts and their functions.

► **Related Links**

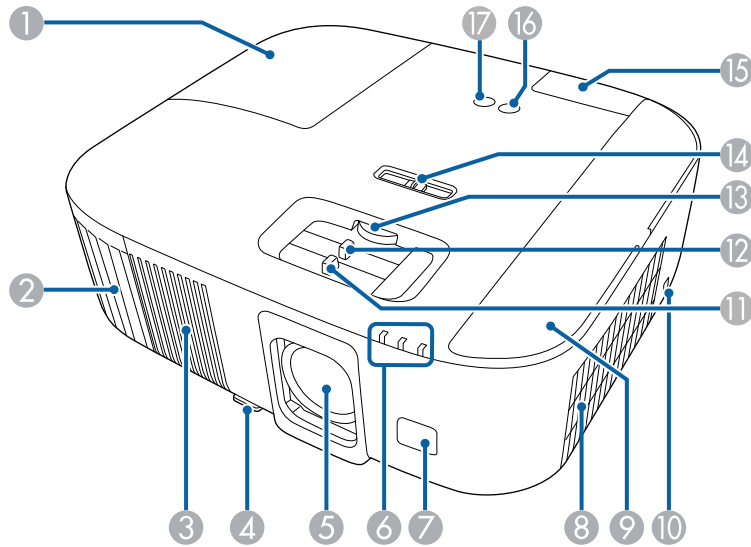

- "Projector Parts - Front" [p.9](#)
- "Projector Parts - Rear" [p.10](#)
- "Projector Parts - Base" [p.11](#)
- "Projector Parts - Projector Remote Control" [p.11](#)
- "Projector Parts - Remote Control for Streaming Media Player" [p.13](#)

## Projector Parts - Front



Name	Function
① Lamp cover	Open to access the projector's lamp.
② Air exhaust vent	Exhaust vent for air used to cool the projector internally.

Name	Function
	<p><b>⚠ Warning</b></p> <p>Do not look into the vents. If the lamp explodes, gases may escape and small fragments of glass may be scattered which could cause an injury. Contact a doctor if any fragments of broken glass are inhaled or get into the eyes or mouth.</p> <p><b>⚠ Caution</b></p> <p>While projecting, do not put your face or hands near the air exhaust vent, and do not place objects that may become warped or damaged by heat near the vent. Hot air from the air exhaust vent could cause burns, warping, or accidents to occur.</p>
③ Speaker	Outputs audio.
④ Foot release lever	Press the foot release lever to extend and retract the front adjustable foot.
⑤ Lens	Images are projected from here.
⑥ Indicators	Indicates the projector's status.
⑦ Remote receiver	Receives signals from the remote control.
⑧ Air intake vent (air filter)	Takes in air to cool the projector internally.
⑨ Air filter cover	Open to access the air filter. Open to connect a streaming media player.
⑩ Security slot	The security slot is compatible with the Microsaver Security System manufactured by Kensington.
⑪ Focus slider	Adjusts the image focus.
⑫ Zoom slider	Adjusts the image size.
⑬ Lens shift dial	Turn the dial to move the position of the projected image up or down.

Name	Function
14 Horizontal keystone slider	Corrects horizontal distortion in the projected image. This slider cannot be used when <b>Keystone</b> is set to <b>Quick Corner</b> in the projector's <b>Settings</b> menu.
15 Rear cover	Open to access the HDMI2 or USB-A ports.
16 Power button [  ]	Turns the projector on or off.
17 Source button [  ]	Switches the input source between <b>HDMI1</b> and <b>HDMI2</b> .

► **Related Links**

- "Air Filter and Vent Maintenance" [p.81](#)
- "Projector Indicator Status" [p.94](#)
- "Remote Control Operation" [p.23](#)
- "Resizing the Image with the Zoom Slider" [p.40](#)
- "Focusing the Image Using the Focus Slider" [p.41](#)
- "Correcting the Image Shape with the Horizontal Keystone Slider" [p.36](#)
- "Adjusting the Image Position Using Lens Shift" [p.33](#)
- "Adjusting the Image Height" [p.35](#)

## Projector Parts - Rear

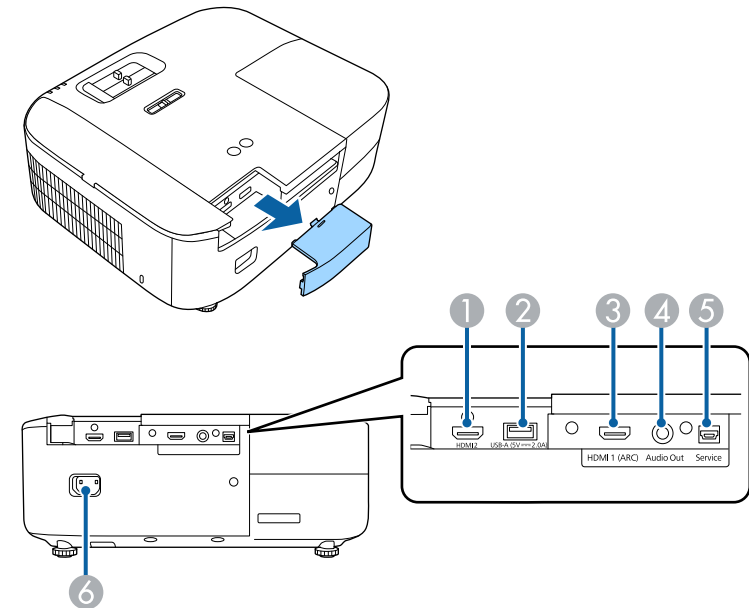

Name	Function
1 HDMI2 ports	Connects the streaming media player that comes with the projector. This port is compatible with HDCP 2.3.
2 USB-A (5V === 2.0A) port	Connects to a streaming media player to power it. Hereinafter referred to as the USB-A port.
3 HDMI1 (ARC) port	Inputs video signals from HDMI compatible video equipment and computers. This port is compatible with HDCP 2.3. This port is compatible with HDMI ARC.
4 Audio Out port	Outputs audio from the current input source to an external speaker.
5 Service port	This port is not normally used.

Name	Function
⑥ Power inlet	Connects the power cord to the projector.

» **Related Links**

- "Projector Connections" [p.20](#)

## Projector Parts - Base

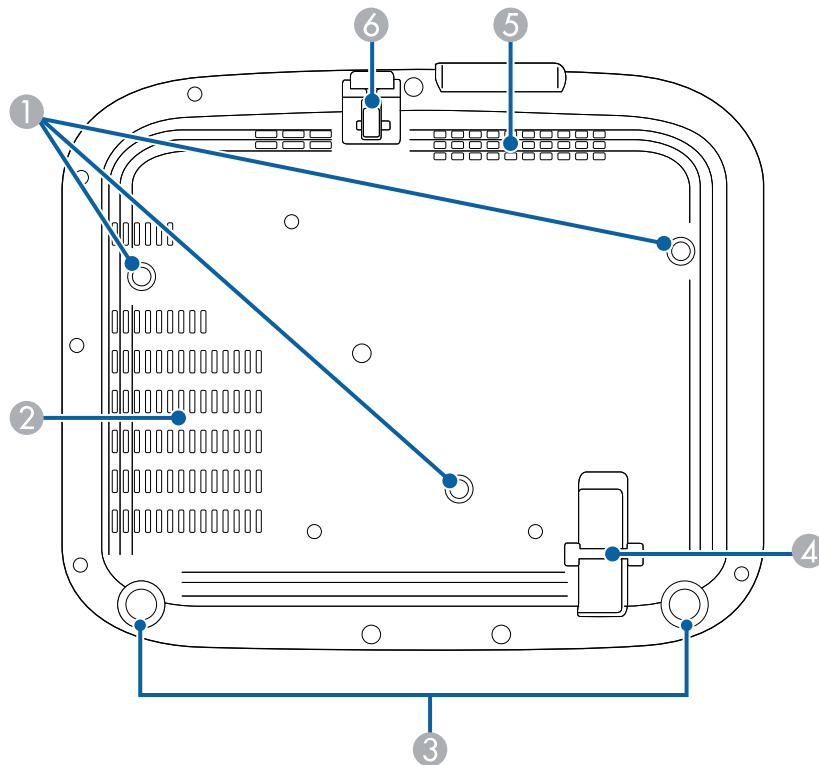

Name	Function
① Ceiling mount fixing points (three points)	Attach the optional ceiling mount here when suspending the projector from a ceiling.
② Air exhaust vent	Exhaust vent for air used to cool the projector internally.
③ Rear feet	When the projector is set up on a surface such as a desk, turn to extend and retract the feet to adjust the horizontal tilt.
④ Security cable attachment point	Pass a commercially available wire lock through here and lock it in place. You can also attach the optional safety wire here to prevent the projector from falling from the ceiling or wall.
⑤ Air intake vent	Takes in air to cool the projector internally.
⑥ Front adjustable foot	When the projector is set up on a surface such as a desk, extend the foot to adjust the position of the image.

» **Related Links**







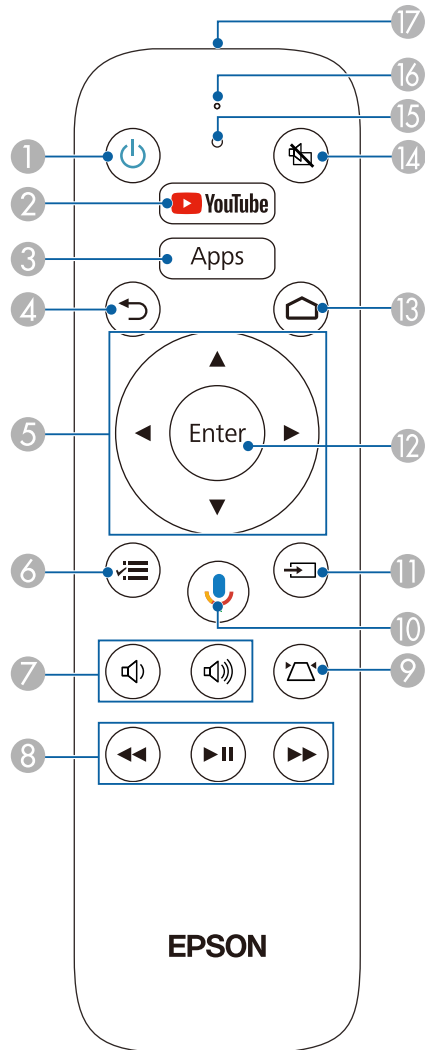

- "Adjusting the Image Height" [p.35](#)
- "Installing a Security Cable" [p.63](#)



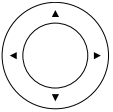

## Projector Parts - Projector Remote Control

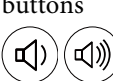
You can operate your projector and Epson streaming media player (ELPAP12) using this remote control.

Unless otherwise stated, all of the operations using a remote control in this guide are explained using this remote control.



Name		Function
1	Power button 	Turns the projector on or off.
2	YouTube button 	Starts the YouTube application.
3	Apps button 	Displays a list of the applications.
4	Esc button 	Stops the current function. Moves back to the previous menu level while displaying the projector's menu.
5	Arrow buttons 	Selects menu items while displaying the projector's menu.
6	Menu button 	Displays and closes the projector's menu. You can use the projector's menus to adjust the settings that control how your projector works.
7	Volume up/down buttons 	Adjusts the volume for the speaker and headphones. You can also control the volume for Bluetooth audio devices connected to the projector.
8	Playback control buttons 	Controls playback of the connected streaming media player or video equipment that supports the HDMI CEC standard.
9	Keystone button 	Displays the <b>Keystone</b> adjustment screen or the <b>Quick Corner</b> screen.

Name	Function
⑩ Google Assistant button 	Allows you to quickly search 400,000+ movies and shows, get recommendations to match your mood, control smart home devices, and more.
⑪ Source button 	Switches the input source between <b>HDMI1</b> and <b>HDMI2</b> .
⑫ [Enter] button 	Enters the current selection and moves to the next level while displaying the projector's menu.
⑬ Home button 	Displays the Android TV™ home screen.
⑭ A/V Mute button 	Turns the video and audio on or off temporarily.
⑮ Indicator	Turns on when outputting signals from the remote control.
⑯ Microphone	Detects audio when you press the Google Assistant button.
⑰ Remote control light emitting area	Outputs remote control signals.

### » Related Links

- "Adjusting Image Quality (Color Mode)" [p.45](#)
- "Correcting the Image Shape with the Keystone Button" [p.37](#)
- "Correcting the Image Shape with Quick Corner" [p.38](#)
- "Turning On the Projector" [p.26](#)
- "Controlling the Volume with the Volume Buttons" [p.56](#)
- "Shutting Off the Image and Sound Temporarily (A/V Mute)" [p.62](#)
- "Using the Projector's Menus" [p.65](#)

## Projector Parts - Remote Control for Streaming Media Player

When you install the Epson streaming media player (ELPAP12) in any video device other than this projector, you can operate ELPAP12 using this remote control.

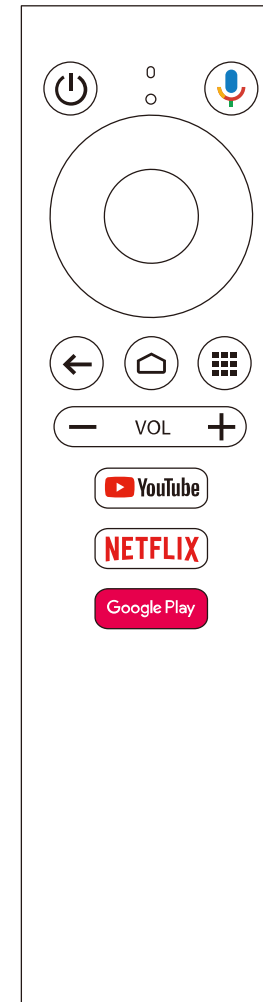

## » Related Links

- "Disconnecting a Streaming Media Player" [p.87](#)

# Setting Up the Projector

Follow the instructions in these sections to set up your projector.

## ► Related Links

- "Projector Placement" [p.16](#)
- "Installing the Safety Wire" [p.19](#)
- "Projector Connections" [p.20](#)
- "Installing Batteries in the Remote Control" [p.23](#)

You can place the projector on almost any flat surface to project an image.

You can also install the projector in a ceiling mount if you want to use it in a fixed location. An optional ceiling mount is required when suspending the projector from a ceiling.

Note the following points when selecting a projector location:

- Place the projector on a sturdy, level surface or install it using a compatible mount.

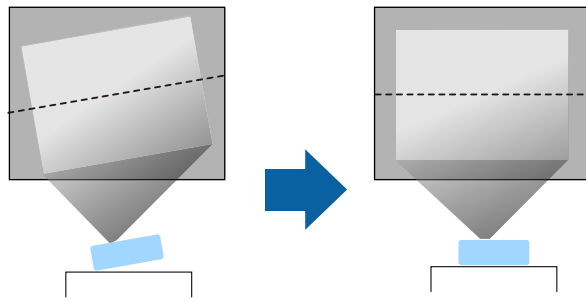

- Leave plenty of space around and under the projector for ventilation, and do not place it on top of or next to anything that could block the vents.
- Place the projector so it squarely faces the screen, not at an angle.

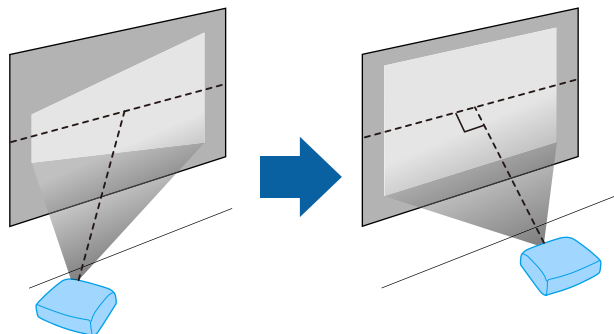

If you cannot install the projector squarely facing the screen, correct any resulting keystone distortion using the projector controls. For the best quality images, we recommend adjusting the installation position of the projector to achieve the correct image size and shape.

## Warning

- You must install a ceiling mount when suspending the projector from a ceiling. If you do not install the projector correctly, it could fall and cause damage or injury.
- Do not use adhesives on the ceiling mount fixing points to prevent the screws from loosening, or use lubricants, oils, or similar substances on the projector; the projector case may crack causing it to fall from its ceiling mount. This could cause serious injury to anyone under the ceiling mount and could damage the projector.
- Failure to install the ceiling mount and projector may cause the projector to fall. After installing the specific Epson mount that supports your projector, make sure you secure the mount to all of the projector's ceiling mount fixing points. Also, secure the projector and the mounts using wire that is strong enough to hold their weight.
- Do not install the projector in a location subject to high levels of dust or humidity, or in a location subject to smoke or steam. Otherwise, it could cause a fire or electric shock to occur. The projector's case could also deteriorate and be damaged causing the projector to fall from the mount.

### Examples of environments that could cause the projector to fall due to case deterioration

- Locations subject to excessive smoke or airborne oil particles, such as factories or kitchens
- Locations containing volatile solvents or chemicals, such as factories or laboratories
- Locations where the projector could be subjected to detergents or chemicals, such as factories or kitchens
- Locations in which aroma oils are often used, such as relaxation rooms
- Near devices that produce excessive smoke, airborne oil particles, or foam at events
- Locations near humidifiers



## ⚠ Warning

- Do not cover the projector's air intake or air exhaust vents. If the vents are covered, the internal temperature could rise and cause a fire.
- Do not use or store the projector in locations where it will be subject to dust or dirt. Otherwise, the quality of the projected image may decline, or the air filter may become clogged, resulting in a malfunction or fire.
- Do not install the projector on an unstable surface or in a location beyond the weight specifications of the projector. Otherwise, it could fall or topple causing an accident and injury.
- When installing the projector in a high position, take measures to prevent falling by using wires to ensure safety in an emergency, such as an earthquake, and to prevent accidents. If it is not installed correctly, it could fall causing an accident and injury.
- Do not install in locations where salt damage could occur, or in locations subject to corrosive gas such as sulphuric gas from hot springs. Otherwise, corrosion could cause the projector to fall. It could also cause the projector to malfunction.

## Attention

- Make sure you do not operate the projector in the following positions. Doing so may cause the projector to malfunction.
  - Do not operate the projector on its side.
  - Do not project images straight up or straight down.
  - Do not tilt the projector right or left.
- If you are using the projector at altitudes above 1,500 m, set the **High Altitude Mode** setting to **On** in the projector's menu to ensure the projector's internal temperature is regulated properly.
  - ☛ **Extended > Operation > High Altitude Mode**
- Try not to setup the projector in locations subject to high humidity and dust, or in locations subject to smoke from fires or tobacco smoke.

## » Related Links

- "Precautions on Installation" [p.17](#)
- "Projector Setup and Installation Options" [p.17](#)
- "Projection Distance" [p.18](#)
- "Image Shape" [p.36](#)
- "Projector Setup Settings - Extended Menu" [p.72](#)

## Precautions on Installation

Note the following precautions when installing the projector.

### Installation space

#### Attention

- Be sure to leave the following amount of space around the projector so as not to block the air exhaust and intake vents.
- Do not install the projector in a location that does not allow air to circulate, such as on a shelf or in a box.

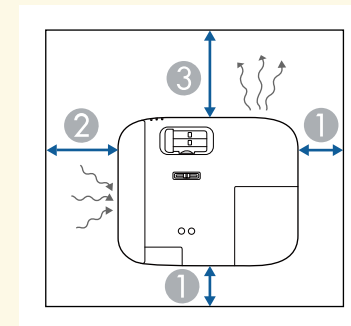

- ① 10 cm
- ② 20 cm
- ③ 30 cm

## Projector Setup and Installation Options

You can set up or install your projector in the following ways:

## Front/Rear

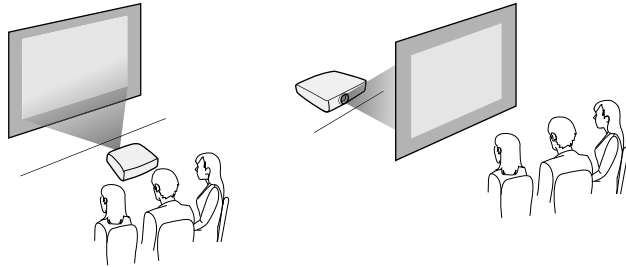

## Front Ceiling/Rear Ceiling

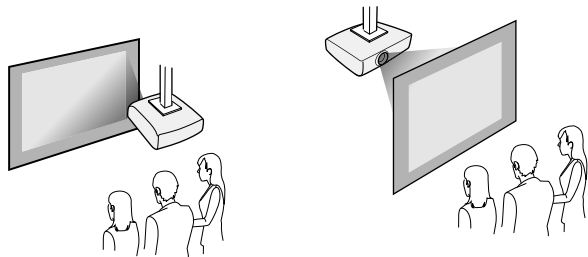

Make sure you select the correct **Projection** option in the projector's **Extended** menu according to the installation method being used.

### » Related Links

- "Projection Modes" [p.32](#)

See the Appendix for details about how far to place the projector from the screen based on the size of the projected image.



When correcting keystone distortion, your image is slightly smaller.

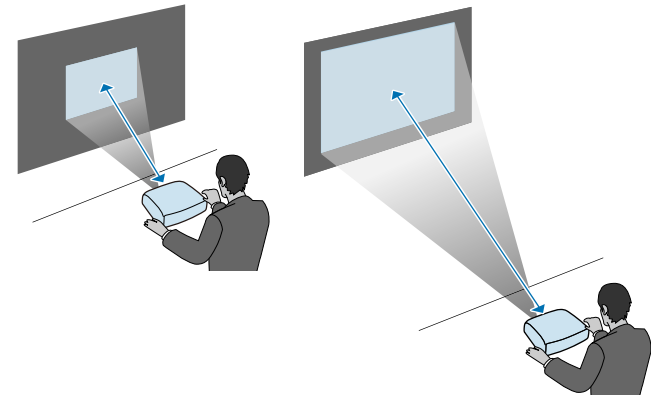

### » Related Links

- "Screen Size and Projection Distance" [p.105](#)

## Projection Distance

The distance at which you place the projector from the screen determines the approximate size of the image. The image size increases the farther the projector is from the screen, but can vary depending on the zoom factor, aspect ratio, and other settings.

When installing the projector in a high location such as a ceiling, wall, or shelf, install the optional safety wire set to secure the projector to the installation location and prevent it from falling.

## **Warning**

Be sure to use the safety wire provided with the Epson ceiling mount. The safety wire is available as an optional Safety Wire Set ELPWR01.

- 1** Pass the safety wire through the security cable attachment point on the projector.

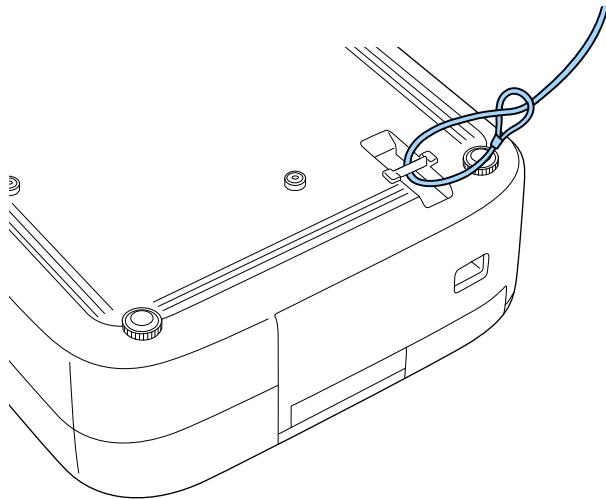

- 2** Attach the other end of the safety wire to a structure that is strong enough to bear the projector's weight, such as a commercially available mounting hardware. If the wire is too long, loop the wire around so that there is as little slack as possible.

See these sections to connect the projector to a variety of projection sources.

### Attention

- Check the shape and orientation of the connectors on any cable you plan to connect. Do not force a connector into a port if it does not fit. The device or your projector could be damaged or could malfunction.
- Make sure you connect the projector and video devices first, and then connect the power cord to the projector's power inlet and plug it into an electrical outlet.

### Related Links

- "Connecting to an HDMI Video Source" [p.20](#)
- "Connecting to a Computer for HDMI Video and Audio" [p.20](#)
- "Connecting to an iPad/iPhone" [p.21](#)
- "Connecting to External Devices" [p.21](#)

## Connecting to an HDMI Video Source

If your video source has an HDMI port, you can connect it to the projector using an HDMI cable.

### Attention

Do not turn on the video source before connecting it to the projector. Doing so could damage the projector.



- If the port on the device you connect has an unusual shape, use the cable supplied with the device or an optional cable to connect to the projector.
- The cable differs depending on the output signal from the connected video devices.
- Some video devices are capable of outputting different types of signals. See your video device manual to confirm what type of signals can be output.

- 1 Connect the HDMI cable to your video source's HDMI output port.

- 2 Connect the other end to the projector's HDMI port.

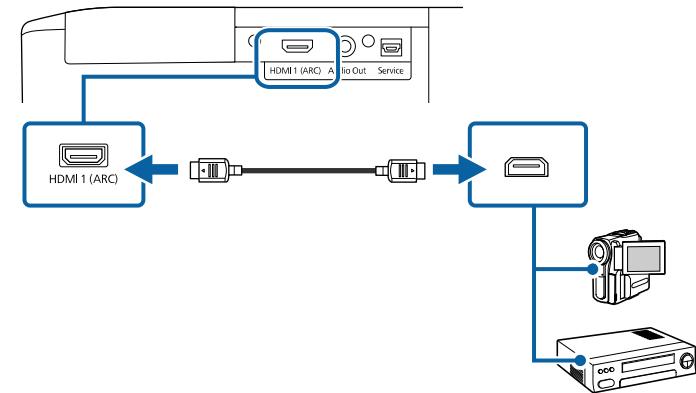

## Connecting to a Computer for HDMI Video and Audio

If your computer has an HDMI port, you can connect it to the projector using an HDMI cable.

- 1 Connect the HDMI cable to your computer's HDMI output port.
- 2 Connect the other end to the projector's HDMI port.

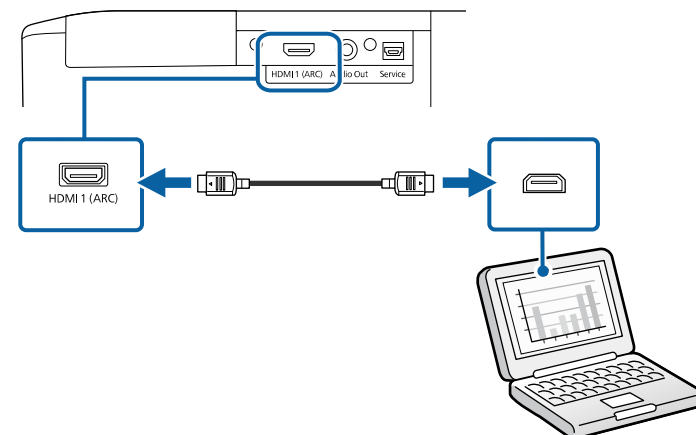

## Connecting to an iPad/iPhone

You can connect your iPad/iPhone to project videos. To connect your device to the projector's HDMI port, use a commercially available cable such as an HDMI conversion adapter.

## Connecting to External Devices

Follow the instructions in these sections to connect external devices to the projector.

### » Related Links

- "Connecting to an ARC Compatible AV System" [p.21](#)
- "Connecting to External Speakers" [p.21](#)

## Connecting to an ARC Compatible AV System

If your AV system or speakers, such as a sound bar, has an HDMI port, you can connect them to the projector using an HDMI cable (with Ethernet) to output audio to these devices.



- When the AV System is connected to the projector, set **HDMI Link** to **On**.
  - ☛ **Settings > HDMI Link > HDMI Link**
- To output audio from the projector's HDMI1 (ARC) port, set **Audio Out Device** to **AV System**.
  - ☛ **Settings > HDMI Link > Audio Out Device**
- See the *Supplemental A/V Support Specification* for ARC audio supported formats.

- 1 Connect the HDMI cable to your AV system's or speakers' HDMI output port (ARC compatible).

- 2 Connect the other end to the projector's HDMI1 (ARC) port.

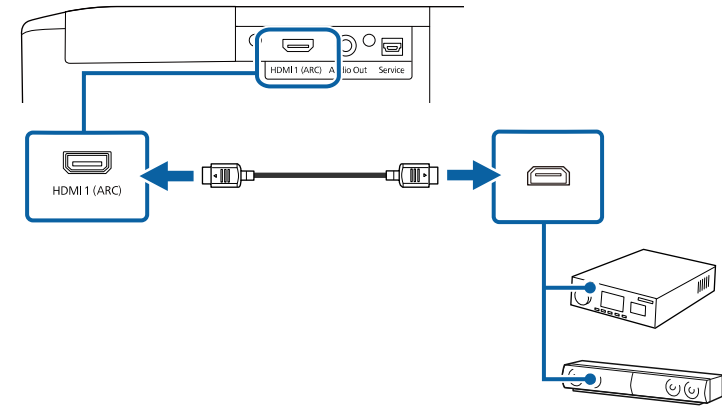

- 3 Make any necessary settings on the connected AV system. See your device's documentation for more information.

### » Related Links

- "Projector Feature Settings - Settings Menu" [p.70](#)

## Connecting to External Speakers

You can connect the projector to external self-powered speakers. You can control the volume using the projector's remote control.

To output audio from external speakers, set the **Audio Out Device** setting to **Projector** in the projector's **Settings** menu. When an audio/video system is not connected to the projector, audio is output from the external speakers even if **Audio Out Device** is set to **AV System**.

☛ **Settings > HDMI Link > Audio Out Device**



- You can also connect the projector to an amplifier with speakers.
- The projector's built-in speaker system is disabled when you connect external speakers.

- 1** Make sure your computer or video source is connected to the projector with both audio and video cables as necessary.
- 2** Locate the appropriate cable to connect your external speakers, such as a stereo mini-jack-to-pin-jack cable, or another type of cable or adapter.
- 3** Connect one end of the cable to your external speakers as necessary.
- 4** Connect the stereo mini-jack end of the cable to your projector's Audio Out port.

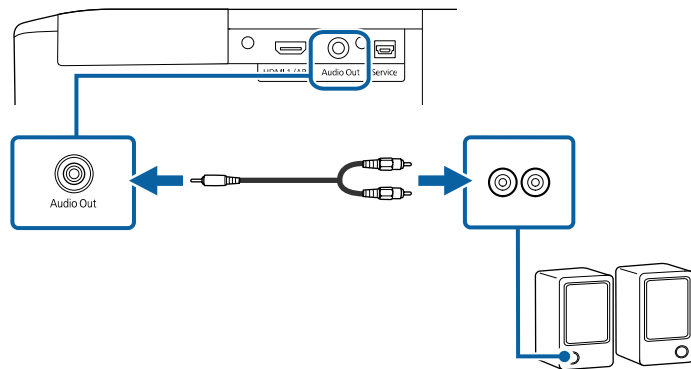

## » Related Links

- "Projector Feature Settings - Settings Menu" [p.70](#)

The remote control uses the two AAA batteries that came with the projector.

## Attention

Make sure you read the *Safety Instructions* before handling the batteries.

- 1 Remove the battery cover as shown.

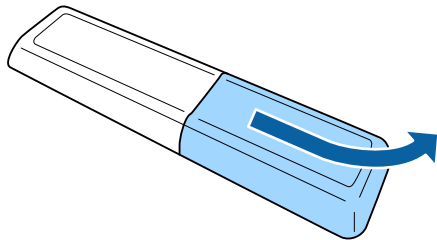

- 2 Remove the old batteries, if necessary.



Dispose of used batteries according to local regulations.

- 3 Insert the batteries with the + and - ends facing as shown.

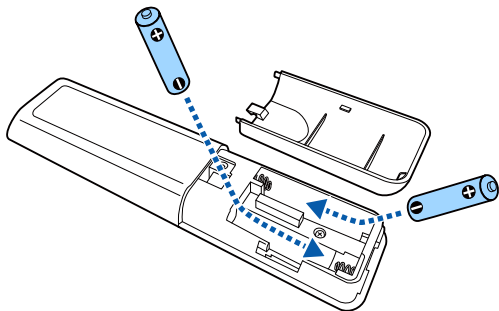

## Warning

Check the positions of the (+) and (-) marks inside the battery holder to ensure the batteries are inserted the correct way. If the batteries are not used correctly, they could explode or leak causing a fire, injury, or damage to the product.

- 4 Replace the battery cover and press it down until it clicks into place.

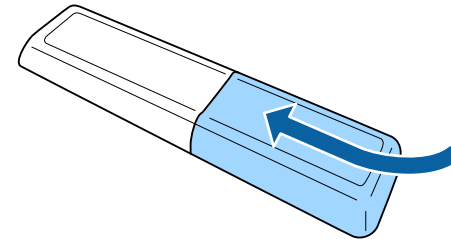

## ► Related Links

- "Remote Control Operation" [p.23](#)

---

## Remote Control Operation

The remote control lets you control the projector from almost anywhere in the room.

Make sure that you aim the remote control at the projector's receivers within the distance and angles listed here.

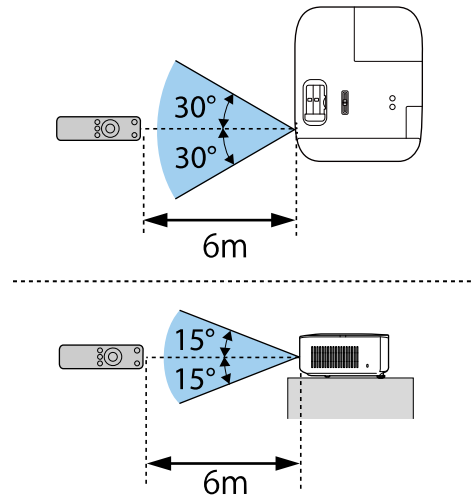

- Avoid using the remote control in conditions with bright fluorescent lights or in direct sunlight, or the projector may not respond to commands. If you are not going to use the remote control for a long time, remove the batteries.



# Using Basic Projector Features

Follow the instructions in these sections to use your projector's basic features.

## ► Related Links

- ["Turning On the Projector" p.26](#)
- ["Turning Off the Projector" p.30](#)
- ["Selecting the Language for the Projector Menus" p.31](#)
- ["Projection Modes" p.32](#)
- ["Adjusting the Image Position Using Lens Shift" p.33](#)
- ["Adjusting the Image Height" p.35](#)
- ["Image Shape" p.36](#)
- ["Resizing the Image with the Zoom Slider" p.40](#)
- ["Focusing the Image Using the Focus Slider" p.41](#)
- ["Selecting an Image Source" p.42](#)
- ["Image Aspect Ratio" p.43](#)
- ["Adjusting Image Quality \(Color Mode\)" p.45](#)
- ["Adjusting the Image Quality" p.46](#)
- ["Adjusting the Image Color" p.51](#)
- ["Saving Settings to Memory and Using Saved Settings" p.55](#)
- ["Controlling the Volume with the Volume Buttons" p.56](#)
- ["Changing the Sound Mode" p.57](#)

Turn on the computer or video device you want to use after you turn on the projector.

- 1** Remove the lens cover.

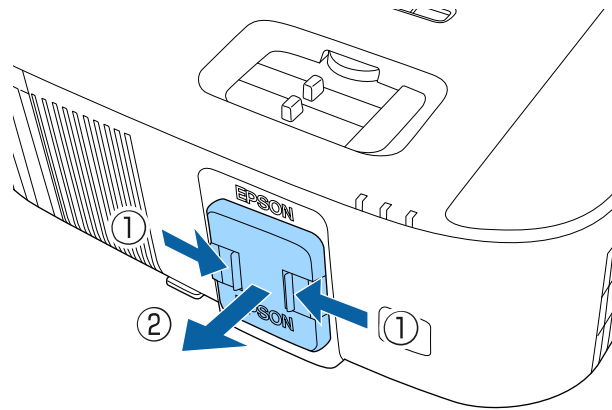

- 2** Connect the power cord to the projector's power inlet and plug it into an electrical outlet.

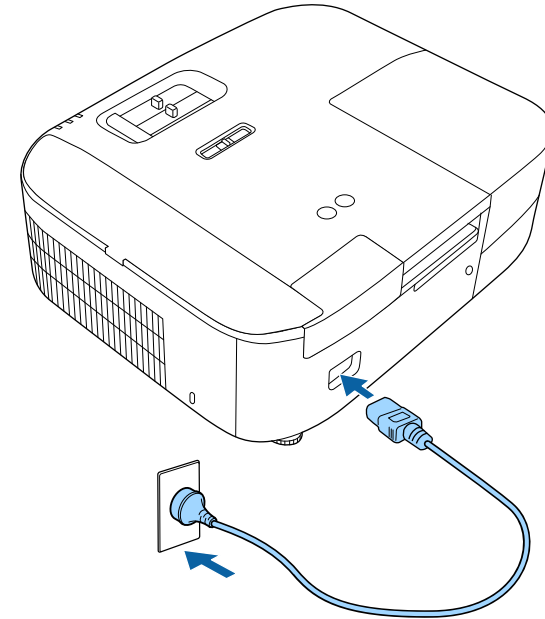

The projector's power indicator turns blue. This indicates that the projector is receiving power, but is not yet turned on (it is in standby mode).

- 3** Press the power button on the projector or remote control to turn on the projector.

The status indicator flashes blue as the projector warms up. Once the projector is warmed up, the status indicator stops flashing and turns blue.



When you connect a computer or a video device, turn on the projector first, and then turn on the connected computer or video device you want to use.

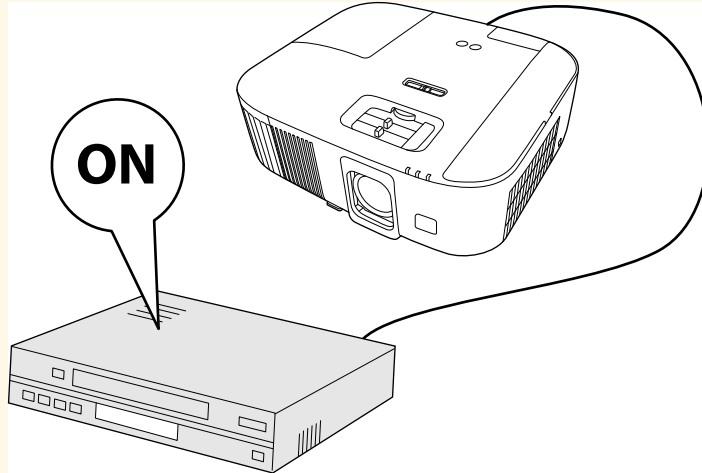

Try the following if you do not see a projected image.

- Turn on the connected computer or video device.
- Change the screen output from the computer when using a laptop computer.
- Insert a DVD or other video media, and press play (if necessary).
- Press the  button on the projector or remote control to detect the source.

## Warning

- Never look into the projector lens when the lamp is on. This can damage your eyes and is especially dangerous for children.
- When turning on the projector at a distance using the remote control, make sure there is no one looking into the lens.
- Do not project images with the lens cover attached. The lens cover may get hot, causing a burn or injury.
- During projection, do not block the light from the projector with a book or other objects. If the light from the projector is blocked, the area on which the light shines becomes hot which could cause it to melt, burn, or start a fire. Also, the lens may get hot due to the reflected light which could cause the projector to malfunction. To stop projection, use the A/V Mute function, or turn off the projector.
- A mercury lamp with high internal pressure is used as the projector's light source. If the lamp is subjected to vibrations or shocks, or if it is used for an overly extended length of time, the lamp may break or it may not turn on. If the lamp explodes, gases may escape and small fragments of glass may be scattered which could cause an injury. Be sure to observe the instructions below.
  - Do not disassemble or damage the lamp or subject it to any impacts.
  - Do not bring your face close to the projector while it is in use.
  - Particular care should be taken when the projector is installed to a ceiling, as small pieces of glass may fall down when the lamp cover is removed. When cleaning the projector or replacing the lamp yourself, be very careful not to allow such pieces of glass to get into the eyes or mouth.
  - If the lamp breaks, ventilate the area immediately, and contact a doctor if any fragments of broken glass are inhaled or get into the eyes or mouth.



- When the **Direct Power On** setting is set to **On** in the projector's **Extended** menu, the projector turns on as soon as you plug it in. Note that the projector also turns on automatically in cases such as recovery from a power outage.
  - ☛ **Extended > Operation > Direct Power On**
- This projector provides a **Child Lock** function to prevent children from accidentally turning the power on.
  - ☛ **Settings > Child Lock**
- If you are using the projector at altitudes above 1,500 m, set the **High Altitude Mode** setting to **On** in the projector's **Extended** menu to ensure the projector's internal temperature is regulated properly.
  - ☛ **Extended > High Altitude Mode**

### » Related Links

- "Setting Up Android TV on the Streaming Media Player" [p.28](#)
- "Projector Setup Settings - Extended Menu" [p.72](#)

## Setting Up Android TV on the Streaming Media Player

When you turn on the projector for the first time, you need to setup Android TV.



You can change each of the settings even after completing the initial setup. Change the settings in the menu displayed when you press  at the top right of the Android TV home screen.

**1** Turn on the projector.

**2** When the pairing screen is displayed, hold down the [Enter] button and  button on the projector remote control at the same time to pair the remote control and the projector.

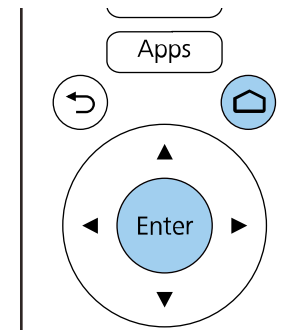

When pairing starts, the indicator on the remote control flashes. When pairing is complete, the indicator turns off.

**3** When the language selection screen is displayed, select the language you want to use.

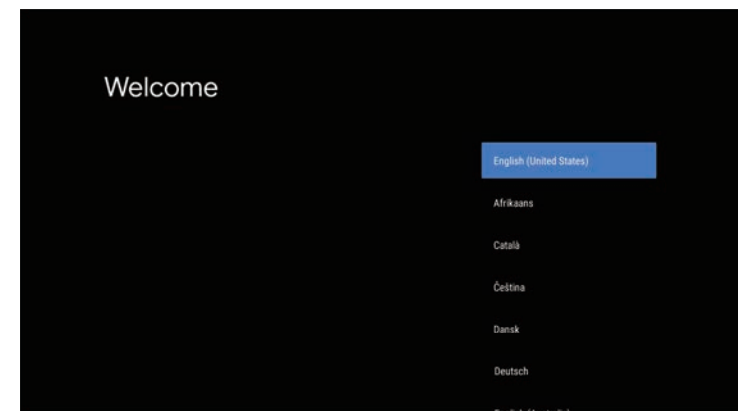

- 4** When the Wi-Fi setting screen is displayed, select the wireless network you want to use, and then follow the on-screen instructions to make necessary settings.
  - An internet connection is required to view online content. Make sure you can use the Wi-Fi service.
  - The customer is responsible for any communication charges incurred when downloading the app or watching online content.
  
- 5** When the login screen is displayed, sign in using your Google Account.
  - You can download various popular apps and games on Google Play by signing in with your Google Account.
  - You can also create a Google Account on your computer or smart device.

When you have finished the initial setup, the home screen is displayed.

Turn off the projector after use.



- Turn off this product when it is not in use to prolong the life of the projector. Lamp life varies depending on the mode selected, environmental conditions, and usage. Brightness decreases over time.

- 1** Press the power button on the projector or remote control.  
The projector displays a shutdown confirmation screen.

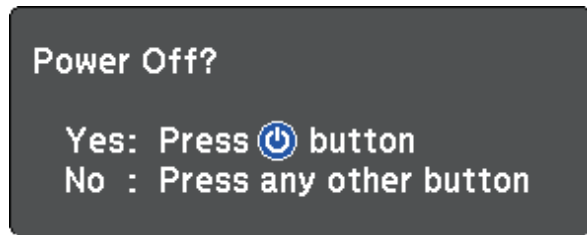

- 2** Press the power button again. (To leave it on, press any other button.)  
The projected image disappears and the status indicator turns off.
- 3** To transport or store the projector, make sure the status indicator on the projector is off, and then unplug the power cord.
- 4** Attach the lens cover.



You can keep supplying power to the streaming media player even if the projector is in standby mode by selecting **Always On** as the **USB Power** setting. This lets the device start earlier, or perform updates automatically over a network if necessary.

☛ **Extended > Operation > USB Power**



## » Related Links

- "Projector Setup Settings - Extended Menu" [p.72](#)

If you want to view the projector's menus and messages in another language, you can change the **Language** setting.

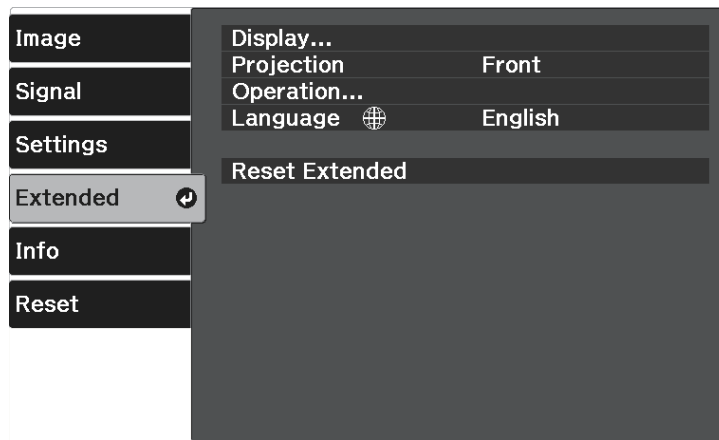
- 1 Turn on the projector.
- 2 Press the  button on the remote control.
- 3 Select the **Extended** menu and press [Enter].



- 4 Select the **Language** setting and press [Enter].
- 5 Select the language you want to use and press [Enter].
- 6 Press  or  to exit the menus.

Depending on how you positioned the projector, you may need to change the projection mode so your images project correctly.

- **Front** lets you project from a table in front of the screen.
- **Front/Ceiling** flips the image over top-to-bottom to project upside-down from a ceiling or wall mount.
- **Rear** flips the image horizontally to project from behind a translucent screen.
- **Rear/Ceiling** flips the image over top-to-bottom and horizontally to project from a ceiling or wall mount and behind a translucent screen.

#### » Related Links

- "Changing the Projection Mode Using the Menus" [p.32](#)
- "Projector Setup and Installation Options" [p.17](#)

## Changing the Projection Mode Using the Menus

You can change the projection mode to flip the image over top-to-bottom and/or left-to-right using the projector menus.

- 1** Turn on the projector and display an image.
- 2** Press the  button on the remote control.

- 3** Select the **Extended** menu and press [Enter].

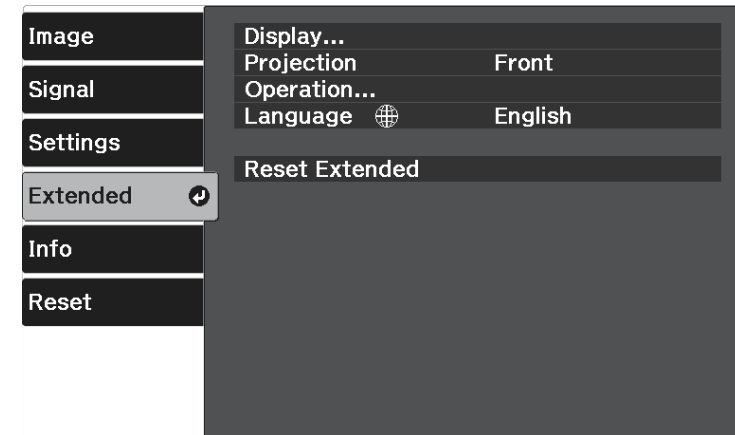

- 4** Select **Projection** and press [Enter].

- 5** Select a projection mode and press [Enter].

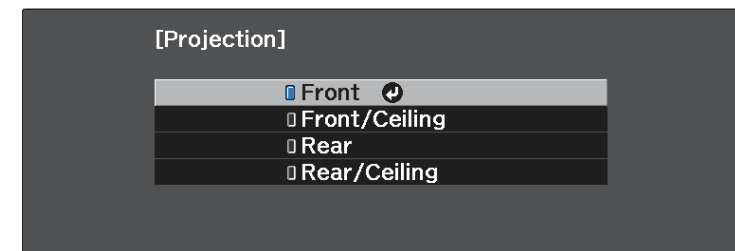



If you cannot install the projector directly in front of the screen, you can adjust the vertical position of the projected image using the lens shift feature.

## Attention

When adjusting the vertical image position using the lens shift, adjust it by moving the image from the bottom to the top. If you adjust it from the top to the bottom, the image position may move down slightly after adjusting.

- 1 Turn on the projector and display an image.

- 2 Turn the lens shift dial on the projector to adjust the position of the projected image as necessary.

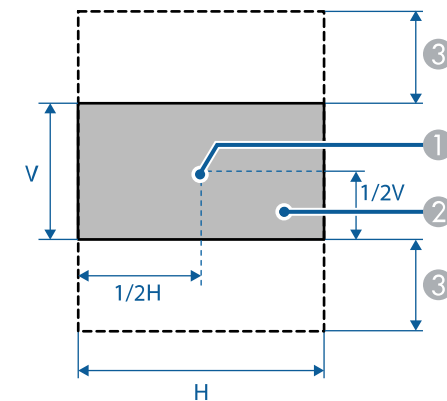
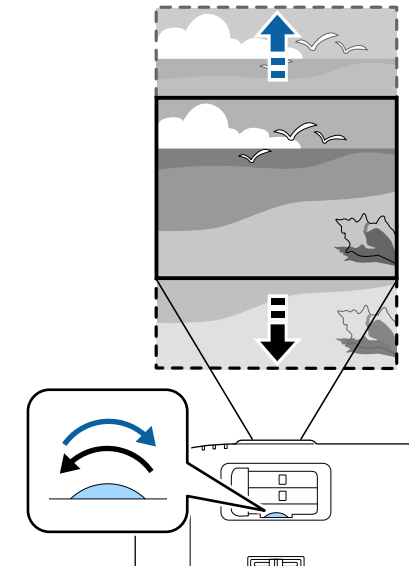

- 1 Center of lens
- 2 Projected image when lens shift is not being used

- ③ Maximum range:  $V \times 60\%$

If you are projecting from a table or other flat surface and the image is too high or low, you can adjust the image height using the projector's adjustable feet.

The larger the angle of tilt, the harder it becomes to focus. Locate the projector so that it only needs to be tilted at a small angle.

- 1** Turn on the projector and display an image.
- 2** To adjust the front foot, pull up on the foot release lever and lift the front of the projector.

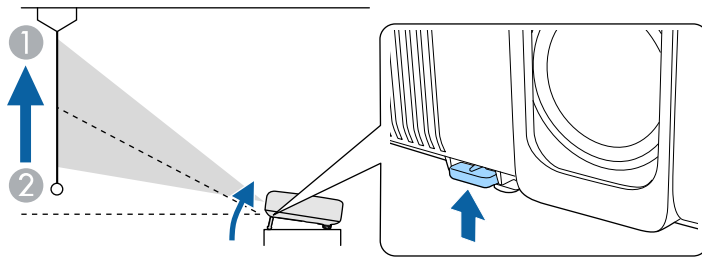

The foot extends from the projector.

You can adjust the position up to approximately 10 degrees.

- 3** If the image is tilted, rotate the rear feet to adjust their height.

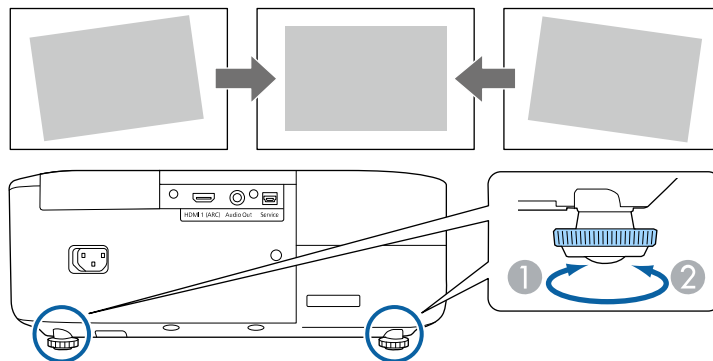

- 1** Extend the rear foot
- 2** Retract the rear foot

If the projected image is unevenly rectangular, you need to adjust the image shape.

## ► Related Links

- "Image Shape" [p.36](#)

You can project an even, rectangular image by placing the projector directly in front of the center of the screen and keeping it level. If you place the projector at an angle to the screen, or tilt it up or down, or off to the side, you may need to correct the image shape.

After correction, your image is slightly smaller.

For the best quality images, we recommend adjusting the installation position of the projector to achieve the correct image size and shape.

#### ► Related Links

- "Auto V-Keystone" [p.36](#)
- "Correcting the Image Shape with the Horizontal Keystone Slider" [p.36](#)
- "Correcting the Image Shape with the Keystone Button" [p.37](#)
- "Correcting the Image Shape with Quick Corner" [p.38](#)

## Auto V-Keystone

When the projector is moved or tilted, **Auto V-Keystone** automatically corrects any vertical keystone distortion.

**Auto V-Keystone** can correct the projected image distortion in these conditions:

- Projection angle is about 30° up or down
- The **Projection** setting is set to **Front** in the projector's **Extended** menu



- If you do not want to use the **Auto V-Keystone** function, set **Auto V-Keystone** to **Off** in the projector's menu.  
 🖱️ **Settings > Keystone > H/V-Keystone > Auto V-Keystone**

#### ► Related Links

- "Projection Modes" [p.32](#)
- "Projector Setup Settings - Extended Menu" [p.72](#)
- "Projector Feature Settings - Settings Menu" [p.70](#)

## Correcting the Image Shape with the Horizontal Keystone Slider

You can use the projector's horizontal keystone slider to correct the shape of an image that is an uneven horizontal rectangle, such as when the projector is placed to the side of the projection area.

You can make effective corrections when the projection angle is about 30° right or left.

- 1 Turn on the projector and display an image.
- 2 Adjust the slider until the image is an even rectangle.

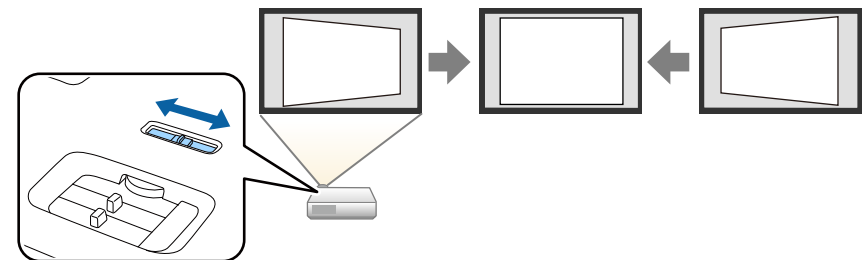

After correction, your image is slightly smaller.



- If the projector is installed out of your reach, you can also correct the shape of the image using the  button on the remote control.
- You can also correct the shape of the image in the projector's menu.  
 🖱️ **Settings > Keystone > H/V-Keystone**

#### ► Related Links

- "Projector Feature Settings - Settings Menu" [p.70](#)

## Correcting the Image Shape with the Keystone Button

You can correct the shape of an image that is unevenly rectangular. To correct the distortion in the horizontal and vertical directions independently, use the  button on the remote control.

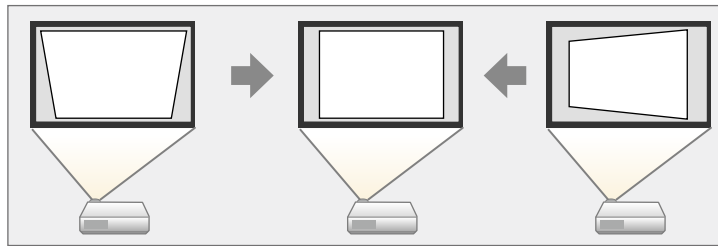

- You cannot combine H/V-Keystone correction with other image shape correction methods.
- You can correct keystone distortion by up to 30° right, left, up, or down.

**1** Turn on the projector and display an image.

**2** Press the  button on the remote control.  
You see the **Keystone** adjustment screen:



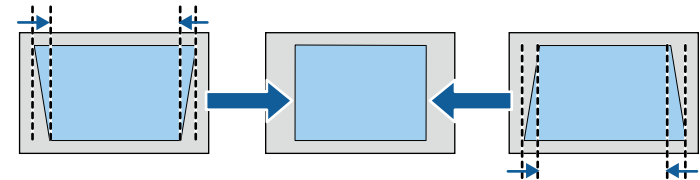

**3** Use the arrow buttons on the remote control to select between vertical and horizontal keystone correction and to adjust the image shape as necessary.

• **V-Keystone**

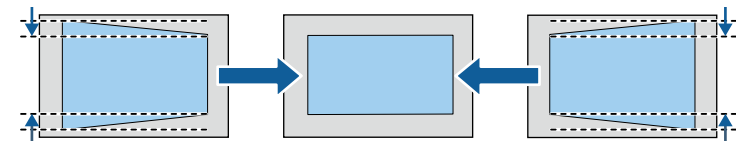

• **H-Keystone**





**4** When you are finished, press .

After correction, your image is slightly smaller.

## Correcting the Image Shape with Quick Corner

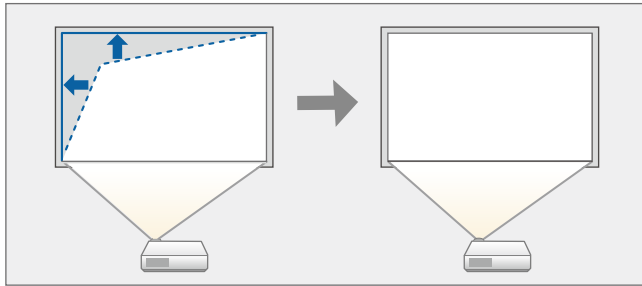
You can use the projector's **Quick Corner** setting to correct the shape and size of an image that is unevenly rectangular.



- 1** Turn on the projector and display an image.
- 2** Press the  button on the remote control.
- 3** Select the **Settings** menu and press [Enter].

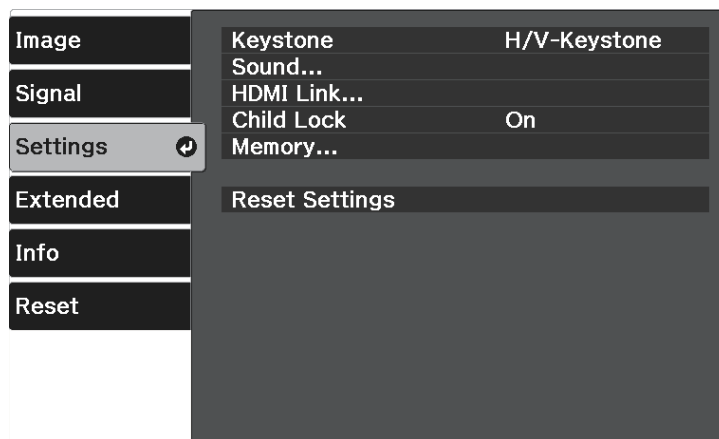

- 4** Select **Keystone** and press [Enter].

- 5** Select **Quick Corner** and press [Enter]. Then press [Enter] again if necessary.

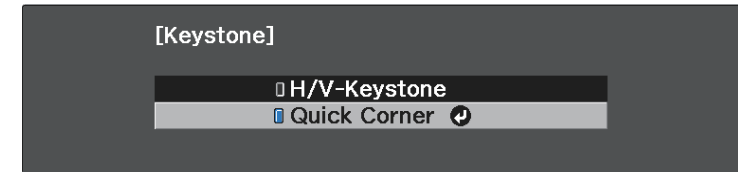

You see the area selection screen.

- 6** Use the arrow buttons to select the corner of the image you want to adjust. Then press [Enter].

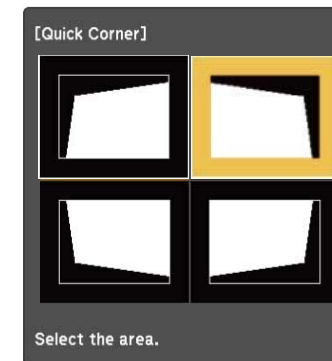

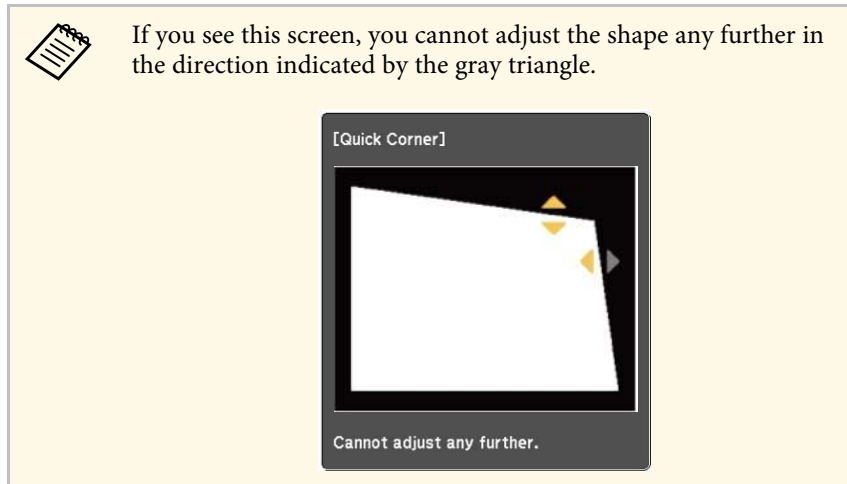

To reset the Quick Corner corrections, hold down  for about two seconds while the area selection screen is displayed, and then select **Yes**.

- 7** Press the arrow buttons to adjust the image shape as necessary. To return to the area selection screen, press [Enter].



**8** Repeat steps 6 and 7 as needed to adjust any remaining corners.

**9** When you are finished, press .

The **Keystone** setting is now set to **Quick Corner** in the projector's **Settings** menu. The next time you press the  button on the remote control, the area selection screen is displayed.

## » Related Links

- "Projector Feature Settings - Settings Menu" [p.70](#)

You can resize the image using the projector's zoom slider.

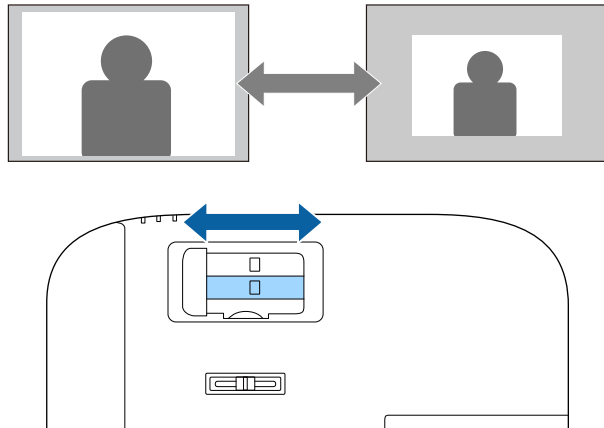



You can correct the focus using the projector's focus slider.

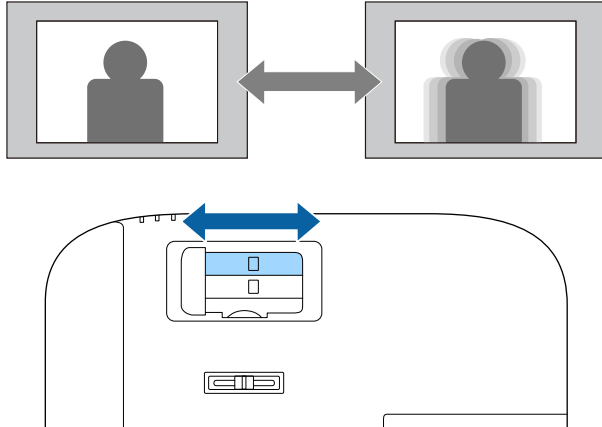

When multiple image sources are connected to the projector, you can switch from one image source to the other.

- 1** Make sure the connected image source you want to use is turned on.
- 2** For video image sources, insert a DVD or other video media and press play.
- 3** Press the  button on the remote control until you see the image from the source you want.



When no image signal is detected, check the cable connections between the projector and the image source.

The projector can display images in different width-to-height ratios called aspect ratios. Normally, the input signal from your video source determines the image's aspect ratio.

If you always want to use a particular aspect ratio for a certain video input source, you can select it using the projector's **Signal** menu.

► **Related Links**

- "Changing the Image Aspect Ratio" [p.43](#)
- "Available Image Aspect Ratios" [p.43](#)
- "Input Signal Settings - Signal Menu" [p.69](#)

## Changing the Image Aspect Ratio

You can change the aspect ratio of the displayed image.

- 1** Turn on the projector and display an image.
- 2** Press the  button on the remote control.
- 3** Select the **Signal** menu and press [Enter].

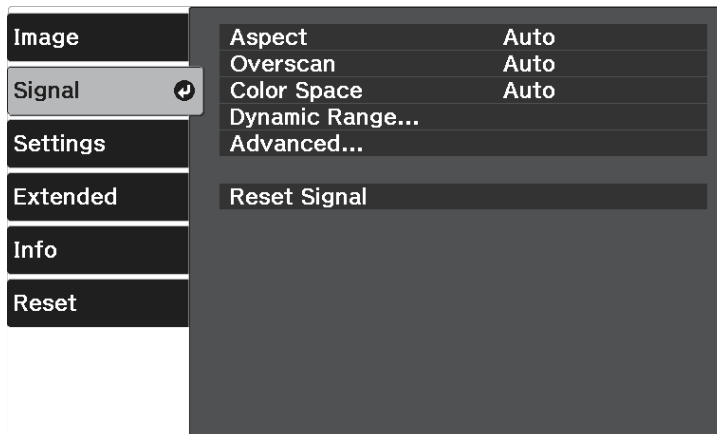

- 4** Select **Aspect** and press [Enter].

- 5** Select one of the available aspect ratios for your input signal and press [Enter].

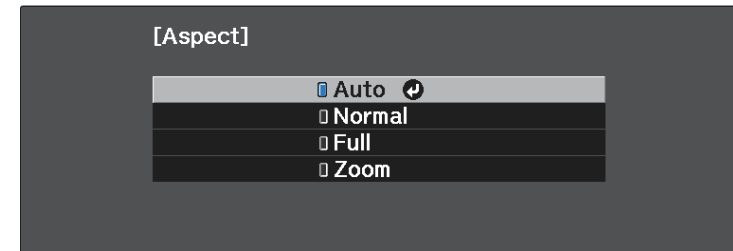

 The available aspect ratio setting varies depending on the input signal.

► **Related Links**

- "Input Signal Settings - Signal Menu" [p.69](#)

## Available Image Aspect Ratios

You can select the following image aspect ratios, depending on the input signal from your image source.

 Note that using the aspect ratio function of the projector to reduce, enlarge, or split the projected image for commercial purposes or for public viewing may infringe upon the rights of the copyright holder of that image based on copyright law.

Aspect mode	Description
Auto	Automatically sets the aspect ratio according to the input signal.

Aspect mode	Description
Normal	Displays images using the full projection area and maintains the aspect ratio of the image.
Full	Displays images using the full size of the projection area, but does not maintain the aspect ratio.
Zoom	Displays images using the full width of the projection area and maintains the aspect ratio of the image.

The projector offers different color modes to provide optimum brightness, contrast, and color for a variety of viewing environments and image types. You can select the mode designed to match your image and environment, or experiment with the available modes.

## » Related Links

- "Changing the Color Mode" [p.45](#)
- "Available Color Modes" [p.45](#)

## Changing the Color Mode

You can change the projector's Color Mode using the remote control to optimize the image for your viewing environment.

- 1** Turn on the projector and display an image.
- 2** Press the  button on the remote control.
- 3** Select the **Image** menu and press [Enter].

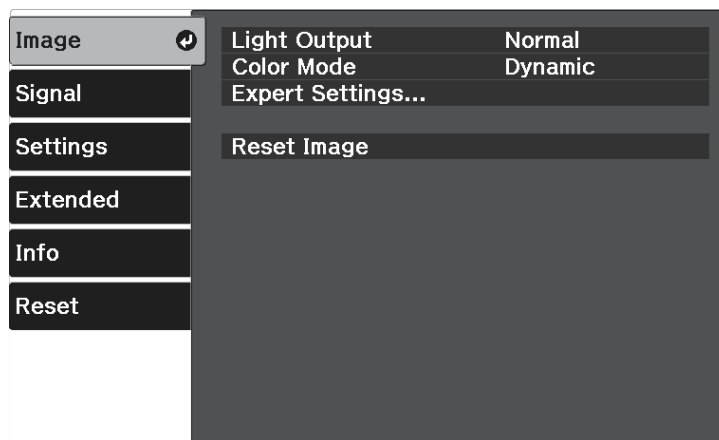

- 4** Select **Color Mode** and press [Enter].

- 5** Select the color mode you want to use from the list and press [Enter].

- 6** Press  or  to exit the menus.

## » Related Links

- "Image Quality Settings - Image Menu" [p.67](#)

## Available Color Modes

You can set the projector to use these color modes, depending on your environment and image types.

Color mode	Description
Dynamic	This is the brightest mode. Best for prioritizing brightness.
Vivid	Best for enjoying content with bright colors.
Natural	Reproduces natural colors. This is the best option when you want to adjust the image color.
Cinema	Best for enjoying content such as movies.

You can fine-tune various aspects of the quality of your projected images.

## » Related Links

- "Adjusting the Sharpness" [p.46](#)
- "Adjusting the Image Resolution (Image Enhancement)" [p.46](#)
- "Setting Frame Interpolation" [p.47](#)
- "Adjusting the Scene Adaptive Gamma" [p.48](#)
- "Adjusting the Projector Lamp Brightness" [p.49](#)
- "Setting Auto Iris" [p.50](#)

---

## Adjusting the Sharpness

You can fine-tune various aspects of the quality of your projected images.

- 1** Turn on the projector and display an image.
- 2** Press the  button on the remote control.
- 3** Select the **Image** menu and press [Enter].

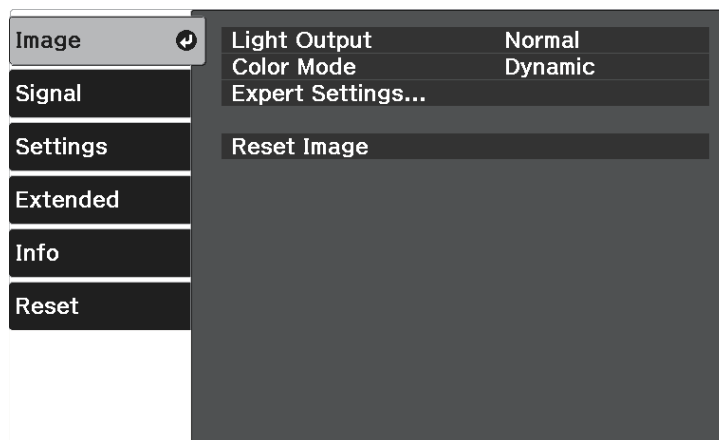

- 4** Select **Expert Settings** > **Sharpness**, and press [Enter].

- 5** Press the right or left arrow buttons to adjust the outline of the image.

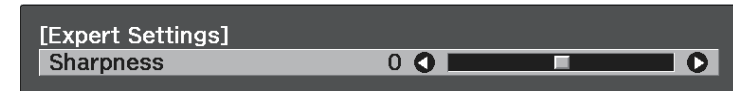

- 6** Press  or  to exit the menus.

## » Related Links

- "Image Quality Settings - Image Menu" [p.67](#)

---

## Adjusting the Image Resolution (Image Enhancement)

You can adjust the resolution of the image to reproduce a clear image with an emphatic texture and material feel. The available settings depend on the currently selected input source.

- 1** Turn on the projector and switch to the image source you want to use.
- 2** Press the  button on the remote control.

**3** Select the **Image** menu and press [Enter].

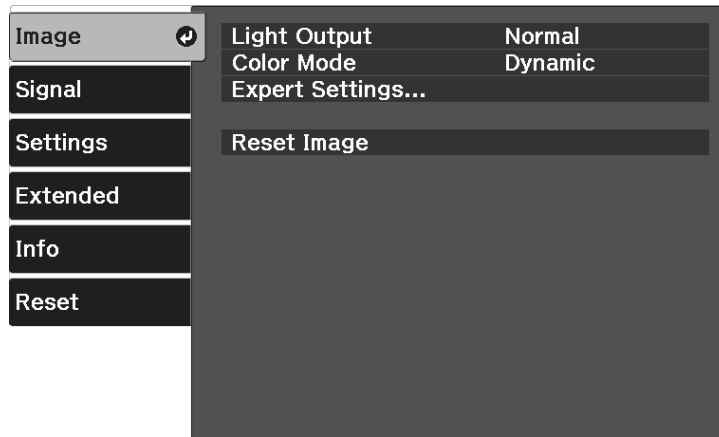

**4** Select **Expert Settings > Image Enhancement**, and press [Enter].

**5** Select the item you want to adjust, and press [Enter].

**6** Adjust each setting as necessary.

**7** Press or to exit the menus.

» **Related Links**

- "Image Enhancement Options" [p.47](#)
- "Image Quality Settings - Image Menu" [p.67](#)

## Image Enhancement Options

You can adjust the following items in the **Image Enhancement** menu.

Color mode	Description
4K Enhancement	When set to <b>On</b> , projects 4K images at the optimal resolution.

Color mode	Description
Image Preset Mode	Selects the settings prepared in advance as the settings for <b>Noise Reduction</b> , <b>MPEG Noise Reduction</b> , and <b>Detail Enhancement</b> .
Noise Reduction	Smooths out rough images.
MPEG Noise Reduction	Reduces dot and block noise that occurs in outlines when projecting MPEG movies.
Detail Enhancement	Enhances the contrast in an image to create a more emphatic texture and material feel.

• **Noise Reduction** and **MPEG Noise Reduction** are available when:

- **Image Processing** is set to **Fine**.  
**Signal > Advanced > Image Processing**
- **Image Preset Mode** is set to any option other than **Off**.
- 4K signals are not being input.
- 21:9 signals (2560 × 1080) are not being input.

• **Detail Enhancement** is available when **Image Preset Mode** is set to any option other than **Off**.

## Setting Frame Interpolation

You can use the projector's **Frame Interpolation** feature to smooth fast-moving video by comparing consecutive image frames and inserting an intermediate image frame between them.

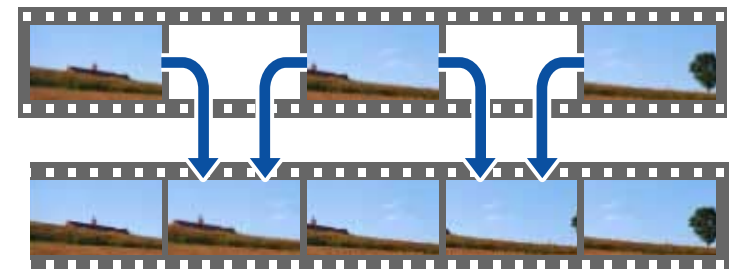

Frame Interpolation is available in these conditions:

- **Image Processing** is set to **Fine**.
  - ☛ **Signal > Advanced > Image Processing**
- **Image Preset Mode** is set to any option other than **Off**.
  - ☛ **Image > Expert Settings > Image Enhancement > Image Preset Mode**
- 4K signals are not being input.
- **4K Enhancement** is set to **Off**. (You can select **On** when 1080p 24Hz signals not being input.)
  - ☛ **Image > Expert Settings > Image Enhancement > 4K Enhancement**

**1** Turn on the projector and switch to the image source you want to use.

**2** Press the  button on the remote control.

**3** Select the **Image** menu and press [Enter].

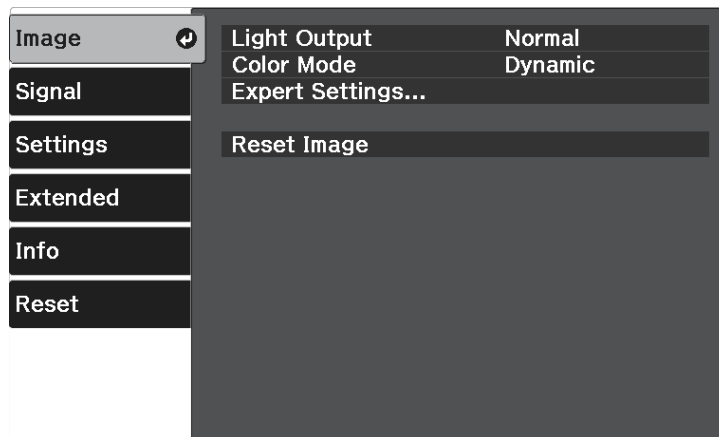

**4** Select **Expert Settings > Frame Interpolation**, and press [Enter].

**5** Select the level of interpolation and press [Enter].

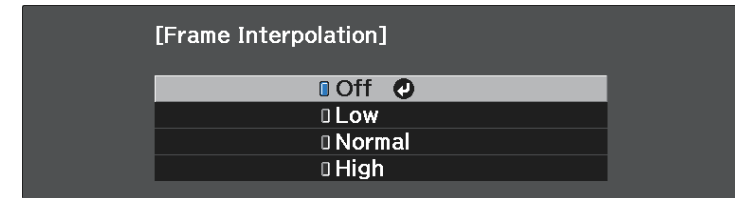

**6** Press  or  to exit the menus.

## » Related Links

- "Image Quality Settings - Image Menu" [p.67](#)

---

## Adjusting the Scene Adaptive Gamma

You can adjust the coloring according to the scene, and obtain a more vivid image by adjusting the **Scene Adaptive Gamma** setting.

**1** Turn on the projector and display an image.

**2** Press the  button on the remote control.



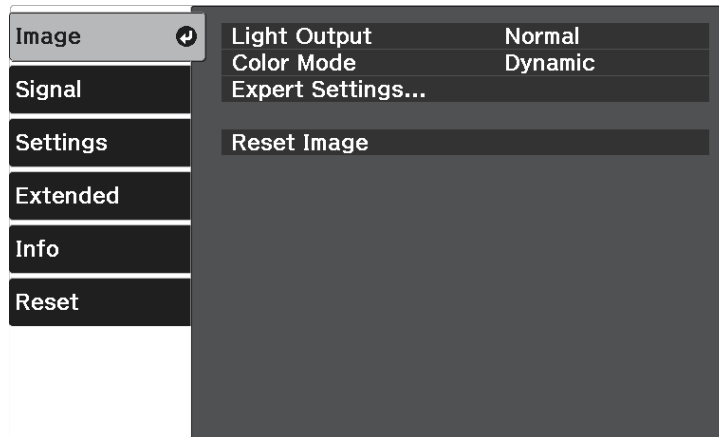

- 3** Select the **Image** menu, and press [Enter].



- 4** Select **Expert Settings > Scene Adaptive Gamma**, and press [Enter].

- 5** Press the left or right arrow buttons to adjust the color tone. Select higher values to enhance the contrast.



- 6** Press  or  to exit the menu.

## » Related Links

- "Image Quality Settings - Image Menu" [p.67](#)

## Adjusting the Projector Lamp Brightness

You can adjust the brightness of your projector's lamp.

- 1** Turn on the projector and display an image.

- 2** Press the  button on the remote control.

- 3** Select the **Image** menu and press [Enter].

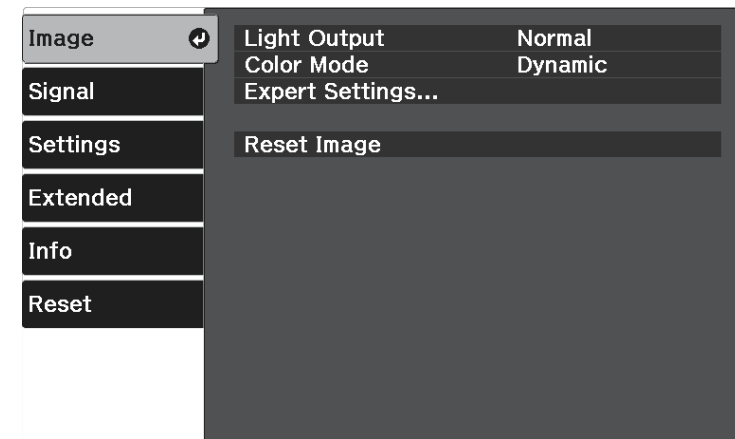

- 4** Select **Light Output** and press [Enter].

- 5** Select a brightness level, and press [Enter].

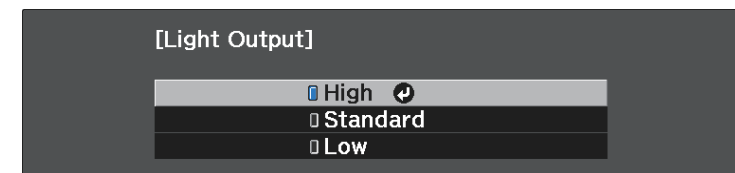

- 6** Press  or  to exit the menu.

## » Related Links

- "Image Quality Settings - Image Menu" [p.67](#)

## Setting Auto Iris

You can turn on **Auto Iris** to automatically optimize the image based on the brightness of the content.

- 1 Turn on the projector and switch to the image source you want to use.
- 2 Press the  button on the remote control.
- 3 Select the **Image** menu and press [Enter].

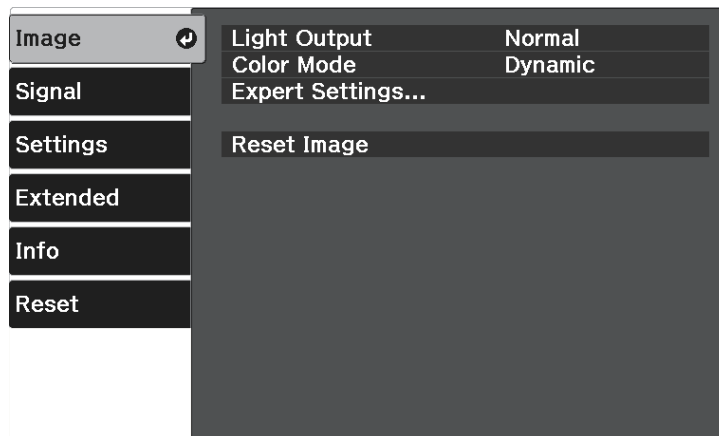

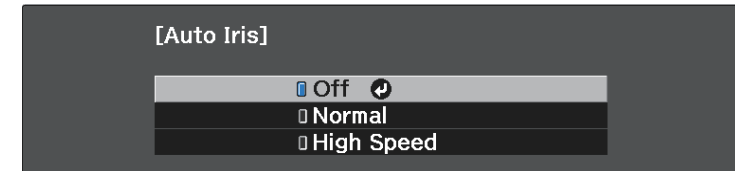

- 4 Select **Expert Settings > Auto Iris**, and press [Enter].

- 5 Choose one of the following options and press [Enter]:



- **Normal** for standard brightness adjustment.
- **High Speed** to adjust brightness as soon as the scene changes.

- 6 Press  or  to exit the menus.

### » Related Links

- "Image Quality Settings - Image Menu" [p.67](#)

You can fine-tune various aspects of how colors are displayed in your projected images.

## » Related Links

- "Adjusting the Color Temperature" [p.51](#)
- "Adjusting the RGB Offset and Gain" [p.51](#)
- "Adjusting the Hue, Saturation, and Brightness" [p.52](#)
- "Adjusting the Gamma" [p.53](#)

---

## Adjusting the Color Temperature

You can set the overall color tone by adjusting the **Color Temp.** setting if the image is too bluish or reddish.

- 1** Turn on the projector and display an image.
- 2** Press the  button on the remote control.
- 3** Select the **Image** menu and press [Enter].

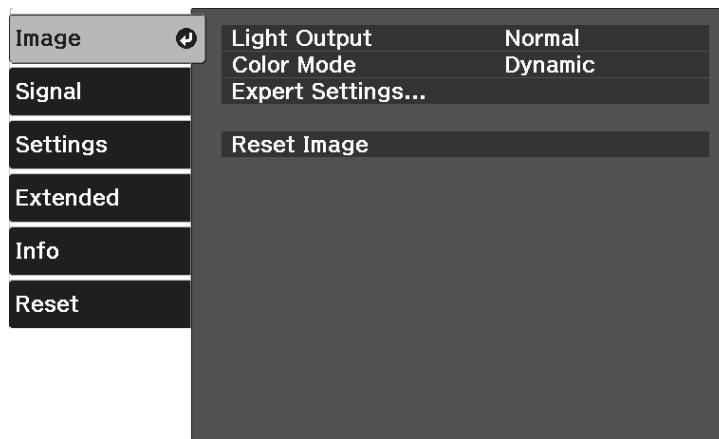

- 4** Select **Expert Settings > White Balance > Color Temp.**, and press [Enter].

- 5** Press the left or right arrow button to adjust the color tone of the image.



Higher values tint the image blue and lower values tint the image red.

- 6** Press  or  to exit the menus.

## » Related Links

- "Image Quality Settings - Image Menu" [p.67](#)

---

## Adjusting the RGB Offset and Gain

You can adjust the brightness of dark and bright areas by adjusting the **Offset** and **Gain** settings for individual image colors.

- 1** Turn on the projector and display an image.
- 2** Press the  button on the remote control.

**3** Select the **Image** menu and press [Enter].

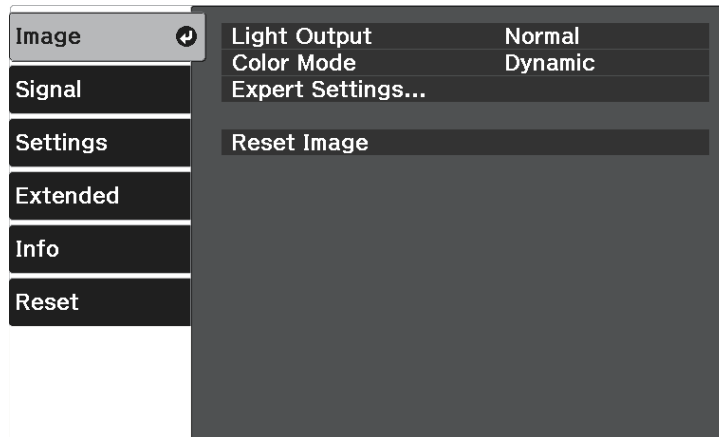

**4** Select **Expert Settings > White Balance > Custom** and press [Enter].

**5** Do the following as necessary for each R (red), G (green), and B (blue):

- To adjust the brightness of dark areas, adjust the **Offset** setting.
- To adjust the brightness of bright areas, adjust the **Gain** setting.



Higher values make the image brighter and lower values make the image darker.

In the **Offset** setting, shading for the dark areas is more vividly expressed when you select a high value. When you select a low value, the image appears more full-bodied but shading for the dark areas is harder to distinguish.

In the **Gain** setting, the bright areas become whiter and shading is lost when you select a high value. When you select a low value, shading for the bright areas is more vividly expressed.

**6** Press  or  to exit the menus.

### » Related Links

- "Image Quality Settings - Image Menu" [p.67](#)

## Adjusting the Hue, Saturation, and Brightness

You can adjust the **Hue**, **Saturation**, and **Brightness** settings for individual image colors.

**1** Turn on the projector and display an image.

**2** Press the  button on the remote control.

**3** Select the **Image** menu and press [Enter].

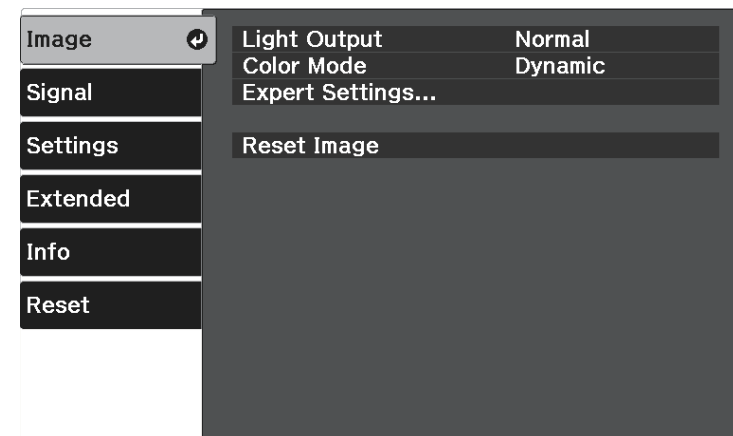

**4** Select **Expert Settings** > **RGBCMY**, and press [Enter].

**5** Select the color to adjust, and press [Enter].



**6** Do the following as necessary for each setting:

- To adjust the overall hue of the color, bluish - greenish - reddish, adjust the **Hue** setting.
- To adjust the overall vividness of the color, adjust the **Saturation** setting.
- To adjust the overall color brightness of the color, adjust the **Brightness** setting.

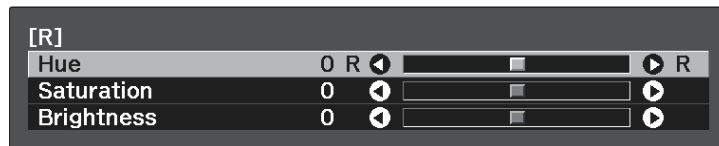

**7** Press or to exit the menus.

» **Related Links**

- "Image Quality Settings - Image Menu" [p.67](#)

## Adjusting the Gamma

You can correct differences in projected image colors that occur between different image sources by adjusting the **Gamma** setting.

**1** Turn on the projector and display an image.

**2** Press the button on the remote control.

**3** Select the **Image** menu and press [Enter].

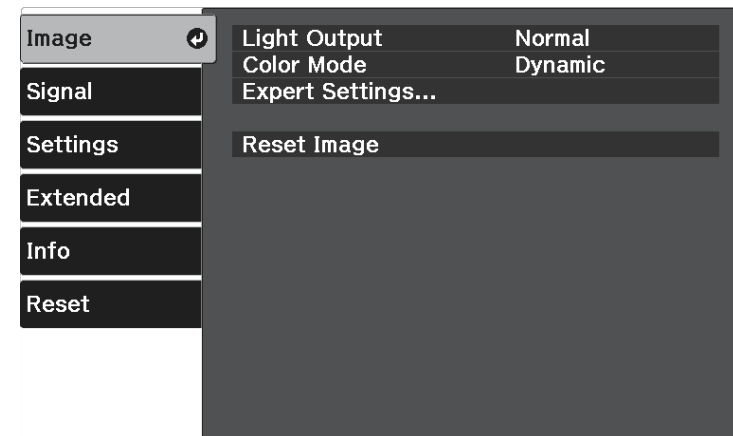

**4** Select **Expert Settings** > **Gamma**, and press [Enter].

- 5** Select and adjust the correction value.

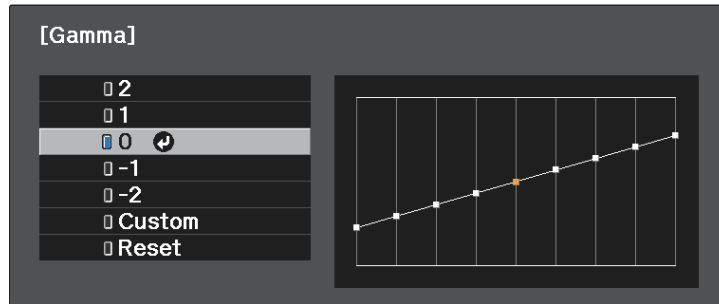

When you select a smaller value, you can reduce the overall brightness of the image to make the image sharper. When you select a larger value, the dark areas of images become brighter, but the color saturation for lighter areas may become weaker.

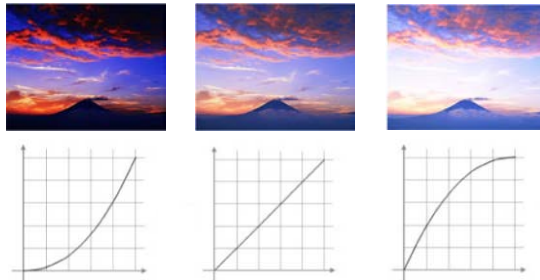

- 6** If you want to make finer adjustments, select **Custom** and press [Enter].

- 7** Press the left or right arrow buttons to select the color tone you want to adjust on the gamma adjustment graph. Then press the up or down arrow button to adjust the value and press [Enter].

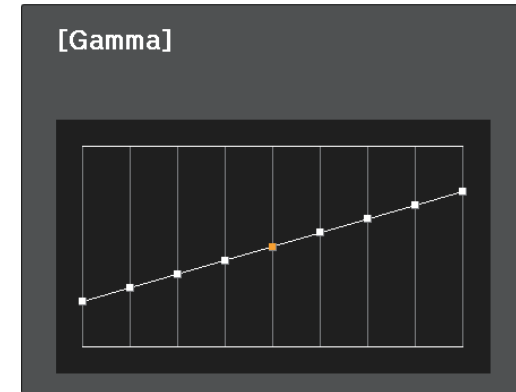

- 8** Press  or  to exit the menus.

## » Related Links

- "Image Quality Settings - Image Menu" [p.67](#)

You can save the customized **Image** menu settings for your video inputs and then select the saved settings whenever you want to use them.

- 1 Turn on the projector and display an image.
- 2 Press the  button on the remote control.
- 3 Select the **Settings** menu and press [Enter].

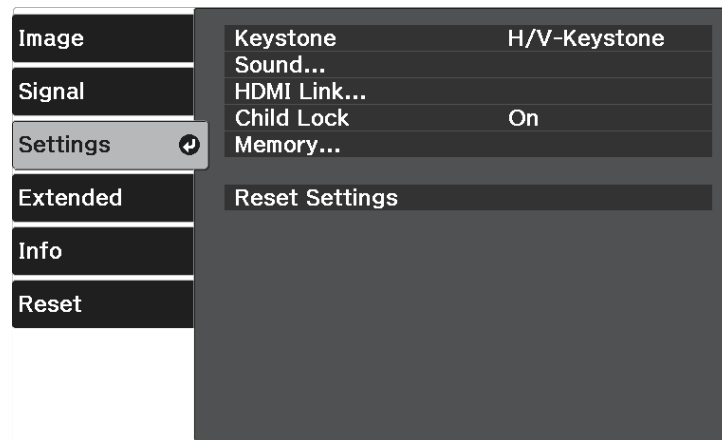

- 4 Select **Memory** and press [Enter].

- 5 Select one of the following options:

- **Load Memory** lets you overwrite your current **Image** menu settings with saved settings.
- **Save Memory** lets you save your current **Image** menu settings to memory (10 memories with different names are available).





A memory name that has already been used is indicated by a blue mark. Saving over a previously saved memory overwrites the settings with your current settings.

- **Erase Memory** lets you erase the selected memory settings.

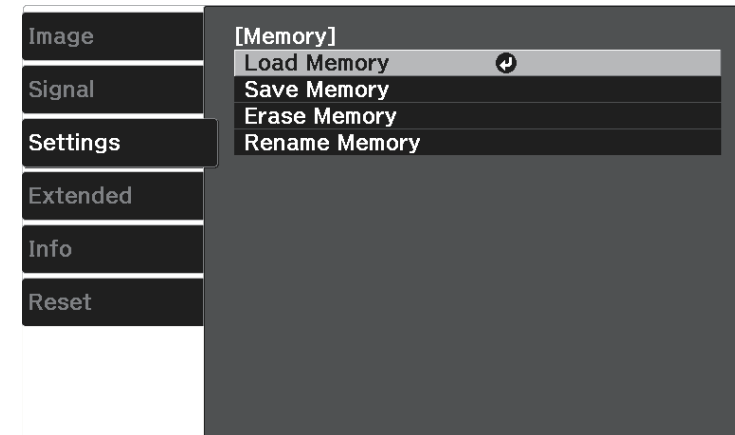
- **Rename Memory** lets you rename a saved memory.



- 6 Press  or  to exit the menus.



- The saved Color Mode is displayed on the right of the memory name.
- To delete all saved memories, select **Reset Memory** in the projector's **Reset** menu.

## » Related Links

- "Projector Feature Settings - Settings Menu" [p.70](#)



The volume buttons control the projector's internal speaker system.

You can also control the volume of any external speakers you connected to the projector.

You must adjust the volume separately for each connected input source.



- To adjust the volume for connected audio/video system, set the **HDMI Link** setting to **On** and the **Audio Out Device** setting to **AV System** in the projector's **Settings** menu.
  - ☛ **Settings > HDMI Link > HDMI Link**
  - ☛ **Settings > HDMI Link > Audio Out Device**

- 1** Turn on the projector and start a presentation.
- 2** To lower or raise the volume, press the  or  buttons on the remote control.

A volume gauge appears on the screen.
- 3** To set the volume to a specific level for an input source, select **Volume** in the projector's **Settings** menu.



If you have adjusted the volume for your streaming media player to the lowest level using the remote control for the streaming media player, you cannot raise the volume using the projector remote control. Raise the volume using the remote control for the streaming media player, and then adjust the volume again using the projector remote control.

## **Caution**

Do not start a presentation at a high volume setting. Sudden loud noises may cause hearing loss.

Always lower the volume before powering off, so that you can power on and then gradually increase the volume.

## » **Related Links**

- "Projector Feature Settings - Settings Menu" [p.70](#)



The projector offers different sound modes to provide optimum sound for a variety of image types.

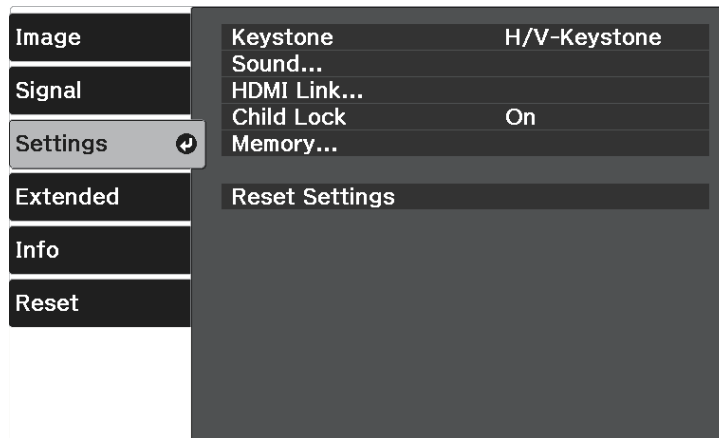

You can select the mode designed to match your image, or experiment with the available modes.

- 1** Turn on the projector and start a video.
- 2** Press the  button on the remote control.
- 3** Select the **Settings** menu and press [Enter].

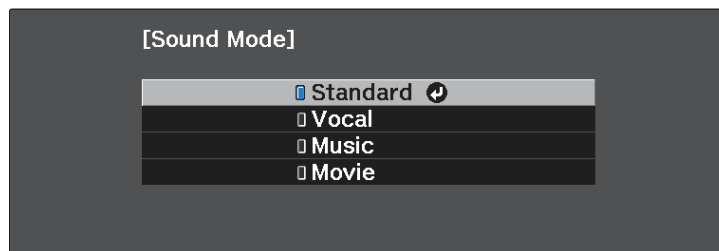

- 4** Select **Sound > Sound Mode** and press [Enter].
- 5** Select your sound mode and press [Enter].



- 6** Press  or  to exit the menus.

» **Related Links**

- "Available Sound Modes" [p.57](#)
- "Projector Feature Settings - Settings Menu" [p.70](#)

## Available Sound Modes

You can set the projector to use these sound modes, depending on the input source you are using:

Sound mode	Description
Standard	Outputs the audio using normal sound quality.
Vocal	Best for hearing voices and spoken lines.
Music	Best for music. Low and high pitch sounds are clearer.
Movie	Best for audio from videos or movies. Low and high pitch sounds are emphasized.

# Adjusting Projector Features

Follow the instructions in these sections to use your projector's adjustment features.

## ► **Related Links**

- "HDMI Link Features" [p.59](#)
- "Shutting Off the Image and Sound Temporarily (A/V Mute)" [p.62](#)
- "Projector Security Features" [p.63](#)

When an audio/video source that meets the HDMI CEC standard is connected to the projector's HDMI port, you can use the projector's remote control to control certain features of the linked device.

» **Related Links**

- "Operating the Connected Devices Using the HDMI Link Features" [p.59](#)

## Operating the Connected Devices Using the HDMI Link Features

You can select the connected device that is available for HDMI Link and control the selected device using the HDMI Link features.



- You must also configure the connected device. See the documentation supplied with the device for more information.
- Some connected devices or functions of those devices may not operate properly even if they meet the HDMI CEC standard. See the documentation supplied with the device for more information.
- Use a cable that supports the HDMI standard.

**1** Press the  button on the remote control.

**2** Select the **Settings** menu and press [Enter].

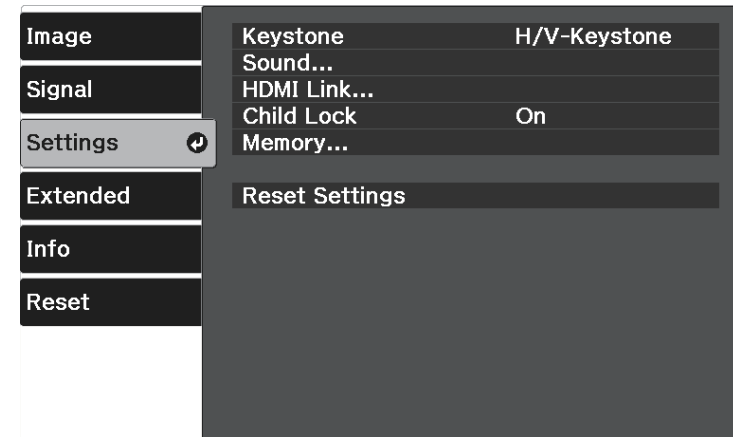

**3** Select **HDMI Link** and press [Enter].

**4** Select **On** as the **HDMI Link** setting and press [Enter].

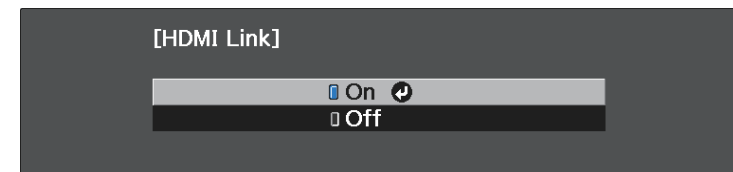

**5** Select **Device Connections** and press [Enter].

You see the Device Connections list.

- 6** Select the device you want to control and project the image from, and press [Enter].

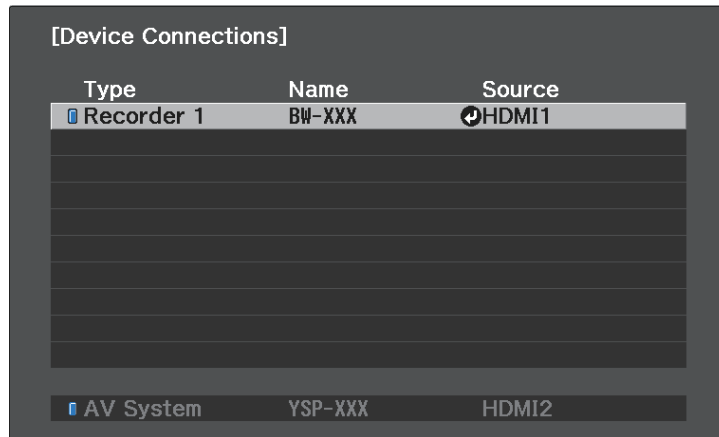

- A linked device is indicated by a blue mark.
- The device name is left blank if it cannot be acquired.

- 7** Press to select the HDMI Link options as necessary.
- **Audio Out Device** lets you select whether to output audio from the internal speakers or a connected audio/video system.
  - **Power On Link** lets you control what happens when you turn on the projector or linked device. Select **PJ -> Device** or **Bidirectional** to turn the linked device on when the projector is turned on. Select **Device -> PJ** or **Bidirectional** to turn the projector on when the linked device is turned on.
  - **Power Off Link** lets you control whether linked devices are turned off when the projector is turned off.

- **Power Off Link** only works when the connected device's CEC power link function is enabled.
- Note that depending on the status of the connected device (for example, if it is recording), the device may not be turned off.

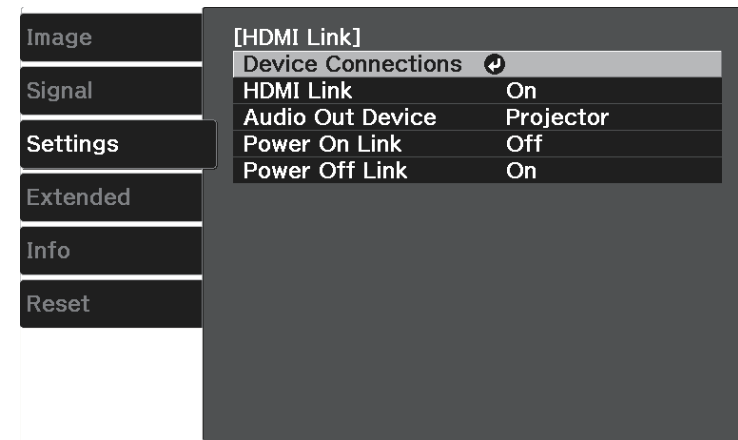

- 8** Press or to exit the menus.

You can use the projector's remote control to control the linked device such as playback, stop, or adjust the volume.



- When you are using smart speakers connected to the projector, make sure you select the following settings to operate the speakers smoothly.
  - **HDMI Link: On**
  - **Power On Link: Bidirectional** or **Device -> PJ**
  - **Power Off Link: On**
  - **USB Power: Always On**  
**Extended > Operation > USB Power**

## » Related Links

- "Projector Feature Settings - Settings Menu" [p.70](#)

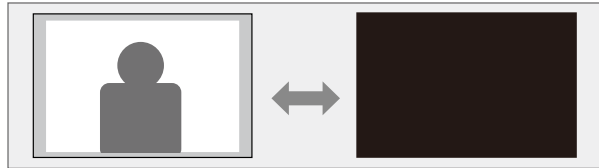
You can temporarily turn off the projected image and sound. Any sound or video action continues to run, however, so you cannot resume projection at the point that you stopped it.



- 1** Press the  button on the remote control.  
The projected image and sound are interrupted.
- 2** To turn the image and sound back on, press  again.

You can secure your projector to deter theft or prevent unintended use by setting up the following security features:

- Child lock to disable the power button on the projector to prevent children from turning on the projector.
- Security cabling to physically secure the projector in place.

#### » Related Links

- "Using the Child Lock Feature" p.63
- "Installing a Security Cable" p.63

## Using the Child Lock Feature

You can use the Child Lock feature to prevent children from turning on the projector without adult supervision. However, because the remote control can still be used to perform operations, keep it out of children's reach.

**1** Press the  button on the remote control.

**2** Select the **Settings** menu and press [Enter].

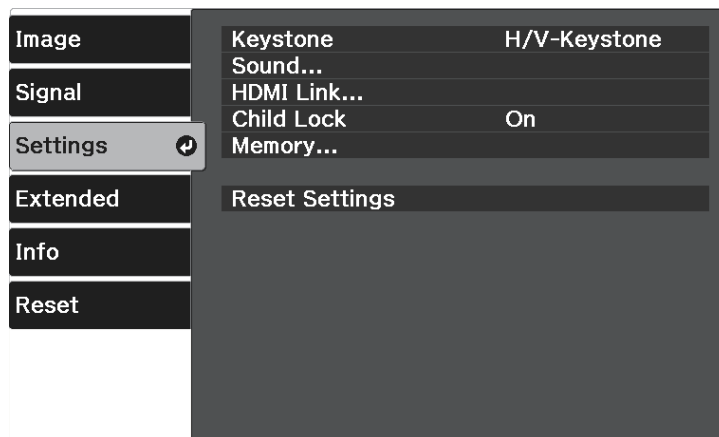

**3** Select **On** as the **Child Lock** setting.



- To turn the projector on, you must press the power button for longer than three seconds.
- **Child Lock** does not prevent the projector from turning on when the power cord is connected if the **Direct Power On** setting is set to **On** in the projector's **Extended** menu.  
☛ **Extended > Operation > Direct Power On**

**4** If you see a confirmation prompt, select **Yes** and press [Enter].

**5** Restart the projector to apply the **Child Lock** setting.

#### » Related Links

- "Projector Feature Settings - Settings Menu" p.70

## Installing a Security Cable

You can use the security slot on the projector to attach a Kensington Microsaver Security system as a theft deterrent.



For more details on the Microsaver Security System, see <http://www.kensington.com/>.

# Adjusting the Menu Settings



Follow the instructions in these sections to access the projector menu system and change projector settings.

## ► Related Links

- ["Using the Projector's Menus" p.65](#)
- ["Using the Displayed Keyboard" p.66](#)
- ["Image Quality Settings - Image Menu" p.67](#)
- ["Input Signal Settings - Signal Menu" p.69](#)
- ["Projector Feature Settings - Settings Menu" p.70](#)
- ["Projector Setup Settings - Extended Menu" p.72](#)
- ["Projector Information Display - Info Menu" p.74](#)
- ["Projector Reset Options - Reset Menu" p.76](#)



You can use the projector's menus to adjust the settings that control how your projector works. The projector displays the menus on the screen.

**8** Press  or  to exit the menus.

- 1** Press the  button on the remote control.  
You see the menu screen displaying the **Image** menu settings.

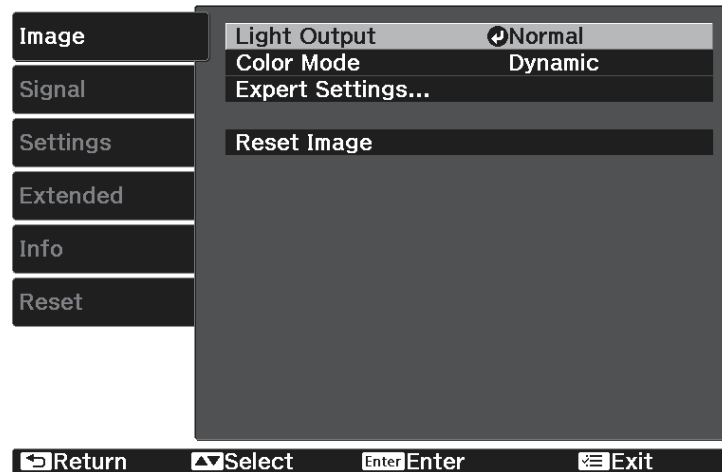

- 2** Press the up or down arrow buttons to move through the menus listed on the left. The settings for each menu are displayed on the right.
- 3** To change settings in the displayed menu, press [Enter].
- 4** Press the up or down arrow button to move through the settings.
- 5** Change the settings using the buttons listed on the bottom of the menu screens.
- 6** To return all the menu settings to their default values, select **Reset**.
- 7** When you finish changing settings on a menu, press .

You can use the displayed keyboard to enter numbers and characters.

- 1 Use the arrow buttons on the remote control to highlight the number or character you want to enter and press the [Enter] button.

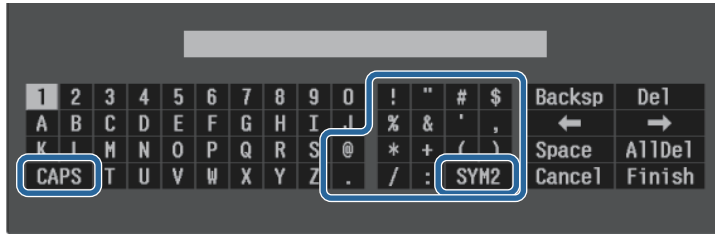

 Each time you select the **CAPS** key, the characters change between upper case and lower case. Each time you select the **SYM1/2** key, the symbols enclosed by the frame change.

- 2 After entering the text, select **Finish** on the keyboard to confirm your entries. Select **Cancel** to cancel entering text.

» **Related Links**

- "Available Text Using the Displayed Keyboard" [p.66](#)

## Available Text Using the Displayed Keyboard

You can enter the following text when using the displayed keyboard.

Text type	Details
Symbols	!"#\$%&'()*+,-./:;<=>?@[ \ ] ^_`{ }~

Text type	Details
Numbers	0123456789
Alphabet	ABCDEFGHIJKLMNOPQRSTUVWXYZ Z abcdefghijklmnopqrstuvwxyz

Settings on the **Image** menu let you adjust the quality of your image for the input source you are currently using. The available settings depend on the currently selected input source.

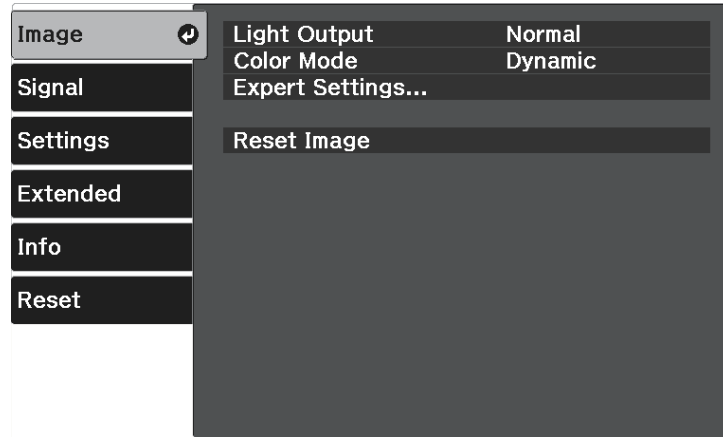

To change settings for an input source, make sure the source is connected and select that source.

Setting	Options	Description
Light Output	High Standard ECO	Selects the brightness mode of the projector lamp.
Color Mode	See the list of available color modes.	Adjusts the vividness of image colors for various image types and environments.
Expert Settings	Brightness	Lightens or darkens the overall image.
	Contrast	Adjusts the difference between light and dark areas of the image.
	Color Saturation	Adjusts the intensity of the image colors.
	Tint	Adjusts the balance of green to magenta tones in the image.

Setting	Options	Description
	Sharpness	Adjusts the sharpness or softness of image details.
	White Balance	Adjusts the overall tint of the image. <ul style="list-style-type: none"> <li>• <b>Color Temp.:</b> sets the color temperature according to the color mode you selected. Higher values tint the image blue and lower values tint the image red.</li> <li>• <b>Custom:</b> adjusts the individual R (red), G (green), and B (blue) components of the offset and gain.</li> </ul>
	Frame Interpolation	Adjusts the smoothness of image movement.
	Image Enhancement	Adjusts the perceived resolution of the image:
		<b>4K Enhancement:</b> projects an image at a doubled resolution by diagonally shifting 1 pixel in increments of 0.5 pixels. A high-resolution image signal is projected in fine detail.
		<b>Image Preset Mode:</b> selects the settings prepared in advance as the settings for <b>Noise Reduction</b> , <b>MPEG Noise Reduction</b> , and <b>Detail Enhancement</b> .
		<b>Noise Reduction:</b> reduces flickering in images.
		<b>MPEG Noise Reduction:</b> reduces the noise or artifacts seen in MPEG video.
		<b>Detail Enhancement:</b> creates a more emphatic texture and material feel of the image.
	Scene Adaptive Gamma	Adjusts the coloring according to the scene, and obtains a more vivid image. Higher values enhance the more the contrast.

Setting	Options	Description
	Gamma	Adjusts the coloring by selecting one of the gamma correction values, or referring to a gamma graph.
	RGBCMY	Adjusts the hue, saturation, and brightness of each color R (red), G (green), B (blue), C (cyan), M (magenta), Y (yellow) individually.
	Auto Iris	Adjusts the projected luminance based on the image brightness.
Reset Image	—	Resets all adjustment values on the <b>Image</b> menu for the selected color mode to their default settings.



The **Brightness** setting does not affect lamp brightness. To change the lamp brightness mode, use the **Light Output** setting.

» **Related Links**

- "Available Color Modes" [p.45](#)
- "Adjusting the Image Quality" [p.46](#)
- "Adjusting the Image Color" [p.51](#)

Normally the projector automatically detects and optimizes the input signal settings. If you need to customize the settings, you can use the **Signal** menu. The available settings depend on the currently selected input source.

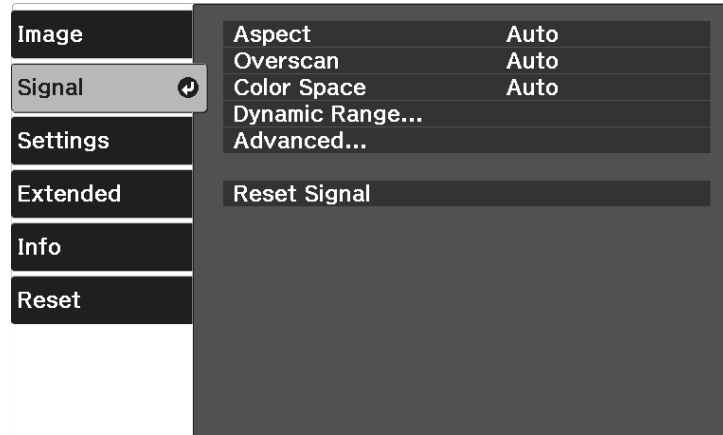

To change settings for an input source, make sure the source is connected and select that source.

Setting	Options	Description
Aspect	See the list of available aspect ratios.	Sets the aspect ratio (width-to-height ratio) for the selected input source.
Overscan	Auto Off 4% 8%	Changes the projected image ratio to make the edges visible by a selectable percentage or automatically.
Color Space	Auto BT.709 BT.2020	Sets the conversion system for the color space.
Dynamic Range	Dynamic Range	Changes the range of dark and bright areas in images; choose from <b>Auto</b> (recommended), <b>SDR</b> , <b>HDR10</b> , or <b>HLG</b> .
	Signal Status	Displays the detected input image signal.

Setting	Options	Description
	HDR10 Setting	Changes the PQ (Perceptual Quantizer) curve of the dynamic range using the HDR PQ method.  This setting is only displayed when <b>Signal Status</b> is <b>HDR10</b> , or <b>Dynamic Range</b> is set to <b>HDR10</b> .
	HLG Setting	Changes the HLG (Hybrid Log Gamma) curve of the dynamic range using the HDR HLG method.  This setting is only displayed when <b>Signal Status</b> is <b>HLG</b> , or <b>Dynamic Range</b> is set to <b>HLG</b> .
Advanced	Video Range	Sets the video range to match the setting of the device connected to the HDMI port.
	EDID	Describes the display capabilities of your projector. If images are not displayed correctly, you may be able to display them correctly by changing this setting.
	Image Processing	Improves the response speed for images projected at high speed. <ul style="list-style-type: none"> <li>• <b>Fast</b>: increases image processing speed.</li> <li>• <b>Fine</b>: increases image quality.</li> </ul>
Reset Signal	—	Resets all adjustment values on the <b>Signal</b> menu to their default settings.

» **Related Links**

- "Available Image Aspect Ratios" [p.43](#)

Options on the **Settings** menu let you customize various projector features.

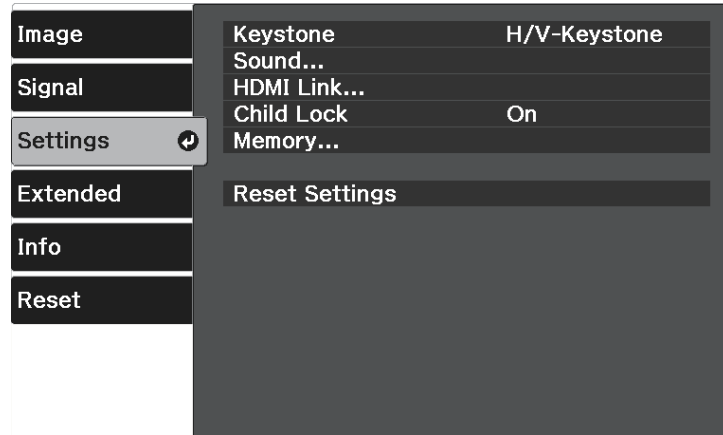

Setting	Options	Description
Keystone		Adjusts image shape to rectangular (horizontally and vertically).
	H/V-Keystone	<ul style="list-style-type: none"> <li>• <b>V-Keystone:</b> lets you manually correct vertical side.</li> <li>• <b>H-Keystone:</b> lets you manually correct horizontal side.</li> <li>• <b>Auto V-Keystone:</b> turns automatic correction on or off.</li> <li>• <b>H-Keystone Adjuster:</b> enables or disables the projector's horizontal keystone slider.</li> </ul>
	Quick Corner	Select to correct image shape and alignment using an on-screen display.
Sound	Volume	Adjusts the volume of the projector's speaker system.
	Sound Mode	Select your favorite mode for sound output from the projector's speaker system according to the playback contents.

Setting	Options	Description
HDMI Link		Adjusts the HDMI Link options:
	Device Connections	Lists the devices connected to the HDMI ports.
	HDMI Link	Enables or disables the HDMI Link features.
	Audio Out Device	Selects whether to output audio from the internal speakers or a connected audio/video system.
	Power On Link	Controls what happens when you turn on the projector or connected device. <ul style="list-style-type: none"> <li>• <b>Off:</b> turns off the power link.</li> <li>• <b>Bidirectional:</b> automatically turns on the connected device when you turn on the projector, and vice versa.</li> <li>• <b>Device -&gt; PJ:</b> automatically turns on the projector when you turn on the connected device.</li> <li>• <b>PJ -&gt; Device:</b> automatically turns on the connected device when you turn on the projector.</li> </ul>
	Power Off Link	Controls whether connected devices are turned off when you turn off the projector.
Child Lock	On Off	Locks the power button on the projector to prevent children from turning the projector on by accident.
Memory	Load Memory Save Memory Erase Memory Rename Memory	Saves customized settings to the projector's memory.

Setting	Options	Description
Reset Settings	—	Resets all adjustment values on the <b>Settings</b> menu to their default settings, except for the following: <ul style="list-style-type: none"><li>• <b>Audio Out Device</b></li><li>• <b>Power On Link</b></li><li>• <b>Power Off Link</b></li><li>• <b>Memory</b></li></ul>

Settings on the **Extended** menu let you customize various projector setup features.

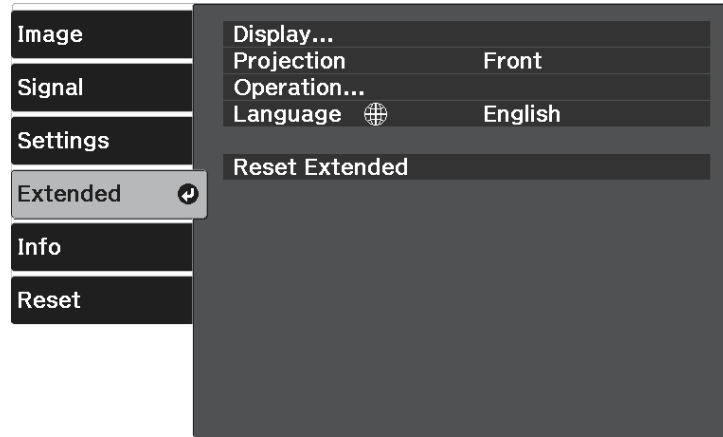

Setting	Options	Description
Display		Selects various display options:
	Messages	Set to <b>On</b> to display messages such as input source name, color mode name, aspect ratio, no signal message, or high temperature warning on your projected image. Set to <b>Off</b> if you do not want to display messages.
	Display Background	Sets the screen color or logo to display when no signal is received.
	Startup Screen	Set to <b>On</b> to display a logo when the projector starts up.
	Panel Alignment	Manually corrects color misalignment in the projected image. <b>Panel Alignment:</b> Set to <b>On</b> to correct color misalignment in the projected image. <b>Select Color:</b> selects the color to correct.

Setting	Options	Description
		<b>Pattern Color:</b> selects the pattern used for correction. <b>Start Adjustments:</b> starts panel alignment. <b>Memory:</b> manages saving and loading of the color convergence in the projected image you have adjusted. <ul style="list-style-type: none"> <li>• <b>Save Memory:</b> saves your current <b>Panel Alignment</b> settings to the projector's memory (three memories with different names are available).</li> <li>• <b>Load Memory:</b> overwrites your current <b>Panel Alignment</b> settings with saved settings.</li> <li>• <b>Rename Memory:</b> renames a saved memory.</li> <li>• <b>Erase Memory:</b> erases the selected memory settings.</li> </ul> <b>Reset:</b> resets all adjustment values on the <b>Panel Alignment</b> setting to their default settings.
Projection	Front Front/Ceiling Rear Rear/Ceiling	Selects the way the projector faces the screen so the image is oriented correctly.
Operation		Selects various operation options:
	Direct Power On	Lets you turn on the projector by plugging it in without pressing the power button.
	Sleep Mode	Set to <b>On</b> to automatically turn off the projector after an interval of inactivity.
	Sleep Mode Timer	Sets the interval for Sleep Mode.
	Illumination	Turns off the indicators on the projector.



Setting	Options	Description
	High Altitude Mode	Regulates the projector's operating temperature at altitudes above 1,500 m.
	USB Power	<p><b>Always On:</b> continues supplying power to the streaming media player connected to the projector even when it is not projecting images.</p> <p><b>On While Projecting:</b> supplies power to the streaming media player only when the projector is projecting images.</p>
Language	Various languages available	Select the language for projector menu and message displays.
Reset Extended	—	<p>Resets all adjustment values on the <b>Extended</b> menu to their default settings, except for the following:</p> <ul style="list-style-type: none"> <li>• <b>Projection</b></li> <li>• <b>High Altitude Mode</b></li> <li>• <b>USB Power</b></li> <li>• <b>Language</b></li> </ul>

You can display information about the projector and version by viewing the **Info** menu. However, you cannot change any settings in the menu.



## Info Menu - Projector Info Menu

You can display information about the projector and input sources by viewing the **Projector Info** menu in the projector's **Info** menu.

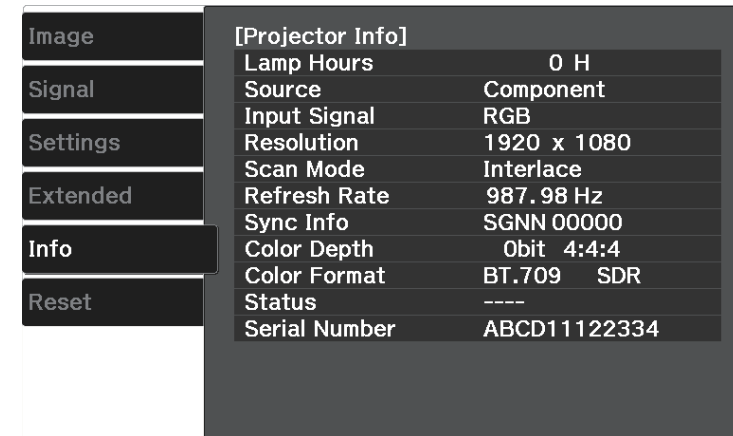

Information item	Description
Projector Info	Displays the projector information.
Version	Displays the projector's firmware version.

### ► Related Links

- "Info Menu - Projector Info Menu" [p.74](#)

Information item	Description
Lamp Hours	Displays the number of hours (H) the lamp has been used; if the information is displayed in yellow, obtain a genuine Epson replacement lamp soon.
Source	Displays the name of the port to which the current input source is connected.
Input Signal	Displays the input signal setting of the current input source.
Resolution	Displays the resolution of the current input source.
Scan Mode	Displays the scan mode (progressive or interlaced).
Refresh Rate	Displays the refresh rate of the current input source.
Sync Info	Displays information that may be needed by a service technician.
Color Depth	Displays the color depth and color difference.

Information item	Description
Color Format	Displays information on the <b>Color Space</b> and <b>Dynamic Range</b> .
Status	Displays information about projector problems that may be needed by a service technician.
Serial Number	Displays the projector's serial number.

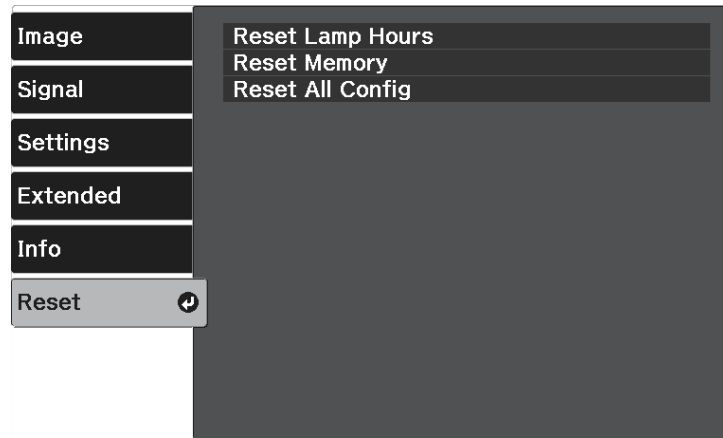

Setting	Options	Description
Reset Lamp Hours	—	Reset the projector's lamp usage timer to zero when you replace the lamp.
Reset Memory	—	Resets the name and settings of a saved memory.
Reset All Config	—	Resets most of the projector settings to their default values.

You cannot reset the following settings using the **Reset All Config** option:

- Memory
- Panel Alignment
- Language

# Maintaining the Projector

Follow the instructions in these sections to maintain your projector.

## ► Related Links

- "Projector Maintenance" [p.78](#)
- "Cleaning the Lens" [p.79](#)
- "Cleaning the Projector Case" [p.80](#)
- "Air Filter and Vent Maintenance" [p.81](#)
- "Projector Lamp Maintenance" [p.83](#)
- "Disconnecting a Streaming Media Player" [p.87](#)
- "Adjusting the Color Convergence (Panel Alignment)" [p.90](#)

You may need to clean the projector's lens periodically, and clean the air filter and air vents to prevent the projector from overheating due to blocked ventilation.

The only parts you should replace are the lamp, air filter, and remote control batteries. If any other part needs replacing, contact Epson or an authorized Epson servicer.

## **Warning**

Before cleaning any part of the projector, turn it off and unplug the power cord. Never open any cover on the projector, except as specifically explained in this manual. Dangerous electrical voltages in the projector can injure you severely.

Clean the projector's lens periodically, or whenever you notice dust or smudges on the surface.

- To remove dust or smudges, gently wipe the lens with clean and dry lens-cleaning paper.
- If the lens is dusty, blow off dust using a blower, and then wipe the lens.

## **Warning**

- Before cleaning the lens, turn off the projector and unplug the power cord.
- Do not use any flammable gas sprays such as air dusters to blow off dust. The high heat generated by the projector may cause a fire.

## **Attention**

- Do not wipe the lens right after you turn off the projector. Doing so could damage the lens.
- Do not use any harsh materials to clean the lens and do not subject the lens to any impacts; otherwise, it could be damaged.

Before cleaning the projector case, turn off the projector and unplug the power cord.

- To remove dust or dirt, use a soft, dry, lint-free cloth.
- To remove stubborn dirt, use a soft cloth moistened with water and mild soap. Do not spray liquid directly on the projector.

### **Attention**

Do not use wax, alcohol, benzene, paint thinner, or other chemicals to clean the projector case. These can damage the case. Do not use canned air, or the gases may leave a flammable residue.



Regular filter maintenance is important to maintain your projector. If dust collects on the air filter, it can cause the internal temperature of the projector to rise, and this can lead to problems with operation and shorten the optical engine's service life. It is recommended that you clean the air filter at least once every three months. Clean them more often than this if using the projector in a particularly dusty environment.

## » Related Links

- "Cleaning the Air Filters and Intake Vents" [p.81](#)
- "Replacing the Air Filter" [p.81](#)

## Cleaning the Air Filters and Intake Vents

You need to clean the projector's air filters in the following situations:

- The filter or vents get dusty.
- The projector's Temp indicator turns or flashes orange.

- 1** Turn off the projector and unplug the power cord.
- 2** Carefully remove the dust using a vacuum cleaner or a brush.

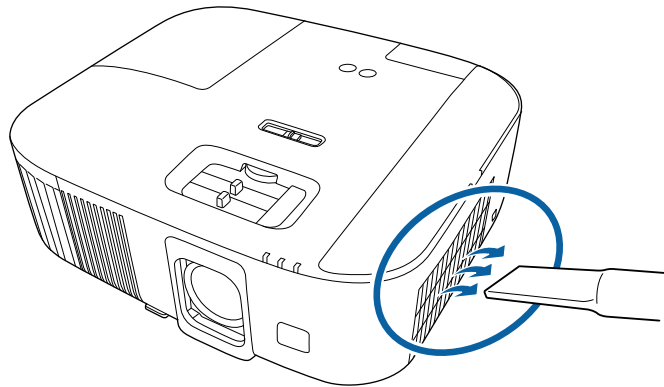

## Attention

- If you have not connected the streaming media player, disconnect the HDMI cable and the power supply USB cable from the projector. Otherwise, when cleaning the air filter, the ports of the cables may get dusty, resulting in a malfunction.
- Do not rinse the air filter in water, or use any detergent or solvent to clean it.
- Do not vacuum the air filter. Doing so could damage the filter.
- Do not use canned air. The gases may leave a flammable residue or push dust and debris into the projector's optics or other sensitive areas.
- If dust is difficult to remove or the air filter is damaged, replace the air filter.

## Replacing the Air Filter

You need to replace the air filter in the following situations:

- The air filter is torn or damaged.

- 1** Turn off the projector and unplug the power cord.
- 2** Open the air filter cover.

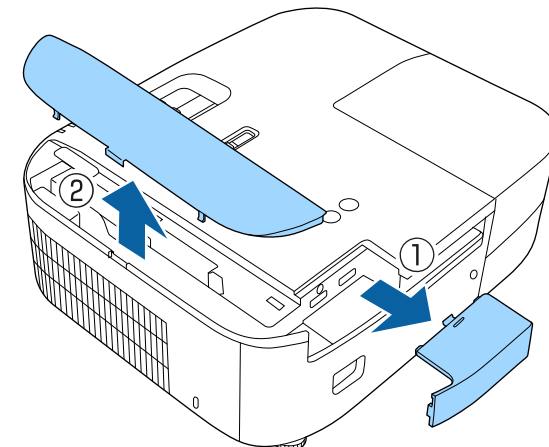

**3** Pull the air filter out of the projector.

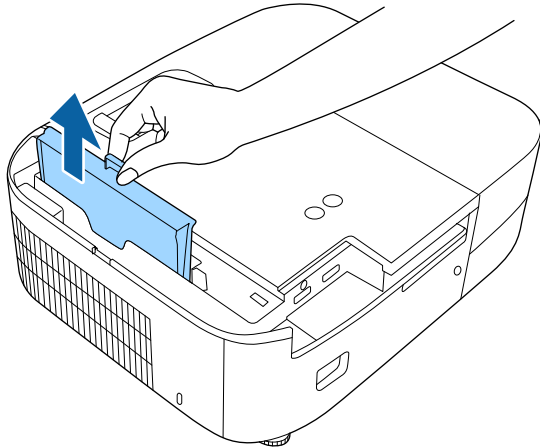

**5** Close the air filter cover.

» **Related Links**

- "Replacement Parts" [p.104](#)



Dispose of used air filters according to local regulations.

- Filter frame: ABS
- Filter: Polyurethane foam

**4** Place the new air filter in the projector as shown and push gently until it clicks into place.

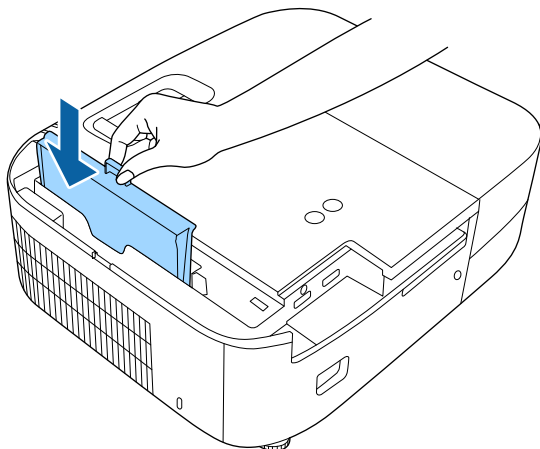

The projector monitors the number of hours the lamp is used and displays this information in the projector's menu system.

Replace the lamp as soon as possible when the following occurs:

- The projected image gets darker or quality declines
- A message is displayed when you turn on the projector telling you to replace the lamp (the message is displayed 100 hours before the expected end of the lamp life and appears for 30 seconds)



- The projector's power indicator is flashing blue and its lamp indicator is flashing orange.

## Attention

- If you continue to use the lamp after the replacement period has passed, the possibility that the lamp may explode increases. When the lamp replacement message appears, replace the lamp with a new one as soon as possible, even if it is still working.
- Do not repeatedly turn off the power and then immediately turn it back on. Turning the power on and off frequently may shorten the lamp's operating life.
- Depending on the characteristics of the lamp and the way it has been used, the lamp may become darker or stop working before the lamp warning message appears. You should always have a spare lamp unit ready in case it is needed.
- We recommend the use of genuine Epson replacement lamps. The use of non-genuine lamps may affect projection quality and safety. Any damage or malfunction caused by the use of non-genuine lamps may not be covered by Epson's warranty.

## » Related Links

- "Replacing the Lamp" [p.83](#)

- "Resetting the Lamp Timer" [p.86](#)
- "Projector Specifications" [p.108](#)
- "Projector Indicator Status" [p.94](#)

## Replacing the Lamp

You can replace the lamp while the projector is placed on a table or mounted to the ceiling.

### Warning

- Let the lamp fully cool before replacing it to avoid injury.
- Never disassemble or modify the lamp. If a modified or disassembled lamp is installed in the projector, it could cause a fire, electric shock, or other damage or injury.

- 1** Turn off the projector and unplug the power cord.
- 2** Allow the projector lamp to cool down for at least one hour.
- 3** Use the screwdriver included with the replacement lamp to loosen the screw securing the lamp cover.

## Warning

When replacing the lamp, there is a possibility that the lamp may be broken. If replacing the lamp of a projector which has been installed on the ceiling, you should always assume that the lamp is cracked, and you should stand to the side of the lamp cover, not underneath it. Remove the lamp cover gently. Be careful when removing the lamp cover as shards of glass may fall out and could cause an injury. If any shards of glass get into your eyes or mouth, contact a doctor immediately.

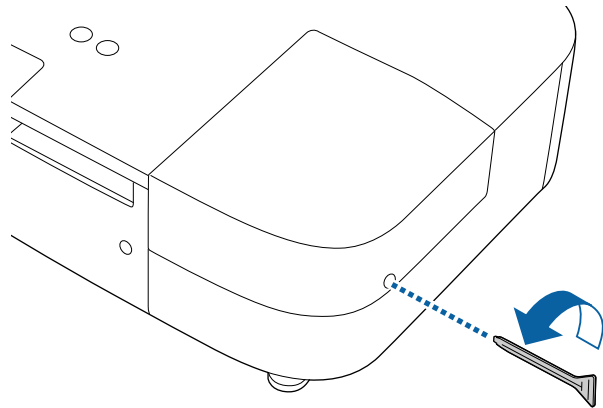

**4** Slide the lamp cover out and lift it off.

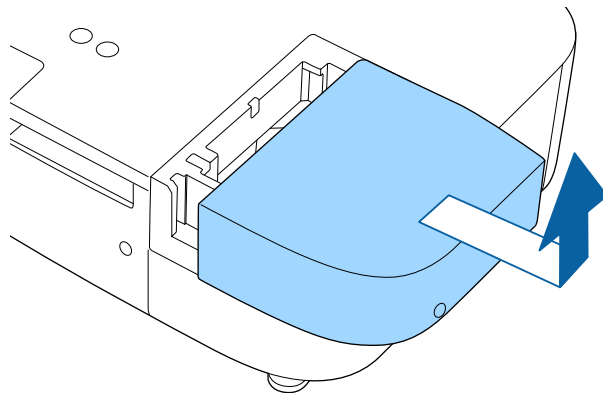

**5** Loosen the screws securing the lamp to the projector. The screws do not come all the way out.

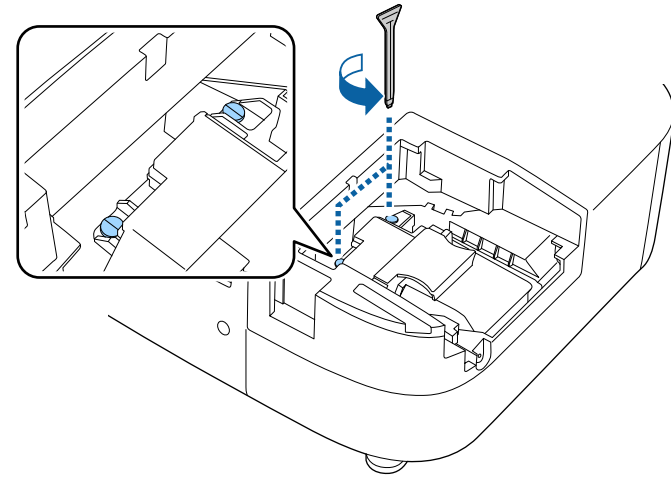

**6** Grip the raised section of the lamp and remove it.

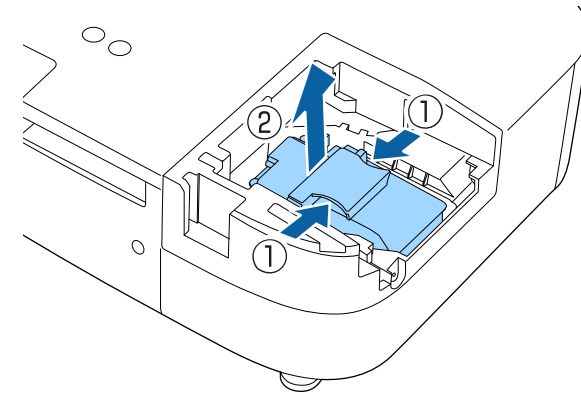



- If you notice the lamp is cracked when removing the lamp, contact Epson for help.
- The lamp(s) in this product contain mercury (Hg). Check your local laws and regulations regarding disposal or recycling. Do not put in the trash.

**7** Gently insert the new lamp into the projector. If it does not fit easily, make sure it is facing the right way.

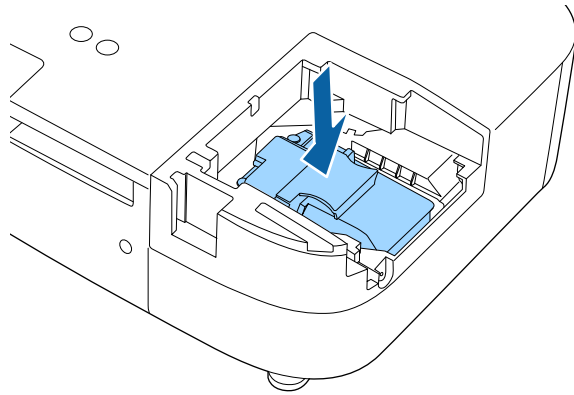

**Attention**

Do not touch any glass on the lamp assembly to avoid premature lamp failure.

**8** Push in the lamp firmly and tighten the screws to secure it.

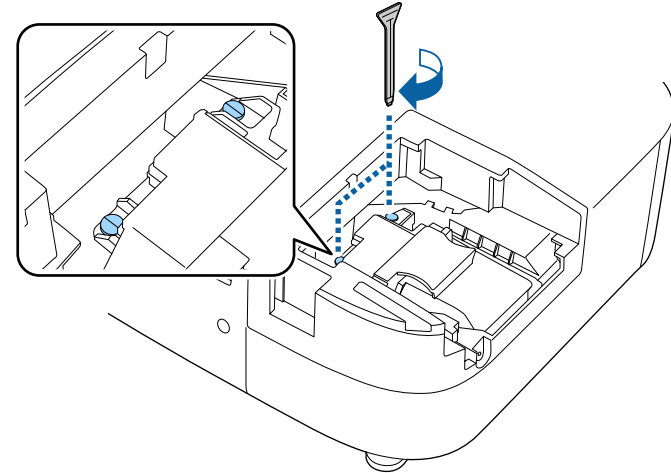

**9** Replace the lamp cover and tighten the screw to secure it.

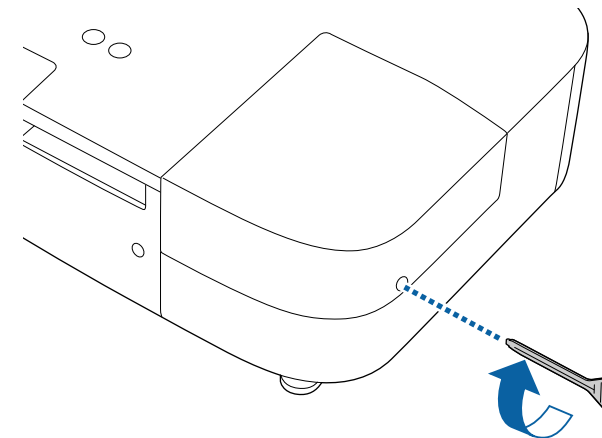



- Make sure the lamp cover is securely installed or the lamp will not turn on.
- Do not replace the lamp cover with too much force and make sure the lamp cover is not deformed.

Reset the lamp timer to zero to monitor the new lamp's usage.

## » Related Links

- "Replacement Parts" [p.104](#)

---

## Resetting the Lamp Timer

You must reset the lamp timer after replacing the projector's lamp to clear the lamp replacement message and to monitor lamp usage correctly.





Do not reset the lamp timer if you have not replaced the lamp to avoid inaccurate lamp usage information.

- 1** Turn on the projector.
- 2** Press the  button, select the **Reset** menu, and press [Enter].

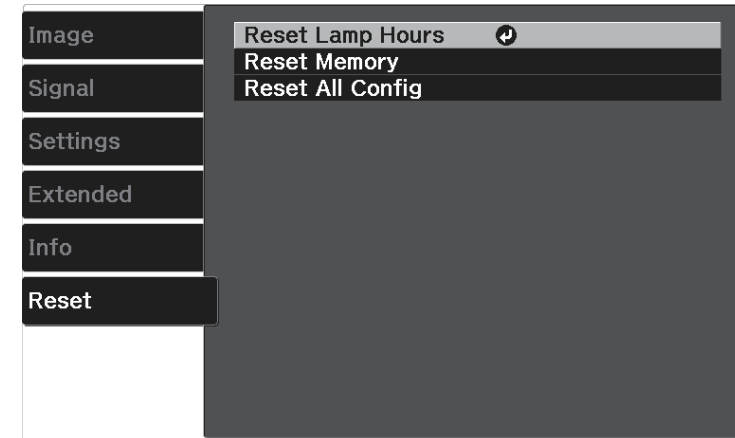
- 3** Select **Reset Lamp Hours** and press [Enter].



You see a prompt asking if you want to reset the lamp hours.

- 4** Select **Yes** and press [Enter].
- 5** Press  or  to exit the menus.

Follow the steps below to disconnect the Epson streaming media player (ELPAP12) installed in the projector.

- 1** Remove the rear cover and air filter cover from the projector.

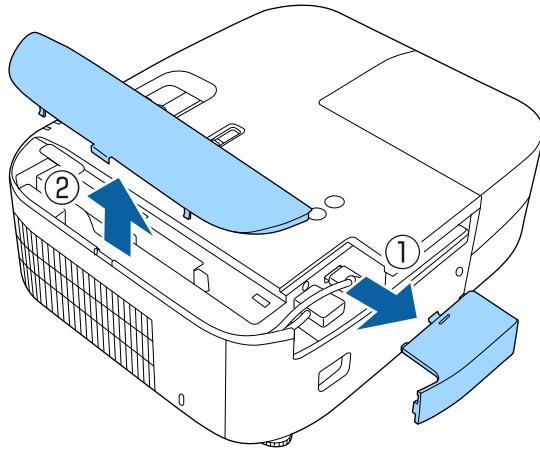

- 2** Pull out the streaming media player.

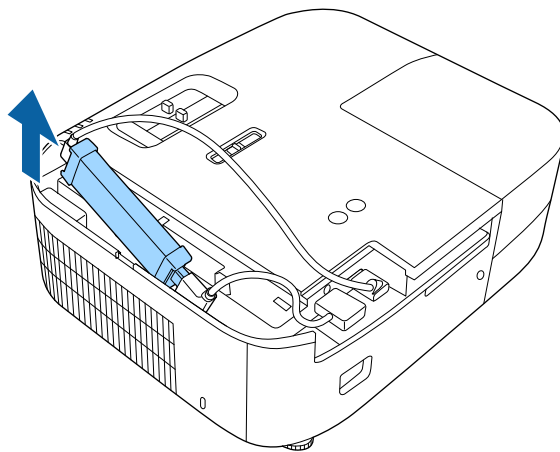

- 3** Disconnect the HDMI cable and power supply USB cable.

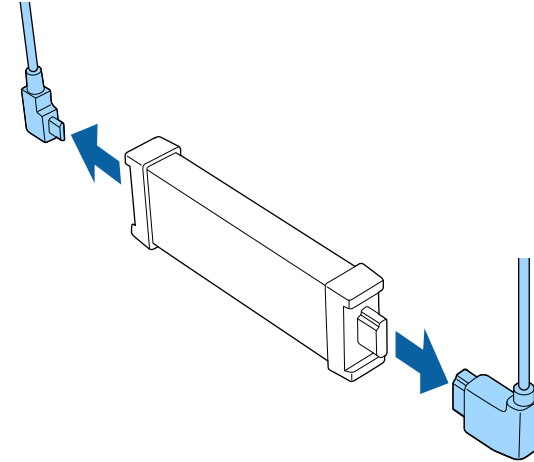

### Attention

If you have not connected the streaming media player, disconnect the HDMI cable and the power supply USB cable from the projector. Otherwise, the ports of the cables may get dusty, resulting in a malfunction.



If the built-in streaming media player is sent for repairs, it may be reset when it is returned. Make sure you save any account information for your online services before sending it for repairs.









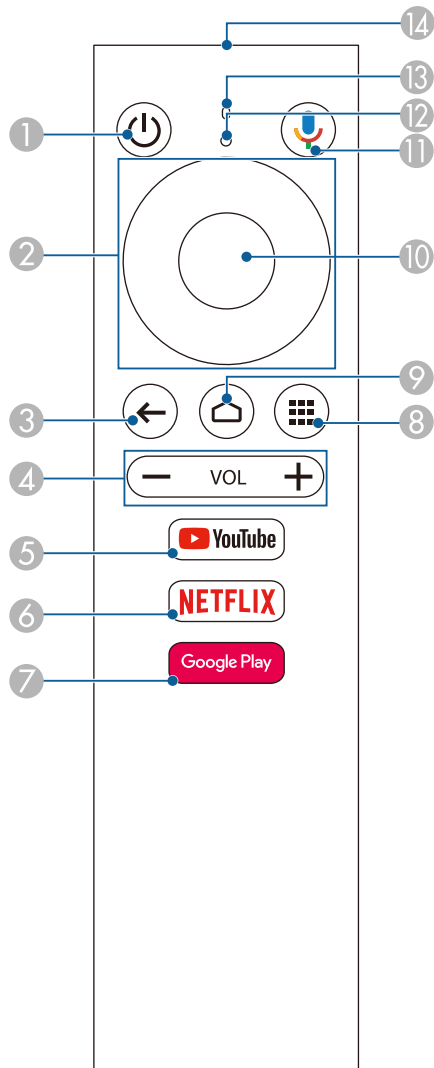

### » Related Links

- "Remote Control for Streaming Media Player" [p.88](#)
- "Pairing the Remote Control for the Streaming Media Player" [p.89](#)

## Remote Control for Streaming Media Player

You can use this remote control to operate the Epson streaming media player (ELPAP12) when it is connected to any video device other than this projector.





Name	Function
① Power button 	Turns the Epson streaming media player on or off.
② Directional pad 	Selects menu items.
③ Esc button 	Moves back to the previous menu level.
④ Volume up/down buttons 	Adjusts the volume for the Epson streaming media player.
⑤ YouTube button 	Starts the YouTube application.
⑥ Netflix button 	Starts the Netflix application.
⑦ Google Play button 	Opens Google Play.
⑧ Applications button 	Displays a list of the applications.
⑨ Home button 	Displays the Android TV home screen.
⑩ Enter button 	Enters the current selection and moves to the next level.



Name	Function
① Google Assistant button 	Allows you to quickly search 400,000+ movies and shows, get recommendations to match your mood, control smart home devices, and more.
⑫ Indicator	Turns on when outputting signals from the remote control.
⑬ Microphone	Detects audio when you press the Google Assistant button.
⑭ Remote control light emitting area	Outputs remote control signals.

## Pairing the Remote Control for the Streaming Media Player

When you connect the Epson streaming media player (ELPAP12) to any video device other than this projector, follow the steps below to pair the remote control for the streaming media player with the ELPAP12.

- 1 Press the  button on the projector remote control to open the Android TV home screen.
- 2 Select  at the top right of the Android TV home screen > **Remote & accessories** > **Add accessory** using the projector remote control.

- 3 Press the [Enter] button and  button on the remote control for the streaming media player at the same time to enter pairing mode.

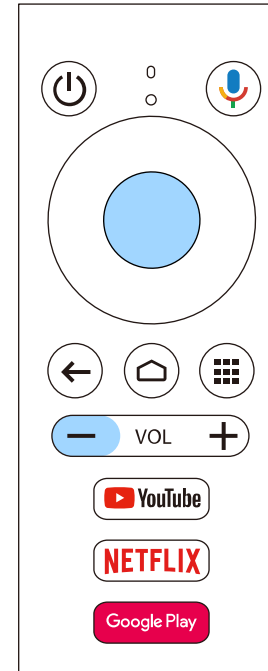

When pairing starts, the indicator on the remote control for the streaming media player flashes. When pairing is complete, the indicator turns off.

- 4 Select **EPSON ATV REMOTE** displayed on the screen using the remote control for the streaming media player to perform pairing.

You can use the Panel Alignment feature to manually adjust the color convergence (the alignment of the red and blue colors) in the projected image. You can adjust the pixels horizontally and vertically in increments of 0.125 pixels within a range of  $\pm 3$  pixels.



- You can adjust only the red or blue color convergence. Green is the standard color panel and cannot be adjusted.
- Image quality may decline after performing Panel Alignment.
- Images for pixels that extend beyond the edge of the projected screen are not displayed.

**1** Press the  button on the remote control, select the **Extended** menu, and then press [Enter].

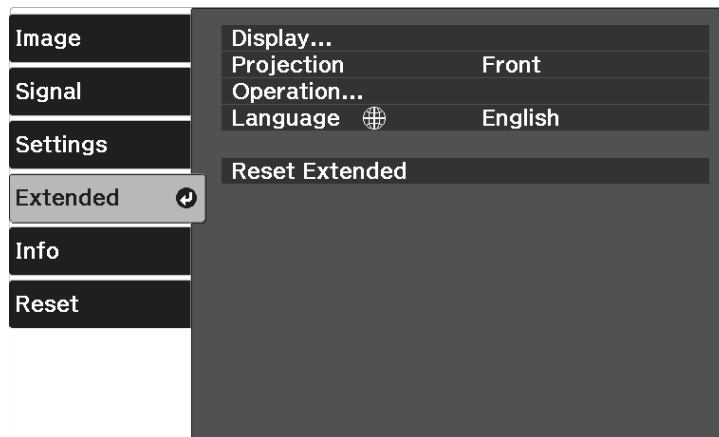

**2** Select **Display > Panel Alignment** and press [Enter].

**3** Select **Panel Alignment** and set it to **On**.

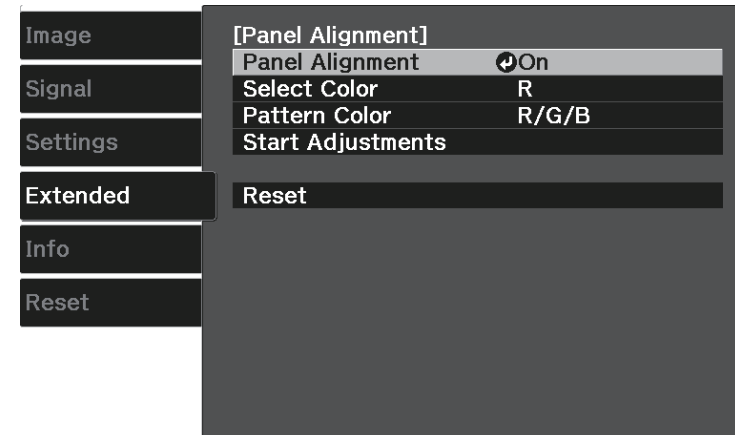

**4** Select **Select Color** and choose one of the following:

- **R** to adjust the red color convergence.
- **B** to adjust the blue color convergence.

**5** Select **Pattern Color** and choose the grid color displayed when making adjustments. The available color varies depending on the **Select Color** setting.

- **R/G/B** to display the grid color in white.
- **R/G** to display the grid color in yellow.
- **G/B** to display the grid color in cyan.

**6** Select **Start Adjustments** and press [Enter].

**7** Select one of the following options:

- Select **Shift the whole panel** to adjust the entire panel at the same time and go to the next step.
- Select **Adjust the four corners** to adjust the corners of the panel one at a time and go to step 10.

- 8** Use the arrow buttons on the remote control to adjust the color alignment selected in **Select Color**, and then press [Enter].



Adjustment affects the grid lines in the entire screen.

- 9** Select one of the following options:
- Select **Adjust the four corners** to fine-tune your adjustments.
  - Select **Exit** to finish adjustments.
- 10** Use the arrow buttons on the remote control to adjust the color alignment of the screen corner highlighted by the orange box, and then press [Enter].
- 11** When you are finished adjusting each corner of the screen, press [Enter].
- 12** Select one of the following options:
- If your projector needs additional panel alignment, select **Select intersection and adjust**. Use the arrow buttons on the remote control to highlight the corner of any misaligned box on the screen, press [Enter], make any necessary adjustments, and then press [Enter] again. Repeat this step as necessary for the other intersections.
  - Select **Exit** to finish adjustments.
- 13** If you want to save the color convergence in the projected image you have adjusted, select **Memory > Save Memory**.

# Solving Problems

Check the solutions in these sections if you have any problems using the projector.

## ► Related Links

- "Projection Problems" [p.93](#)
- "Projector Indicator Status" [p.94](#)
- "Solving Projector Power-On or Power-Off Problems" [p.96](#)
- "Solving Image Problems" [p.97](#)
- "Solving Sound Problems" [p.100](#)
- "Solving Remote Control Operation Problems" [p.101](#)
- "Solving HDMI Link Problems" [p.102](#)

If the projector is not working properly, turn it off, unplug it, and then plug it back in and turn it on.

If this does not solve the problem, check the following:

- The indicators on the projector may indicate the problem.
- The solutions in this manual can help you solve many problems.

If none of these solutions help, contact Epson for technical support.

The indicators on the projector indicate the projector status and let you know when a problem occurs. Check the status and color of the indicators and then refer to this table for a solution.

 If the indicators display a pattern not listed in the table below, turn the projector off, unplug it, and contact Epson for help.

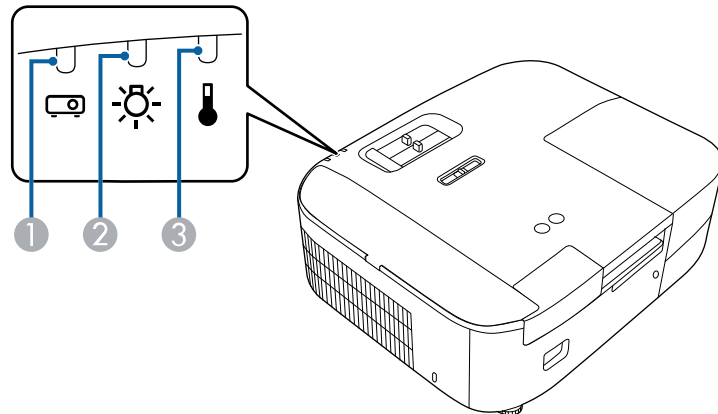

- ① Status indicator
- ② Lamp indicator
- ③ Temp (temperature) indicator

### Projector status

Indicator and status	Problem and solutions
Status: Lit blue Lamp: Off Temp: Off	Normal operation. If you set <b>USB Power</b> to <b>On</b> , the status indicator turns blue even when the projector is in standby mode (when the power is off).  <b>Extended &gt; Operation &gt; USB Power</b>

Indicator and status	Problem and solutions
Status: Flashing blue Lamp: Off Temp: Off	Warming up, shutting down, or cooling down. When warming up, wait about 30 seconds for an image to appear. All buttons are disabled during warm-up, shutting down, and cooling down.
Status: Off Lamp: Off Temp: Off	Standby or sleep mode. When you press the power button, projection starts.
Status: Indicator status varies Lamp: Off Temp: Flashing orange	Projector is too hot. <ul style="list-style-type: none"> <li>Make sure that the vents and air filter are not clogged with dust or obstructed by nearby objects.</li> <li>Clean or replace the air filter.</li> <li>Make sure the environmental temperature is not too hot.</li> </ul>
Status: Off Lamp: Off Temp: Lit orange	Projector has overheated and turned off. Leave it turned off to cool down for 5 minutes. <ul style="list-style-type: none"> <li>Make sure that the vents and air filter are not clogged with dust or obstructed by nearby objects.</li> <li>Make sure the environmental temperature is not too hot.</li> <li>Clean or replace the air filter.</li> <li>If operating the projector at high altitude, set the <b>High Altitude Mode</b> setting to <b>On</b> in the projector's menu.  <b>Extended &gt; Operation &gt; High Altitude Mode</b></li> <li>If the problem persists, unplug the projector and contact Epson for help.</li> </ul>

Indicator and status	Problem and solutions
Status: Off Lamp: Lit orange Temp: Off	Lamp has a problem. <ul style="list-style-type: none"> <li>• Check to see if the lamp is burned out, broken, or installed incorrectly. Reseat or replace the lamp as necessary.</li> <li>• Clean the air filter.</li> <li>• If operating the projector at high altitude, set the <b>High Altitude Mode</b> setting to <b>On</b> in the projector's menu. ☛ <b>Extended &gt; Operation &gt; High Altitude Mode</b></li> <li>• If the problem persists, unplug the projector and contact Epson for help.</li> </ul> Lamp cover has a problem. <ul style="list-style-type: none"> <li>• Check that the lamp and the lamp cover are securely installed. The lamp does not turn on if the lamp and the lamp cover are not installed correctly.</li> </ul>
Status: Indicator status varies Lamp: Flashing orange Temp: Off	Replace the lamp soon to avoid damage. Do not continue using the projector.
Status: Off Lamp: Lit orange Temp: Lit orange	Internal projector error Turn the projector off, unplug it, and contact Epson for help.

» **Related Links**

- "Projector Setup Settings - Extended Menu" [p.72](#)
- "Cleaning the Air Filters and Intake Vents" [p.81](#)
- "Replacing the Air Filter" [p.81](#)
- "Replacing the Lamp" [p.83](#)

Check the solutions in these sections if the projector does not turn on when you press the power button or it turns off unexpectedly.

## » Related Links

- "Solving Projector Power Problems" [p.96](#)
- "Solving Projector Shutdown Problems" [p.96](#)

---

## Solving Projector Power Problems

If the projector does not turn on when you press the power button, try the following steps until the problem is solved.

- 1** Check the following items.
  - If you are using the remote control, check the batteries of the remote control.
  - Make sure the power cord is securely connected to the projector and to a working electrical outlet.
  - Check that you are not using the remote control for the streaming media player. Make sure you are using the projector remote control.
- 2** Unlock the lock feature using the following method.
  - To release **Child Lock**, hold down the power button on the control panel for three seconds.
- 3** Disconnect the cord and contact Epson for help.

## » Related Links

- "Using the Child Lock Feature" [p.63](#)

---

## Solving Projector Shutdown Problems

If the projector turns off unexpectedly, try the following steps until the problem is solved.

- 1** Projectors may have entered sleep mode after a period of inactivity. Perform any operation to wake the projector. To turn off sleep mode, select **Off** as the **Sleep Mode** setting.

## ☛ Extended > Operation > Sleep Mode



When the current input source is **Home**, you cannot change the **Sleep Mode** setting. Press the  button on the remote control to switch the input source to **HDMI**, and then set **Sleep Mode** to **Off**.

- 2** When the temp (temperature) indicator is lit orange, the projector has overheated and turned off.



The cooling fans may run in standby status depending on the projector settings. Also, when the projector wakes from standby status, the fans may cause an unexpected noise. This is not a malfunction.

## » Related Links

- "Projector Setup Settings - Extended Menu" [p.72](#)



Check the solutions in these sections if you have any problems with projected images.

## ► Related Links

- "Solving Missing Image Problems" [p.97](#)
- "Adjusting an Image that is not Rectangular" [p.97](#)
- "Adjusting a Fuzzy or Blurry Image" [p.98](#)
- "Fixing Partial Image Problems" [p.98](#)
- "Adjusting an Image that Contains Noise or Static" [p.98](#)
- "Adjusting an Image with Incorrect Brightness or Colors" [p.99](#)
- "Adjusting an Upside-down Image" [p.99](#)

---

## Solving Missing Image Problems

If no image is displayed, try the following steps until the problem is solved.

### 1 Check the projector's status:

- Press the  button on the remote control to see if the image was temporarily turned off.
- Check the status indicator to confirm that the projector is in normal operating status.
- Press the projector's power button to wake it from standby or sleep mode. Also, check if the connected computer is in sleep mode or displaying a blank screen saver.

☛ **Extended > Operation > Sleep Mode**

### 2 Check the cable connection:

- Make sure all necessary cables are securely connected and the power is on for the projector.
- Connect the video source directly to the projector.
- Replace the HDMI cable with the shorter one.

### 3 Check the status of your video source:

- If you are projecting from a streaming media player, make sure it is powered by the power supply USB cable on the projector.
- Turn on the connected streaming media player or video source, and press the play button to start a video, if necessary.
- Make sure the connected device meets the HDMI CEC standard. See the documentation supplied with the device for more information.
- If you are projecting from a laptop computer, make sure it is set up to display on an external monitor.

### 4 Check the following items:

- Turn off the projector and the connected streaming media player or video source, and then turn them back on.
- Set the CEC function for the connected device again and restart the device.
- Make sure the computer's display resolution does not exceed the projector's resolution and frequency limits. If necessary, select a different display resolution for your computer. (See your computer manual for details.)
- Resets all of the projector settings to their default values.

☛ **Reset > Reset All Config**

## ► Related Links

- "Projector Setup Settings - Extended Menu" [p.72](#)
- "Projector Reset Options - Reset Menu" [p.76](#)

---

## Adjusting an Image that is not Rectangular

If the projected image is not evenly rectangular, try the following steps until the problem is solved.

- ### 1
- Place the projector directly in front of the center of the screen, facing it squarely, if possible.

**2** Adjust the image shape using the **Keystone** settings.

☛ **Settings > Keystone > H/V-Keystone**

☛ **Settings > Keystone > Quick Corner**

## » Related Links

- "Projector Feature Settings - Settings Menu" [p.70](#)
- "Correcting the Image Shape with the Horizontal Keystone Slider" [p.36](#)
- "Correcting the Image Shape with the Keystone Button" [p.37](#)
- "Correcting the Image Shape with Quick Corner" [p.38](#)

---

## Adjusting a Fuzzy or Blurry Image

If the projected image is fuzzy or blurry, try the following steps until the problem is solved.

**1** Adjust the image focus using the focus slider.

**2** Check the following items:

- Position the projector close enough to the screen.
- Position the projector so the keystone adjustment angle is not so wide that it distorts the image.

**3** Clean the projector's lens.



To avoid condensation on the lens after bringing the projector in from a cold environment, let the projector warm up to room temperature before using it.

**4** Adjust the **Sharpness** setting in the projector's **Image** menu to improve image quality.

☛ **Image > Expert Settings > Sharpness**

**5** If you are projecting from a computer, use a lower resolution or select a resolution that matches the projector's native resolution.

## » Related Links

- "Image Quality Settings - Image Menu" [p.67](#)
- "Focusing the Image Using the Focus Slider" [p.41](#)
- "Cleaning the Lens" [p.79](#)

---

## Fixing Partial Image Problems

If only a partial computer image is displayed, try the following steps until the problem is solved.

**1** Adjust the size of the projected image using the zoom slider on the projector.

**2** Make sure you selected the correct projection mode. You can select this using the **Projection** setting in the projector's **Extended** menu.

**3** Check your computer display settings to disable dual display and set the resolution within the projector's limits. (See your computer manual for details.)

## » Related Links

- "Projector Setup Settings - Extended Menu" [p.72](#)

---

## Adjusting an Image that Contains Noise or Static

If the projected image contains electronic interference (noise) or static, try the following steps until the problem is solved.

- 1** Check the cables connecting your video source to the projector. They should be:
  - Separated from the power cord to prevent interference
  - Securely connected at both ends
  - Not connected to an extension cable
- 2** If you adjusted the image shape using the projector controls, try decreasing the **Sharpness** setting in the projector's **Image** menu to improve image quality.
  - ☛ **Image > Expert Settings > Sharpness**
- 3** If you connected an extension power cable, try projecting without it to see if it caused interference in the signal.
- 4** Select a computer video resolution and refresh rate that are compatible with the projector.

#### » Related Links

- "Image Quality Settings - Image Menu" [p.67](#)

---

## Adjusting an Image with Incorrect Brightness or Colors

If the projected image is too dark or bright, or the colors are incorrect, try the following steps until the problem is solved.

- 1** Try different color modes for your image and environment by selecting the **Color Mode** setting in the projector's **Image** menu.
- 2** Check your video source settings.
- 3** Adjust the available settings in the projector's **Image** menu for the current input source, such as **Brightness**, **Contrast**, **Tint**, and **Color Saturation**.

#### ☛ **Image > Expert Settings**

- 4** Make sure you selected the correct **Video Range** setting in the projector's **Signal** menu, if available for your image source.

#### ☛ **Signal > Advanced > Video Range**

- 5** Make sure all the cables are securely connected to the projector and your video equipment. If you connected long cables, try connecting shorter cables.

- 6** Position the projector close enough to the screen.

#### » Related Links

- "Image Quality Settings - Image Menu" [p.67](#)

---

## Adjusting an Upside-down Image



If the projected image is upside-down, select the correct projection mode.

#### ☛ **Extended > Projection**

#### » Related Links

- "Projector Setup Settings - Extended Menu" [p.72](#)

If there is no sound or the volume is too low, try the following steps until the problem is solved.

- 1** Adjust the projector's volume settings using the  or  button on the remote control.



If you have adjusted the volume for your streaming media player using the remote control for the streaming media player, you may also need to adjust the volume again.

- 2** Check the cable connection between the projector and your video source.
- 3** Check the following settings on the projector:
  - Press the  button on the remote control to resume video and audio if they were temporarily stopped.
- 4** Check the following settings on your video equipment:
  - Check your streaming media player or video source to make sure the volume is turned up and the audio output is set for the correct source.
  - Set the connected device to PCM output.
  - When you are connecting the projector to a Mac using an HDMI cable, make sure your Mac supports audio through the HDMI port.

## » Related Links

- "Projector Feature Settings - Settings Menu" [p.70](#)

If the projector does not respond to remote control commands, try the following steps until the problem is solved.



If you lose the remote control, you can order another one from Epson.

- 1** Check that the remote control batteries are installed correctly and have power. If necessary, replace the batteries.
- 2** Check that you are not using the remote control for the streaming media player. Make sure you are using the projector remote control.
- 3** Check to see if a button on the remote control is stuck down, causing it to enter sleep mode. Release the button to wake the remote control up.
- 4** Make sure you are operating the remote control within the reception angle and range of the projector.
- 5** Make sure the projector is not warming up or shutting down.
- 6** Strong fluorescent lighting, direct sunlight, or infrared device signals may be interfering with the projector's remote receivers. Dim the lights or move the projector away from the sun or interfering equipment.
- 7** The streaming media player and the remote control may have been disconnected. Perform pairing again by holding down the  and right arrow buttons on the remote control at the same time for about seven seconds.



To unpair the streaming media player and the remote control, select  > **Remote & accessories** > on the Android TV home screen, select the remote control you want to unpair, and then select **Unpair**.

## » Related Links

- "Remote Control Operation" [p.23](#)

If you cannot operate the connected devices using the HDMI Link features, try the following steps until the problem is solved.

- 1** Make sure the cable meets the HDMI CEC standard.
- 2** Make sure the connected device meets the HDMI CEC standard. See the documentation supplied with the device for more information.
- 3** Check if the device is available in the **Device Connections** list.  
If the device does not appear in the **Device Connections** list, it does not meet the HDMI CEC standards. Connect a different device.  
☛ **Settings > HDMI Link > Device Connections**
- 4** Check that all cables required for HDMI Link are securely connected.
- 5** Make sure the connected devices are turned on and in standby status. See the documentation supplied with the device for more information.
- 6** If you connect a new device or change the connection, set the CEC function for the connected device again and restart the device.

## » Related Links

- "Projector Feature Settings - Settings Menu" [p.70](#)

# Appendix

Check these sections for the technical specifications and important notices about your product.

## ► **Related Links**

- "Optional Accessories and Replacement Parts" [p.104](#)
- "Screen Size and Projection Distance" [p.105](#)
- "Supported Monitor Display Resolutions" [p.107](#)
- "Projector Specifications" [p.108](#)
- "External Dimensions" [p.110](#)
- "Warning Labels" [p.111](#)
- "List of Safety Symbols and Instructions" [p.112](#)
- "Glossary" [p.114](#)
- "Notices" [p.116](#)

The following optional accessories and replacement parts are available. Please purchase these products as and when needed.

The following list of optional accessories and replacement parts is current as of: March 2022.

Details of accessories are subject to change without notice and availability may vary depending on the country of purchase.

## ► Related Links

- "Mounts" [p.104](#)
- "External Devices" [p.104](#)
- "Replacement Parts" [p.104](#)

---

## Mounts

### Ceiling mount ELPMB23

Use when installing the projector on a ceiling.

### Safety Wire Set ELPWR01

Use when connecting the projector to the installation mount to prevent the projector from falling down.

### Ceiling pipe (450 mm) ELPFP13

### Ceiling pipe (700 mm) ELPFP14

Use when installing the projector on a high ceiling.



Special expertise is required to suspend the projector from a ceiling. Contact Epson for help.

---

## External Devices

### Streaming Media Player ELPAP12

Use this streaming media player to watch online content.

---

## Replacement Parts

### Lamp unit ELPLP97

Use as a replacement for used lamps.

### Air filter ELPAF54

Use as a replacement for used air filters.



Check the table here to determine how far to place the projector from the screen based on the size of the projected image.

The maximum lens shift adjustment values are shown in the following table.

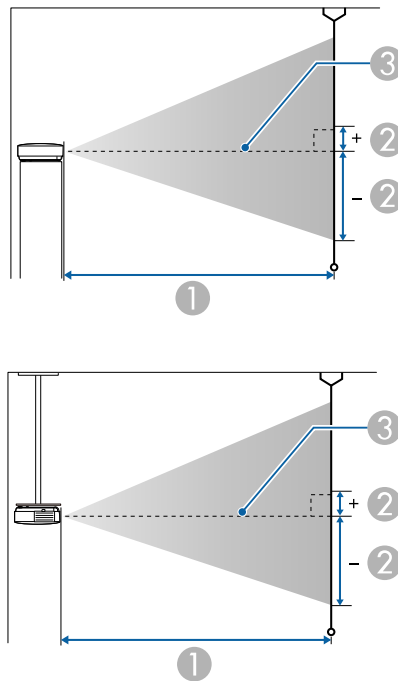

- ① Projection distance (cm)
- ② Distance from the center of the lens to the base of the screen (This changes depending on the setting for vertical lens shift.) (cm)
- ③ Center of lens

16:9 screen size		①	②
		Minimum (Wide) to Maximum (Tele)	Vertical Lens Shift Bottom to Top
60"	133 × 75	175 - 285	-83 - 8
80"	177 × 100	234 - 381	-110 - 11
100"	221 × 125	294 - 477	-138 - 14
120"	266 × 149	353 - 573	-166 - 16
150"	332 × 187	443 - 718	-207 - 20
200"	443 × 249	591 - 958	-276 - 27
300"	664 × 374	888 - 1439	-414 - 41
400"	886 × 498	1186 - 1919	-552 - 54
500"	1107 × 623	1483 - 2400	-690 - 68

4:3 screen size		①	②
		Minimum (Wide) to Maximum (Tele)	Vertical Lens Shift Bottom to Top
33"	67 × 50	117 - 191	-56 - 5
40"	81 × 61	142 - 232	-68 - 7
60"	122 × 91	215 - 350	-101 - 10
80"	163 × 122	288 - 467	-135 - 13
100"	203 × 152	360 - 585	-169 - 17
120"	244 × 183	433 - 703	-203 - 20
150"	305 × 229	542 - 879	-253 - 25
200"	406 × 305	724 - 1173	-338 - 33
300"	610 × 457	1088 - 1761	-507 - 50
400"	813 × 610	1452 - 2349	-676 - 66
408"	829 × 622	1481 - 2396	-689 - 67

16:9 screen size		①	②
		Minimum (Wide) to Maximum (Tele)	Vertical Lens Shift Bottom to Top
40"	89 × 50	115 - 189	-55 - 5

16:10 screen size		①	②
		Minimum (Wide) to Maximum (Tele)	Vertical Lens Shift Bottom to Top
37"	80 × 50	116 - 189	-55 - 5
40"	86 × 54	125 - 205	-60 - 6
60"	129 × 81	189 - 308	-90 - 9
80"	172 × 108	254 - 412	-119 - 12
100"	215 × 135	318 - 516	-149 - 15
120"	258 × 162	382 - 620	-179 - 18
150"	323 × 202	479 - 776	-224 - 22
200"	431 × 269	639 - 1036	-298 - 29
300"	646 × 404	961 - 1555	-448 - 44
400"	862 × 538	1282 - 2075	-597 - 58
462"	995 × 622	1483 - 2399	-690 - 68

See the *Supplemental A/V Support Specification* for detailed information on compatible refresh rates and resolutions for each compatible video display format.

► **Related Links**

- "Getting the Latest Version of the Documents" [p.7](#)

Product name	EH-TW6250
Dimensions	333 (W) × 123 (H) × 275 (D) mm (not including raised section)
LCD panel size	0.61" wide
Display method	Poly-silicon TFT active matrix
Resolution	2,073,600 pixels * Full HD (1,920 (W) × 1,080 (H) dots) × 3
Focus adjustment	Manual
Zoom adjustment	1 to 1.62 (Optical Zoom)
Lamp	UHE lamp, 200 W Model No.: ELPLP97
Lamp life	When <b>Light Output</b> in the <b>Image</b> menu is set to: <b>High:</b> Up to 4,500 hours <b>Standard:</b> Up to 4,500 hours <b>ECO:</b> Up to 7,500 hours
Max. audio output	10 W
Speaker	1
Power supply	100-240V AC±10% 50/60Hz 3.2 - 1.5 A
Rated power consumption (100 to 120 V area)	When <b>Light Output</b> in the <b>Image</b> menu is set to: <b>High:</b> 316 W <b>Standard:</b> 280 W <b>ECO:</b> 242 W
Rated power consumption (220 to 240 V area)	When <b>Light Output</b> in the <b>Image</b> menu is set to: <b>High:</b> 301 W <b>Standard:</b> 268 W <b>ECO:</b> 231 W
Standby power consumption	0.3 W
Operating altitude	Altitude 0 to 3,048 m

Operating temperature **	Altitude of 0 to 2,286 m: +5 to +35°C (Humidity of 20 to 80%, No condensation) Altitude of 2,287 to 3,048 m: +5 to +30°C (Humidity of 20 to 80%, No condensation)
Storage temperature	-10 to +60°C (Humidity of 10 to 90%, No condensation)
Mass	Approx. 4.1 kg

\* Pixel shifting technology achieves 4K resolution on screen.

\*\* Lamp brightness automatically dims if the surrounding temperature gets too high. (Approximately 35°C at an altitude of 0 to 2,286 m, and approximately 30°C at an altitude of 2,287 to 3,048 m; however, this may vary depending on the surrounding environment.)

This product is also designed for IT power distribution system with phase-to-phase voltage 230V.

### Angle of tilt

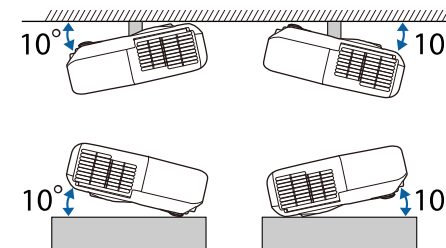

If you use the projector tilted at an angle of more than 10° it could be damaged and cause an accident.

### » Related Links

- "Connector Specifications" [p.109](#)

## Connector Specifications

Audio Out port	Stereo mini pin jack
HDMI1 (ARC) port	HDMI
HDMI2 port	HDMI
USB-A (5V---2.0A) port	USB connector (Type A)
Service port	USB connector (Mini B)



USB-A and Service port supports USB 2.0. However, USB ports are not guaranteed to operate all devices that support USB.

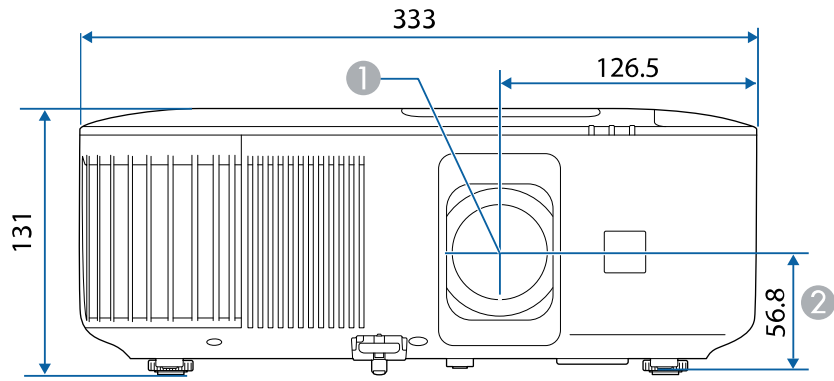

① Center of lens

② Distance from center of lens to suspension bracket fixing point

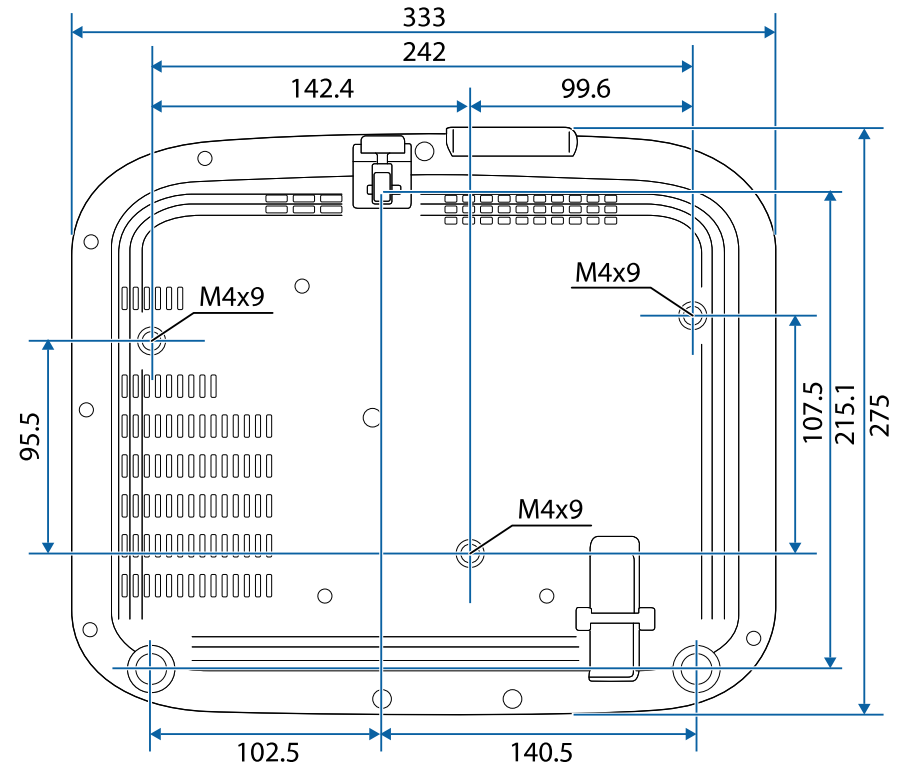



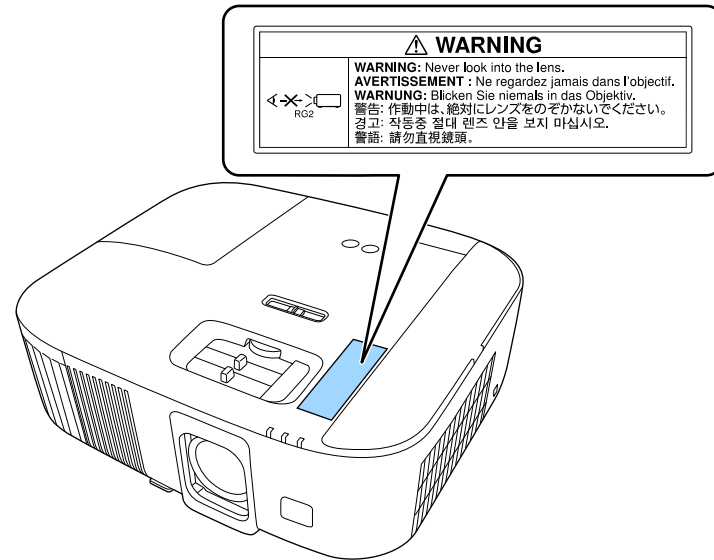













This product comes with warning labels.











As with any bright source, do not stare into the beam, RG2 IEC/EN 62471-5:2015.

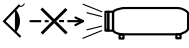

The following table lists the meaning of the safety symbols labeled on the equipment.

No.	Symbol mark	Approved standards	Description
1		IEC60417 No. 5007	"ON" (power) To indicate connection to the mains.
2		IEC60417 No. 5008	"OFF" (power) To indicate disconnection from the mains.
3		IEC60417 No. 5009	Stand-by To identify the switch or switch position by means of which part of the equipment is switched on in order to bring it into the stand-by condition.
4		ISO7000 No. 0434B, IEC3864-B3.1	Caution To identify general caution when using the product.
5		IEC60417 No. 5041	Caution, hot surface To indicate that the marked item can be hot and should not be touched without taking care.
6		IEC60417 No. 6042 ISO3864-B3.6	Caution, risk of electric shock To identify equipment that has risk of electric shock.
7		IEC60417 No. 5957	For indoor use only To identify electrical equipment designed primarily for indoor use.
8		IEC60417 No. 5926	Polarity of d.c. power connector To identify the positive and negative connections (the polarity) on a piece of equipment to which a d.c. power supply may be connected.

No.	Symbol mark	Approved standards	Description
9		—	The same as No. 8.
10		IEC60417 No. 5001B	Battery, general On battery powered equipment. To identify a device for instance a cover for the battery compartment, or the connector terminals.
11		IEC60417 No. 5002	Positioning of cell To identify the battery holder itself and to identify the positioning of the cell(s) inside the battery holder.
12		—	The same as No. 11.
13		IEC60417 No. 5019	Protective earth To identify any terminal which is intended for connection to an external conductor for protection against electric shock in case of a fault, or the terminal of a protective earth electrode.
14		IEC60417 No. 5017	Earth To identify an earth (ground) terminal in cases where neither the symbol No. 13 is explicitly required.
15		IEC60417 No. 5032	Alternating current To indicate on the rating plate that the equipment is suitable for alternating current only; to identify relevant terminals.
16		IEC60417 No. 5031	Direct current To indicate on the rating plate that the equipment is suitable for direct current only; to identify relevant terminals.

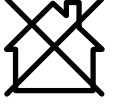

No.	Symbol mark	Approved standards	Description
17		IEC60417 No. 5172	Class II equipment To identify equipment meeting the safety requirements specified for Class II equipment according to IEC 61140.
18		ISO 3864	General prohibition To identify actions or operations that are prohibited.
19		ISO 3864	Contact prohibition To indicate injury that could occur due to touching a specific part of the equipment.
20		—	Never look into the optical lens while the projector is on.
21		—	To indicate that the marked item don't place anything on projector.
22		ISO3864 IEC60825-1	Caution, laser radiation To indicate the equipment has a laser radiation part.
23		ISO 3864	Disassembly prohibition To indicate a risk of injury, such as electric shock, if the equipment is disassembled.
24		IEC60417 No. 5266	Standby, partial standby To indicate that part of the equipment is in the ready status.
25		ISO3864 IEC60417 No. 5057	Caution, movable parts To indicate that you must keep away from movable parts according to protection standards.
26		IEC60417 No. 6056	Caution (Moving Fan Blades) As a safety precaution, stay away from the moving fan blades.

No.	Symbol mark	Approved standards	Description
27		IEC60417 No. 6043	Caution (Sharp Corners) To indicate sharp corners that should not be touched.
28		—	To indicate that looking into the lens while projecting is prohibited.
29		ISO7010 No. W027 ISO 3864	Warning, Optical radiation (such as UV, visible radiation, IR) Taking care to avoid injury to eyes and skin when in the vicinity of optical radiation.
30		IEC60417 No. 5109	Not to be used in residential areas. To identify electrical equipment which is not suitable for a residential area.

This section briefly explains the difficult terms that are not explained in the text of this guide. For details, refer to other commercially available publications.

Aspect Ratio	The ratio between an image's length and its height. Screens with a horizontal:vertical ratio of 16:9, such as HDTV screens, are known as wide screens. SDTV and general computer displays have an aspect ratio of 4:3.
Contrast	The relative brightness of the light and dark areas of an image can be increased or decreased to make text and graphics stand out more clearly, or to make them appear softer. Adjusting this particular property of an image is called contrast adjustment.
DHCP	An abbreviation of Dynamic Host Configuration Protocol, this protocol automatically assigns an IP address to equipment connected to a network.
Gateway Address	This is a server (router) for communicating across a network (subnet) divided according to subnet mask.
HDCP	HDCP is an abbreviation for High-bandwidth Digital Content Protection. It is used to prevent illegal copying and protect copyrights by encrypting digital signals sent over DVI and HDMI ports. Because the HDMI port on this projector supports HDCP, it can project digital images protected by HDCP technology. However, the projector may not be able to project images protected with updated or revised versions of HDCP encryption.
HDMI™	An abbreviation for High Definition Multimedia Interface. HDMI™ is a standard aimed at digital consumer electronics and computers. This is the standard by which HD images and multichannel audio signals are digitally transmitted. By not compressing the digital signal, the image can be transferred at the highest quality possible. It also provides an encryption function for the digital signal.

HDTV	An abbreviation for High-Definition Television that refers to high-definition systems which satisfy the following conditions: <ul style="list-style-type: none"> <li>• Vertical resolution of 720p or 1080i or greater (p = Progressive, i = Interlace)</li> <li>• Screen aspect ratio of 16:9</li> </ul>
Interlace	Transmits information needed to create one screen by sending every other line, starting from the top of the image and working down to the bottom. Images are more likely to flicker because one frame is displayed every other line.
IP Address	A number to identify a computer connected to a network.
Progressive	Projects information to create one screen at a time, displaying the image for one frame. Even though the number of scan lines is the same, the amount of flicker in images decreases because the volume of information has doubled compared with an interlace system.
Refresh Rate	The light-emitting element of a display maintains the same luminosity and color for an extremely short time. Because of this, the image must be scanned many times per second to refresh the light-emitting element. The number of refresh operations per second is called the Refresh rate and is expressed in hertz (Hz).
SDTV	An abbreviation for Standard Definition Television that refers to standard television systems which do not satisfy the conditions for HDTV High-Definition Television.
SSID	SSID is identification data for connecting to another device on a wireless LAN. Wireless communication is possible between devices with the same SSID.
Subnet Mask	This is a numerical value that defines the number of bits used for the network address on a divided network (subnet) from the IP address.
SVGA	A screen size standard with a resolution of 800 (horizontal) × 600 (vertical) dots.
SXGA	A screen size standard with a resolution of 1,280 (horizontal) × 1,024 (vertical) dots.

Sync.	<p>The signals output from computers have a specific frequency. If the projector frequency does not match this frequency, the resulting images are not of a good quality.</p> <p>The process of matching the phases of these signals (the relative position of the crests and the troughs in the signal) is called Synchronization.</p> <p>If the signals are not synchronized, flickering, blurriness, and horizontal interference occur.</p>
VGA	A screen size standard with a resolution of 640 (horizontal) × 480 (vertical) dots.
XGA	A screen size standard with a resolution of 1,024 (horizontal) × 768 (vertical) dots.
WXGA	A screen size standard with a resolution of 1,280 (horizontal) × 800 (vertical) dots.

Check these sections for important notices about your projector.

► **Related Links**

- "FCC Compliance Statement" [p.116](#)
- "How to Dispose of the Projector" [p.117](#)
- "Indication of the manufacturer and the importer in accordance with requirements of EU directive" [p.117](#)
- "Indication of the manufacturer and the importer in accordance with requirements of United Kingdom directive" [p.117](#)
- "Restriction of Use" [p.117](#)
- "Operating System References" [p.118](#)
- "Trademarks" [p.118](#)
- "Copyright Notice" [p.118](#)
- "Copyright Attribution" [p.119](#)

---

## FCC Compliance Statement

**Supplier's DECLARATION of CONFORMITY**

According to 47CFR, Part 2 and 15  
 Class B Personal Computers and Peripherals; and/or  
 CPU Boards and Power Supplies used with Class B Personal Computers

We: Epson America, Inc.

Located at: 3131 Katella Avenue, Los Alamitos, CA

Tel: 562-981-3840

Declare under sole responsibility that the product identified herein, complies with 47CFR Part 2 and 15 of the FCC rules as a Class B digital device. Each product marketed, is identical to the representative unit tested and found to be compliant with the standards. Records maintained continue to reflect the equipment being produced can be expected to be within the variation accepted, due to quantity production and testing on a statistical basis as required by 47CFR 2.906. Operation is subject to the following two conditions: (1) this device may not cause harmful interference, and (2) this

device must accept any interference received, including interference that may cause undesired operation.

Trade Name: EPSON

Type of Product: LCD Projector

Model: HA73B/HA74B

Options:

Product name	Model
Remote controller for HA74B	2219079 xx (x=0-9)

### FCC Compliance Statement For United States Users

This device complies with part 15 of the FCC Rules. Operation is subject to the following two conditions: (1) This device may not cause harmful interference, and (2) this device must accept any interference received, including interference that may cause undesired operation.

This equipment has been tested and found to comply with the limits for a Class B digital device, pursuant to Part 15 of the FCC Rules. These limits are designed to provide reasonable protection against harmful interference in a residential installation. This equipment generates, uses, and can radiate radio frequency energy and, if not installed and used in accordance with the instructions, may cause harmful interference to radio communications. However, there is no guarantee that interference will not occur in a particular installation. If this equipment does cause interference to radio and television reception, which can be determined by turning the equipment off and on, the user is encouraged to try to correct the interference by one or more of the following measures.

- Reorient or relocate the receiving antenna.
- Increase the separation between the equipment and receiver.
- Connect the equipment into an outlet on a circuit different from that to which the receiver is connected.
- Consult the dealer or an experienced radio/TV technician for help.

**WARNING**

The connection of a non-shielded equipment interface cable to this equipment will invalidate the FCC Certification or Declaration of this device and may cause interference levels which exceed the limits established by the FCC for this equipment. It is the responsibility of the user to obtain and use a shielded equipment interface cable with this device. If this equipment has more than one interface connector, do not leave cables connected to unused interfaces. Changes or modifications not expressly approved by the manufacturer could void the user's authority to operate the equipment.

---

**How to Dispose of the Projector****Projector**

Before disposing of the projector, remove the lamp from the projector. Check your local laws and regulations regarding disposal or recycling. Do not put it in the trash with ordinary garbage.

**Projector lamp**

The lamp in this product contains mercury (Hg). Check your local laws and regulations regarding disposal or recycling. Do not put it in the trash with ordinary garbage.

---

**Indication of the manufacturer and the importer in accordance with requirements of EU directive**

Manufacturer: SEIKO EPSON CORPORATION  
Address: 3-5, Owa 3-chome, Suwa-shi, Nagano-ken 392-8502 Japan  
Telephone: 81-266-52-3131  
<http://www.epson.com/>

Importer: EPSON EUROPE B.V.  
Address: Atlas Arena, Asia Building, Hoogoorddreef 5,1101 BA Amsterdam  
Zuidoost  
The Netherlands  
Telephone: 31-20-314-5000  
<http://www.epson.eu/>

---

**Indication of the manufacturer and the importer in accordance with requirements of United Kingdom directive**

Manufacturer: SEIKO EPSON CORPORATION  
Address: 3-5, Owa 3-chome, Suwa-shi, Nagano-ken 392-8502 Japan  
Telephone: 81-266-52-3131  
<http://www.epson.com/>

Importer: Epson (UK) Ltd.  
Address: Westside, London Road, Hemel Hempstead, Hertfordshire, HP3 9TD,  
United Kingdom  
<http://www.epson.co.uk>

---

**Restriction of Use**

When this product is used for applications requiring high reliability/safety such as transportation devices related to aviation, rail, marine, automotive etc.; disaster prevention devices; various safety devices etc; or functional/precision devices etc, you should use this product only after giving consideration to including fail-safes and redundancies into your design to maintain safety and total system reliability. Because this product was not intended for use in applications requiring extremely high reliability/safety such as aerospace equipment, main communication equipment, nuclear power control equipment, or medical equipment related to direct medical care

etc, please make your own judgment on this product's suitability after a full evaluation.

---

## Operating System References

- Microsoft® Windows® 8.1 operating system
- Microsoft® Windows® 10 operating system
- Microsoft® Windows® 11 operating system

In this guide, the operating systems above are referred to as "Windows 8.1", "Windows 10", and "Windows 11". Furthermore, the collective term "Windows" is used to refer to them all.

- macOS 10.13.x
- macOS 10.14.x
- macOS 10.15.x
- macOS 11.0.x
- macOS 12.0.x

In this guide, the collective term "Mac OS" is used to refer to all of the operating systems above.

---

## Trademarks

EPSON is a registered trademark, EXCEED YOUR VISION and its logos are registered trademarks or trademarks of Seiko Epson Corporation.

iPad, iPhone, Mac, OS X, iOS, and macOS are trademarks of Apple Inc.

Microsoft, Windows, and the Windows logo are trademarks or registered trademarks of Microsoft Corporation in the United States and/or other countries.

Google, Google Play, YouTube and Android TV are trademarks of Google LLC.

Google Assistant is not available in certain languages and countries. Availability of services varies by country and language.

HDMI, the HDMI Logo and High-Definition Multimedia Interface are trademarks or registered trademarks of HDMI Licensing Administrator, Inc.



Wi-Fi® is a trademark of the Wi-Fi Alliance®.

The Bluetooth® word mark and logos are registered trademarks owned by Bluetooth SIG, Inc. and any use of such marks by Seiko Epson Corporation is under license. Other trademarks and trade names are those of their respective owners.

Netflix is a registered trademark of Netflix, Inc. **NETFLIX**

Other product names used herein are also for identification purposes only and may be trademarks of their respective owners. Epson disclaims any and all rights in those marks.

---

## Copyright Notice

All rights reserved. No part of this publication may be reproduced, stored in a retrieval system, or transmitted in any form or by any means, electronic, mechanical, photocopying, recording, or otherwise, without the prior written permission of Seiko Epson Corporation. No patent liability is assumed with respect to the use of the information contained herein. Neither is any liability assumed for damages resulting from the use of the information contained herein.

Neither Seiko Epson Corporation nor its affiliates shall be liable to the purchaser of this product or third parties for damages, losses, costs, or expenses incurred by the purchaser or third parties as a result of: accident, misuse, or abuse of this product or unauthorized modifications, repairs, or alterations to this product, or (excluding the U.S.) failure to strictly comply with Seiko Epson Corporation's operating and maintenance instructions.

Seiko Epson Corporation shall not be liable against any damages or problems arising from the use of any options or any consumable products other than those designated as Original Epson Products or Epson Approved Products by Seiko Epson Corporation.

The contents of this guide may be changed or updated without further notice.

---

## Copyright Attribution

This information is subject to change without notice.

© 2022 Seiko Epson Corporation

2022.4 414279000EN