



Instruction Manual for Smartmove Series Motorized Screen



Model: SSM

Technical Assistance

If you need help with installing this screen please visit
www.sapphireav.com



Thank you for purchasing a sapphire projection screen.

Before use, please read instructions carefully. After installation, store instructions for future reference.

Questions & Answers

Fabrics of Grandview motorized screen can be used for years, most problems are cost by simple incidents. If problem occurs, please find the list below for some common solutions. If problems keep on, please contact authorized agent of Grandview or call service number: (8620)34806166

1. Can not be used after installation completely.

Reasons	Solutions
No power or wrong installation of batteries in controller.	Please check about the batteries as instruction manual.
Power line disconnection	Please connect the power line as instruction manual.
The strap is blocked	Return the sling wheel by hands.

2. The casing can drop, but can not rise.

Reasons	Solutions
Secure Positioning Executive Piece is blocked	Return the Secure Positioning Executive Piece by hands

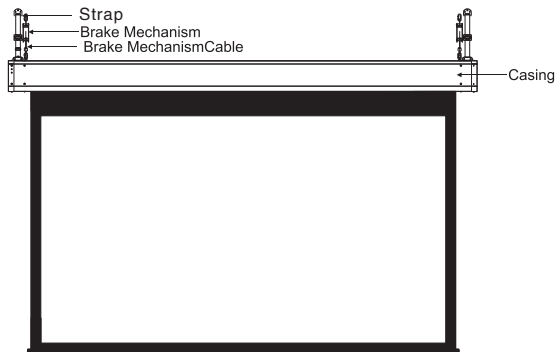

Caution

Warnings: Please prevent screen from wet place to avoid electric or fire dangerous.

1. Please read carefully with this instructions before installation to avoid damage to product causing by inappropriate installation or operation.
2. Please keep the screen away from hot sources, such as radiator, heating machine, fireplace, loudspeaker or other relative device.
3. Only Plug with ground wire is acceptable.
4. Only accessories from authorized supplier is acceptable.
5. Please unplug the power wire when lighting and raining or not use with a long time.
6. Please handle the repair work to the professional agent.
7. Please prevent screen from water as well as putting stuff with water (such as vase) on the screen.
8. As soon as the plug of the screen is connected to the power source, the screen is connecting with electricity.
9. Please use the approved power line (three-core power line)/ device interface/power plug.
10. Please use the rating (voltage, amps) power line (three-core power line) / device interface/power plug. If have any questions about power line/ device interface/power plug, please contact the professional people.
11. After installation, please locate a power device in order to disconnect power or connect the power plug to electrical socket. This electrical socket should be installed to a convenient position. If the accident occurs during operation, please disconnect power or take out the power plug.
12. The ceiling or wall used for fixture installation must be secure enough; load-bearing requirement must be 4 times of the screen to prevent the screens from falling.
13. Please do not operate the screen continuously because of over-heat protection, The product can be used normally after a few minutes.

Warnings

To prevent from electric dangerous, please don't remove the end cap. There is no need for users to check the parts inside, please handle the problems to professional repairman.



Please notice the non-insulated voltage of the spare parts to prevent from electric dangerous.



Please operate according to the user manual with the screen.

Caution

1. Safety

- Please ensure whether the operating voltage is the same as local voltage. If the voltage adapter is required, please contact the professional agent.
- If any liquid or solid fall into the casing, please disconnect power and contact the professional agent.
- If the screen is not being used for an extended period of time, please disconnect electricity.
- Take out the power plug by hand.
- Wall power socket needs to be installed at a convenient position.
- As soon as the plug of the screen is connected to the power source, the screen is connecting with electricity.
- Do not put the hands into casing.

2. Lighting

- Do not stay the screen under lighting or sunlight to achieve the best viewing image.
- Recommend using spotlight in viewing process, and magnesium light is not recommended.
- The windows facing to screen need to be blocked by opaque curtain.
- Using the screen in the room without reflective materials.

3. Cleaning and Maintenance

After cleaning, please disconnect power.

(1). Casing Clean

- Please use the soft dry-cloth to clean the casing. Please remove the stubborn stains with Neutral detergent, and then use the soft-cloth to clean.
- The excess using of rubber or vinyl resin products will damage the appearance of casing.

(2). Fabric Clean

- The damages of appearance of screen will influence the viewing image, please note the following:
 - Do not touch the screen by hands.
 - Please do not mark the screen surface
 - Do not shave the screen by finger or edge tool to avoid the crack or scratch.
 - Do not clean the screen with alcohol, benzene or thinner.
- Retract the screen after using.
- Please retract the screen without any insects, dust and foreign bodies.

Caution Illustration

The surface of screen is processed to achieve good performance of the reflector. Any damage of surface will influence projection effects so please use this product in right way.

Caution

- Please do not shake the screen by hand.

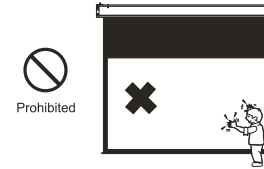

- Please do not use any cloth with water, volatile oil and corrosive cleaning agents to clean the screen, because they will make the surface metamorphism and paint off.

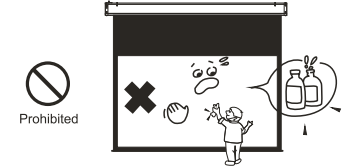

- Please do not make any marks on screen surface.

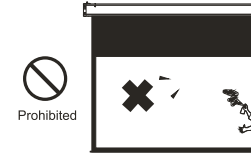

- Please do not pull the screen strongly that it will cause the risk of damage.



Maintenance

- Any stains on the casing, please use dry-cloth to clean softly. If too serious, please use soft-cloth with water-diluted neutral detergent to clean.



- Please use a brush to clean the dust of screen surface softly.

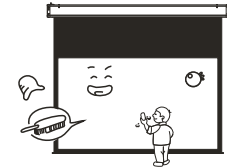

Location Caution

- Please keep the screen far away from sunshine, dust and wet. Avoid using the screen in strong wind.

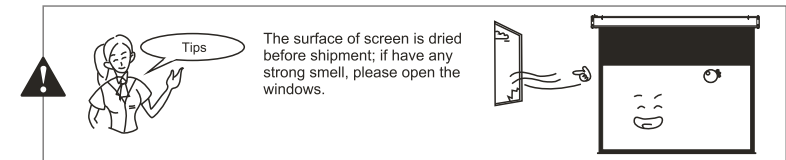

Caution

- Please contact your local dealer for repairing and replacing. Please contact us if you have any questions. Avoid taking apart the fixture yourself.



Model A Series Data

Format	Model	Diagonal (in)	Viewing area		L (mm)	A (mm)	B1 (mm)	B3 (mm)	P1 (mm)	P2 (mm)	Net weight
			W (mm)	H (mm)							
4:3	SSM300 RADV	150"	3048	2286	3571	2820	80	200	3411	3285	
	SSM360 RADV	180"	3620	2715	4181	3277	80	200	4021	3895	
	SSM400 RADV	200"	4020	3015	4587	3582	80	200	4427	4301	
	SSM480 RADV	240"	4878	3660	5400	4192	80	200	5240	5114	
16:9	SSM330RAD-WSF	150"	3320	1867	3844	2402	80	200	3684	3558	
	SSM400RAD-WSF	180"	3984	2240	4508	2775	80	200	4348	4222	

Remarks: Casing length will change upon different screen sizes, above specifications are subject to change without informing. (The tolerance for L is 3mm.)

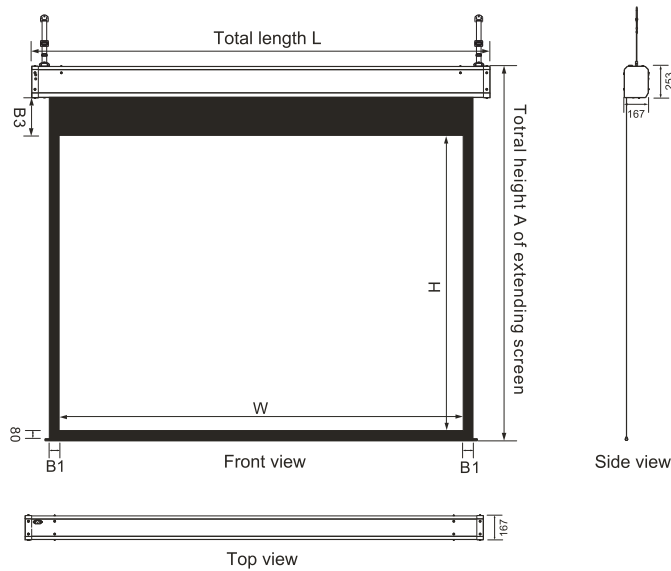

Smartmove series is a perfect solution for installation in venues with high ceiling or pillars that range from 5m to 8m.

Description

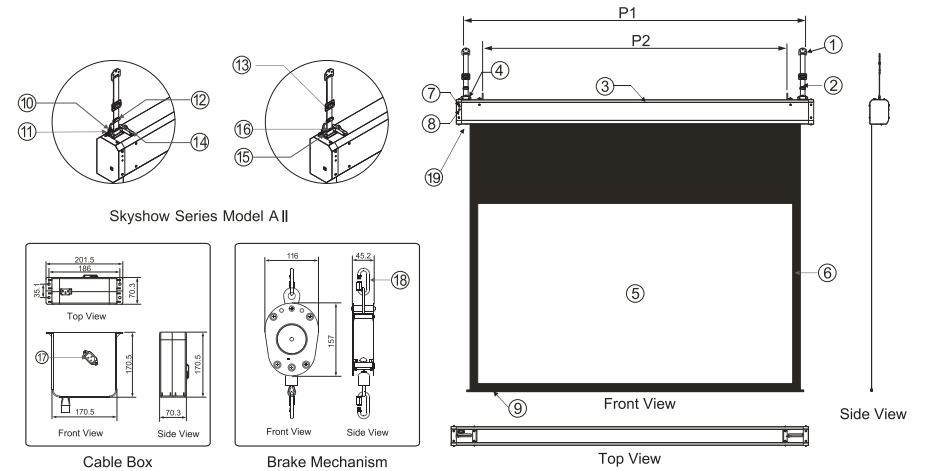

Screen parts

①	Hook	⑧	Extending Limitation	⑮	Hanging Hook for Brake Mechanism (series B)
②	Strap	⑨	Low Bar	⑯	Secure Positioning Executive Piece
③	Casing	⑩	Cable Box Plug	⑰	Cable Box Socket
④	Secure Positioning Piece	⑪	Socket	⑱	Buckle
⑤	Screen Fabric	⑫	Positioning Screw	⑲	LED Indication Light
⑥	Black Border	⑬	Carriage Wheel		
⑦	Retracting Limitation	⑭	Hanging Piece for Brake Mechanism (series A)		

Accessories

- Cable box (1 pc)
- #5 x 40mm Tapping screws and caps (4 sets)
- Cable (1 pc)
- Remote controller (1pc)
- Cable lock (1pc)
- φ4x10 Screw (1 pc)
- M4 Adjustment Key (1 pc)
- Brake Mechanism (2 pcs)
- Buckle (4 pcs)
- Batteries(1set)
- Flat Network Control Cable Lock (1pc)
- Instruction Manual (1pc)
- Warranty Card (1pc)

Optional Accessories

■ Ethernet Cable Box



■ Multimedia Cable Box



■ Wall Switch



■ Ceiling Installation Part

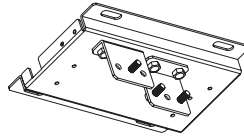

■ Synchro Power Relay

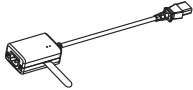

Installation Instruction

Take out all the parts from the packaging and follow the accessories guideline to ensure you have all parts, and then follow the operations to install (Please follow model B series installation, which is the same as model A).

1. Fix the rings (not accessories) on the ceiling according to the distance P1 between two hooks (note: make sure each of rings can endure at least 200kg) (figure 1).

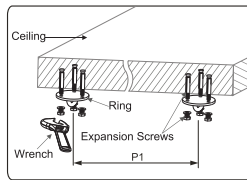

Figure 1

2. Fix the rings (not accessories) on the ceiling according to the distance P2 between two hanging pieces of brake mechanism (note: make sure each of rings can endure at least 200kg) (figure 2).

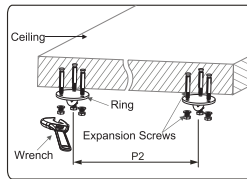

Figure 2

Optional

1. Multimedia cable box; 5M automatic retracting.

Only use for the products which have this joint and the products can work with the multimedia cable to connect computer or central control. And they can be controlled by RS-232, RS-485 and trigger.



Multimedia Cable Box

2. Synchro Power Relay

Connect the projector with Synchro Power Relay, and then the screen can be controlled by projector.

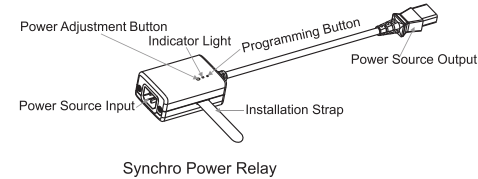

Synchro Power Relay

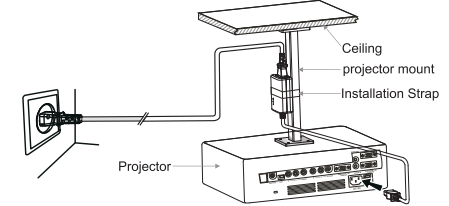

5. Screen Adjustment

Motor Positioning

Don't roll out and retract the screen continuously over 4 minutes in a time to avoid overheating. If the motor overheats, keep 30 minutes for heat elimination. No lubrication using for the motor, the drop and retract limit of the screen has been preposition to an optimal configuration before delivery. In order to avoid motor damage, please ask the local dealer or professional for consultation when a new position setting is needed.

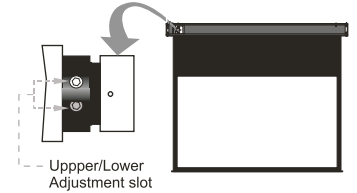

Upper/Lower Adjustment slot

"Screen Extending" adjustment

Adjust after the screen fabric is dropping completely:

- (1) To adjust the position of the viewing area when the screen is falling down, first of all please insert the adjuster in the slot, the viewing area will rise up about 40mm if turning the adjuster for a circle anticlockwise.

Note: Only when pressing "UP" button and operating for few seconds, that you can observe the differences after position adjustment distinctly; then press "DOWN" button you can easily see the difference of the position of the screen.

- (2) If over-adjusting, anticlockwise adjustment can regulate the screen retraction. Adjustment is only after the screen is completely dropped and up or down control is not in use.

⚠ Please operate carefully to avoid motor and screen damage by over-retraction.

"Screen Retracting" adjustment

Only for your information: turn off the positioning switch.

(Note: the adjustment is extremely dangerous, please ask our technician for assistance without fail to prevent destroying the screen or guarantee invalidation.)

"The Note"strongly suggests users not adjust the retraction limit privately; all the screens are preset before delivery which satisfies most of the users' demand. Description as follow is only restricted to few situations:

- (1) Insert the adjuster in the adjusting slot (in the place where is nearest to the rear of the screen), when the screen fabric is retracted to the casing, adjust the motor anchor point. The screen can be positioned at where 40mm away from the casing if turning the adjuster for a circle deasil.

Note: Only when pressing "DOWN" button and operating for few seconds, that you can observe the differences after position adjustment distinctly; then press "UP" button you can easily see the difference of the position of the screen.

To avoid damage, please do not operate the screen before the first step.

- (2) Turn the Motor Adjusting Slot anticlockwise for one circle, the screen will be positioned at where 40mm away from the casing.

⚠ Please operate carefully to avoid motor and screen damage by over-retraction.

a.Upper limitation adjusting. Take off the knob from the hole and use the provided allen key to adjust (figure28). A clockwise adjustment will retract the screen (The distance between the screen and installation position will decrease) and a counter-clockwise adjustment will extend the screen (The distance between the screen and installation position will increase).

b.Lower limitation adjusting. Take off the knob from the hole and use the provided allen key to adjust (figure 29). A clockwise adjustment will extend the screen (The distance between the screen and installation position will increase) and a counter-clockwise adjustment will retract the screen (. The distance between the screen and installation position will decrease).

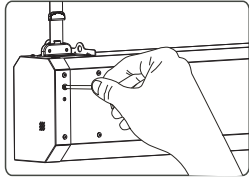

Figure 28

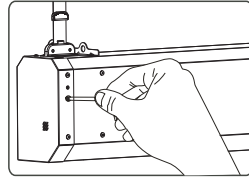

Figure 29

(3).Secure positioning piece

There is also a Secure Positioning Piece besides the Remote Localizer.

a.Loose the screw on the positioning piece (12) and then fasten again after moving it to the desired position (figure 30).

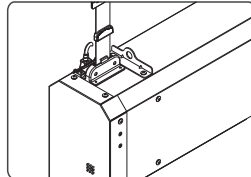
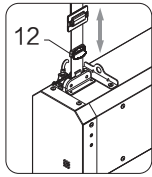

Figure 30

Remark: the position of positioning piece needs to be set according to the highest upper limitation setting by the remote.

b.When the casing retracts to a certain height and reach the secure positioning piece, the touching switch would be off by being pressed by secure positioning piece onto a trigger. The casing will not rise any more but can only be lower down.(Recommendation:cable box must be installed above the power input of screen)(figure 31-32)

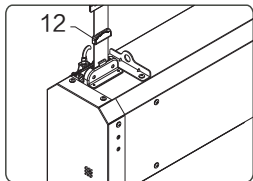

Figure 31

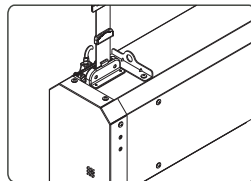

Figure 32

3.To hang the strap on the rings (note: do not operate after pull out the cable from cable box) (figure 3-4).

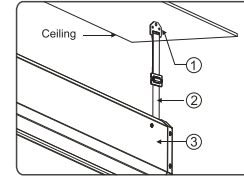

Figure 3

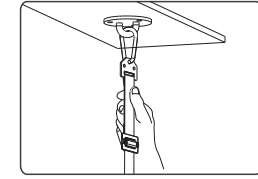

Figure 4

Note: the screen needs to be hanging if you want to adjust the length of strap (the drive mechanism can be opened when the strap is carrying and power on), and the use the controller for adjusting the length of strap.

4. Hook the buckles of brake mechanism on the rings, and then fasten the buckles (figure 5-6)

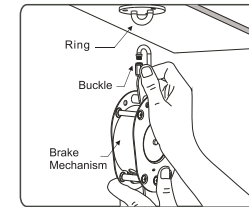

Figure 5

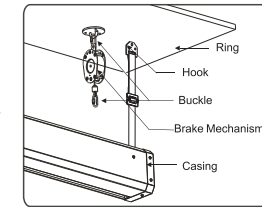

Figure 6

5. Hook the low buckles of brake mechanism on the hanging pieces, and then fasten the buckles (figure 7-9)

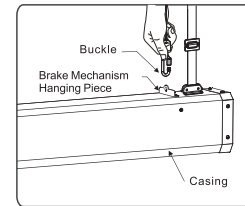

Figure 7

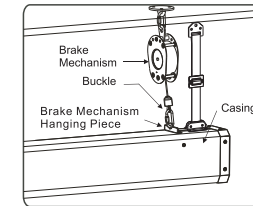

Figure 8

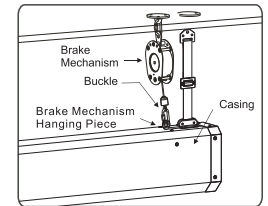

Figure 9

6. Drill 4 holes on the ceiling, and then select 5x40mm tapping screws to fasten the cable box on the ceiling.
(Recommendation: cable box must be installed above the power input of screen) (figure 10-11).

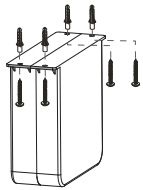

Figure 10

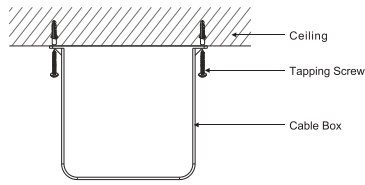

Figure 11

7. The screen includes two parts of cable; there are cable box and main cable. Firstly, please insert the plug into socket (figure 12-13).

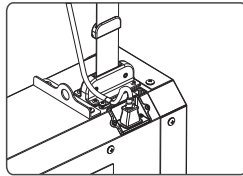

Figure 13

8. Loop the cable with cable lock, and then fasten it onto the casing top via 4x10mm screw (note: separate the cable and power to avoid the damages of power line).

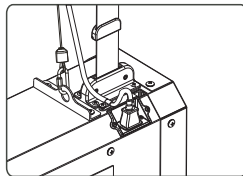

Figure 14

9. Insert the plug from main cable into the socket on the cable box (figure 15-16).

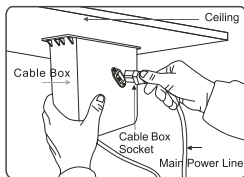

Figure 15

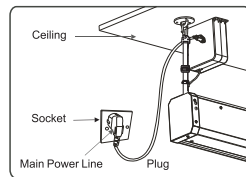

Figure 16

6. Positioning Instruction

There are 3 level to position the screen (1)remote localizer, (2)motor positioning, (3)secure positioning piece.

(1).Remote Localizer (Recommended)

- a. When the screen is at loading situation, you can adjust the upper/lower limitation via the remote controller.
(Retract position is larger than 30cm to the installation position, extend position is smaller than 495cm installation position).
- b. To press the localizer hole at the back of the remote controller with one small pin or equivalence for about 3 seconds and then release, then press Up button for strap to the desired position and stop, the screen is already reset for its retract limit (figure 22-23).

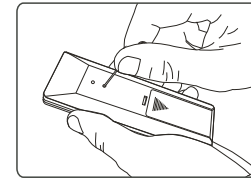

Figure 22

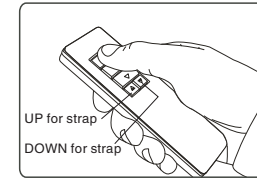

Figure 23

- c. To press the localizer hole at the back of the remote controller with one small pin or equivalence for about 3 seconds and then release, then press Down button for strap to the desired position and stop, the screen is already reset for its extend limit (figure 24-25).

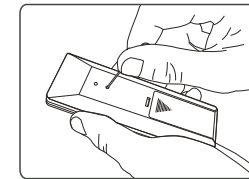

Figure 24

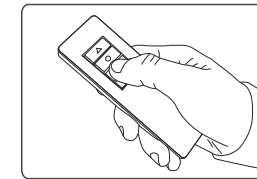

Figure 25

Notice: for ensuring the security of positioning function, the distance between the upper limitation and secure positioning mechanism must be 10cm. The effective setting period of electric positioning should be 60 seconds, after 60 seconds will return to normal situation. If the setting fails within 60 seconds, please repeat as following step: to press the setting button, then LED light will turn off; press the setting button again, then LED light will turn on. In this movement, the resetting function will begin.

(2).Motor positioning (Do not adjust the allen keys without advise from manufacturer.)

Upper limitation and lower limitation are set from factory, the upper limitation should be at 30cm which is the distance between the screen and installation position (figure 26), and the lower limitation should be at 495cm which is the distance between the screen and installation position (figure 27) (upper/lower limitation hole for sling wires must be regulated by professional or dealers, please do not regulate yourself. Improper regulation will cause the risk of damages).

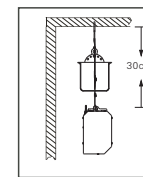

Figure 26

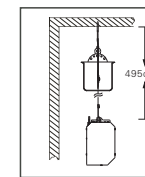

Figure 27

Directive for retracting the fabric: 0xFF 0x10 0x11 0x12 0xDD

Directive for stopping the screen: 0xFF 0x10 0x11 0x12 0xCC

Directive for extending the fabric: 0xFF 0x10 0x11 0x12 0xEE

Directive for retracting the casing: 0xFF 0x10 0x11 0x12 0xC9

Directive for extending the casing: 0xFF 0x10 0x11 0x12 0xE9

Completed the studying in screen A, and then disconnect the power in screen A. Please operate the screen B in same way and change the address to 0xAA 0xAA 0xAA. Entering the operating address of screen B can control the screen.

Directive for retracting the fabric: 0xFF 0x10 0x11 0x12 0xDD

Directive for stopping the screen: 0xFF 0x10 0x11 0x12 0xCC

Directive for extending the fabric: 0xFF 0x10 0x11 0x12 0xEE

Directive for retracting the casing: 0xFF 0x10 0x11 0x12 0xC9

Directive for extending the casing: 0xFF 0x10 0x11 0x12 0xE9

This studying is one address bit for a long time until next address bit change to update.

After studying address bit, the common directive is still effective, so the address bit can not be 0xEE 0xEE 0xEE.

Attachment 1

Compare 16 hexadecimal system to 10 hexadecimal system

16 hexadecimal system	1	2	3	4	5	6	7	8	9	A	B	C	D	E	F	
10 hexadecimal system	1	2	3	4	5	6	7	8	9	10	11	12	13	14	15	16

4. Load Mechanism

There is a load mechanism in the screen, assuring screen to work only after being properly installed. When hanging the screen on the rings, screen gravity would turn the wheel via strap, which connects the load switch automatically (figure 18-19).

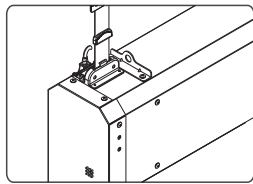

Figure 18

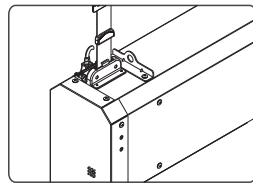

Figure 19

5. Remote Controller Instruction

(The matching between controller and screen is already done in factory pre-setting)

There is matching function between controller and screen, and then controller needs to be programmed before using.

- (1). The screen is at situation of load. After connecting the power within 5 seconds, please press "UP" button and "STOP" button simultaneously for 5 seconds then release.
- (2). Press the "DOWN" button to ensure whether the programming works?
- (3). If the programming fails, please repeat step 2 and 3.

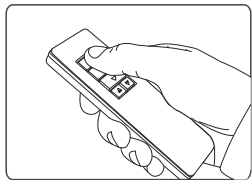

Figure 20

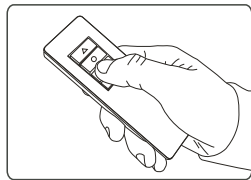

Figure 21

Recessed Mount

The screen can be installed on the ceiling, with the reference to the above-mentioned steps 1-9 (figure 17).

Recessed Mount Illustration

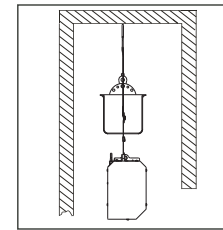

Figure 17

Product Instruction

1. Wall Switch Instruction

Please use the wall switch following the marking and symbols on switch.

Note: please fix the cable box on the ceiling, and please ensure the cable box, retractor and central control input are at the same level.

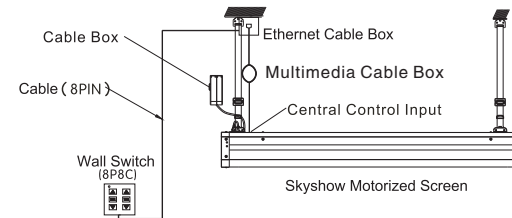

Wall Switch Wiring Description

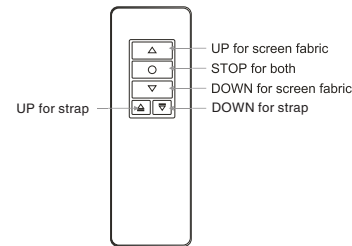

Front view

2. Remote controller instruction

Remote controller instruction:

1. To retract screen, press "UP for screen fabric".
2. To stop sling wires or screen fabric, press "STOP for both".
3. To lower down screen, press "DOWN for screen fabric".
4. To retract sling wires, press "UP for strap".
5. To lower down sling wires, press "DOWN for strap".

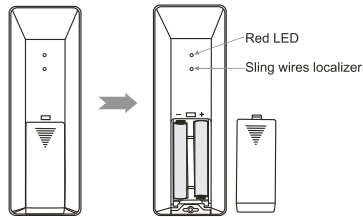

Remote controller guideline:

1. Working temperature: -200C - +800C.
2. Protection index: IP30.
3. Batteries: 1.5V x 2pcs, model # AAA.
4. Working under normal polluted environment.
5. Take out batteries if the controller will not be used for a long time.
6. Please change the batteries when signal is weak.

How to install the batteries:

- Please change the batteries as below when signal is weak.
1. Turn around the controller, push to pen the cover as guiding arrow.
 2. Put the batteries in according to the guide of anode and cathode.
 3. Close the cover.

Caution

The controller does not work if mistaking the anode and cathode of batteries, please correct the direction according to the figure on the left.

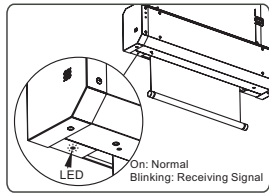

LED Indication Light

Under the casing on the left side, the LED light can indicate the status of the screen.
When the light is on, it means the power supply is normal.
When the light is blinking, it means the screen is receiving signals.

Central Control Instruction

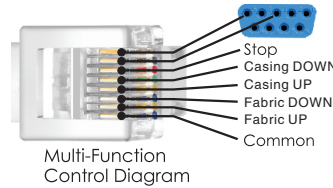

Emitter Function:

1	RS232 GND /RS485 A	5	Casing UP
2	RS232 TXD /RS485 B	6	Fabric DOWN
3	Stop	7	Fabric UP
4	Casing DOWN	8	Common Line

Central Control Format Agreement

- 1)Communication Agreement Setting:
data bits: 8 bits, start bits: 1 bit, stop bits: 1 bit, Baud Ratio: 2400.

Function	Hexadecimal System	decimal System
Stop	FF EE EE EE CC	1099225296588
Casing DOWN	FF EE EE EE E9	1099225296617
Casing UP	FF EE EE EE C9	1099225296585
Fabric DOWN	FF EE EE EE EE	1099225296622
Fabric UP	FF EE EE EE DD	1099225296605

RS485 Custom Setting Address:

- 1、RS-485, RS-232 input

A continuous data sends two times, each time interval of 200 ms.

3 bytes of studying address directive are custom setting address directive.

Central Control Format Agreement

1)Communication Agreement Setting

Data Bits: 8 bits

Start Bits: 1 bit

Stop Bits: 1 bit

Baud Ratio: 2400

Common directives are in chip of screen and can not be changed.

2)Directive for retracting the fabric: 0xFF 0xEE 0xEE 0xEE 0xDD

3) Directive for stopping the screen: 0xFF 0xEE 0xEE 0xEE 0xCC

4) Directive for extending the fabric: 0xFF 0xEE 0xEE 0xEE 0xEE

5) Directive for retracting the casing: 0xFF 0xEE 0xEE 0xEE 0xC9

6) Directive for extending the casing: 0xFF 0xEE 0xEE 0xEE 0xE9

7) Studying address directive: 0xFF 0xFF 0xFF 0xFF 0xAA

Directive Composing Instruction:

0xFF is only bit; 0x stands for 16 hexadecimal system; FF is effective bit; a directive is composed by 5 bits.

Studying directive 0xFF 0xFF 0xFF 0xFF 0xFF

0xFF and 0xAA can not be changed, but 0xFF 0xFF 0xFF can be changed to any 16 hex data, which stand for address bit.

The changed working directive

1) Directive for retracting the fabric: 0xFF 0xFF 0xFF 0xFF 0xDD

2) Directive for stopping the screen: 0xFF 0xFF 0xFF 0xFF 0xCC

3) Directive for extending the fabric: 0xFF 0xFF 0xFF 0xFF 0xEE

4) Directive for retracting the casing: 0xFF 0xFF 0xFF 0xFF 0xC9

5) Directive for extending the casing: 0xFF 0xFF 0xFF 0xFF 0xE9

6) Studying address directive: 0xFF 0xFF 0xFF 0xFF 0xAA

Example: the studying directive is 0xFF 0x10 0x11 0x12 0xAA which can be changed to:

7) Directive for retracting the fabric: 0xFF 0x10 0x11 0x12 0xDD

8) Directive for stopping the screen: 0xFF 0x10 0x11 0x12 0xCC

9) Directive for extending the fabric: 0xFF 0x10 0x11 0x12 0xEE

10) Directive for retracting the casing: 0xFF 0x10 0x11 0x12 0xC9

11) Directive for extending the casing: 0xFF 0x10 0x11 0x12 0xE9

12) Studying address directive: 0xFF 0x10 0x11 0x12 0xAA

Studying Directive and Operation

After connecting power, studying status will operate within the first 10 seconds. The studying directive is 0xFF 0xFF 0xFF 0xFF 0xFF. The screen can be used normally after study completed, but the screen can not be used normally after the address bit changed, so that one port can be used to control many screens.

Example:

Screen A and screen B with RS-485 port, if need to control these two screens synchronously that the directive 0xFF 0xFF 0xFF 0xFF 0xFF will be sent out from the port. If need to control these two screens in different movement, such as screen A goes down and screen B goes up, common directive can not be used and separated by address bit at this time.

Connect the power for screen A, and send out directive 0xFF 0x10 0x11 0x12 0xFF. At the same time, the address of screen A is 0x10 0x11 0x12. Entering the operating address of screen A can control the screen.