

KRAMER



USER MANUAL

MODEL:

VS-42UHD

4x2 HDMI Matrix Switcher



VS-42UHD Quick Start Guide

This guide helps you install and use your **VS-42UHD** for the first time.
Go to <http://www.kramerav.com/manual/VS-42UHD> to download the latest user manual
(or scan the QR code) and check if firmware upgrades are available.

Step 1: Check what's in the box

- ✓ VS-42UHD 4x2 HDMI Matrix Switcher
- ✓ 4 Rubber feet
- ✓ Kramer RC-IR3 Infrared Remote Control Transmitter with batteries and user manual
- ✓ 1 Power supply (5V DC)
- ✓ 1 Quick start guide

Step 2: Install the VS-42UHD

Attach the rubber feet and place on a table or mount the **VS-42UHD** in a rack (using an optional **RK-T2B** rack mount).

Step 3: Connect inputs and outputs

Always switch OFF the power on each device before connecting it to your **VS-42UHD**.
For best results, we recommend that you always use Kramer high-performance cables to connect AV equipment to the **VS-42UHD**.

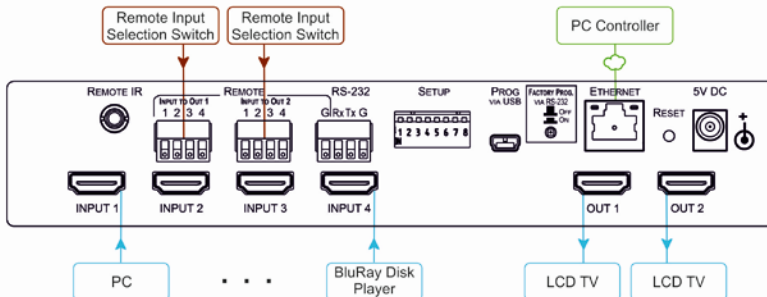

Step 4: Connect the power

Connect the 5V DC power adapter to the **VS-42UHD** and plug the adapter into the mains electricity.



Step 5: Set the DIP-switches:

#	Feature	Description
1	HDCP support on inputs	On—Disable HDCP support on all inputs Off—Enable HDCP support which is defined by P3000 commands
2	Video mode switching Output 1	On—Auto Off—Manual
3	Last connected/Priority mode Output 1	When DIP-switch 2 is set to Auto (ON): On—Enable Last Connected mode Off—Enable Priority mode where the priority of each input is defined by the input number, (1 is the highest priority)
4	Video mode switching Output 2	On—Auto Off—Manual
5	Last connected/Priority mode Output 2	When DIP-switch 4 is set to Auto (ON): On—Enable Last Connected mode Off—Enable Priority mode where the priority of each input is defined by the input number, (1 is the highest priority)
6	N/A	—
7	N/A	—
8	N/A	—

Step 6: General operation

Switch an Input to an Output:

Press an input button on the top row (To OUT1) to switch that input to Output 1.

Press an input button on the bottom row (To OUT2) to switch that input to Output 2.

To Copy an EDID from an Output to an Input:

1. Press the EDID button.
2. Press the required Input button corresponding to either Output 1 or Output 2.
3. Press the EDID button.

Step 7: Operate via the front panel buttons and via the:

IR Remote Controller:



RS-232 and Ethernet:

RS-232	
Protocol 3000	
Baud Rate:	115,200
Data Bits:	8
Stop Bits:	1
Parity:	None
Command Format:	ASCII
TCP/IP Parameters	
IP Address:	192.168.1.39
Netmask:	255.255.0.0
Gateway:	0.0.0.0
TCP Port #:	5000
UDP Port #:	50000

Embedded Web Page:

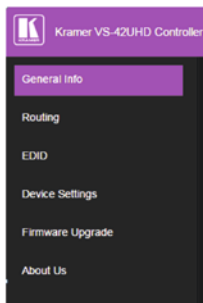

Contents

1	Introduction	1
2	Getting Started	2
2.1	Achieving the Best Performance	2
2.2	Safety Instructions DC	2
2.3	Recycling Kramer Products	3
3	Overview	4
3.1	Using the IR Transmitter	5
3.2	Defining the VS-42UHD 4x2 HDMI Matrix Switcher	6
4	Connecting the VS-42UHD	8
4.1	Connecting a Serial Controller via RS-232	9
4.2	Connecting to the VS-42UHD via Ethernet	9
4.3	Connecting the Remote Contact-Closure Switches	12
5	Principles of Operation	14
5.1	Automatic Signal Detection	14
5.2	Input Switching Modes	14
5.3	EDID Operation	15
5.4	Step-in Functionality	15
6	Operating the VS-42UHD 4x2 HDMI Matrix Switcher	16
6.1	Switching an Input to an Output	16
6.2	Acquiring an EDID from an Output	16
6.3	Muting and Unmuting the Outputs	17
6.4	Locking and Unlocking the Front Panel Buttons	18
6.5	Generating a Test Pattern	18
7	Configuring and Maintaining the VS-42UHD	19
7.1	Setting the DIP-Switches	19
7.2	Resetting the VS-42UHD to Factory Default Settings	20
7.3	Upgrading the Firmware	20
8	Operating the VS-42UHD Remotely via the Web Pages	21
8.1	Browsing the VS-42UHD Web Pages	21
8.2	Routing Page	23
8.3	EDID Page	27
8.4	Device Setting Page	29
8.5	Firmware Upgrade Page	30
8.6	About Us Page	31
9	Wiring the Twisted Pair RJ-45 Connectors	32
10	Technical Specifications	33
11	Default Communication Parameters	34
12	Default EDID	35
13	Protocol 3000	37
13.1	Understanding Protocol 3000	38
13.2	Kramer Protocol 3000 Syntax	40
13.3	Protocol 3000 Commands	41

Figures

Figure 1: VS-42UHD 4x2 HDMI Matrix Switcher Front	6
Figure 2: VS-42UHD 4x2 HDMI Matrix Switcher Rear	7
Figure 3: Connecting the VS-42UHD 4x2 HDMI Matrix Switcher	9
Figure 4: Local Area Connection Properties Window	10
Figure 5: Internet Protocol Version 4 Properties Window	11
Figure 6: Internet Protocol Properties Window	12
Figure 7: Remote Contact-closure Switch Connections	13
Figure 8: Available Test Patterns	18
Figure 9: The Loading Page	22
Figure 10: The General Info Page	22
Figure 11: The Routing Page	23
Figure 12: The Output Buttons	24
Figure 13: The Input Buttons	24
Figure 14: The Remote Device Control Window	25
Figure 15: Test Pattern Tab	26
Figure 16: The EDID Page	27
Figure 17: The Device Setting Page	29
Figure 18: The Firmware Upgrade Page	30
Figure 19: The About Us Page	31
Figure 20: TP Pinout Wiring	32

1 Introduction

Welcome to Kramer Electronics! Since 1981, Kramer Electronics has been providing a world of unique, creative, and affordable solutions to the vast range of problems that confront video, audio, presentation, and broadcasting professionals on a daily basis. In recent years, we have redesigned and upgraded most of our line, making the best even better!

Our 1,000-plus different models now appear in 14 groups that are clearly defined by function: GROUP 1: Distribution Amplifiers; GROUP 2: Switchers and Routers; GROUP 3: Control Systems; GROUP 4: Format/Standards Converters; GROUP 5: Range Extenders and Repeaters; GROUP 6: Specialty AV Products; GROUP 7: Scan Converters and Scalers; GROUP 8: Cables and Connectors; GROUP 9: Room Connectivity; GROUP 10: Accessories and Rack Adapters; GROUP 11: Sierra Video Products; GROUP 12: Digital Signage; GROUP 13: Audio; and GROUP 14: Collaboration.

Congratulations on purchasing your Kramer **VS-42UHD 4x2 HDMI Matrix Switcher**. This product, which incorporates HDMI™ technology, is ideal for:

- Conference rooms
- Education
- Hospitality

2 Getting Started

We recommend that you:

- Unpack the equipment carefully and save the original box and packaging materials for possible future shipment
- Review the contents of this user manual



Go to www.kramerav.com/downloads/VS-42UHD to check for up-to-date user manuals, application programs, and to check if firmware upgrades are available (where appropriate).

2.1 Achieving the Best Performance

To achieve the best performance:

- For optimum range and performance, use the recommended Kramer cables available at www.kramerav.com/product/VS-42UHD
- Do not secure the cables in tight bundles or roll the slack into tight coils
- Avoid interference from neighbouring electrical appliances that may adversely influence signal quality
- Position your **VS-42UHD** away from moisture, excessive sunlight and dust



This equipment is to be used only inside a building. It may only be connected to other equipment that is installed inside a building.

2.2 Safety Instructions DC



Caution: There are no operator serviceable parts inside the unit

Warning: Use only the Kramer Electronics power supply that is provided with the unit

Warning: Disconnect the power and unplug the unit from the wall before installing

2.3 Recycling Kramer Products

The Waste Electrical and Electronic Equipment (WEEE) Directive 2002/96/EC aims to reduce the amount of WEEE sent for disposal to landfill or incineration by requiring it to be collected and recycled. To comply with the WEEE Directive, Kramer Electronics has made arrangements with the European Advanced Recycling Network (EARN) and will cover any costs of treatment, recycling and recovery of waste Kramer Electronics branded equipment on arrival at the EARN facility. For details of Kramer's recycling arrangements in your particular country go to our recycling pages at www.kramerav.com/support/recycling/.

3 Overview

The **VS-42UHD** is a high quality, 4x2 matrix switcher for HDMI signals. It reclocks and equalizes the signals and can route any input to either or both outputs simultaneously.

In particular, the **VS-42UHD** features:

- Up to 8.91Gbps data rate (2.97Gbps per graphics channel)
Suitable for resolutions up to UXGA and 4K x 2K
- Support for HDCP (High Definition Digital Content Protection)
- True video clock detection
- Automatic switching modes (last connected and priority switching)
- HDMI Support – 3D, Deep Color, x.v.Color™, Lip Sync, Dolby® TrueHD, Dolby Digital Plus, DTS–HD®, and 7.1 multi-channel audio
- I-EDIDPro™ Kramer Intelligent EDID Processing™ – Intelligent EDID handling & processing algorithm ensures Plug and Play operation for HDMI systems
- Programmable step-in functionality when used in conjunction with compatible step-in devices, such as **SID-X3N** and **DIP-31** (using an HDMI cable that supports HEC, the HDMI Ethernet Channel)
- Non-volatile EDID storage
- Kramer reClocking™ & Equalization Technology that rebuilds the digital signal to travel longer distances
- Static or dynamic DHCP IP addressing
- Embedded Web pages that provide remote configuration and operation
- A lock button to prevent unwanted tampering with the buttons on the front panel
- Support for Kramer Protocol 3000

You can control the **VS-42UHD** using the front panel buttons, or remotely via:

- RS-232 serial commands transmitted by a PC, touch screen system or other serial controller
- The Kramer **RC-IR3** infrared, remote control transmitter
- A PC connected via a LAN to the Ethernet port on the **VS-42UHD**
- An optional, external, remote IR receiver (see [Section 3.1](#))

3.1 Using the IR Transmitter

You can use the **RC-IR3** IR transmitter to control the machine via the built-in IR receiver on the front panel or, instead, via an optional external IR receiver (for example, P/N C-A35M/IRR-50). The external IR receiver can be located up to 15m away from the machine. This distance can be extended to up to 60m when used with three extension cables (for example, P/N C-A35M/A35F-50).

Before using the external IR receiver, be sure to arrange for your Kramer dealer to insert the internal IR connection cable (for example, P/N: 505-70434010-S) with the 3.5mm connector that fits into the REMOTE IR opening on the rear panel. Connect the external IR receiver to the REMOTE IR 3.5mm connector.

3.2 Defining the VS-42UHD 4x2 HDMI Matrix Switcher

This section defines the **VS-42UHD**.

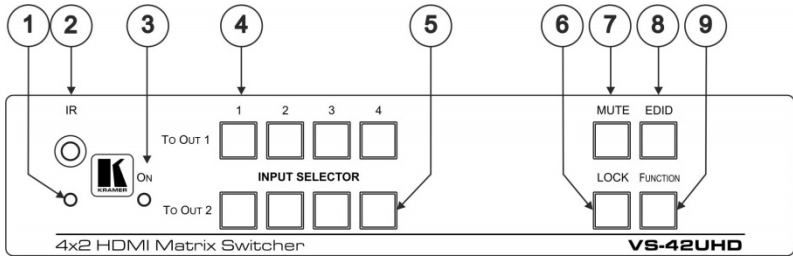

Figure 1: VS-42UHD 4x2 HDMI Matrix Switcher Front

#	Feature	Function
1	IR LED	Lights yellow when receiving an IR signal
2	IR Sensor	Signal receiver for the infrared remote control transmitter
3	ON LED	Lights green when the device is powered on
4	INPUT SELECTOR TO OUT 1 1~4	Press one of the four inputs to switch it to Output 1 Press the currently selected input button to mute the output
5	INPUT SELECTOR TO OUT 2 1~4	Press one of the four inputs to switch it to Output 2 Press the currently selected input button to mute the output
6	LOCK Button	Press and hold to lock the front panel buttons. Press and hold again to unlock (see Section 6.4)
7	MUTE Button	Press to toggle mute of both output signals (see Section 6.3)
8	EDID Button	Press to capture the EDID (see Section 6.2)
9	FUNCTION Button	Press to activate the test pattern generator. When the generator is active, press one of the input buttons to select a test pattern (see Section 6.5)

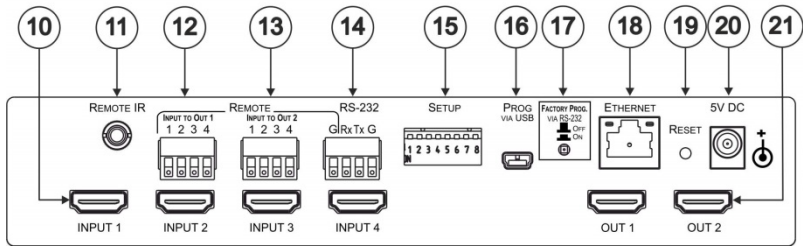

Figure 2: VS-42UHD 4x2 HDMI Matrix Switcher Rear

#	Feature	Function
10	<i>INPUT 1–4</i> HDMI Input Connectors	Connect to up to four HDMI sources (see Section 6.1)
11	<i>REMOTE IR</i> Opening	Connect to an external IR receiver for controlling the device via an IR remote controller (see Section 3.1). Covered by a cap. The 3.5mm mini jack at the end of the internal IR connection cable fits into this opening
12	<i>REMOTE INPUT To OUT 1</i> 4-pin Terminal Block	Connect to up to four remote, contact-closure input selection switches for Output 1 (see Section 4.3)
13	<i>REMOTE INPUT To OUT 2</i> 4-pin Terminal Block	Connect to up to four remote, contact-closure input selection switches for Output 2 (see Section 4.3)
14	<i>RS-232</i> 3-pin Terminal Block	Connect to a PC/serial controller (see Section 4.1)
15	<i>SETUP</i> 8-way DIP-switch	Sets the device configuration (see Section 7.1)
16	<i>PROG VIA USB</i> Connector	Connect to a PC to upgrade the firmware (see Section 7.3)
17	<i>PROG VIA RS-232 Upgrade Switch</i>	Press to upgrade the firmware via the RS-232 port, release for normal operation
18	<i>ETHERNET</i> RJ-45 Connector	Connect to a PC via a LAN (see Section 4.2)
19	<i>RESET</i> Switch	Press while power-cycling the device to reset to factory default parameters (see Section 7.2)
20	<i>5V DC</i> Connector	Connect to the power adapter, center pin positive
21	<i>OUT 1</i> and <i>OUT 2</i> HDMI Output Connectors	Connect to up to two HDMI acceptors

4 Connecting the VS-42UHD



Always switch off the power to each device before connecting it to your **VS-42UHD**. After connecting your **VS-42UHD**, connect its power and then switch on the power to each device.



You do not have to connect all the inputs and outputs, connect only those that are required.

To connect the **VS-42UHD**, as illustrated in the example in [Figure 3](#), do the following:

1. Connect up to four HDMI sources, (for example, Blu-ray Disc players) to the HDMI Input connectors.
2. Connect the two OUT HDMI connectors to up to two HDMI acceptors, (for example, LCD displays with built-in speakers).
3. If required, connect a PC/controller to the RS-232 port (see [Section 4.1](#)) and/or the Ethernet port (see [Section 4.2](#)).
4. Connect the power adapter to the device and plug the power adapter into the mains electricity (not shown in [Figure 3](#)).
5. If required, acquire the EDID (see [Section 6.1](#)).

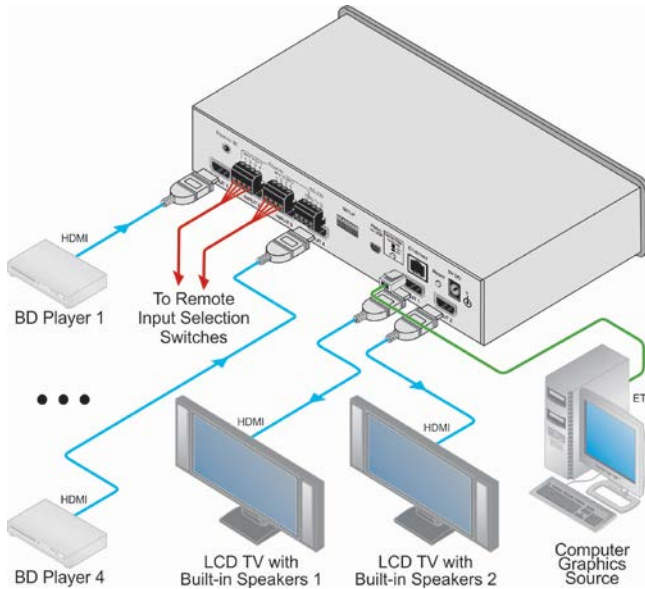

Figure 3: Connecting the VS-42UHD 4x2 HDMI Matrix Switcher

4.1 Connecting a Serial Controller via RS-232

To connect a serial controller to the VS-42UHD:

- From the RS-232 9-pin D-sub serial port on the serial controller connect:
 - Pin 2 to the TX pin on the **VS-42UHD** RS-232 terminal block
 - Pin 3 to the RX pin on the **VS-42UHD** RS-232 terminal block
 - Pin 5 to the GND pin on the **VS-42UHD** RS-232 terminal block

4.2 Connecting to the VS-42UHD via Ethernet

You can connect to the **VS-42UHD** via Ethernet using either of the following methods:

- Directly to the PC using a crossover cable (see [Section 4.2.1](#))
- Via a network hub, switch, or router, using a straight-through cable (see [Section 4.2.2](#))

Note: If you want to connect via a router and your IT system is based on IPv6, speak to your IT department for specific installation instructions.

4.2.1 Connecting the Ethernet Port Directly to a PC

You can connect the Ethernet port of the **VS-42UHD** directly to the Ethernet port on your PC using a crossover cable with RJ-45 connectors.



This type of connection is recommended for identifying the **VS-42UHD** with the factory configured default IP address.

After connecting the VS-42UHD to the Ethernet port, configure your PC as follows:

1. Click **Start > Control Panel > Network and Sharing Center**.
2. Click **Change Adapter Settings**.
3. Highlight the network adapter you want to use to connect to the device and click **Change settings of this connection**.

The Local Area Connection Properties window for the selected network adapter appears as shown in [Figure 4](#).

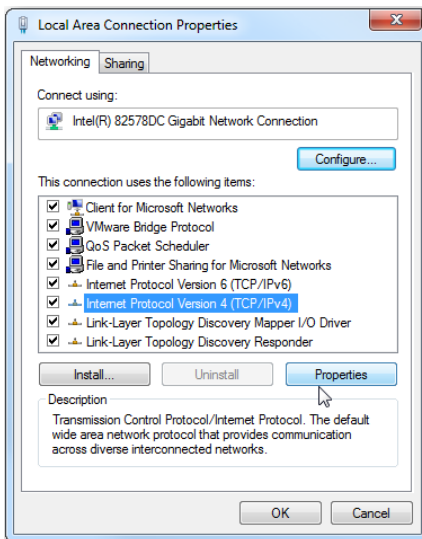

Figure 4: Local Area Connection Properties Window

4. Highlight **Internet Protocol Version 4 (TCP/IPv4)** by clicking on the item.
5. Click **Properties**.

The Internet Protocol Properties window appears as shown in [Figure 5](#).

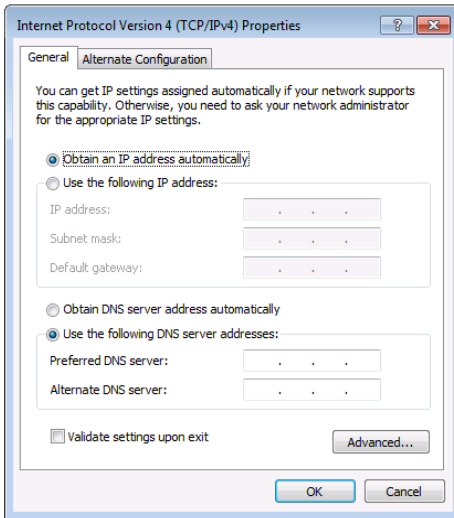

Figure 5: Internet Protocol Version 4 Properties Window

6. Select **Use the following IP Address** for static IP addressing and fill in the details as shown in [Figure 6](#).

For TCP/IPv4 you can use any IP address in the range 192.168.1.1 to 192.168.1.255 (excluding 192.168.1.39) that is provided by your IT department.

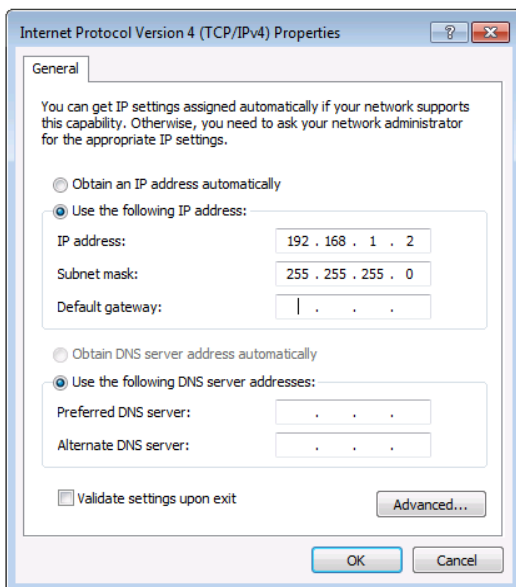

Figure 6: Internet Protocol Properties Window

7. Click **OK**.
8. Click **Close**.

4.2.2 Connecting the Ethernet Port via a Network Hub or Switch

You can connect the Ethernet port of the **VS-42UHD** to the Ethernet port on a network hub or using a straight-through cable with RJ-45 connectors.

4.3 Connecting the Remote Contact-Closure Switches

You can connect up to four remote, contact-closure switches per output to control the **VS-42UHD** remotely. These switches replicate the Input selection buttons on the front panel of the **VS-42UHD**.

Figure 7 illustrates the wiring of the switch connections to the terminal block.

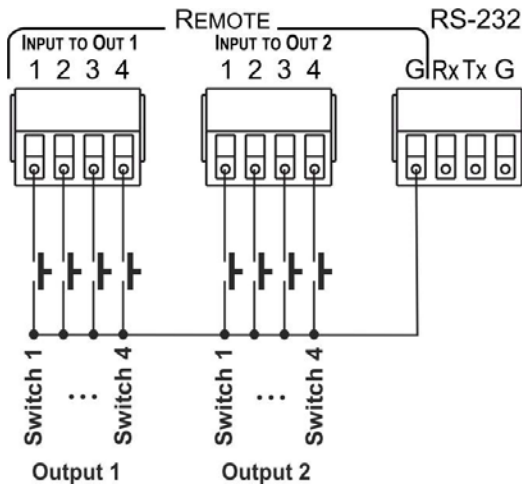

Figure 7: Remote Contact-closure Switch Connections

5 Principles of Operation

This section describes the operating theory of the **VS-42UHD** and includes:

- Automatic signal detection (see [Section 5.1](#))
- Input switching modes (see [Section 5.2](#))
- EDID operation (see [Section 5.3](#))

5.1 Automatic Signal Detection

The **VS-42UHD** can automatically detect the presence of a video signal on an input based on the presence of a video sync or clock signal.

5.2 Input Switching Modes

5.2.1 Manual Mode

In Manual switching mode, routing is performed according to the front panel button selection or according to the remote command selection.

5.2.2 Automatic Mode

Automatic switching can be performed in either of the following ways:

- **Input priority.** Upon detection of an active input, the input with the highest priority is automatically selected. Input priority is from the lowest input number (1) to the highest (4)
- **Last Connected.** The device automatically selects the most recently connected input. Should this source become inactive, the device automatically switches to the last connected input that was active. When turning the device on and more than one input is active, the input with the highest priority is selected

If a manual selection is made when the device is in Automatic mode, the device enters Manual Override mode. The manually selected input remains selected as long as it is active. When a manually selected input becomes inactive, the device returns to Automatic mode.

5.3 EDID Operation

The **VS-42UHD** has a default EDID (see [Section 12](#)) stored on all inputs. This EDID can be exchanged for either:

- A custom EDID which is uploaded to one or more inputs using Protocol 3000 commands (see [Section 13.3.5](#))
–OR–
- The EDID of a display device connected to an output by using either the front panel buttons (see [Section 6.2](#)), a Protocol 3000 command, or the Web pages

The EDID is non-volatile and the last valid EDID is used when the device is powered up.

5.4 Step-in Functionality

The **VS-42UHD** can function as a step-in switcher when connected to a suitable HDMI transmitter, (for example, the **SID-X3N** or **DIP-31**) using the correct HDMI cable with HEC support.

Use the Web pages (see [Section 8.2.2](#)) to assign remote device button actions.

The default button actions are shown in the following table. Up to three buttons can be active at the same time.

Command	Action
Echo	Allows a connected controller to be programmed to perform a variety of tasks triggered by the user buttons, such as, room control, (lights, screen, and so on)
Out1	Step in current input to Output 1
Out2	Step in current input to Output 2

6 Operating the VS-42UHD 4x2 HDMI Matrix Switcher

This section describes operating the **VS-42UHD** and consists of:

- Switching an input to an output (see [Section 6.1](#))
- Acquiring an EDID from an output (see [Section 6.2](#))
- Muting and unmuting the outputs (see [Section 6.3](#))
- Locking and unlocking the front panel buttons (see [Section 6.4](#))
- Generating a test pattern (see [Section 6.5](#))

6.1 Switching an Input to an Output

To switch an input to an output, (for example, Input 4 to Output 2):

- Press the Input 4 button in the bottom Output (To OUT 2) row.
The LED lights red and Input 4 is switched to Output 2

6.2 Acquiring an EDID from an Output

You can acquire the EDID from OUT 1 or OUT 2 and copy it to any or all of the four inputs to be stored in non-volatile memory. You can also reset any or all of the inputs to the default EDID.

To copy the EDID from an Output to one or more Inputs:

1. Press the EDID button to enter the EDID setting mode.

The EDID button lights.

Note: If there is no button activity for 10 seconds, the device automatically exits the EDID setting mode to normal operation, the EDID button no longer lights and any changes made are lost.

2. From the To OUT 1 (top) row, press each of the Inputs to which you want to copy the EDID from Output 1.
Each selected Input LED lights.

3. From the To OUT 2 (bottom) row, press each of the Inputs into which you want to copy the EDID from Output 2.
Each selected Input LED lights.
4. Press the EDID button.
The button no longer lights and the EDID changes are saved.

To copy the default EDID to one or more Inputs:

1. Press the EDID button to enter the EDID setting mode.
The EDID button lights.
2. For each Input to which you want to copy the default EDID, press both the To OUT 1 and To OUT 2 buttons simultaneously.
Both top row and bottom row Input LEDs light.
3. Press the EDID button.
The button no longer lights and the EDID changes are saved.

6.3 Muting and Unmuting the Outputs

To mute and unmute both outputs simultaneously:

1. Press the Mute button.
The Mute button lights and the outputs are muted.
2. Press the lit Mute button.
The outputs are unmuted and the button no longer lights.

To mute and unmute one output:

1. Press the currently selected (and lit) input button.
The output is muted and the button flashes.
2. Press the currently muted (and flashing) input button.
The output is unmuted and the button lights solid.

6.4 Locking and Unlocking the Front Panel Buttons

To lock and unlock the front panel buttons:

1. Press and hold the Lock button.
The front panel buttons are locked and the button lights.
2. Press and hold the Lock button again.
The front panel buttons are unlocked and the button no longer lights.

6.5 Generating a Test Pattern

For diagnostic purposes, the **VS-42UHD** can generate a number of test patterns on the outputs. [Figure 8](#) shows the test patterns available.

To generate a test pattern on the outputs:

1. Press the Function button.
The button lights.
2. Press any of the Input buttons to select a test pattern.
The selected test pattern is generated on the outputs.

To exit the test pattern generator:

- Press the lit Function button.
The test pattern generation ceases and the button no longer lights.

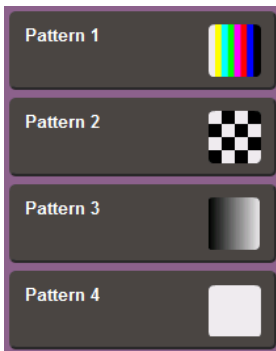

Figure 8: Available Test Patterns

7 Configuring and Maintaining the VS-42UHD

This section describes the configuration and maintenance of the **VS-42UHD** and consists of:

- Setting the DIP-switches (see [Section 7.1](#))
- Resetting the device to factory default settings (see [Section 7.2](#))
- Upgrading the firmware (see [Section 7.3](#))

7.1 Setting the DIP-Switches

The DIP-switches dictate the behavior of the **VS-42UHD**.

All DIP-switches are off by default.

#	Feature	Description
1	HDCP support on inputs	On—Disable HDCP support on all inputs Off—Enable HDCP support which is defined by P3000 commands
2	Video mode switching Output 1	On—Auto Off—Manual
3	Last connected/Priority mode Output 1	When DIP-switch 2 is set to Auto (ON): On—Enable Last Connected mode Off—Enable Priority mode where the priority of each input is defined by the input number, (1 is the highest priority)
4	Video mode switching Output 2	On—Auto Off—Manual
5	Last connected/Priority mode Output 2	When DIP-switch 4 is set to Auto (ON): On—Enable Last Connected mode Off—Enable Priority mode where the priority of each input is defined by the input number, (1 is the highest priority)
6	N/A	—
7	N/A	—
8	N/A	—

7.2 Resetting the VS-42UHD to Factory Default Settings

To reset the device to factory default settings:

1. Power the device off.
2. Press and hold down the Reset button on the rear panel.
3. While holding down the Reset button, power on the device.
4. Wait a few seconds and release the button.
The device is reset to its factory settings.

7.3 Upgrading the Firmware

The **VS-42UHD** can be upgraded via any of the following:

- Mini USB
- RS-232
- Ethernet

For instructions on upgrading the firmware see “*K-Upload Software*”.

8 Operating the VS-42UHD Remotely via the Web Pages

The **VS-42UHD** can be operated remotely using the embedded Web pages. The Web pages are accessed using a Web browser and an Ethernet connection.

Before attempting to connect:

- Perform the procedures in [Section 4.2](#)
- Ensure that your browser is supported (see [Section 10](#))
- Ensure that JavaScript is enabled

There are six Web pages:

- Browsing and General Info (see [Section 8.1](#))
- Routing (see [Section 8.2](#))
- EDID (see [Section 8.3](#))
- Device Setting (see [Section 8.4](#))
- Firmware Update (see [Section 8.5](#))
- About Us (see [Section 8.6](#))

8.1 Browsing the VS-42UHD Web Pages

Note: In the event that a Web page does not update correctly, clear your Web browser's cache (by pressing CTRL-F5).

To browse the VS-42UHD Web pages:

1. Open your Internet browser.
2. Type the IP number of the device (see [Section 4.2](#)) in the Address bar of your browser.



The Loading page appears:

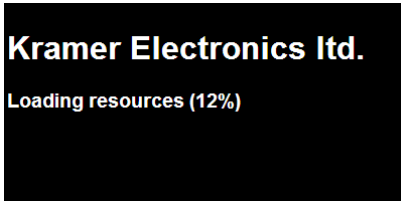

Figure 9: The Loading Page

Immediately after the Loading page, the General Info page appears which displays information related to the device and the Web page version.

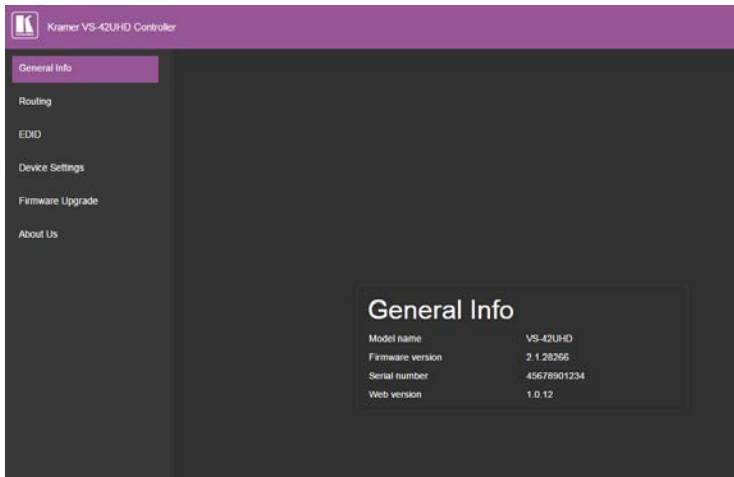

Figure 10: The General Info Page

8.2 Routing Page

The **VS-42UHD** Routing page lets you perform operational actions, such as, switching inputs/outputs and selecting HDCP support.

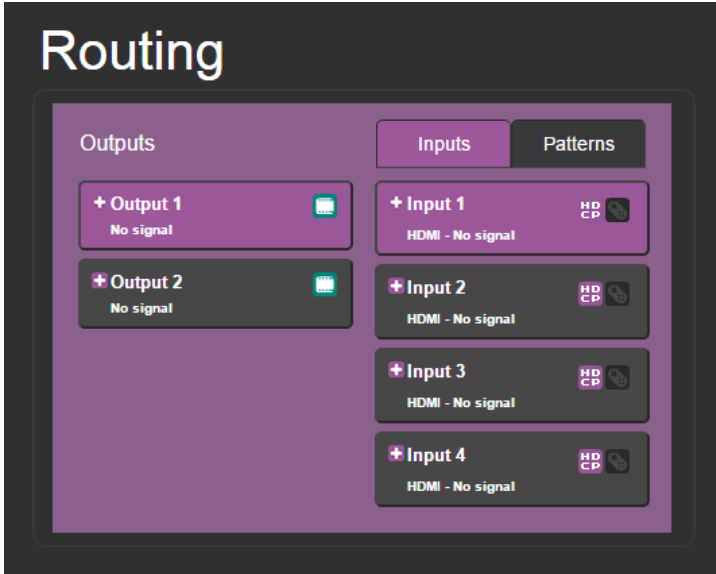

Figure 11: The Routing Page

Item	Description
Output Buttons 1 and 2	2 Buttons for output selection, signal identification, and audio and video muting (see Section 8.2.1)
Inputs Tab	4 Buttons for input selection, and port and signal identification (see Section 8.2.1)
Patterns Button Tab	4 Buttons for video pattern generation (see Section 8.2.3)

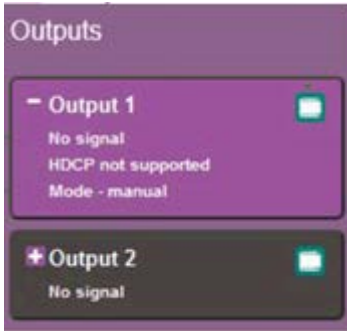

Figure 12: The Output Buttons

Item	Description
Output Button Number	Identifies the Output number
HDCP Indicator	Indicates whether the Output port supports HDCP
Video Mute Button	Click the button to mute the video
Signal Indicator	Indicates whether or not there is a device connected to the output
Mode Indicator	Indicates the switching mode currently employed

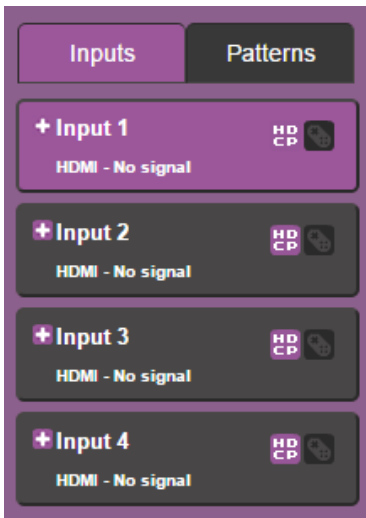

Figure 13: The Input Buttons

Item	Description
Input Button Number	Identifies the Input number
Input Type and Signal Indicator	Indicates the type of input and whether there is a signal present on the Input
HDCP Selection Button	Click the button to turn HDCP support for the Input on and off
HDCP Content Indicator	Indicates whether or not the Input signal is HDCP protected
Remote Device Control Button	Click the button to display the control window for the remote device connected to this Input (see Section 8.2.2)

8.2.1 Switching an Input to an Output

To switch an Input to an Output, (for example, Input 2 to Output 2):

1. Click on Output button 2.
The button changes color to purple and the Output is selected.
2. Click on Input button 2.
The button changes color to purple and the output is switched.

8.2.2 Controlling a Remote Transmitter

Compatible remote transmitters, (for example, the **SID-X3N** or **DIP-31**) that are connected to the **VS-42UHD** can be controlled using the Web pages, (see [Section 8.2, Figure 13](#)).



Figure 14: The Remote Device Control Window

The **VS-42UHD** allows you to program the general purpose buttons on remote modules. The table shows the functionality defined for each button. The options are:

- HDMI—selects one of the four inputs
- Echo—allows a connected controller to be programmed to perform a variety of tasks triggered by the user buttons, such as, room control, (lights, screen, and so on)
- Out 1—step-in current input to output 1
- Out 2—step-in current input to output 2

Note: These settings are per input and remain valid even if the remote **SID-X3N** is exchanged for another **SID-X3N**.

Up to three of the Echo, Out 1 and Out 2 buttons can be active at the same time.

8.2.3 Using Test Patterns as Video Inputs

You can use one of four built-in, video test patterns as a video Input.

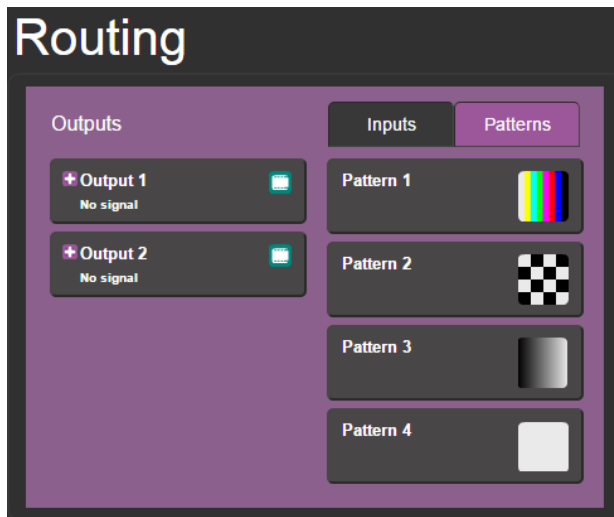

Figure 15: Test Pattern Tab

To select a test pattern as an Input for an Output:

1. Click the Patterns tab.
The four test pattern buttons are shown.
2. Click the required Output to select it.
The button changes color.
3. Click the required test pattern button.
The button changes color and the selected test pattern is switched to the Output.

8.3 EDID Page

The **VS-42UHD** EDID page lets you copy EDID data to one or more Inputs from an:

- Output
- Input
- EDID data file

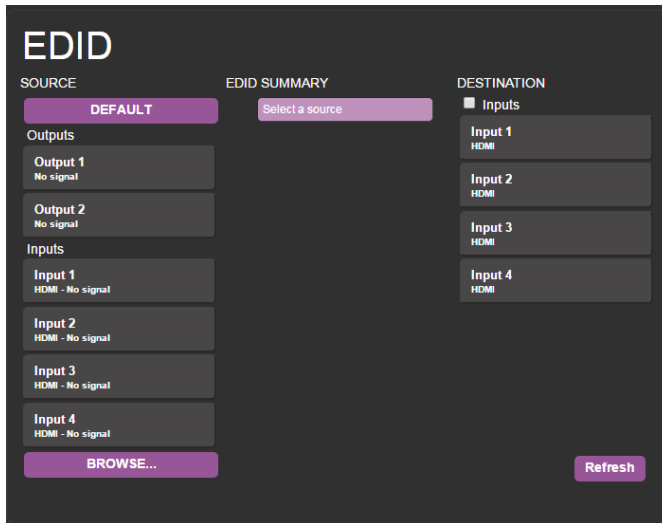

Figure 16: The EDID Page

Note: The display is not updated automatically when the status of an EDID changes on the device due to outputs being exchanged. Click Refresh to update the display.

To copy EDID data from an Output or Input to one or more inputs:

1. Click the source button from which to copy the EDID (Output or Input).
The button changes color and the EDID summary information reflects the EDID data.
2. Click one or more destination Inputs, or select all Inputs by checking the Inputs check-box.
All selected Input buttons change color and the EDID summary information reflects the Input selection(s).
3. Click the Copy button.
The "EDID was copied" success message is displayed and the EDID data are copied to the selected Input(s).
4. Click OK.

To copy EDID data to an Input from an EDID data file:

1. Click the source Browse button.
The Windows Browser opens.
2. Browse to the required file.
3. Select the required file and click Open.
The EDID summary information reflects the selection.
4. Click one or more destination Inputs, or select all Inputs by checking the Inputs check-box.
All selected Input buttons change color and the EDID summary information reflects the Input selection(s).
5. Click the Copy button.
The "EDID was copied" success message is displayed and the EDID data are copied to the selected Input(s).

6. Click OK.

8.4 Device Setting Page

The **VS-42UHD** Device Settings page lets you modify some communication parameters and view others.

Device Settings

Unit Info

Unit Name

RS-232

Baud rate

Ethernet

DHCP

IP address

UDP Port

Mask

Gateway

MAC b1-b2-b3-b4-b5-b6

Figure 17: The Device Setting Page

To modify serial or Ethernet communication parameters:

1. Adjust the parameters as required, either by entering the parameters directly or by using the drop-down list.
2. Click Set.
The changes are saved.

8.5 Firmware Upgrade Page

The Firmware Upgrade page lets you perform a firmware upgrade from a firmware file.

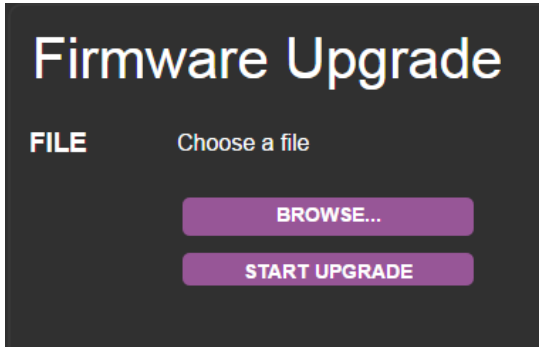

Figure 18: The Firmware Upgrade Page

To upgrade the firmware:

1. Click the Choose File button.
The Windows Browser opens.
2. Browse to the required file.
3. Select the required file and click Open.
The firmware file name is displayed in the Firmware Upgrade page.
4. Click Start Upgrade.
The firmware file is loaded and a progress bar is displayed.



Do not interrupt the process or the **VS-42UHD** may be damaged.

5. When the process is complete reboot the device.
The firmware is upgraded.

8.6 About Us Page

The **VS-42UHD** About Us page displays the Web page version and Kramer Electronics Ltd company details.



Figure 19: The About Us Page

9 Wiring the Twisted Pair RJ-45 Connectors

Connect/solder the cable shield to the RJ-45 connector shield.



Do not use a crossed TP cable with this product.

Using a TP cable that is incorrectly wired may cause permanent damage to the device

Do not use unshielded TP cables with this product

The following figure defines the TP pinout using a straight pin-to-pin cable with RJ-45 connectors.

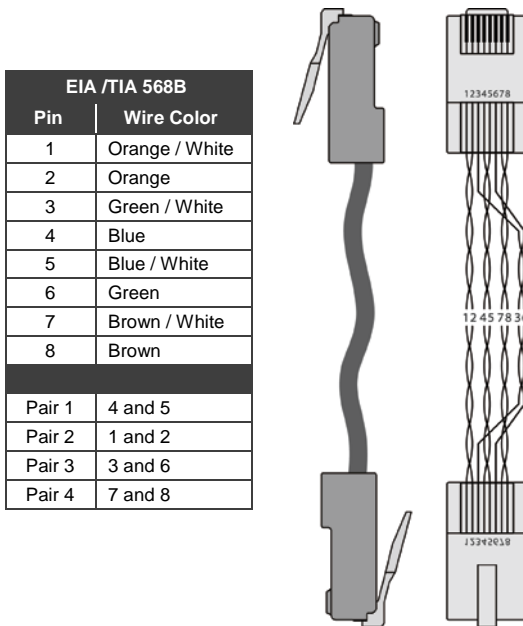

Figure 20: TP Pinout Wiring

10 Technical Specifications

INPUTS:	4 HDMI Connectors
OUTPUTS:	2 HDMI Connectors
PORTS:	1 Ethernet on an RJ-45 connector 1 IR on a 3.5mm mini jack 8 Remote selection contact-closure switches on 9 terminal block pins 1 Serial port on a 3-pin terminal block 1 Program port on a mini USB
BANDWIDTH:	Up to 8.91Gbps data rate (2.97Gbps per graphic channel)
COMPLIANCE WITH HDMI STANDARD:	HDMI and HDCP
RESOLUTION:	Up to UXGA; 4K x 2K
SUPPORTED BAUD RATES:	9600, 115200bps
SUPPORTED WEB BROWSERS:	The following operating systems and Web browsers are supported: Windows 7: <ul style="list-style-type: none"> • Google Chrome v25 • FireFox v15 • Opera v12 • Microsoft Internet Explorer v9 Windows XP: <ul style="list-style-type: none"> • Google Chrome v25 • FireFox v15 Apple Mac: <ul style="list-style-type: none"> • Google Chrome v25 • FireFox v20 • Opera v12.14 • Safari v6
POWER CONSUMPTION:	5V DC, 880mA
CONTROLS:	Front panel buttons, infrared remote control transmitter, RS-232, Ethernet, Remote input selection switches
OPERATING TEMPERATURE:	0° to +40°C (32° to 104°F)
STORAGE TEMPERATURE:	-40° to +70°C (-40° to 158°F)
HUMIDITY:	10% to 90%, RHL non-condensing
POWER CONSUMPTION:	100-240V AC, 65VA max.
DIMENSIONS:	21.5cm x 16.6cm x 4.4cm (8.46" x 6.54" x 1.73") W, D, H
WEIGHT:	0.9kg (2.0lbs) approx.
SHIPPING DIMENSIONS:	35.1cm x 21.2cm x 7.2cm (13.8" x 8.4" x 2.8") W, D, H
SHIPPING WEIGHT:	1.6kg (3.5lbs) approx.
INCLUDED ACCESSORIES:	Power supply, RC-IR3 remote control
OPTIONS:	External remote IR receiver cable, RK-1
<p>Specifications are subject to change without notice For the most updated resolution list, go to our Web site at www.kramerav.com</p>	

11 Default Communication Parameters

RS-232	
Protocol 3000	
Baud Rate:	115,200
Data Bits:	8
Stop Bits:	1
Parity:	None
Command Format:	ASCII
TCP/IP Parameters	
IP Address:	192.168.1.39
Netmask:	255.255.0.0
Gateway:	0.0.0.0
TCP Port #:	5000
UDP Port #:	50000

12 Default EDID

Monitor

Model name..... VS-42UHD
Manufacturer..... KMR
Plug and Play ID..... KMR1200
Serial number..... 505-70990100
Manufacture date..... 2011, ISO week 255
Filter driver..... None

EDID revision..... 1.3
Input signal type..... Digital
Color bit depth..... Undefined
Display type..... RGB color
Screen size..... 520 x 320 mm (24.0 in)
Power management..... Standby, Suspend, Active off/sleep
Extension blocs..... 1 (CEA-EXT)

DDC/CI..... Not supported

Color characteristics

Default color space..... Non-sRGB
Display gamma..... 2.20
Red chromaticity..... Rx 0.674 - Ry 0.319
Green chromaticity..... Gx 0.188 - Gy 0.706
Blue chromaticity..... Bx 0.148 - By 0.064
White point (default).... Wx 0.313 - Wy 0.329
Additional descriptors... None

Timing characteristics

Horizontal scan range.... 30-83kHz
Vertical scan range..... 56-76Hz
Video bandwidth..... 170MHz
CVT standard..... Not supported
GTF standard..... Not supported
Additional descriptors... None
Preferred timing..... Yes
Native/preferred timing., 1280x720p at 60Hz (16:10)
Modeline..... "1280x720" 74.250 1280 1390 1430 1650 720 725 730 750 +hsync +vsync

Standard timings supported

720 x 400p at 70Hz - IBM VGA
720 x 400p at 88Hz - IBM XGA2
640 x 480p at 60Hz - IBM VGA
640 x 480p at 67Hz - Apple Mac II
640 x 480p at 72Hz - VESA
640 x 480p at 75Hz - VESA
800 x 600p at 56Hz - VESA
800 x 600p at 60Hz - VESA
800 x 600p at 72Hz - VESA
800 x 600p at 75Hz - VESA
832 x 624p at 75Hz - Apple Mac II
1024 x 768i at 87Hz - IBM
1024 x 768p at 60Hz - VESA
1024 x 768p at 70Hz - VESA
1024 x 768p at 75Hz - VESA
1280 x 1024p at 75Hz - VESA
1152 x 870p at 75Hz - Apple Mac II
1280 x 1024p at 75Hz - VESA STD
1280 x 1024p at 85Hz - VESA STD
1600 x 1200p at 60Hz - VESA STD
1024 x 768p at 85Hz - VESA STD
800 x 600p at 85Hz - VESA STD
640 x 480p at 85Hz - VESA STD
1152 x 864p at 70Hz - VESA STD
1280 x 960p at 60Hz - VESA STD

EIA/CEA-861 Information

Revision number..... 3
IT underscan..... Supported
Basic audio..... Supported
YCbCr 4:4:4..... Supported
YCbCr 4:2:2..... Supported
Native formats..... 1
Detailed timing #1..... 1920x1080p at 60Hz (16:10)

13 Protocol 3000

The **VS-42UHD** can be operated using the Kramer Protocol 3000 serial commands. The command framing varies according to how you interface with the **VS-42UHD**. For example, a basic video input switching command that routes a layer 1 video signal to HDMI out 1 from HDMI input 2 (`ROUTE 1, 1, 2`), is entered as follows:

- Terminal communication software, such as Hercules:

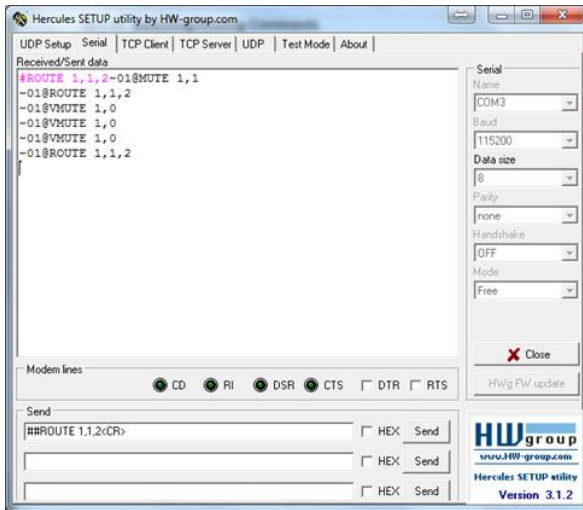

The framing of the command varies according to the terminal communication software.

- K-Touch Builder (Kramer software):

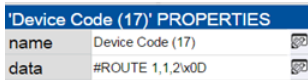

- K-Config (Kramer configuration software):

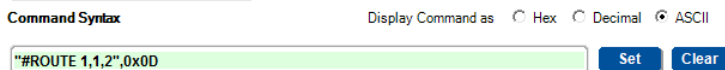

All the examples provided in this section are based on using the K-Config software.

You can enter commands directly using terminal communication software (e.g., Hercules) by connecting a PC to the serial or Ethernet port on the **VS-42UHD**. To enter `CR` press the Enter key (`LF` is also sent but is ignored by the command parser).

Commands sent from various non-Kramer controllers (e.g., Crestron) may require special coding for some characters (such as, /x##). For more information, refer to your controller's documentation.

For more information about:

- Understanding Protocol 3000, see [Section 13.1](#)
- General syntax used for Protocol 3000 commands, see [Section 13.2](#)
- Protocol 3000 commands available for the **VS-42UHD**, see [Section 13.3](#)

13.1 Understanding Protocol 3000

Protocol 3000 commands are structured according to the following:

- **Command** – A sequence of ASCII letters (A-Z, a-z and -). A command and its parameters must be separated by at least one space.
- **Parameters** – A sequence of alphanumeric ASCII characters (0-9, A-Z, a-z and some special characters for specific commands). Parameters are separated by commas.
- **Message string** – Every command entered as part of a message string begins with a message starting character and ends with a message closing character.



A string can contain more than one command. Commands are separated by a pipe (|) character.

The maximum string length is 64 characters.

- **Message starting character:**
 - # – For host command/query
 - ~ – For device response
- **Device address** – K-NET Device ID followed by @ (optional, K-NET only)
- **Query sign** – ? follows some commands to define a query request
- **Message closing character:**
 - CR – Carriage return for host messages (ASCII 13)
 - CR LF – Carriage return for device messages (ASCII 13) and line-feed (ASCII 10)
- **Command chain separator character** – Multiple commands can be chained in the same string. Each command is delimited by a pipe character (|). When chaining commands, enter the message starting character and the message closing character only at the beginning and end of the string.



Spaces between parameters or command terms are ignored. Commands in the string do not execute until the closing character is entered. A separate response is sent for every command in the chain.

13.2 Kramer Protocol 3000 Syntax

The Kramer Protocol 3000 syntax uses the following delimiters:

- **CR** = Carriage return (ASCII 13 = 0x0D)
- **LF** = Line feed (ASCII 10 = 0x0A)
- **SP** = Space (ASCII 32 = 0x20)

Some commands have short name syntax in addition to long name syntax to enable faster typing. The response is always in long syntax.

The Protocol 3000 syntax is in the following format:

- **Host Message Format:**

Start	Address (optional)	Body	Delimiter
#	<i>Device_id@</i>	Message	CR

- **Simple Command** – Command string with only one command without addressing:

Start	Address (optional)	Body	Delimiter
#		Command SP <i>Parameter_1,Parameter_2,...</i>	CR

- **Command String** – Formal syntax with command concatenation and addressing:

Start	Address (optional)	Body	Delimiter
#	<i>Device_id@</i>	Command_1 <i>Parameter1_1,Parameter1_2,...</i> Command_2 <i>Parameter2_1,Parameter2_2,...</i> Command_3 <i>Parameter3_1,Parameter3_2,...</i> ...	CR

- **Device Message Format:**

Start	Address (optional)	Body	Delimiter
~	<i>Device_id@</i>	Message	CR LF

- **Device Long Response** – Echoing command:

Start	Address (optional)	Body	Delimiter
~	<i>Device_id@</i>	Command SP [<i>Param1 ,Param2 ...</i>] result	CR LF

13.3 Protocol 3000 Commands

This section includes the following commands:

- System Commands (see [Section 13.3.1](#))
- Switching/Routing Commands (see [Section 13.3.2](#))
- Video Commands (see [Section 13.3.3](#))
- Communication Commands (see [Section 13.3.4](#))
- EDID Handling Commands (see [Section 13.3.5](#))

13.3.1 System Commands

Command	Description
#	Protocol handshaking (system mandatory)
BUILD-DATE	Get device build date (system mandatory)
FACTORY	Reset to factory default configuration
HELP	Get command list (system mandatory)
LOCK-FP	Set/get front panel lock
MODEL	Get device model (system mandatory)
PROT-VER	Get device protocol version (system mandatory)
RESET	Reset device (system mandatory)
SN	Get device serial number (system mandatory)
VERSION	Get device firmware version (system mandatory)
DISPLAY	Get output HPD status (system)
HDCP-MOD	Set/get HDCP mode (system)
HDCP-STAT	Get HDCP signal status (system)
NAME	Set/get machine (DNS) name (system – Ethernet)
NAME-RST	Reset machine (DNS) name to factory default (system – Ethernet)
PRIO?	Get priority for an input (system)
SIGNAL	Get input signal lock status (system)

13.3.1.1

Functions		Permission	Transparency
Set:	#	End User	Public
Get:	-	-	-
Description		Syntax	
Set:	Protocol handshaking	# <code>CR</code>	
Get:	-	-	
Response			
~ <code>nn</code> @ <code>SP</code> <code>OK</code> <code>CR LF</code>			
Parameters			
Response Triggers			
Notes			
Validates the Protocol 3000 connection and gets the machine number Step-in master products use this command to identify the availability of a device			
K-Config Example			
"#", 0x0D			

13.3.1.2 BUILD-DATE

Functions		Permission	Transparency
Set:	-	-	-
Get:	BUILD-DATE?	End User	Public
Description		Syntax	
Set:	-	-	
Get:	Get device build date	# <code>BUILD-DATE?</code> <code>CR</code>	
Response			
~ <code>nn</code> @ <code>BUILD-DATE</code> <code>SP</code> <code>date</code> <code>SP</code> <code>time</code> <code>CR LF</code>			
Parameters			
<i>date</i> – Format: YYYY/MM/DD where YYYY = Year, MM = Month, DD = Day <i>time</i> – Format: hh:mm:ss where hh = hours, mm = minutes, ss = seconds			
Response Triggers			
Notes			
K-Config Example			
"#BUILD-DATE?", 0x0D			

13.3.1.3 FACTORY

Functions		Permission	Transparency
Set:	FACTORY	End User	Public
Get:	-	-	-
Description		Syntax	
Set:	Reset device to factory default configuration	#FACTORY <code>CR</code>	
Get:	-	-	
Response			
~ <code>nn</code> @FACTORY <code>SP</code> OK <code>CR LF</code>			
Parameters			
Response Triggers			
Notes			
This command deletes all user data from the device. The deletion can take some time. Your device may require powering off and powering on for the changes to take effect.			
K-Config Example			
"#FACTORY", 0x0D			

13.3.1.4 HELP

Functions		Permission	Transparency
Set:	-	-	-
Get:	HELP	End User	Public
Description		Syntax	
Set:	-	-	
Get:	Get command list or help for specific command	1. #HELP <code>CR</code> 2. #HELP <code>SP</code> COMMAND_NAME <code>CR</code>	
Response			
1. Multi-line: ~ <code>nn</code> @Device available protocol 3000 commands: <code>CR LF</code> command, <code>SP</code> command... <code>CR LF</code>			
2. Multi-line: ~ <code>nn</code> @HELP <code>SP</code> command: <code>CR LF</code> description <code>CR LF</code> USAGE:usage <code>CR LF</code>			
Parameters			
COMMAND_NAME – name of a specific command			
Response Triggers			
Notes			
To get help for a specific command use: HELP <code>SP</code> COMMAND_NAME <code>CR LF</code>			
K-Config Example			
"#HELP", 0x0D			

13.3.1.5 LOCK-FP

Functions		Permission	Transparency
Set:	LOCK-FP	End User	Public
Get:	LOCK-FP?	End User	Public
Description		Syntax	
Set:	Set front panel lock	Option 1: # LOCK-FP _{SP} <i>lock_mode</i> _{CR}	
Get:	Get front panel lock state	Option 1: # LOCK-FP? _{CR}	
Response			
Set:	~ _{nn} @ LOCK-FP _{SP} <i>lock_mode</i> _{SP} OK _{CR LF}		
Get:	~ _{nn} @ LOCK-FP _{SP} <i>lock_mode</i> _{CR LF}		
Parameters			
<i>lock_mode</i> - 0/OFF - unlocks the front panel buttons, 1/ON - locks the front panel buttons			
Response Triggers			
Notes			
Lock the front panel buttons: "# LOCK-FP 1", 0x0D			

13.3.1.6 MODEL

Functions		Permission	Transparency
Set:	-	-	-
Get:	MODEL?	End User	Public
Description		Syntax	
Set:	-	-	
Get:	Get device model	#MODEL? [CR]	
Response			
~nn@MODEL [SP] model_name [CR LF]			
Parameters			
model_name – String of up to 19 printable ASCII chars			
Response Triggers			
Notes			
This command identifies equipment connected to Step-in master products and notifies of identity changes to the connected equipment. The Matrix saves this data in memory to answer REMOTE-INFO requests			
K-Config Example			
"#MODEL?" , 0x0D			

13.3.1.7 PROT-VER

Functions		Permission	Transparency
Set:	-	-	-
Get:	PROT-VER?	End User	Public
Description		Syntax	
Set:	-	-	
Get:	Get device protocol version	#PROT-VER? [CR]	
Response			
~nn@PROT-VER [SP] 3000:version [CR LF]			
Parameters			
version - XX.XX where X is a decimal digit			
Response Triggers			
Notes			
K-Config Example			
"#PROT-VER?" , 0x0D			

13.3.1.8 RESET

Functions		Permission	Transparency
Set:	RESET	Administrator	Public
Get:	-	-	-
Description		Syntax	
Set:	Reset device	# RESET <input type="checkbox"/>	
Get:	-	-	
Response			
~nn@ RESET <input type="checkbox"/> OK <input type="checkbox"/> CR LF			
Parameters			
Response Triggers			
Notes			
To avoid locking the port due to a USB bug in Windows, disconnect USB connections immediately after running this command. If the port was locked, disconnect and reconnect the cable to reopen the port.			
K-Config Example			
"#RESET", 0x0D			

13.3.1.9 SN

Functions		Permission	Transparency
Set:	-	-	-
Get:	SN?	End User	Public
Description		Syntax	
Set:	-	-	
Get:	Get device serial number	# SN? <input type="checkbox"/>	
Response			
~nn@ SN <input type="checkbox"/> serial_number <input type="checkbox"/> CR LF			
Parameters			
serial_number – 11 decimal digits, factory assigned			
Response Triggers			
Notes			
This device has a 14 digit serial number, only the last 11 digits are displayed			
K-Config Example			
"#SN?", 0x0D			

13.3.1.10 VERSION

Functions		Permission	Transparency
Set:	-	-	-
Get:	VERSION?	End User	Public
Description		Syntax	
Set:	-	-	
Get:	Get firmware version number	#VERSION? CR	
Response			
~nn@VERSION SP firmware_version CR LF			
Parameters			
firmware_version – XX.XX.XXXX where the digit groups are: major.minor.build version			
Response Triggers			
Notes			
K-Config Example			
"#VERSION?" , 0x0D			

13.3.1.11 DISPLAY

Functions		Permission	Transparency
Set:	-	-	-
Get:	DISPLAY?	End User	Public
Description		Syntax	
Set:	-	-	
Get:	Get output HPD status	#DISPLAY? SP out_id CR	
Response			
~nn@DISPLAY SP out_id,status CR LF			
Parameters			
out_id – 1 (HDMI Out) status – HPD status according to signal validation : 0 (Off), 1 (On), 2 (On and all parameters are stable and valid)			
Response Triggers			
A response is sent to the com port from which the Get was received, after command execution and: After every change in output HPD status from On to Off (0) After every change in output HPD status from Off to On (1) After every change in output HPD status form Off to On and all parameters (new EDID, etc.) are stable and valid (2)			
Notes			
K-Config Example			
Get the output HPD status of HDMI Out: "#DISPLAY? 1" , 0x0D			

13.3.1.12 HDCP-MOD

Functions		Permission	Transparency
Set:	HDCP-MOD	Administrator	Public
Get:	HDCP-MOD?	End User	Public
Description		Syntax	
Set:	Set HDCP mode	#HDCP-MOD ^{SE} _{inp_id,mode} ^{CR}	
Get:	Get HDCP mode	#HDCP-MOD? ^{SE} _{inp_id} ^{CR}	
Response			
Set / Get: ~nn@HDCP-MOD ^{SE} _{inp_id,mode} ^{CR LF}			
Parameters			
<i>inp_id</i> – input number: 1 (HDMI In 1), 2 (HDMI In 2), 3 (HDMI In 3), 4 (HDMI In 4) <i>mode</i> – HDCP mode: 0 (HDCP Off), 3 (Mirror output – MAC mode)			
Response Triggers			
A response is sent to the com port from which the set (before execution) / get command was received A response is sent to all com ports after command execution if HDCP-MOD was set by any other external control device (device button, device menu or other) or if the HDCP mode changed			
Notes			
Set HDCP working mode on the device input: HDCP not supported - HDCP Off HDCP support changes following detected sink - MIRROR OUTPUT			
K-Config Example			
Disable HDCP mode on HDMI In 2: "#HDCP-MOD 2,0",0x0D			

13.3.1.13 HDCP-STAT

Functions		Permission	Transparency
Set:	-	-	-
Get:	HDCP-STAT?	End User	Public
Description		Syntax	
Set:	-	-	
Get:	Get HDCP signal status	#HDCP-STAT? <input type="checkbox"/> stage, <input type="checkbox"/> stage_id <input type="checkbox"/>	
Response			
~nn@HDCP-STAT <input type="checkbox"/> stage, <input type="checkbox"/> stage_id, <input type="checkbox"/> status <input type="checkbox"/> CR <input type="checkbox"/> LF			
Parameters			
<i>stage</i> – 0 (input), 1 (output) <i>stage_id</i> – for input stage: 1 (HDMI In 1), 2 (HDMI In 2), 3 (HDMI In 3), 4 (HDMI In 4) for output stage: 1 (HDMI 1 Out), 2 (HDMI 2 Out) <i>status</i> – signal encryption status: 0 (On), 1 (Off)			
Response Triggers			
A response is sent to the com port from which the Get command was received			
Notes			
Output stage (1) – get the HDCP signal status of the sink device connected to HDMI Out			
Input stage (0) – get the HDCP signal status of the source device connected to the specified input			
K-Config Example			
Get the HDCP input signal status of the source device connected to HDMI In 1: "#HDCP-STAT? 0,1",0x0D			

13.3.1.14 NAME

Functions		Permission	Transparency
Set:	NAME	Administrator	Public
Get:	NAME?	End User	Public
Description		Syntax	
Set:	Set machine (DNS) name	#NAME[SP]machine_name[CR]	
Get:	Get machine (DNS) name	#NAME?[CR]	
Response			
Set:	~nn@NAME[SP]machine_name[CR LF]		
Get:	~nn@NAME?[SP]machine_name[CR LF]		
Parameters			
<i>machine_name</i> - String of up to 14 alpha-numeric characters (can include hyphens but not at the beginning or end)			
Response Triggers			
Notes			
The machine name is not the same as the model name. The machine name is used to identify a specific machine or a network in use (with DNS feature on).			
K-Config Example			
Set the DNS name of the device to "room-442": "#NAME room-442",0x0D			

13.3.1.15 NAME-RST

Functions		Permission	Transparency
Set:	NAME-RST	Administrator	Public
Get:	-	-	-
Description		Syntax	
Set:	Reset machine (DNS) name to factory default	#NAME-RST[CR]	
Get:	-	-	
Response			
~nn@NAME-RST[SP]OK[CR LF]			
Parameters			
Response Triggers			
Notes			
Factory default of machine (DNS) name is "KRAMER_"			
K-Config Example			
Reset the DNS name of the device to the factory default: "#NAME-RST",0x0D			

13.3.1.16 PRIO

Functions		Permission	Transparency
Set:	–	–	–
Get	PRIO?	Administrator	Public
Description		Syntax	
Set:	–	–	
Get:	Get input priority	#PRIO? <code>[SP]</code> input_id <code>[CR]</code>	
Response			
~nn@PRIO <code>[SP]</code> input_id,prio <code>[CR LF]</code>			
Parameters			
<i>input_id</i> - input number: 1 (HDMI In 1), 2 (HDMI In 2), 3 (HDMI In 3), 4 (HDMI In 4)			
<i>prio</i> - assigned priority (1.. max priority)			
Response triggers			
After execution, response is sent to the com port from which the command was received			
After execution, response is sent to all com ports if PRIO was set by any other external control device (button press, device menu and similar)			
Notes			
The PRIO max value may vary for different devices			
K-Config Example			
Get the input priority of HDMI In 2: "#PRIO? 2",0x0D			

13.3.1.17 SIGNAL

Functions		Permission	Transparency
Set:	-	-	-
Get	SIGNAL?	End User	Public
Description		Syntax	
Set:	-	-	
Get:	Get input signal lock status	# SIGNAL? <code>SP</code> <i>inp_id</i> <code>CR</code>	
Response			
~ <code>nn</code> @ SIGNAL <code>SP</code> <i>inp_id,status</i> <code>CR LF</code>			
Parameters			
<i>inp_id</i> – input number: 1 (HDMI In 1), 2 (HDMI In 2), 3 (HDMI In 3), 4 (HDMI In 4)			
<i>status</i> – lock status according to signal validation: 0 (Off), 1 (On)			
Response Triggers			
After execution, a response is sent to the com port from which the Get was received			
A response is sent after every change in input signal status from On to Off or from Off to On			
Notes			
K-Config Example			
Get the input signal lock status of HDMI In 2: "#SIGNAL? 2",0x0D			

13.3.2 Switching/Routing Commands

Command	Description
MTX-MODE?	Get switch mode
ROUTE	Set/get layer routing
VID	Set/get video switch state

13.3.2.1 MTX-MODE

Functions		Permission	Transparency
Set:	–	–	–
Get:	MTX-MODE?	End User	Public
Description		Syntax	
Set:	–	–	
Get :	Get auto-switch mode	#MTX-MODE? <input type="text" value="SP"/> output_id <input type="text" value="CR"/>	
Response			
~nn@MTX-MODE <input type="text" value="SP"/> output_id,mode <input type="text" value="CR"/>			
Parameters			
output_id: 1 (Out1), 2 (Out2) mode - 0 (manual), 1 (auto priority), 2 (auto last connected)			
Response Triggers			
After execution, a response is sent to the com port from which the Get was received After execution, a response is sent to all com ports if MTX-MODE was set by any other external control device (button press, WEB, device menu and similar)			
K-Config Example			
Get auto switch mode of Out 2: "#MTX-MODE? 2,0",0x0D			

13.3.2.2 ROUTE

Functions		Permission	Transparency
Set:	ROUTE	End User	Public
Get:	ROUTE?	End User	Public
Description		Syntax	
Set:	Set layer routing	#ROUTE[SP]layer,dest,src[CR]	
Get:	Get layer routing	#ROUTE?[SP]layer,dest[CR]	
Response			
~nn@ROUTE[SP]layer,dest,src[CR LF]			
Parameters			
layer – 1 (video)			
dest – for video layer: 1 (HDMI Out 1), 2 (HDMI Out 2)			
src – for video layer: 1 (HDMI In 1), 2 (HDMI In 2), 3 (HDMI In 3), 4 (HDMI In 4)			
Response Triggers			
Notes			
The get command identifies input switching on Step-in clients			
The set command is for remote input switching on Step-in clients (essentially via by the Web)			
K-Config Example			
Set the remote input switching of HDMI In 3 to HDMI Out 1: "#ROUTE 1,1,3",0x0D			

13.3.2.3 VID

Functions		Permission	Transparency
Set:	VID	End User	Public
Get:	VID?	End User	Public
Description		Syntax	
Set:	Set video switch state	#VID <code>SP</code> <i>in>out</i> <code>CR</code>	
Get:	Get video switch state	#VID? <code>SP</code> <i>out</i> <code>CR</code>	
Response			
Set:	~ <code>nn</code> @VID <code>SP</code> <i>in>out</i> <code>CR LF</code>		
Get:	~ <code>nn</code> @VID <code>SP</code> <i>in>out</i> <code>CR LF</code>		
Parameters			
<i>in</i> – input number: 1 (HDMI In 1), 2 (HDMI In 2), 3 (HDMI In 3), 4 (HDMI In 4) > – connection character between in and out parameters <i>out</i> – output number: 1 (HDMI Out 1), 2 (HDMI Out 2), * (for all outputs)			
Response Triggers			
Notes			
K-Config Example			
Set the video switch state from HDMI In 4 to HDMI Out 2: "#VID 4>1", 0x0D			

13.3.3 Video Commands

Command	Description
DEF-RES	Set/get custom defined scaled video output resolution to "VIC" index
VID-PATTERN	Set/get video test pattern
VMUTE	Set/get video on output mute

13.3.3.1 DEF-RES

Functions	Permission	Transparency
Set	–	–
Get	DEF-RES?	End User Public
Description	Syntax	
Set:	–	–
Get:	Get custom defined video resolution	#DEF-RES?SETable_id,stage,stage_idCR
Response		
~nn@DEF-RESSE Table_id,Width,Height,Htotal,VTtotal,HSyncW,HSyncBackPorch,VSynW,VSynBackPorch,FrRate,InterlacedCR LF		
Parameters		
Table_id – 2 (HDMI) Stage – 0 (input), 1 (output) Stage_id – for input stage: 1 (HDMI In 1), 2 (HDMI In 2), 3 (HDMI In 3), 4 (HDMI In 4), for output stage: 1 (HDMI Out 1), 2 (HDMI Out 2)		
Response Triggers		
After execution, response is sent to the com port from which the Set/Get was received After execution, response is sent to all com ports if DEF-RES was set by any other external control device (button press, device menu and similar)		
Notes		
If a requested custom resolution is not defined, yet is in the device, it returns ERRSE003 (out of range) Only indexes 100-104 are valid for custom defined resolution In Get command when sending: index 0 - device replies with detailed info of native resolution index 255 - device replies with detailed info of current resolution		
K-Config Example		
Get the detailed custom defined resolution from HDMI Out 2: "#DEF-RES? 255,0,2",0x0D		

13.3.3.2 VID-PATTERN

Functions		Permission	Transparency
Set:	VID-PATTERN	End User	Public
Get:	VID-PATTERN?	End User	Public
Description		Syntax	
Set:	Set test pattern on output	#VID-PATTERN ^{SP} output_id,pattern_id ^{CR}	
Get :	Get test pattern on output	#VID-PATTERN? ^{SP} output_id ^{CR}	
Response			
~nn@VID-PATTERN ^{SP} output_id,pattern_id ^{CR}			
Parameters			
output_id - 1 (HDMI Out 1), 2 (HDMI Out 2) pattern_id - 1 (Pattern 1: vertical color bars), 2 (Pattern 2: checkerboard), 3 (Pattern 3: gradient), 4 (Pattern 4: white)			
Response Triggers			
After execution, response is sent to the com port from which the Set/Get was received After execution, response is sent to all com ports if VID-PATTERN was set by any other external control device (button press, WEB, device menu and similar)			
Notes			
K-Config Example			
Set HDMI Out 2 to pattern 2 (checkerboard): "#VID-PATTERN, 2, 2", 0x0D			

13.3.3.3 VMUTE

Functions		Permission	Transparency
Set:	VMUTE	End User	Public
Get:	VMUTE?	End User	Public
Description		Syntax	
Set:	Set enable/disable video on output	#VMUTE ^{SP} output_id,flag ^{CR}	
Get:	Get video on output status	#VMUTE? ^{SP} output_id ^{SP} ^{CR}	
Response			
Set / Get: ~nn@VMUTE ^{SP} output_id,flag ^{CR} LF			
Parameters			
output_id - 1 (HDMI Out) flag - 0 (disable video on output), 1 (enable video on output), 2 (blank video)			
Response Triggers			
K-Config Example			
Disable the video output on HDMI Out: "#VMUTE 2, 0", 0x0D			

13.3.4 Communication Commands

Command	Description
ETH-PORT	Set/get Ethernet port protocol
NET-DHCP	Set/get DHCP mode
NET-GATE	Set/get gateway IP
NET-IP	Set/get IP address
NET-MAC	Get MAC address
NET-MASK	Set/get subnet mask

13.3.4.1 ETH-PORT

Functions		Permission	Transparency
Set:	ETH-PORT	Administrator	Public
Get:	ETH-PORT?	End User	Public
Description		Syntax	
Set:	Set Ethernet port protocol	# ETH-PORT [SP] <i>portType</i> , <i>ETHPort</i> CR	
Get:	Get Ethernet port protocol	# ETH-PORT? [SP] <i>portType</i> CR	
Response			
~nn@ ETH-PORT [SP] <i>portType</i> , <i>ETHPort</i> CR LF			
Parameters			
<i>portType</i> – string of 3 letters indicating the port type: TCP, UDP			
<i>ETHPort</i> – TCP / UDP port number: 0-65565			
Response Triggers			
Notes			
If the port number you enter is already in use, an error is returned			
The port number must be within the following range: 0-(2 ¹⁶ -1)			
K-Config Example			
Set the Ethernet port protocol for TCP to port 12457: "#ETH-PORT TCP,12457",0x0D			

13.3.4.2 NET-DHCP

Functions		Permission	Transparency
Set:	NET-DHCP	Administrator	Public
Get:	NET-DHCP?	End User	Public
Description		Syntax	
Set:	Set DHCP mode	#NET-DHCP SP mode CR	
Get:	Get DHCP mode	#NET-DHCP? CR	
Response			
~nn@NET-DHCP SP mode CR LF			
Parameters			
mode – 0 (do not use DHCP. Use the IP address set by the factory or the NET-IP command), 1 (try to use DHCP. If unavailable, use the IP address set by the factory or the NET-IP command)			
Response Triggers			
Notes			
<p>Connecting Ethernet to devices with DHCP may take more time in some networks</p> <p>To connect with a randomly assigned IP by DHCP, specify the device DNS name (if available) using the NAME command. You can also get an assigned IP by direct connection to USB or RS-232 protocol port if available</p> <p>Consult your network administrator for correct settings</p>			
K-Config Example			
<p>Enable DHCP mode, if available:</p> <pre>"#NET-DHCP 1", 0x0D</pre>			

13.3.4.3 NET-GATE

Functions		Permission	Transparency
Set:	NET-GATE	Administrator	Public
Get:	NET-GATE?	End User	Public
Description		Syntax	
Set:	Set gateway IP	#NET-GATE ^[SP] ip_address ^[CR]	
Get:	Get gateway IP	#NET-GATE? ^[CR]	
Response			
~nn@NET-GATE ^[SP] ip_address ^[CR LF]			
Parameters			
ip_address – gateway IP address, in the following format: xxx.xxx.xxx.xxx			
Response Triggers			
Notes			
A network gateway connects the device via another network, possibly over the Internet. Be careful of security problems. Consult your network administrator for correct settings.			
K-Config Example			
Set the gateway IP address to 192.168.0.1: "#NET-GATE 192.168.000.001",0x0D			

13.3.4.4 NET-IP

Functions		Permission	Transparency
Set:	NET-IP	Administrator	Public
Get:	NET-IP?	End User	Public
Description		Syntax	
Set:	Set IP address	#NET-IP ^[SP] ip_address ^[CR]	
Get:	Get IP address	#NET-IP? ^[CR]	
Response			
~nn@NET-IP ^[SP] ip_address ^[CR LF]			
Parameters			
ip_address – IP address, in the following format: xxx.xxx.xxx.xxx			
Response Triggers			
Notes			
Consult your network administrator for correct settings			
K-Config Example			
Set the IP address to 192.168.1.39: "#NET-IP 192.168.001.039",0x0D			

13.3.4.5 NET-MAC

Functions		Permission	Transparency
Set:	-	-	-
Get:	NET-MAC?	End User	Public
Description		Syntax	
Set:	-	-	
Get:	Get MAC address	#NET-MAC? <input type="checkbox"/>	
Response			
~nn@NET-MAC <input type="checkbox"/> mac_address <input type="checkbox"/> CR LF			
Parameters			
mac_address – unique MAC address. Format: XX-XX-XX-XX-XX-XX where x is hex digit			
Response Triggers			
Notes			
K-Config Example			
"#NET-MAC?", 0x0D			

13.3.4.6 NET-MASK

Functions		Permission	Transparency
Set:	NET-MASK	Administrator	Public
Get:	NET-MASK?	End User	Public
Description		Syntax	
Set:	Set subnet mask	#NET-MASK <input type="checkbox"/> net_mask <input type="checkbox"/>	
Get:	Get subnet mask	#NET-MASK? <input type="checkbox"/>	
Response			
~nn@NET-MASK <input type="checkbox"/> net_mask <input type="checkbox"/> CR LF			
Parameters			
net_mask - format: xxx.xxx.xxx.xxx			
Response Triggers			
The subnet mask limits the Ethernet connection within the local network Consult your network administrator for correct settings			
Notes			
K-Config Example			
Set the subnet mask to 255.255.0.0: "#NET-MASK 255.255.000.000", 0x0D			

13.3.5 EDID Handling Commands

Additional EDID data functions can be performed via the **VS-42UHD** Web pages or a compatible EDID management application, such as Kramer EDID Designer (see www.kramerav.com/product/EDID%20Designer).

Command	Description
CPEDID	Copy EDID data from the output to the input EEPROM

13.3.5.1 CPEDID

Functions	Permission	Transparency
Set:	CPEDID	End User
Get:	-	-
Description	Syntax	
Set:	Copy EDID data from the output to the input EEPROM	
Get:	-	
Response		
~nn@CPEDIDSPsrc_type,src_id,dst_type,dest_bitmapCR LF		
Parameters		
<p><i>src_type</i> – EDID source type (usually output): 0 (input), 1 (output), 2 (default EDID) <i>src_id</i> – for input source: 1 (HDMI In 1), 2 (HDMI In 2), 3 (HDMI In 3), 4 (HDMI In 4), for output source: 1 (HDMI Out 1), 2 (HDMI Out 2), for default EDID source: 0 (default EDID) <i>dst_type</i> – EDID destination type (usually input): 0 (input), 1 (output), 2 (default EDID) <i>dest_bitmap</i> – bitmap representing destination IDs. Format: XXXX...X, where X is hex digit. The binary form of every hex digit represents corresponding destinations. Setting '1' indicates that EDID data is copied to this destination. Setting '0' indicates that EDID data is not copied to this destination.</p>		
Response Triggers		
Response is sent to the com port from which the Set was received (before execution)		
Notes		
<p>Destination bitmap size depends on device properties (for 64 inputs it is a 64-bit word) Example: bitmap 0x0013 means inputs 1, 2 and 5 are loaded with the new EDID. In this device, if the destination type is input (0), the bitmap size is 3 bits, for example bitmap 0x5 means inputs 1 and 3 are loaded with the new EDID.</p>		
K-Config Example		
<p>Copy the EDID data from the HDMI Out output (EDID source) to the HDMI In 1 input: "#CPEDID 1,1,0,0x1",0x0D Copy the EDID data from the default EDID source to HDMI In 1 and PC In inputs: "#CPEDID 2,0,0,0x5",0x0D</p>		

LIMITED WARRANTY

The warranty obligations of Kramer Electronics for this product are limited to the terms set forth below:

What is Covered

This limited warranty covers defects in materials and workmanship in this product.

What is Not Covered

This limited warranty does not cover any damage, deterioration or malfunction resulting from any alteration, modification, improper or unreasonable use or maintenance, misuse, abuse, accident, neglect, exposure to excess moisture, fire, improper packing and shipping (such claims must be presented to the carrier), lightning, power surges, or other acts of nature. This limited warranty does not cover any damage, deterioration or malfunction resulting from the installation or removal of this product from any installation, any unauthorized tampering with this product, any repairs attended by a person unauthorized by Kramer Electronics to make such repairs, or any other cause which does not relate directly to a defect in materials and/or workmanship of this product. This limited warranty does not cover cartons, equipment enclosures, cables or accessories used in conjunction with this product.

Without limiting any other exclusion herein, Kramer Electronics does not warrant that the product covered hereby, including, without limitation, the technology and/or integrated circuit(s) included in the product, will not become obsolete or that such items are or will remain compatible with any other product or technology with which the product may be used.

How Long Does this Coverage Last

Seven years as of this printing; please check our Web site for the most current and accurate warranty information.

Who is Covered

Only the original purchaser of this product is covered under this limited warranty. This limited warranty is not transferable to subsequent purchasers or owners of this product.

What Kramer Electronics will do

Kramer Electronics will, at its sole option, provide one of the following three remedies to whatever extent it shall deem necessary to satisfy a proper claim under this limited warranty:

1. Elect to repair or facilitate the repair of any defective parts within a reasonable period of time, free of any charge for the necessary parts and labor to complete the repair and restore this product to its proper operating condition. Kramer Electronics will also pay the shipping costs necessary to return this product once the repair is complete.
2. Replace this product with a direct replacement or with a similar product deemed by Kramer Electronics to perform substantially the same function as the original product.
3. Issue a refund of the original purchase price less depreciation to be determined based on the age of the product at the time remedy is sought under this limited warranty.

What Kramer Electronics will not do Under This Limited Warranty

If this product is returned to Kramer Electronics or the authorized dealer from which it was purchased or any other party authorized to repair Kramer Electronics products, this product must be insured during shipment, with the insurance and shipping charges prepaid by you. If this product is returned uninsured, you assume all risks of loss or damage during shipment. Kramer Electronics will not be responsible for any costs related to the removal or re-installation of this product from or into any installation. Kramer Electronics will not be responsible for any costs related to any setting up this product, any adjustment of user controls or any programming required for a specific installation of this product.

How to Obtain a Remedy under this Limited Warranty

To obtain a remedy under this limited warranty, you must contact either the authorized Kramer Electronics reseller from whom you purchased this product or the Kramer Electronics office nearest you. For a list of authorized Kramer Electronics resellers and/or Kramer Electronics authorized service providers, please visit our web site at www.kramerelectronics.com or contact the Kramer Electronics office nearest you.

In order to pursue any remedy under this limited warranty, you must possess an original, dated receipt as proof of purchase from an authorized Kramer Electronics reseller. If this product is returned under this limited warranty, a return authorization number, obtained from Kramer Electronics, will be required. You may also be directed to an authorized reseller or a person authorized by Kramer Electronics to repair the product.

If it is decided that this product should be returned directly to Kramer Electronics, this product should be properly packed, preferably in the original carton, for shipping. Cartons not bearing a return authorization number will be refused.

Limitation on Liability

THE MAXIMUM LIABILITY OF KRAMER ELECTRONICS UNDER THIS LIMITED WARRANTY SHALL NOT EXCEED THE ACTUAL PURCHASE PRICE PAID FOR THE PRODUCT. TO THE MAXIMUM EXTENT PERMITTED BY LAW, KRAMER ELECTRONICS IS NOT RESPONSIBLE FOR DIRECT, SPECIAL, INCIDENTAL OR CONSEQUENTIAL DAMAGES RESULTING FROM ANY BREACH OF WARRANTY OR CONDITION, OR UNDER ANY OTHER LEGAL THEORY. Some countries, districts or states do not allow the exclusion or limitation of relief, special, incidental, consequential or indirect damages, or the limitation of liability to specified amounts, so the above limitations or exclusions may not apply to you.

Exclusive Remedy

TO THE MAXIMUM EXTENT PERMITTED BY LAW, THIS LIMITED WARRANTY AND THE REMEDIES SET FORTH ABOVE ARE EXCLUSIVE AND IN LIEU OF ALL OTHER WARRANTIES, REMEDIES AND CONDITIONS, WHETHER ORAL OR WRITTEN, EXPRESS OR IMPLIED. TO THE MAXIMUM EXTENT PERMITTED BY LAW, KRAMER ELECTRONICS SPECIFICALLY DISCLAIMS ANY AND ALL IMPLIED WARRANTIES, INCLUDING, WITHOUT LIMITATION, WARRANTIES OF MERCHANTABILITY AND FITNESS FOR A PARTICULAR PURPOSE. IF KRAMER ELECTRONICS CANNOT LAWFULLY DISCLAIM OR EXCLUDE IMPLIED WARRANTIES UNDER APPLICABLE LAW, THEN ALL IMPLIED WARRANTIES COVERING THIS PRODUCT, INCLUDING WARRANTIES OF MERCHANTABILITY AND FITNESS FOR A PARTICULAR PURPOSE, SHALL APPLY TO THIS PRODUCT AS PROVIDED UNDER APPLICABLE LAW.

IF ANY PRODUCT TO WHICH THIS LIMITED WARRANTY APPLIES IS A "CONSUMER PRODUCT" UNDER THE MAGNUSON-MOSS WARRANTY ACT (15 U.S.C.A. §2301, ET SEQ.) OR OTHER APPLICABLE LAW, THE FOREGOING DISCLAIMER OF IMPLIED WARRANTIES SHALL NOT APPLY TO YOU, AND ALL IMPLIED WARRANTIES ON THIS PRODUCT, INCLUDING WARRANTIES OF MERCHANTABILITY AND FITNESS FOR THE PARTICULAR PURPOSE, SHALL APPLY AS PROVIDED UNDER APPLICABLE LAW.

Other Conditions

This limited warranty gives you specific legal rights, and you may have other rights which vary from country to country or state to state.

This limited warranty is void if (i) the label bearing the serial number of this product has been removed or defaced, (ii) the product is not distributed by Kramer Electronics or (iii) this product is not purchased from an authorized Kramer Electronics reseller. If you are unsure whether a reseller is an authorized Kramer Electronics reseller, please visit our Web site at www.kramerelectronics.com or contact a Kramer Electronics office from the list at the end of this document.

Your rights under this limited warranty are not diminished if you do not complete and return the product registration form or complete and submit the online product registration form. Kramer Electronics thanks you for purchasing a Kramer Electronics product. We hope it will give you years of satisfaction.

KRAMER



P/N: 2900-300609



Rev: 4



SAFETY WARNING

Disconnect the unit from the power supply before opening and servicing

For the latest information on our products and a list of Kramer distributors, visit our Web site to find updates to this user manual.

We welcome your questions, comments, and feedback.

www.kramerav.com
info@kramerav.com