

SMART Board® M700 and M700V series interactive whiteboards

USER GUIDE

SBM777-43 | SBM787 | SBM794-169 | SBM797

SBM777V-43 | SBM787V | SBM794V-169 | SBM797V

Was this document helpful?
smarttech.com/docfeedback/171660

SMART®



Learn more

This guide and other resources for SMART Board M700 and M700V series interactive whiteboards are available in the Support section of the SMART website (smarttech.com/support). Scan the QR code to view these resources on your mobile device.

Trademark notice

SMART Board, SMART Notebook, SMART Ink, Object Awareness, smarttech, the SMART logo and all SMART taglines are trademarks or registered trademarks of SMART Technologies ULC in the U.S. and/or other countries. Windows is either a registered trademark or trademark of Microsoft Corporation in the U.S. and/or other countries. Mac is a trademark of Apple Inc., registered in the U.S. and other countries. Linux is a registered trademark of Linus Torvalds. Ubuntu is a registered trademark of Canonical Ltd. All third-party product and company names may be trademarks of their respective owners.

Copyright notice

© 2021 SMART Technologies ULC. All rights reserved. No part of this publication may be reproduced, transmitted, transcribed, stored in a retrieval system or translated into any language in any form by any means without the prior written consent of SMART Technologies ULC. Information in this manual is subject to change without notice and does not represent a commitment on the part of SMART.

This product and/or use thereof is covered by one or more of the following U.S. patents: www.smarttech.com/patents. Contents are subject to change without notice.

June 1, 2021

Important information

Before you install and use your SMART Board M700 or M700V series interactive whiteboard, read and understand the safety warnings and precautions in this user guide and the included warnings document. The included warnings document describes the safe and correct operation of your SMART Board interactive whiteboard and its accessories, helping you to prevent injuries and equipment damage.

NOTE

In this document, the term “interactive whiteboard” refers to your interactive whiteboard and its accessories and options.

Federal Communication Commission interference statement

FCC

Supplier's Declaration of Conformity

47 CFR § 2.1077 Compliance Information

Unique Identifier: **IB777-1, IB787-1, IB794-1, IB797-1**

Responsible Party – U.S. Contact Information

SMART Technologies Inc.

2401 4th Ave, 3rd Floor

Seattle, WA 98121

compliance@smarttech.com

This device complies with Part 15 of the FCC Rules. Operation is subject to the following two conditions:

1. This device may not cause harmful interference, and
2. this device must accept any interference received, including interference that may cause undesired operation.

CAUTION

Any changes or modifications not expressly approved by the party responsible for compliance could void the user's authority to operate this equipment.

NOTE

This equipment has been tested and found to comply with the limits for a Class A digital device, pursuant to part 15 of the FCC Rules. These limits are designed to provide reasonable protection against harmful interference when the equipment is operated in a commercial environment. This equipment generates, uses, and can radiate radio frequency energy and, if not installed and used in accordance with the instruction manual, may cause harmful interference to radio communications. Operation of this equipment in a residential area is likely to cause harmful interference in which case the user will be required to correct the interference at his own expense.

Innovation, Science and Economic Development Canada statement

This device complies with ICES-003 of the Innovation, Science and Economic Development Canada Rules. Operation is subject to the following two conditions:

1. This device may not cause harmful interference, and
2. this device must accept any interference received, including interference that may cause undesired operation.

Innovation, Science et Développement économique Déclaration du Canada

Cet appareil est conforme à la norme ISED NBM-003 pour les appareils radio agréés. Son fonctionnement est soumis aux deux conditions suivantes:

1. le dispositif ne doit pas produire de brouillage préjudiciable, et
2. ce dispositif doit accepter tout brouillage reçu, y compris un brouillage susceptible de provoquer un fonctionnement indésirable.

Important information

EU Declaration of Conformity

This device complies with the applicable CE Mark Directives. For more details, contact smarttech.com/compliance

 **WARNING**

Operation of this equipment in a residential environment could cause radio interference.

Contents

- Important information** **3**
- Chapter 1: Welcome** **6**
 - About the interactive whiteboard 6
 - Features 7
 - Computer requirements 8
 - How does the interactive whiteboard work? 9
 - Installation tips 10
 - Replacement parts 10
- Chapter 2: Connecting a computer** **11**
 - Matching your computer’s resolution to your projector’s resolution 11
 - Installing SMART Product Drivers and Ink 12
 - Configuring SMART Product Drivers and Ink 12
- Chapter 3: Orienting the interactive whiteboard** **13**
- Chapter 4: Using the interactive whiteboard** **14**
 - Using the pen tray 15
 - Using SMART Ink 18
 - Using gestures 18
 - Updating SMART software 23
- Chapter 5: Maintaining the interactive whiteboard** **24**
 - Tips for trouble-free performance 24
 - Cleaning your interactive whiteboard 24
 - Transporting your interactive whiteboard 25
- Chapter 6: Troubleshooting** **26**
 - Tips for resolving issues with general behavior 27
 - Resolving common issues 28
 - Using the connection wizard 32
 - Using SMART Diagnostics 32
 - Contacting SMART Support 32
- Appendix A: Hardware environmental compliance** **34**
 - Waste Electrical and Electronic Equipment (WEEE) 34
 - More information 34

Chapter 1

Welcome

About the interactive whiteboard	6
Features	7
Identifying your model	7
Advanced IR with Object Awareness	7
Touch and gestures	7
Multitouch capabilities	8
Pen tray and pen ledge	8
Durable surface	8
Computer requirements	8
How does the interactive whiteboard work?	9
Installation tips	10
Extending your USB cable	10
Avoiding electromagnetic interference (EMI)	10
Replacement parts	10

About the interactive whiteboard

Your SMART product is a wall-mounted, front projection interactive whiteboard. It enables you to do everything that you can do at your computer—open and close applications, scroll through files, hold meetings with others, create new documents or edit existing ones, visit websites, play video clips and more—by touching the interactive screen with your finger or the included pens. When you connect the interactive whiteboard to a computer and a projector, your computer image appears on the interactive screen. You can write over any application in digital ink, and then save these notes to a file in SMART Notebook® collaborative learning software for future reference and distribution.

The SMART Board M700 and M700V series interactive whiteboards are full-speed USB 2.0 bus powered devices with no external power supply. Because USB is the primary connectivity mode, your interactive whiteboard receives power from the computer through the included 16' 5" (5 m) USB cable. There's no power switch on your interactive whiteboard. It's always running when your computer is turned on.

Features

The SMART Board M700 and M700V series interactive whiteboards are durable and reliable. They feature a rugged, hardened interactive screen, two damage-resistant pens, and advanced infrared (IR) with Object Awareness™ technology.

Identifying your model

A variety of models of SMART Board M700 and M700V series interactive whiteboards are available:

Model	Pen tray or pen ledge	Size (diagonal)	Aspect ratio
SMART Board M700 series interactive whiteboards			
SBM777-43	Pen tray	77"	4:3
SBM787	Pen tray	87"	16:10
SBM794-169	Pen tray	94"	16:9
SBM797	Pen tray	97"	16:10
SMART Board M700V series interactive whiteboards			
SBM777V-43	Pen ledge	77"	4:3
SBM787V	Pen ledge	87"	16:10
SBM794V-169	Pen ledge	94"	16:9
SBM797V	Pen ledge	97"	16:10

Advanced IR with Object Awareness

Advanced IR technology uses light emitters and receivers mounted in the interactive whiteboard's frame to track the position of your finger or the pen as it moves across the interactive screen. The emitters create an invisible light surface, and the receivers detect the light, or more importantly, the lack of it. With Object Awareness, the whiteboard responds automatically to the tool or object you're using, whether it's a pen, finger, eraser, or palm.

Touch and gestures

Touch and gestures enable you to write and erase digital ink and to perform mouse functions by touching the interactive whiteboard with your pen, palm, or a finger. Your interactive whiteboard also features gesture capability, providing a natural and flexible way to interact with content.

NOTE

SMART Product Drivers must be installed on your Windows, Mac, or Linux® computer to enable all features in SMART software. For supported versions, see *Computer requirements* below

Multitouch capabilities

Support for up to 20 simultaneous touches enables up to two users to interact with the interactive whiteboard by using the included pens or other objects, or by using their fingers to perform gestures. They can also use their palms to erase.

Pen tray and pen ledge

SMART Board M700 series interactive whiteboards include a pen tray. Use the color select buttons to change digital ink colors. The on-screen keyboard, the right-click and the orient features are also accessible with pen tray buttons.

SMART Board M700V series interactive whiteboards include a pen ledge. The durable pen ledge holds the two included pens.

Durable surface

The interactive screen is scratch-resistant, dent-resistant and optimized for projection.

Computer requirements

To successfully power a SMART Board M700 or M700V series interactive whiteboard and run SMART Product Drivers (see *Installing SMART Product Drivers and Ink* on page 12), your computer must meet certain minimum requirements. SMART Board M700 and M700V series interactive whiteboards are supported on computers with Windows®, macOS, or Linux operating systems.

See the release notes for a complete list of computer requirements:

- [SMART Notebook 20 software for Windows and Mac](#)
- SMART Notebook 11.1 software for Linux (smarttech.com/kb/171706)

SMART Board M700 and M700V series interactive whiteboards work with these versions of SMART software:

Windows and Mac	Linux
SMART Product Drivers 12.16 (or later) ¹	SMART Product Drivers 12.17 (or later) required for Ubuntu® 20.04 ²
SMART Notebook 20 (or later) including SMART Notebook basic version	SMART Notebook 11.1 for Linux

How does the interactive whiteboard work?

SMART Board M700 and M700V series interactive whiteboards function as input devices for your computer, enabling you to work in any application on your connected computer. You need two more components to use your interactive whiteboard: a computer and a digital projector. Here's how these components work together:

- Your computer runs an application and sends the image to the projector.
- The projector casts the image onto the interactive whiteboard.
- The interactive whiteboard detects contact with its screen and sends each contact point, along with Pen tool information, to the connected computer.

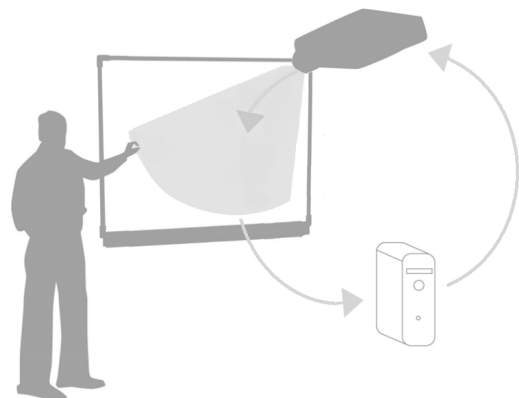

When you touch your interactive whiteboard's screen, the touch of your finger becomes a mouse click, and you can control your computer from your interactive whiteboard.

When you use a pen tool, the pointer changes to a pen, so you can write over your desktop or any open application with digital ink. Dragging your palm across the interactive surface erases digital ink.

NOTE

Your interactive whiteboard determines how you are interacting with its screen by measuring the size of the object detected close to its screen. The smallest detected object will be identified as a pen tool (tip). A larger object will be identified as a finger and even larger object will be identified as an eraser.

¹SMART Product Drivers 12.16 is available only with SMART Notebook 20 (including basic version) software downloads.

²SMART Product Drivers for Linux (Ubuntu 20.04) is included with SMART Notebook 11.1 for Linux software downloads.

When you install SMART Product Drivers, the SMART Ink® dynamic (floating) toolbar appears on your desktop. You can change pen settings such as the transparency, color, and width of the ink. You can then save your notes to a file in SMART Notebook software. You can also customize other tools, such as the width of the eraser tool you use to erase notes. For more information, see *Using SMART Ink* on page 18.

Installation tips

For instructions on installing SMART Board M700 and M700V series interactive whiteboards, see the *SMART Board M700 and M700V series interactive whiteboard installation instructions* (smarttech.com/kb/171771).

Extending your USB cable

The 16' 5" (5 m) USB cable included with your interactive whiteboard is within the limit defined by the USB standard for maximum length. However, if this cable isn't long enough to reach from your computer to your interactive whiteboard, you can use a bus-powered hub, such as the active USB extension cable (Part No. USB-XT-1100) to extend the USB connection.

Avoiding electromagnetic interference (EMI)

You can take some precautions to prevent EMI to your interactive whiteboard:

- Don't route USB cables parallel to power cables.
- Cross USB cables over power cables at a 90° angle to reduce the risk of interference on the USB cables.
- Don't route USB cables close to common sources of EMI, such as electric motors or fluorescent lighting ballasts.
- Don't bend USB cables sharply.
- Don't use USB plug adapters or passive USB wall plates.

Replacement parts

For a list of replacement parts for SMART Board M700 and M700V series interactive whiteboards, refer to the service parts diagram.

Contact your authorized SMART reseller (smarttech.com/wheretobuy) to order standard replacement parts for your interactive whiteboard.

Chapter 2

Connecting a computer

Matching your computer’s resolution to your projector’s resolution 11
Installing SMART Product Drivers and Ink 12
Configuring SMART Product Drivers and Ink 12

The USB interface of a SMART Board M700 or M700V series interactive whiteboard enables you to connect your interactive whiteboard to your computer. Because the included USB cable provides both a digital signal and power from your computer to your interactive whiteboard, you don’t need an additional power supply.

Matching your computer’s resolution to your projector’s resolution

Ensure that the resolution settings for your computer and projector match. If your computer’s resolution doesn’t match the projector’s native resolution, the image on your interactive whiteboard’s surface can appear to shimmer or be distorted.

Set the projector to its optimal image resolution by following the instructions included with your projector, and then set your computer’s resolution to match. If you need help changing your computer’s resolution, see the instructions included with your computer’s operating system.

To learn more, see the knowledge base article, [Getting the best image quality on your SMART Board interactive whiteboard](#).

Installing SMART Product Drivers and Ink

You can install SMART Product Drivers and Ink on any computer that meets certain minimum requirements (see *Computer requirements* on page 8). If you have a subscription to SMART Learning Suite or will be installing the basic version of SMART Notebook software, SMART Product Drivers and Ink are included with those downloads. You can download both from here: support.smarttech.com/downloads/notebook.

SMART Product Drivers is also included with SMART Notebook 11.1 for Linux downloads. You can download this file here: support.smarttech.com/docs/redirect/?product=notebook11&context=linux-11-1.

NOTES

- You must install SMART Product Drivers and Ink on your computer in order to write in digital ink and to use touch on the interactive whiteboard's surface.
 - The SMART Board M700V series interactive whiteboard does not include status lights. SMART Product Drivers must be installed to view the interactive whiteboard's status.
-

Configuring SMART Product Drivers and Ink

SMART Product Drivers and Ink software have a number of features you can use to customize default settings for your interactive whiteboard and troubleshoot common issues:

- [Adjust pen default settings, such as color and line thickness.](#)
- [Adjust touch, mouse, and gesture settings.](#)
- [Turn SMART Ink on or off.](#)
- [Use SMART Ink in Microsoft Office products.](#)

Chapter 3

Orienting the interactive whiteboard

After you install SMART Product Drivers on your computer, orient the SMART Board M700 or M700V series interactive whiteboard's touch system to the image cast by your projector. Orienting your interactive whiteboard ensures the best possible level of writing and touch accuracy. Orient your interactive whiteboard any time you've moved the projector or interactive whiteboard since you used it last or whenever the mouse pointer isn't properly aligned with the pen or your finger when you touch the interactive screen.

To orient your interactive whiteboard

1. Tap the SMART Board icon  in the notification area (Windows) or menu bar (Mac) and select **Orient**.

The *Orientation* screen appears.

NOTE

If your computer isn't currently connected to an interactive whiteboard, the SMART Board icon includes an X in the lower-right corner .

2. Pick up the pen from the pen tray.
3. Beginning at the first target on the screen, touch the center of the target firmly with the tip of the pen and hold the pen steady until the target moves to the next point.
4. Repeat step 3 until you arrive at the last point.
5. At the last point, touch the center of the target, pause and release the pen.

The *Orientation* screen closes.

Chapter 4

Using the interactive whiteboard

Using the pen tray	15
Pen tray buttons	15
Understanding the Highlighter button's status light	16
Customizing the pen tray buttons	17
Using SMART Ink	18
Using gestures	18
Single-finger gestures	19
Selecting and object and clearing the selection (clicking)	19
Displaying menu options (right-clicking)	19
Dragging an object, scroll bar, or window	19
Double-clicking	20
Displaying the next page	20
Displaying the previous page	20
Multi-finger gestures	20
Displaying menu options (right-clicking)	20
Making an area or object larger	21
Making an area or object smaller	21
Scrolling horizontally or vertically	21
Rotating an object	21
Best practices for gestures and tools	22
Updating SMART software	23

When you touch the SMART Board M700 or M700V series interactive whiteboard's surface, the interactive whiteboard registers the horizontal and vertical (or x and y) coordinates. Your computer's driver interprets those coordinates and moves the pointer to the corresponding point on the projected image.

WARNING

Do not stand (or allow children to stand) on a chair to touch the surface of the SMART Board product. Instead, safely fix the product at the appropriate height on a wall.

To open an application on your interactive whiteboard, tap twice consecutively on the application's icon. When you tap twice to open an application, it's the same as double-clicking your mouse to open an application on your computer. Similarly, each time you tap once on the interactive whiteboard's surface, it's the same as a single left click.

NOTE

If necessary, move the mouse, touch the interactive whiteboard's surface, or press any key on your keyboard to bring your computer out of Standby mode.

Using the pen tray

In addition to providing a convenient place to hold the included pens, the interactive pen tray on SMART Board M700 series interactive whiteboards has several controls and indicators.

NOTE

SMART Board M700V series interactive whiteboards feature a durable pen ledge that holds the two included pens, rather than an interactive pen tray.

Pen tray buttons

In the center of the pen tray, there are six buttons. The middle four change the color of digital ink that appears when you touch the screen. The buttons on either side of the pen color buttons default to the highlighter (left button) and fine-erase (right button) functions. These buttons light up to indicate the currently selected tool.

The buttons on the right side of the pen tray enable the right-click, on-screen keyboard, and orientation functions.

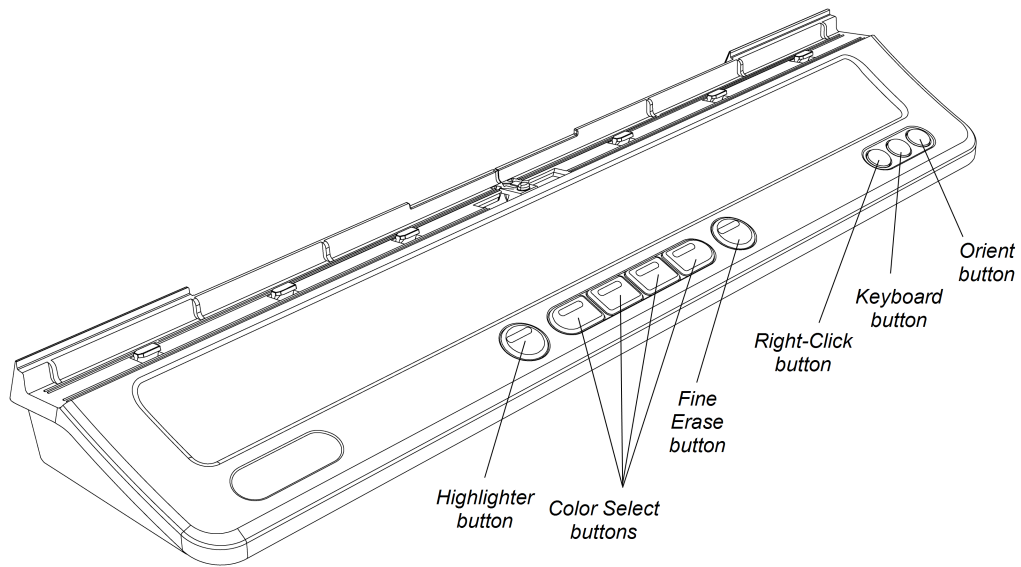

Understanding the Highlighter button's status light

The Highlighter button's light also indicates the interactive whiteboard's status. The Highlighter button's light is solid white when the system is working properly.

This table shows the Highlighter button's normal states:

Highlighter light state	Meaning
Flashing white	<p>The interactive whiteboard is receiving power and communicating successfully with the computer's USB HID driver, but SMART Product Drivers isn't installed.</p> <hr/> <p>NOTE</p> <p>In HID mode, interactive whiteboard tools (such as the pens) aren't available, but you can move the mouse pointer and perform mouse functions by touching the interactive surface. The Right-Click button on the pen tray might work, depending on the version of operating system you're using. Neither the Keyboard nor the Orient button works in HID mode.</p> <hr/>
Solid white	<p>The interactive whiteboard is receiving power and communicating successfully with SMART Product Drivers. When you press another pen tray button, the Select button's light turns off and the light on the button you pressed turns on.</p>
Solid amber	<p>The controller module is in service mode or the firmware is being updated.</p>
Off	<p>You have selected a non-standard digital ink color using SMART Notebook software or SMART Ink, the interactive whiteboard isn't receiving power, or the interactive whiteboard is in Standby mode.</p>

Customizing the pen tray buttons

You can customize the pen tray button settings. For example, you can change line transparency, color, and style; you can change the eraser's width; and you can change the action performed by the Keyboard and Right-Click buttons.

For more information about customizing settings, see [Changing pen, eraser, and button settings](#).

Using SMART Ink

If you pick up a pen while viewing a connected computer's input, the SMART Ink® dynamic (floating) toolbar for SMART Ink appears on the screen. You can use this toolbar to temporarily change the pen's color, thickness, or other properties, and you can also access SMART Ink's tools, such as screen capture, spotlight, screen shade, and so on.

When you start drawing on the screen while viewing a connected computer's input, the SMART Ink® dynamic (floating) toolbar for SMART Ink appears on the screen. You can use this toolbar to temporarily change the pen's color, thickness, or other properties, and you can also access SMART Ink's tools, such as screen capture, spotlight, screen shade, and so on.

If SMART Ink is installed on the connected computer, the dynamic (floating) toolbar for SMART Ink appears on the screen. You can use this toolbar to change the pen's color, thickness, or other properties temporarily, or to use some of SMART Ink's tools such as screen capture, spotlight, screen shade, and so on.

To learn more about SMART Ink and its toolbar, visit the [SMART Ink support page](#). Here are a few quick links to get you started:

- [Turning SMART Ink on or off](#)
- [Opening the dynamic \(floating\) toolbar](#)
- [Closing \(hiding\) the toolbar](#)
- [Using SMART Ink presentation tools](#)

NOTE

The SMART Ink toolbar doesn't appear within SMART Notebook software because SMART Notebook includes its own ink tools that you can use to write directly in your file.

Using gestures

SMART Board M700 and M700V series interactive whiteboards support multitouch gestures with a computer running Windows, macOS, or Linux operating systems. For computer requirements, see *Computer requirements* on page 8. (Some gestures might not work in all operating systems.)

Multitouch gestures enable you to use a variety of commands on your interactive whiteboard without using the keyboard or mouse. With a series of two-finger touches on your interactive whiteboard screen, you can navigate pages, change the look of an object, and more.



Single-finger gestures

You can perform some gestures using one finger, including selecting an object and double-clicking. Single-finger gestures include:

Selecting an object and clearing the selection (clicking)

Quickly tap the interactive screen to select an object or option. This performs a standard mouse click. Tap again to clear the selection.

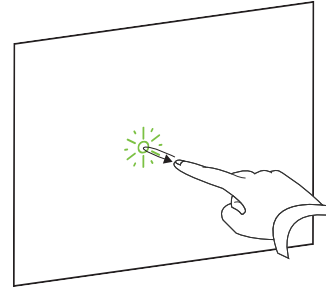

NOTE

This gesture starts programs if your operating system is set to start applications on a single click.

Displaying menu options (right-clicking)

Press and hold the screen with your finger.

In SMART Notebook software, Windows, and Microsoft® Office programs, the right-click menu appears.

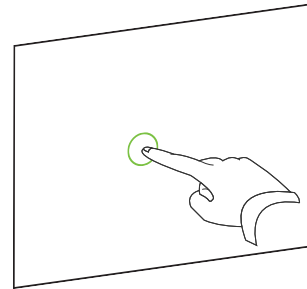

Dragging an object, scroll bar, or window

Press and hold an object or scroll bar on the screen. Keep your finger on the screen and slowly move the object or scroll bar. When you reach the position you want, release your finger.

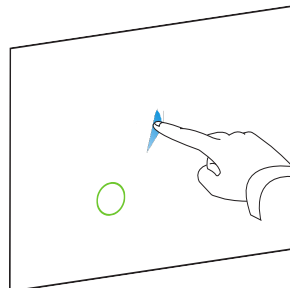

Double-clicking

Quickly tap the interactive screen twice in the same spot. This performs a standard double-click.

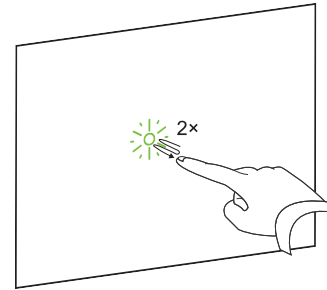

NOTE

This gesture starts programs if your operating system is set to start applications on a double-click.

Displaying the next page

Tap the screen, and then quickly tap again directly to the right of that point to display the next page.

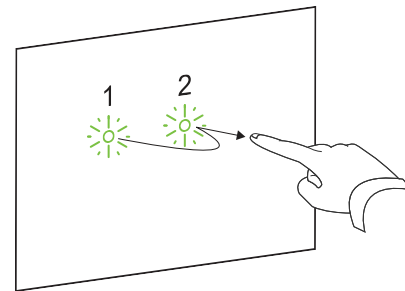

Displaying the previous page

Tap the screen, and then quickly tap again directly to the left of that point to display the previous page.

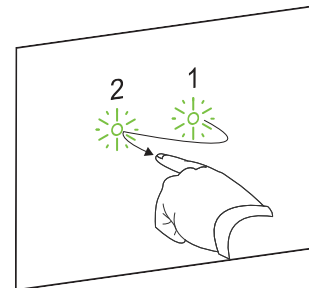

Multi-finger gestures

You can perform some gestures using two or more fingers, including scaling, scrolling, and manipulating objects. Multi-finger gestures include the following:

Displaying menu options (right-clicking)

Using two fingers on the same hand, press and hold the screen with one finger and then tap the screen directly to the right of that point with a second finger.

Release the first finger from the screen, and then select a menu item with any finger.

Making an area or object larger

Use one finger on each hand to press and hold in the center of the area or object, and then drag your fingers away from each other.

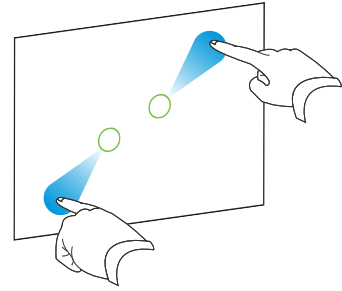

Making an area or object smaller

Use one finger on each hand to press and hold the screen at opposite ends of the area or object, and then drag your fingers toward each other.

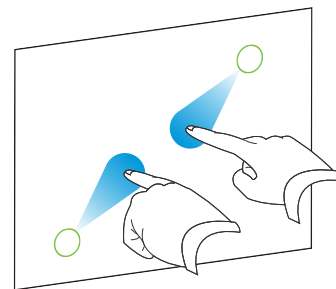

Scrolling horizontally or vertically

Use two fingers on the same hand to press and hold the screen.

Keeping your fingers on the screen, move up, down, left or right on the page. Release your fingers when you're satisfied with the view.

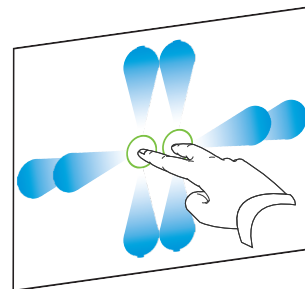

Rotating an object

Place one finger on either side of the object you want to rotate. Keep one finger stationary, and quickly move your second finger around the object. Release your fingers from the screen when you're satisfied with the angle.

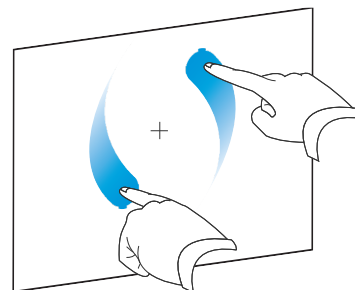

Best practices for gestures and tools

Follow these guidelines when you use tools and gestures with your interactive product.

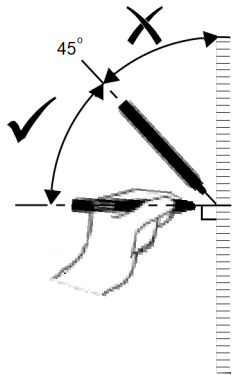

Hold pens at an angle greater than 45° from the interactive screen.

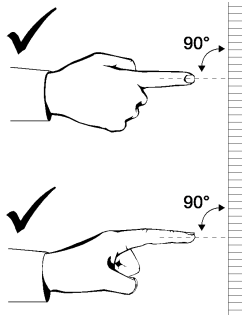

Hold your fingers perpendicular (90°) to the interactive screen at the contact point.

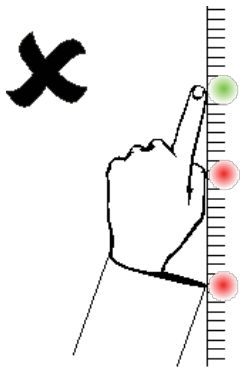

Keep your thumb, fingers, other hand, elbows, jewelry, loose clothing, and other objects away from the interactive screen. They can generate unintentional commands.

For “click” commands, quickly tap your finger on the interactive screen. Also, make sure you lift your finger far enough away from the interactive screen between taps so your finger is not detected on or close to the interactive screen.

Updating SMART software

To update the SMART software on a Windows or Mac computer, go to the SMART software download page or use SMART Product Update.

NOTE

Although SMART Product Update is not available for Linux computers, the computer's package management system can find and apply updates automatically if SMART software was installed from SMART's package repository directly (provided the package management system is configured correctly). If the software wasn't installed from SMART's package repository, you can check the SMART website for software updates and install them manually.

To check for software updates on a Windows or Mac computer

1. Tap the SMART Board icon  in the notification area (Windows) or menu bar (Mac) and select **Check for Updates and Activation**.

The *SMART Product Update* dialog box appears listing the SMART software products installed on your computer.

NOTES

- If your computer isn't currently connected to an interactive whiteboard, the SMART Board icon includes an X in the lower-right corner .
 - If you don't see the *Check for Updates and Activation* option, contact the network administrator.
2. Tap the **Update** button beside the software you want to update.

The SMART software updates automatically.

Chapter 5

Maintaining the interactive whiteboard

Tips for trouble-free performance	24
Cleaning your interactive whiteboard	24
Transporting your interactive whiteboard	25

Tips for trouble-free performance

SMART Board M700 and M700V series interactive whiteboards are durable, but take care to prevent damage to them and their parts:

- Replace the pen when the nib wears out.
- Don't touch the interactive screen with sharp or pointed objects.
- Don't use adhesive tape on the interactive screen.
- Don't set up and use your interactive whiteboard in an area with excessive levels of dust, humidity, or smoke.
- Don't use low-odor dry-erase markers because they can be very difficult to erase. Use standard (high-odor) dry-erase markers that show a warning to use them only in well-ventilated areas.
- Don't attach objects (decorations, magnets, stickers, and so on) to your interactive whiteboard's screen.
- Keep the optical touch system clean and clear of obstruction.
- Keep the interactive whiteboard's USB connection as short as possible (avoid extenders if you can).

Cleaning your interactive whiteboard

With proper care, a SMART Board M700 or M700V series interactive whiteboard will provide years of trouble-free service. Follow these tips to keep your interactive whiteboard clean.

- To clean dust, dirt, and fingerprints, wipe the writing surface with a damp cloth or sponge. Use mild soap, if required. You can also use isotropy alcohol (IPA) wipes to clean the whiteboard's screen.
- Don't spray cleaner directly onto the interactive screen. Instead, spray a light amount of cleaner on a cloth and then gently wipe the interactive screen.

- If ink is accidentally used on your interactive whiteboard, remove the ink as soon as possible. Ink becomes more difficult to remove the longer it stays on the whiteboard's screen.

 **CAUTION**

Do not use harsh chemicals or abrasive cleaners.

 **IMPORTANT**

- Before you clean your interactive whiteboard, disconnect its USB cable.
 - To view dirt or streaks more easily, set your projector to standby (lamp off) mode.
-

To learn more, see the knowledge base article, [How to clean SMART Board surfaces and accessories](#).

Transporting your interactive whiteboard

Save the original SMART Board M700 or M700V series interactive whiteboard packaging so that it's available if you need to transport the interactive whiteboard. When required, repack the interactive whiteboard with the original packaging. This packaging was designed with optimal shock and vibration protection. If the original packaging is no longer available, you can purchase the same packaging directly from your authorized SMART reseller (smarttech.com/wheretobuy).

Chapter 6

Troubleshooting

Tips for resolving issues with general behavior	27
Adjusting the projected image	27
Resetting your interactive whiteboard	27
Preventing USB cable issues	27
Resolving common issues	28
No image is projected on the interactive screen, or a “No Input” message appears	28
The projected image is blurry or not the same size as the interactive whiteboard’s projection surface	28
The interactive screen doesn’t respond to touch	29
Touch or ink alignment is inaccurate, the pointer moves erratically, or gaps appear when you draw or write	29
The SMART software icon doesn’t appear in the notification area	30
A small red × appears on the SMART software icon	30
The orientation procedure doesn’t proceed to the second point	31
Using the connection wizard	32
Using SMART Diagnostics	32
Contacting SMART Support	32

This chapter explains how to troubleshoot a variety of common issues with SMART Board M700 and M700V series interactive whiteboards. If you’re experiencing an issue that’s not listed or the solutions don’t work, check out the following resources:

Resource	Description
Communities discussions	Search the communities discussion forums for an answer, or post a description of the issue. SMART Support and other SMART Product users regularly monitor the forums, so it’s a great place to find answers to help resolve the issue.
Knowledge base (Communities articles)	The knowledge base contains articles to help with advanced troubleshooting. Search for the issue to see if an article offers a solution.

Tips for resolving issues with general behavior

Adjusting the projected image

If your projector isn't installed in a fixed location, you can correct many image problems by shifting your projector so the projected image fits squarely on the interactive surface. Ideally, each side of the image should extend almost to the edge of the interactive surface.

 **IMPORTANT**

Ensure the projected image does not extend beyond the interactive surface and onto the area that contains the optical touch-system sensors.

For more information about your projector, refer to the instructions included with your projector.

Resetting your interactive whiteboard

You can reset your interactive whiteboard by disconnecting and reconnecting the USB cable. This turns the power off and back on, restarting all the interactive whiteboard's components.

Preventing USB cable issues

To troubleshoot some common cable routing issues, ensure the USB cable is connected directly from your interactive whiteboard to your computer and is not routed through other devices, such as a USB HUB or extender. Also ensure that the USB cable is not longer than 16' 5" (5 m). The basic system consists of the SMART Board M700 or M700V series interactive whiteboard, USB cable, computer hardware, computer operating system, and SMART Product Drivers. You can try isolating and replacing each component to identify the cause of the connectivity issue.

Resolving common issues

No image is projected on the interactive screen, or a “No Input” message appears

Issue	Solutions
The projector isn't receiving a video signal.	<ul style="list-style-type: none">• Ensure the video cables that connect your computer to the projector are securely fastened, undamaged, and don't exceed the maximum length recommended by the projector's manufacturer.• Ensure that the correct video input is selected on the projector.• Ensure that the projector is on and that it's connected to a power source. Contact the projector's manufacturer for troubleshooting assistance.• If you're using a laptop computer, ensure it's configured to output video to an external display. Refer to your laptop's user guide for more information. <hr/> <p>TIP</p> <p>On computers with Windows operating systems, you can use the WIN+P keyboard shortcut to open a menu for choosing the display projection options.</p>
The computer is in Standby mode.	Move the computer's mouse, touch the interactive screen, or press a key on the keyboard to bring the computer out of Standby mode.
The computer is off.	Turn on the computer (or press the computer's reset button), and then log on as usual.

The projected image is blurry or not the same size as the interactive whiteboard's projection surface

Issue	Solutions
The projector's position, zoom, and focus settings aren't adjusted.	Adjust the projector's position, zoom, and focus settings. Refer to the projector's user guide for more information.

Issue	Solutions
Your computer's video resolution settings don't match the projector's native resolution.	<p>Consult the projector's user guide for its native resolution, and then select Start > Control Panel > Display to change the video resolution to match the projector's native resolution.</p> <hr/> <p>TIP</p> <p>To learn more about configuring the computer and whiteboard to get the best image quality, see the knowledge base article, Getting the best image quality on the SMART Board interactive whiteboard.</p>

The interactive screen doesn't respond to touch

Issue	Solutions
There is no USB connection between your computer and the interactive whiteboard.	<ul style="list-style-type: none">Restart the interactive whiteboard by disconnecting and reconnecting the USB cable.If a small red × appears on the SMART software icon, see <i>A small red × appears on the SMART software icon</i> on the next page.Try connecting a different computer to the interactive whiteboard. If you have more than one SMART Board M700 or M700V interactive whiteboard, use a computer that is normally connected to another SMART Board M700 or M700V interactive whiteboard.
Something is obstructing the optical touch system.	Make sure no decorations or notes are attached to the interactive screen and that the frames are clean. See <i>Cleaning your interactive whiteboard</i> on page 24.

Touch or ink alignment is inaccurate, the pointer moves erratically, or gaps appear when you draw or write

Issue	Solutions
The interactive whiteboard isn't oriented.	Orient the interactive whiteboard. For more information about orienting the interactive whiteboard, see <i>Chapter 2: Connecting a computer</i> on page 11.
The interactive whiteboard's optical touch system is dirty.	Clean the whiteboard. Use the cleaning instructions provided on <i>Cleaning your interactive whiteboard</i> on page 24.
Magnets, stickers, or adhesive tape placed on the interactive screen are obstructing its optical touch system.	Remove all objects from the whiteboard's interactive screen.



Issue	Solutions
Sunlight or other sources of strong infrared light are shining on the interactive whiteboard's touch system sensors.	Remove sources of strong infrared light, such as incandescent or arc lights, desk lamps, and infrared audio devices.
SMART Board Tools isn't running.	Run the connection wizard (see <i>Using the connection wizard</i> on page 32).
SMART Product Drivers isn't installed on your computer.	Install SMART Product Drivers on your computer. For details about installing SMART Product Drivers, see <i>Installing SMART Product Drivers and Ink</i> on page 12.
Some components of SMART Product Drivers are not installed on your computer.	Uninstall and then reinstall SMART Product Drivers on your computer.

The SMART software icon doesn't appear in the notification area

Issue	Solutions
SMART Board Tools isn't running.	Run the connection wizard (see <i>Using the connection wizard</i> on page 32).
SMART Product Drivers isn't installed on your computer.	Install SMART Product Drivers on your computer. For details about installing SMART Product Drivers, see <i>Installing SMART Product Drivers and Ink</i> on page 12.

A small red × appears on the SMART software icon

Issue	Solutions
SMART Product Drivers can't detect the interactive whiteboard.	Ensure that the USB cable is connected from your computer to the interactive whiteboard and that the USB cable isn't longer than 16' 5" (5 m).
Your computer's USB receptacle may not be providing sufficient power to the interactive whiteboard.	Use a different USB port on your computer. If you're using a laptop, ensure its externally powered and not running on battery.

Issue	Solutions
<p>SMART Board service isn't running.</p>	<p>Start SMART Board service:</p> <ol style="list-style-type: none"> Click the SMART Board icon  in the notification area (Windows) or menu bar (Mac) and select SMART Settings. <hr/> <p>NOTE</p> <p>If your computer isn't currently connected to an interactive whiteboard, the SMART Board icon includes an X in the lower-right corner .</p> <hr/> <ol style="list-style-type: none"> Select About Software and Product Support > Tools > Diagnostics. The <i>SMART Board Diagnostics</i> window opens. Select Service > Start. Close the <i>SMART Board Diagnostics</i> window, and then close SMART Settings. <hr/> <p>NOTE</p> <p>Running the connection wizard also starts SMART Board service (see <i>Using the connection wizard</i> on the next page).</p>
<p>Some components of SMART Product Drivers are not installed on your computer.</p>	<p>Uninstall and then reinstall SMART Product Drivers on your computer.</p>

The orientation procedure doesn't proceed to the second point

Issue	Solutions
<p>Your computer may be sending input to an application other than the interactive whiteboard's orientation screen.</p>	<p>Press ALT+TAB on your computer's keyboard to change the operating system's focus to the interactive whiteboard's orientation screen.</p>
<p>The SMART orientation window is appearing on a different display than the SMART whiteboard.</p>	<p>Press the SPACEBAR on your computer to change which display is associated with the SMART Board.</p>
<p>The interactive whiteboard's optical touch system is dirty or obstructed.</p>	<p>Clean the whiteboard using the cleaning instructions provided on page 24.</p>

Using the connection wizard

SMART Settings includes a connection wizard for troubleshooting problems with the connection between your computer and a SMART Board M700 or M700V series interactive whiteboard.

For example, you may need to configure a serial port manually in the following situations:

- The computer's operating system doesn't support plug and play.
- The *Found New Hardware* wizard doesn't appear.
- You connected the interactive whiteboard to a power source after you started your computer.
- The Ready light remains red after you start SMART Board Tools.

To troubleshoot connections

1. Click the SMART Board icon  in the notification area (Windows) or menu bar (Mac) and select **SMART Settings**.

NOTE

If your computer isn't currently connected to an interactive whiteboard, the SMART Board icon includes an X in the lower-right corner .

2. Click **Connection Wizard**.

The *SMART Connection Wizard* appears.

3. Follow the on-screen instructions.

Using SMART Diagnostics

With SMART Diagnostics, you can troubleshoot a variety of camera problems and configure many of the camera settings for SMART Board M700 and M700V series interactive whiteboards.

For more information about SMART Diagnostics, see [Using SMART Diagnostics](#).

Contacting SMART Support

SMART Support welcomes your call. However, if you experience difficulty with a SMART Board M700 or M700V series interactive whiteboard or any other SMART product, consider contacting your authorized SMART reseller (smarttech.com/where) first. Your reseller can often resolve the issue without delay.

Before you contact SMART Support, make sure:

- You know the interactive whiteboard's serial number.
- The computer specifications and operating system meet the minimum system requirements for SMART Product Drivers.
- The USB cable is connected properly to your computer and interactive whiteboard.
- SMART Product drivers are installed on your computer's operating system.
- The interactive screen and frames aren't optically obstructed.
- You oriented your interactive whiteboard's touch system to the projected display.

To find your interactive whiteboard's serial number

The serial number is on a label located on the left side of the interactive whiteboard (pictured). The serial number is also on the back of the interactive whiteboard.

Scan the QR code on the label to view the SMART Board M700 and M700V series interactive whiteboards support pages on the SMART website.

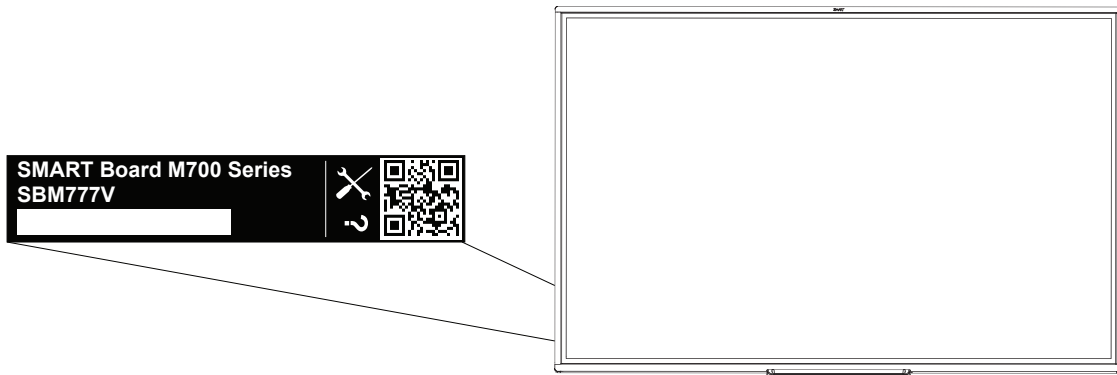

Appendix A

Hardware environmental compliance

SMART Technologies supports global efforts to ensure that electronic equipment is manufactured, sold, and disposed of in a safe and environmentally friendly manner.

Waste Electrical and Electronic Equipment (WEEE)

Electrical and electronic equipment and batteries contain substances that can be harmful to the environment and to human health. The crossed-out wheeled bin symbol indicates that products should be disposed of in the appropriate recycling stream and not as regular waste.



More information

See smarttech.com/compliance for more information.

SMART TECHNOLOGIES

smarttech.com/support

smarttech.com/contactsupport

smarttech.com/kb/171660