

User's Guide

PT-P900W
PT-P950NW

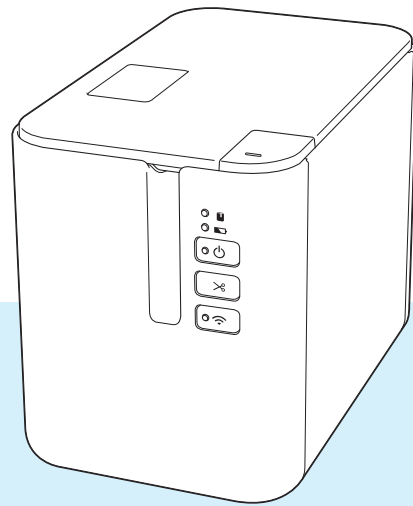

Introduction

Important Notice

- The contents of this document and the specifications of this product are subject to change without notice.
- Brother reserves the right to make changes without notice in the specifications and materials contained herein and shall not be responsible for any damages (including consequential) caused by reliance on the materials presented, including but not limited to typographical and other errors relating to the publications.
- Screen images in this document may differ depending on your computer's operating system, your product model and, the software version.
- Before using the P-touch Label Printer, make sure you read all documents included with the P-touch Label Printer for information about safety and proper operation.
- The P-touch Label Printer shown in the illustrations may be different from, P-touch Label Printer.
- Not all options and the consumables such as TZe, HGe tape, FLe label and HSe tube cassettes are available in all countries.
- The available options and supplies may vary depending on the country.

Available Manuals

Visit the Brother Solutions Center at support.brother.com and click Manuals on your model page to download the latest manuals.





Product Safety Guide ¹	This guide provides safety information; read it before you use the P-touch Label Printer.
Quick Setup Guide ¹	This guide provides basic information about using the P-touch Label Printer along with troubleshooting tips.
User's Guide ²	This guide provides additional information about the P-touch Label Printer settings and operations, network connection and settings, troubleshooting tips, and maintenance instructions.

¹ Printed manual in the box

² PDF manual on the Brother Solutions Center website

Symbols Used in This Guide

The following symbols are used throughout this guide:

 WARNING	Tells you what to do to avoid the risk of injury.
 CAUTION	Tells you about procedures you must follow to avoid minor personal injury or damage to the P-touch Label Printer.
 Important	Indicates information or directions that should be followed. Ignoring them may result in damage, or failed operations.
 Note	Indicates notes that provide information or directions that can help you better understand and use the product more efficiently.

IMPORTANT NOTE

- This product is approved for use in the country of purchase only. Do not use this product outside the country of purchase as it may violate the wireless telecommunication and power regulations of that country.
- Windows Vista® in this document represents all editions of Windows Vista®.
- Windows® 7 in this document represents all editions of Windows® 7.
- Windows® 8 in this document represents all editions of Windows® 8.
- Windows® 8.1 in this document represents all editions of Windows® 8.1.
- Windows® 10 in this document represents Windows® 10 Home, Windows® 10 Pro, Windows® 10 Enterprise, and Windows® 10 Education.
Windows® 10 in this document does not represent Windows® 10 Mobile, Windows® 10 Mobile Enterprise, or Windows® 10 IoT Core.
- Windows Server® 2008 in this document represents all editions of Windows Server® 2008 and Windows Server® 2008 R2.
- Windows Server® 2012 in this document represents all editions of Windows Server® 2012 and Windows Server® 2012 R2.
- Not all models are available in all countries.

©2016 Brother Industries, Ltd. All rights reserved.

Table of Contents

Section I Basic Operations

1	Setting Up the P-touch Label Printer	2
	General Description	2
	Front	2
	Back.....	3
	Connecting the Power Supply	4
	Inserting a Tape Cassette.....	5
	Turning Power On/Off.....	7
	Feeding Tape	7
2	Printing Using the Computer	8
	Installing the Printer Driver and Software	8
	Connecting the P-touch Label Printer to a Computer	9
	Connecting Using USB	9
	Connecting Using Wi-Fi®	9
	Connecting Using a Wired LAN (PT-P950NW Only).....	12
	Printing from a Computer.....	13
	Available Applications.....	13
	Printing from Your Computer.....	14
	Attaching Labels	16
3	Printing Using the Mobile Device	17
	Installing Applications for Use with Mobile Devices.....	17
	Available Applications.....	17
	Connecting the P-touch Label Printer to a Mobile Device	17
	Turning the Wireless Function On or Off	18
	Printing from a Mobile Device.....	18
	Printing from Your Mobile Device	18
	Using a Mobile Device to Print Templates Created on a Computer	20
	Attaching Labels	21
4	Using the Other Interfaces (Serial Interface/Bluetooth Interface)	22
	Installing the Printer Driver and Software	22
	Transferring the Template to P-touch Transfer Manager	22
	Transferring Templates from the Computer to the P-touch Label Printer.....	22
	Connecting Using the Serial Adapter (Optional:PA-SCA-001)	23
	Serial (RS-232C) Cable (Windows® Only)	24
	Serial Interface Settings	24
	Connecting Using the Bluetooth Interface (Optional: PA-BI-002) (PT-P950NW Only).....	25
	Product Specifications of PA-BI-002	25

5 Changing the P-touch Label Printer Settings 26

Printer Setting Tool for Windows®	26
Before Using the Printer Setting Tool	26
Using the Printer Setting Tool for Windows®	27
Communication Settings for Windows®	29
Settings Dialog Box	29
Menu Bar	31
General Tab	34
Wired LAN (PT-P950NW Only)/Wireless LAN Tabs	36
Wireless Direct Tab	41
Bluetooth Tab (PT-P950NW Only)	42
Applying Setting Changes to Multiple Printers	43
Device Settings for Windows®	44
Settings Dialog Box	44
Menu Bar	46
Basic Tab	48
Label Settings Tab	49
Panel Settings Tab (PT-P950NW Only)	50
Management Tabs (PT-P950NW Only)	51
Applying Setting Changes to Multiple Printers	54
P-touch Template Settings for Windows®	55
P-touch Template Settings Dialog Box	56
Printer Setting Tool for Mac	58
Before Using the Printer Setting Tool	58
Using the Printer Setting Tool for Mac	58
Settings Dialog Box	59
Basic Tab	60
Label Settings Tab	61
Bluetooth Settings Tab (PT-P950NW Only)	62
Wireless LAN Tab	63
Applying Setting Changes to Multiple Printers	64
Changing Settings When Printing from a Mobile Device	65

6 Printing Labels Using P-touch Template 66

P-touch Template Operations	66
Preparation	67
Specifying Settings in the P-touch Template Settings Tool	67
Specifying the RS232C Serial Port Settings	69
Connecting a Barcode Scanner	70
Standard Template Printing	71
Advanced Template Printing	73
Database Lookup Printing	76
Numbering (Serialized Number) Printing	79
Text Numbering (Serializing)	79
Barcode Numbering (Serializing)	80
Printing with Numbering (Serializing) Advanced Operation	81

7 Other Functions 82

Confirming the P-touch Label Printer Settings.....82
Mass Storage Mode.....82
 Description.....82
 Using the Mass Storage Mode82
Distributed Printing (Windows® Only).....84
Printing Labels in High Resolution Mode.....88
Printing Labels in High Speed Mode89

Section II Application

8 How to Use Cable Label Tool (Windows® Only) 91

Starting Cable Label Tool91
Creating a Cable Label.....93
 Faceplate.....93
 Cable Wrap.....94
 Cable Flag95
 Patch Panel96
 Punch-Down Block96
 Die-cut Flag97
 Heat Shrink Tube.....97
Linking a Database98
Numbering Function (Serialized Number) Printing99
Printing with Cable Label Tool.....99
Transferring Templates from Cable Label Tool to the P-touch Label Printer100

9 How to Use P-touch Editor 101

For Windows®101
 Starting P-touch Editor101
 Printing with P-touch Editor104
 Transferring Data to the P-touch Label Printer.....105
For Mac.....106
 Starting P-touch Editor106
 Operation modes.....107
 Transferring Data to the P-touch Label Printer.....108

10 How to Use P-touch Transfer Manager and P-touch Library (Windows® Only) 109

P-touch Transfer Manager.....109
Transferring the Template to P-touch Transfer Manager109
Transferring Templates or Other Data from the Computer to the P-touch Label Printer112
Backing up Templates or Other Data Saved in the P-touch Label Printer.....117
Deleting All the P-touch Label Printer Data118
Creating a BLF File or a PDZ File.....119
P-touch Library120
Starting P-touch Library120
Opening and Editing Templates122
Printing Templates.....123
Searching for Templates.....124

11 Transferring Templates with P-touch Transfer Express (Windows® Only) 126

Preparing P-touch Transfer Express126
Transferring the Template to P-touch Transfer Manager127
Saving the Template as a Transfer Package File (.pdz).....128
Distributing the Transfer Package File (.pdz) and P-touch Transfer Express to the User130
Transferring the Transfer Package File (.pdz) to Your P-touch Label Printer.....131

12 How to Update P-touch Software 134

Updating Cable Label Tool (Windows® Only) and P-touch Editor.....134
 For Windows®134
 For Mac136
Updating the Firmware138
 For Windows®138
 For Mac140

Section III Network

13 Introduction 144

Network Features144

14 Changing Your P-touch Label Printer Network Settings 145

Changing Your P-touch Label Printer's Network Settings
(IP Address, Subnet Mask and Gateway) Using Windows®145
 Using the BRAdmin Light Utility.....145
Other Management Utilities147
 Using Web Based Management (Web Browser).....147
 Using the BRAdmin Professional Utility (Windows® Only)147

15 Web Based Management 148

Overview.....148
Configuring the Printer Settings Using Web Based Management (Web Browser).....149

Section IV Appendix

16 Resetting the P-touch Label Printer 151

Resetting All Settings to the Factory Settings Using the P-touch Label Printer Buttons151
Resetting Data Using the Printer Setting Tool151

17	Maintenance	152
	Cleaning the Exterior of the Unit.....	152
	Cleaning the Print Head and Head Roller.....	152
	Print Head.....	153
	Head Roller.....	153
	Cleaning the Tape Cutter.....	154
18	Troubleshooting	155
	Overview.....	155
	Printing Problems.....	156
	Label Problems.....	159
	Printer Problems.....	160
	Network Setup Problems.....	161
	P-touch Label Printer Cannot Print over the Network	
	P-touch Label Printer Is Not Found on the Network Even after Successful Installation.....	162
	Security Software Problems.....	162
	Checking the Operation of Network Devices.....	163
	Version Information.....	163
	LED Indicators.....	164
	Indicator Warnings.....	168
19	Product Specifications	169
	P-touch Label Printer Specifications.....	169
	Operating Environment.....	171
20	Notes on Using P-touch Transfer Manager	172
	Notes on Creating Templates.....	172
	Notes on Transferring Templates.....	172
	Notes on Transferring Data Other Than Templates.....	173
21	Network Terms and Information	174
	Supported Protocols and Security Features.....	174
	Types of Network Connections and Protocols.....	175
	Types of Network Connections.....	175
	Configuring Your P-touch Label Printer for a Network.....	177
	IP Addresses, Subnet Masks and Gateways.....	177
	Wireless Network Terms and Concepts.....	179
	Security Terms.....	179
22	List of Barcodes for the P-touch Template Function	184
	General Procedure for the P-touch Template Function.....	184
	List of Barcodes for Specifying Settings.....	185

23	Using the Rechargeable Li-ion Battery/Battery Base (Optional:PA-BT-4000LI/PA-BB-002)	188
	Installing the Rechargeable Li-ion Battery	188
	Removing the Rechargeable Li-ion Battery	189
	Charging the Rechargeable Li-ion Battery.....	190
	Stopping Rechargeable Li-ion Battery Charging	190
	Notes on Using the Rechargeable Li-ion Battery.....	191
	Rechargeable Li-ion Battery Characteristics	191
	Product Specifications	192
24	Using the Touch Panel Display (Optional:PA-TDU-003) (PT-P950NW Only)	193
	General Description	193
	LCD	194
	Main Screen	194
	Touch Panel	196
	Replacing the Touch Panel	197
	Printing With the Touch Panel Display	200
	Touch Panel Display Settings.....	201
	Specifying Settings From the Touch Panel Display.....	201
	Creating a Label Layout (Windows® Only).....	205
	Creating a Template	205
	Linking a Database to a Template.....	208
	Transferring the Label Layout to the P-touch Label Printer	211
	Selecting the Touch Panel.....	213
	Selecting the Data Assigned to Keys on the One-Touch Panel	214
	Creating a One-Touch Panel.....	215
	Printing the Label.....	216
	Printing Using the Basic Control Panel.....	216
	Printing Using the One-Touch Panel	218
	Printing Using a Barcode Scanner	220
	Label Layouts on the P-touch Label Printer (Checking, Deleting and Log).....	221
	Replacing the Time/Date Battery.....	222
	Frequently Asked Questions.....	224
	Product Specifications	226
25	Using the Brother Barcode Scanner (Optional: PA-BR-001) (PT-P950NW Only)	227



Basic Operations

Setting Up the P-touch Label Printer	2
Printing Using the Computer	8
Printing Using the Mobile Device	17
Using the Other Interfaces (Serial Interface/Bluetooth Interface)	22
Changing the P-touch Label Printer Settings	26
Printing Labels Using P-touch Template	66
Other Functions	82

1





Setting Up the P-touch Label Printer

1

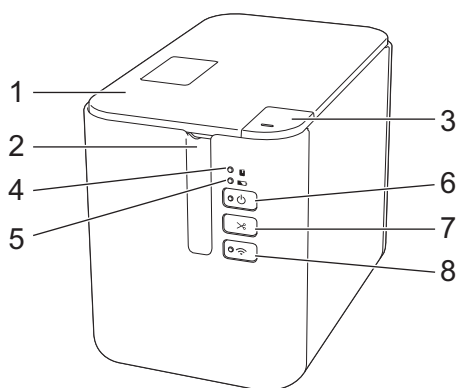
General Description

Front



- 1 Tape compartment cover
- 2 Tape exit slot
- 3 Cover open button
- 4  (Status) indicator
- 5  (Battery) indicator
- 6  (Power) button
- 7  (Feed&Cut) button
- 8  (Wi-Fi) button

Back

PT-P900W

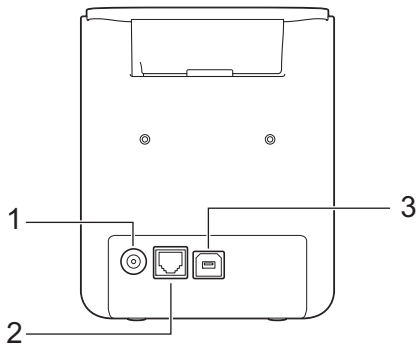

PT-P950NW

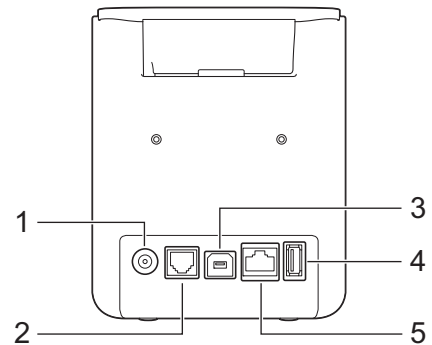

- 1 AC adapter socket
- 2 Serial port
- 3 USB port (for Computer)
- 4 USB host (for Barcode Scanner)
- 5 LAN port

! Important

Before using the P-touch Label Printer, make sure you remove the protective material according to the following procedure.

- 1 Press the cover open button to open the tape compartment cover.
- 2 Pull the tape to remove the tape together with the protective material.

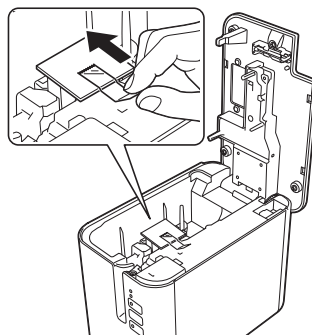

Connecting the Power Supply

Use the AD9100ESA (AC adapter) for this P-touch Label Printer. Connect the AC adapter directly to the P-touch Label Printer.

- 1 Insert the plug on the AC adapter cord into the AC adapter socket marked DC IN 24 V on the P-touch Label Printer.
- 2 Insert the plug on the power supply cord into the AC adapter.

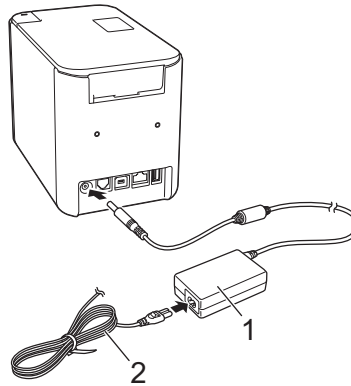

- 1 AC adapter
- 2 Power supply cord

- 3 Insert the power supply plug into a standard AC power outlet.

! Important

- Turn off the P-touch Label Printer before disconnecting the AC adapter.
- Do not pull or bend the AC adapter cord and power supply cord.
- After the power supply plug is inserted into the AC power outlet, it may take a few seconds until the  (Power) button is enabled.



Note

To safeguard and back up the P-touch Label Printer memory, when the power supply is unplugged it is recommended to have the rechargeable battery (optional: PA-BT-4000LI) installed in the P-touch Label Printer.

Inserting a Tape Cassette

The TZe, HGe tape, FLe label and HSe tube cassettes can be used in your P-touch Label Printer.

! Important

If the new tape cassette has a cardboard stopper, be sure to remove the stopper before inserting the cassette.

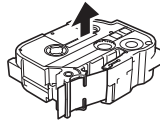

- 1 Check that the end of the tape is not bent and that it passes through the tape guides. If it does not, pass it through the tape guides as shown in the illustration.

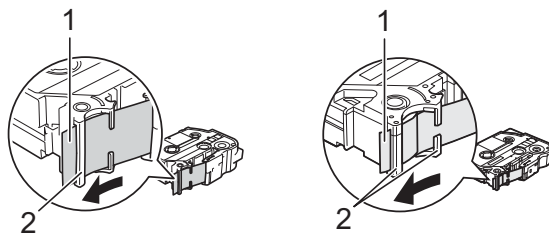

1 End of tape

2 Tape guides (The actual shape may be different depending on the tape width.)

- 2 Press the cover open button to open the tape compartment cover.
- 3 Carefully insert the tape cassette into the tape cassette compartment with the end of the tape facing the P-touch Label Printer's tape exit slot, then push down evenly until the tape cassette is installed correctly.

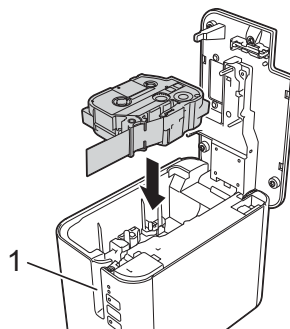

1 Tape exit slot

! Important

- When inserting the tape cassette, make sure that the tape and ink ribbon do not catch on the print head.
- Make sure that there is no slack in the tape. Otherwise the tape may catch on the protrusion (2) and become bent or wrinkled, causing the tape to jam.

To fix the slack in the tape, refer to the illustration in step ① and pull the tape outside of the tape guide.

- When removing the tape cassette, make sure that the tape does not catch on the protrusion (2).

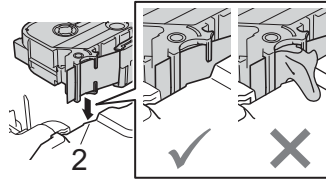



- 4** Close the tape compartment cover.

! Important

Store tape cassettes in a cool dark location, away from direct sunlight and high temperature, high humidity, or dusty locations. After opening the sealed package, use the tape cassette as quickly as possible.

Turning Power On/Off

On: Press the  (Power) button to turn on the P-touch Label Printer. The  (Power) indicator lights in green.

Off: Press and hold the  (Power) button again to turn off the P-touch Label Printer. The  (Power) indicator may light in orange until the power is off.

Important

When turning the P-touch Label Printer off, do NOT remove the battery or disconnect the AC adapter until the orange  (Power) indicator turns off.

Feeding Tape

Important

- Be sure to feed tape to remove any slack in the tape and ink ribbon after inserting the tape cassette.
 - **Do not pull the label when the P-touch Label Printer is ejecting it from the tape exit slot.** Doing so will cause the ink ribbon to be discharged with the tape. The tape may no longer be functional after the ink ribbon discharges.
 - Do not block the tape exit slot during printing or when feeding tape. Doing so will cause the tape to jam.
-

Feed and Cut

The Feed and Cut function feeds approximately 0.88" (22.3 mm) of blank tape, and then cuts the tape.

Press the  (Feed&Cut) button.

Installing the Printer Driver and Software

To print from your Windows® computer or Mac, install the printer driver, Cable Label Tool, P-touch Editor and other applications.

- 1 Visit our website (www.brother.com/inst) and download the installer for the latest software and manuals.
- 2 Double-click the downloaded file and follow the on-screen instructions to proceed with the installation.



Note

- After the installation starts, you can select which items to install.
 - To connect the P-touch Label Printer to a computer using a wireless connection, we recommend the following:
 - Configure the wireless network settings while installing the software. You can change the settings later using the Printer Setting Tool. For more information, see *Changing the P-touch Label Printer Settings* on page 26.
 - Install the software on a computer wirelessly connected to your network and configure the P-touch Label Printer using a USB cable.
 - Get the SSID (network name) and password (network key) of the wireless network in advance.
-
- 3 Close the dialog box when the installation is complete.

Connecting the P-touch Label Printer to a Computer

Refer to the directions for the type or connection method:

- USB cable connection
See *Connecting Using USB* on page 9.
- Wireless LAN connection
See *Connecting Using Wi-Fi®* on page 9.
- Wired LAN connection (PT-P950NW only)
See *Connecting Using a Wired LAN (PT-P950NW Only)* on page 12.

Connecting Using USB

- 1 Before connecting the USB cable, make sure that the P-touch Label Printer is turned off.
- 2 Connect the P-touch Label Printer end of the USB cable to the USB port on the back of the P-touch Label Printer.
- 3 Connect the other end of the USB cable to the USB port on the computer.
- 4 Turn on the P-touch Label Printer.

Connecting Using Wi-Fi®

The following Wi-Fi connection methods are available:

- Infrastructure Mode
- Ad-Hoc Mode (To set the Ad-Hoc mode, use the Printer Setting Tool (see *Changing the P-touch Label Printer Settings* on page 26).)

Infrastructure Mode









Infrastructure mode allows you to connect the P-touch Label Printer to a computer via a wireless access point/router.

■ Before You Begin

First you must configure the Wi-Fi settings of your printer to communicate with your wireless access point/router. After the printer has been configured, computers on your network will have access to the printer.

❗ Important

- If you are going to connect the printer to your network, we recommend that you contact your system administrator prior to installation. You must confirm your Wi-Fi settings before you proceed with this installation.



- To configure the Wi-Fi settings again, or if the status of the Wi-Fi connection for your printer is not clear, reset the Wi-Fi settings of the printer.
 - 1 Confirm that the printer is turned off.
 - 2 Press and hold the  (Power) and  (Feed&Cut) buttons for more than three seconds.
The  (Status) indicator flashes in green and the  (Power) indicator lit in orange.
 - 3 Continue holding down the  (Power) button, and press the  (Feed&Cut) button two times (for APIPA On) or four times (for APIPA Off).
 - 4 Release the  (Power) button.
The  (Status) indicator flashing three times in green and the  (Power) indicator flashing three times in orange.



Note

- We recommend preparing the SSID (network name) and password (network key) of the wireless network in advance.
- To achieve the best results with everyday document printing, use the printer as close to the wireless access point/router as possible with minimal obstructions. Large objects and walls between the two devices as well as interference from other electronic devices can affect the data transfer speed of your documents.

■ Connecting the P-touch Label Printer to your wireless access point/router

- 1 First, write down the SSID (network name) and password (network key) of your wireless access point/router.
- 2 Connect the printer and computer with a USB cable.
- 3 Press and hold the  (Wi-Fi) button on your P-touch Label Printer for one second to turn the Wi-Fi function on. The  (Wi-Fi) indicator starts flashing in green once every three seconds.
- 4 Configure the Infrastructure Mode settings of the P-touch Label Printer using the computer.
 - For Windows®

Start the Printer Setting Tool on your computer, and click [**Communication Settings**]. Select [**Infrastructure or Ad-hoc**] or [**Infrastructure and Wireless Direct**] for [**Selected Interface**] in [**Communication Settings**] in the [**General**] tab, and select [**Infrastructure**] for [**Communication Mode**] in [**Wireless Settings**] in the [**Wireless LAN**] tab.

For details, see *Changing the P-touch Label Printer Settings* on page 26.
 - For Mac

Start the Wireless Device Setup Wizard included in the Printer Driver Package, and then follow the on-screen instructions. The Wireless Device Setup Wizard can be found in the [**Utilities**] folder.
- 5 Enter the SSID that you wrote down, or click [Search] and select the SSID from the displayed list.

- 6 Enter the password in the [Passphrase] field.

**Note**

The required information depends on the authentication method and encryption mode; enter only the information relevant to your network environment.

- 7 To send the settings to the printer, click [Apply].
When the connection between the P-touch Label Printer and your wireless access point/router is established, the  (Wi-Fi) indicator lights in green. Computers on the same network as the P-touch Label Printer will have access to the P-touch Label Printer.

**Note**



To change any other network settings, use the Printer Setting Tool (see *Changing the P-touch Label Printer Settings* on page 26).

■ WPS (Wi-Fi Protected Setup™)

If your wireless access point/router supports WPS, you can configure settings and connections wirelessly.

- 1 First, confirm that your wireless access point/router has the WPS symbol.



- 2 Place your printer within the range of your wireless access point/router. The range may differ depending on your environment. See the instructions provided with your wireless access point/router.
- 3 Press the WPS button on your wireless access point/router, and press and hold the  (Wi-Fi) button on the printer for about five seconds.
The  (Wi-Fi) indicator on the printer flashes in green.
When the connection is established, the  (Wi-Fi) indicator lights in green. Computers that are on the same network as the printer will have access to the printer.

**Note**

Your printer will try to connect using WPS for two minutes. If the  (Wi-Fi) button is pressed and held for another five seconds during that time, the printer will continue trying to connect for an additional two minutes.



Ad-Hoc Mode

For Windows, after installing the printer driver and other applications to your computer, set the Ad-Hoc mode using the Printer Setting Tool installed on the computer.

For Mac, set the Ad-Hoc mode using the Wireless Device Setup Wizard.

Turning the Wireless Function On or Off

To turn the wireless function on or off, press the  (Wi-Fi) button.

- 1 Press the  (Wi-Fi) button. The wireless function is now on. The  (Wi-Fi) indicator lights/flashes in green.

- 2 Press the  (Wi-Fi) button again to turn the wireless function off. The  (Wi-Fi) indicator turns off.



Note

When the wireless function is on, the Li-ion battery power will decrease quickly. To change the power source, connect the AC adapter.

Connecting Using a Wired LAN (PT-P950NW Only)



Note

To use a static IP address to connect your P-touch Label Printer to a wired LAN connection, install the printer driver and Printer Setting Tool, and then specify wired LAN connection settings with [**Communication Settings**] in the Printer Setting Tool.

For more information, see *Changing the P-touch Label Printer Settings* on page 26.

- 1 Before connecting the LAN cable, make sure that the P-touch Label Printer is turned off.
- 2 Connect the LAN cable to the LAN port on the back of the P-touch Label Printer, and then connect the other end of the LAN cable to an active LAN port on the network.
- 3 Turn on the P-touch Label Printer.



Note

The printer's communication settings can be changed with [**Communication Settings**] in the Printer Setting Tool.

For more information, see *Changing the P-touch Label Printer Settings* on page 26.

Network Cable

Use a straight-through Category 5 (or greater) twisted-pair cable for 10BASE-T or 100BASE-TX Fast Ethernet Network.



Note

Connect this product to a LAN connection that is not liable to overvoltages.

Printing from a Computer

Available Applications

To use the P-touch Label Printer effectively, a number of applications and functions are available.

You must install the printer driver to use these applications.

Visit our website (www.brother.com/inst) and download the installer for the applications and printer driver.

Application	Windows	Mac	Features
Cable Label Tool	✓		Create and print labels for cables, patch panels, faceplates, electrical equipment and more.
P-touch Editor	✓	✓	Design and print custom labels with built in drawing tools, text using different fonts and styles, imported graphic images and barcodes.
P-touch Transfer Manager	✓		It allows you to transfer templates and other data to the P-touch Label Printer and save backups of your data on the computer. This application is installed with P-touch Editor.
P-touch Library	✓		Manage and print P-touch Editor templates. You can use P-touch Library to print templates. This application is installed with P-touch Editor.
P-touch Update Software	✓	✓	Update software to the latest version.
Printer Setting Tool	✓	✓	Specify the printer's device settings from a computer.
Wireless Device Setup Wizard		✓	This application allows you to configure your printer for a wireless network.
BRAdmin Light	✓		Finds the P-touch Label Printer on your network and is used to make basic configuration settings from your computer.
BRAdmin Professional	✓		Finds the P-touch Label Printer on your network and is used to make advanced configuration settings and updates from your computer.

Useful Function	Windows	Mac	Features
Distributed printing	✓		When printing a large number of labels, printing can be distributed among multiple printers. Because printing is performed at the same time, the total printing time can be reduced. For more information, see <i>Distributed Printing (Windows® Only)</i> on page 84.

Printing from Your Computer

There are various methods for printing with this P-touch Label Printer.

The following describes the procedure for printing from a computer using Cable Label Tool or P-touch Editor.



- 1 Start Cable Label Tool or P-touch Editor, and then open the document you want to print.
- 2 Create a label design.
- 3 Check the cutting options. (See *Cutting Options* on page 14.)
- 4 Select [**File**] then [**Print**] from the menu bar or by clicking the [**Print**] icon.

Cutting Options



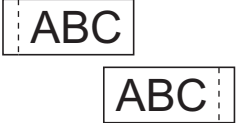

The cutting options allow you to specify how the item is fed and cut when it is printed. Use the printer driver to select the cutting option when printing from the computer using the application.

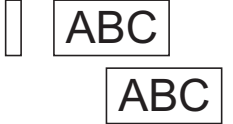
See the following table for a list of all available settings:

Tape Cut Option Table

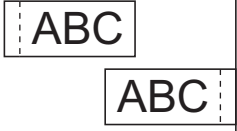
Auto Cut	Half Cut	Chain Printing	Image
No	Yes	No	
Yes	Yes	No	
No	No	No	
Yes	No	No	

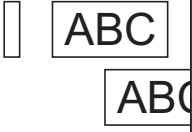
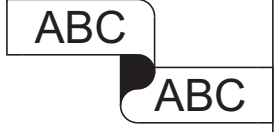
Tape Cut Option Table

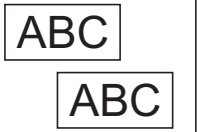
Auto Cut	Half Cut	Chain Printing	Image
No	Yes	Yes	
Yes	Yes	Yes	
No	No	Yes	
Yes	No	Yes	
Special tape			
No (FLe Label)	—	—	
Yes (FLe Label)	—	—	



Note

- When printing multiple copies of different labels, select chain printing option to reduce the blank space between the labels. (See *Tape Cut Option Table* on page 14.)
 - When using the chain printing option, press the ✂ (Feed&Cut) button after the last label is printed.
-

Attaching Labels

- 1 If needed, trim the printed label to the shape and length you want with scissors.
- 2 Peel the backing from the label.
- 3 Position the label, and then press firmly from top to bottom with your finger to attach the label.



Note

- The backing of some types of tapes may be pre-cut to make it easier to peel the backing. To remove the backing, simply fold the label lengthwise with the text facing inwards to expose the inside edges of the backing. Next, peel off the backing one piece at a time.
 - Labels may be difficult to attach to surfaces that are wet, dirty, or uneven. The labels may peel off easily from these surfaces.
 - Extra Strength Adhesive Tape:
 - For rough and textured surfaces, we recommend using Extra Strength Adhesive Tape.
 - Be sure to read the instructions provided with Fabric Tapes, Extra Strength Adhesive Tapes or other special tapes and observe all precautions noted in the instructions.
-

Installing Applications for Use with Mobile Devices

Brother offers various applications for use with your P-touch Label Printer, including applications that allow you to print directly from your Apple iPhone, iPad, and iPod touch or Android™ smartphone or tablets, and applications that allow you to transfer data, such as templates, symbols, and databases created using a computer, to your P-touch Label Printer wirelessly.

Available Applications

The following Brother applications can be downloaded free-of-charge from the App Store or Google Play™:



Application	Features
Mobile Cable Label Tool	Print labels for cables and patch panels using templates on a smartphone, tablet or other mobile device directly to your P-touch Label Printer.
Brother iPrint&Label	Create and print labels using templates on a smartphone, tablet or other mobile device directly to your P-touch Label Printer.
Mobile Transfer Express	Allows you to use a mobile device to download databases and label data, which was created on a computer using P-touch Editor and saved to a cloud service, and send them to your P-touch Label Printer.

Connecting the P-touch Label Printer to a Mobile Device

You can connect your P-touch Label Printer to a mobile device. To create and print labels directly from your mobile device, install the Brother mobile applications, and then connect your P-touch Label Printer to your mobile device.

- 1 Confirm the Wireless Direct settings of the P-touch Label Printer.
 - For Windows®
Connect the P-touch Label Printer and computer with a USB cable. Start the Printer Setting Tool on your computer, and click **[Communication Settings]**. Confirm that **[Infrastructure and Wireless Direct]** or **[Wireless Direct]** is selected for **[Selected Interface]** in **[Communication Settings]** in the **[General]** tab.

For more information, see *Printer Setting Tool for Windows®* on page 26.
 - For Mac
Connect the P-touch Label Printer and computer with a USB cable. Start the Printer Setting Tool on your computer, and confirm that **[WirelessDirect]** is set to **[On]** in the **[Wireless LAN]** tab.

For more information, see *Printer Setting Tool for Mac* on page 58.
- 2 Press and hold the  (Wi-Fi) button on your P-touch Label Printer for one second to turn the Wi-Fi function on.
The  (Wi-Fi) indicator starts flashing in green once every three seconds.





- 3 In the Wi-Fi settings screen of your mobile device, select the SSID of the P-touch Label Printer and enter the password.

 **Note**

- The factory settings for the SSID and password are as follows:
SSID: "DIRECT-*****_PT-P900W" or "DIRECT-*****_PT-P950NW" where "*****" is the last five digits of the product serial number.
(You can find the serial number label in the tape compartment of the P-touch Label Printer.)
Password (network key): 00000000
- You can connect the P-touch Label Printer to a mobile device in the Infrastructure Mode via a wireless access point/router.

Turning the Wireless Function On or Off

To turn the wireless function on or off, press the  (Wi-Fi) button.

- 1 Press the  (Wi-Fi) button. The wireless function is now on. The  (Wi-Fi) indicator lights/flashes in green.
- 2 Press the  (Wi-Fi) button again to turn the wireless function off. The  (Wi-Fi) indicator turns off.

 **Note**

When the wireless function is on, the Li-ion battery power will decrease quickly. To change the power source, connect the AC adapter.

Printing from a Mobile Device

Printing from Your Mobile Device

- 1 Start the application (Mobile Cable Label Tool/Brother iPrint&Label) on your mobile device.
(See *Available Applications* on page 17.)

 **Note**

Make sure that the P-touch Label Printer is connected to your mobile device.
See *Connecting the P-touch Label Printer to a Mobile Device* on page 17.

- 2 Select a label template or design.

 **Note**

You can also select a label or image you designed previously, and print it.





- 3 Check the cutting options. (See *Cutting Options* on page 19.)
- 4 Tap **[Print]** in the application menu.

Cutting Options



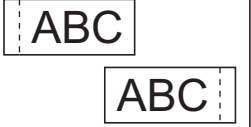

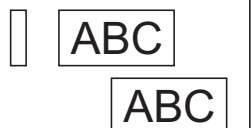
The cutting options allow you to specify how the item is fed and cut when it is printed. Use the printing option to select the cutting option when printing from the mobile device using the application.

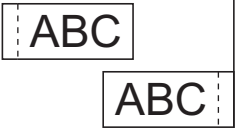
See the following table for a list of all available settings:

Tape Cut Option Table

Auto Cut	Half Cut	Chain Printing	Image
No	Yes	No	
Yes	Yes	No	
No	No	No	
Yes	No	No	
No	Yes	Yes	
Yes	Yes	Yes	

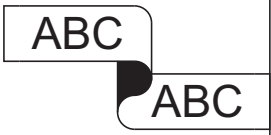
Tape Cut Option Table

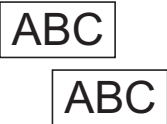
Auto Cut	Half Cut	Chain Printing	Image
No	No	Yes	
Yes	No	Yes	
Special tape			
No (FLe Label) (Mobile Cable Label Tool only)	—	—	
Yes (FLe Label) (Mobile Cable Label Tool only)	—	—	



Note

- When printing multiple copies of different labels, select chain printing option to reduce the blank space between the labels. (See *Tape Cut Option Table* on page 19.)
- When using the chain printing option, press the ✂ (Feed&Cut) button after the last label is printed.

Using a Mobile Device to Print Templates Created on a Computer

You can use P-touch Transfer Manager to save template data, which was created using P-touch Editor, in the BLF or PDZ format. Then, you can use Mobile Transfer Express to send the saved file from your mobile device to the P-touch Label Printer and print the file.

- 1 Save the template data in the BLF format or the PDZ format using P-touch Transfer Manager. For more information, see *Creating a BLF File or a PDZ File* on page 119.

- 2 Use one of the following methods to use a .blf file or .pdz file with your mobile device.
 - Save the file using a cloud storage service, and then use the sharing function of the mobile device's OS to share the file.
 - Send the file as an email attachment from the computer to the mobile device, and then save the file to the mobile device.
- 3 Connect the P-touch Label Printer to your mobile device, and then start Mobile Transfer Express. The template data appears.
- 4 Select the template that you want to print, and then transfer the template to the P-touch Label Printer.



Note

To download a file from a cloud storage service to your mobile device, you must connect your mobile device using Infrastructure Mode. Therefore, if you also connect your mobile device to the P-touch Label Printer using Infrastructure Mode, you can quickly transfer downloaded files (.blf file only).

- 5 Use the barcode scanner or the touch panel display (optional: PA-TDU-003)(PT-P950NW only) to select the template that you want to print from the transferred file and print it.

Attaching Labels

- 1 If needed, trim the printed label to the shape and length you want with scissors.
- 2 Peel the backing from the label.
- 3 Position the label, and then press firmly from top to bottom with your finger to attach the label.



Note

- The backing of some types of tapes may be pre-cut to make it easier to peel the backing. To remove the backing, simply fold the label lengthwise with the text facing inwards to expose the inside edges of the backing. Next, peel off the backing one piece at a time.
 - Labels may be difficult to attach to surfaces that are wet, dirty, or uneven. The labels may peel off easily from these surfaces.
 - Extra Strength Adhesive Tape:
 - For rough and textured surfaces, we recommend using Extra Strength Adhesive Tape.
 - Be sure to read the instructions provided with Fabric Tapes, Extra Strength Adhesive Tapes or other special tapes and observe all precautions noted in the instructions.
-

Using the Other Interfaces (Serial Interface/Bluetooth Interface)

To connect a barcode scanner or scale to the P-touch Label Printer using a serial cable or Bluetooth and use the P-touch Template functions, you must transfer a template to the printer in advance.

Installing the Printer Driver and Software

Install the printer driver and software (P-touch Editor).

For more information on installing the printer driver and software, see *Installing the Printer Driver and Software* on page 8.

Transferring the Template to P-touch Transfer Manager

Create the template using P-touch Editor, and then transfer the template to P-touch Transfer Manager.

For more information, see *Transferring the Template to P-touch Transfer Manager* on page 109.

Transferring Templates from the Computer to the P-touch Label Printer

Transfer the template to the printer using P-touch Transfer Manager.

For more information, see *Transferring Templates or Other Data from the Computer to the P-touch Label Printer* on page 112.

Connecting Using the Serial Adapter (Optional:PA-SCA-001)

You can connect the P-touch Label Printer to a barcode scanner or scale using a serial interface.

- 1 Before connecting the serial cable, make sure the P-touch Label Printer and the barcode scanner or scale are turned off.
- 2 Connect the RJ25 end of the adapter to the P-touch Label Printer.
- 3 Connect the P-touch Label Printer end of the serial cable to the DB9M side of this adapter.
- 4 Connect the other end of the serial cable to the serial port on your barcode scanner or scale.



Note

- The serial interface is not compatible with the Windows® or Mac printer drivers and is only used for template mode.
- The default communication settings are as follows:
Baud rate: 9600 bps
Parity: None
Bit length: 8 bits
Flow control: Hardware
- To change the communication settings, use [P-touch Template Settings] in the Printer Setting Tool. For more information on setting the P-touch Label Printer baud rate, download *P-touch Template Manual/Command Reference* (English only) from the Brother Solutions Center at support.brother.com
To download the latest version, from the Brother Solutions Center website:
 - 1 Visit support.brother.com
 - 2 Select the product, and then select [Manuals].

Serial adapter converts RJ25 to a D-sub 9-pin male connector.

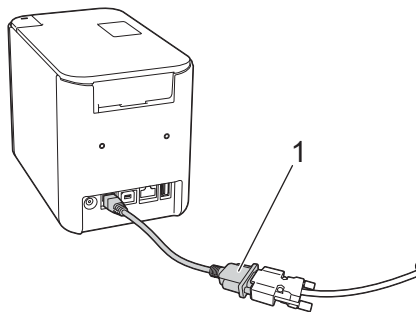

1 RJ25 to DB9M serial adapter

Serial (RS-232C) Cable (Windows® Only)

Serial (RS-232C) cables are not standard accessories.



Note

- For serial interfaces, a shielded interface cable should be used to ensure compliance with the limits for Electromagnetic Compatibility (EMC).
- Changes or modifications not expressly approved by Brother Industries, Ltd. may affect the performance and print quality, and damage may not be covered under the limited warranty.

The pin assignments for the serial cables (RS-232C cables) that can be used with this P-touch Label Printer are shown in the table below. You can purchase the cables at an electronics store. Do not use a serial cable that is longer than 5.9 ft.

PA-SCA-001 side (D-sub female, lock screw #4-40 inch screw)		Pin Assignments	Barcode scanner or scale side (D-sub 9-pin female)	
Signal Name	Pin Number		Pin Number	Signal Name
DCD	1		1	DCD
RXD	2		2	RXD
TXD	3		3	TXD
DTR	4		4	DTR
GND	5		5	GND
DSR	6		6	DSR
RTS	7		7	RTS
CTS	8		8	CTS
RI	9		9	RI

Serial Interface Settings

Use the following steps to change or confirm the port and the baud rate settings on the barcode scanner or scale and the P-touch Label Printer.

Setting the Barcode Scanner or Scale Baud Rate

For more information on setting the baud rate, see the instruction manual for the barcode scanner or scale.

Setting the P-touch Label Printer Baud Rate (Windows® Only)

To set the P-touch Label Printer baud rate, see *Preparation* on page 67. For more information, download *P-touch Template Manual/Command Reference* (English only) from the Brother Solutions Center at support.brother.com

[Select your region/country.] - [Manuals] - [Choose your product]

Connecting Using the Bluetooth Interface (Optional: PA-BI-002) (PT-P950NW Only)

You can connect the P-touch Label Printer to a barcode scanner using a Bluetooth interface (optional:PA-BI-002).



Note

- Follow the recommendations of the manufacturer of your Bluetooth-equipped devices such as barcode scanners or Bluetooth adapter and install any necessary hardware and software.
- The Bluetooth connection settings are saved even after the P-touch Label Printer is turned off.

To use a Bluetooth connection, the Bluetooth interface must be installed to the P-touch Label Printer. Refer to the instruction manual for more information on attaching the Bluetooth interface.







- Connecting the P-touch Label Printer to a computer using Bluetooth:

See **[FAQs & Troubleshooting]** on the Brother Solutions Center at support.brother.com.

- Connecting the P-touch Label Printer to a barcode scanner using Bluetooth:

This P-touch Label Printer will not be able to print using Bluetooth immediately after it has been enabled.

You must first follow the procedure below to allow the printer to communicate with your barcode scanner. Once a connection has been established, the printer remains connected until it is turned off, preventing it from connecting to another device.

- 1 Check that the Bluetooth interface is correctly attached to the P-touch Label Printer, and then use the slider to enable the Bluetooth interface.
- 2 Press and hold the  (Wi-Fi) button and the  (Power) button at the same time. The printer starts up in mass storage mode, the  (Power) indicator lights in green and the  (Status) indicator lights in orange.
- 3 Press and hold (about 5 seconds) the  (Feed&Cut) button until the  (Status) indicator blinks in green.
- 4 If the printer was automatically turned off, turn it on again.
- 5 Check that the Bluetooth indicator on the Bluetooth Interface is lights in green. The printer has entered Bluetooth mode. If the  (Status) indicator turns off, the printer has failed to enter the Bluetooth mode. Repeat the procedure from step 3.
- 6 Use the search and connect function of the barcode scanner to discover and connect to the printer.

Product Specifications of PA-BI-002

Size: approx. 3.82" (W) x 2.80" (D) x 0.71" (H) (97 mm (W) x 71 mm (D) x 18 mm (H))

Weight: approx. 0.11 lb (0.048 kg)

Printer Setting Tool for Windows[®]

Using the Printer Setting Tool, you can specify the printer's communication settings, device settings and P-touch Template settings from a Windows[®] computer.



Note

The Printer Setting Tool is installed automatically when you use the initial installer to install the printer driver. For more information, see *Installing the Printer Driver and Software* on page 8.



Important

The Printer Setting Tool is available only with compatible Brother printers.

Before Using the Printer Setting Tool

- Make sure the AC adapter is connected to the printer and to an AC power outlet, or a fully-charged battery is installed.
- Make sure the printer driver has been installed correctly and you can print.
- Connect this P-touch Label Printer to a computer with a USB cable. Settings cannot be specified using Wi-Fi using this tool.

Using the Printer Setting Tool for Windows®

- 1 Connect the P-touch Label Printer you want to configure to the computer.
- 2 Start the Printer Setting Tool.
 - **For Windows Vista® / Windows® 7 / Windows Server® 2008 / Windows Server® 2008 R2:**
From the Start button, click [All Programs] - [Brother] - [Label & Mobile Printer] - [Printer Setting Tool].
 - **For Windows® 8 / Windows® 8.1 / Windows Server® 2012 / Windows Server® 2012 R2:**
Click the [Printer Setting Tool] icon on the [Apps] screen.
 - **For Windows® 10:**
From the Start button, select [All apps], and then click [Brother] - [Label & Mobile Printer] - [Printer Setting Tool].
The main window appears.

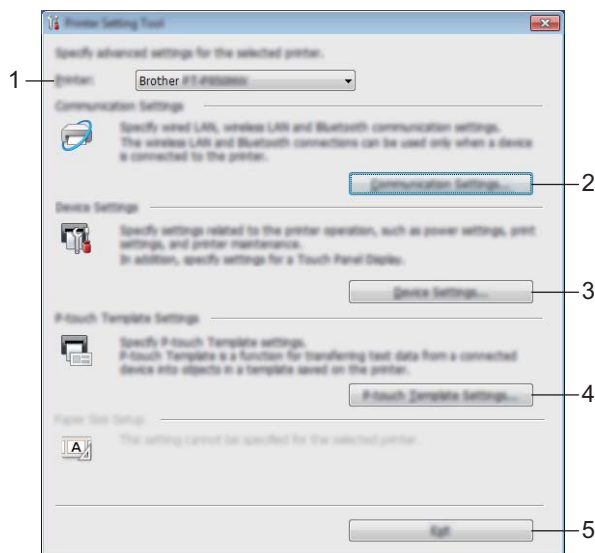

1 Printer

Lists the connected printers.

2 Communication Settings

Specify wired LAN (PT-P950NW only), wireless LAN and Bluetooth (PT-P950NW only) communication settings.

To use the Bluetooth connection, you must attach the corresponding optional unit to the P-touch Label Printer and specify connection settings.

3 Device Settings

Specifies printer device settings, such as power settings and printer settings. Settings can also be specified for the touch panel display (PT-P950NW only).

4 P-touch Template Settings

Specifies P-touch Template settings.

For more information on P-touch Template, download the *P-touch Template Manual/Command Reference* (English only) from the Brother Solutions Center at support.brother.com.

5 Exit

Closes the window.

- 3 Check that the P-touch Label Printer you want to configure appears next to **[Printer]**. If a different printer appears, select the P-touch Label Printer you want from the drop-down list.



Note

If only one P-touch Label Printer is connected, it is unnecessary to make a selection because only that P-touch Label Printer is available.

- 4 Select the setting you want to change, and then specify or change the settings in the dialog box. For more information on the settings dialog boxes, see *Communication Settings for Windows*[®] on page 29, *Device Settings for Windows*[®] on page 44 or *P-touch Template Settings for Windows*[®] on page 55.
- 5 Click **[Apply]** - **[Exit]** in the settings dialog box to apply the settings to the P-touch Label Printer.
- 6 Click **[Exit]** in the main window to finish specifying settings.

Important

Use the Printer Setting Tool to configure the P-touch Label Printer only when the P-touch Label Printer is in standby. The P-touch Label Printer may malfunction if you try to configure it while it is handling a job.

Communication Settings for Windows®

With [Communication Settings] in the Printer Setting Tool, the printer communication information can be specified or changed when connecting the printer and computer with a USB cable or via a Bluetooth connection (PT-P950NW only). Not only can you change the communication settings for one printer, but you can also apply the same settings to multiple printers.

Settings Dialog Box

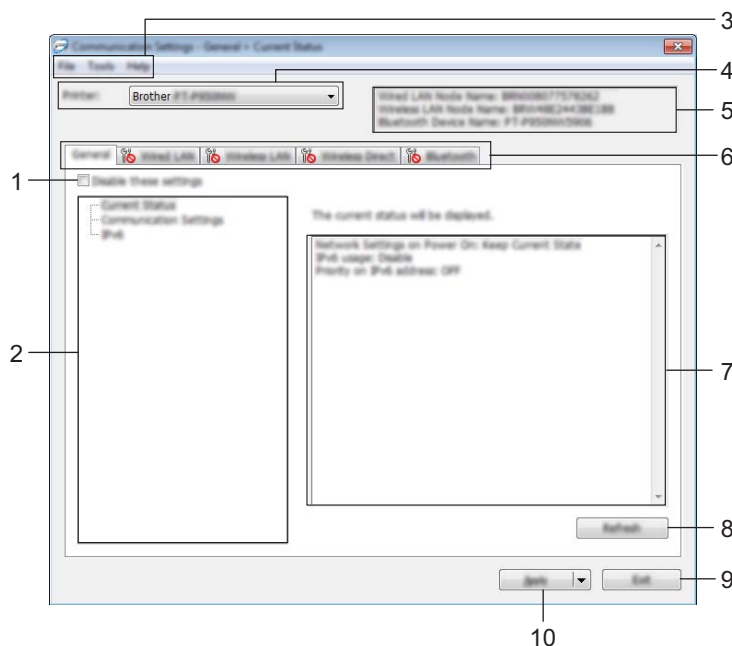

1 Disable these settings

When this check box is selected,  appears in the tab, and the settings can no longer be specified or changed.

Settings in a tab where  appears will not be applied to the printer even if [Apply] is clicked. In addition, the settings in the tab will not be saved or exported when the [Save in Command File] or [Export] command is executed.

To apply the settings to the printer or save or export them, make sure you clear the check box.

2 Items

When [Current Status] is selected, the current settings appear in the settings display/change area. Select the item for the settings that you want to change.

3 Menu Bar

4 Printer

Lists the connected printers.

5 Node Name

Displays the node name (nodes can be renamed). (See *Menu Bar* on page 31.)

6 Settings Tabs

Contains settings that may be specified or changed.

If  appears in the tab, the settings in that tab will not be applied to the printer.

7 Settings Display/Change Area

Displays the current settings for the selected item.

8 Refresh

Updates the displayed settings with the most recent information.

9 Exit

Exits [**Communication Settings**], and returns to the main window of the Printer Setting Tool.

! Important

Settings are not applied to printers if [**Exit**] is clicked without clicking the [**Apply**] button after changing settings.

10 Apply

Applies the settings to the printer.

To save the specified settings in a command file, select [**Save in Command File**] from the drop-down list. The saved command file can be used with the mass storage mode to apply the settings to a printer. (See *Mass Storage Mode* on page 82.)

! Important

Clicking [**Apply**] applies all settings in all tabs to the printer.

If the [**Disable these settings**] check box is selected, the settings in that tab are not applied.

Menu Bar

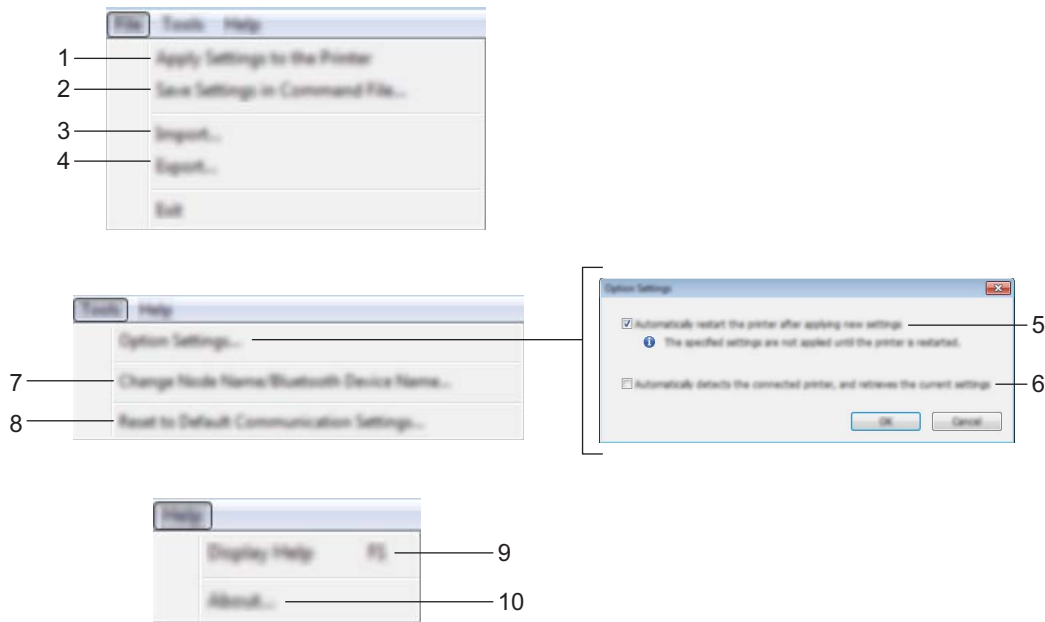

1 Apply Settings to the Printer

Applies the settings to the printer.

2 Save Settings in Command File

Saves the specified settings in a command file. The file extension is .bin.

The saved command file can be used with the mass storage mode to apply the settings to a printer. (See *Mass Storage Mode* on page 82.)



Note

If the **[Disable these settings]** check box is selected, the settings in that tab are not saved.

Important

- The following information is not saved with the command file:
 - Node name
 - IP address, subnet mask and default gateway (when the IP address is set to **[STATIC]**)
- The saved communication settings commands are intended to be used only for applying settings to a printer. To apply the settings to the printer using this command file, use the mass storage mode.
- Saved command files contain authentication keys and passwords. Take necessary measures to protect saved command files, such as saving them in a location that cannot be accessed by other users.
- Do not send the command file to a different printer model.

3 Import

■ Import from the current computer wireless settings

Imports the settings from the computer.



Note

- When importing the computer wireless settings, administrator privileges for the computer are needed.
- Only personal security authentication settings (open system, public key authentication and WPA/WPA2-PSK) can be imported. Enterprise security authentication (such as LEAP and EAP-FAST), WPA2-PSK (TKIP) and WPA-PSK (AES) settings cannot be imported.
- If multiple wireless LANs are enabled for the computer you use, the first wireless settings (only personal settings) that are detected will be considered for the import data.
- Only the settings (communication mode, SSID, authentication method, encryption mode and authentication key) from the **[Wireless LAN]** tab - **[Wireless Settings]** pane can be imported.

■ Select a Profile to import

Imports the exported file and applies the settings to a printer.

Click **[Browse]** and select the file you want to import. The settings in the selected file appear in the settings display/change area.



Note

- All settings, such as wireless settings or TCP/IP settings, can be imported, except for node names.
- Only profiles that are compatible with the selected printer can be imported.
- If the imported profile's IP address is set to **[STATIC]**, change the IP address of the imported profile, if needed, so that it does not duplicate the IP address of an existing configured printer on the network.

4 Export

Saves the current settings in a file.



Note

If the **[Disable these settings]** check box is selected, the settings in that tab are not saved.



Important

Exported files are not encrypted.

5 Automatically restart the printer after applying new settings

If this check box is selected, the printer automatically restarts after communication settings are applied.

If this check box is cleared, you must restart the printer manually.



Note

When configuring multiple printers, you can reduce the time needed to change settings by clearing this check box. In this case, we recommend selecting this check box when configuring the first printer so that you can confirm that each setting is operating as intended.

6 Automatically detects the connected printer, and retrieves the current settings

If this check box is selected and a printer is connected to the computer, the printer is automatically detected and the printer's current settings are displayed in the **[Current Status]** pane.



Note

If the model of the connected printer is different from that of the printer shown in the **[Printer]** drop-down list, the settings available on all tabs change to match the connected printer.

7 Change Node Name/Bluetooth Device Name

Allows renaming a node.

8 Reset to Default Communication Settings

Returns the communication settings to their factory settings.

9 Display Help

Displays the Help.

10 About

Displays the version information.

General Tab

Communication Settings

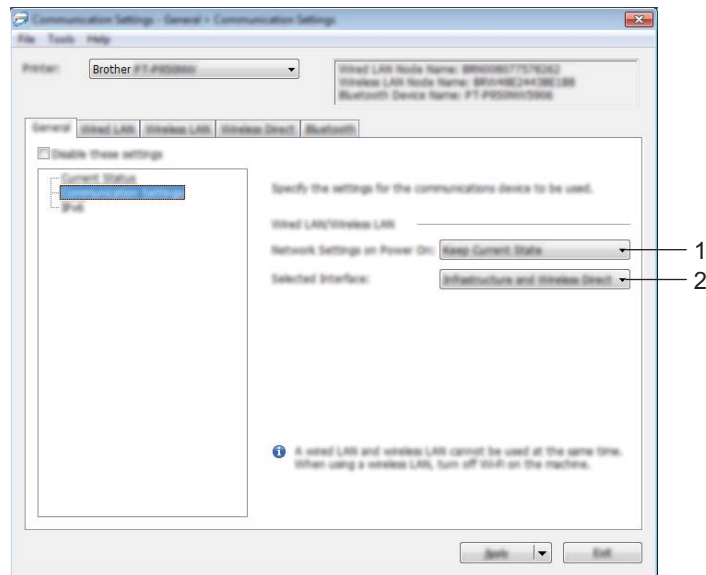

1 Network Settings on Power On

Specifies the conditions for connecting via Wi-Fi when the printer is turned on.

PT-P900W: Select [**On by Default**], [**Off by Default**] or [**Keep Current State**].

PT-P950NW: Select [**Wireless LAN by Default**], [**Wired LAN by Default**] or [**Keep Current State**].

2 Selected Interface

Select [**Infrastructure or Ad-hoc**], [**Infrastructure and Wireless Direct**] or [**Wireless Direct**].

IPv6

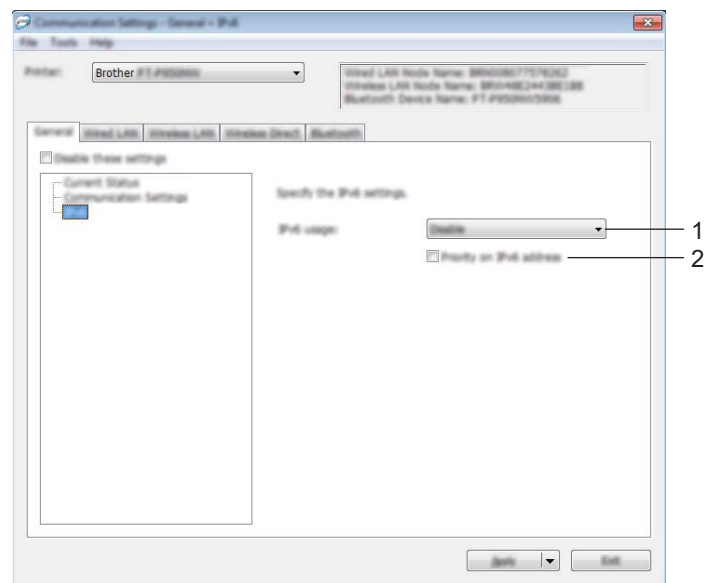

1 IPv6 usage

Select [Enable] or [Disable].

2 Priority on IPv6 address

Select to give priority to an IPv6 address.

Wired LAN (PT-P950NW Only)/Wireless LAN Tabs

TCP/IP (Wired)

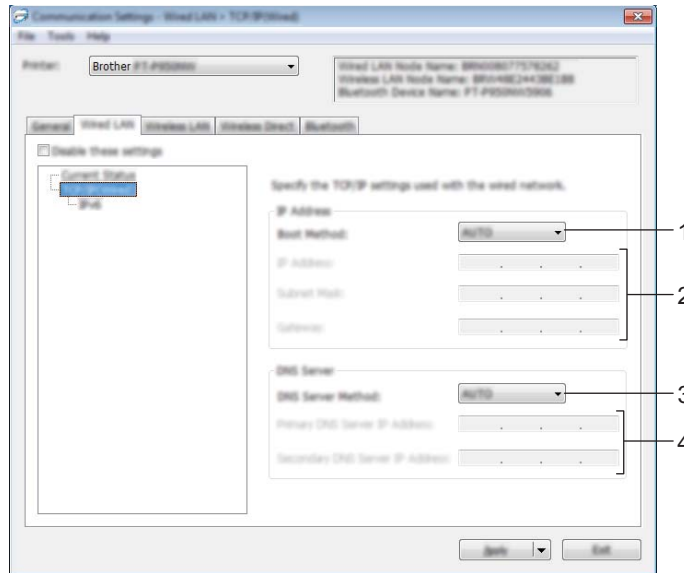

TCP/IP (Wireless)

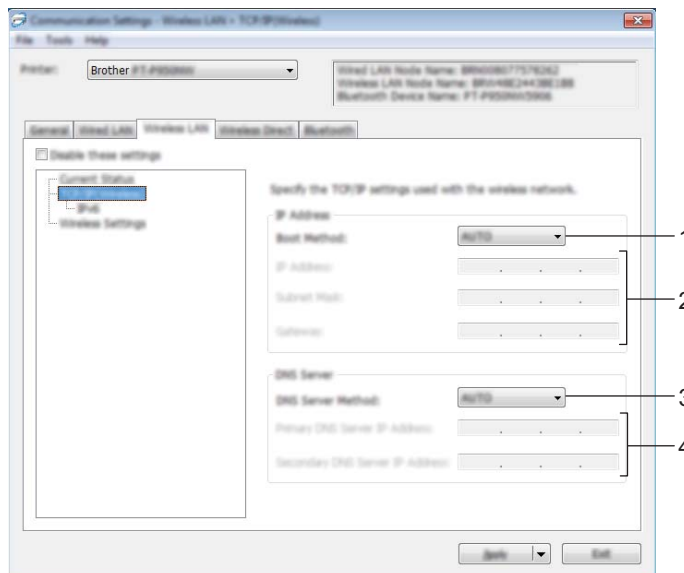

1 Boot Method

Select [AUTO], [BOOTP], [DHCP], [RARP] or [STATIC].

2 IP Address/Subnet Mask/Gateway

Specifies the various networking values.

You can type these settings only when the IP address is set to [STATIC].

3 DNS Server Method

Select **[AUTO]** or **[STATIC]**.

4 Primary DNS Server IP Address/Secondary DNS Server IP Address

You can type these settings only when the DNS server is set to **[STATIC]**.

IPv6

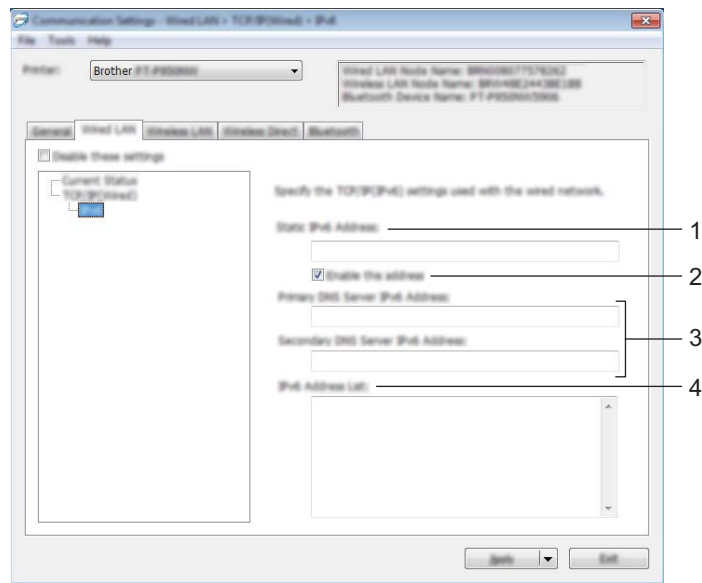

1 Static IPv6 Address

Specifies a permanent IPv6 address.

2 Enable this address

Enables the specified static IPv6 address.

3 Primary DNS Server IPv6 Address/Secondary DNS Server IPv6 Address

Specifies the DNS server IPv6 addresses.

4 IPv6 Address List

Displays the list of IPv6 addresses.

Wireless Settings

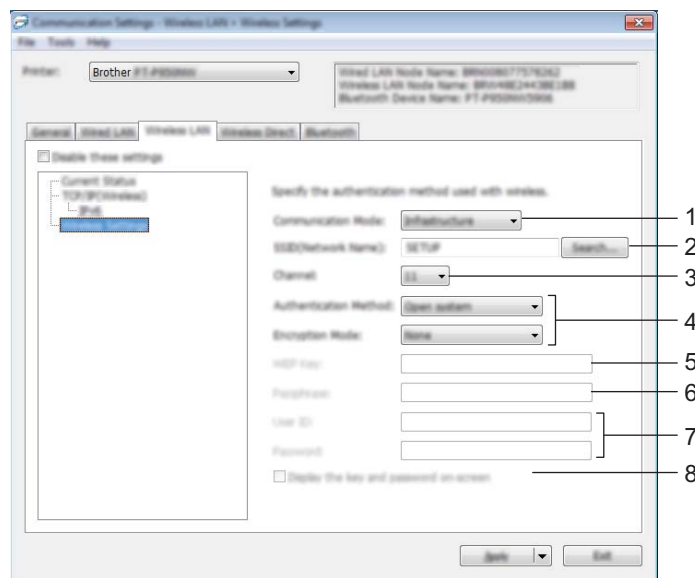

1 Communication Mode

Select [Infrastructure] or [Ad-hoc].

2 SSID (Network Name)

Clicking [Search] displays the available SSID selections in a separate dialog box.

3 Channel

Lists available channels.



Note

This setting is valid only in Ad-Hoc mode.

4 Authentication Method/Encryption Mode

The supported encryption modes for the authentication methods are as shown in *Communication Modes and Authentication Methods/Encryption Modes* on page 40.

5 WEP Key

You can specify a setting only when WEP is selected as the encryption mode.

6 Passphrase

You can specify a setting only when WPA/WPA2-PSK is selected as the authentication method.

7 User ID/Password

You can specify settings only when LEAP, EAP-FAST, PEAP, EAP-TTLS or EAP-TLS is selected as the authentication method. In addition, with EAP-TLS, it is not necessary to register a password, but a client certificate must be registered. To register a certificate, connect to the printer from a web browser, and then specify the certificate. For more information on using a web browser, see *Web Based Management* on page 148.

8 Display the key and password on-screen

If this check box is selected, keys and passwords are displayed in plain (non-encrypted) text.

Communication Modes and Authentication Methods/Encryption Modes

- When [Communication Mode] is set to [Ad-hoc]

Authentication Method	Encryption Mode
Open System	None / WEP

- When [Communication Mode] is set to [Infrastructure]

Authentication Method	Encryption Mode
Open System	None / WEP
Shared Key	WEP
WPA/WPA2-PSK	TKIP+AES / AES
LEAP	CKIP
EAP-FAST/NONE	TKIP+AES / AES
EAP-FAST/MS-CHAPv2	TKIP+AES / AES
EAP-FAST/GTC	TKIP+AES / AES
PEAP/MS-CHAPv2	TKIP+AES / AES
PEAP/GTC	TKIP+AES / AES
EAP-TTLS/CHAP	TKIP+AES / AES
EAP-TTLS/MS-CHAP	TKIP+AES / AES
EAP-TTLS/MS-CHAPv2	TKIP+AES / AES
EAP-TTLS/PAP	TKIP+AES / AES
EAP-TLS	TKIP+AES / AES

! Important

To specify higher level security settings:

When performing certificate verification with EAP-FAST, PEAP, EAP-TTLS or EAP-TLS authentication methods, the certificate cannot be specified from the Printer Setting Tool. After the printer is configured to connect to the network, specify the certificate by accessing the printer from a web browser.

For more information on using a web browser, see *Web Based Management* on page 148.

Wireless Direct Tab

Wireless Direct Settings

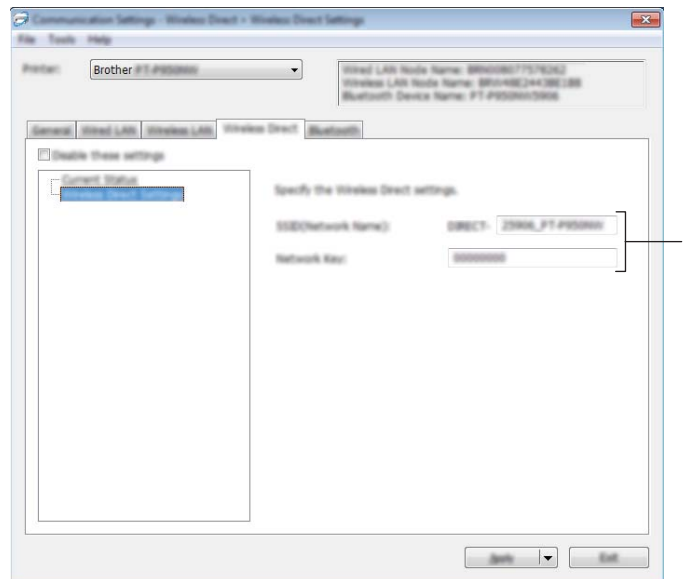

1 SSID (Network Name)/Network Key

Specifies the SSID (25 ASCII characters or fewer) and the network key (63 characters or fewer) you want to use in the Wireless Direct mode.



Note

The factory settings for the SSID and password are as follows:

SSID: "DIRECT-*****_PT-P900W" or "DIRECT-*****_PT-P950NW" where "*****" is the last five digits of the product serial number.

(You can find the serial number label in the tape compartment of the P-touch Label Printer.)

Password (Network key): 00000000

Bluetooth Tab (PT-P950NW Only)

Bluetooth Settings

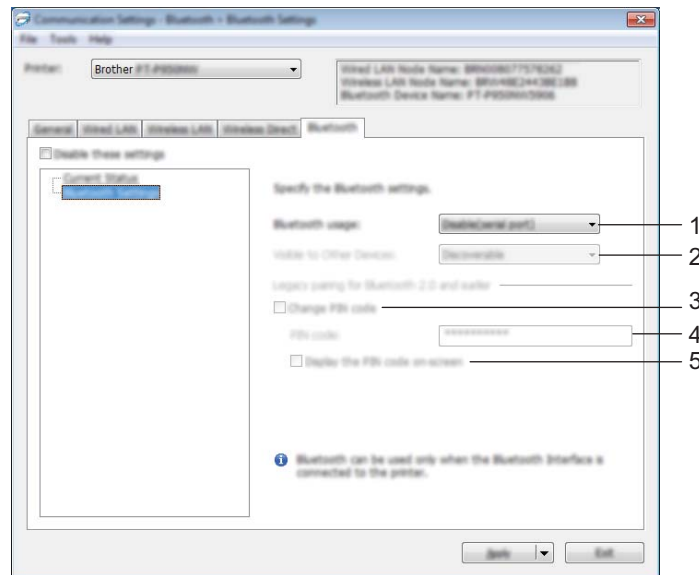

1 Bluetooth usage

Select [Enable] or [Disable(serial port)].

2 Visible to Other Devices

Allows the printer to be “discovered” by other Bluetooth devices.

Available settings: [Discoverable], [Not Discoverable]

3 Change PIN code

If this check box is selected, you can change the PIN.

4 PIN code

Specifies the PIN that will be used when pairing with devices compliant with Bluetooth 2.0 or earlier.

5 Display the PIN code on-screen

If this check box is selected, your computer displays PIN by default.

Applying Setting Changes to Multiple Printers

- 1 After applying settings to the first printer, disconnect the printer from the computer, and then connect the second printer to the computer.
- 2 Select the newly connected printer from the **[Printer]** drop-down list.



Note

If the **[Automatically detects the connected printer, and retrieves the current settings]** check box in the **[Option Settings]** dialog box is selected, the printer connected with the USB cable is automatically selected.

For more information, see *Communication Settings for Windows*[®] on page 29.

- 3 Click **[Apply]**.
The same settings that were applied to the first printer are applied to the second printer.



Note

We recommend selecting the **[Automatically restart the printer after applying new settings]** check box when configuring the first printer so that you can confirm that a connection with the wireless access point/router can be correctly established with the settings. For more information, see *Communication Settings for Windows*[®] on page 29.

- 4 Repeat steps 1 – 3 for all printers whose settings you want to change.

Important

If the IP address is set to **[STATIC]**, the printer's IP address will also be changed to the same address as the first printer.
Change the IP address if needed.



Note

To save the current settings in a file, click **[File] - [Export]**.

The same settings can be applied to another printer by clicking **[File] - [Import]**, then selecting the exported settings file. (See *Communication Settings for Windows*[®] on page 29.)

Device Settings for Windows®

With **[Device Settings]** in the Printer Setting Tool, printer settings can be specified or changed when connecting the printer and computer with a USB cable or via a Bluetooth connection. Not only can you change the device settings for one printer, but you can also apply the same settings to multiple printers.

When printing from a computer application, various printing settings can be specified from the printer driver; however, by using **[Device Settings]** in the Printer Setting Tool, more advanced settings can be specified.

When **[Device Settings]** is opened, the printer's current settings are retrieved and displayed. If the current settings could not be retrieved, the previous settings are displayed. If the current settings could not be retrieved and previous settings have not been specified, this tool's factory settings are displayed.

Settings Dialog Box

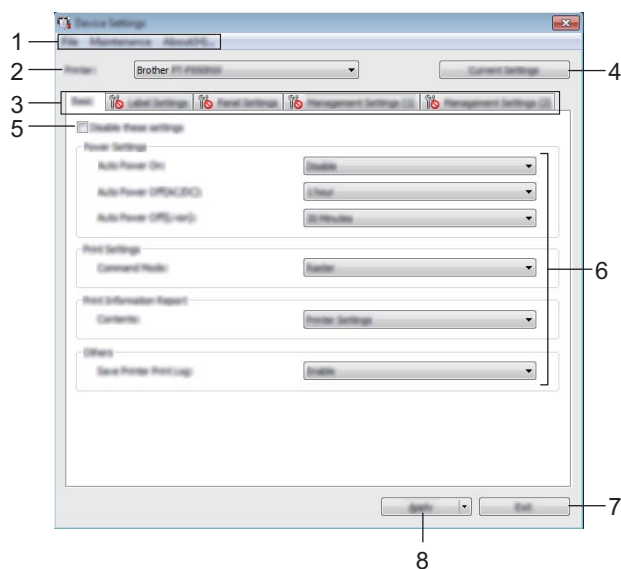

1 Menu Bar

Select a command contained in each menu from the list.

2 Printer

Specifies the printer whose device settings are to be configured.

If only one printer is connected, it is unnecessary to make a selection since only that printer will appear.

3 Settings Tabs

Contains settings that may be specified or changed.



Note

If  appears in the tab, the settings in that tab cannot be specified or changed. In addition, the settings in the tab will not be applied to the printer even if **[Apply]** is clicked. The settings in the tab will also not be saved or exported when the **[Save in Command File]** or **[Export]** command is executed.

4 Current Settings

Retrieves the settings from the currently connected printer and displays them in the dialog box. Settings will also be retrieved for parameters on tabs with .

5 Disable these settings

When this check box is selected,  appears in the tab, and the settings can no longer be specified or changed.

Settings in a tab where  appears will not be applied to the printer even if **[Apply]** is clicked. In addition, the settings in the tab will not be saved or exported when the **[Save in Command File]** or **[Export]** command is executed.

6 Parameters

Displays the current settings.

7 Exit

Exits **[Device Settings]**, and returns to the main window of the Printer Setting Tool.

8 Apply

Applies the settings to the printer.

To save the specified settings in a command file, select **[Save in Command File]** from the drop-down list. The saved command file can be used with the mass storage mode to apply the settings to a printer. (See *Mass Storage Mode* on page 82.)

Menu Bar

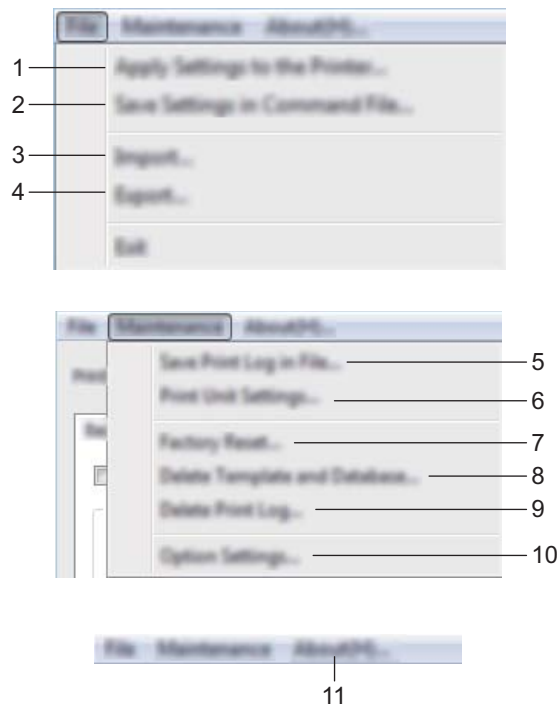

1 Apply Settings to the Printer

Applies the settings to the printer.

Performs the same operation as when **[Apply]** is clicked.

2 Save Settings in Command File

Saves the specified settings in a command file.

Performs the same operation as when **[Save in Command File]** is selected from the **[Apply]** drop-down list.

3 Import

Imports the exported file.

4 Export

Saves the current settings in a file.

5 Save Print Log in File

Saves the print log in a file in the CSV format.

6 Print Unit Settings

Prints a report containing firmware version and device setting information.

You can also print this report using the ✂ (Feed&Cut) button (see *Confirming the P-touch Label Printer Settings* on page 82).



Note

When you print this report, use 0.94" (24 mm) or 1.4" (36 mm) tape.

7 Factory Reset

Resets all printer settings to factory settings.

8 Delete Template and Database

Deletes the templates and databases stored in the printer.

9 Delete Print Log

Deletes the print log stored in the printer.

10 Option Settings

If the [**Do not display an error message if the current settings cannot be retrieved at startup**] check box is selected, a message will not be displayed next time.

11 About

Displays the version information.

Basic Tab

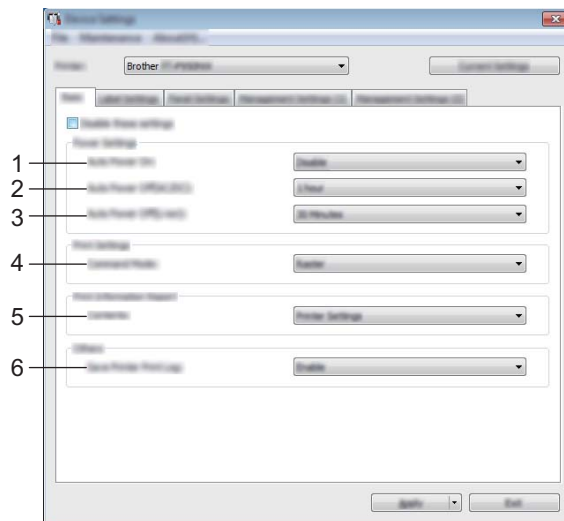

1 Auto Power On

Specifies whether the printer turns on automatically when the power supply cord is plugged into an AC power outlet.

Available settings: **[Disable]**, **[Enable]**

2 Auto Power Off (AC/DC)

Specifies the period of time that passes before the printer turns off automatically when connected to an AC power outlet.

Available settings: **[None]**, 10/20/30/40/50 Minutes, 1/2/4/8/12 hours

3 Auto Power Off (Li-ion)

Specifies the period of time that passes before the printer turns off automatically when powered by the rechargeable Li-ion battery.

Available settings: **[None]**, 10/20/30/40/50 Minutes, 1 hour

4 Command Mode

Specifies the printer's command format.

Available settings: **[Raster]**, **[ESC/P]**, **[P-touch Template]**

5 Contents

Specifies the printer information that will be printed.

Available settings: **[All]**, **[Usage Log]**, **[Printer Settings]**, **[Printer Transfer Data]**

6 Save Printer Print Log

Select whether or not to save the printer's print log. If **[Disable]** is applied to the printer, **[Maintenance]** - **[Save Print Log in File]** does not work.

Available settings: **[Enable]**, **[Disable]**

Label Settings Tab

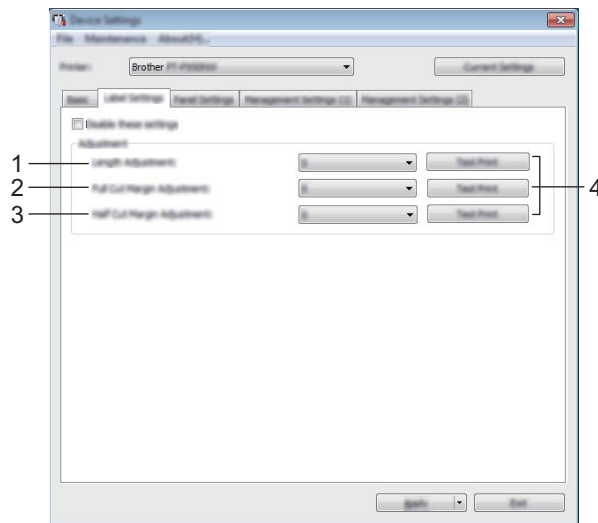

1 Length Adjustment

Adjusts the length of the printed label to correspond to the length of the label displayed on the computer.
Available settings: -4 to +4 (1 increments)

2 Full Cut Margin Adjustment

Adjusts the margin length when fully cutting labels.
Available settings: -2 to +2 (1 increments)

3 Half Cut Margin Adjustment

Adjusts the margin length when half-cutting labels.
Available settings: -2 to +2 (1 increments)

4 Test Print

Prints a test label to check the results of each adjustment.

Panel Settings Tab (PT-P950NW Only)

Specify the settings when the touch panel display (optional) is used.

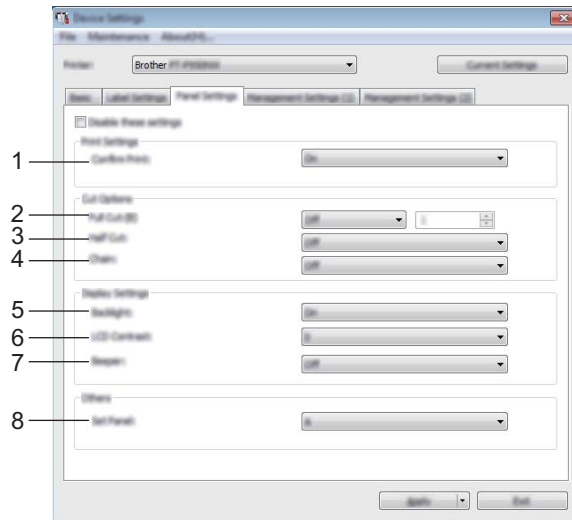

1 Confirm Print

Select whether a message appears before printing so that the number of copies can be confirmed.

Available settings: **[On]**, **[Off]**

2 Full Cut

Select whether to cut the labels automatically and how many labels to print before cutting them.

Available settings: **[On]**, **[Off]** (A number between 1 and 99 can be specified.)

3 Half Cut

Select whether to use half cuts.

Available settings: **[On]**, **[Off]**

4 Chain

Select whether to use chain printing.

Available settings: **[On]**, **[Off]**

5 Backlight

Select whether the LCD display backlight is turned on.

Available settings: **[On]**, **[Off]**

6 LCD Contrast

Select the LCD display contrast.

Available settings: -2--+2

7 Beeper

Select whether the printer beeps when a touch panel key is pressed.

Available settings: **[On]**, **[Off]**

8 Set Panel

Select the touch panel you want.

Available settings: **[A]**, **[B]**

Management Tabs (PT-P950NW Only)

Specify the settings when the touch panel display (optional) is used.

❗ Important

To display these tabs, you must have administrator privileges for the computer or the printer.

You can confirm the administrator privileges for the printer in the [Printer properties] - [Security] tab.

Management (1)

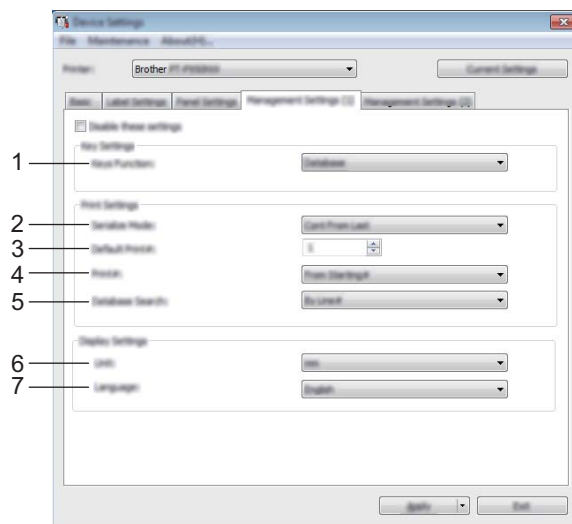

Management (2)

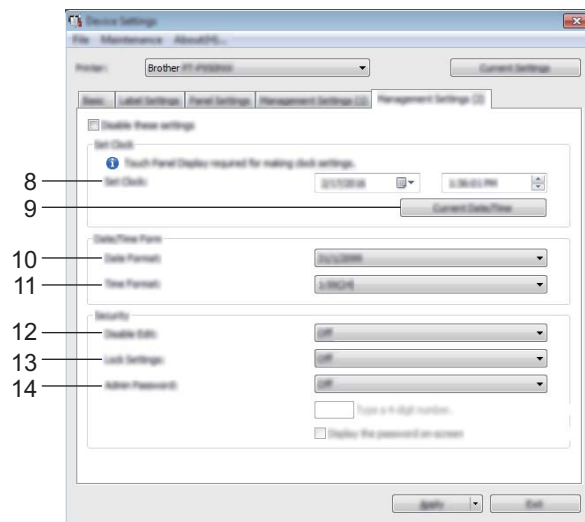

1 Keys Function

Select the type of data assigned to keys in the one-touch panel.

To assign templates, select [**Template**].

To assign databases linked to a single template, select [**Database**].

Available settings: [**Template**], [**Database**]

2 Serialize Mode

Select whether to serialize from the last number printed.

Available settings: [**Cont From Last**], [**From Starting#**]

3 Default Print#

Specify the default number of copies that appears when printing.

Available settings: 1–999

4 Print#

Select whether the number of copies set from the touch panel display (TDU), remains set after the copies are printed.

This TDU setting is applied until the printer is turned off.

Available settings: [**From Starting#**], [**Cont from Last**]

5 Database Search

When using a template with a linked database, select whether to search for database records by their line number or by their data.

Available settings: [**By Line#**], [**By Data**]

6 Unit

Select the measurement units for displayed settings.

Available settings: [**mm**], [**inch**]

7 Language

Select the language of the touch panel display.

Available settings: [**Dansk**], [**Deutsch**], [**English**], [**Español**], [**Français**], [**Italiano**], [**Nederlands**], [**Norsk**], [**Português**], [**Suomi**], [**Svenska**], [中文], [日本語]



Note

The possible display languages differ depending on the printer model you are using. If the selected language cannot be used for the touch panel display, the display language will not be changed. Make sure that the touch panel display can display the selected language.

8 Set Clock

Set the date and time for the touch panel display.

To specify the time settings, you must attach the touch panel display.

9 Current Date/Time

Click to retrieve the current date and time from the computer and display them.

10 Date Format

Select the date format for the clock.

11 Time Format

Select the time format for the clock.

12 Disable Edit

Select whether label layouts can be edited.

Available settings: **[On]**, **[Off]**

13 Lock Settings

Select whether settings selected by pressing **[⚙]** (settings key) on the touch panel display can be changed.

Available settings: **[On]**, **[Off]**

14 Admin Password

Set a password for accessing basic settings specified by pressing **[↵]** (admin key) on the touch panel display. Set a 4-digit password. If the **[Display the password on-screen]** check box is selected, specified passwords appear in computer windows.

Applying Setting Changes to Multiple Printers

- 1 After applying settings to the first printer, disconnect the printer from the computer, and then connect the second printer to the computer.
- 2 Select the newly connected printer from the **[Printer]** drop-down list.
- 3 Click **[Apply]**.
The same settings that were applied to the first printer are applied to the second printer.
- 4 Repeat steps 1 – 3 for all printers whose settings you want to change.



Note

To save the current settings in a file, click **[File]** - **[Export]**.

The same settings can be applied to another printer by clicking **[File]** - **[Import]**, and then selecting the exported settings file. (See *Device Settings for Windows*[®] on page 44.)

P-touch Template Settings for Windows®

P-touch template mode provides operations for inserting data into text and barcode objects in a downloaded template from a barcode scanner (optional: PA-BR-001) or other device connected to the P-touch Label Printer.

With [**P-touch Template Settings**] in the Printer Setting Tool, settings for using the P-touch Template functions can be specified or changed.



Note

- P-touch template mode is also compatible with other input devices like a scale, testing machine, controller or a programmable logic device.
 - For more information on P-touch Template, download the *P-touch Template Manual/Command Reference* (English only) from the Brother Solutions Center at support.brother.com
[Select your region/country.] - [Manuals] - [Choose your product]
-

P-touch Template Settings Dialog Box

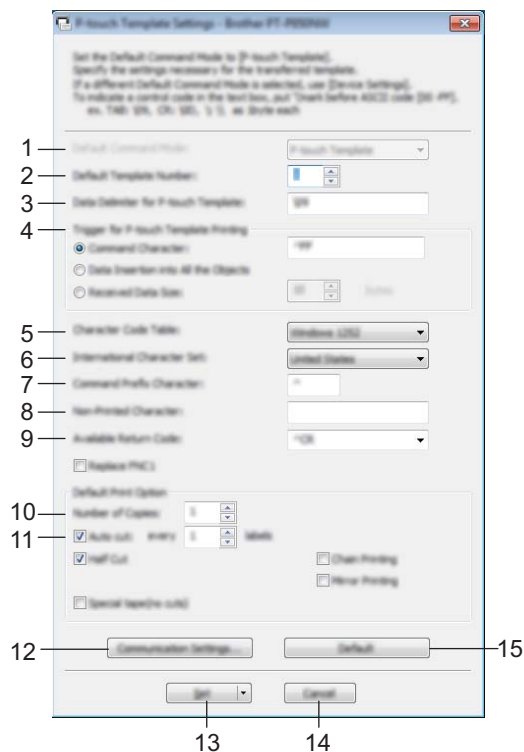

1 Default Command Mode

Specifies the P-touch Template mode as the default mode.
To change the mode, use the Device Settings.

2 Default Template Number

Specifies a template number to select as default when the printer is turned on.
However, if a template is not to be transferred to the printer, do not specify a template number.

3 Data Delimiter for P-touch Template

A symbol used to indicate the boundaries between groups of data in a file. Between 1 and 20 characters can be specified.

4 Trigger for P-touch Template Printing

You can specify a trigger to begin printing from a number of options.

[Command Character]: Printing starts when the command character specified here is received.

[Data Insertion into All the Objects]: Printing starts when the delimiter for the last object is received.

[Received Data Size]: Printing starts when the number of characters specified here is received. However, delimiters are not counted in the number of characters.

5 Character Code Table

Select one of the following character code sets:

Available settings: **[Windows 1252]**, **[Windows 1250 Eastern Europe]**, **[Brother standard]**

6 International Character Set

Lists character sets for specific countries.

Available settings: [United States], [France], [Germany], [Britain], [Denmark], [Sweden], [Italy], [Spain], [Japan], [Norway], [Denmark II], [Spain II], [Latin America], [Korea], [Legal]

The following 12 codes are switched depending on the country selected from the list above:

23h 24h 40h 5Bh 5Ch 5Dh 5Eh 60h 7Bh 7Ch 7Dh 7Eh

For switched characters, see the *P-touch Template Manual/Command Reference* (which can be downloaded from the Brother Solutions Center website).

7 Command Prefix Character

Specifies the prefix character code, which identifies commands used in P-touch Template mode.

8 Non-Printed Character

Characters specified here are not printed when data is received. Specify 1 to 20 characters.

9 Available Return Code

The line feed code is used when feeding data to indicate that the following data should be moved to the next line in a text object. One of the following four line feed codes can be selected, or 1 to 20 characters can be specified as the line feed code.

Available settings: [^CR], [\0D\0A], [\0A], [\0D]

10 Number of Copies

Sets the number of copies. A number between 1 and 99 can be specified.

11 Cut option

Specifies whether to cut the labels automatically and how many labels to print before cutting them. A number between 1 and 99 can be specified.

You can also select other cutting options.

12 Communication Settings

Specifies the communication settings.

13 Set

Applies the settings to the printer.

To save the specified settings in a command file, select [**Save in Command File**] from the drop-down list. The saved command file can be used with the mass storage mode to apply the settings to a printer. (See *Mass Storage Mode* on page 82.)

14 Cancel

Cancels the settings and closes the dialog box. The settings will remain unchanged.

15 Default

Returns to factory settings.

Printer Setting Tool for Mac

Using the Printer Setting Tool, you can specify the printer's communication settings and device settings from a Mac. Not only can you change the device settings for one printer, but you can also apply the same settings to multiple printers.



Note

The Printer Setting Tool is installed automatically when you use the initial installer to install the printer driver. For more information, see *Installing the Printer Driver and Software* on page 8.



Important

The Printer Setting Tool is available only with compatible Brother printers.

Before Using the Printer Setting Tool

- Make sure the AC adapter is connected to the printer and to an AC power outlet, or a fully-charged battery is installed.
- Make sure the printer driver has been installed correctly and you can print.
- Connect this P-touch Label Printer to a computer with a USB cable. Settings cannot be specified using Wi-Fi using this tool.

Using the Printer Setting Tool for Mac

- 1 Connect the P-touch Label Printer you want to configure to the computer.
- 2 Click **[Macintosh HD]** - **[Applications]** - **[Brother]** - **[Printer Setting Tool]** - **[Printer Setting Tool.app]**. The **[Printer Setting Tool]** window appears.
- 3 Check that the P-touch Label Printer you want to configure appears next to **[Printer]**. If a different printer appears, select the P-touch Label Printer you want from the drop-down list.



Note

If only one P-touch Label Printer is connected, it is unnecessary to make a selection because only that P-touch Label Printer will appear.

- 4 Select a setting tab, and then specify or change the settings.
- 5 Click **[Apply Settings to the Printer]** in the setting tab to apply the settings to the P-touch Label Printer.
- 6 Click **[Exit]** to finish specifying settings.



Important

Use the Printer Setting Tool to configure the P-touch Label Printer only when the P-touch Label Printer is in standby. The P-touch Label Printer may malfunction if you try to configure it while it is handling a job.

Settings Dialog Box

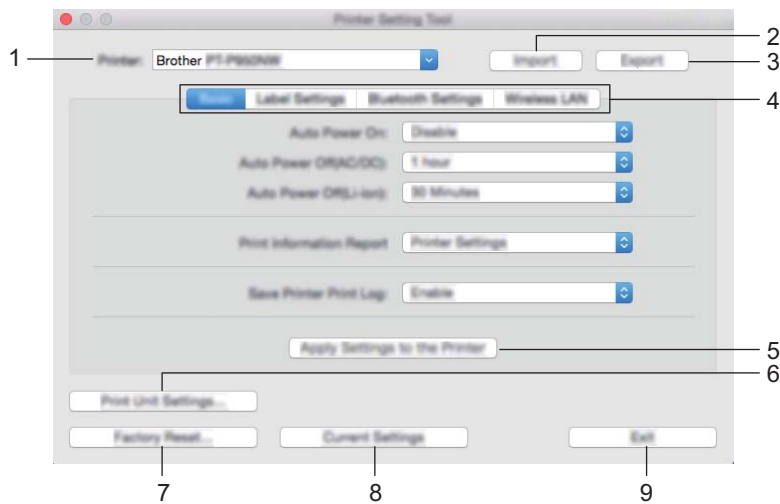

1 Printer

Lists the connected printers.

2 Import

Imports settings from a file.

3 Export

Saves the current settings in a file.

4 Setting Tabs

Contain settings that may be specified or changed.

5 Apply Settings to the Printer

Applies the settings to the printer.

6 Print Unit Settings

Prints a report containing firmware version and device setting information.

You can also print this report using the ⌘ (Feed&Cut) button (see *Confirming the P-touch Label Printer Settings* on page 82).



Note

When you print this report, use 0.94" (24 mm) or 1.4" (36 mm) tape.

7 Factory Reset

Resets printer settings to factory settings.

8 Current Settings

Retrieves the settings from the currently connected printer and displays them in the dialog box.

9 Exit

Exits the Printer Setting Tool.

Basic Tab

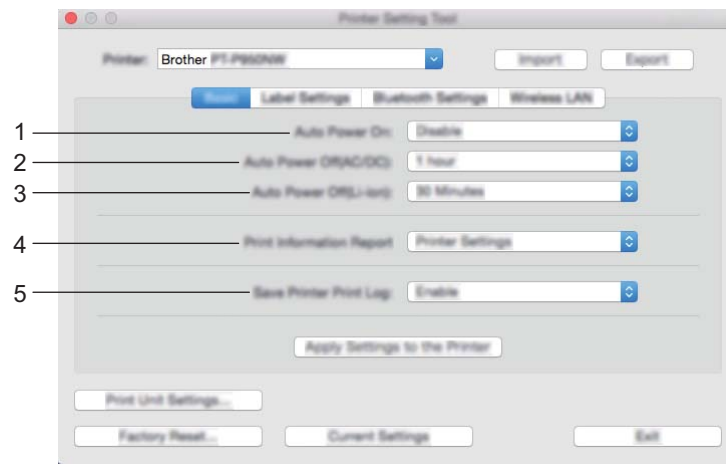

1 Auto Power On

Specifies whether the printer turns on automatically when the power supply cord is plugged into an AC power outlet.

Available settings: **[Disable]**, **[Enable]**

2 Auto Power Off (AC/DC)

Specifies the period of time that passes before the printer turns off automatically when connected to an AC power outlet.

Available settings: **[None]**, 10/20/30/40/50 Minutes, 1/2/4/8/12 hours

3 Auto Power Off (Li-ion)

Specifies the period of time that passes before the printer turns off automatically when powered by the rechargeable Li-ion battery.

Available settings: **[None]**, 10/20/30/40/50 Minutes, 1 hour

4 Print Information Report

Specifies the printer information that will be printed.

Available settings: **[All]**, **[Usage Log]**, **[Printer Settings]**, **[Printer Transfer Data]**

5 Save Printer Print Log

Select whether or not to save the printer's print log.

Available settings: **[Enable]**, **[Disable]**

Label Settings Tab

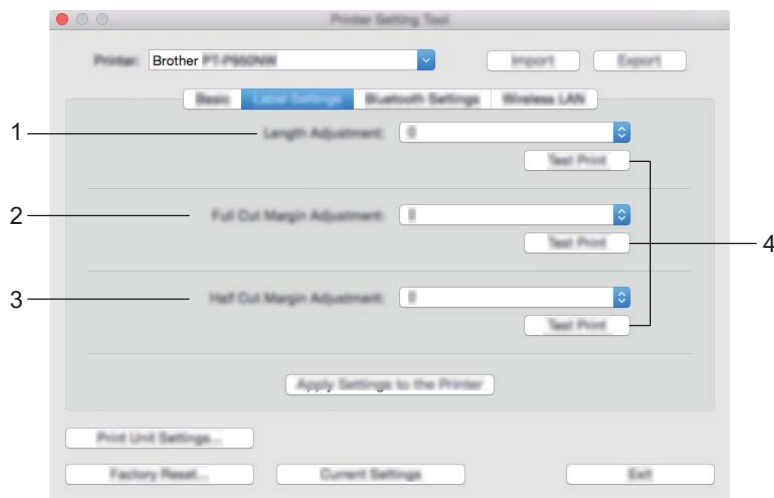

1 Length Adjustment

Adjusts the length of the printed label to correspond to the length of the label displayed on the computer.
Available settings: -4 to +4 (1 increments)

2 Full Cut Margin Adjustment

Adjusts the margin length when fully cutting labels.
Available settings: -2 to +2 (1 increments)

3 Half Cut Margin Adjustment

Adjusts the margin length when half-cutting labels.
Available settings: -2 to +2 (1 increments)

4 Test Print

Prints a test label to check the results of the settings.

Bluetooth Settings Tab (PT-P950NW Only)

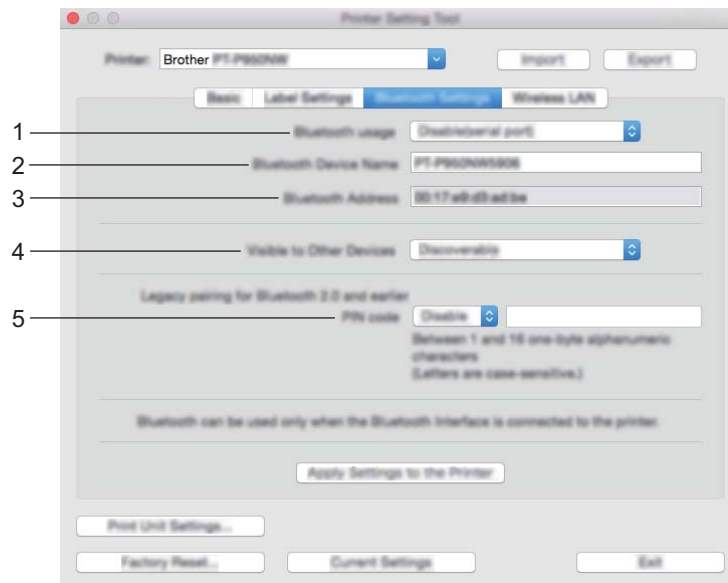

1 Bluetooth usage

Select [Enable] or [Disable(serial port)].

2 Bluetooth Device Name

Allows to type the Bluetooth device name.

3 Bluetooth Address

Displays the acquired Bluetooth address.

4 Visible to Other Devices

Allows the printer to be "discovered" by other Bluetooth devices.

Available settings: [Discoverable], [Not Discoverable]

5 PIN code

Enables or disables the PIN used when pairing with devices.

Wireless LAN Tab

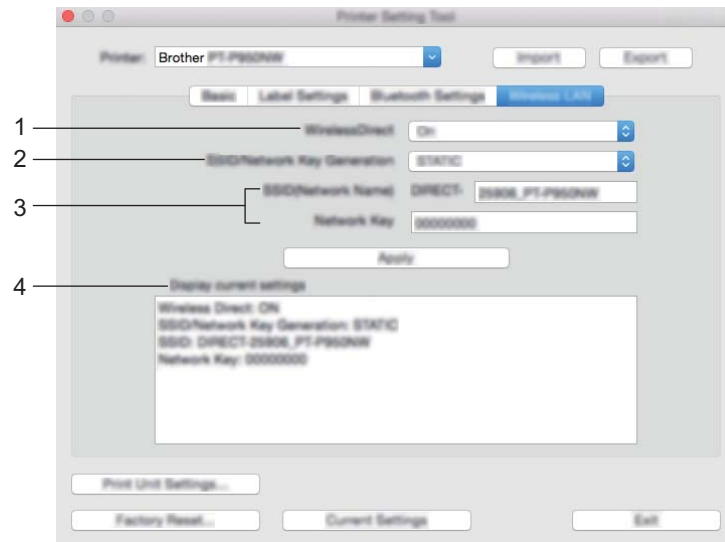

1 WirelessDirect

Turns the Wireless Direct function on or off.

2 SSID/Network Key Generation

Select [AUTO] or [STATIC].

3 SSID (Network Name)/Network Key

Specifies the SSID (3 to 25 ASCII characters) and the network key you want to use in the Wireless Direct mode.

You can specify a setting only when [STATIC] is selected as [SSID/Network Key Generation].

4 Display current settings

Displays the current settings for Wireless Direct. Click [Current Settings] to update the displayed settings with the most recent information.

Applying Setting Changes to Multiple Printers

- 1 After applying settings to the first printer, disconnect the printer from the computer, and then connect the second printer to the computer.
- 2 Select the newly connected printer from the **[Printer]** drop-down list.
- 3 Click **[Apply Settings to the Printer]**.
The same settings that were applied to the first printer are applied to the second printer.
- 4 Repeat steps 1 – 3 for all printers whose settings you want to change.



Note

To save the current settings in a file, click **[Export]**.

The same settings can be applied to another printer by clicking **[Import]**, then selecting the exported settings file. (See *Settings Dialog Box* on page 59.)

Changing Settings When Printing from a Mobile Device

If using a mobile device, change the settings as necessary using the application before printing. The settings that can be changed vary according to the application.



Note

Before connecting a mobile device, you can specify detailed settings by connecting the P-touch Label Printer to a computer and using the Printer Setting Tool (see *Changing the P-touch Label Printer Settings* on page 26).

P-touch Template Operations

P-touch template mode provides operations for inserting data into text and barcode objects in a downloaded template from a barcode scanner (optional: PA-BR-001) or other device connected to the P-touch Label Printer.

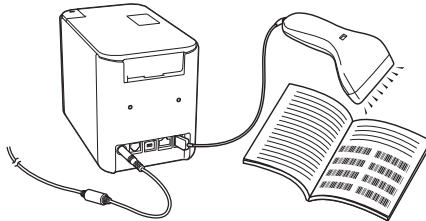

Basic operations

■ *Standard Template Printing* (See page 71)

Download frequently used templates or images and simply scan a barcode to select which one to print.

■ *Advanced Template Printing* (See page 73)

Download a template and scan a barcode to print a copy or insert the scanned data into a different looking label.

■ *Database Lookup Printing* (See page 76)

Download a database linked to a template and scan a barcode to find a record to insert into the template and print it out.

Advanced Features

■ *Numbering (Serialized Number) Printing* (See page 79)

Automatically increment a text or barcode in any downloaded template while printing.



Note

- P-touch template mode is also compatible with other input devices like a scale, testing machine, controller or a programmable logic device.
- See the *P-touch Template Manual/Command Reference* for more information. You can download the latest versions from the Brother Solutions Center at support.brother.com

[Select your region/country.] - [Manuals] - [Choose your product]

Preparation

Before connecting the barcode scanner to the P-touch Label Printer, specify the barcode scanner settings using the P-touch Template setting tool (inside Printer Setting Tool).

Specifying Settings in the P-touch Template Settings Tool

- 1 Connect the P-touch Label Printer and the computer with a USB cable, and then turn on the P-touch Label Printer.
- 2 Start the Printer Setting Tool.
 - **For Windows Vista® / Windows® 7 / Windows Server® 2008 / Windows Server® 2008 R2:**
From the Start button, click [All Programs] - [Brother] - [Label & Mobile Printer] - [Printer Setting Tool].
 - **For Windows® 8 / Windows® 8.1 / Windows Server® 2012 / Windows Server® 2012 R2:**
Click the [Printer Setting Tool] icon on the [Apps] screen.
 - **For Windows® 10:**
From the Start button, select [All apps], and then click [Brother] - [Label & Mobile Printer] - [Printer Setting Tool].
- 3 Click [P-touch Template Settings].
- 4 Select the appropriate settings, and then click [Set].

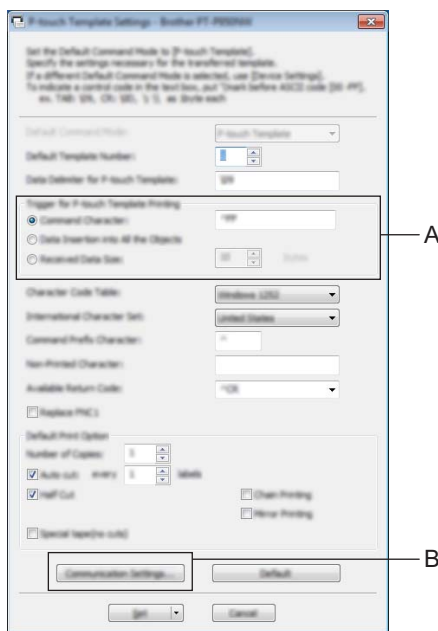



Note

- By default, printing begins with the code "^FF" is scanned from a barcode using a barcode scanner. (This can be changed with the settings in A.)
If [**Received Data Size**] is selected with the number of bytes setting, the template will automatically print out after the specified number of bytes have been scanned in.
 - Because the print mode setting will return to raster mode each time you print from the computer, you must change the setting to template mode again.
 - If you turn off the P-touch Label Printer and then turn it on again, the printer starts up in template mode.
-

Specifying the RS232C Serial Port Settings

If you are using a barcode scanner or other device with an RS-232C serial interface, you will need to set the serial communications in the barcode scanner and the P-touch Label Printer to be the same in order to operate reliably. You will also need the serial adapter (optional: PA-SCA-001).



Note

Refer to the barcode scanner programming reference manual before making these settings. We recommend starting with the barcode scanner factory settings and change the communication settings in the P-touch Label Printer because many barcode scanners are more difficult to program. The factory communication settings for the P-touch Label Printer are shown below.

Baud rate	[9600] bps
Bit Length	[8] bits
Parity	[None]
Busy Control	[DTR]

- 1 Click Communication Settings (B) shown in the previous step 4 "Specifying settings in the P-touch Template Settings tool".

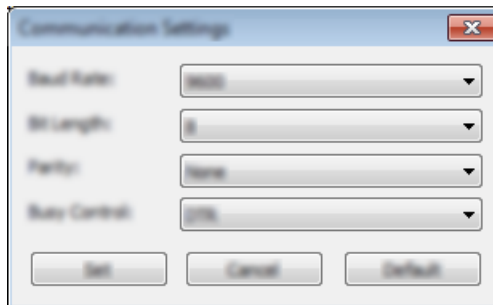

- 2 Change the settings as necessary, and then click **[Set]**.



Note

Making the proper communication settings may require trying a few different settings so the Communication Settings box does not close after clicking the **[Set]** button. After the proper settings have been made, click **[Cancel]** or the red **[x]** in the upper right corner to close the Communication Settings box.

Connecting a Barcode Scanner

We recommend you use a high quality reliable barcode scanner and you check the barcode scanner specifications before selecting a model.

■ Barcode scanner connection methods

For PT-P900W, use the RS232C serial interface.

For PT-P950NW, use the USB host interface, the RS232C serial interface, or the Bluetooth interface.



Note

- When using the RS232C serial interface, you may also need the RJ25 to DB9M serial adapter (optional: PA-SCA-001).
- When using the Bluetooth interface with the PT-P950NW, you also need the Bluetooth interface (optional: PA-BI-002).

■ Recommended barcode scanner selection criteria

- When using the USB host interface: HID-class models that can be identified as a keyboard (ex. optional: PA-BR-001)
- When using the RS232C serial interface: Programmable models with battery or external AC adapter

The communication settings for the P-touch Label Printer are listed below:

Baud rate	From [300] bps to [115200] bps
Bit Length	[7] bits, [8] bits
Parity	[None], [Odd], [Even]
Busy Control	[DTR], [XON/XOFF]

- When using the Bluetooth interface: Bluetooth Ver.2.1+EDR (Class 1) models that support SPP or OPP profiles



Note

- For P-touch Template mode, templates must first be downloaded from a computer to the P-touch Label Printer using P-touch Transfer Manager. See *How to Use P-touch Transfer Manager and P-touch Library (Windows® Only)* on page 109 for more information.
- The barcode scanner should be programmed to use the English keyboard. For beginners, the barcode scanner should be programmed to scan data with no prefix or suffix characters. For advanced users, the prefix and/or suffix characters can be used as commands to the P-touch Label Printer to make a P-touch Template mode solution easier to use.
- When scanning barcodes with encoded characters, we recommend using a RS232C serial interface barcode scanner model.
- Contact the manufacturer for more information on how to use and program that barcode scanner model.

Standard Template Printing

Download frequently used templates or images and simply scan a barcode to select which one to print.

<Sign>

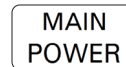

<Electrical label>



Note

- For more information on the barcodes that can be scanned using various settings, see *List of Barcodes for the P-touch Template Function* on page 184.
- Grouped objects will be converted and sent as an image.

- 1 Using P-touch Transfer Manager, transfer (from P-touch Editor) a template (label layout) to the P-touch Label Printer. (See *How to Use P-touch Transfer Manager and P-touch Library (Windows® Only)* on page 109.)

Note

A text object in the label layout can be converted to an image. After being converted to an image, the text cannot be changed. This is useful for protecting frequently used templates from being accidentally edited.

In the P-touch Editor layout window, right-click the text object, and then click **[Properties]**. Click the **[Expanded]** tab, and then select the **[Text Cannot Be Edited]** check box.

Otherwise, click **[Options]** in the **[Tools]** menu, click the **[General]** tab, and then select the **[Display Expanded Tabs of Object Properties]** check box under **[Others]**.

When the check box is cleared, the object is converted back to text that can be edited.

- 2 When you transfer data to **[Configurations]** in P-touch Transfer Manager, select the folder containing the data you want to transfer.

Note

- When a template is transferred to **[Configurations]** in P-touch Transfer Manager, the **[Key Assign]** number is automatically assigned.
- You can specify a **[Key Assign]** number between 1 and 10 for any downloaded templates into the P-touch Label Printer.
- For advanced operation, you can specify a **[Key Assign]** number between 1 and 99 for any downloaded templates into the P-touch Label Printer but you will need to scan different barcodes in step 6 to select and print it. For more information, download *P-touch Template Manual/Command Reference* (English only) from the Brother Solutions Center at support.brother.com
[Select your region/country.] - [Manuals] - [Choose your product]
- You can add custom folders under **[Configurations]**, and drag-and-drop a transferred template into that custom folder to manage different sets of templates.

- 3 Select the transferred template and then click [**Transfer**] to download the template to the [**Key Assign**] number in the P-touch Label Printer.
- 4 Scan the “P-touch template command (Initialize + begin specifying settings)” barcode. See *List of Barcodes for the P-touch Template Function* on page 184.
- 5 From the list of barcodes under "Basic settings", scan each barcode to send a command or setting to the P-touch Label Printer.



Note

- Settings can be made with multiple commands.
- If no settings have been made by scanning the barcode commands, a template will be printed using the P-touch Template settings. The default P-touch Template settings are to print a single copy with "Auto cut" turned "On".

For more information on P-touch Template Settings, download *P-touch Template Manual/Command Reference* (English only) from the Brother Solutions Center at support.brother.com [Select your region/country.] - [Manuals] - [Choose your product]

- To specify the number of copies you want, scan the “Number of copies” barcode, and then scan the barcodes under “For entering numbers” to specify a three-digit number.

Example:

Specify numbers by scanning the following barcodes: 7-[0][0][7], 15-[0][1][5]

- To change the setting for the number of copies, scan the “Number of copies” barcode again, and then scan the barcodes for the new three-digit number.

-
- 6 Scan the barcode under “Preset template number” with the same number as the [**Key Assign**] number for the label layout you want.
 - 7 The specified label is printed.

Advanced Template Printing

Download a template and scan a barcode to print a copy or insert the scanned data into a different looking label.

Note

- For more information on the barcodes that can be scanned using various settings, see *List of Barcodes for the P-touch Template Function* on page 184.
- If the barcode to be scanned with the barcode reader has a different protocol than the barcode template already registered with the printer, it may not be possible for the barcode to be created and printed.
- Depending on the manufacturer barcode scanner model, some barcode symbologies or protocols that can be scanned may not be printable because they are not supported in the P-touch Label Printer.

- 1 Using P-touch Transfer Manager, transfer (from P-touch Editor) a template (label layout) to the P-touch Label Printer. (See *How to Use P-touch Transfer Manager and P-touch Library (Windows® Only)* on page 109)



CODE128/9-digit/2.7"×0.65"

Important

It is important to design a template to meet the barcode symbology or protocol requirements, especially for the label size and barcode position in the label to fit the maximum number and type of characters being inserted from the barcode scanner. A barcode in the template cannot be created or be scannable if the barcode with the inserted data does not fit entirely within the label printable image area.

- 2 When you transfer data to **[Configurations]** in P-touch Transfer Manager, select the folder containing the data you want to transfer.

Note

- When a template is transferred to **[Configurations]** in P-touch Transfer Manager, the **[Key Assign]** number is automatically assigned.
- You can specify a **[Key Assign]** number between 1 and 10 for any downloaded templates into the P-touch Label Printer.
- You can add custom folders under **[Configurations]**, and drag-and-drop a transferred template into that custom folder to manage different sets of templates.

- 3 Select the transferred template and then click [**Transfer**] to download the template to the [**Key Assign**] number in the P-touch Label Printer.
- 4 Scan the “P-touch template command (Initialize + begin specifying settings)” barcode. See *List of Barcodes for the P-touch Template Function* on page 184.
- 5 From the list of barcodes under "Basic settings", scan each barcode to send a command or setting to the P-touch Label Printer.

 **Note**

- Settings can be made with multiple commands.
- If no settings have been made by scanning the barcode commands, a template will be printed using the P-touch Template settings. The default P-touch Template settings are to print a single copy with "Auto cut" turned "On".

For more information on P-touch Template Setting Tool, download *P-touch Template Manual/Command Reference* (English only) from the Brother Solutions Center at support.brother.com [Select your region/country.] - [Manuals] - [Choose your product]

- To specify the number of copies you want, scan the “Number of copies” barcode, and then scan the barcodes under “For entering numbers” to specify a three-digit number. The setting is automatically applied when three digits have been specified.

Example:

Specify numbers by scanning the following barcodes: 7-[0][0][7], 15-[0][1][5]

- To change the setting for the number of copies, scan the “Number of copies” barcode again, and then scan the barcodes for the new three-digit number.

- 6 Scan the "Select template" barcode and then scan the barcodes under "For entering numbers" with the same number (three digits) as the [**Key Assign**] number used for the downloaded template to be printed. The desired downloaded template will be automatically selected after the three digit numbers have been scanned.

Example:

Specify the three digit numbers by scanning the following barcodes: 7-[0][0][7], 15-[0][1][5]

 **Note**

You can use P-touch Editor to create and print a label with a single barcode for step 6.

Example:



- 7 Scan a barcode that contains the data you want inserted into the barcode object in the selected downloaded template from step 6.

Example:



(CODE128/9-digit)

- 8 Scan the "Begin printing" barcode to send the command to start printing.
 - 9 The barcode in the printed template will contain the data from the barcode scanned in step 7.
- Example:



Database Lookup Printing

Download a database linked to a template and scan a barcode as a key word to find a record containing that key word, and then insert that record into the template and print it out.

 **Note**

- The P-touch Label Printer has reserved the leftmost column (field "A") of a downloaded linked database for this operation, therefore the key word scanned from a barcode must be in this column of the database.
- The data in the leftmost column (field "A") of a downloaded linked database must match exactly to the key word scanned from a barcode, otherwise the key word search will not be successful.
- P-touch Editor and the P-touch Label Printer can only read one line of data in each field of a linked database so we do not recommend using databases with two or more lines of data in the leftmost column (field "A").
- For more information on the barcodes that can be scanned using various settings, see *List of Barcodes for the P-touch Template Function* on page 184.

- 1 Use P-touch Editor to create a template and connect to a database file. You can link as many columns to a text and barcode object in the template as needed.

 **Note**

It is not necessary to link the leftmost column (field "A") in the database file to any text or barcode object in the template if this data is not needed in the printed label, however the key words must be included in the leftmost column (field "A") of the database file regardless if this data is printed or not.

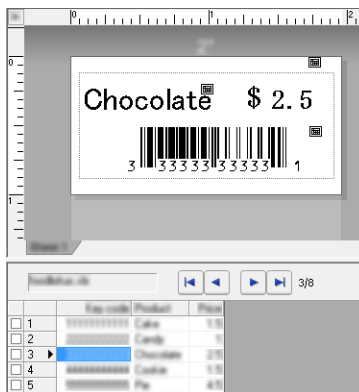

For more information on specifying the settings, refer to the **[P-touch Editor Help]**.

- 2 Using P-touch Transfer Manager, transfer (from P-touch Editor) a template (label layout) to the P-touch Label Printer.

(See *How to Use P-touch Transfer Manager and P-touch Library (Windows® Only)* on page 109.)
The linked database file will also be transferred.

- 3 When a template is transferred to **[Configurations]** in P-touch Transfer Manager, the **[Key Assign]** number is automatically assigned.

 **Note**

You can add custom folders under **[Configurations]**, and drag-and-drop a transferred template into that custom folder to manage different sets of templates.

- 4 Select the transferred template and then click **[Transfer]** to download the template to the **[Key Assign]** number in the P-touch Label Printer.
- 5 Scan the “P-touch template command” barcode.
See *List of Barcodes for the P-touch Template Function* on page 184.
- 6 From the list of barcodes under "Basic settings", scan each barcode to send a command or setting to the P-touch Label Printer.

 **Note**

- Settings can be made with multiple commands.
- If no settings have been made by scanning the barcode commands, a template will be printed using the P-touch Template settings. The default P-touch Template settings are to print a single copy with "Auto cut" turned "On".

For more information on P-touch Template Setting Tool, download *P-touch Template Manual/Command Reference* (English only) from the Brother Solutions Center at support.brother.com [Select your region/country.] - [Manuals] - [Choose your product]

- To specify the number of copies to be printed, scan the “Number of copies” barcode, and then scan the barcodes under “For entering numbers” to specify a three-digit number. The setting is automatically applied when three digits have been specified.

Example:

Specify numbers by scanning the following barcodes: 7-[0][0][7], 15-[0][1][5]

- To change the setting for the number of copies, scan the “Number of copies” barcode again, and then scan the barcodes for the new three-digit number.

- 7 Scan the "Select template" barcode and then scan the barcodes under "For entering numbers" with the same number (three digits) as the **[Key Assign]** number used for the downloaded template to be printed. The desired downloaded template will be automatically selected after the three digit numbers have been scanned.

Example:

Specify the three digit numbers by scanning the following barcodes: 7-[0][0][7], 15-[0][1][5]



Note

You can use P-touch Editor to create and print a label with a single barcode for step 6.

Example:



- 8 Scan a barcode that contains the key word to lookup in downloaded database from step 4.

Example:



- 9 Scan the "Delimiter" barcode to send the command to start searching the downloaded database for the key word that was scanned in.

- 10 Scan the "Begin printing" barcode to send the command to start printing.



Note

You can use P-touch Editor to create and print a label with a single barcode for steps 9 and 10.

Example:



- 11 The P-touch Label Printer will print the template with the data inserted from the database record found with the key word that was scanned in.

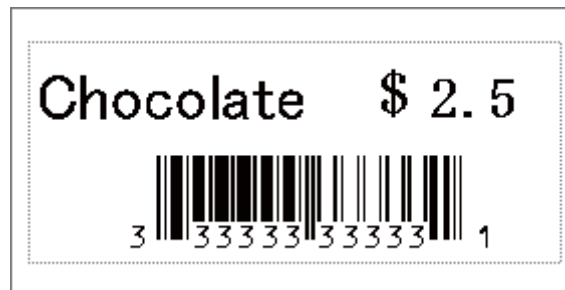

Numbering (Serialized Number) Printing

Automatically increment text or barcode in any downloaded template while printing.



Note

- This advanced operation can be applied to any of the P-touch Template mode basic operations.
- You can automatically increment up to 999 printed copies.
- You can select up to nine text and barcode objects within each downloaded template that will simultaneously be incremented while printing.
- Text and barcode objects linked to a database file can not be incremented.

Text Numbering (Serializing)

■ Procedure

- 1 Use P-touch Editor to create or open a template and select a text object that you want to automatically increment while printing.
Example:

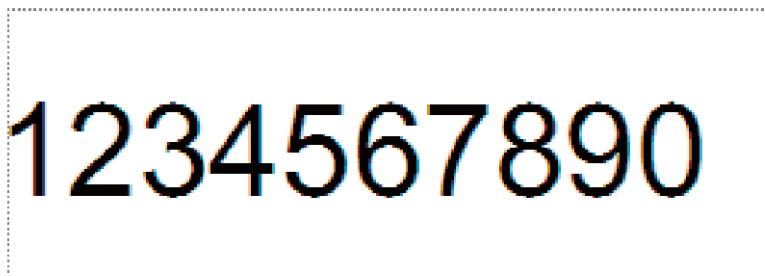

- 2 Highlight or drag the cursor over a group of numbers and letters within the text object that you want to increment (Numbering field).

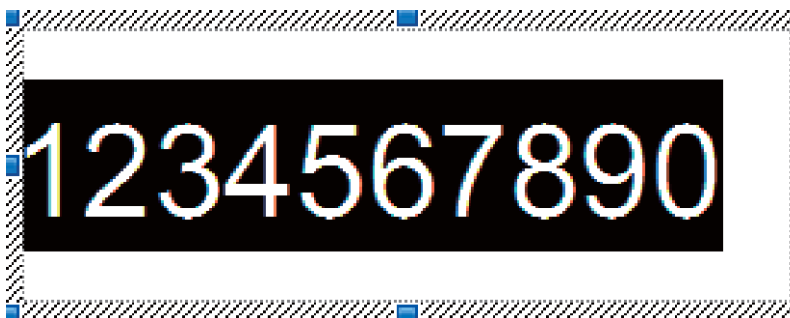

Note

A maximum of 15 numbers and letters can be selected in each Numbering field.

- 3 With the cursor over the highlighted Numbering field, right-click and select **[Numbering]**.

Barcode Numbering (Serializing)

■ Procedure

- 1 Use P-touch Editor to create or open a template and select a barcode object that you want to automatically increment while printing.
- 2 With the cursor over a selected barcode object, right-click and select [**Properties**].
Example:

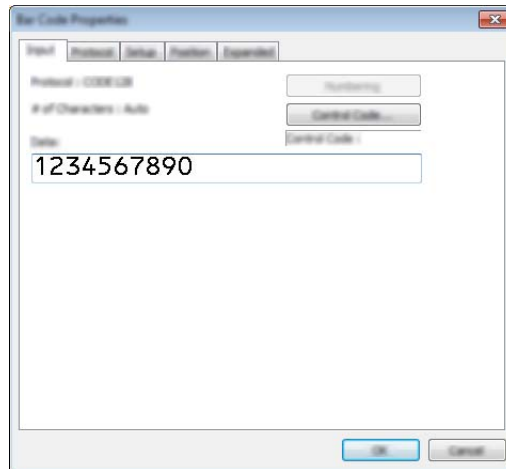

- 3 Click on the Input tab and highlight or drag the cursor over a group of numbers and letters within the barcode object that you want to increment (Numbering field).
Example:

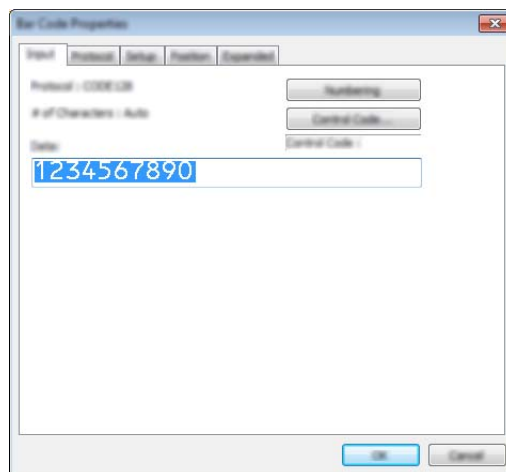

Note

The [**Numbering**] button will become un-grayed after a group of numbers and letters are highlighted.

- 4 Click **[Numbering]**, and then click **[OK]**.



Note

A maximum of 15 numbers and letters can be selected in each Numbering field.

Printing with Numbering (Serializing) Advanced Operation

- 1 Using P-touch Transfer Manager, transfer (from P-touch Editor) a template (label layout) to the P-touch Label Printer. (See *How to Use P-touch Transfer Manager and P-touch Library (Windows® Only)* on page 109.) A linked database file will also be transferred.
- 2 Numbering (Serializing) advanced operation setting the P-touch Label Printer. See *List of Barcodes for the P-touch Template Function* on page 184.
 - Scan the "Number of serialized copies" barcode and then scan the barcodes under "For entering numbers" with the number of copies to be printed (three digits).

Example:

For five copies, specify the three digit numbers by scanning barcodes for [0][0][5]



Note

- Follow P-touch Template mode basic operation procedures from *Standard Template Printing* on page 71 to *Database Lookup Printing* on page 76 to start printing.
- The Numbering field will increment by one number or letter with each label that is printed and the count is permanently saved in the P-touch Label Printer.
- To reset a text or barcode object back to the original value, scan the "Initialize template data" barcode.

Confirming the P-touch Label Printer Settings

You can print the settings report without connecting the P-touch Label Printer to a computer or mobile device.



Note

The printer report contains the following information: The firmware version, device setting information, serial number, network setting information, and Bluetooth setting information (PT-P950NW only).

- 1 Turn on the P-touch Label Printer.
- 2 Press and hold the ✂ (Feed&Cut) button for more than ten seconds to print the report.



Note

- When you print this report, use 0.94" (24 mm) or 1.4" (36 mm) tape.
- This operation can also be performed using the Printer Setting Tool (see *Changing the P-touch Label Printer Settings* on page 26).

Mass Storage Mode

Description

The mass storage mode feature allows you to communicate with the P-touch Label Printer with just a file via the USB interface without loading a printer driver.

This feature is useful for:

- Applying printer settings saved in a command file (.bin file format) or adding templates (.blf file format) into the P-touch Label Printer distributed by the administrator without using any software tools.
- Executing commands without installing the printer driver
- Using a device with an OS (including non-Windows[®] operating systems) that has a USB host feature to print and transmit data

Using the Mass Storage Mode

- 1 Confirm that the P-touch Label Printer is turned off.
- 2 Press and hold the (Wi-Fi) button and the (Power) button at the same time.
The P-touch Label Printer starts up in mass storage mode, the (Power) indicator lights in green and the (Status) indicator lights in orange.
- 3 Connect the computer or device to the P-touch Label Printer via USB.
The P-touch Label Printer's mass storage area appears as a folder on the computer or device's screen.





Note

If the mass storage area does not appear automatically, refer to the operating instructions for the computer or device's operating system for information about displaying the mass storage area.

4 Drag and drop the file you want to copy to the mass storage area.

5 Press the  (Wi-Fi) button.

The commands in the command file are executed, and the  (Status) indicator flashes once in green. When finished, the  (Status) indicator lights in orange.

6 To turn mass storage mode off, turn off the P-touch Label Printer.

Important

- When the P-touch Label Printer is turned off, mass storage mode is deactivated and any files in the mass storage area are deleted.
- This feature supports .bin, and .blf files. Other file formats are not supported.
- Do not create folders in the mass storage area. If a folder is created, files in the folder cannot be accessed.
- The capacity of the mass storage area is 2.5 MB. Files larger than 2 MB may not work correctly.
- If multiple files are copied, the order that the commands will be executed in cannot be guaranteed.
- Wi-Fi and Bluetooth features are not available while the P-touch Label Printer is running in mass storage mode.
- Do not access other files in the mass storage area when executing a copied file.



Note

For more information on how to create a .blf file, see *Creating a BLF File or a PDZ File* on page 119.

Distributed Printing (Windows® Only)

When printing a large number of labels, printing can be distributed among multiple printers. Because printing is performed at the same time, the total printing time can be reduced.



Note

- Printing can be distributed to printers connected via a USB or network connection.
- The number of pages is automatically divided among the selected printers. If the specified number of pages cannot be evenly divided among the printers, it will be divided in the order of the printers listed in the dialog box when the print settings are specified in step 4.

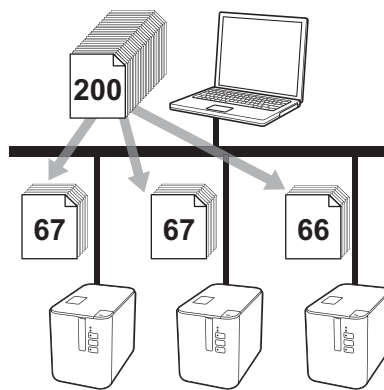

- 1 From the **[File]** menu in P-touch Editor, click **[Print]**.
- 2 Click **[Properties...]**.

- Click the **[Advanced]** tab, select the **[Distributed Printing]** check box, and then click **[Settings]**.

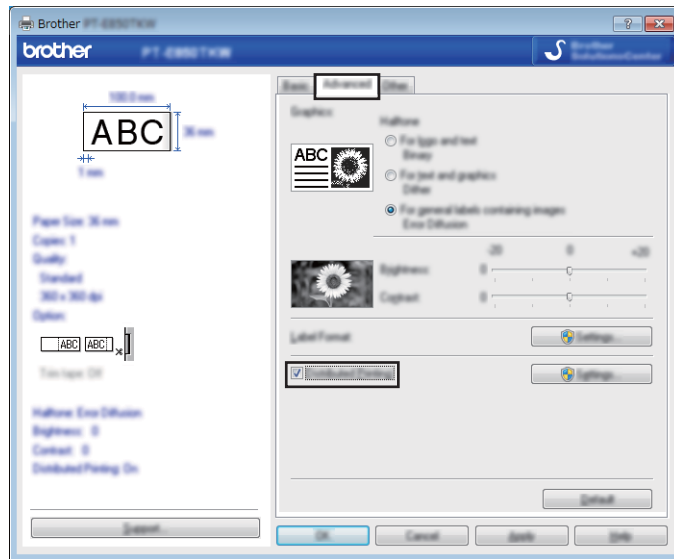

7

- In the **[Distributed Printing Settings]** dialog box, select the printers you want to use for distributed printing.

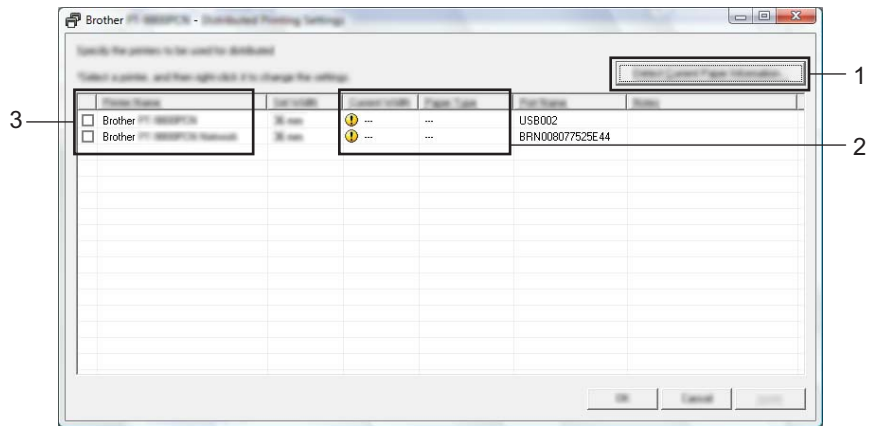

- Click **[Detect Current Paper Information...]**.
- The current printer information that was detected appears below **[Current Width]** and **[Paper Type]**.
- Select the check box next to the **[Printer Name]** you want.

Note

If the selected tape width is different from that displayed beside **[Current Width]**,  appears beside the setting below **[Current Width]**. Load the printer with tape of the width specified **[Set Width]**.

5 Specify the tape width.

A. If only one printer has been selected.

In the [**Distributed Printing Settings**] dialog box from step 4, select the printer whose setting you want to specify, and then either double-click it, or right-click it and then click [**Settings**]. From the [**Set Width**] drop-down list, select the tape width.



Note

Information displayed in the [**Distributed Printing Settings**] dialog box from step 4 can be entered in the [**Notes**] text box.

B. If multiple printers have been selected.

In the [**Distributed Printing Settings**] dialog box from step 4, select the printers whose settings you want to specify, right-click them, and then click [**Settings**]. From the [**Set Width**] drop-down list, select the tape width. The same tape width setting is applied to all selected printers.

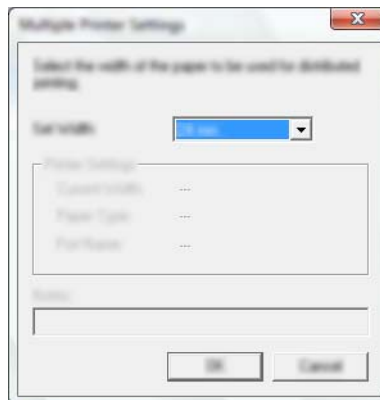

Note

The settings below [**Printer Settings**] and [**Notes**] are not available.

6 Click [**OK**] to close the tape width setting window.

7 Click **[OK]** to close the **[Distributed Printing Settings]** window. Setup is completed.

8 Click **[OK]** to start distributed printing.



Note

-
- It may not be possible for information to be detected for a printer connected using a USB hub or print server. Before printing, enter the settings manually, and check if the printer can be used for printing.
 - Depending on whether a router is used and the security features in use, such as a firewall, it may not be possible to use this function.
 - We recommend performing a connection test for your operating environment. Contact your information technology manager or administrator for assistance.
-

Printing Labels in High Resolution Mode

High resolution printing can be used if the AC adapter is connected, and TZe and HGe laminated tape with black ink is installed. Use the printer driver to select the high resolution mode when printing the labels. You cannot use this function for TZe-FX**1 tape.

- 1 From the **[File]** menu in P-touch Editor, click **[Print]**.
- 2 Click **[Properties...]**.
- 3 On the **[Basic]** tab, select **[High resolution]** from the **[Quality]** drop-down list.

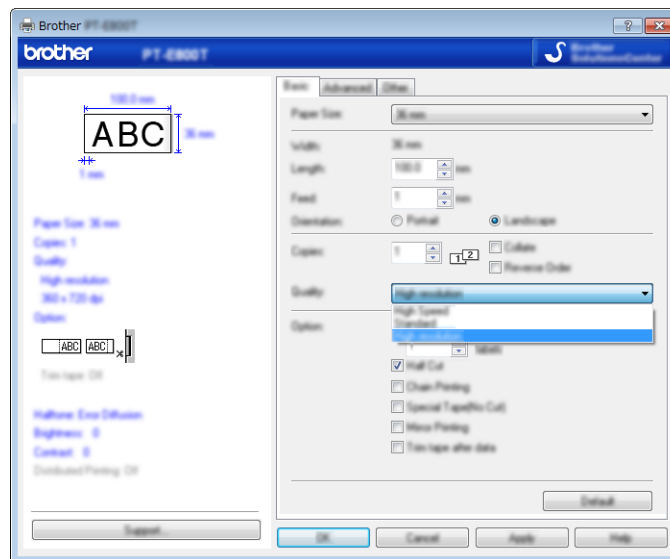

- 4 Click **[OK]**.

Printing Labels in High Speed Mode

High speed printing can be used if the AC adapter is connected, and TZe and HGe laminated tape with black ink is installed. Use the printer driver to select the high speed mode when printing the labels. You cannot use this function for TZe-FX**1 tape.

- 1 From the **[File]** menu in P-touch Editor, click **[Print]**.
- 2 Click **[Properties...]**.
- 3 On the **[Basic]** tab, select **[High Speed]** from the **[Quality]** drop-down list.

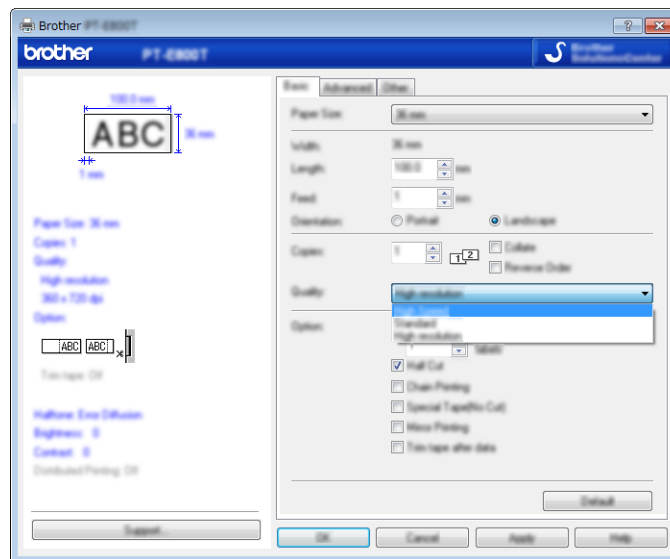

- 4 Click **[OK]**.



Application

How to Use Cable Label Tool (Windows® Only)	91
How to Use P-touch Editor	101
How to Use P-touch Transfer Manager and P-touch Library (Windows® Only)	109
Transferring Templates with P-touch Transfer Express (Windows® Only)	126
How to Update P-touch Software	134

Starting Cable Label Tool

1 Start the Cable Label Tool.

■ **For Windows Vista® / Windows® 7 / Windows Server® 2008 / Windows Server® 2008 R2:**

From the Start button, click [All Programs] - [Brother P-touch] - [Cable Label Tool 1.0], or double-click [Cable Label Tool 1.0] shortcut icon on the desktop.

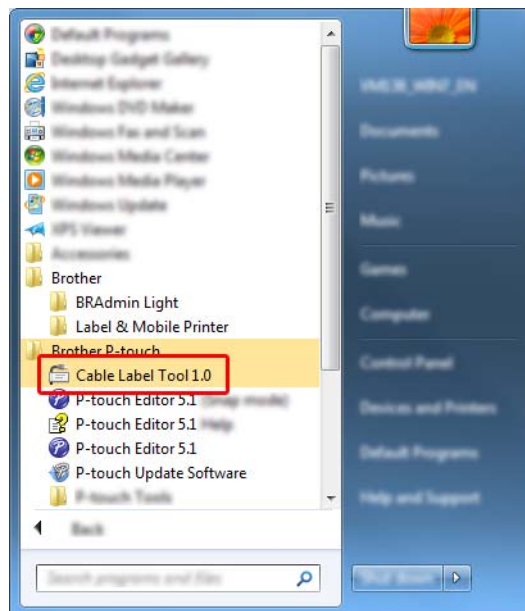

■ **For Windows® 8 / Windows® 8.1 / Windows Server® 2012 / Windows Server® 2012 R2:**

Click [Cable Label Tool 1.0] on the [Apps] screen or double-click [Cable Label Tool 1.0] on the desktop.

■ **For Windows® 10:**

From the Start button, select [All apps] and click [Cable Label Tool 1.0] under [Brother P-touch], or double-click [Cable Label Tool 1.0] on the desktop.

- 2 Click the button for the cable label type you want.

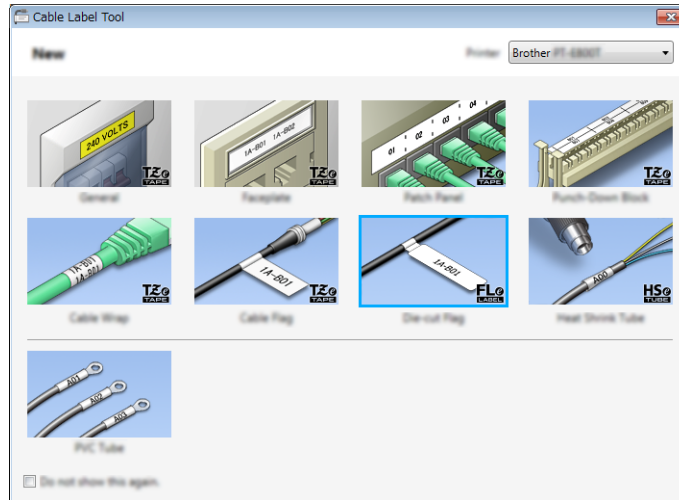

Creating a Cable Label

Faceplate

Labels of this type can be used to identify various faceplates.

Blocks of text are evenly spaced on each label.

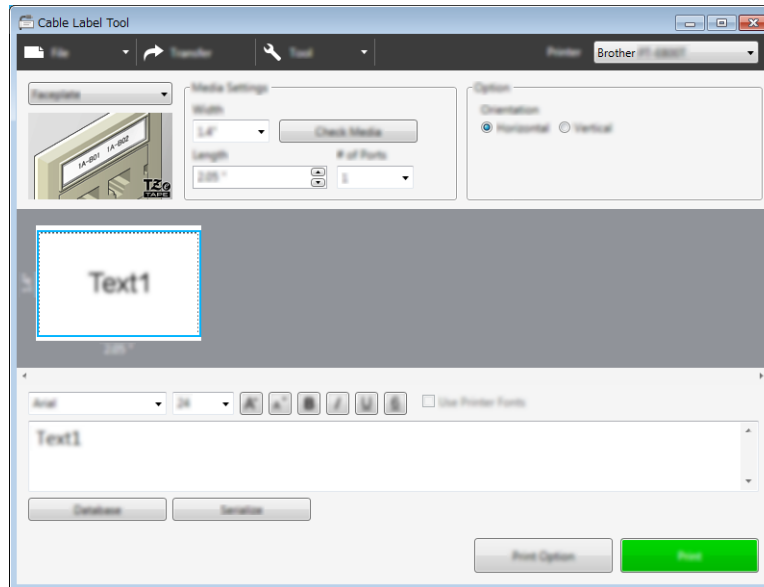

Cable Wrap

Labels of this type can be wrapped around a cable or wire.

The text is rotated 90° counterclockwise and printed.

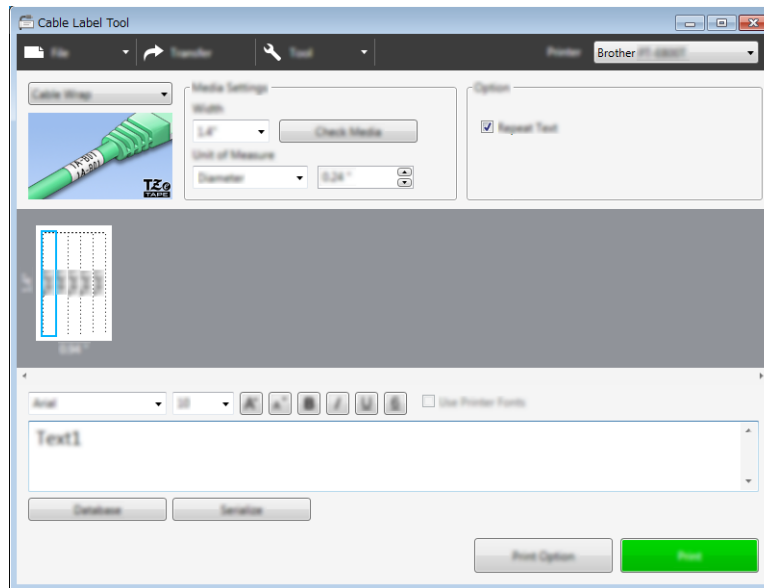

Note

When using Flexible ID Tape:

- We recommend using Flexible ID Tape for the "Cable Wrap" labels.
- Labels made with Flexible ID Tape are not designed for use as electrical insulation.
- When wrapping labels around cylindrical objects, the diameter (1) of the object should be at least 0.12" (3 mm).
- The overlapping (2) ends of the label should be at least 0.2" (5 mm).

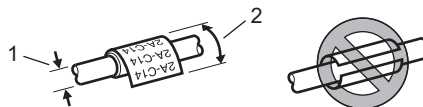

Cable Flag

Labels of this type can be wrapped around a cable or wire, and both ends of the label stick together to form a flag.

The text on flag labels is printed on both ends of the label, leaving a blank space in the middle that wraps around the cable.

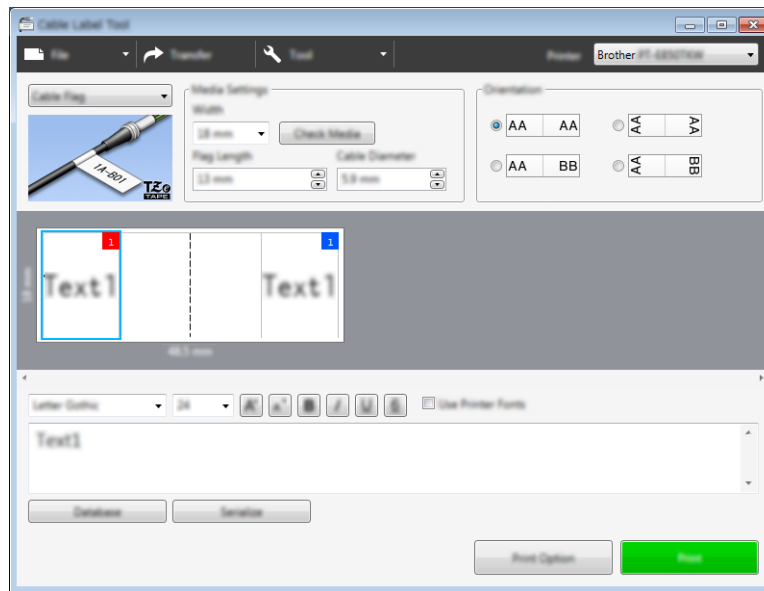

Note

- The flag length (1) should be at least 0.2" (5 mm).

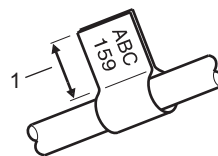

- Orientation



- 1 Flag length
- 2 Cable circumference

- We recommend using Flexible ID Tape for the "Cable Flag" labels.
- Labels made with Flexible ID Tape are not designed for use as electrical insulation.

Patch Panel

Labels of this type can be used to identify various types of panels.

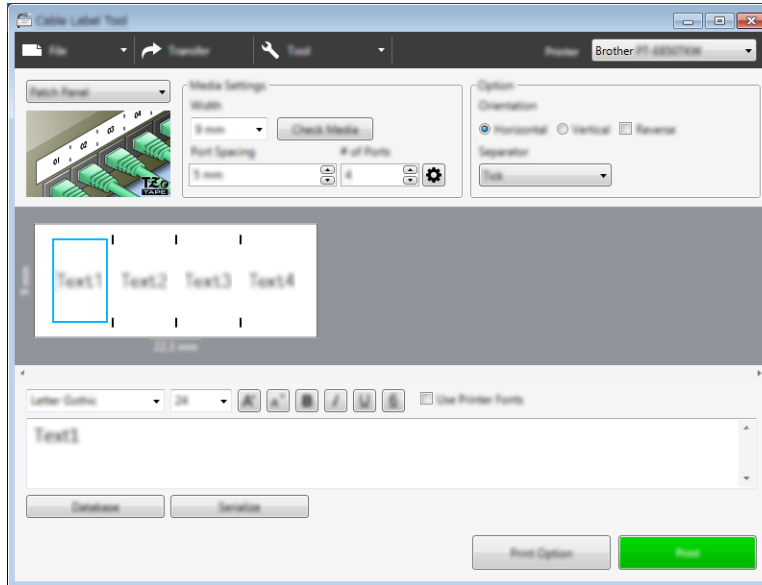

Punch-Down Block

Labels of this type can be used to identify a type of electrical connection, often used in telecommunications. You can enter up to eight lines for each block on a single label.

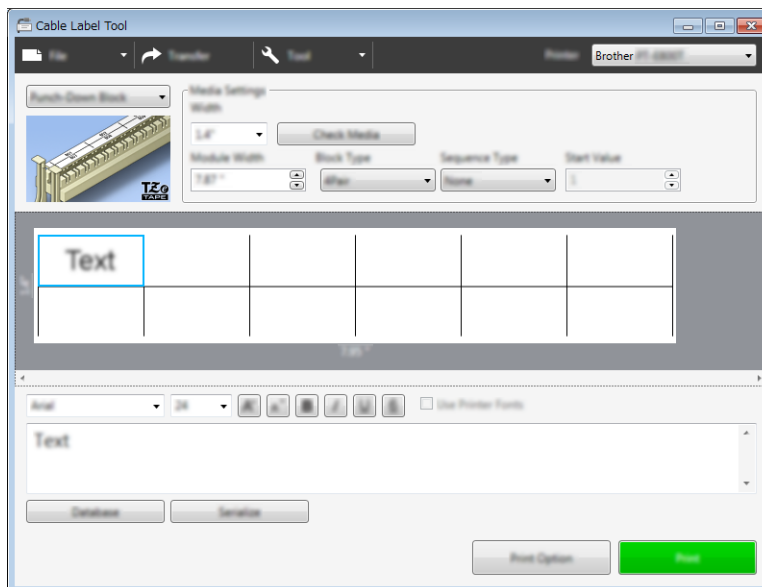

Die-cut Flag

Labels of this type can be printed on special die-cut flag labels to create flag labels for cables and wires. Use FLe tape cassettes for this type of application.

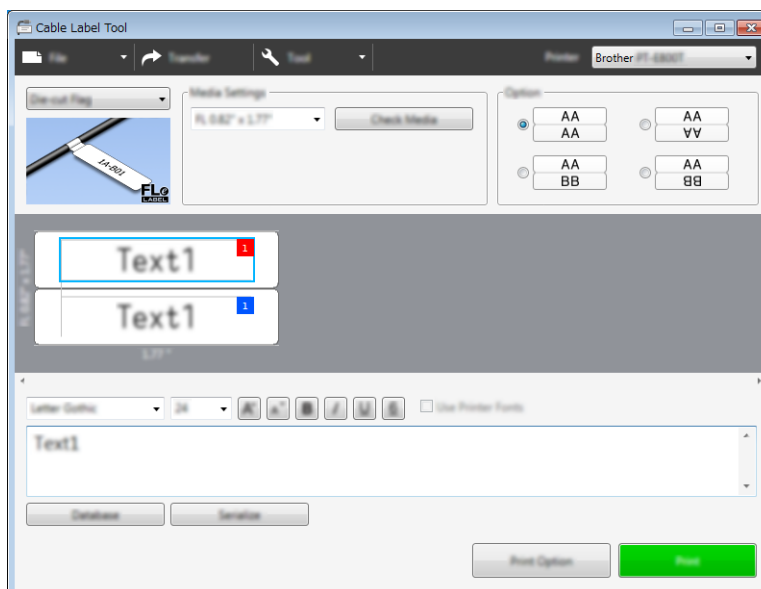

Heat Shrink Tube

Tubes of this type can be heated to shrink them to fit cables. Use HSe tube cassettes for this type of application.

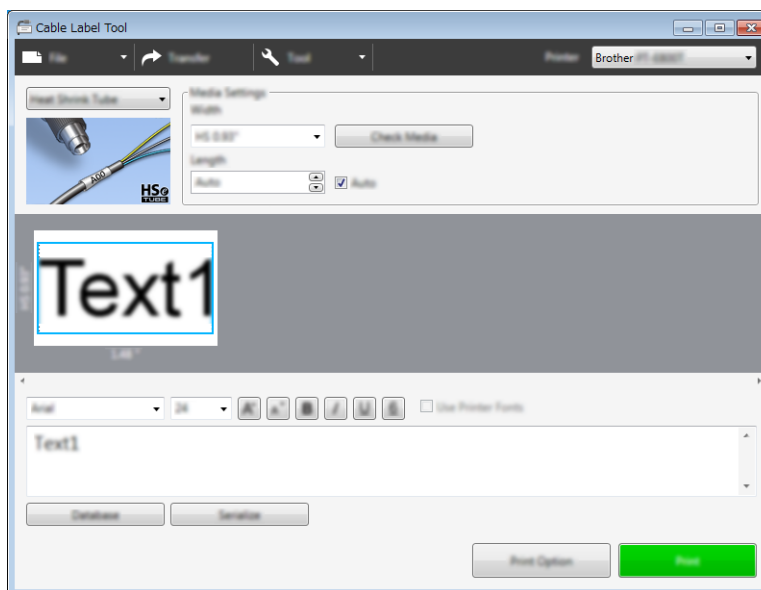

Linking a Database

You can link databases to templates.

- 1 Click [**Database**].
- 2 Select a database.
- 3 The database linked to the template appears.
Specify the data to print and the number of copies.

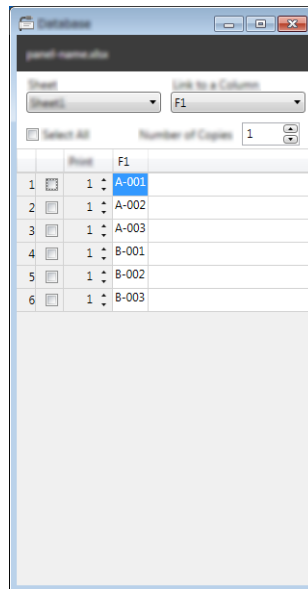

Numbering Function (Serialized Number) Printing

You can create numerically serialized labels.

- 1 Highlight the text you want to serialize.

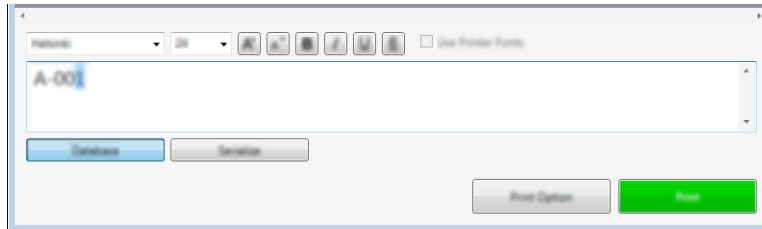

- 2 Click [Serialize].

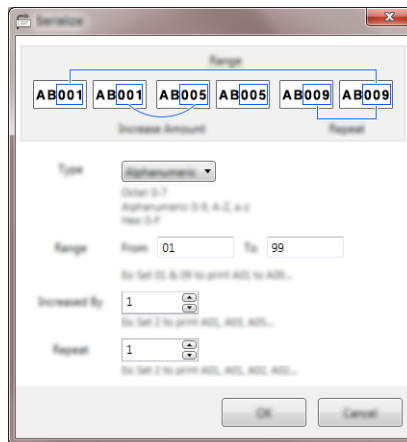

- 3 Specify the settings using the screen image as an example.

Printing with Cable Label Tool

You can print by selecting [Print] from the [File] menu or by clicking the [Print] button. (Configure the printing settings in the [Print] screen before printing.)

Transferring Templates from Cable Label Tool to the P-touch Label Printer

Using the transfer function, you can transfer a template or a template with a database to the P-touch Label Printer without using P-touch Transfer Manager.

- 1 Display the template to transfer in the layout window.
- 2 Click [**Transfer**].
The [**Transfer Template**] dialog box appears.

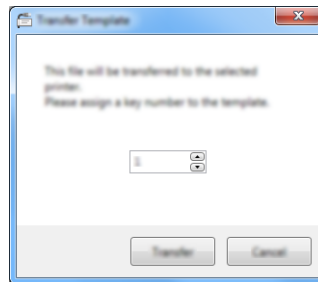

- 3 Select the assignment key.



Note

If the template or other data transferred to the printer has the same key number as another template already saved in the printer, the new template will overwrite the old one.

- 4 To transfer a template with a connected database, select the [**Transfer with Database**] check box.
- 5 Click [**Transfer**].
The template or template with database is transferred to the printer.



Note

- [**Serialize**] settings will not be transferred.
- When transferring a template with a database, if the connected database has multiple sheets, only the sheet currently displayed in the database dialog box is transferred.

To use your P-touch Label Printer with your computer, install P-touch Editor and the printer driver.

To download the latest driver and software, visit the Brother Solutions Center at support.brother.com

[Select your region/country.] - [Downloads] - [Choose your product]

For Windows®

Starting P-touch Editor

1 Start the P-touch Editor.

■ **For Windows Vista® / Windows® 7 / Windows Server® 2008 / Windows Server® 2008 R2:**

From the Start button, click **[All Programs]-[Brother P-touch]-[P-touch Editor 5.1]**, or double-click **[P-touch Editor 5.1]** shortcut icon on the desktop.

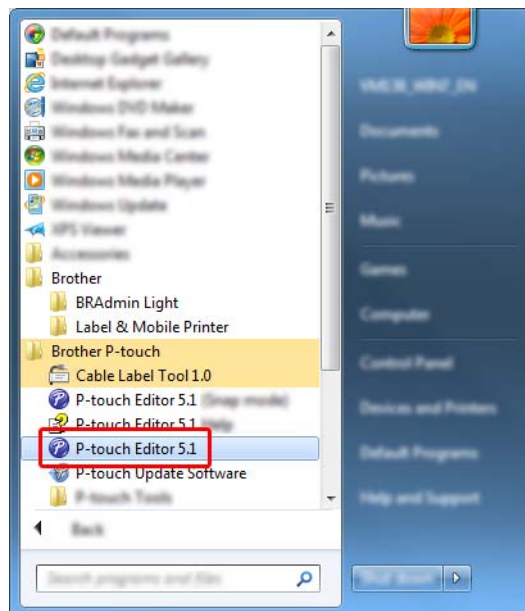

■ **For Windows® 8 / Windows® 8.1 / Windows Server® 2012 / Windows Server® 2012 R2:**

Click **[P-touch Editor 5.1]** on the **[Apps]** screen or double-click **[P-touch Editor 5.1]** on the desktop.

■ **For Windows® 10:**

From the Start button, select **[All apps]** and click **[P-touch Editor 5.1]** under **[Brother P-touch]**, or double-click **[P-touch Editor 5.1]** on the desktop.

- When P-touch Editor starts, select whether you want to create a new layout or open an existing layout.



Note

To change how P-touch Editor functions when it starts, click **[Tools]-[Options]** in the P-touch Editor menu bar to display the **[Options]** dialog box. On the left side, select the **[General]** heading, and then the setting you want in the **[Operations]** list box under **[Startup Settings]**. The factory setting is **[Display New View]**.

- Select one of the displayed options:

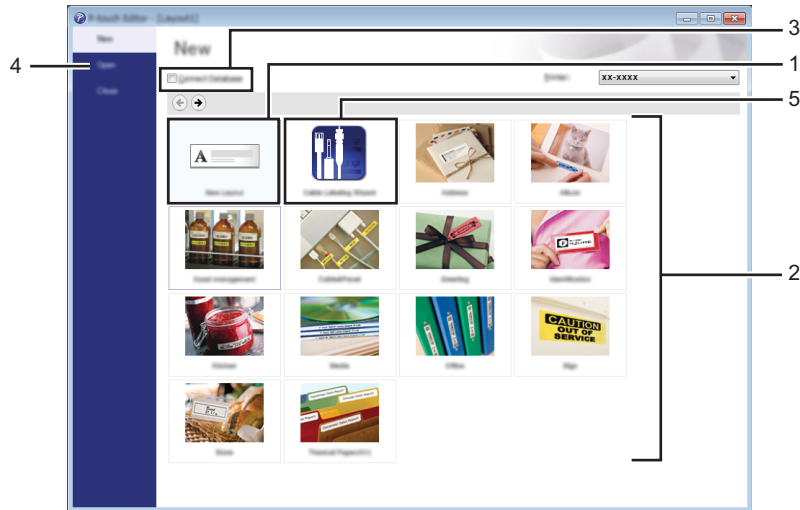

- To create a new layout, double-click **[New Layout]**, or click **[New Layout]** and then click **[→]**.
- To create a new layout using a preset layout, double-click a category button, or select a category button and then click **[→]**.
- To connect a preset layout to a database, select the check box next to **[Connect Database]**.
- To open an existing layout, click **[Open]**.

- 5 To open the application for creating labels for electrical equipment management, double-click [**Cable Labelling Wizard**], or click [**Cable Labelling Wizard**] and then click [→] .

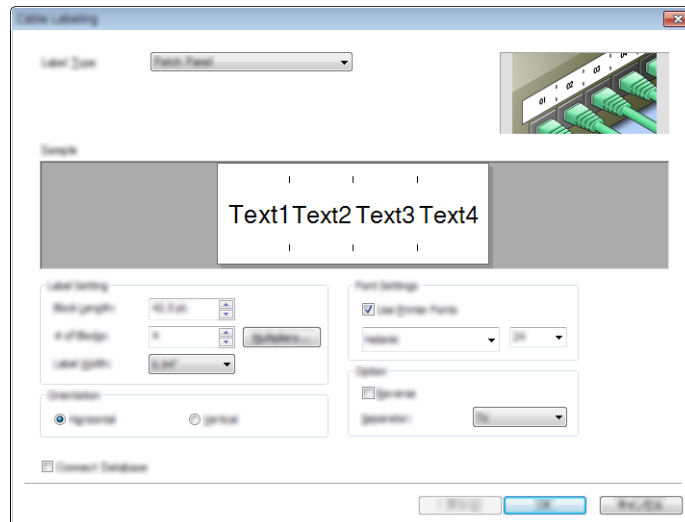

Printing with P-touch Editor

■ Express mode

This mode allows you to quickly create layouts that include text and images.

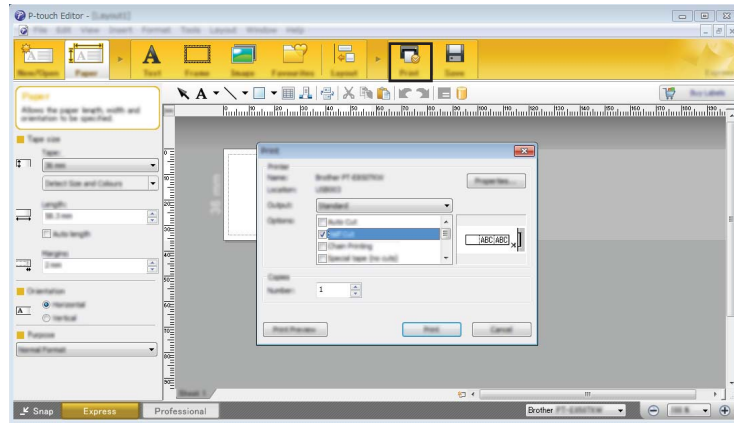

You can print by selecting **[Print]** from **[File]** in the menu bar or by clicking the **[Print]** icon. (Configure the printing settings in the **[Print]** screen before printing.)

■ Professional mode

This mode allows you to create layouts using a wide-range of advanced tools and options.

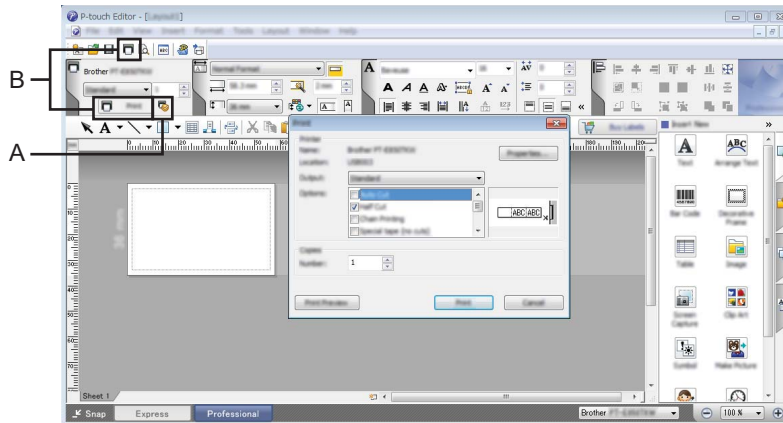

You can print by selecting **[Print]** from **[File]** in the menu bar or by clicking the Print Setting icon (A). Configure the printing settings in the **[Print]** screen before printing.

In addition, you can click the **[Print]** icon “B” to start printing without changing the printing settings.

■ Snap mode

This mode allows you to capture all or a portion of your computer screen display, print it as an image, and save it for future use.

- 1 Click the **[Snap]** mode selection button.
The **[Description of Snap mode]** dialog box appears.

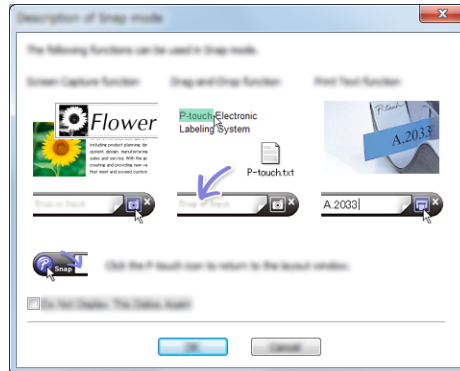

- 2 Click **[OK]**.
The **[Snap]** mode palette appears.



Transferring Data to the P-touch Label Printer

To transfer data to the P-touch Label Printer, you must use P-touch Transfer Manager. For more information, see *P-touch Transfer Manager* on page 109.

For Mac

Starting P-touch Editor

- 1 Double-click [**P-touch Editor**] icon on the desktop.



Note

- The following method can also be used to start the P-touch Editor:
Double-click [**Macintosh HD**] - [**Applications**] - [**P-touch Editor 5.1**], and then double-click the [**P-touch Editor**] application icon.
 - When using a Mac computer, you cannot transfer label data created using P-touch Editor to the printer.
-

P-touch Editor starts.

Operation modes

■ Standard Mode

This mode allows you to create labels with text and images.

The layout window consists of the following sections:

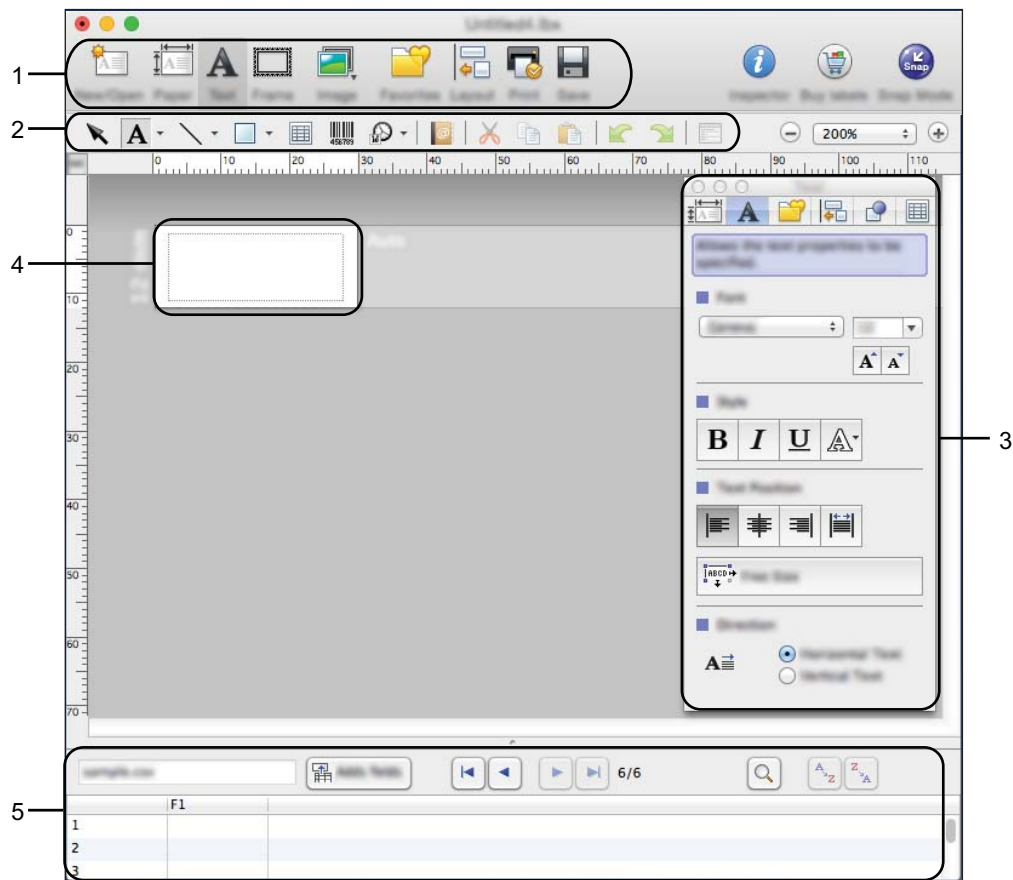

- 1 Command bar
- 2 Draw/Edit toolbar
- 3 Inspector
- 4 Layout window
- 5 Database window

■ Snap mode

With this mode, you can capture the screen, print it as an image, and save it for future use.

To start the Snap mode, follow steps below.

- 1 Click the **[Snap]** mode selection button.
The **[Description of Snap mode]** dialog box appears.

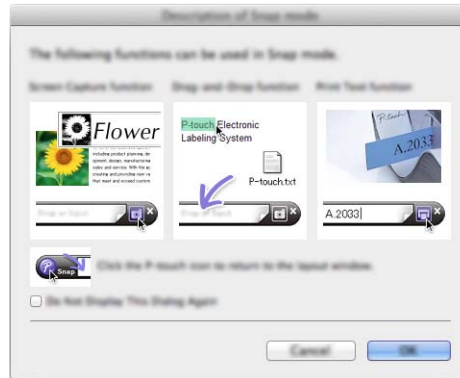

- 2 Click **[OK]**.
The **[Snap]** mode palette appears.



Transferring Data to the P-touch Label Printer

To transfer data to the P-touch Label Printer, you must use a Windows® computer. For more information, see *P-touch Transfer Manager* on page 109.

P-touch Transfer Manager

This program allows you to transfer templates and other data to the P-touch Label Printer and save backups of your data on the computer.

First P-touch Transfer Manager transfers data to the P-touch Label Printer, and then P-touch Template sends text data that will be inserted into the template and printed. For more information on P-touch Template, download the *P-touch Template Manual/Command Reference* (English only) from the Brother Solutions Center at support.brother.com

[Select your region/country.] - [Manuals] - [Choose your product]

The transfer function is needed to use P-touch Template.

The template can also be transferred via the network.

Transferring the Template to P-touch Transfer Manager

To use P-touch Transfer Manager, you must first transfer templates created in P-touch Editor to P-touch Transfer Manager.

- 1 In P-touch Editor, open the template to be transferred.
- 2 Click [File] - [Transfer Template] - [Transfer].

When P-touch Transfer Manager starts, the main window appears.



Note

The following method can also be used to start the P-touch Transfer Manager:

- **For Windows Vista[®] / Windows[®] 7 / Windows Server[®] 2008 / Windows Server[®] 2008 R2:**
From the Start button, click [All Programs]-[Brother P-touch]-[P-touch Tools]-[P-touch Transfer Manager 2.2].
- **For Windows[®] 8 / Windows[®] 8.1 / Windows Server[®] 2012 / Windows Server[®] 2012 R2:**
Click [P-touch Transfer Manager 2.2] on the [Apps] screen.
- **For Windows[®] 10:**
From the Start button, select [All apps], and then click [P-touch Transfer Manager 2.2] under [Brother P-touch].

Main window

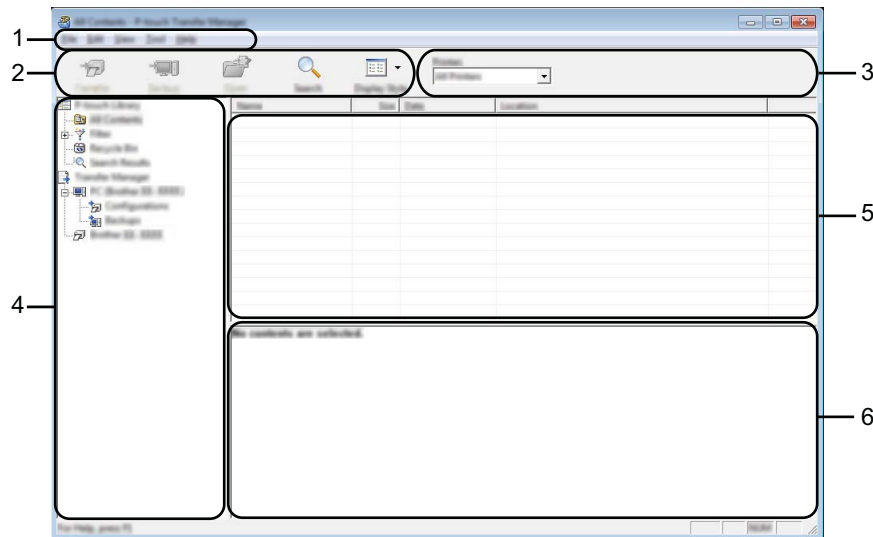

1 Menu bar

Provides access to various commands, which are grouped under each menu title ([File], [Edit], [View], [Tool], and [Help]) according to their functions.

2 Toolbar

Provides access to frequently used commands.

3 Printer selector

Allows you to select which P-touch Label Printer the data will be transferred to. When you select a P-touch Label Printer, only the data that can be sent to the selected P-touch Label Printer appears in the data list.

4 Folder view

Displays a list of folders and printers. When you select a folder, the templates in the selected folder appear in the template list.

If you select a P-touch Label Printer, the current templates and other data stored in the P-touch Label Printer appear.







5 Template list

Displays a list of templates in the selected folder.

6 Preview

Displays a preview of the templates in the templates list.

Explanations of the Toolbar Icons

Icon	Button name	Function
	Transfer (Only for P-touch Transfer Manager)	Transfers templates and other data from the computer to the P-touch Label Printer.
	Save Transfer File (When not connected to a P-touch Label Printer)	Changes the file type of the data to be transferred to other applications. Select "BLF" for the filename extension when printing the label using Mass Storage Mode (USB), or when transferring the data using BRAdmin Professional (LAN or Wi-Fi) or Mobile Transfer Express (Wi-Fi). Select "PDZ" when transferring the data using TransferExpress (USB). The available interfaces differ depending on your model.
	Backup (Only for P-touch Transfer Manager)	Retrieves the templates and other data saved in the P-touch Label Printer and saves it on the computer.
	Open	Opens the selected template.
	Print (Only for P-touch Library)	Prints the selected template with the P-touch Label Printer.
	Search	Allows you to search for templates or other data registered to P-touch Library.
	Display Style	Changes the file display style.

Transferring Templates or Other Data from the Computer to the P-touch Label Printer

Use the following procedure to transfer templates, databases and images from the computer to the P-touch Label Printer.

- 1 Connect the computer and the P-touch Label Printer via USB and turn on the P-touch Label Printer. The P-touch Label Printer model name appears next to a printer icon in the folder view. If you select the P-touch Label Printer in the folder view, the current templates and other data stored in the printer appear.

Note

- If a P-touch Label Printer is disconnected or offline, it is not listed in the folder view.
- Before transferring data, check that the computer and the P-touch Label Printer are correctly connected using a USB cable or a wireless connection, and that the P-touch Label Printer is on.

- 2 Select the P-touch Label Printer that you want to transfer the template or other data to.

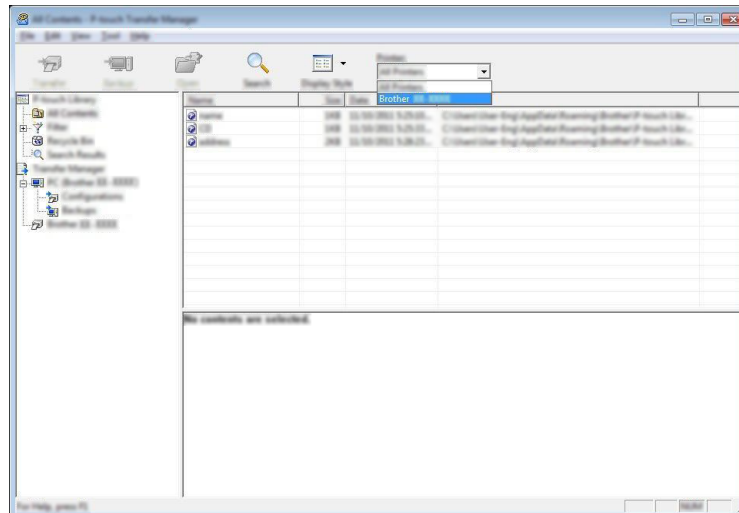

Note

Before transferring data, check that the computer and the P-touch Label Printer are correctly connected with a USB cable or a wireless connection and that the P-touch Label Printer is on.

- Right-click the **[Configurations]** folder, select **[New]**, and then create a new folder.

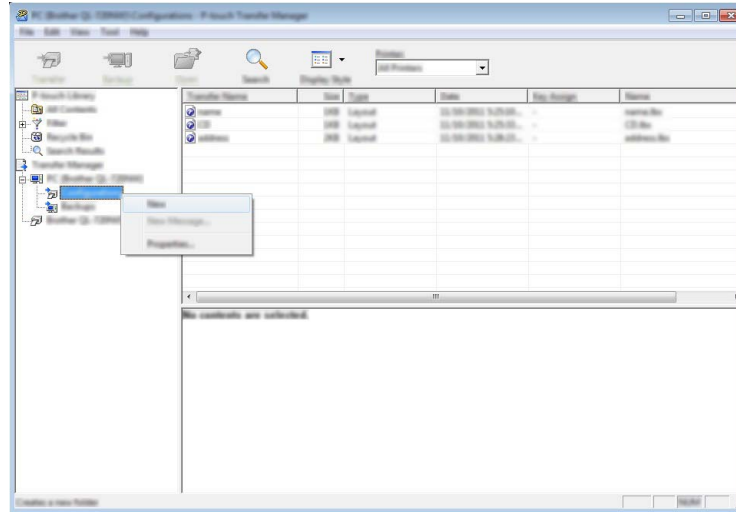

In the example above, the **[Transfer]** folder is created.

- Drag the template or other data that you want to transfer and place it in the new folder.

Transfer Function Specification

Data type	Maximum number of transferable items	Restriction details
Template	99	<ul style="list-style-type: none"> ■ Each template can contain a maximum of 50 objects. ■ Each object can contain a maximum of 17 lines.
Database	99	<ul style="list-style-type: none"> ■ Only *.csv files can be transferred. ■ Each *.csv file can contain a maximum of 256 fields and 65000 records.
Image (transferred symbols)	99	<ul style="list-style-type: none"> ■ Only *.bmp files can be transferred. ■ Monochrome *.bmp files are recommended. ■ The size limit is 2048 × 2048 pixels. ■ Wide images may be cropped.



Note

You can confirm the available space in the transfer file memory by printing the printer settings report (see *Confirming the P-touch Label Printer Settings* on page 82).

See **[ROM FREE]** in the report for the available space ¹.

¹ The available space that appears in "ROM FREE: ***** byte" may be different from the actual available space.

You can view the templates and other data by selecting:

- The folder in the **[Configurations]** folder
- **[All Contents]**
- One of the categories under **[Filter]**, such as **[Layouts]**.

When transferring multiple templates or other data, drag all files you want to transfer and place them in the new folder.

Each file is assigned a key number (memory location in the P-touch Label Printer) when it is placed in the new folder.

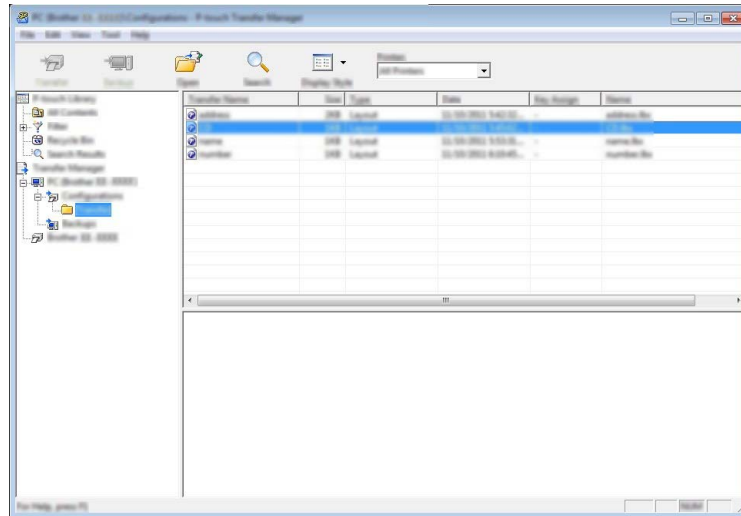

- 5 To change the key number assigned to an item, right-click the item, select **[Key Assign]**, and then select the key number you want.

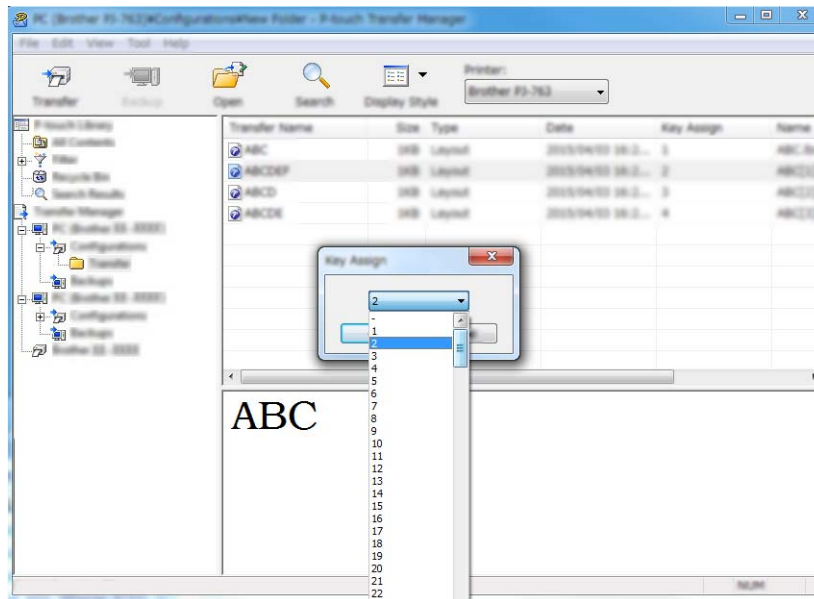

 **Note**

- Except for the data in databases, all data transferred to the P-touch Label Printer is assigned a key number.
- If the template or other data transferred to the P-touch Label Printer has the same key number as another template already saved in the P-touch Label Printer, the new template will overwrite the old one. You can confirm the templates key number assignments saved in the P-touch Label Printer by backing up the templates or other data (see *Backing up Templates or Other Data Saved in the P-touch Label Printer* on page 117).
- If the P-touch Label Printer memory is full, remove one or more templates from the P-touch Label Printer's memory (see *Backing up Templates or Other Data Saved in the P-touch Label Printer* on page 117).

- 6 To change the names of templates or other data that you want to transfer, click the item you want, and then type the new name. The number of characters used for the template names may be limited depending on the P-touch Label Printer model.

 **Note**

The LCD of the touch panel display (PT-P950NW only) displays the first 10 characters of the template file name.

- 7 Select the folder containing the templates or other data that you want to transfer, and then click **[Transfer]**. A confirmation message appears.

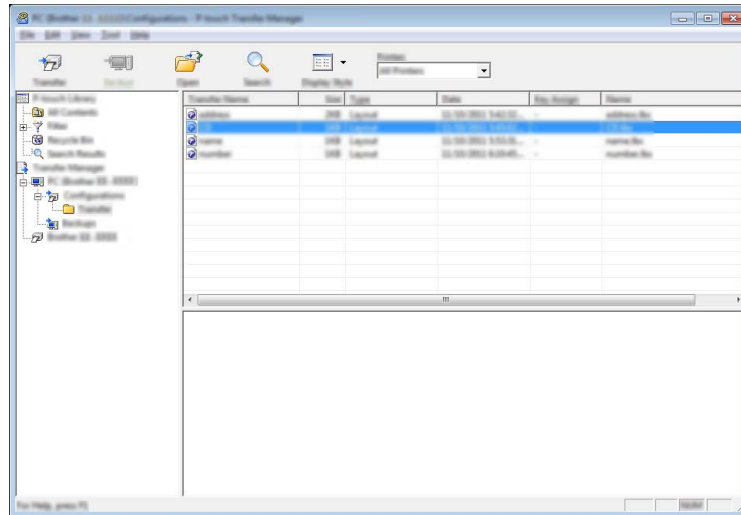

Note

- You can also transfer individual items to the P-touch Label Printer without adding them to a folder. Select the template or other data that you want to transfer, and then click **[Transfer]**.
- Multiple items and folders can be selected and transferred in one operation.

- 8 Click **[OK]**.

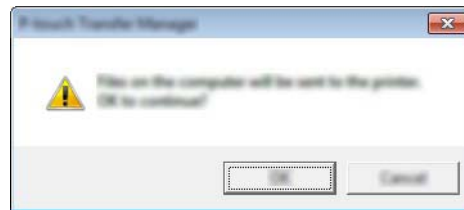

The selected data are transferred to the P-touch Label Printer.

Backing up Templates or Other Data Saved in the P-touch Label Printer

Use the following procedure to retrieve templates or other data saved in the P-touch Label Printer and save it on the computer.

❗ Important

- Backed up templates or other data cannot be edited on the computer.
- Depending on the P-touch Label Printer model, templates or other data backed up from one P-touch Label Printer model may not be able to be transferred to another P-touch Label Printer model.

- 1 Connect the computer and the P-touch Label Printer and turn on the P-touch Label Printer. The P-touch Label Printer model name appears next to a printer icon in the folder view. If you select the P-touch Label Printer in the folder view, the current templates and other data stored in the P-touch Label Printer appear.
- 2 Select the P-touch Label Printer to back up from, and then click **[Backup]**. A confirmation message appears.

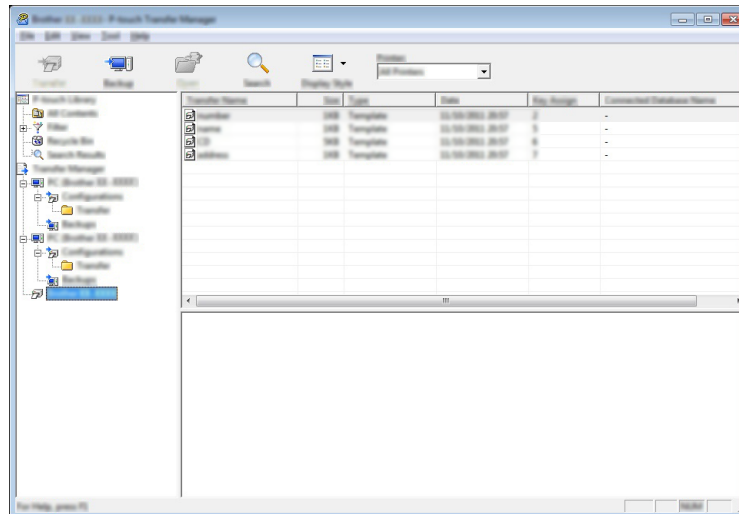

- 3 Click **[OK]**.

A new folder is created under the P-touch Label Printer in the folder view. The folder name is based on the date and time of the backup. All of the P-touch Label Printer's templates and other data are transferred to the new folder and saved on the computer.

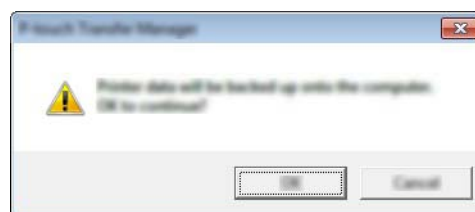

Deleting All the P-touch Label Printer Data

Use the following procedure to delete all templates or other data saved on the P-touch Label Printer.

- 1 Connect the computer and the P-touch Label Printer and turn on the P-touch Label Printer. The P-touch Label Printer model name appears next to a printer icon in the folder view.
- 2 Right-click the P-touch Label Printer, and then select [**Delete All**].

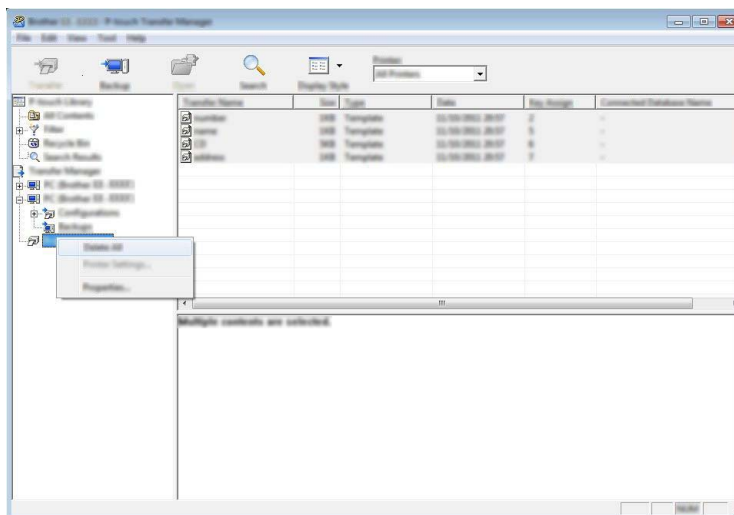

A confirmation message appears.

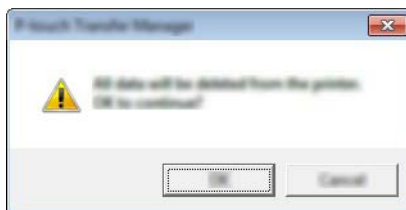

- 3 Click [**OK**]. All templates and other data saved in the P-touch Label Printer is deleted.

Creating a BLF File or a PDZ File

You can use P-touch Transfer Manager to save template data, which was created using P-touch Editor, in the BLF or PDZ format. You can transfer these files in this format to a printer over a network, from a computer or mobile device. You can also print files in BLF format from mass storage mode.

- 1 Create the template using P-touch Editor, and then transfer it to P-touch Transfer Manager. For more information, see *Transferring the Template to P-touch Transfer Manager* on page 109.
- 2 Without connecting the P-touch Label Printer to the computer, select **[Configurations]** in the P-touch Transfer Manager window, and then select the template to save.



Note

You can select multiple templates at the same time.

- 3 Click **[File]** - **[Save Transfer File]**.



Important

The **[Save Transfer File]** button appears only if the P-touch Label Printer is disconnected from the computer or offline.



Note

- If you click **[Save Transfer File]** after selecting **[Configurations]**, all templates in the folder are saved as the Transfer file (.blf) or Transfer Package file (.pdz).
 - You can combine multiple templates into a single Transfer file (.blf) or Transfer Package file (.pdz).
- 4 In **[Save as type]**, select the format in which to save the template, and then type in the name and save the template.
Select the BLF format when printing using the mass storage mode or connecting your mobile device to the P-touch Label Printer using Wireless Direct or Wi-Fi, and select the PDZ format when connecting using Bluetooth.
The templates are saved as a Transfer file (.blf) or Transfer Package file (.pdz).

P-touch Library

This program allows you to use your computer to manage P-touch Template. You can use P-touch Library to print templates.

Starting P-touch Library

- **For Windows Vista® / Windows® 7 / Windows Server® 2008 / Windows Server® 2008 R2:**
From the Start button, click **[All Programs]** - **[Brother P-touch]** - **[P-touch Tools]** - **[P-touch Library 2.2]**.
- **For Windows® 8 / Windows® 8.1 / Windows Server® 2012 / Windows Server® 2012 R2:**
Click **[P-touch Library 2.2]** on the **[Apps]** screen.
- **For Windows® 10:**
From the Start button, select **[All apps]**, and then click **[P-touch Library 2.2]** under **[Brother P-touch]**.

When P-touch Library starts, the main window appears.

Main window

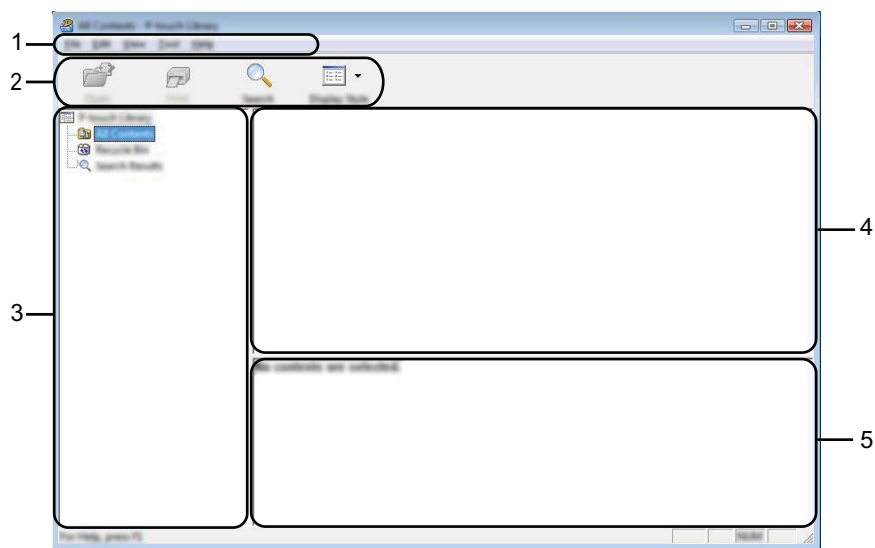

1 Menu bar

Provides access to all available commands, which are grouped under each menu title (**[File]**, **[Edit]**, **[View]**, **[Tool]**, and **[Help]**) according to their functions.

2 Toolbar

Provides access to frequently used commands.

3 Folder list

Displays a list of folders. When you select a folder, the templates in the selected folder appears in the templates list.



4 Templates list

Displays a list of the templates in the selected folder.

5 Preview

Displays a preview of the templates selected in the templates list.

Explanations of the Toolbar Icons

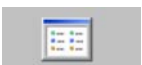
Icon	Button name	Function
	Open	Opens the selected template.
	Print (Only for P-touch Library)	Prints the selected template with the P-touch Label Printer.
	Search	Allows you to search for templates registered to P-touch Library.
	Display Style	Changes the file display style.

Printing Templates

Select the template you want to print, and then click **[Print]**.

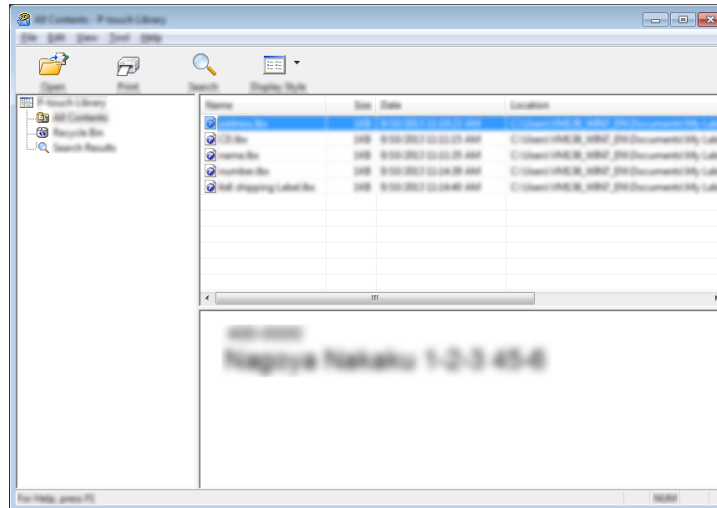

The connected P-touch Label Printer prints the template.

Searching for Templates

You can search for templates registered to P-touch Library.

- 1 Click [**Search**].
The [**Search**] dialog box appears.

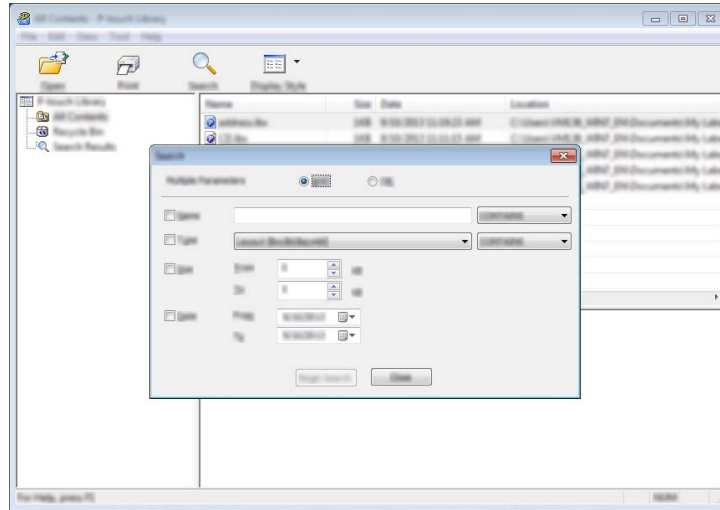

- 2 Specify the search criteria.
The following search criteria are available:

Settings	Details
Multiple Parameters	Determines how the program searches when multiple criteria are specified. If you select [AND], the program searches for files that satisfy all of the criteria. If you select [OR], the program searches for files that satisfy any of the criteria.
Name	Search for a template by specifying the file name.
Type	Search for a template by specifying the file type.
Size	Search for a template by specifying the file size.
Date	Search for a template by specifying the file date.

- 3 Click [**Begin Search**].
The search begins.

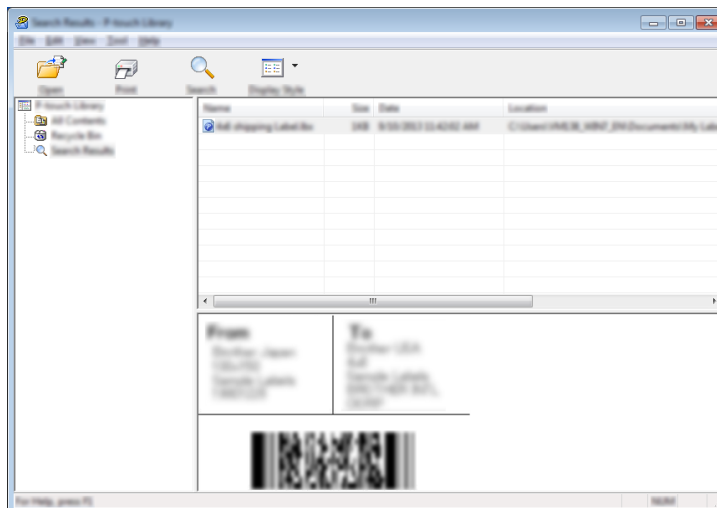

- 4 Close the **[Search]** dialog box.
To confirm the search results, click **[Search Results]** in the folder view.

 **Note**

You can register templates to P-touch Library by dragging and dropping them into the **[All Contents]** folder or to the folder list. You can also configure P-touch Editor to register templates to P-touch Library automatically, using the following procedure:

- 1 From the P-touch Editor menu, select **[Tools]-[Options]**.
- 2 In the **[Options]** dialog box, click **[Registration Settings]** in the **[General]** tab.
- 3 Select the timing for registering templates created with P-touch Editor, and then click **[OK]**.

Transferring Templates with P-touch Transfer Express (Windows® Only)

You can transfer templates to the P-touch Label Printer using P-touch Transfer Express. First, the administrator creates a template, and then distributes it together with P-touch Transfer Express. You can then use P-touch Transfer Express to transfer the template directly to your P-touch Label Printer.

You can download the latest P-touch Transfer Express from the Brother Solutions Center at support.brother.com

[Select your region/country.] - [Downloads] - [Choose your product]

Important

- If the template is to be transferred as a new one, make sure you specify a **[Key Assign]** number (in P-touch Transfer Manager) that is not currently used. If the specified **[Key Assign]** number is already being used, the existing template will be overwritten with the new one.
- This function requires a USB connection.

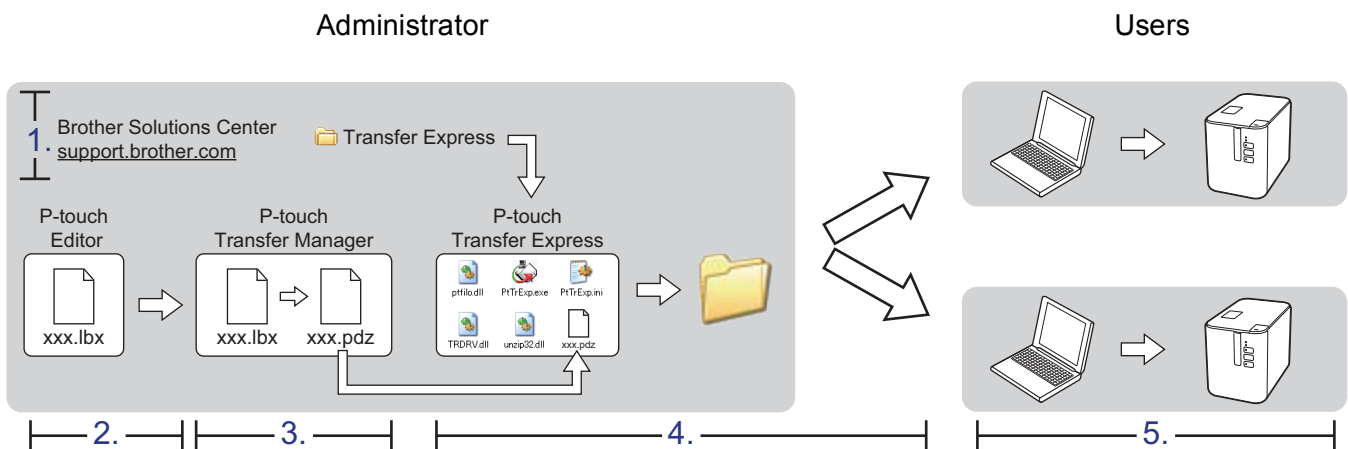

Preparing P-touch Transfer Express

The user must prepare P-touch Transfer Express for transferring templates to a P-touch Label Printer.

Important

- The printer driver must be installed before using Transfer Express.
- P-touch Transfer Express is available only in English.

- 1 You can download the latest P-touch Transfer Express from the Brother Solutions Center at support.brother.com
[Select your region/country.] - [Downloads] - [Choose your product]
- 2 Download Transfer Express to any location on the computer.
- 3 Decompress the downloaded file (.zip).

Transferring the Template to P-touch Transfer Manager

- 1 In P-touch Editor, open the template to be transferred.
- 2 Click **[File]** - **[Transfer Template]** - **[Transfer]**.

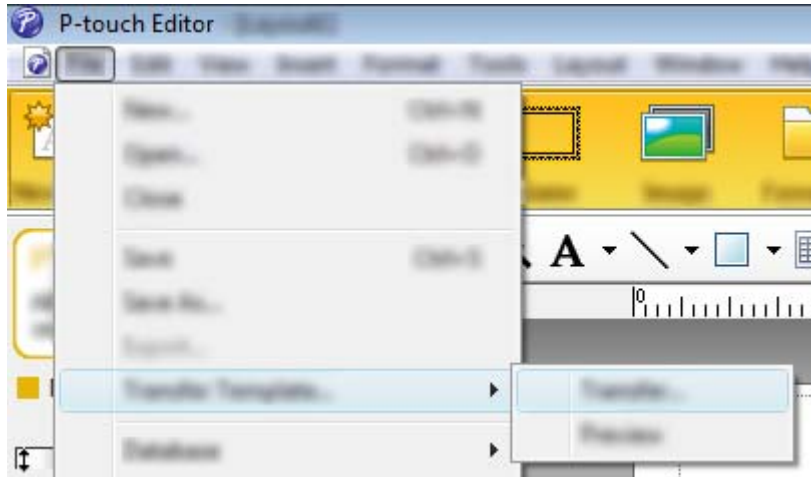

The template is transferred to P-touch Transfer Manager.
P-touch Transfer Manager automatically starts up.



Note

- **For Windows Vista® / Windows® 7 / Windows Server® 2008 / Windows Server® 2008 R2:**
The template can also be transferred to P-touch Transfer Manager by clicking the Start button - **[All Programs]** - **[Brother P-touch]** - **[P-touch Tools]** - **[P-touch Transfer Manager 2.2]** to start P-touch Transfer Manager, and then dragging the .ltx file to the P-touch Transfer Manager window.
- **For Windows® 8 / Windows® 8.1 / Windows Server® 2012 / Windows Server® 2012 R2:**
The template can also be transferred to P-touch Transfer Manager by clicking **[P-touch Transfer Manager 2.2]** on the **[Apps]** screen to start P-touch Transfer Manager, and then dragging the .ltx file to the P-touch Transfer Manager window.
- **For Windows® 10:**
The template can also be transferred to P-touch Transfer Manager by clicking the Start button, then selecting **[All Apps]** and clicking **[Brother P-touch]** - **[P-touch Transfer Manager 2.2]** to start P-touch Transfer Manager, and then dragging the .ltx file to the P-touch Transfer Manager window.

Saving the Template as a Transfer Package File (.pdz)

To create a file in a format that can be used by P-touch Transfer Express, save the template as a Transfer Package file (.pdz).

- 1 In the folder view, select **[Configurations]**.

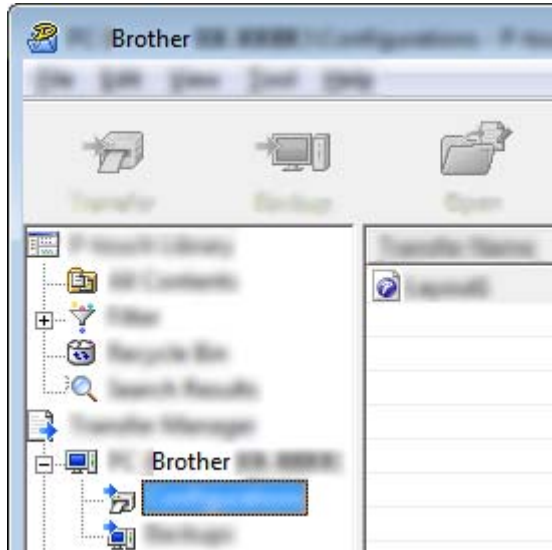

- 2 Select the templates you want to distribute.

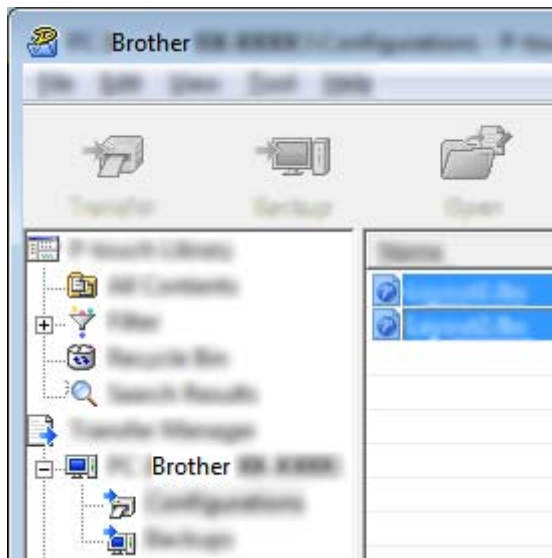

- 3 Click **[File]** - **[Save Transfer File]**.



! Important

The **[Save Transfer File]** button appears only if the P-touch Label Printer is disconnected from the computer or offline.

Note

- If you click **[Save Transfer File]** after selecting **[Configurations]** or a created folder, all templates in the folder are saved as the Transfer Package file (.pdz).
- You can combine multiple templates into a single Transfer Package file (.pdz).

- 4 Type in the name, and then click **[Save]**.

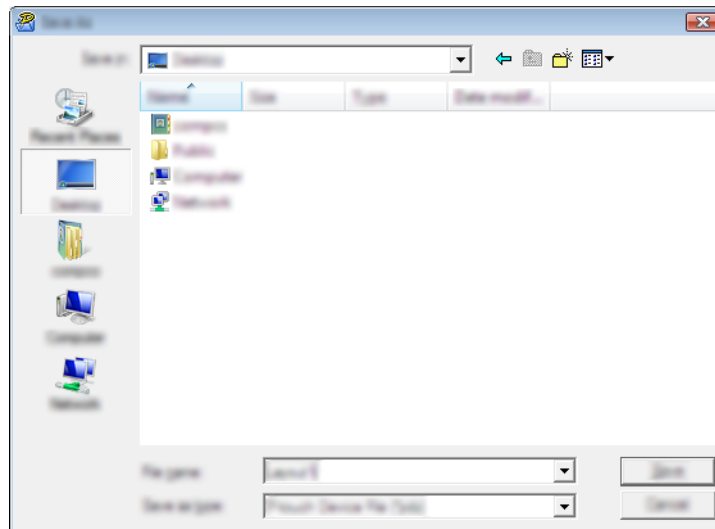

The template is saved as a Transfer Package file (.pdz).

Distributing the Transfer Package File (.pdz) and P-touch Transfer Express to the User



Note

If the user already has P-touch Transfer Express downloaded, it is not necessary for the administrator to send the Transfer Express folder to the user. In this case, the user can simply move the distributed Transfer Package file to the downloaded folder, and then double-click [**PtTrExp.exe**].

- 1 Move the Transfer Package file (.pdz) to the downloads folder.

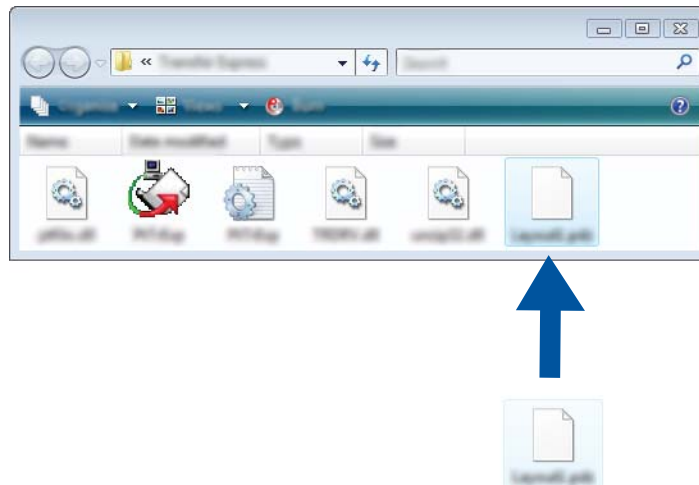

- 2 Distribute all files in the downloads folder to the user.

Transferring the Transfer Package File (.pdz) to Your P-touch Label Printer

Using the P-touch Transfer Express application received from the administrator, the user can transfer the Transfer Package file (.pdz) to the P-touch Label Printer.

❗ Important

Do not turn off the power when transferring templates.

- 1 Turn on the P-touch Label Printer.
- 2 Using a USB cable, connect the P-touch Label Printer to the computer.
- 3 Double-click [**PtTrExp.exe**], which was received from the administrator.
- 4 1. When there is a single Transfer Package file (.pdz) within the folder containing [**PtTrExp.exe**], click [**Transfer**].

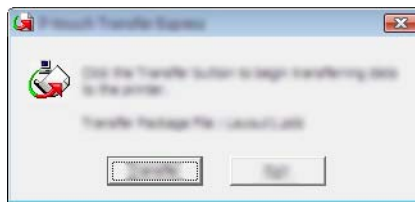

The transfer of the Transfer Package file begins.

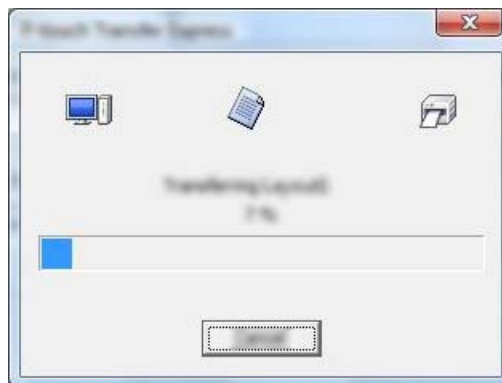

2. When there are either multiple or no Transfer Package files (.pdz) within the folder containing [PtTrExp.exe], click [Browse].

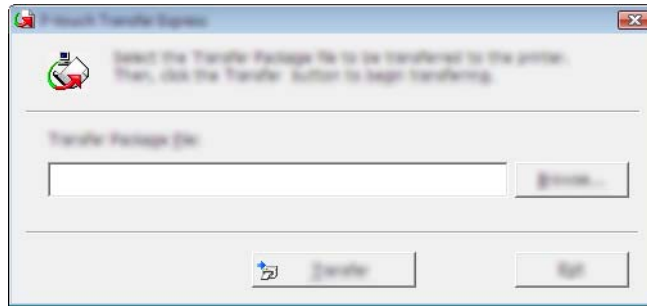

Select the Transfer Package file you want to transfer, and then click [Open].

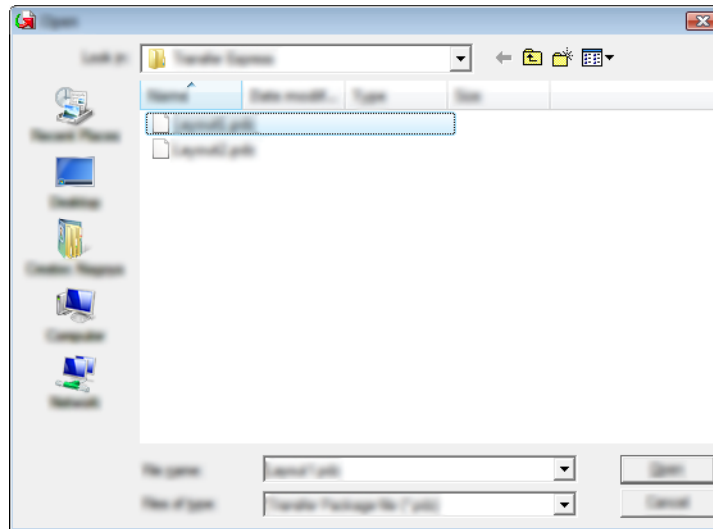

Click [Transfer].

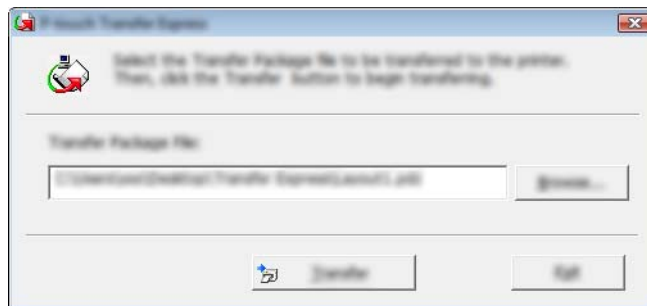

Click **[Yes]**.

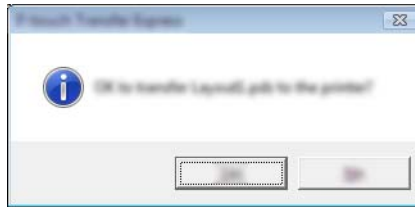

The transfer of the Transfer Package file begins.

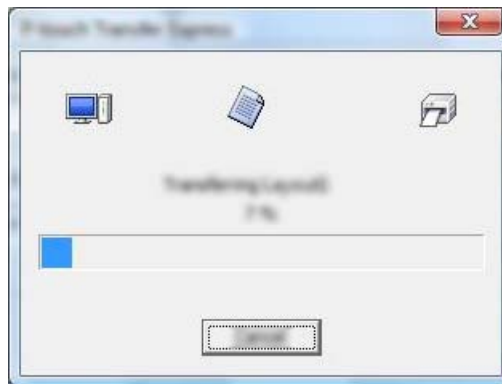

5 Click **[OK]**.

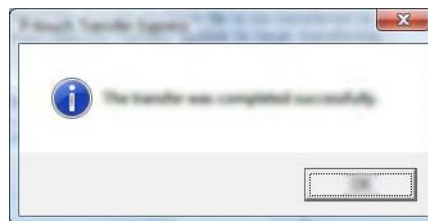

The transfer of the Transfer Package file is completed.

The software can be upgraded to the latest available version using the P-touch Update Software.



Note

- The actual software and the contents of this manual may differ.
- Do not turn off the power when transferring data or updating firmware.

Updating Cable Label Tool (Windows[®] Only) and P-touch Editor



Important

The printer driver must be installed before updating Cable Label Tool (Windows[®] only) and P-touch Editor.

For Windows[®]



1 Start the P-touch Update Software.

- **For Windows Vista[®] / Windows[®] 7 / Windows Server[®] 2008 / Windows Server[®] 2008 R2:**
Double-click the **[P-touch Update Software]** icon.



Note

The following method can also be used to start P-touch Update Software:

Click the Start button, and then select **[All Programs]** - **[Brother P-touch]** - **[P-touch Update Software]**.

- **For Windows[®] 8 / Windows[®] 8.1 / Windows Server[®] 2012 / Windows Server[®] 2012 R2:**
Click **[P-touch Update Software]** on the **[Apps]** screen or double-click **[P-touch Update Software]** on the desktop.
- **For Windows[®] 10:**
From the Start button, select **[All apps]** and click **[Brother P-touch]** - **[P-touch Update Software]**, or double-click **[P-touch Update Software]** on the desktop.



- 2 Click the **[Computer software update]** icon.

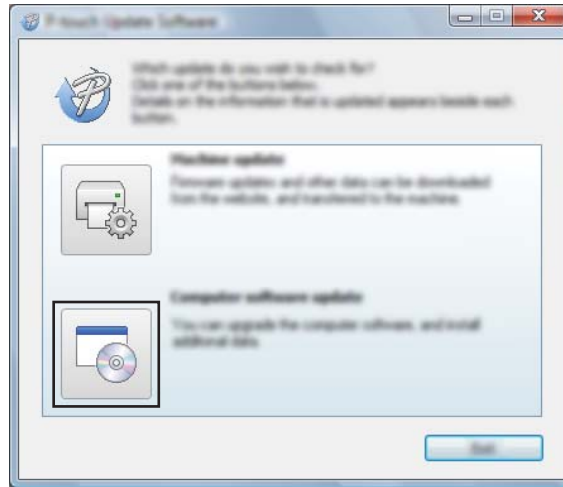

- 3 Select the **[Printer]** and **[Language]**, select the check box next to Cable Label Tool and P-touch Editor, and then click **[Install]**.

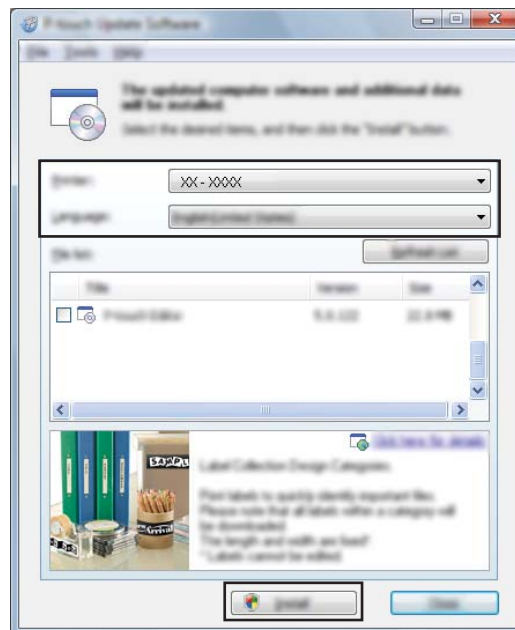

- 4 A message appears indicating that the installation has finished.

For Mac

- 1 Double-click the **[P-touch Update Software]** icon on the desktop.



Note

The following method can also be used to start P-touch Update Software:

Double-click **[Macintosh HD] - [Applications] - [P-touch Update Software]**, and then double-click the **[P-touch Update Software]** application icon.



- 2 Click the **[Computer software update]** icon.

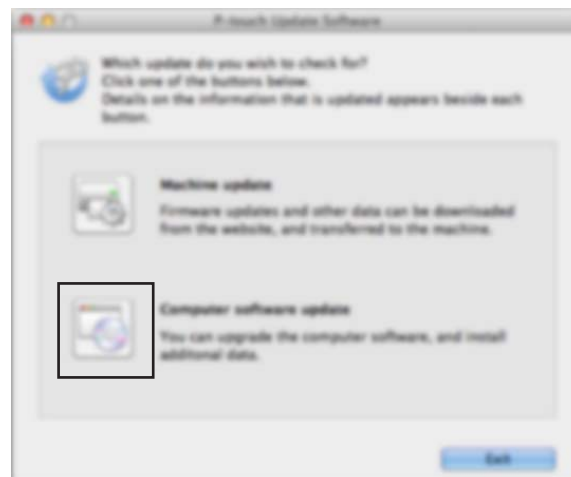

- 3 Select the **[Printer]** and **[Language]**, select the check box next to P-touch Editor, and then click **[Install]**.

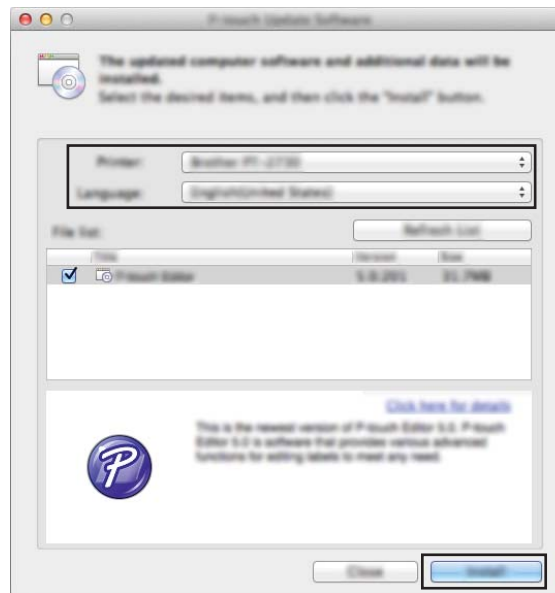

- 4 A message appears indicating that the installation has finished.

Updating the Firmware

❗ Important

- The printer driver must be installed before updating the firmware.
- Do not turn off the power when transferring data or updating firmware.
- If another application is running, exit the application.

For Windows®

- 1 Turn on the P-touch Label Printer and connect the USB cable.
- 2 Start the P-touch Update Software.
 - **For Windows Vista® / Windows® 7 / Windows Server® 2008 / Windows Server® 2008 R2:**
Double-click the **[P-touch Update Software]** icon.

📝 Note

The following method can also be used to start P-touch Update Software:

Click the Start button, and then select **[All Programs] - [Brother P-touch] - [P-touch Update Software]**.

- **For Windows® 8 / Windows® 8.1 / Windows Server® 2012 / Windows Server® 2012 R2:**

Click **[P-touch Update Software]** on the **[Apps]** screen or double-click **[P-touch Update Software]** on the desktop.

- **For Windows® 10:**

From the Start button, select **[All apps]** and click **[Brother P-touch] - [P-touch Update Software]**, or double-click **[P-touch Update Software]** on the desktop.



- 3 Click the **[Machine update]** icon.

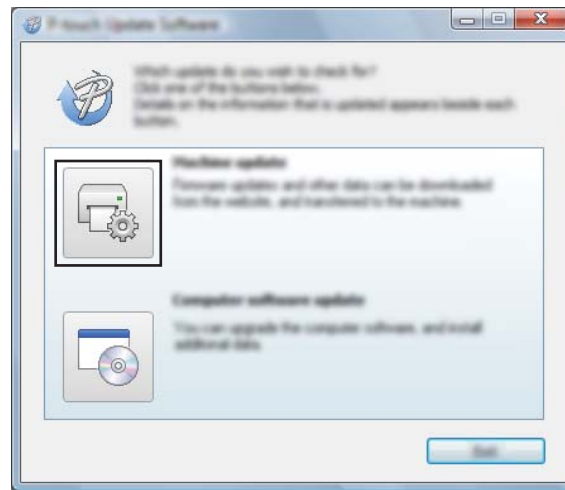

- 4 Select the **[Printer]**, ensure that **[The machine is connected correctly.]** appears, and then click **[OK]**.

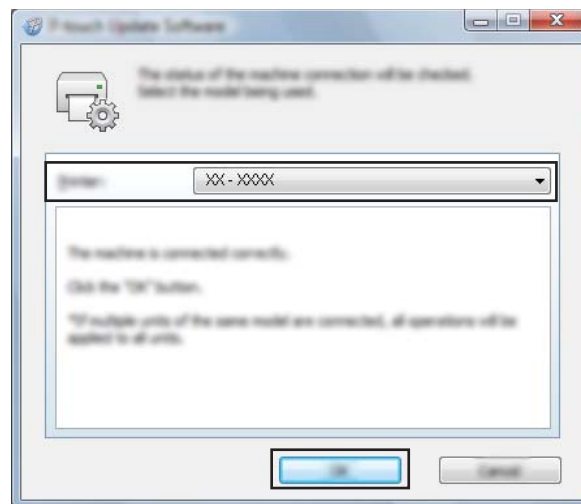

- 5 Select the [**Language**], select the check box next to the firmware you want to update to, and then click [**Transfer**].

Important

Do not turn off the P-touch Label Printer or disconnect the cable during data transfer.

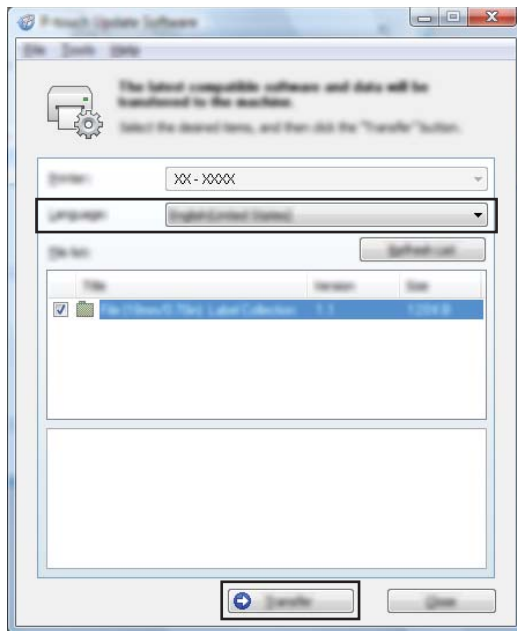

- 6 Check the content to be updated, and then click [**Start**] to begin the update. The firmware update begins.

Important

Do not turn off the P-touch Label Printer or disconnect the cable during the update process.

For Mac

- 1 Turn on the P-touch Label Printer and connect the USB cable:
- 2 Double-click the [**P-touch Update Software**] icon on the desktop.

Note

The following method can also be used to start P-touch Update Software:

Double-click [**Macintosh HD**] - [**Applications**] - [**P-touch Update Software**], and then double-click the [**P-touch Update Software**] application icon.



- 3 Click the **[Machine update]** icon.

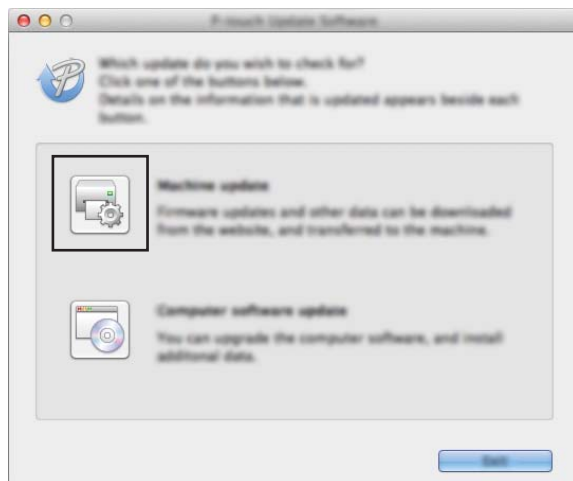

- 4 Select the **[Printer]**, ensure that **[The machine is connected correctly.]** appears, and then click **[OK]**.

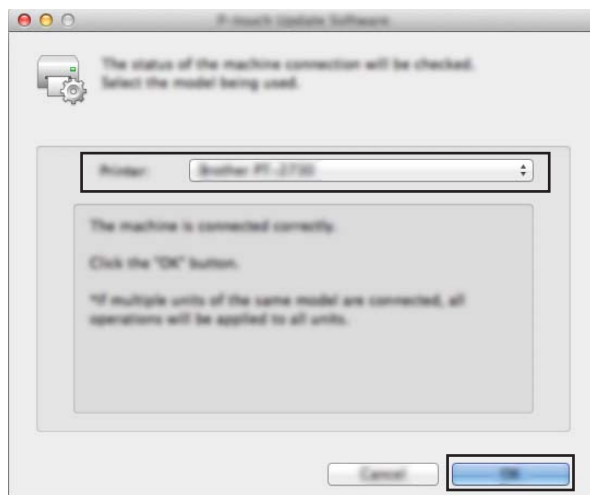

- 5 Select the **[Language]**, select the check box next to the firmware you want to update to, and then click **[Transfer]**.

! Important

Do not turn off the P-touch Label Printer or disconnect the cable during data transfer.

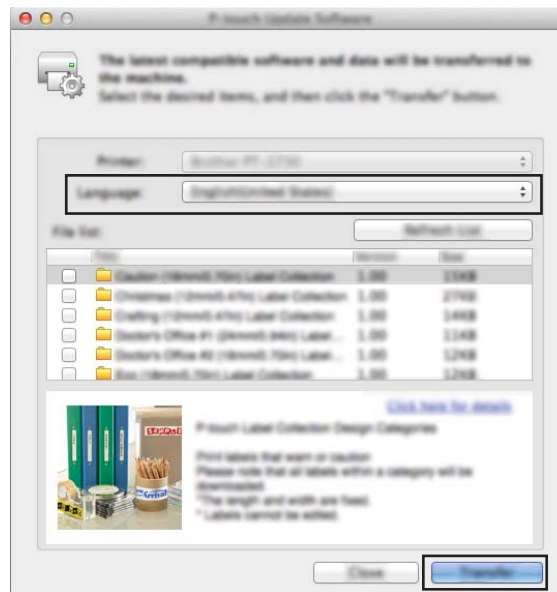

- 6 Check the content you want to update, and then click [**Start**] to begin the update. The firmware update begins.



Note

Do not turn off the P-touch Label Printer during the update process.



Network

Introduction	144
Changing Your P-touch Label Printer Network Settings	145
Web Based Management	148

13 Introduction

Network Features

Your P-touch Label Printer can be shared on an IEEE 802.11b/g/n wireless network or Ethernet 10BASE-T/100BASE-TX Auto Negotiation wired network (PT-P950NW only) using the internal network print server. The print server supports various functions and methods of connection on a network supporting TCP/IP, depending on the operating system you are running.

Changing Your P-touch Label Printer's Network Settings (IP Address, Subnet Mask and Gateway) Using Windows®

Using the BRAdmin Light Utility

The BRAdmin Light utility is designed for the initial setup of Brother network connectable devices. It can also search for Brother products in a TCP/IP environment, display the status, and configure basic network settings, such as the IP address.

Installing BRAdmin Light

- 1 Visit the Brother Solutions Center at support.brother.com and download the installer for the software and documents.
- 2 Double-click the downloaded file and follow the on-screen instructions to proceed with the installation. In the dialog box for selecting which items to install, select BRAdmin Light.



Note

- For more advanced printer management, use the latest version of the Brother BRAdmin Professional utility available as a download from the Brother Solutions Center at support.brother.com.
 - If using firewall, anti-spyware, or antivirus software, temporarily disable them. When you are sure that you can print, re-enable them.
 - The node name appears in the current BRAdmin Light window. The default node name of the print server in the printer is "BRWxxxxxxxxxxxx" or "BRNxxxxxxxxxxxx". ("xxxxxxxxxxxx" is based on your printer's MAC Address / Ethernet Address.)
-

Setting the IP address, Subnet Mask and Gateway using BRAdmin Light

- 1 Start the BRAdmin Light utility.
 - **Windows Vista® / Windows® 7 / Windows Server® 2008 / Windows Server® 2008 R2**
Click [Start] - [All Programs] - [Brother] - [BRAdmin Light] - [BRAdmin Light].
 - **Windows® 8 / Windows® 8.1 / Windows Server® 2012 / Windows Server® 2012 R2**
Click the [BRAdmin Light] icon on the [Apps] screen.
 - **Windows® 10**
From the Start button, select [All apps], and then click [BRAdmin Light] under [Brother].
- 2 BRAdmin Light will search for new devices automatically.

- 3 Double-click the unconfigured device.

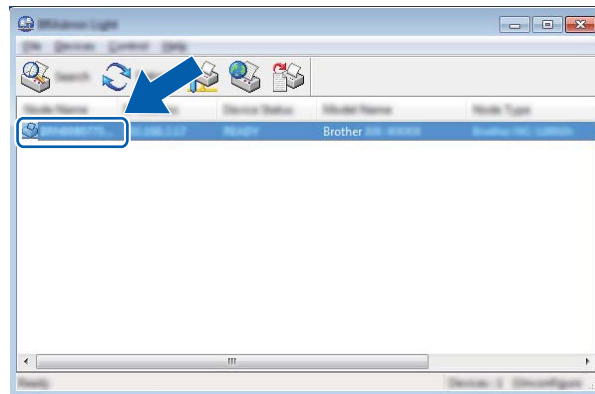

Note

If you do not use a DHCP/BOOTP/RARP server, the device appears as **[Unconfigured]** in the BRAdmin Light utility screen.

- 4 Select **[STATIC]** for **[Boot Method]**. Type the **[IP Address]**, **[Subnet Mask]**, and **[Gateway]** settings (if needed) for your print server.

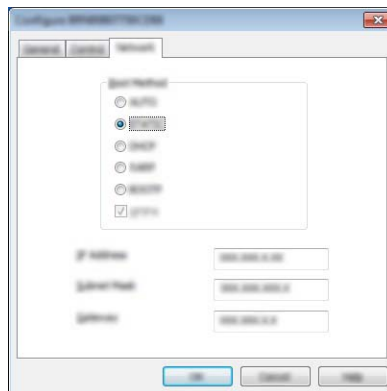

- 5 Click **[OK]**.
- 6 If you have set the IP address up correctly, the Brother print server appears in the device list.

Other Management Utilities

Your P-touch Label Printer can be used with the following management utilities in addition to the BRAdmin Light utility. You can change your network settings using these utilities.

Using Web Based Management (Web Browser)

A standard web browser can be used to change your print server settings using the HTTP (Hyper Text Transfer Protocol). (See *Configuring the Printer Settings Using Web Based Management (Web Browser)* on page 149.)

Using the BRAdmin Professional Utility (Windows® Only)

BRAdmin Professional is a utility for more advanced management of network connected Brother devices. This utility can search for Brother products on your network, and display the device status from an easy to read Explorer style window that changes color to represent the status of each device. You can configure network and device settings along with the ability to update device firmware from a Windows® computer on your Local Area Network (LAN). BRAdmin Professional can also log activity of Brother devices on your network and export the log data.

For more information and downloads, visit the Brother Solutions Center at support.brother.com.



Note

- Use the latest version of the BRAdmin Professional utility available as a download from the Brother Solutions Center at support.brother.com.
 - If using firewall, anti-spyware, or antivirus software, temporarily disable them. When you are sure that you can print, re-enable them.
 - The node name appears in the current BRAdmin Professional window. The default node name is "BRWxxxxxxxxxxx" or "BRNxxxxxxxxxxx". ("xxxxxxxxxxx" is based on your printer's MAC Address / Ethernet Address.)
-

Overview

You can use a standard web browser to manage a P-touch Label Printer on your network using HTTP. When using Web Based Management, the following operations are possible:

- Displaying your P-touch Label Printer status information
- Changing network settings, such as TCP/IP information
- Displaying software version information of the P-touch Label Printer and print server
- Changing network and P-touch Label Printer configuration details



Note

We recommend Microsoft® Internet Explorer® 7.0 or later or Firefox® 25.0.1 or later for Windows®, Safari® 5.0.6 or later or Firefox® 26.0 or later for Mac.

Make sure JavaScript and cookies are always enabled in the browser you use.

To use Web Based Management, your network must use TCP/IP, and the P-touch Label Printer and computer must have a valid IP address.

Configuring the Printer Settings Using Web Based Management (Web Browser)

A standard web browser can be used to change your print server settings using the HTTP (Hyper Text Transfer Protocol).

- 1 In your browser's address bar, type the IP address of your P-touch Label Printer (or print server name).
For example: `http://192.168.1.2`



Note

If you have edited the hosts file on your computer or are using a Domain Name System, you can also type the DNS name of the print server. As the print server supports TCP/IP and NetBIOS, you can also type the NetBIOS name of the print server. The NetBIOS name can be seen on the printer settings page. The NetBIOS name assigned is the first 15 characters of the node name and by default it appears as "BRNxxxxxxxxxxx" where "xxxxxxxxxxx" is the Ethernet address.



- 2 You can now change the print server settings.



Note

Setting a password

We recommend setting a logon password to prevent unauthorized access to Web Based Management.

- 1 Click [**Administrator**].
 - 2 Type the password you want to use (up to 32 characters).
 - 3 Re-type the password in the [**Confirm new password**] field.
 - 4 Click [**Submit**].
The next time you access Web Based Management, type a password in the [**Login**] field, and then click .
- After configuring the settings, log off by clicking .

You can also set a password by clicking [**Please configure the password.**] on the printer's web page if you are not setting a logon password.



Appendix









Resetting the P-touch Label Printer	151
Maintenance	152
Troubleshooting	155
Product Specifications	169
Notes on Using P-touch Transfer Manager	172
Network Terms and Information	174
List of Barcodes for the P-touch Template Function	184
Using the Rechargeable Li-ion Battery/Battery Base (Optional:PA-BT-4000LI/PA-BB-002)	188

You can reset the internal memory of your P-touch Label Printer to clear all saved label files, or if the P-touch Label Printer is not operating correctly.

Resetting All Settings to the Factory Settings Using the P-touch Label Printer Buttons

All text, format settings, option settings and stored label files are cleared when you reset the P-touch Label Printer (including language and unit settings).

To reset the P-touch Label Printer, perform the following procedure.

- 1 Turn off the P-touch Label Printer.
- 2 Press and hold the  (Power) and  (Feed&Cut) buttons for more than three seconds. The  (Status) indicator flashes in green and the  (Power) indicator lit in orange.
- 3 While holding the  (Power) button, press the  (Feed&Cut) button as follows:
 - Press two times to reset the communication settings to the factory settings.
 - Press four times to reset the communication settings to the factory settings. However, **[APIPA]** is set to **[OFF]**.
 - Press six times to reset the communication settings and device settings to the factory settings. Also, the transferred data from the computer is deleted.
- 4 Release the  (Power) button. The  (Status) indicator flashing three times in green and the  (Power) indicator flashing three times in orange.

Resetting Data Using the Printer Setting Tool

You can use the Printer Setting Tool from a computer to perform the following operations for the P-touch Label Printer:

- Deleting the templates and databases
- Deleting the print log
- Resetting Wi-Fi settings
- Resetting printer settings to factory settings

For more information, see *Changing the P-touch Label Printer Settings* on page 26.

We recommend cleaning your P-touch Label Printer on a regular basis to maintain its correct performance.

**Note**

Always disconnect the AC adapter prior to cleaning the P-touch Label Printer.

Cleaning the Exterior of the Unit

Wipe any dust and marks from the main unit using a soft, dry cloth.

Use a slightly dampened cloth with water on difficult to remove marks.

**Note**

Do not use paint thinner, benzene, alcohol or any other organic solvent.

These may deform the case or damage the appearance of your P-touch Label Printer.

Cleaning the Print Head and Head Roller

Streaks or poor-quality characters on printed labels generally indicate that the print head and head roller are dirty. Clean the print head using a dry cotton swab, or the optional print head cleaning cassette (TZe-CL6).

WARNING

Do not touch the print head directly with your bare hands. The print head may be hot.

**Note**

See the instructions provided with the print head cleaning cassette for directions on how to use it.

Print Head

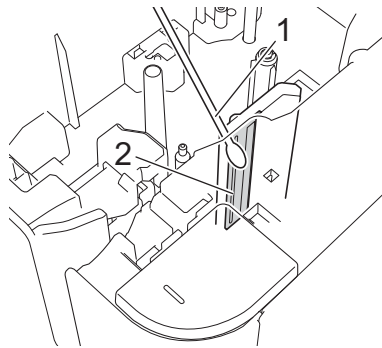

- 1 Cotton swab
- 2 Print head

Head Roller

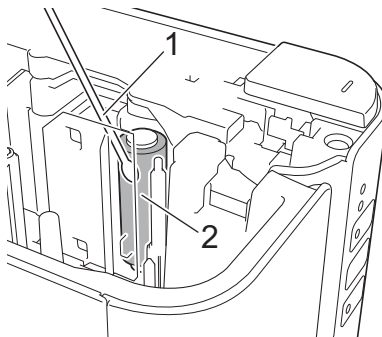

- 1 Cotton swab
- 2 Head roller

Cleaning the Tape Cutter

About once every year, wipe the cutter blades using a cotton swab moistened with isopropyl alcohol (rubbing alcohol).

Tape adhesive can build up on the cutter blade after repeated use, taking the edge off the blade which may result in the tape jamming in the cutter.

! WARNING

Do not touch the cutter blade with your bare hands.

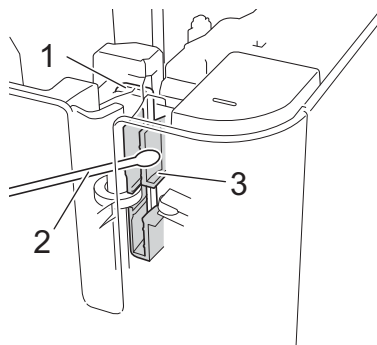

- 1 Cutter blade
- 2 Cotton swab
- 3 Metal section

18 Troubleshooting



Overview

This chapter explains how to resolve typical problems you may encounter when using the P-touch Label Printer. If you have any problems with the P-touch Label Printer, first make sure you have performed the following tasks correctly:

- Connect the P-touch Label Printer to an AC power outlet or install the battery (see *Connecting the Power Supply* on page 4 or *Installing the Rechargeable Li-ion Battery* on page 188).
- Remove all protective packaging from the P-touch Label Printer.
- Install and select the correct printer driver (see *Installing the Printer Driver and Software* on page 8).
- Connect the P-touch Label Printer to a computer or mobile device (see *Connecting the P-touch Label Printer to a Computer* on page 9).
- Close the tape compartment cover completely.
- Insert a tape cassette correctly (see *Inserting a Tape Cassette* on page 5).

If you still have problems, read the troubleshooting tips in this chapter for help. If, after reading this chapter, you are unable to resolve your problem, visit the Brother Solutions Center at support.brother.com.

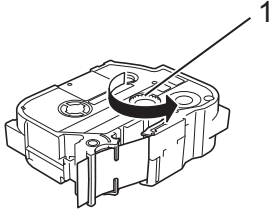
Printing Problems

Problem	Solution
The printer does not print. A printing error is received.	Check that the interface cable is connected correctly, the tape cassette is installed correctly, and the tape compartment cover is closed.
I want to cancel the current printing job.	Make sure that the printer is on, and then briefly press the  (Power) button on the front of the printer.
The label did not print.	<ul style="list-style-type: none"> ■ Check that text has been entered and that the tape cassette is installed correctly with sufficient tape remaining. ■ If the tape is bent, cut off the bent section and thread the tape through the exit slot. ■ If the tape is jammed, remove the tape cassette, and then pull out the jammed tape and cut it. Check that the end of the tape passes through the guide before reinstalling the tape cassette.
The label is not printed correctly.	<ul style="list-style-type: none"> ■ Remove the tape cassette and reinstall it, pressing it firmly until it locks into place. ■ If the print head is dirty, clean it with a dry cotton swab (see <i>Cleaning the Print Head and Head Roller</i> on page 152) or optional print head cleaning cassette (TZe-CL6).
The ink ribbon is separated from the ink roller.	<p>If the ink ribbon is broken, replace the tape cassette. If not, leave the tape uncut and remove the tape cassette, then wind the loose ink ribbon onto the spool as shown in the figure.</p> <div style="text-align: center;">  </div> <p>1 Spool</p>
The P-touch Label Printer stops while printing a label.	<ul style="list-style-type: none"> ■ Replace the tape cassette if striped tape is visible, as this indicates that you have reached the end of the tape. ■ Connect the AC adapter directly to the P-touch Label Printer, or charge the rechargeable Li-ion battery.
The label did not get cut automatically.	<p>Check the Cut Option setting. For more information, see <i>Cutting Options</i> on page 14 or page 19.</p> <p>Alternatively, when using the tape cassette, press the  (Feed&Cut) button to feed and cut the tape.</p>
A tape jam error cannot be cleared despite following the troubleshooting steps.	Contact Brother customer service.

Problem	Solution
I want to print in higher resolution.	<p>High resolution printing can be used if you are printing from a computer, the AC adapter is connected, and TZe and HGe laminated tape with black ink is installed. Use the printer driver to select the high resolution mode when printing the labels.</p> <p>You cannot use this function for TZe-FX**1 tape.</p>
The high resolution or high speed printing setting was specified, but an error occurred and printing could not be completed.	<p>As conditions for high resolution or high speed printing, the AC adapter must be connected, and TZe and HGe laminated tape with black ink must be installed.</p> <p>You cannot use this function for TZe-FX**1 tape.</p> <p>To clear the error, cancel the print job, and then connect the AC adapter or cancel high resolution or high speed printing.</p>







Problem	Solution
<p>Printed barcodes cannot be read.</p>	<ul style="list-style-type: none"> ■ Print labels so that barcodes are aligned with the print head as shown below: <div data-bbox="889 394 1209 552" style="text-align: center;"> <p>The diagram illustrates the correct alignment for printing barcodes. A horizontal grey bar at the top is labeled '1' and represents the print head. Below it, a rectangular label is shown with a barcode inside, labeled '2'. A downward-pointing arrow between the print head and the label is labeled '3', indicating the direction of printing. The barcode is positioned such that its vertical lines are aligned with the print head.</p> </div> <ul style="list-style-type: none"> 1 Print head 2 Barcodes 3 Printing orientation <ul style="list-style-type: none"> ■ Try using another scanner. ■ We recommend printing the barcodes with [Standard] selected from the [Quality] options. <p>Windows Vista® / Windows Server® 2008</p> <p>To display the [Quality] options, open the printer properties by clicking the Start button - [Control Panel] - [Hardware and Sound] - [Printers], right-clicking the P-touch Label Printer you want to set up, and then clicking [Printing Preferences].</p> <p>Windows® 7 / Windows Server® 2008 R2</p> <p>To display the [Quality] options, open the printer properties by clicking the Start button - [Devices and Printers], right-clicking the P-touch Label Printer you want to set up, and then clicking [Printing Preferences].</p> <p>Windows® 8 / Windows® 8.1 / Windows Server® 2012 / Windows Server® 2012 R2</p> <p>To display the [Quality] options, open the printer properties by clicking [Control Panel] in the [Apps] screen - [Hardware and Sound] - [Devices and Printers], right-clicking the P-touch Label Printer you want to set up, and then clicking [Printing Preferences].</p> <p>Windows® 10</p> <p>To display the [Quality] options, open the printer properties by clicking the Start button - [Settings] - [Devices] - [Devices and Printers], right-clicking the P-touch Label Printer you want to set up, and then clicking [Printing Preferences].</p>

Problem	Solution
<p>Jams occur when I use TZe-R*** tape cassettes.</p>	<p>Remove the TZe-R*** tape cassette from the printer, and then remove the jammed ribbon.</p> <p>Because the material used for the TZe-R*** ribbon is light and flexible, the ribbon may jam if it contacts the parts of the tape exit slot.</p> <p>When using TZe-R*** tape cassettes, position the printer so that the ribbon exits straight out of the tape exit slot. In addition, make sure the discharged ribbon does not hang down from the printer. The ribbon may jam if it touches the tape exit slot.</p> <p>In addition to these precautions, do not touch the ribbon during printing.</p>



Label Problems

Problem	Solution
<p>While printing, striped tape appears.</p>	<p>The tape cassette is empty.</p> <p>Install a new tape cassette (see <i>Inserting a Tape Cassette</i> on page 5).</p>
<p>There is about 1" of blank space at the leading edge of each printed label.</p>	<p>Most TZe and HGe labels have a clear laminate top layer. This durable laminate helps the label withstand abrasion, fading and wet conditions providing a crisp, readable image. The process of adding this laminate layer results in the leading edge of blank space. Adjusting the label's margin or using the chain printing feature may reduce the amount of blank space.</p>
<p>The label is not cut automatically.</p>	<ul style="list-style-type: none"> ■ Use P-touch Editor to check the Auto Cut, Chain Printing and Special Tape settings. <p>After printing, remove the tape cassette from the P-touch Label Printer and use scissors to cut the tape.</p> <p>Be sure to read the instructions provided with tapes and observe all precautions noted in the instructions.</p>
<p>The printed label contains a blank horizontal line.</p>	<p>There may be some dust on the print head.</p> <p>For more information, see <i>Maintenance</i> on page 152 and clean the print head and head roller.</p>
<p>After the labels are cut, they are not ejected from the printer correctly.</p>	<p>The cutter blade may be dirty.</p> <p>For more information, see <i>Maintenance</i> on page 152 and clean the cutter.</p>

Printer Problems

Problem	Solution
The  (Power) button does not light up or flash.	Check that the power supply cord is connected correctly. If the  (Power) button still does not light up or flash, contact the retail outlet where the printer was purchased or your local authorized service center.
A data transmission error appears on the computer.	<ul style="list-style-type: none"> ■ The wrong port may be selected. For Windows®, select the correct port from the “Print to the following port” list in the Properties dialog box for the printer. For a USB connection, select “USB00n”. ■ Is someone printing via the network? If you try to print while other users are printing large amounts of data, the printer is unable to accept your print job until the ongoing printing is finished. In such situations, execute the print job again after the other jobs are completed. ■ The baud rates for the computer and the printer may not be the same. For more information, see <i>Setting the Barcode Scanner or Scale Baud Rate</i> on page 24 and change the baud rate.
The baud rate cannot be set using the Change Baud Rate Wizard or the Brother printer utilities.	<ul style="list-style-type: none"> ■ Error 99: the computer cannot detect the printer. <ul style="list-style-type: none"> • Make sure that the printer is turned on. • Make sure that the interface cable is connected correctly. • Make sure that the COM port where the printer is connected is the same COM port selected in the Change Baud Rate Wizard. (Many computers have more than one COM port and COM2 may have been selected in error in the Change Baud Rate Wizard.) ■ Error 1 or Error 5: the serial port of the computer cannot be used. ■ When another serial connection device is using the same COM port, labels cannot be printed. Change the COM port for the serial connection device or connect the printer to a COM port that is not in use.
I want to reset the printer and delete the data transferred from the computer.	To reset the printer, press and hold the  (Power) button to turn off the printer. Then, press and hold the  (Power) button and  (Feed&Cut) buttons for more than three seconds. Continue holding down the  (Power) button, and press the  (Feed&Cut) button six times. The printer will then reset. All data transferred from the computer will be deleted and the printer will be reset to the factory settings.
An error occurred during installation.	Visit support.brother.com

Network Setup Problems

Problem	Solution
You are using security software	<ul style="list-style-type: none"> ■ Confirm your settings in the installation dialog box. ■ Allow access when the security software alert message appears during the printer installation.
Your security settings (SSID/Network Key) are incorrect	<p>Recheck and select the correct security settings.</p> <ul style="list-style-type: none"> ■ The manufacturer's name or model number of the wireless access point/router may be used as the default security settings. ■ See the instructions supplied with your wireless access point/router for information on how to find the security settings. ■ Ask the manufacturer of your wireless access point/router or ask your Internet provider or network administrator.
Your P-touch Label Printer is placed too far from your mobile device	Move your P-touch Label Printer within about 3.3 ft (1 m) of the mobile device when you configure the Wi-Fi network settings.
There are obstructions (walls or furniture, for example) between your P-touch Label Printer and the mobile device	Move your P-touch Label Printer to an obstruction-free area.
A wireless computer, Bluetooth supported device, microwave oven or digital cordless phone is near the P-touch Label Printer or the wireless access point/router	Move other devices away from the P-touch Label Printer.
You are using MAC Address filtering	<p>You can confirm the MAC address by printing the printer settings report. See <i>Confirming the P-touch Label Printer Settings</i> on page 82 for more information.</p>
Your wireless access point/router is in stealth mode (not broadcasting the SSID)	<ul style="list-style-type: none"> ■ You must type the correct SSID name during the installation or when using the Printer Setting Tool. ■ Check the SSID name in the instructions supplied with your wireless access point/router and reconfigure the Wi-Fi settings.
Your P-touch Label Printer is not connected correctly to the network	<p>Check the  (Wi-Fi) indicator on the P-touch Label Printer.</p> <p> : The network is correctly connected.</p> <p> (flashes once every three seconds): The network is connected incorrectly, and the Wi-Fi settings must be reconfigured.</p>
I have checked and tried all of the above, but still cannot complete the Wi-Fi settings	Turn off the P-touch Label Printer, and then turn it on again. Then try and configure the Wi-Fi settings again.

P-touch Label Printer Cannot Print over the Network P-touch Label Printer Is Not Found on the Network Even after Successful Installation

Problem	Solution
You are using security software	See <i>Security Software Problems</i> on page 162.
Your P-touch Label Printer is not assigned with an available IP address	<ul style="list-style-type: none"> ■ Confirm the IP address and the Subnet Mask. Verify that both the IP addresses and Subnet Masks of your computer and your P-touch Label Printer are correct and located on the same network. For more information on how to verify the IP address and the Subnet Mask, ask the network administrator. ■ Confirm your IP address, Subnet Mask and other network settings using the Printer Setting Tool. See <i>Changing the P-touch Label Printer Settings</i> on page 26.
Your previous printing job failed	<ul style="list-style-type: none"> ■ If the failed printing job is still in your computer's print queue, delete it. For example, when using Windows® 7:  [Devices and Printers] and select your printer from [Printers and Faxes]. Double-click your printer's icon, and then select [Cancel All Documents] in the [Printer] menu.
I have checked and tried all of the above, but my P-touch Label Printer does not print	Uninstall the printer driver and the software, and then reinstall them.

Security Software Problems

Problem	Solution
You did not select to allow access when the security alert dialog box appeared during either the standard installation, BRAdmin Light installation, or when printing	If you did not select to allow access when the security alert dialog box appeared, the firewall function of your security software may be blocking access. Some security software may block access without displaying a security alert dialog box. To allow access, see the instructions of your security software or ask the manufacturer.
Incorrect port numbers are being used for the Brother network features	<p>The following port numbers are used for Brother network features:</p> <ul style="list-style-type: none"> ■ BRAdmin Light – Port number 161 / Protocol UDP <p>For more information on how to open the port, see the instructions for the security software or ask the manufacturer.</p>

Checking the Operation of Network Devices









Problem	Solution
Your P-touch Label Printer and wireless access point/router are not turned on	Make sure you have performed all of the tasks on page 155.
I do not know my P-touch Label Printer network settings, such as the IP address	Check the Printer Setting Tool (see <i>Changing the P-touch Label Printer Settings</i> on page 26).

Version Information

Problem	Solution
I do not know the version number of the firmware for the P-touch Label Printer.	<p>You can use the following procedure.</p> <ol style="list-style-type: none"> 1 Turn your P-touch Label Printer on. 2 Press and hold the > (Feed&Cut) button for more than 10 seconds to print the report. (Use 0.94" (24 mm) or 1.4" (36 mm) tape.)
I want to confirm whether I am using the latest version of the software.	<p>Use the P-touch Update Software to confirm if you have the latest version or not.</p> <p>See the User's Guide for more information about the P-touch Update Software.</p>

LED Indicators



















































The indicators light and flash to indicate the P-touch Label Printer status. The symbols used in this section explain the meaning of the different indicator and patterns:

-  or  or  Indicator is lit in the color shown
-  or  or  Indicator is flashing in the color shown
-  Indicator can be off, lit or flashing in any color
-  Indicator is off





















Status, Power, Wi-Fi indicator

 (Status)	 (Power)	 (Wi-Fi)	Condition
			During the processing of the power-off
			Idle mode Initializing mode Mode can be used only when the Touch Panel Display (TDU) is installed (includes the error mode) (PT-P950NW only)
			Tape feed and cutting mode
			Printing mode
 (2 times in 1.8 seconds)			No media error Tape end error
			Cover open mode
			Cover open error when printing
			Receiving data
			Transferring data
			Now cooling
			System error 1 System error 2 System error 3 → Turn off the P-touch Label Printer and on again.















Status, Power, Wi-Fi indicator

 (Status)	 (Power)	 (Wi-Fi)	Condition
			In boot mode
			Reset mode (when the mode is starting)
			Reset mode (when the button is pressed 1/3/5 times)
			Reset mode (when the button is pressed 2/4/6 times)
 (Three times)	 (Three times)		Reset mode (when reset is confirmed)
	   (Repeat four times)		IP address fixed notification (USB ID fixed notification)
			Mass storage mode
 (One time)			Mass storage processing mode
 (2 times in 1.8 seconds)			PT-P950NW only: USB host unsupported device connection error USB host HUB connection error
 (1 time in 1 second)			USB host power supply excessive voltage error (PT-P950NW only) → Connect compatible AC Adapter. Mass storage error
 (1 time in 2 seconds)			Roller holder error → Remove the tape cassette and reinstall it correctly.
 (2 times in 1.8 seconds)			Adapter error
			Option connection error (PT-P950NW only)
			Adapter connection error
			When blinking alternately: Cutter error When blinking simultaneously: High temperature error



























Status, Power, Wi-Fi indicator

 (Status)	 (Power)	 (Wi-Fi)	Condition
 (2 times in 1.8 seconds)			Non-compliant tape error
			Wrong media error → Check that the correct tape cassette is inserted.
 (2 times in 1.8 seconds)	 (2 times in 1.8 seconds)		Communication error Memory full error Number of lines/character size error
 (1 time in 1 second)	 (1 time in 1 second)		When blinking alternately: Database search error When blinking simultaneously: No template error
 (2 times in 1.8 seconds)	 (2 times in 1.8 seconds)		High-resolution/draft printing error → Confirm the conditions of use.
			Black mark not detected error



Battery indicator

 (Battery)	 (Power)	Condition
		Rechargeable battery power: full Charging complete
		Charging
 (1 time in 4 seconds)		Rechargeable battery power: half
 (2 times in 4 seconds)		Rechargeable battery power: low
		Rechargeable battery error
		Rechargeable battery power: empty

Wi-Fi indicator

 (Status)	 (Power)	 (Wi-Fi)	Condition
			No available WPS access point was found
			WPS access point connection error Check the protocol.
		 (2 times in 1.8 seconds)	Incorrect security settings
		 (2 times in 1.8 seconds)	WPS access point search error
			Wi-Fi on, not connected
			Wi-Fi on, connected
			Wi-Fi: WPS setting mode
		 (Three times)	BT switching complete notification (PT-P950NW only)

Indicator Warnings

Problem	Solution
Received data in buffer	<p>Print data is saved in the buffer. If the P-touch Label Printer has not received the complete data, printing will not start.</p> <p>Turn off the P-touch Label Printer, and then turn it on again.</p>
Head is cooling down	<p>The thermal head is too hot.</p> <p>The P-touch Label Printer stops and resumes printing only after the thermal head has cooled down. The head may become too hot if you are printing a large number of labels.</p> <p>When the thermal head becomes too hot, it may produce imaging on the labels in areas not intended to be printed. To avoid or delay overheating, make sure the P-touch Label Printer has adequate ventilation and is not located in an enclosed space.</p> <p>If the P-touch Label Printer must cool down because it overheated due to the type of tape cassette you are using or the contents of the label, printing may take longer than usual.</p> <p> Note</p> <p>This condition may occur more often when the P-touch Label Printer is used at high altitude (more than 10,000 ft (3,048 m)) due to a lower air density available to cool the P-touch Label Printer.</p>
P-touch Label Printer is in boot mode	<p>To resolve the issue, contact your Brother dealer or Brother customer service for assistance.</p>
Errors concerning tape cassettes	<p>Check the following:</p> <ul style="list-style-type: none"> ■ You are using the correct tape cassette. ■ There is enough tape remaining. ■ The tape cassette is installed correctly.
I want to reset an error	<p>I want to reset an error</p> <ol style="list-style-type: none"> 1 Open the top cover, and then close it. 2 If the error is not reset, press the  (Feed&Cut) button. 3 If the error still is not reset, turn off the P-touch Label Printer, and then turn it on again. 4 If the error still is not reset, contact Brother customer service.

P-touch Label Printer Specifications

Model Name	PT-P900W/PT-P950NW
Size	
Dimensions	approx. 4.65" (W) × 7.56" (D) × 5.75" (H) (118 mm (W) × 192 mm (D) × 146 mm (H))
Weight	approx. 3.33 lb (1508 g) (without tape cassette, battery base and batteries)
LED indicators	
Status indicator, Battery indicator, Power indicator, Wi-Fi indicator	
Buttons	
Power button, Feed&Cut button, Wi-Fi button	
Printing	
Method	Thermal Transfer
Print head	454 dot/360 dpi
Print resolution	Standard 360 dpi × 360 dpi High resolution mode: 360 dpi × 720 dpi ¹ High speed mode: 360 dpi × 180 dpi ¹
Printing speed	AC adapter: max. 2.3"/sec. (60 mm/sec.) Battery: 0.78"/sec. - 2.3"/sec. (20 mm/sec. - 60 mm/sec.) (varies depending on the tape cassette and tape width) Actual print speed varies depending on the conditions.
Cassette	<ul style="list-style-type: none"> ■ Brother TZe tape cassette : 0.13" (3.5 mm), 0.23" (6 mm), 0.35" (9 mm), 0.47" (12 mm), 0.70" (18 mm), 0.94" (24 mm), 1.4" (36 mm) widths ■ Brother FLe label cassette : 0.82" (21 mm) × 1.77" (45 mm) ■ Brother HSe tube cassette : 0.23" (5.8 mm), 0.34" (8.8 mm), 0.46" (11.7 mm), 0.69" (17.7 mm), 0.93" (23.6 mm) widths ■ Brother HGe tape cassette: 0.23" (6 mm), 0.35" (9 mm), 0.47" (12 mm), 0.70" (18 mm), 0.94" (24 mm), 1.4" (36 mm) widths
Maximum printing width	1.26" (32.0 mm)
Interface	
USB port	Version 2.0 Full Speed (Peripheral)

Model Name		PT-P900W/PT-P950NW	
Wi-Fi	<ul style="list-style-type: none"> ■ Wireless Direct: IEEE 802.11n ■ Ad-Hoc mode: IEEE 802.11b ■ Infrastructure mode: IEEE 802.11b/g/n ■ WPS 2.0 		
Serial port	RS232C (The serial adapter (optional) is required.)		
USB host (PT-P950NW only)	Supports only barcode scanners		
LAN port (PT-P950NW only)	10BASE-T/100BASE-TX		
Bluetooth (PT-P950NW only)	(The Bluetooth interface (optional) is required.) Bluetooth Ver.2.1+EDR (Class 1) Supported profiles: SPP, OPP		
Power Supply			
Adapter	AC adapter (AD9100ESA): 24 V AC 120 V 60 Hz		
Battery (Optional)	Li-ion Battery (PA-BT-4000LI): 14.4 V		
Auto Power-off	Li-ion Battery (PA-BT-4000LI): 30 min AC adapter (AD9100ESA): None (To change the Auto Power-off setting, see <i>Changing the P-touch Label Printer Settings</i> on page 26.)		
Other			
Cutter	Auto full cutter/auto “crack and peel” cutter		
Environment	Operating temperature/humidity	When running: between 50°F (10°C) and 95°F (35°C) / between 20% and 80% max. wet bulb temperature: 80.6°F (27°C)	

¹ The high resolution mode or high speed mode can be used if the AC adapter is connected and TZe and HGe laminated tape with black ink is installed. You cannot use this function for TZe-FX**1 tape.

- Auto “crack and peel” cutter is available only when using laminated tape.

Operating Environment

Item	Specification	
Operating System	Windows®	Windows Vista® / Windows® 7 / Windows® 8 / Windows® 8.1 / Windows® 10 / Windows Server® 2008 / Windows Server® 2008 R2 / Windows Server® 2012 / Windows Server® 2012 R2
	Mac	OS X v10.9.5 / 10.10.x / 10.11
Standard Interface	Windows®	RS-232C, USB port (USB Spec. 1.1 or 2.0 protocol), 10BASE-T/100BASE-TX Wired Ethernet (only for PT-P950NW)
	Mac	USB port (USB Spec. 1.1 or 2.0 protocol), 10BASE-T/100BASE-TX Wired Ethernet (only for PT-P950NW)
Hard Disk	Windows®	Disk Space : 460 MB or more
	Mac	Disk Space : 500 MB or more
Memory	Windows®	Windows Vista® / Windows Server® 2008 / Windows Server® 2008 R2 / Windows Server® 2012 / Windows Server® 2012 R2: 512 MB or more Windows® 7 / Windows® 8 / Windows® 8.1 / Windows® 10: 1 GB or more (32-bit) or 2 GB or more (64-bit)
	Mac	OS X v10.9.5 / 10.10.x / 10.11: 2 GB or more

The compatible operating systems may change. For the latest information, visit our support website at support.brother.com.

■ Brother support website

Please visit our support website at support.brother.com.

You can find following information:

- Software downloads
- Manuals/Documents
- Frequently Asked Questions (Troubleshooting, Useful tips on using printer)
- Consumable information
- Latest OS compatibility information

The contents of this website are subject to change without notice.

Since some P-touch Editor functions are not available with the P-touch Label Printer, keep the following points in mind when using P-touch Editor to create templates.

You can check a preview of the printed template before the created template is transferred to the P-touch Label Printer. See *Transferring the Template to P-touch Transfer Manager* on page 109 for more information.

Notes on Creating Templates

- The P-touch Label Printer is loaded with three fonts. Some of the text in the template that is transferred to the P-touch Label Printer will be printed using similar fonts and character sizes that are loaded in the P-touch Label Printer. As a result, the printed label may differ from the image of the template created in P-touch Editor.
- Depending on the text object setting, the character size may be automatically reduced or some of the text may not be printed. If this occurs, change the text object setting.
- Although character styles can be applied to individual characters with P-touch Editor, styles can be applied to a block of text only with the P-touch Label Printer. In addition, some character styles are not available on the P-touch Label Printer.
- Backgrounds specified with P-touch Editor are not compatible with the P-touch Label Printer.
- A P-touch Editor layout that uses the split printing function (enlarging the label and printing it on two or more labels) cannot be transferred.
- Only the portion of the label within the printable area is printed.
- Fields that overflow the print area may not be printed completely.

Notes on Transferring Templates

- The printed label may differ from the image that appears in the preview area of P-touch Transfer Manager.
- If a barcode not loaded on the P-touch Label Printer is transferred to the P-touch Label Printer, the barcode will be converted into an image if it is a 2-dimensional barcode. The image of the converted barcode cannot be edited. If the template contains a 1-dimensional barcode that was rotated, an error will occur and the template cannot be transferred.
- All transferred objects that cannot be edited by the P-touch Label Printer are converted into images.
- Grouped objects will be converted into a single bitmap.

Notes on Transferring Data Other Than Templates

- If the number or order of fields in a database is changed and only the database (*.csv file) is transferred to update it, the database may not link correctly with the template. In addition, the first line of data in the transferred file must be recognized by the P-touch Label Printer as "field names".
- Logos, symbols, and graphics downloaded to the P-touch Label Printer will automatically be scaled like the resident font or any of the resident symbol in the library.

Supported Protocols and Security Features

Interface	Wireless	IEEE 802.11b/g/n (Infrastructure Mode) IEEE 802.11b (Ad-Hoc Mode) IEEE 802.11n (Wireless Direct Mode)
	Ethernet (PT-P950NW only)	Ethernet 10BASE-T/100BASE-TX Auto Negotiation
Network (Common)	Protocol (IPv4)	ARP, RARP, BOOTP, DHCP, APIPA (Auto IP), mDNS, WINS, NetBIOS name resolution, DNS Resolver, LPR/LPD, Custom Raw Port/Port9100, FTP Server, TFTP client and server, SNTP client, ICMP, LLMNR responder, SNMPv1/v2c
	Protocol (IPv6)	NDP, RA, DNS Resolver, LPR/LPD, mDNS, Custom Raw Port/Port9100, FTP Server, SNMPv1, TFTP client and server, ICMP, LLMNR responder, SNMPv1/v2c
Network (Security)	Wireless	WEP 64/128 bit, WPA/WPA2-PSK, LEAP, EAP-FAST, PEAP, EAP-TTLS, EAP-TLS

Types of Network Connections and Protocols

You will find basic information about the advanced network features of the P-touch Label Printer, along with general networking and common terms.

The supported protocols and network features differ depending on the model you are using.

Types of Network Connections

Peer-to-Peer printing using TCP/IP

In a Peer-to-Peer environment, each computer directly sends and receives data to each device. There is no central server controlling file access or printer sharing.

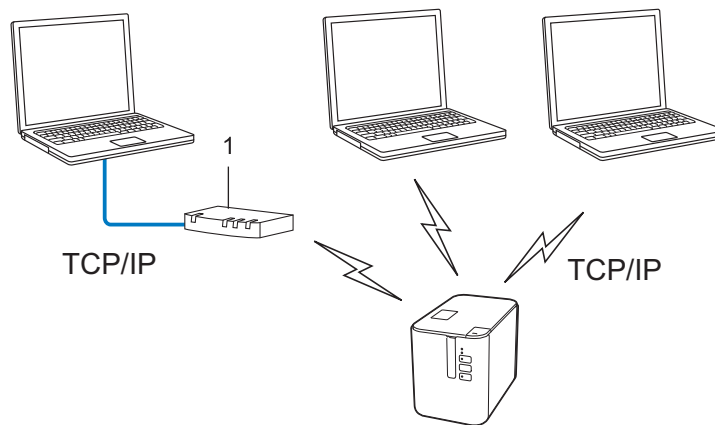

1 Router

- In a smaller network of two or three computers, we recommend the Peer-to-Peer printing method as it is easier to configure than the Network Shared printing method. See *Network Shared printing* on page 176.
- Each computer must use the TCP/IP Protocol.
- Your P-touch Label Printer needs an appropriate IP address configuration.
- If using a router, you must configure the Gateway address on the computers and your P-touch Label Printer.

Network Shared printing

In a Network Shared environment, each computer sends data via a centrally controlled computer. This type of computer is often called a “Server” or a “Print Server”. Its job is to control the printing of all print jobs.

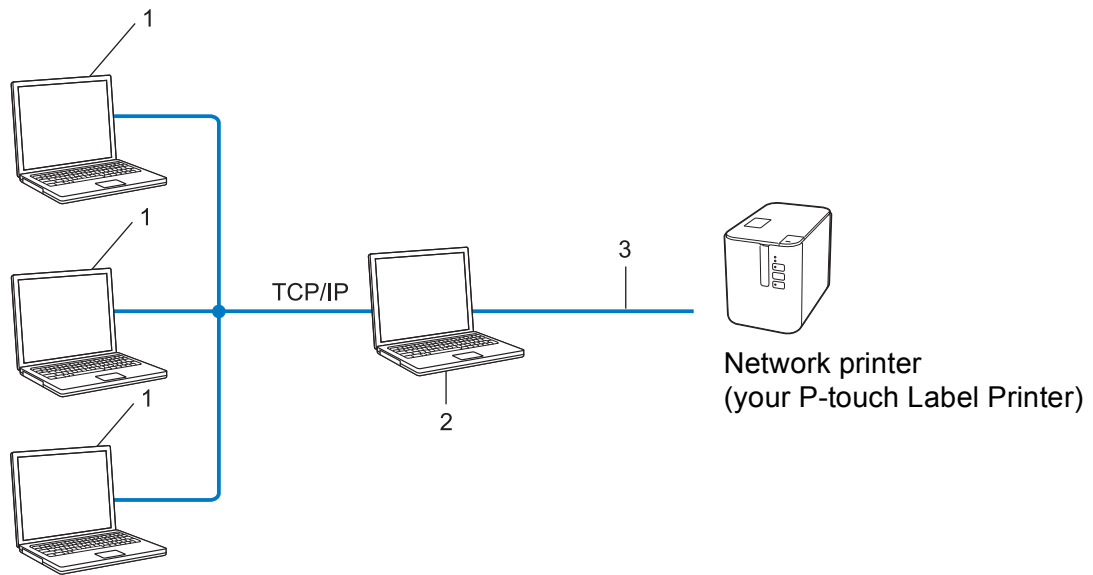

1 Client computers

2 Also known as “Server” or “Print server”

3 TCP/IP or USB

- In a larger network, we recommend using a Network Shared printing environment.
- The “server” or the “print server” must use the TCP/IP print protocol.
- Your P-touch Label Printer needs to have an appropriate IP address configuration, except when the P-touch Label Printer is connected via the USB interface to the server.

Configuring Your P-touch Label Printer for a Network

IP Addresses, Subnet Masks and Gateways

To use the P-touch Label Printer in a networked TCP/IP environment, you must configure its IP address and subnet mask. The IP address you assign to the print server must be on the same logical network as your host computers. If it is not, you must correctly configure the subnet mask and the gateway address.

IP address

An IP address is a series of numbers that identifies each device connected to a network. An IP address consists of four numbers separated by dots. Each number is between 0 and 254.

■ For example in a small network, you would normally change the final number:

- 192.168.1.1
- 192.168.1.2
- 192.168.1.3

How the IP address is assigned to your print server:

If you have a DHCP/BOOTP/RARP server on your network, the print server will automatically obtain its IP address from that server.



Note

On smaller networks, the DHCP server may also be the router.

If you do not have a DHCP/BOOTP/RARP server, the Automatic Private IP Addressing (APIPA) protocol will automatically assign an IP address from the range 169.254.0.1 to 169.254.254.254. The subnet mask is automatically set to 255.255.0.0 and the gateway address is set to 0.0.0.0.

By default, the APIPA protocol is enabled. To disable the APIPA protocol, use BRAdmin Light or Web Based Management (web browser).

Subnet mask

Subnet masks restrict network communication.

- For example, Computer 1 can communicate with to Computer 2

- Computer 1

IP Address: 192.168.1.2

Subnet Mask: 255.255.255.0

- Computer 2

IP Address: 192.168.1.3

Subnet Mask: 255.255.255.0

The 0 in the Subnet mask signifies that there is no limit to communication at this part of the address. In the example above this means that you can communicate with any device with an IP address that begins with 192.168.1.x. (where x is a number between 0 and 254).

Gateway (and router)

A gateway is a network point that acts as an entrance to another network and sends data transmitted via the network to an exact destination. The router knows where to direct data that arrives at the gateway. If a destination is located on an external network, the router transmits data to the external network. If your network communicates with other networks, you may need to configure the Gateway IP address. If you do not know the Gateway IP address contact your network administrator.

Wireless Network Terms and Concepts

Security Terms

Authentication and encryption

Most wireless networks use some kind of security settings. These security settings define the authentication (how the device identifies itself to the network) and encryption (how the data is encrypted as it is sent on the network). **If you do not correctly specify these options when you are configuring your Brother wireless printer, it will not be able to connect to the wireless network.** Make sure you configure these options carefully.

Authentication and Encryption methods for a personal wireless network

A personal wireless network is a small network, for example using your P-touch Label Printer in a wireless network at home, without IEEE 802.1x support.

To use your P-touch Label Printer in an IEEE 802.1x supported wireless network, see *Authentication and Encryption methods for an enterprise wireless network* on page 181.

Authentication methods

■ Open system

Wireless devices are allowed to access the network without any authentication.

■ Shared key

A secret pre-determined key is shared by all devices that will access the wireless network.

The Brother wireless printer uses a WEP key as the pre-determined key.

■ WPA-PSK

Enables a Wi-Fi Protected Access Pre-shared key (WPA-PSK), which enables the Brother wireless printer to associate with access points using TKIP for WPA-PSK.

■ WPA2-PSK

Enables a Wi-Fi Protected Access Pre-shared key (WPA2-PSK), which enables the Brother wireless printer to associate with access points using AES for WPA2-PSK (WPA-Personal).

■ WPA/WPA2-PSK

Enables a Wireless Protected Access Pre-shared key (WPA-PSK/WPA2-PSK), which enables the Brother wireless printer to associate with access points using TKIP for WPA-PSK or AES for WPA-PSK and WPA2-PSK (WPA-Personal).

Encryption methods

■ None

No encryption method is used.

■ WEP

When using WEP (Wired Equivalent Privacy), the data is transmitted and received with a secure key.

■ TKIP

TKIP (Temporal Key Integrity Protocol) provides per-packet key mixing, a message integrity check and rekeying mechanism.

■ AES

Advanced Encryption Standard (AES) provides stronger data protection using a symmetric-key encryption.

When [Communication Mode] is set to [Ad-hoc]

Authentication Method	Encryption Mode
Open System	None
	WEP

When [Communication Mode] is set to [Infrastructure]

Authentication Method	Encryption Mode
Open System	None
	WEP
Public Key Authentication	WEP
WPA-PSK	TKIP
WPA2-PSK	AES
WPA/WPA2-PSK	TKIP
	AES

Network key

■ Open system/Shared key with WEP

This key is a 64-bit or 128-bit value that must be entered in an ASCII or hexadecimal format.

- 64 (40) bit ASCII:
Uses five text characters. For example, “WSLAN” (case-sensitive)
- 64 (40) bit hexadecimal:
Uses 10 digits of hexadecimal data. For example, “71f2234aba”
- 128 (104) bit ASCII:
Uses 13 text characters. For example, “Wirelesscomms” (case-sensitive)
- 128 (104) bit hexadecimal:
Uses 26 digits of hexadecimal data. For example, “71f2234ab56cd709e5412aa2ba”

■ WPA-PSK/WPA2-PSK and TKIP or AES, WPA2 with AES

Uses a Pre-Shared Key (PSK) that is eight or more characters in length, up to a maximum of 63 characters.

Authentication and Encryption methods for an enterprise wireless network

An enterprise wireless network is a large network with IEEE 802.1x support. If you configure your printer in an IEEE 802.1x supported wireless network, you can use the following authentication and encryption methods:

Authentication methods

■ LEAP (For wireless network)

Cisco LEAP (Light Extensible Authentication Protocol) has been developed by Cisco Systems, Inc. and uses a user ID and password for authentication.

■ EAP-FAST

EAP-FAST (Extensible Authentication Protocol-Flexible Authentication via Secured Tunnel) has been developed by Cisco Systems, Inc. and uses a user ID and password for authentication, and symmetric key algorithms to achieve a tunnelled authentication process.

The printer supports the following inner authentication methods:

- EAP-FAST/NONE
- EAP-FAST/MS-CHAPv2
- EAP-FAST/GTC

■ PEAP

PEAP (Protected Extensible Authentication Protocol) has been developed by Microsoft Corporation, Cisco Systems and RSA Security. PEAP creates an encrypted SSL (Secure Sockets Layer)/TLS (Transport Layer Security) tunnel between a client and an authentication server, for sending a user ID and password. PEAP provides mutual authentication between the server and the client.

The printer supports the following inner authentication methods:

- PEAP/MS-CHAPv2
- PEAP/GTC

■ EAP-TTLS

EAP-TTLS (Extensible Authentication Protocol Tunnelled Transport Layer Security) has been developed by Funk Software and Certicom. EAP-TTLS creates a similar encrypt SSL tunnel to PEAP, between a client and an authentication server, for sending a user ID and password. EAP-TTLS provides mutual authentication between the server and the client.

The printer supports the following inner authentication methods:

- EAP-TTLS/CHAP
- EAP-TTLS/MS-CHAP
- EAP-TTLS/MS-CHAPv2
- EAP-TTLS/PAP

■ EAP-TLS

EAP-TLS (Extensible Authentication Protocol Transport Layer Security) requires digital certificate authentication both at a client and an authentication server.

Encryption methods

■ TKIP

TKIP (Temporal Key Integrity Protocol) provides a per-packet key mixing a message integrity check and rekeying mechanism.

■ AES

Advanced Encryption Standard (AES) provides stronger data protection using a symmetric-key encryption.

■ CKIP

The original Key Integrity Protocol for LEAP by Cisco Systems, Inc.

When [Communication Mode] is set to [Infrastructure]

Authentication Method	Encryption Mode
LEAP	CKIP
EAP-FAST/NONE	TKIP
	AES
EAP-FAST/MS-CHAPv2	TKIP
	AES
EAP-FAST/GTC	TKIP
	AES
PEAP/MS-CHAPv2	TKIP
	AES
PEAP/GTC	TKIP
	AES
EAP-TTLS/CHAP	TKIP
	AES
EAP-TTLS/MS-CHAP	TKIP
	AES
EAP-TTLS/MS-CHAPv2	TKIP
	AES
EAP-TTLS/PAP	TKIP
	AES
EAP-TLS	TKIP
	AES

User ID and password

The following security methods support a user ID less than 64 characters and a password less than 32 characters in length:

■ LEAP

■ EAP-FAST

- PEAP
- EAP-TTLS
- EAP-TLS (For user ID)

General Procedure for the P-touch Template Function

The general procedure for using the P-touch Template function is described below.

For more information on specifying the various settings, see *Printing Labels Using P-touch Template* on page 66.

Before connecting the barcode scanner to this P-touch Label Printer, be sure that the barcode scanner settings match the settings in the P-touch Template Settings tool that is specified during preparation. For more information, see *Preparation* on page 67.

- 1 Use P-touch Editor to create a template and then transfer it to the P-touch Label Printer.
- 2 Connect the barcode scanner to the P-touch Label Printer.
- 3 Scan the “P-touch template command” barcode.
This allows the settings to be specified or clears the previous settings.
- 4 Scan the “Basic settings” barcode.
Specify the number of copies.
- 5 Specify the appropriate settings (A, B, or C).

A. Standard Template Printing

- 1 Scan the “Preset template number” barcode.

B. Advanced Template Printing

- 1 Scan the “Select template” barcode, and then scan the barcodes under “For entering numbers”.
- 2 Scan the barcode whose data you want to use or copy.
- 3 Scan the “Begin printing” barcode.

C. Database Lookup Printing

- 1 Scan the “Select template” barcode, and then scan the barcodes under “For entering numbers”.
- 2 Scan the key barcode for the database data.
- 3 Scan the “Delimiter” barcode.
- 4 Scan the “Begin printing” barcode.

- 6 The specified label is printed.

List of Barcodes for Specifying Settings

These are the barcodes for specifying settings used in *Printing Labels Using P-touch Template* on page 66.



Note

- When using the barcodes in this list, set “Trigger for P-touch Template Printing” and “Command Prefix Character” to the factory settings in the P-touch Template Settings tool.
- When printing barcodes that will be scanned for printing labels, print the barcodes at a high resolution.
- It is possible that these sample barcodes may not be read correctly, depending on the quality of your printout.

■ P-touch template command (initialize + begin specifying settings)



■ Basic settings

Auto cut on



Auto cut off



Half cut on



Half cut off



Chain printing on



Chain printing off



Mirror printing on



Mirror printing off



Number of copies



■ For entering numbers ¹



■ Preset template number

Preset template 1



Preset template 2



Preset template 3



Preset template 4



Preset template 5



Preset template 7



Preset template 9



Preset template 6



Preset template 8



Preset template 10



■ Select template



■ Number of serialized copies



■ Delimiter



■ Initialize template data



■ Begin printing



¹ These are used when specifying the number of copies printed and when selecting a template number. Scan barcodes to specify a three-digit number, such as [0][0][7] or [0][1][5]. The setting is automatically applied when three digits have been specified. To change settings, scan the “Number of copies” barcode again when changing the number of copies or scan the “Select template” barcode again when changing the template number, and then scan the barcodes for the new three-digit number.

Using the Rechargeable Li-ion Battery/Battery Base (Optional: PA-BT-4000LI/PA-BB-002)

This P-touch Label Printer can be powered by the AC adapter (included) or the rechargeable Li-ion battery (optional: PA-BT-4000LI). Use the power source appropriate for your intended use.

With the rechargeable Li-ion battery installed, you can use the P-touch Label Printer in locations that do not have AC power.

The battery is recharged by the AC adapter when the battery and the battery base are attached to the P-touch Label Printer.

Installing the Rechargeable Li-ion Battery

- 1 Disconnect the AC adapter and then attach the battery base (optional: PA-BB-002) onto the P-touch Label Printer. For more information about attaching the battery base, see its instruction manual.
- 2 Open the battery cover on the bottom of the P-touch Label Printer.

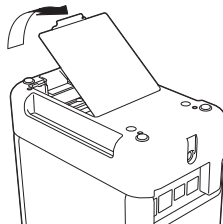

- 3 Insert the battery into the battery compartment.

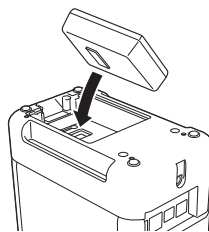

- 4 Close the battery cover.

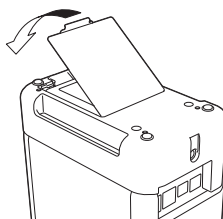

Note

The voltage supplied by the rechargeable Li-ion battery fluctuates. The printing speed may also fluctuate depending on the voltage.

Removing the Rechargeable Li-ion Battery

Press and hold the  (Power) button to turn off the P-touch Label Printer.

Remove the battery cover and the battery, and then reattach the battery cover.

CAUTION

If it is difficult to remove the rechargeable battery, turning the P-touch Label Printer over with the battery cover removed may allow the rechargeable battery to fall out.

Be careful that this does not cause any injuries.

Charging the Rechargeable Li-ion Battery





Note

- Before use, fully charge the battery.
- Up to three hours may be needed to fully charge the battery.



1 Make sure the battery is installed in the P-touch Label Printer.



2 Use the AC adapter and power supply cord to connect the P-touch Label Printer to an AC power outlet. Press the  (Power) button to turn on the P-touch Label Printer if it is not on already. The  (Battery) indicator lights in orange during charging, and it goes off when the battery is fully charged.

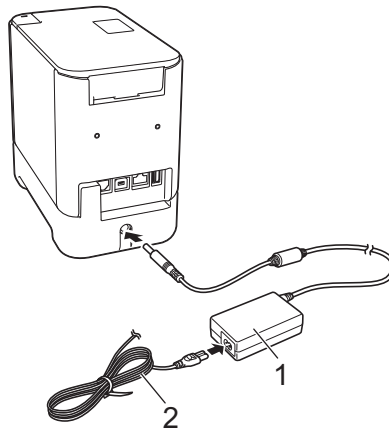

1 AC adapter

2 Power supply cord





Note

- Even if the P-touch Label Printer is turned off during charging, the charging will continue until the battery is fully charged.
- If the P-touch Label Printer is turned on with the rechargeable Li-ion battery installed and the AC adapter is connected to an AC power outlet, the battery will be recharged. However, when the P-touch Label Printer is turned on, even after the rechargeable battery has been charged, the battery charge will be used, leaving the battery with less than a full charge the next time the P-touch Label Printer is used. We recommend leaving the P-touch Label Printer turned off while charging the battery.
- Although the charging stops if the P-touch Label Printer is used to print, feed, or perform another operation, the charging will start again automatically after the operation is finished if the charging is not completed.

Stopping Rechargeable Li-ion Battery Charging

To stop the battery charging, disconnect the AC adapter.

Notes on Using the Rechargeable Li-ion Battery

- Before use, fully charge the battery. Do not use it until it is fully charged.
- The battery charging must take place in environments between 32°F and 104°F (0°C and 40°C), otherwise the battery will not charge, and the  (Battery) indicator will remain lit. If the charging stops because the environment temperature is too low or too high, place the P-touch Label Printer with a temperature between 32°F and 104°F (0°C and 40°C) and try charging again.
- If the P-touch Label Printer is used to print, feed, or perform another operation when both the battery is installed and the AC adapter is connected, the  (Battery) indicator may turn off and charging may stop even if the battery is not fully charged.

Rechargeable Li-ion Battery Characteristics

To ensure the highest performance and longest life from the battery:

- Do not use or store the battery in a location exposed to extreme high or low temperatures as it may discharge more quickly. This may happen when using a rechargeable Li-ion battery with a high charge (90% charged or more) in a location exposed to high temperatures.
- Remove the battery when storing the P-touch Label Printer for long periods of time.
- Store a battery with less than a 50% charge in a cool dry place out of direct sunlight.
- Recharge the battery every six months if it is stored for long periods of time.
- If you touch a part of the P-touch Label Printer while the Li-ion battery is charging, that part of the P-touch Label Printer may feel warm. This is normal, and the P-touch Label Printer may be used safely. However, if the P-touch Label Printer becomes extremely hot, discontinue use.

Product Specifications

Rechargeable Li-ion Battery

Size: approx. 2.92" (W) x 3.39" (D) x 1.26" (H) (74 mm (W) x 86 mm (D) x 32 mm (H))

Weight: approx. 0.53 lb (0.240 kg)

Voltage: 14.4 V

Capacity: 1800 mAh

Charging/discharging cycle: approx. 300 times

Charging time: approx. three hours

Battery Base

Size: approx. 4.65" (W) x 7.56" (D) x 3.07" (H)(118 mm (W) x 192 mm (D) x 78 mm(H))

Weight: approx. 0.73 lb (0.332 kg)

Charging current: 1000 mA

Charging voltage: 16.4 V

Using the Touch Panel Display (Optional: PA-TDU-003) (PT-P950NW Only)

The (optional: PA-TDU-003) touch panel display (TDU) is a touch panel operating keyboard and LCD display designed to be integrated with the P-touch Label Printer.

Because touch panel keys can be pressed to perform operations, labels can be printed and various settings can be specified without a computer connection.

For more information on attaching the touch panel display, refer to its *Quick Setup Guide*.

General Description

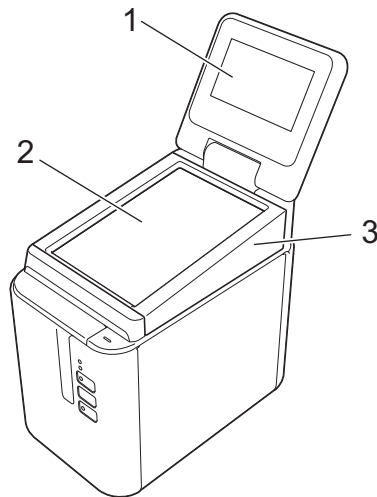

1 LCD



Note

A protective clear plastic sticker is placed over the LCD during manufacturing and shipping. We recommend removing this sticker prior to use.

2 Touch panel

3 TDU panel cover

LCD

Lift the LCD, and then adjust it to an angle so that the screens are visible. If the screens are dark and hard to read, the backlight can be turned on. For more information, see *Specifying Settings From the Touch Panel Display* on page 201.

Main Screen

When the P-touch Label Printer is turned on, the main screen appears.

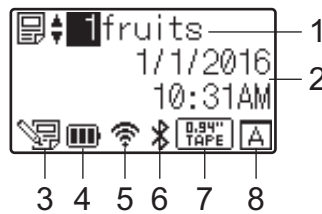

1 Template name and number

Displays the number and name of the selected template.

2 Time and date

Displays the current time and date. For more information on setting the clock, see *Setting the Time and Date* on page 203.

3 Template editing indicator

 appears when you are editing a template using the touch panel display.

4 Battery level display

Indicates the remaining charge when the optional rechargeable Li-ion battery is in use.

If you continue to use the P-touch Label Printer while the battery has a low charge, the message “Battery Empty” appears, and the P-touch Label Printer may run out of power, even while printing.

: Full charge





: Half

: Low charge

: Empty

: Charging

5 Wireless LAN indicator

Indicates the status of the Wireless LAN connection using four levels (, , , ). ( appears when there is no connection.)

6 Bluetooth indicator

 appears when the printer is connected using Bluetooth.

7 Tape type display

Indicates the type of tape installed in the printer.

8 Touch panel setting

Displays whether the touch panel display has been set for touch panel A or B.

 : Basic control panel (A)

 : One-touch panel (B)

Touch Panel

There are two touch panel screens: the basic control panel (A) and the one-touch panel (B). Either can be selected for use.

Press a key on the touch panel screen to perform an operation.

If a label layout has been assigned in advance to a key on the one-touch panel, you can print a label by pressing the key of the corresponding label.

! Important

Do not press on the touch panel with a sharp object. Otherwise, the touch panel may be damaged.

Basic control panel (A)

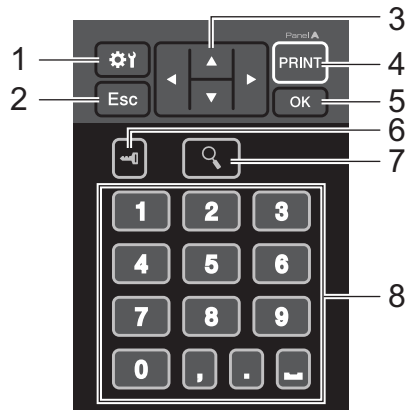

One-touch panel (B)

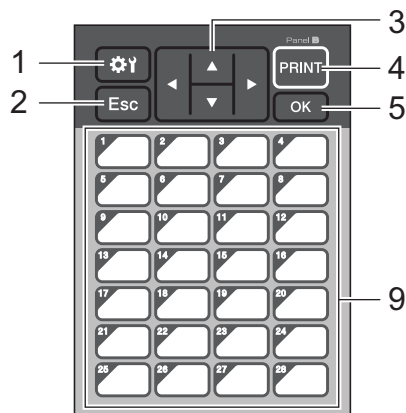

1 ⚙️ (settings key)

Allows you to specify settings for the various parameters.

2 Esc (escape key)

Returns to the previous operation. Holding down this key for at least one second returns to the main screen.

3 ▲/▼/◀/▶

Changes what is displayed, or increases/decreases values. Holding down this key quickly changes what is displayed or increases/decreases values by 10.

4 PRINT key

Print the label.

5 OK key

Applies the operation or setting.

6  (admin key)

Specify basic settings for using the touch panel display.

7  (search key)

Displays the contents of the selected template. The contents of the database linked to the template can also be checked.

8 Numeric keys

Type in the template number or database record number. These can also be used to edit values in the label layout.

9 One-touch keys

Select the label to be printed.



Note

The touch panel name (A or B) is printed in the upper-right corner of the touch panel. Make sure that the specified touch panel name, which appears in the main screen on the LCD, matches the name of the touch panel you are using.

Replacing the Touch Panel

- 1 Lift the LCD.
- 2 Press the cover open button and lift the tape compartment cover to open it.

- 3 The TDU panel cover is attached with four tabs. Use your fingernails or a slotted screwdriver to push the four tabs outwards as shown in the illustration and remove the TDU panel cover.

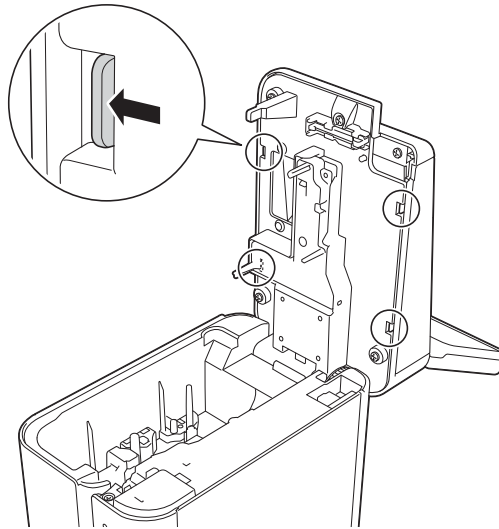

- 4 Place the touch panel (1) you want, and then the clear protective sheet (2) on the touch panel holder (3).

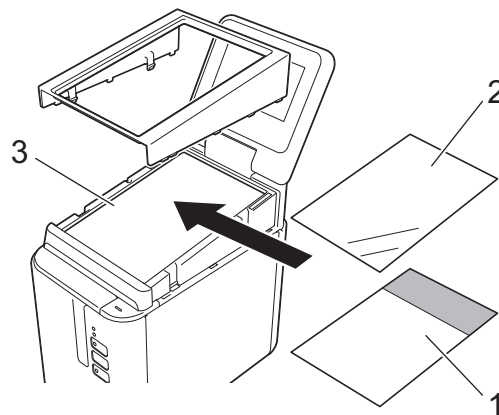

! Important

Because foreign material, such as dust caught between the touch panel, protective sheet and touch panel holder may cause a malfunction, make sure no foreign material is present.

- 5 Install the four tabs on the TDU panel cover into the slots as shown in the illustration until the tabs are locked into place.

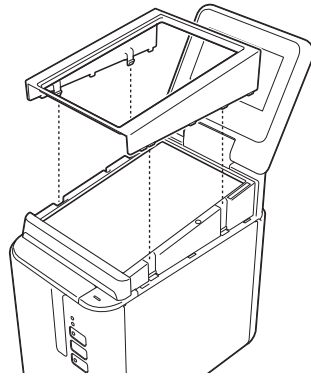

! Important

When the touch panel is replaced, the setting for the touch panel display must be changed. For more information, see *Selecting the Touch Panel* on page 213.

Printing With the Touch Panel Display

Follow the procedure below to print using the touch panel display.

1. Preparation

Connect the P-touch Label Printer to the computer, and then install the printer driver and software. (See *Installing the Printer Driver and Software* on page 8)

Install media in the P-touch Label Printer. (See *Inserting a Tape Cassette* on page 5)

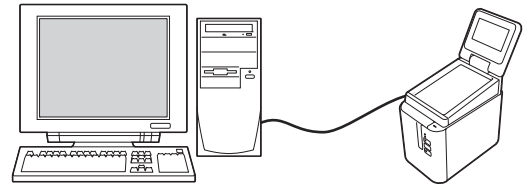

2. Design a label.

From the computer, use P-touch Editor to create a template or layout. (page 205)

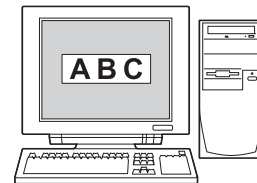

3. Transfer the label layout to the P-touch Label Printer.

Use P-touch Transfer Manager to transfer the template or layout from the computer into the P-touch Label Printer. (page 211)

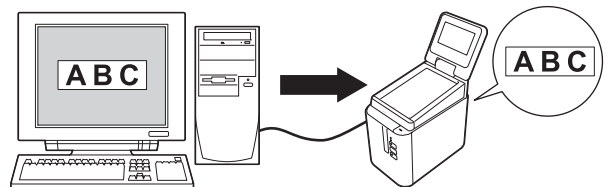

4. Print the label.

Use the touch panel of the touch panel display to print the label. (page 216)

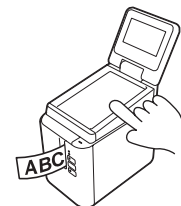

Touch Panel Display Settings

The settings for the touch panel display can be specified using the touch panel or the Printer Setting Tool on a computer connected to the P-touch Label Printer. For more information on connecting a computer and specifying settings, see *Device Settings for Windows*® on page 44.

Specifying Settings From the Touch Panel Display

Press [⚙️] (settings key) or [⏏️] (admin key) to display the menu screen. Press [▲] or [▼] to select a parameter, and then press [OK].

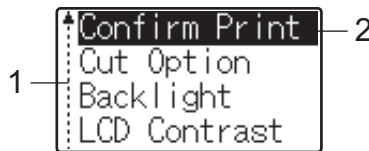



- 1 The scroll bar indicates the first parameter with the up arrow, and the last parameter with the down arrow. If the last parameter is selected, pressing [▼] scrolls to the first parameter. If the first parameter is selected, pressing [▲] scrolls to the last parameter.
- 2 The currently selected parameter is highlighted.

With the touch panel display attached to the P-touch Label Printer, the following settings can be specified:

Key	Parameter		Settings	Description
⚙️ (settings key)	Confirm Print		On/Off	Select whether a message appears before printing, allowing you to confirm the number of copies.
	Cut Option		FullCut/HalfCut/Chain	Select a cut method when printing.
	Backlight		On/Off	Select whether the LCD backlight is turned on.
	LCD Contrast		+2/+1/0/-1/-2	Set the LCD contrast.
	Beeper		On/Off	Select whether the P-touch Label Printer beeps when you press a touch panel key.
	Set Panel		A/B	Select which touch panel you want to use.
⏏️ (admin key) ¹	Setup	Keys Function	Template/ Database	Select the type of data assigned to keys on the one-touch panel. To assign templates, select [Template]. To assign databases linked to a single template, select [Database].
		Serialize Mode	Cont From Last/From Starting#	Select whether to serialize from the last number printed.
		Default Print#	1-999	Set the default number of copies that appears when printing.
		Set Clock	Default: 2013/01/01 <24> 00:00	Set the time and date for the touch panel display.

Key	Parameter		Settings	Description
☰ (admin key) ¹ (Continued)	Setup (Continued)	Time&Date Form	Date Format: 1/31/2099,01/31/2099, 31/1/2099,31/01/2099, 31.1.2099,31.01.2099, 31-1-2099,31-01-2099, 2099/1/31,2099/01/31, 2099-1-31,2099-01-31	Select the date format for the clock.
			Time Format: 01:59 (24), 1:59 (24), 1:59AM, 01:59AM	Select the time format for the clock.
		FLanguage	Dansk/Deutsch/English/ Español/Français/ Italiano/Nederlands/ Norsk/Português/Suomi/ Svenska/日本語	Select the language of the touch panel display.
		Unit	inch/mm	Select the measurement units for displayed settings.
		Print#	From Starting#/Cont From Last	Select whether the number of copies set from the TDU remains set after the copies are printed. This TDU setting is applied until the P-touch Label Printer is turned off.
		DB search	By Line#/By Data	When using a template with a linked database, select whether to search for database records by their line number or by their data.
	Security	Disable Edit	On/Off	Select whether or not label layouts can be edited.
		Lock Settings	On/Off	Allow or disable setting changes for [⚙️] (settings key).
		Admin Password	On/Off	Set password access for [☰] (admin key).
	Enter Password: **** (4 digits)		Type in the 4-digit password.	
	Configuration		Printer/ProgVer/ FontVer/Memory/PrnDis t/PrnCt/FCutCnt/HCutC nt	Displays the model name, firmware version, font version and amount of built-in memory, and similar information.

Key	Parameter		Settings	Description
 (admin key) ¹ (Continued)	Network	LAN	IP Address/Subnet Mask/Gateway	Displays the network settings.
		WLAN	IP Address/Subnet Mask/Gateway/ Status/Signal/Channel/ SSID/Comm. Mode/Infrastructure Mode	
		Wdirect	Device Name/SSID/IP Address/Password/Stat us/Signal/Channel/Wire lessDirect Mode	

¹  (admin key) can be accessed only when touch panel A (basic control panel) is set.









Note

- Some settings may differ depending on the firmware (printer software).
- To reset the settings, use **[Device settings]** in the Printer Setting Tool to return all settings to factory settings. For more information, see *Device Settings for Windows*[®] on page 44.

Setting the Time and Date

Adjust the clock to the current time and date displayed on the main screen.

- 1 Press  (admin key).
- 2 Press , select [Setup], and then press [OK].
- 3 Press , select [Set Clock], and then press [OK]. The clock setting screen appears.
- 4 Press the number keys to specify the last two digits of the year, two digits for the month and two digits for the day.
For December 1, 2016, press [1] [6] [1] [2] [0] [1].
- 5 Press  or  to select AM, PM or 24, and then press the number keys to specify two digits each for the hour and minutes.
To enter 2:45 in the AM/PM format, press  to select [PM], and then press , then [0] [2] [4] [5].
- 6 Press [OK]. The main screen appears, and the specified time and date are displayed.



Note

The format for the time and date can be changed: Press  (admin key), select [Setup], then [Time&Date Form] from the parameters, and then specify settings for [Date Format] and [Time Format].

Setting the Administrator Password

A password can be set so that basic settings specified by pressing [↵] (admin key) cannot be accessed easily. If a password is set, each time [↵] (admin key) is pressed, a password must be entered. Access to these parameters can be restricted by setting a password.

- 1 Press [↵] (admin key).
- 2 Press [▼], select [Security], and then press [OK].
- 3 Press [▼], select [Admin Password], and then press [OK].
- 4 Press [▼], select [On], and then press [OK].
The password input screen appears.
- 5 Type in the 4-digit password, and then press [OK].
The password is set.



Note

- This parameter can be accessed only when touch panel A (basic control panel) is set.
- After a password has been set, the password input screen appears when [↵] (admin key) is pressed. Type in the specified 4-digit password, and then press [OK].
- To cancel the password settings, press [↵] (admin key), type in the password to display the parameters, and then set [Admin Password] to [Off].
- If you do not remember the password, use [Device settings] in the Printer Setting Tool to return all settings to factory settings or specify the password again and apply it. For more information, see *Device Settings for Windows*® on page 44.

Creating a Label Layout (Windows® Only)

From the computer, use P-touch Editor to create a template or layout. For more information on use, see *How to Use P-touch Editor* on page 101.

Creating a Template

- Label sample

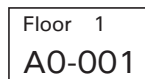

- 1 Start the P-touch Editor.

- **For Windows Vista® / Windows® 7 / Windows Server® 2008 / Windows Server® 2008 R2:**

From the Start button, click **[All Programs]-[Brother P-touch]-[P-touch Editor 5.1]**, or double-click **[P-touch Editor 5.1]** shortcut icon on the desktop.

When P-touch Editor starts, select whether you want to create a new layout or open an existing layout.

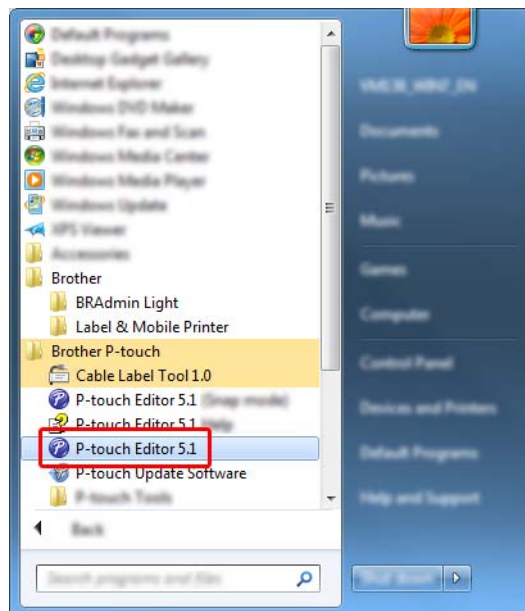

- **For Windows® 8/ Windows® 8.1 / Windows Server® 2012 / Windows Server® 2012 R2:**

Click **[P-touch Editor 5.1]** on the **[Apps]** screen or double-click **[P-touch Editor 5.1]** on the desktop. When P-touch Editor starts, select whether you want to create a new layout or open an existing layout.

- **For Windows® 10:**

From the Start button, select **[All apps]** and click **[P-touch Editor 5.1]** under **[Brother P-touch]**, or double-click **[P-touch Editor 5.1]** on the desktop.

When P-touch Editor starts, select whether you want to create a new layout or open an existing layout.

- When the **[New/Open]** dialog box appears, select the various options to set the P-touch Label Printer to be used and the size of label to be created.
- Click **[Paper]** (1), and then specify the media and length (2). (This window appears in **[Express]** mode.)

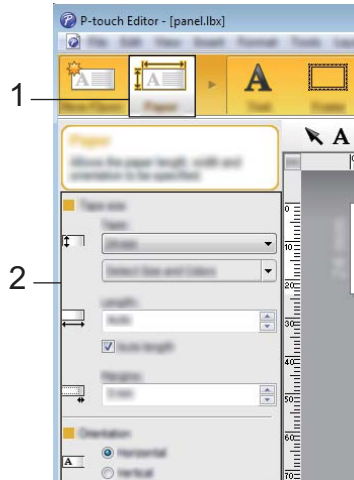

- Click **[Text]** (1), and then specify the font and style (2).

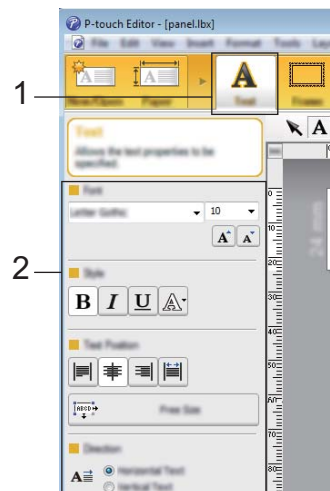

- Clicking **A** displays the cursor so text can be typed in.

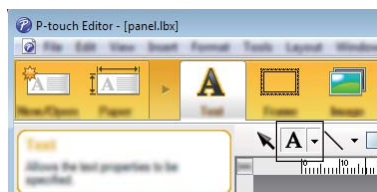

- After inserting the text, click the text box to move it within the template.

- Repeat steps 5 and 6 to type text and arrange the layout.
After entering text, click **[File]** - **[Save as]** on the menu bar, and then specify the file name for saving the data.



Note

The first ten characters of the file name appear on the LCD as the template name when you use the touch panel display.

Setting the Text and Order for Displaying on the LCD

Use P-touch Editor to set the order of the displayed text on the LCD.

- In P-touch Editor, open the template or layout you want to edit.
- Select the text box for text to appear on the LCD, right-click it, and then click **[Properties]** to display the **[Text Properties]** dialog box. In the **[Object Name]** box on the **[Expanded]** tab, set the number you want (for example, "Text1", "Text2" or "Text3"). The text will appear on the LCD in the order of the set numbers. To prevent the text from appearing on the LCD, select the **[Text Cannot Be Edited]** check box on the **[Expanded]** tab.

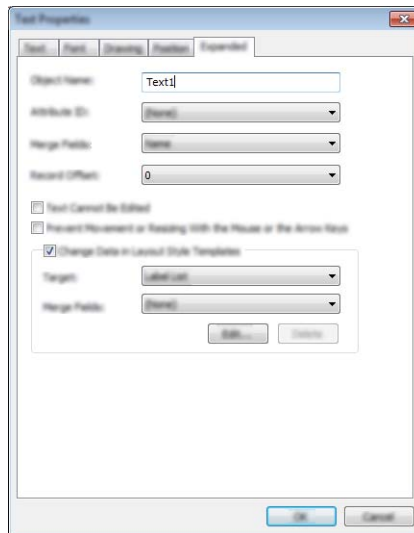

Inserting the Date and Time in a Label

- 1 In P-touch Editor, open the template or layout you want to edit.
- 2 On the menu bar, click **[Insert] - [Date/Time]** to display the **[Date and Time Properties]** dialog box. Select settings for the format of the text you want to insert.

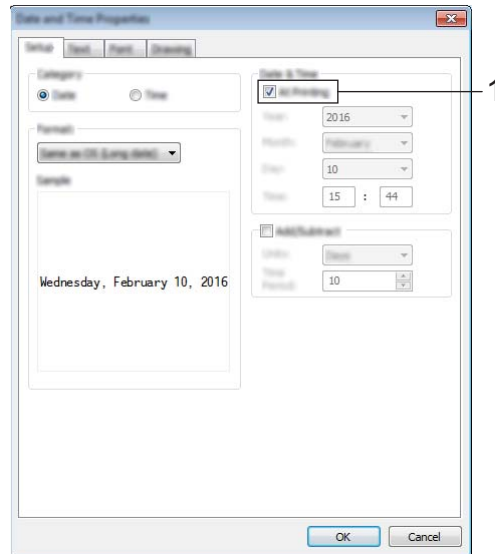

! Important

- If the **[At Printing]** check box (1) is selected, the date and time of printing will be inserted. If the check box is cleared, the current date and time will be inserted and will not be updated.
- The date and time inserted into the label will be printed in the printer's built-in character size. Because the character size is determined by the size of the date and time object, adjust the object to the size you want in P-touch Editor before transferring the label layout to the P-touch Label Printer.

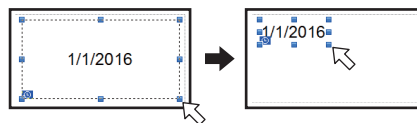

Linking a Database to a Template

■ Label sample

Floor 1	Floor 1	Floor 2
A0-001	A0-002	D0-011

A database can be linked to the template that was created. Because the text in the template can be replaced with text from the database, multiple labels can be printed simply by creating a single template.

For more information on specifying database settings, see **[P-touch Editor Help]**.

- 1 Prepare a database file in advance.

Note

- Files saved as XLS, MDB, CSV and TXT formats can be used as databases.
- To use files in the XLSX or ACCDB format, Microsoft® Office 2007, 32-bit Microsoft® Office 2010, 2007 Office System Driver: Data Connectivity Components, or 32-bit 2010 Office System Driver: Data Connectivity Components must be installed.
- Only one database can be linked to a single template. A maximum of 65,000 records can be created in that database. (The total size of templates and databases is limited to 6 MB.)
- The data entered in the database can be displayed on the LCD. Only the first 13 characters can be displayed.

- 2 In P-touch Editor, open the template that will be linked to the database.

- 3 On the menu bar, click **[File] - [Database] - [Connect]** to display the **[Open Database]** dialog box. Select **[Connect Database File]**, click **[Browse]**, and then select the database you want to link.

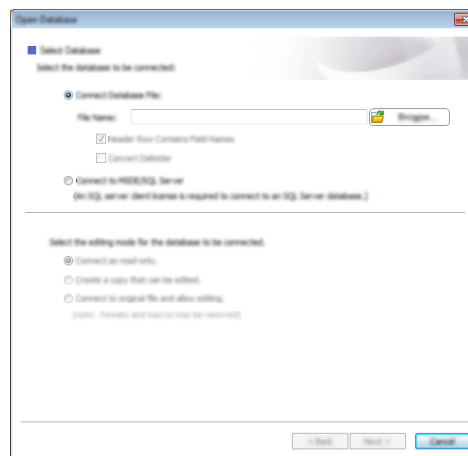

- 4 Click **[Next]** to display a settings dialog box. With **[Database Field]** under **[Merge Fields]**, specify which database column will be linked to which object, and then click **[OK]**.

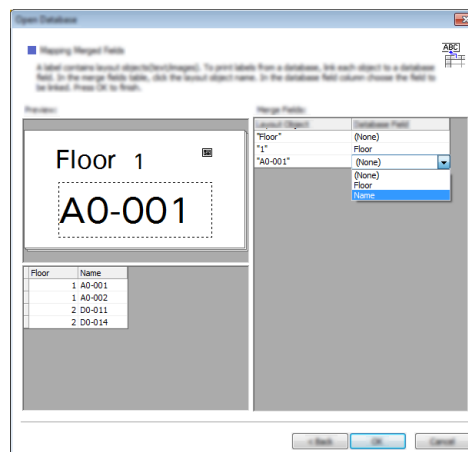

- 5 The template and database are linked, and the main window appears. Click the database row you want to check to display the label with the text replaced.

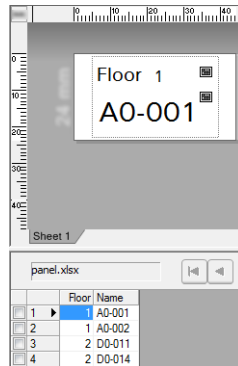

Transferring the Label Layout to the P-touch Label Printer

By transferring the created label layout from a computer to the P-touch Label Printer, you can use the touch panel display to print as many labels as required.

Use P-touch Transfer Manager to transfer data. For more information, see *How to Use P-touch Transfer Manager and P-touch Library (Windows® Only)* on page 109.

! Important

Before transferring data, make sure that the main screen appears on the LCD.

- 1 Connect the P-touch Label Printer to the computer with a USB cable, and then turn on the P-touch Label Printer.
- 2 In P-touch Editor, open the label layout you want to transfer, and then click **[File] - [Transfer Template] - [Transfer]**.

Note

- If **[Transfer Template]** cannot be selected in P-touch Editor, make sure that the layout window in P-touch Editor is the active window.
- **For Windows Vista® / Windows® 7 / Windows Server® 2008 / Windows Server® 2008 R2:** From the Start button, click **[All Programs]-[Brother P-touch]-[P-touch Tools]-[P-touch Transfer Manager 2.2]**.
- **For Windows® 8 / Windows® 8.1 / Windows Server® 2012 / Windows Server® 2012 R2:** Click **[P-touch Transfer Manager 2.2]** on the **[Apps]** screen.
- **For Windows® 10:**
From the Start button, select **[All apps]**, and then click **[P-touch Transfer Manager 2.2]** under **[Brother P-touch]**.

- 3 Select this P-touch Label Printer from the **[Printer]** list. Right-click **[Configurations]**, click **[New]**, and then create a new folder with the name you want. (In this example, the folder **[Switch Label]** is created.) Click **[Configurations]** or **[All contents]**, and then drag the data you want to transfer to the **[Switch Label]** folder.

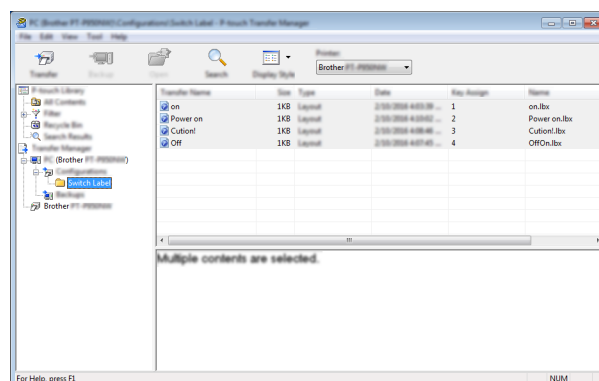

- 4 A key number (number of the template to be registered on the P-touch Label Printer) is assigned to the file in the **[Switch Label]** folder. To change the number, right-click the file, click **[Key Assign]**, and then select a number between 1 and 99.

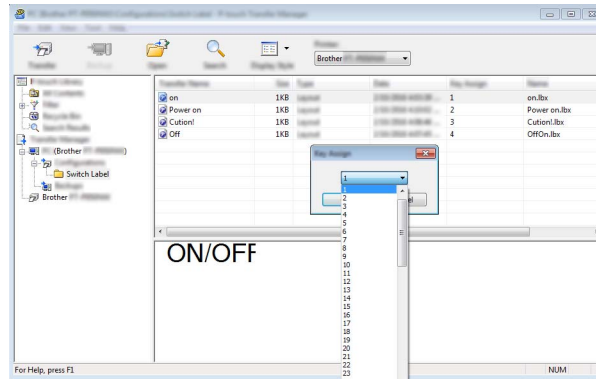

The data registered with keys 1 to 28 (1) of the one-touch panel is determined by the key number.

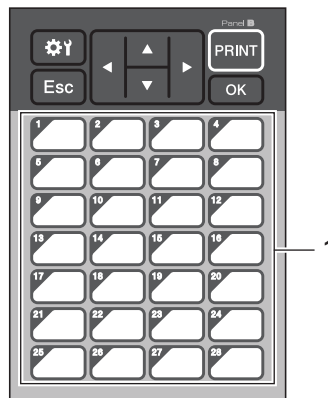

! Important

If using the one-touch panel, specify the number before transferring the data.

- If templates are assigned to one-touch keys:
Templates with key numbers 1 to 28 are registered with the one-touch key of the same number.
- If databases are assigned to one-touch keys:
When a template with a linked database is selected, databases with numbers 1 to 28 are registered with the one-touch key of the same number.

For more information on checking a database assigned to a one-touch key, see *If a Template With a Linked Database Is Registered with a One-Touch Key* on page 219.

For more information on specifying the data assigned to one-touch keys, see *Selecting the Data Assigned to Keys on the One-Touch Panel* on page 214.

- 5 Select the **[Switch Label]** folder, and then click **[Transfer]**. If a confirmation message appears, click **[OK]**. Transferring begins.



Note

- Up to 99 templates can be registered with this P-touch Label Printer.
- If a new template is transferred with the same key number as another template already registered on the P-touch Label Printer, the new template will overwrite the old one.

Selecting the Touch Panel

Two touch panels, basic control panel (A) and one-touch panel (B) can be selected for the touch panel display.

If the one-touch panel (B) will be used, the data to be assigned to the one-touch panel keys must be specified. For more information on specifying the settings, see *Selecting the Data Assigned to Keys on the One-Touch Panel* on page 214.

- 1 Press **[⚙]** (settings key).
- 2 Press **[▼]**, select **[Set Panel]**, and then press **[OK]**.
- 3 Press **[▲]** or **[▼]**, select **[A]** or **[B]**, and then press **[OK]**.
- 4 Follow the on-screen instructions to replace the touch panel. (For more information on replacing it, see *Replacing the Touch Panel* on page 197.)
- 5 Make sure that the specified touch panel name shown on the screen matches the name of the touch panel you are using, and then press **[PRINT]**.

Selecting the Data Assigned to Keys on the One-Touch Panel

You can specify the type of data assigned to one-touch keys when using the one-touch panel with the touch panel display. The type of data can be either templates or databases.

- Sample label layout registered in the P-touch Label Printer:

▪ Template No.1 (panel.lbx)

Floor 1
A0-001

Database

No.	Floor	Name
1	1	A0-001
2	1	A0-002
3	2	D0-011
4	2	D0-014

▪ Template No.2 (sign.lbx)

⚠ CAUTION

Database

No.	SIGN
1	CAUTION
2	DANGER
3	HIGH TEMPERATURE
4	BOILED WATER

▪ Template No.3 (on.lbx)

ON/OFF

- If [Template] was set, starting with template number 1, templates are registered with the one-touch key of the same number.

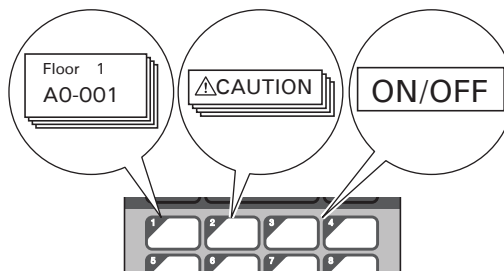

- If [Database] was set, starting with database number 1, the databases of the selected template are registered with the one-touch key of the same number. (The illustration shows when template number 1 is selected.)

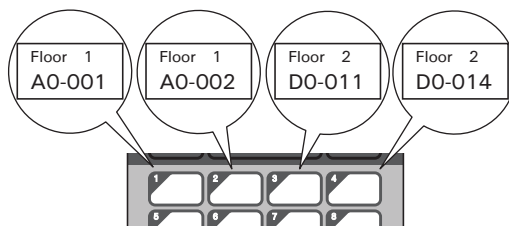

- 1 Press [Admin] (admin key).
- 2 Select [Setup], and then press [OK].
- 3 Select [Keys Function], and then press [OK].
- 4 Press [▲] or [▼], select [Template] or [Database], and then press [OK].

Creating a One-Touch Panel

To create a one-touch panel, use one of the following methods:

- Using stickers or in handwriting, note the names of keys directly on the included one-touch panel.
- The actual panel figure can be found on the last page before the back cover in *Quick Setup Guide* of Touch Panel Display. This figure can be used by copying it onto plain paper.
Panel size: 5.213" (length) x 3.634" (width) (132.4 mm (length) x 92.3 mm (width))
- A panel format can be downloaded from the Brother Solutions Center at support.brother.com
[Select your region/country.] - [Downloads] - [Choose your product]
This can be used by typing in the key names, then printing out the data on plain paper.

Printing the Label

You can use the touch panel display to print or edit a label layout transferred to the P-touch Label Printer, without a computer connection.

Printing Using the Basic Control Panel

- 1 Turn on the P-touch Label Printer. The main screen appears.

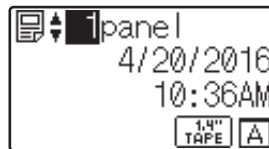

- 2 Press [▲] or [▼] to select the number of the template you want to print, or press the number keys to type in the number, and then press [OK]. Press [Q] (search key) to display the template details on the screen.



- 1 Template number
- 2 Text in template
- 3 Paper size
- 4 Database record number (only if a database is linked)

Note

- To check all of the text in the template, press [◀] or [▶].
- You can set the text displayed on the LCD and its display order using P-touch Editor. For more information, see *Setting the Text and Order for Displaying on the LCD* on page 207.

- 3 If a database is linked:
Press [▲] or [▼] to select the number of the database record you want to print, or press the number keys to type in the number, and then press [OK].
- 4 Press [PRINT]. A message to confirm the number of copies appears.

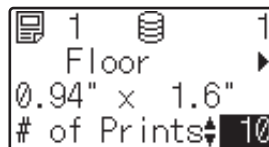

- 5 Type in the number of copies, and then press [PRINT] or [OK]. The labels are printed.

 **Note**

- You can print between 1 and 999 copies.
- If the template contains a serialized number, the labels will be printed with the serialized field incremented by the specified number of times.
- If [Confirm Print] is set to [Off], printing begins when [PRINT] is pressed in step 4.

Editing Label Contents Before Printing

You can use the touch panel display to directly edit the data and change the contents of a template that have already been transferred to the P-touch Label Printer.

You do not need to edit the data from the computer and transfer it to the P-touch Label Printer.

 **Note**

- In the touch panel display settings, set [Disable Edit] to [Off].
- Only numbers can be edited.
- Edited templates are not saveable. When you select a different template or database, the edited data reverts to the original data.

 **Important**

Use the basic control panel to edit data.

- 1 In the main screen, select the template you want to edit, and then press [Q] (search key). If you are editing the contents of a database record select the appropriate database record.
- 2 To display the item you want to edit with [◀] or [▶], and then press [OK]. Editing mode is entered, and the editable number is highlighted.

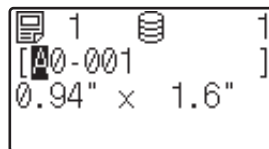

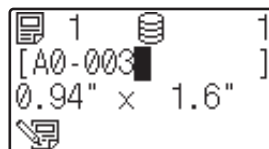

- 3 Press [◀] or [▶] to highlight the number you want to edit. Press the number key of the new number to overwrite the old number. (In this example, [A0-001] will be changed to [A0-003]. Press [▶] to highlight [1], and then press [3] on the number keys.)

 appears in the lower-left corner of the screen to indicate that the template was edited.



 **Note**

- To return the currently displayed item to its original number, press [Esc] to exit the editing mode.
- Holding down [Esc] for at least one second returns the currently displayed item to its original number and returns to the main screen. If any other item has been edited,  appears.

- 4 Press [OK] to apply the edited text, and then press the  (Print) button. A message to confirm the number of copies appears.

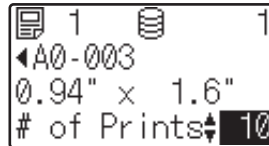

- 5 Type in the number of copies you want to print, and then press [PRINT] or [OK]. The labels are printed.

Searching for Records in a Database Linked to a Template

After transferring a template with a linked database to the P-touch Label Printer, you can search for a record in the database by pressing [Q] (search key) on the basic control panel.

To select whether to search for database records by their line number or by their data, press  (admin key) on the basic control panel, and then select the setting you want for [DB search].

- **By Line#:** Select this setting to search for database records by their line number.
- **By Data:** Select this setting to search for database records by their data (only numbers up to 13 digits) entered into the first data field (for example, Column A).

Printing Using the One-Touch Panel

If a label layout has been assigned to a key on the one-touch panel, you can print a label by pressing the key of the corresponding label.

 **Important**

The data registered with each one-touch key, is determined by the database number or the key number when the data was transferred from the computer to the P-touch Label Printer. For more information, see *Transferring the Label Layout to the P-touch Label Printer* on page 211.

- 1 Turn on the P-touch Label Printer. The main screen appears.

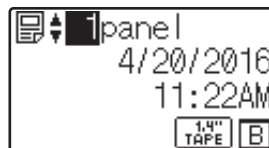

- 2 If databases are assigned to one-touch keys:
Press [▲] or [▼] to select a template.

- 3 Press the one-touch key for the label you want to print. The label details appear on the screen.



- 1 **Template number**
- 2 **Text in label layout**
- 3 **Paper size**
- 4 **Database record number (only if a database is linked)**
- 5 **Number of prints**



Note

- To check all of the text in the label layout, press [◀] or [▶]. To edit the data, use the basic control panel (A), not the one-touch panel (B). For more information, see *Editing Label Contents Before Printing* on page 217.
- You can set the text displayed on the LCD and its display order using P-touch Editor. For more information, see *Setting the Text and Order for Displaying on the LCD* on page 207.

- 4 With [▲] or [▼], type in the number of copies you want to print, and then press [PRINT] or [OK]. The labels are printed.



Note

- You can print between 1 and 999 copies.
- If the template contains a serialized number, the labels will be printed with the serialized field incremented by the specified number of times.
- If [Confirm Print] is set to [Off], printing begins when the one-touch key is pressed in step 3.

If a Template With a Linked Database Is Registered with a One-Touch Key

If you register a template with a linked database to a one-touch key, the displayed contents are for the database record corresponding to the number of times that you press the key.

For example, with a template that has three database records, pressing the one-touch key:

- One time: displays the contents of the first database record.
- Two times: displays the contents of the second record
- Three times: displays the contents of the third record.
- Four times: displays the contents of the first record again.

- 1 Press the one-touch key for the label you want to print until the contents of the database record you want appear.

- 2 With [▲] or [▼], type in the number of copies you want to print, and then press [PRINT] or [OK]. The labels are printed.

! Important

If a template with a linked database is assigned to a one-touch key, be sure that [Confirm Print] is set to [On]. If [Off] is selected, you can select only the first database.

 **Note**

- You can print between 1 and 999 copies.
- If the template contains a serialized number, the labels will be printed with the serialized field incremented by the specified number of times.

Printing Using a Barcode Scanner

Using P-touch Template functions, you can scan barcodes to display a template transferred to the P-touch Label Printer, replace the text if needed, and print labels. You can check the contents of the displayed template or the text you want to replace on the LCD.

The P-touch Label Printer is compatible with many manufacturer barcode scanners, however we recommend you use a genuine Brother barcode scanner (PA-BR-001).

For more information on the P-touch Template functions, see *Printing Labels Using P-touch Template* on page 66.

To check the text in the template, select the template number on the main screen so that the template details are displayed, and then press [◀] or [▶]. To edit the text, display the text to be edited, and then press [OK]. When you enter the editing mode, the editable text becomes highlighted.

Checking the contents of the label layout before printing can help avoid printing the wrong label.

Label Layouts on the P-touch Label Printer (Checking, Deleting and Log)

With the following procedures, label layouts on the P-touch Label Printer can be checked or deleted, or their print log can be viewed.

Checking the Contents of a Label Layout

To display template details on the screen and check the contents, press [Q] (search key) on the touch panel display. For more information, see *Printing Using the Basic Control Panel* on page 216.

Deleting Label Layout Using a Windows® Computer

Use [Device settings] of the Printer Setting Tool to delete a label layout from the P-touch Label Printer. In the menu bar, click [Tools] - [Delete Template and Database] to delete a template or database registered on the P-touch Label Printer. For more information, see *Menu Bar* on page 46.

To check the label layouts on the P-touch Label Printer and select the data you want to delete, connect the P-touch Label Printer to a computer and use P-touch Transfer Manager.

Checking the Print Log for Label Layouts

■ For Windows®

Use [Device settings] of the Printer Setting Tool to check the print log. If [Save Printer Print Log] in the [Advanced] tab is set to [Enable], a print log is saved on the P-touch Label Printer. To export the print log and save it as a CSV file, click [Tools] - [Save Print Log in File]. For more information, see *Device Settings for Windows®* on page 44.

■ For Mac

Use the Printer Setting Tool to check the print log. If [Save Printer Print Log] in the [Basic] tab is set to [Enable], a print log is saved on the P-touch Label Printer. To print the print log, select [Usage Log] in [Print Information Report] in the [Basic] tab. For more information, see *Basic Tab* on page 60.

Replacing the Time/Date Battery

A time/date battery is provided to maintain the settings for the internal clock. The battery will be consumed even if the P-touch Label Printer is not used for a long period of time.

! Important

- Use only recommended batteries in the P-touch Label Printer. Other batteries may cause damage to the P-touch Label Printer.
- When storing or discarding the battery, wrap it (for example with cellophane tape) to prevent it from short-circuiting.

(Battery insulation example)

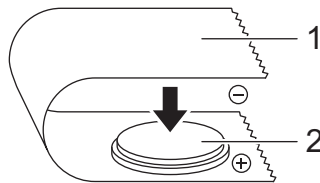

1 Cellophane tape

2 Time/date battery

- We recommend replacing the battery every two years.
- If the clock is reset while power is supplied to the P-touch Label Printer, replace this battery. When replacing the battery, buy a CR2032 battery (recommended manufacturers: Hitachi Maxell, Ltd., FDK Corporation).
- Dispose of the battery at an appropriate collection point, not in the general waste stream. In addition, be sure to observe all applicable federal, state, and local regulations.

- 1 Press and hold the  (Power) button to turn off the P-touch Label Printer, and then disconnect the P-touch Label Printer from the AC power outlet. If the rechargeable Li-ion battery (optional) is installed, remove the rechargeable battery.
- 2 Using a coin or similar object, slowly turn the time/date battery cover in the direction of the arrow on the battery cover until it stops, and then remove the time/date battery cover.

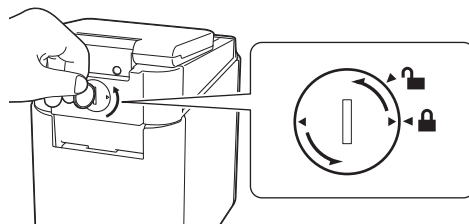

! Important

If the time/date battery cover is forcibly turned past the stop position, it may become damaged.

3 Remove the battery.

As shown below, press part A of the battery to release it so that it can be removed.

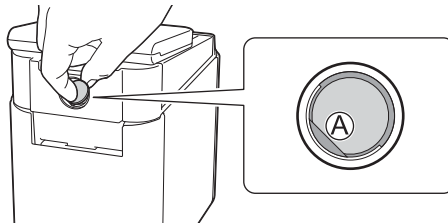

4 Install the new battery.

! Important

Be sure to insert the new battery with the + and – sides facing the correct direction.

5 Return the time/date battery cover to its original position. To install the time/date cover, use a coin or similar object to slowly turn the time/date battery cover in the opposite direction of the arrow on the battery cover until it stops.



! Important

If the time/date battery cover is forcibly turned past the stop position, it may become damaged.

Note

You can configure the time and date using the [Admin Key] (admin key) on the touch panel. For more information, see *Setting the Time and Date* on page 203.

Frequently Asked Questions

Q. How much memory is available?

A. The P-touch Label Printer has 6 MB of built-in memory available, allowing you to save a maximum of 99 templates. When no more built-in memory is available or when 99 templates have been registered, templates can no longer be transferred to (be registered with) the P-touch Label Printer. Delete unnecessary templates from the P-touch Label Printer.

Q. Why does the file size change when I transfer a template to the P-touch Label Printer?

A. Because the format of a template file added to P-touch Transfer Manager 2.2 is different from the format of a file after it has been transferred to the P-touch Label Printer, the file size changes.

Q. How can I check the number of templates that can be registered on the P-touch Label Printer and the key numbers that are being used?

A. Follow the procedure below to check the information:

- 1 Connect the P-touch Label Printer to the computer, and then turn on the P-touch Label Printer.
- 2 Start the P-touch Transfer Manager.

■ **For Windows Vista® / Windows® 7 / Windows Server® 2008 / Windows Server® 2008 R2:**
From the Start button, click [All Programs]-[Brother P-touch]-[P-touch Tools]-[P-touch Transfer Manager 2.2].

■ **For Windows® 8 / Windows® 8.1 / Windows Server® 2012 / Windows Server® 2012 R2:**
Click [P-touch Transfer Manager 2.2] on the [Apps] screen.

■ **For Windows® 10:**

From the Start button, select [All apps], and then click [P-touch Transfer Manager 2.2] under [Brother P-touch].

- 3 Click "Brother PT-P950NW" in the pane on the left side to display the templates registered with the P-touch Label Printer in the pane on the right side. You can check the number of templates and the key numbers currently in use.

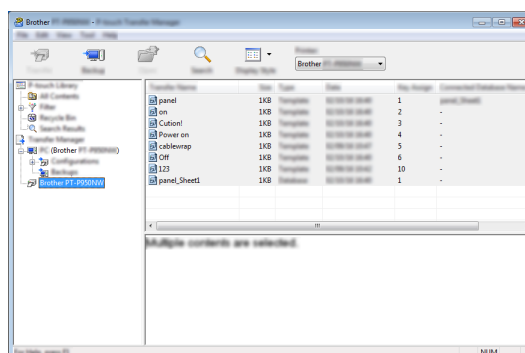

Q. Why can I not transfer a template, with its date automatically updated, to the P-touch Label Printer?

A. The printer driver may not be correctly installed. Re-install the printer driver, and then try transferring again.

If the date was not updated, check that the [**At Printing**] check box is selected in the [**Date and Time Properties**] dialog box for the template.

For more information, see *Inserting the Date and Time in a Label* on page 208.

Using the Touch Panel Display (Optional:PA-TDU-003) (PT-P950NW Only)

Product Specifications

The following specifications are when the time/date battery is not installed and the LCD is closed.

Size: approx. 4.45" (W) × 7.56" (D) × 2.32" (H) (113 mm (W) × 192 mm (D) × 59 mm (H))

Weight: approx. 0.73 lb (0.329 kg)

Using the Brother Barcode Scanner (Optional: PA-BR-001) (PT-P950NW Only)

P-touch template mode provides operations for inserting data into text and barcode objects in a downloaded template from a barcode scanner to the connected to the P-touch Label Printer.

Because the Brother barcode scanner (optional: PA-BR-001) has been set according to the [P-touch Template Settings] in the Printer Setting Tool, you can quickly use this barcode scanner without changing the settings of the barcode scanner.

For information about using the Brother barcode scanner, see the instruction manual included with the barcode scanner.

brother