

User's Manual

Large Format Display

BT421

MODEL: BT421

Please find your model name in the label on the rear side of monitor.

Index

SUPPLIER'S DECLARATION OF CONFORMITY	English-1
Important Information.....	English-2
WARNING.....	English-2
CAUTION	English-2
Safety Precautions, Maintenance & Recommended Use	English-3
Safety Precautions and Maintenance.....	English-3
Recommended Use	English-3
Ergonomics	English-3
For use in Japan only	English-4
Cleaning the LCD Panel	English-4
Cleaning the Cabinet.....	English-4
Contents.....	English-5
Installation	English-6
Attaching Mounting Accessories	English-7
Parts Name and Functions.....	English-8
Control Panel.....	English-8
Terminal Panel.....	English-9
Wireless Remote Control	English-10
Operating Range for the Remote Control	English-11
Setup.....	English-12
Connections	English-13
Wiring Diagram	English-13
Connecting a Personal Computer.....	English-13
Basic Operation.....	English-14
Power ON and OFF Modes	English-14
Power Indicator.....	English-15
Using Power Management	English-15
Aspect.....	English-15
Information OSD.....	English-15
OSD (On-Screen-Display) Controls.....	English-16
Basic Operations on the OSD Screen	English-16
PICTURE.....	English-18
Setup.....	English-18
Initial Setting.....	English-19
Multi Display.....	English-19
System Information.....	English-19
Controlling the LCD monitor via RS-232C Remote Control.....	English-20
Controlling the LCD monitor via LAN Control	English-22
Connecting to a Network	English-22
Network Setting by Using an HTTP Browser	English-22
Features	English-24
Troubleshooting	English-25
Specifications - BT421.....	English-27
Manufacturer's Recycling and Energy Information.....	English-28
Disposing of your old NEC product.....	English-28
Energy Saving.....	English-28
WEEE Mark (European Directive 2012/19/EU and amendments).....	English-29

Cable information

CAUTION: Please use the supplied cables. Use the shielded DVI cable with ferrite cable cores. Use shielded network cables. Using any other types of cables could cause interference to reception.

SUPPLIER'S DECLARATION OF CONFORMITY

This device complies with Part 15 of FCC Rules. Operation is subject to the following two conditions. (1) This device may not cause harmful interference, and (2) this device must accept any interference received, including interference that may cause undesired operation.

U.S. Responsible Party:	NEC Display Solutions of America, Inc.
Address:	3250 Lacey Rd, Ste 500 Downers Grove, IL 60515
Tel. No.:	(630) 467-3000

Type of Product:	Display Monitor
Equipment Classification:	Class A Peripheral
Model:	BT421

**FCC information**

WARNING: The Federal Communications Commission does not allow any modifications or changes to the unit EXCEPT those specified by NEC Display Solutions of America, Inc. in this manual. Failure to comply with this government regulation could void your right to operate this equipment.

This equipment has been tested and found to comply with the limits for a Class A digital device, pursuant to Part 15 of the FCC Rules. These limits are designed to provide reasonable protection against harmful interference when the equipment is operated in a commercial environment. This equipment generates, uses, and can radiate radio frequency energy and, if not installed and used in accordance with the instruction manual, may cause harmful interference to radio communications. Operation of this equipment in a residential area is likely to cause harmful interference in which case the user will be required to correct the interference at his own expense.

If necessary, the user should contact the dealer or an experienced radio/television technician for additional suggestions. The user may find the following booklet, prepared by the Federal Communications Commission, helpful:
"How to Identify and Resolve Radio-TV Interference Problems."

This booklet is available from the U.S. Government Printing Office, Washington, D.C., 20402, Stock No. 004-000-00345-4.

Trademarks

Windows is a registered trademark of Microsoft Corporation.

NEC is a registered trademark of NEC Corporation.

OmniColor is a registered trademark of NEC Display Solutions Europe GmbH in the countries of EU and Switzerland.

All other brands and product names are trademarks or registered trademarks of their respective owners.

Adobe and the Adobe logo are either registered trademarks or trademarks of Adobe Systems Incorporated in the United States and/or other countries.

Important Information



WARNING



TO PREVENT FIRE OR SHOCK HAZARDS, DO NOT EXPOSE THIS UNIT TO RAIN OR MOISTURE. ALSO, DO NOT USE THIS UNIT'S POLARIZED PLUG WITH AN EXTENSION CORD RECEPTACLE OR OTHER OUTLETS UNLESS THE PRONGS CAN BE FULLY INSERTED.

REFRAIN FROM OPENING THE CABINET AS THERE ARE HIGH VOLTAGE COMPONENTS INSIDE. REFER SERVICING TO QUALIFIED SERVICE PERSONNEL.



CAUTION



CAUTION: TO REDUCE THE RISK OF ELECTRIC SHOCK, MAKE SURE POWER CORD IS UNPLUGGED FROM WALL SOCKET. TO FULLY DISENGAGE THE POWER TO THE UNIT, PLEASE DISCONNECT THE POWER CORD FROM THE AC OUTLET. DO NOT REMOVE COVER (OR BACK). NO USER SERVICEABLE PARTS INSIDE. REFER SERVICING TO QUALIFIED SERVICE PERSONNEL.



This symbol warns user that uninsulated voltage within the unit may have sufficient magnitude to cause electric shock. Therefore, it is dangerous to make any kind of contact with any part inside this unit.



This symbol alerts the user that important literature concerning the operation and maintenance of this unit has been included. Therefore, it should be read carefully in order to avoid any problems.

CAUTION: Please use the power cord provided with this monitor in accordance with the table below. If a power cord is not supplied with this equipment, please contact your supplier. For all other cases, please use a power cord that matches the AC voltage of the power outlet and has been approved by and complies with the safety standard of your particular country.

Plug Type	North America		European Continental	U.K.	Chinese	Japanese
Plug Shape						
Region	U.S.A./ Canada	Taiwan	EU (except U.K.)	U.K.	China	Japan
Voltage	120*	110	230	230	220	100

* When operating the monitor with its AC 125-240V power supply, use a power supply cord that matches the power supply voltage of the AC power outlet being used.

NOTE: This product can only be serviced in the country where it was purchased. Use the power cord which has BSMI mark at both ends when you use this monitor in Taiwan.

- The intended primary use of this product is as an Information Technical Equipment in an office or domestic environment.
- The product is intended to be connected to a computer and is not intended for the display of television broadcast signals.



Safety Precautions, Maintenance & Recommended Use

Safety Precautions and Maintenance

FOR OPTIMUM PERFORMANCE, PLEASE NOTE THE FOLLOWING WHEN SETTING UP AND USING THE MULTI-FUNCTION MONITOR:

- **DO NOT OPEN THE MONITOR.** There are no user serviceable parts inside and opening or removing covers may expose you to dangerous shock hazards or other risks. Refer all servicing to qualified service personnel.
- Do not bend, crimp or otherwise damage the power cord.
- Do not place any heavy objects on the power cord. Damage to the cord may cause shock or fire.
- The power supply cord you use must have been approved by and comply with the safety standards of your country. (Type H05VV-F 3G 0.75 mm² should be used in Europe).
- In UK, use a BS-approved power cord with molded plug having a black (5 A) fuse installed for use with this monitor.
- The power cable connector is the primary means of detaching the system from the power supply. The monitor should be installed close to a power outlet, which is easily accessible.
- Do not spill any liquids into the cabinet or use your monitor near water.
- Do not insert objects of any kind into the cabinet slots, as they may touch dangerous voltage points, which can be harmful or fatal or may cause electric shock, fire or equipment failure.
- Do not place this product on a sloping or unstable cart, stand or table, as the monitor may fall, causing serious damage to the monitor.
- Do not mount this product upside down for an extended period of time as it may cause permanent damage to the screen.
- Do not place any objects onto the monitor and do not use the monitor outdoors.
- If glass is broken, handle with care.
- Temperature controlled fans are implemented in this monitor. For reliable performance and long useful life of this product, it is mandatory to not cover any vents on the monitor.
- If monitor or glass is broken, do not come in contact with the liquid crystal and handle with care.
- Allow adequate ventilation around the monitor, so that heat can properly dissipate. Do not block ventilated openings or place the monitor near a radiator or other heat sources.
- Do not put anything on top of the monitor.
- Handle with care when transporting. Save packaging for transporting.
- If using the cooling fan continuously, it is recommended to wipe holes clean a minimum of once a month.
- To ensure the monitor's reliability, please clean the holes at the back side of the cabinet at least once a year to remove dirt and dust.
- When using a LAN cable, do not connect to a peripheral device with wiring that might have excessive voltage.
- Do not use the monitor in high temperature, humid, dusty, or oily areas.
- Do not use monitor under rapid temperature and humidity change condition and avoid cold air from air-conditioning outlet directly, as it may shorten the lifetime of the monitor or cause condensation. If condensation of water has happened, let the monitor stand unplugged until the condensation has disappeared.

Connecting to a TV*

- Cable distribution system should be grounded (earthed) in accordance with ANSI/NFPA 70, the National Electrical Code (NEC), in particular Section 820.93, Grounding of Outer Conductive Shield of a Coaxial Cable.
- The screen of the coaxial cable is intended to be connected to earth in the building installation.

Under the following conditions immediately disconnect your monitor from the wall outlet and refer servicing to qualified service personnel:

- When the power supply cord or plug is damaged.
- If liquid has been spilled, or objects have fallen into the monitor.
- If the monitor has been exposed to rain or water.
- If the monitor has been dropped or the cabinet has been damaged.
- If you notice any structural damage such as cracks or unnatural wobbling.
- If the monitor does not operate normally by following operating instructions.

Recommended Use

- For the monitor's optimum performance, allow 20 minutes for warming up.
- Rest your eyes periodically by focusing on an object at least 5 feet away. Blink often.
- Position the monitor at a 90° angle to windows and other light sources to minimize glare and reflections.
- Clean the LCD monitor surface with a lint-free, non-abrasive cloth. Avoid using any cleaning solution or glass cleaner!
- Adjust the monitor's brightness, contrast and sharpness controls to enhance readability.
- Avoid reproduction of still patterns on the monitor for long periods of time to avoid image persistence (after image effects).
- Get regular eye checkups.

Ergonomics

To realize the maximum ergonomic benefits, we recommend the following:

- Use the preset Size and Position controls with standard signals.
- Use the preset Color Setting.
- Use non-interlaced signals.
- Do not use primary color blue on a dark background, as it is difficult to see and may produce eye fatigue due to insufficient contrast.
- Suitable for entertainment purposes at controlled luminous environments, to avoid disturbing reflections from the screen.

* The product you purchased may not have this feature.

For use in Japan only

This color monitor is designed for use in Japan and can not be used in any other countries.

Cleaning the LCD Panel

- When the liquid crystal panel is dusty, please gently wipe with a soft cloth.
- Please do not rub the LCD panel with hard material.
- Please do not apply pressure to the LCD panel surface.
- Please do not use OA cleaner as it will cause deterioration or discoloration on the LCD panel surface.

Cleaning the Cabinet

- Unplug the power supply
- Gently wipe the cabinet with a soft cloth
- To clean the cabinet, dampen the cloth with a neutral detergent and water, wipe the cabinet and follow with a dry cloth.

NOTE: DO NOT clean with benzene thinner, alkaline detergent, alcoholic system detergent, glass cleaner, wax, polish cleaner, soap powder, or insecticide. Rubber or vinyl should not be in contact with the cabinet for an extended period of time. These types of fluids and materials can cause the paint to deteriorate, crack or peel.

Contents

Your new monitor box* should contain the following:

- LCD monitor
- Power cord*¹
- Video Signal Cable
- Wireless Remote Control and AAA Batteries x 2
- Setup Manual
- Clamp
- Screw

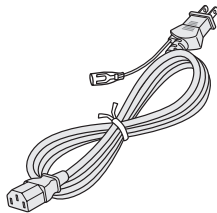
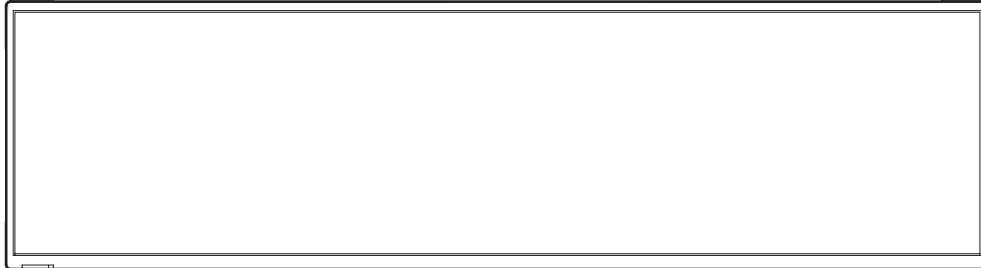

Power Cord*¹

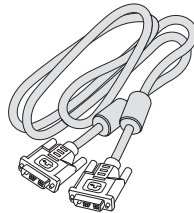

Video Signal Cable

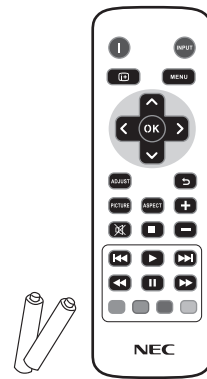

Wireless Remote Control and AAA Batteries x 2



Screw



Clamp

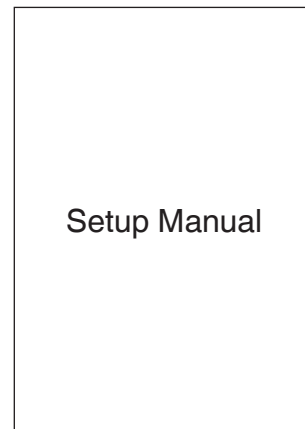

Setup Manual

* Remember to save your original box and packing material to transport or ship the monitor.

*¹ Type and number of power cords included will depend on where the LCD monitor is to be shipped. When more than one power cord is included, please use a power cord that matches the AC voltage of the power outlet and has been approved by and complies with the safety standard of your particular country.

Installation

For contents, please refer to the contents sheet.

This device cannot be used or installed without the Tabletop Stand or other mounting accessory for support. For proper installation it is strongly recommended to use a trained, NEC authorized service person. Failure to follow NEC standard mounting procedures could result in damage to the equipment or injury to the user or installer. Product warranty does not cover damage caused by improper installation. Failure to follow these recommendations could result in voiding the warranty.

Mounting

DO NOT mount the monitor yourself. Please ask your supplier. For proper installation it is strongly recommended to use a trained, qualified technician. Please inspect the location where the unit is to be mounted. Mounting on wall or ceiling is the customer's responsibility. Not all walls or ceilings are capable of supporting the weight of the unit. Product warranty does not cover damage caused by improper installation, remodeling, or natural disasters. Failure to comply with these recommendations could result in voiding the warranty.

DO NOT block ventilated openings with mounting accessories or other accessories.

For NEC Qualified Personnel:

To ensure safe installation, use two or more brackets to mount the unit. Mount the unit to at least two points on the installation location.

Please note the following when mounting on wall or ceiling

- NEC recommends mounting interfaces that comply with UL1678 standard in North America.
- NEC strongly recommends using size M6 screws (8-10 mm + thickness of bracket and washers in length). If using screws longer than 8-10 mm, check the depth of the hole. (Recommended Fasten Force: 470 - 635 N•cm). Bracket hole should be under ϕ 8.0 mm.
- Prior to mounting, inspect the installation location to ensure that it is strong enough to support the weight of the unit so that the unit will be safe from harm.
- For detailed information, refer to the instructions included with the mounting equipment.
- Make sure that there is no gap between the monitor and the bracket.
- When used in a video wall configuration for a longer time, slight expansion of the monitors may happen due to temperature changes. Due to this it is recommended that over one millimeter gap is kept between adjacent monitor edges.
- When installing, do not apply pressure to the screen or excessive force to any part of the monitor by pushing or leaning on it. This may cause the monitor to become distorted or damaged.

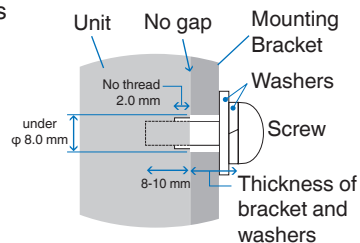

To prevent the LCD monitor from falling off from the wall or ceiling, NEC strongly recommends using a safety wire.

Please install LCD monitor in a spot of the wall or ceiling strong enough to support the monitor.

Prepare the LCD monitor using mounting accessories such as hook, eyebolt or mounting parts and then secure the LCD monitor with a wire. The safety wire must not be tight.

CAUTION: Do not attempt to hang the monitor using an installation safety wire. The monitor must be properly installed.

Please make sure the mounting accessories are strong enough to support the LCD monitor before mounting it.

Mounting location

- The ceiling and wall must be strong enough to support the monitor and mounting accessories.
- DO NOT install in locations where a door or gate can hit the unit.
- DO NOT install in areas where the unit will be subjected to strong vibrations and dust.
- DO NOT install the monitor next to a location where the main power supply is fed into the building.
- DO NOT install the monitor in a location where people can easily grab and hang onto the unit or the mounting equipment.
- Allow for adequate ventilation or provide air conditioning around the monitor, so that heat can properly dissipate away from the monitor and from the mounting equipment.

Mounting on ceilings

- Ensure that the ceiling is sturdy enough to support the weight of the unit and the mounting equipment over time, against earthquakes, unexpected vibrations, and other external forces.
- Be sure the unit is mounted to a solid structure within the ceiling, such as a support beam. Secure the monitor using bolts, spring lock washers, washer and nut.
- DO NOT mount to areas that have no supporting internal structure. DO NOT use wood screws or anchor screws for mounting. DO NOT mount the unit to ceiling or to hanging fixtures.

Maintenance

- Periodically check for loose screws, gaps, distortions, or other problems that may occur with the mounting equipment. If a problem is detected, please refer to qualified personnel for service.
- Regularly check the mounting location for signs of damage or weakness that may occur over time.

Orientation

- When using the monitor in the portrait position, it should be rotated clockwise so that the right side is moved to the top, left side is moved to the bottom. This will allow for proper ventilation and will extend the lifetime of the monitor. Improper ventilation may shorten the lifetime of the monitor.

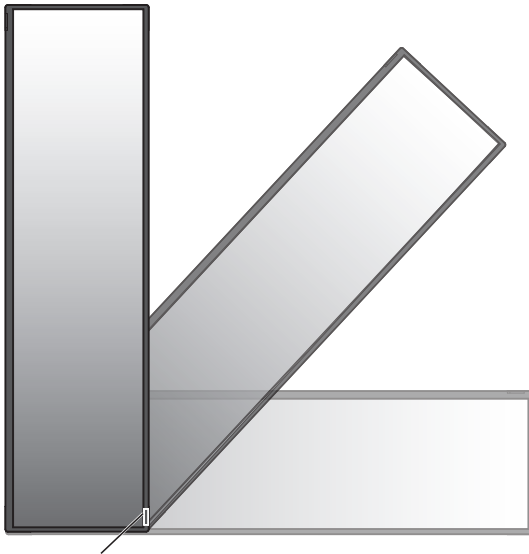

Remote control sensor and Power Indicator

2. Ventilation Requirements

When mounting in an enclosed space or recessed area, leave adequate room between the monitor and the enclosure to allow heat to disperse, as shown below.

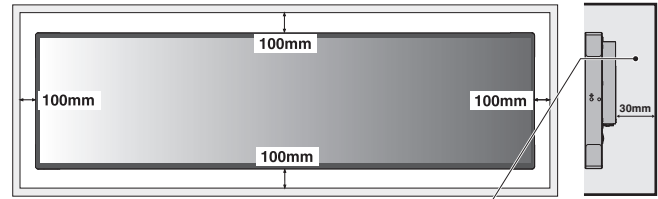

Must be under 50 Degree Celsius.

Allow adequate ventilation or provide air conditioning around the monitor, so that heat can properly dissipate away from the unit and the mounting equipment; especially when you use monitors in a multiple screen configuration.

Attaching Mounting Accessories

The monitor is designed for use with the VESA mounting system.

1. Attach Mounting Accessories

Be careful to avoid tipping the monitor when attaching accessories.

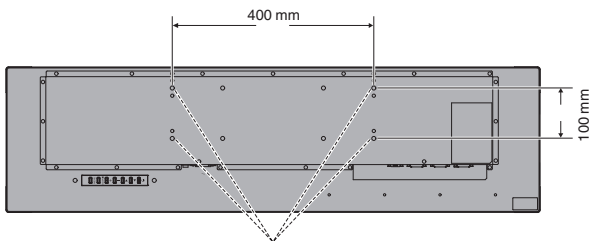

VESA Mounting Interface (M6)

Mounting accessories can be attached with the monitor in the face down position. To avoid damaging the front face, place the protective sheet on the table underneath the LCD monitor. The protective sheet was wrapped around the LCD monitor in the original packaging. Make sure there is nothing on the table that can damage the monitor.

NOTE: Prior to installation, be sure to place the monitor on a flat area with adequate space.

NOTE: You can use 200 mm/100 mm holes for mounting.

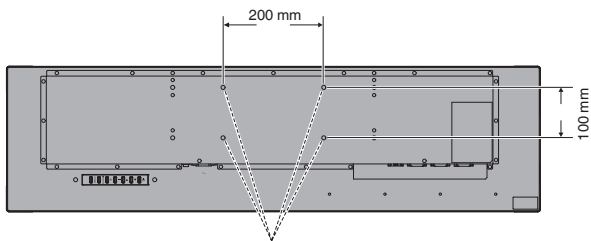

Mounting Interface (M6)

Parts Name and Functions

Control Panel

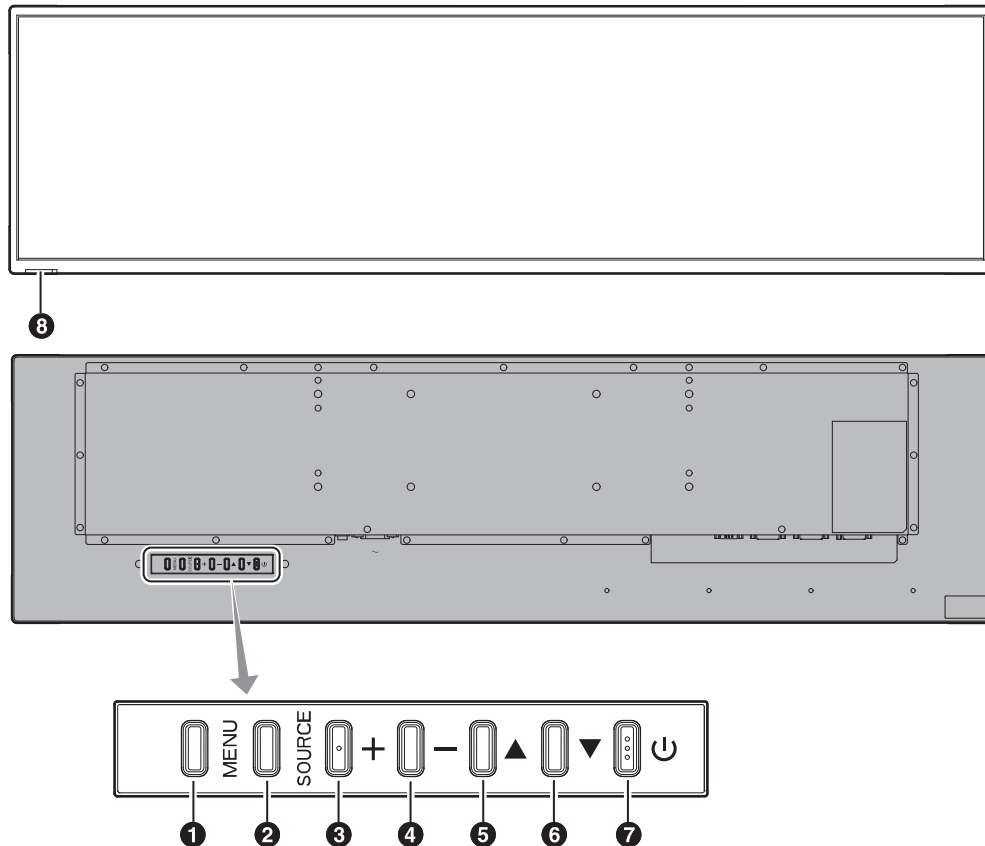

1 MENU button (MENU)

Turns on/off the OSD menu.

2 SOURCE button (SOURCE)

Acts as INPUT button within OSD menu.

You can select [DVI1] or [DVI2] with the up (▲)/down (▼) button. These are available input only, shown as their factory preset name.

3 PLUS button (+)

Acts as (+) button to increase the adjustment with OSD menu.

4 MINUS button (-)

Acts as (-) button to decrease the adjustment with OSD menu.

5 UP button (▲)

Acts as UP button to move the highlighted area up to select adjustment items within OSD menu.

6 DOWN button (▼)

Acts as DOWN button to move the highlighted area down to select adjustment items within OSD menu.

7 POWER button (⏻)

Switches the power on/off. See also [page 14](#).

8 Remote control sensor and Power Indicator

Receives the signal from the remote control (when using the wireless remote control). See also [page 11](#).
Glow green when the LCD monitor is in active mode.
Glow red when the LCD is in POWER OFF mode.
Glow red while in Power Standby mode with the "Scheduler" function enabled. When a component failure is detected within the monitor, the indicator will blink red.

Terminal Panel

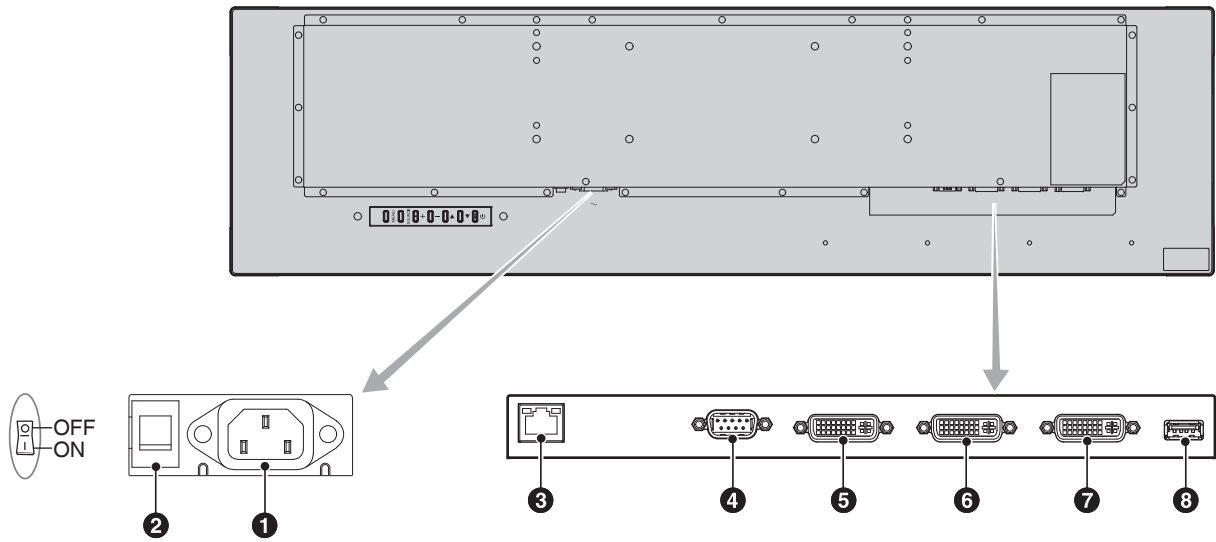

1 AC IN Connector

Connects with the supplied power cord.

2 Main Power Switch

On/Off switch to turn main power ON/OFF.

3 LAN Port (RJ-45)

LAN connection. See [page 22](#).

4 RS-232C IN (D-Sub 9 pin)

Connect RS-232C input from external equipment such as a computer in order to control RS-232C functions.

5 DVI Output Connector

Connect it to the DVI input connector of the digital input interface of another display.

6 DVI Input Connector (DVI1)

7 DVI Input Connector (DVI2)

Connect it to a device conforming to the DVI standard of digital input interface.

8 Service port

This port is for future software upgrades.

Wireless Remote Control

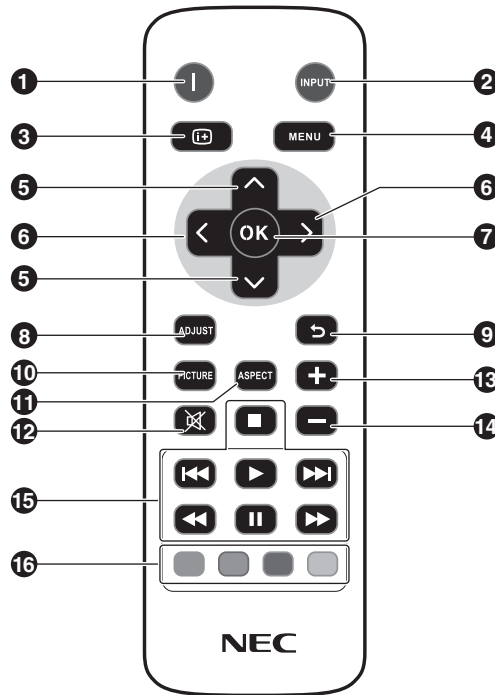

1 POWER button

Switches the power on/standby.

2 INPUT button

Selects input signal.
DVI1, DVI2

3 INFO button

Turns on/off the information OSD. See [page 15](#).

4 MENU button

Turns on/off the OSD menu.

5 UP/DOWN button

Acts as ▲ ▼ button to move the highlighted area up or down to select adjustment items within OSD menu.

6 LEFT/RIGHT button

Increases or decreases the adjustment level within OSD menu settings.

7 OK button

Makes selection.

8 ADJUST button

Cannot be used with this monitor.

9 BACK button

Returns to previous menu within OSD menu.

10 PICTURE button

Selects picture mode, [Dynamic], [Standard], [Cinema], [Custom].

Dynamic: for moving images such as DVD.

Standard: for images.

Cinema: for Cinema.

Custom: activate auto dimming function.

11 ASPECT button

Selects picture aspect, [Full], [Trim up], [Trim down], [Zoom]. See [page 15](#).

12 MUTE button

Cannot be used with this monitor.

13 14 VOLUME UP/DOWN button

Cannot be used with this monitor.

15 AUDIO/VIDEO CONTROL buttons

Cannot be used with this monitor.

16 MEDIA CONTROL buttons

Cannot be used with this monitor.

Operating Range for the Remote Control

Point the top of the remote control toward the LCD monitor's remote control sensor during button operation.

Use the remote control within a distance of about 5 m (16 ft.) from the remote control sensor, or at a horizontal and vertical angle of within 30° and within a distance of about 3.5 m (11 ft.).

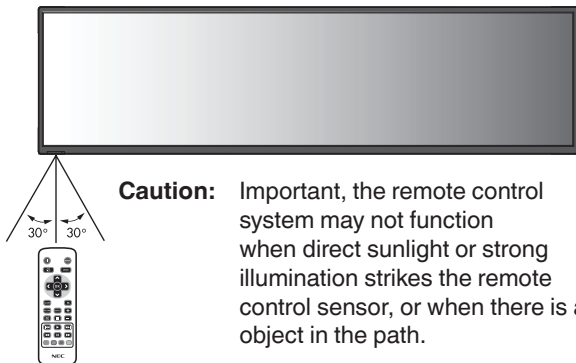

Handling the remote control

- Do not expose to strong shock.
- Do not allow water or other liquid to splash on the remote control. If the remote control gets wet, wipe it dry immediately.
- Avoid exposure to heat and steam.
- Except to install the batteries, do not open the remote control.

Setup

1. Determine the installation location

CAUTION: Installing your LCD monitor must be done by a qualified technician. Contact your supplier for more information.

CAUTION: MOVING OR INSTALLING THE LCD MONITOR MUST BE DONE BY FOUR OR MORE PEOPLE. Failure to follow this caution may result in injury if the LCD monitor falls.

CAUTION: Do not mount or operate the monitor upside down.

IMPORTANT: Lay the protective sheet beneath the monitor, so as not to scratch the LCD panel. The protective sheet was wrapped around the monitor when it was packaged.

2. Install the remote control batteries

The remote control is powered by two 1.5V AAA batteries. To install or replace batteries:

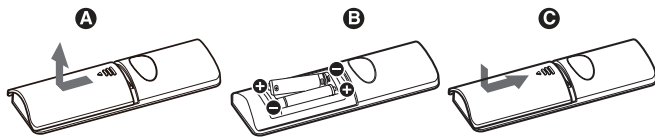

- Press and slide to open the cover.
- Align the batteries according to the (+) and (-) indications inside the case.
- Replace the cover.

CAUTION: Incorrect usage of batteries can result in leaks or bursting.

NEC recommends the following battery use:

- Place “AAA” size batteries matching the (+) and (-) signs on each battery to the (+) and (-) signs of the battery compartment.
- Do not mix battery brands.
- Do not combine new and old batteries. This can shorten battery life or cause liquid leakage of batteries.
- Remove dead batteries immediately to prevent battery acid from leaking into the battery compartment.
- Do not touch exposed battery acid, it may injure your skin.

NOTE: If you do not intend to use the Remote Control for a long period of time, remove the batteries.

3. Connect external equipment (See page 13)

- To protect the external equipment, turn off the main power before making connections.
- Refer to the user’s manual of your equipment for further information.

NOTE: Do not connect/disconnect cables when turning on the monitor or other external equipment, as this may result in a loss of the monitor image.

4. Connect the supplied power cord

- The equipment should be installed close to an easily accessible power outlet.
- Fasten the power cord to the LCD monitor by attaching the screw and clamp.
- Fully insert the prongs into the power outlet socket. A loose connection may cause image degradation.

NOTE: Please refer to the “Safety Precautions and Maintenance” section of this user’s manual for proper selection of an AC power cord. (Recommended Fasten Force: 139 - 189N•cm).

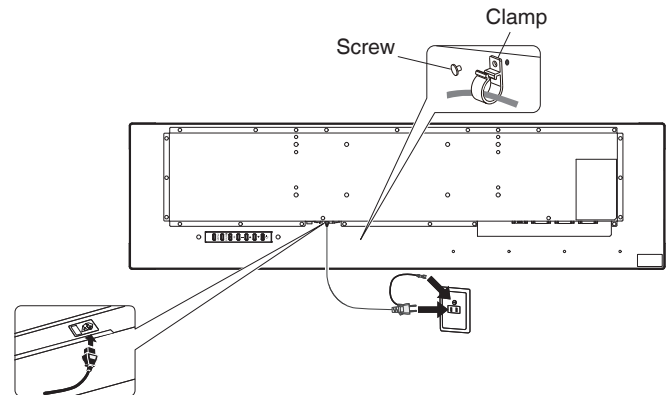

5. Switch on the power of all the attached external equipment

When connected with a computer, switch on the power of the computer first.

6. Operate the attached external equipment

Show the signal on the screen from the desired input source.

7. Adjust the image (See page 18)

Make adjustments such as backlight or contrast when required.

8. Recommended Adjustments

To reduce the risk of the “Image Persistence”, please adjust the following items based on the application being used: “Anti-Image Retention”, “Clock”, “Scheduler”.

Connections

NOTE: Do not connect or disconnect cables when turning on the monitor's main power or other external equipment's power, as this may result in a loss of the monitor image.

Before making connections:

- * First turn off the power of all the attached equipment and make connections.
- * Refer to the user's manual included with each separate piece of equipment.

Wiring Diagram

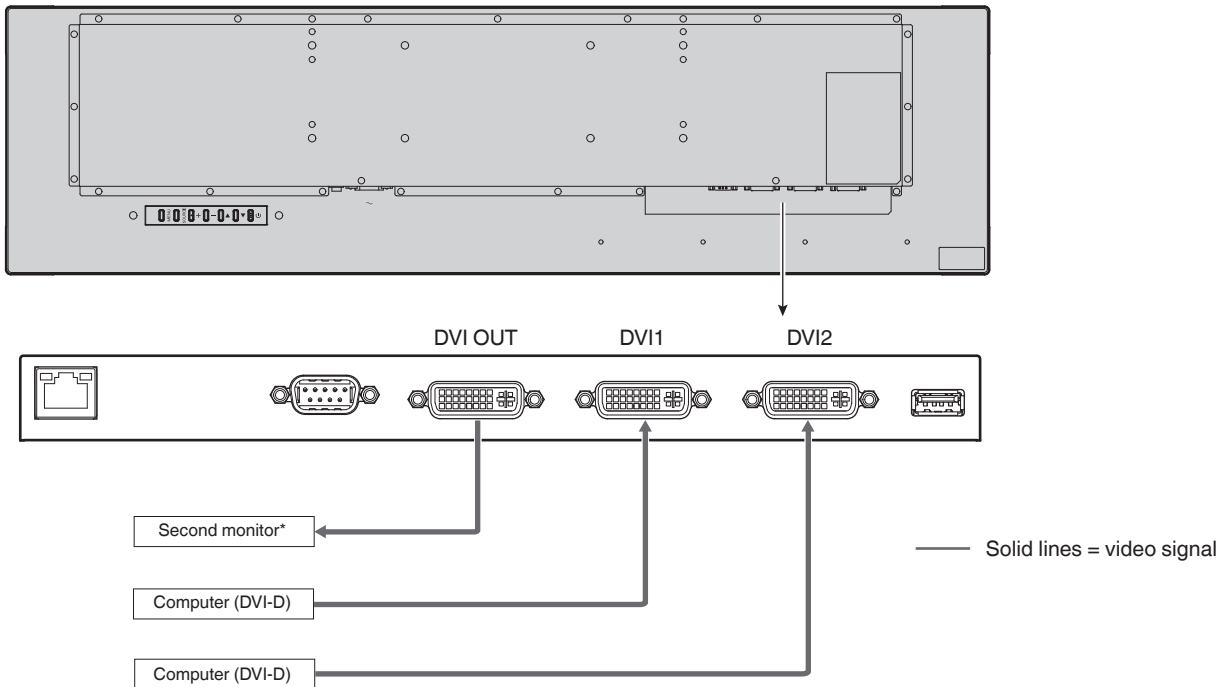

*: Multiple monitors that are daisy-chained have a limit to the connectable monitors.

Connecting a Personal Computer

Connecting your computer to your LCD monitor will enable you to reproduce your computer's video signal output. Some display cards may not be able to support the required resolution for proper image reproduction. Your LCD monitor shows proper image by adjusting the factory preset timing signal automatically.

<Typical factory preset signal timing>

Resolution	Scanning frequency	
	Horizontal	Vertical
640 x 480	31.5 kHz	60 Hz
800 x 600	37.9 kHz	60 Hz
1024 x 768	48.4 kHz	60 Hz
1280 x 720	45.0 kHz	60 Hz
1280 x 768	47.8 kHz	60 Hz
1280 x 800	49.7 kHz	60 Hz
1280 x 1024	64 kHz	60 Hz
1360 x 768	47.7 kHz	60 Hz
1366 x 768	47.7 kHz	60 Hz
1400 x 1050	65.3 kHz	60 Hz
1440 x 900	55.9 kHz	60 Hz
1600 x 1200	75.0 kHz	60 Hz
1680 x 1050	65.3 kHz	60 Hz
1920 x 480*1	29.9 kHz	60 Hz
1920 x 540	33.6 kHz	60 Hz
1920 x 960	59.7 kHz	60 Hz
1920 x 1080	67.5 kHz	60 Hz
1920 x 1200	74.6 kHz	60 Hz

*1: Recommended resolution.

Basic Operation

Power ON and OFF Modes

The LCD monitor power indicator will turn green while powered on.

NOTE: The Main Power switch must be in the ON position in order to power up the monitor using the remote control or the Power button.

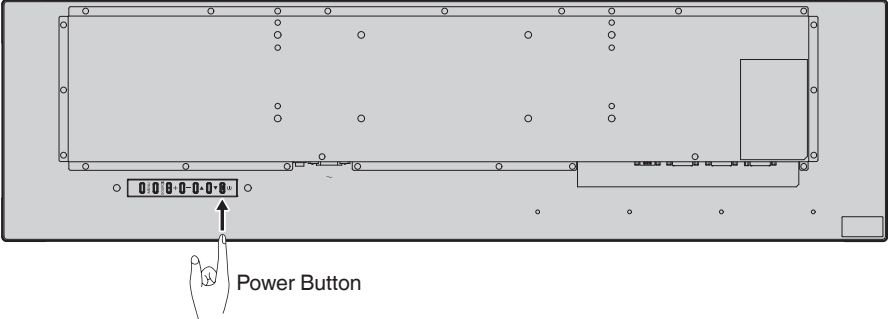
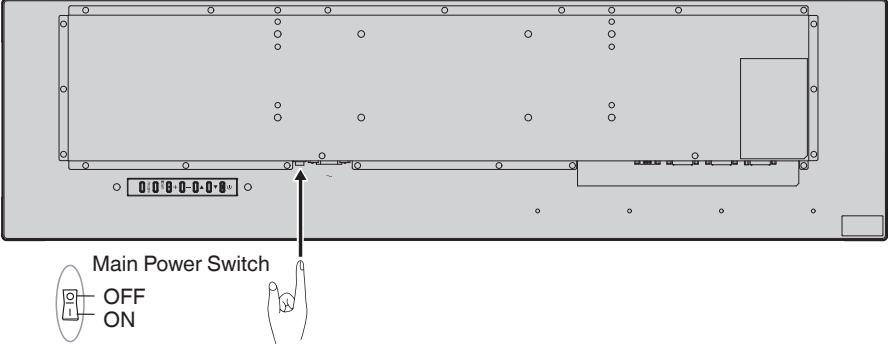

Using the remote control

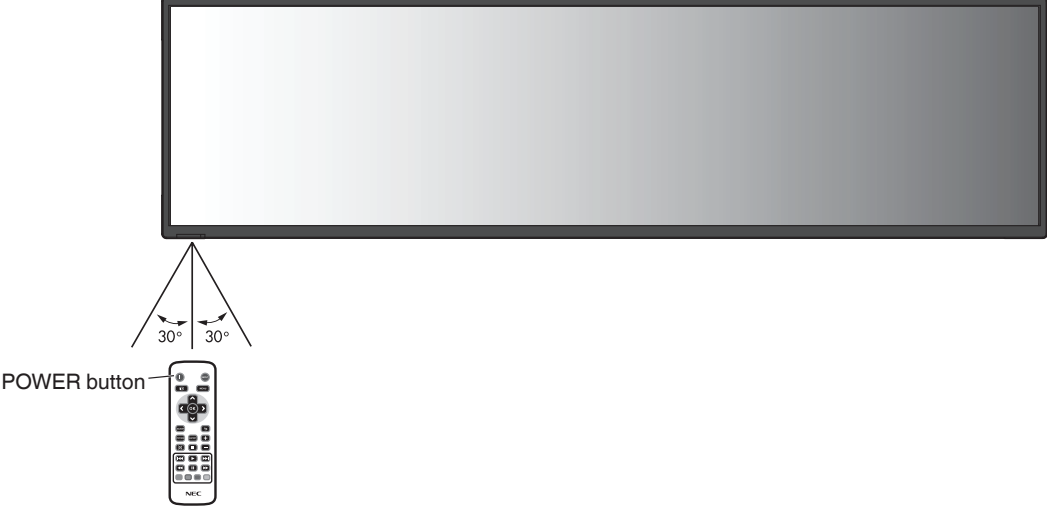

Power Indicator

LED indicator status and lighting pattern	Condition	Recovery
Glowing green	Normal	1. Turn on the monitor by the remote control or the monitor button.
Glowing red	The monitor is turned off with the scheduler function set.	2. Send an AV signal input to the monitor.
	Turn off the monitor by the remote control or the monitor button.	Turn on the monitor by the remote control or the monitor button.

NOTE: If the indicator is blinking red, a certain failure might have occurred, please contact your supplier.

Using Power Management

This LCD monitor follows the VESA approved DPM (Display Power Management) function.

The power management function is an energy saving function that automatically reduces the power consumption of the monitor when the keyboard or the mouse has not been used for a fixed period.

This allows your LCD monitor to enter a Power Management mode if the monitor's POWER SAVE function is set to ENABLE, and a certain amount of time has passed since the monitor recognized "no signal input". It will increase the life and decrease the power consumption of the monitor.

NOTE: Depending on the computer and display card used, this function may not operate. After the video signal was lost, the monitor automatically goes into OFF at a preset time period.

Aspect

Full → Trim up → Trim down → Zoom → Normal

Mode	Original Signal	
	16:9	4:3
Full		
Trim up		
Trim down		
Zoom		
Normal		

*3 Grey areas indicate unused portions of the screen.

FULL: Fills the entire screen.

Trim Up: Expands the image horizontally to fill the entire screen while maintaining the aspect ratio. A strip 80 pixels thick is cut from the top of the screen.

Trim Down: Expands the image horizontally to fill the entire screen while maintaining the aspect ratio. A strip 80 pixels thick is cut from the bottom of the screen.

ZOOM

Expands/reduces the image size horizontally or vertically to the respective magnification ratios.

(The image can be expanded from 0.9 to 3 times both horizontally and vertically.)

The display position can be adjusted with H.Position and V.Position respectively.

NORMAL: Reproduces the aspect ratio that is sent from the source.

Information OSD

The Information OSD provides information such as: Input Source, Input Resolution, etc.

Press the INFO button on the remote to bring up the Information OSD.

OSD (On-Screen-Display) Controls

For this monitor, an OSD (on-screen display) function is used to allow you to easily adjust settings. You can use the OSD function to control the menu displayed on the screen and adjust the brightness and other settings.

Basic Operations on the OSD Screen

Make sure that the power indicator lights in green and the power to the monitor is on.

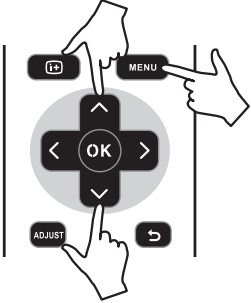
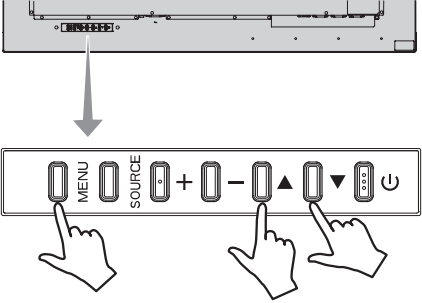
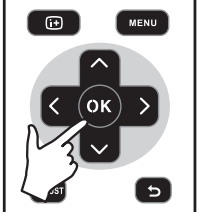
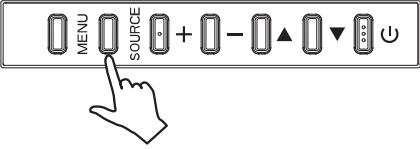
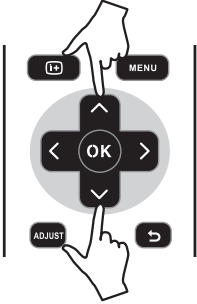
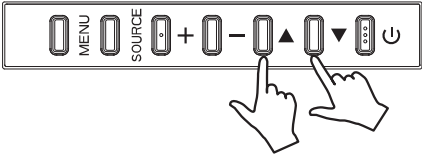
Step	Wireless Remote Control	Keypad Operation
1	 <p data-bbox="253 890 797 966">Press the [MENU] button to display the OSD screen. Press the up (▲)/down (▼) button to select an item in the main menu.</p>	
2	 <p data-bbox="253 1386 829 1437">Press the [OK] button to determine the selected item in the main menu. The top item in the relevant sub menu is selected.</p>	 <p data-bbox="886 1386 1430 1460">Press the [SOURCE] button to determine the selected item in the main menu. The top item in the relevant sub menu is selected.</p>
3	 <p data-bbox="253 1878 789 1928">Press the up (▲)/down (▼) button to select an item in the sub menu.</p>	

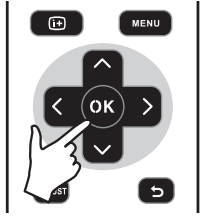
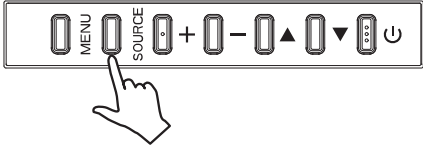
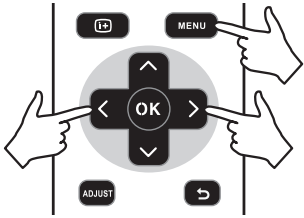
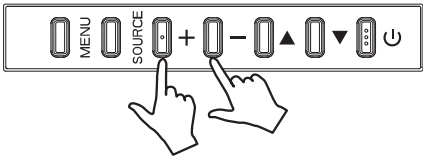
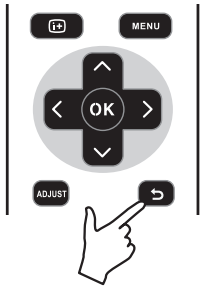
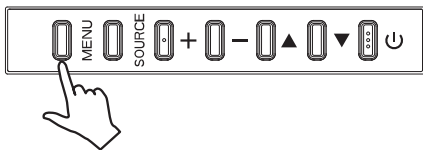
Step	Wireless Remote Control	Keypad Operation
4	 <p>Press the [OK] button to determine the selected item in the sub menu.</p>	 <p>Press the [SOURCE] button to determine the selected item in the sub menu.</p>
5	 <p>Press the left (◀)/right (▶) button to select a setting and press the [OK] button to determine the setting.</p>	 <p>Press the plus (+)/minus (-) button to select a setting and press the [MENU] button to determine the setting.</p>
6	 <p>Press the [BACK] button to exit from the current menu and return to the previous menu.</p>	 <p>Press the [MENU] button to exit from the current menu.</p>

PICTURE	
Picture Mode	Select [Dynamic], [Cinema], [Custom], or [Standard]. Adjust Contrast, Brightness, Sharpness, Tint, and Color. If these categories are adjusted individually, Custom is displayed for Picture Mode.
Backlight	Adjust the Backlight setting.
Color Temperature	Adjust Color Temperature. The color temperature can be set either with the predefined color temperatures, or by adjusting the individual R/G/B levels. A lower color temperature will result in a reddish screen and a higher color temperature in a bluish screen. If the adjustment was made using the individual R/G/B levels, Custom is displayed for Color Temperature.
Gamma	Select a Gamma setting. 2.2 : Sets the gamma value to 2.2. 2.4 : Sets the gamma value to 2.4. NATIVE: Disables the gamma adjustment function.
Noise Reduction	Adjust Noise Reduction. Select [Off], [Low], [Medium], or [High].
Adaptive Contrast	Select On or Off for Adaptive Contrast. When this function is turned on, the contrast is displayed clearly, but the brightness may appear unstable due to the wide range of variation.
Aspect Ratio	Adjust Aspect Ratio. Select [Full], [Trim up], [Trim down], [Zoom], or [Normal]. H.Zoom : Expands/reduces the image size horizontally. (0.9 to 3 times) V.Zoom : Expands/reduces the image size vertically. (0.9 to 3 times) H.Position: Press + to move right and press - to move left. V.Position : Press + to move up and press - to move down.
Color Range	Select the color range setting from [0-255], [16-235], or [Auto].
Reset Picture Setting	Resets the settings in the Picture menu back to their factory settings.
Setup	
Scheduler	Set the schedule operation time of this monitor. NOTE: • Before setting the "Schedule" function, make sure to set the current date and time in "Date & Time". • To enable the "Schedule" function, enable the scheduler from the menu. • When the "Schedule" function is enabled, the Sleep Timer function does not operate.
Signal Check Priority	• Set [Priority1] to [Priority5] ([Priority1]: highest priority) as the priority of each signal. When the current source signal is lost, the display attempts to find a new signal source according to the Signal Check Priority setting. • When [Signal Check Priority] is enabled, the display attempts to find a valid signal source according to the Signal Check Priority setting at power on. • When the signal source for which [Priority 1] is set is not found, the display checks other sources in order of priority and switches to the available source with the highest priority. • When the signal source with the highest priority recovers, the display automatically switches to the source again. • When [Signal Check Priority] is disabled, the display uses the last used source at power on. • When [Signal Check Priority] is enabled and the signal source is USB, the USB data is automatically played at power on.
Control Setting	Make a selection such that the LCD monitor is controlled via RS-232C or LAN. Off : Disables the external control setting. RS-232C : Enables control via RS-232C. LAN : Enables control via LAN. NOTE: • RS-232C and LAN control are exclusive.
Ethernet Setting	Displays the network setting.
Sleep Timer	Change the Sleep Timer setting or set Sleep Timer to Off. NOTE: • When the Sleep Timer setting is enabled, the scheduler function does not operate.
Power Save	Change the Power Save setting or set Power Save Mode to Off.
Equalizer	If you find signs of degradation with the screen when using a long cable, adjust the equalization. Select from [Auto], or any level from [Level1] to [Level7].
Reset Default	Resets the settings in the Setup menu back to their factory settings.

Initial Setting	
OSD Rotation	Select [Landscape] or [Portrait] as the orientation of the OSD.
Menu Language	Change the language used for OSD Menu.
Time Format	Select [12 Hour] or [24 Hour].
Clock	Set the time and date.
Remote Operation	Enable or disable Remote Operation.
Keypad Operation	Enable or disable Keypad Operation.
Anti-Image Retention	Select Anti-Image Retention, or set Anti-Image Retention to Off.
Multi Display	
Monitor ID	Assign an ID number for control. The Monitor ID number can be selected from 1 - 8.
Power On Delay	Adjusts the delay time between being in "standby" mode and entering "power on" mode. "Power On Delay" can be set between 0 and 30 seconds.
Power Lamp	If Off is selected, after turning on the power switch, you can turn off the light indicator (green).
System Information	
Model Name	Displays the model name of the display.
SW Version	Displays the version of the current software of the display.
LAN Version	Displays the software version of the LAN currently used for the display.
IP Address	Displays the IP address currently set for the display.

NOTE: IMAGE PERSISTENCE

Please be aware that LCD Technology may experience a phenomenon known as Image Persistence. Image Persistence occurs when a residual or "ghost" image of a previous image remains visible on the screen. Unlike CRT monitors, LCD monitors' image persistence is not permanent, but constant images being displayed for a long period of time should be avoided.

To alleviate image persistence, turn off the monitor for as long as the previous image was displayed. For example, if an image was on the monitor for one hour and a residual image remains, the monitor should be turned off for one hour to erase the image.

As with all personal display devices, NEC DISPLAY SOLUTIONS recommends displaying moving images and using a moving "Anti-Image Retention" at regular intervals whenever the screen is idle or turning off the monitor when not in use.

Please set "Anti-Image Retention", "Clock" and "Scheduler" functions to further reduce the risk of Image persistence.

For long life use as Public Display

Image Sticking of LCD Panel

When an LCD panel is operated continuously for long hours, a trace of electric charge remains near the electrode inside LCD, and residual or "ghost" image of previous image may be observed. (Image Persistence)

Image Persistence is not permanent, but when fixed image is displayed for long period, ionic impurities inside LCD are accumulated along the displayed image, and may be permanent. (Image Sticking)

Recommendations

To prevent Image Sticking, and for longer life usage of LCD, the following are recommended.

1. Fixed image should not be displayed for long period. Change fixed images after short intervals.
2. When not in use, please turn off the monitor by remote control, or use Power Management or use Schedule Functions.
3. Lower environmental temperatures prolong the lifespan of the monitor.
When Protective surface (glass, acrylic) is installed over the LCD surface, the LCD surface is located in an enclosed space, the monitor are stacked, utilize the temperature sensors inside monitor.
To reduce the environmental temperature, use the "Anti-Image Retention" and Low Brightness.
4. Please use "Anti-Image Retention Mode" of monitor.

Controlling the LCD monitor via RS-232C Remote Control

This LCD monitor can be controlled by connecting a personal computer with an RS-232C (reverse type) terminal.

CAUTION: RS-232C and LAN specification are exclusive.

Functions that can be controlled by a personal computer are:

- Power ON or standby.
- Switching between input signals.

Connection

LCD Monitor + computer.

- Please turn off the monitor's main power when connecting a computer to the monitor.
- Please turn on the connecting computer first then turn on the monitor's main power.
If you turn on the computer and monitor in reverse order, the com port may not work.
- When controlling the monitor connected with an RS-232C cable, please refer to the Control command diagram (See [page 23](#)) or see the "External_Control.pdf" file on the CD-ROM supplied with the monitor.

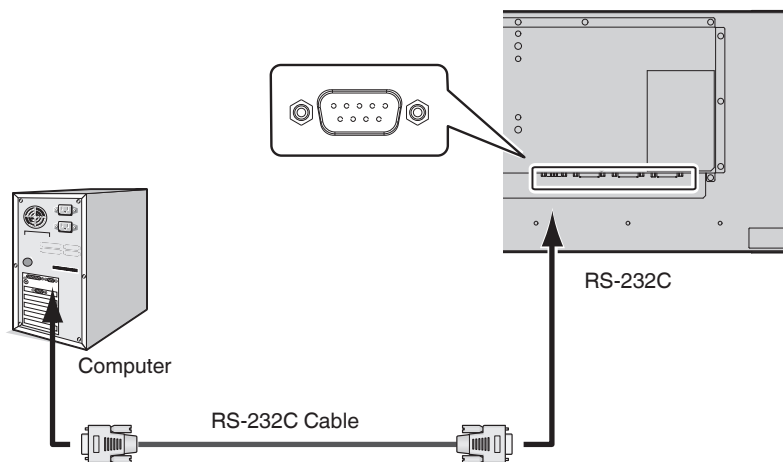

NOTE: If your computer is equipped only with a 25-pin serial port connector, a 25-pin serial port adapter is required. Contact your supplier for details.
For the pin assignment, please see "2) RS-232C input/output" on [page 21](#).

To control a monitor, please use the control command. Instructions for the control command can be found on the CD included with the monitor. The file is called "External_control.pdf".

1) Interface

PROTOCOL	RS-232C
BAUD RATE	9600 [bps]
DATA LENGTH	8 [bits]
PARITY	NONE
STOP BIT	1 [bit]
FLOW CONTROL	NONE

This LCD monitor uses RXD, TXD and GND lines for RS-232C control.

The reverse type cable (null modem cable) (not included) should be used for RS-232C control.

2) PIN ASSIGNMENT

RS-232C input/output

Pin No	Name
1	NC
2	RXD
3	TXD
4	NC
5	GND
6	NC
7	NC
8	NC
9	NC

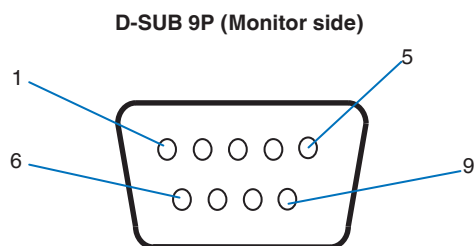

This LCD monitor uses RXD, TXD and GND lines for RS-232C control.

Controlling the LCD monitor via LAN Control

Connecting to a Network

Using a LAN cable allows you to specify the Network Settings and the Alert Mail Settings by using an HTTP server function.

To use a LAN connection you are required to assign an IP address.

CAUTION: RS-232C and LAN specification are exclusive.

Example of LAN connection:

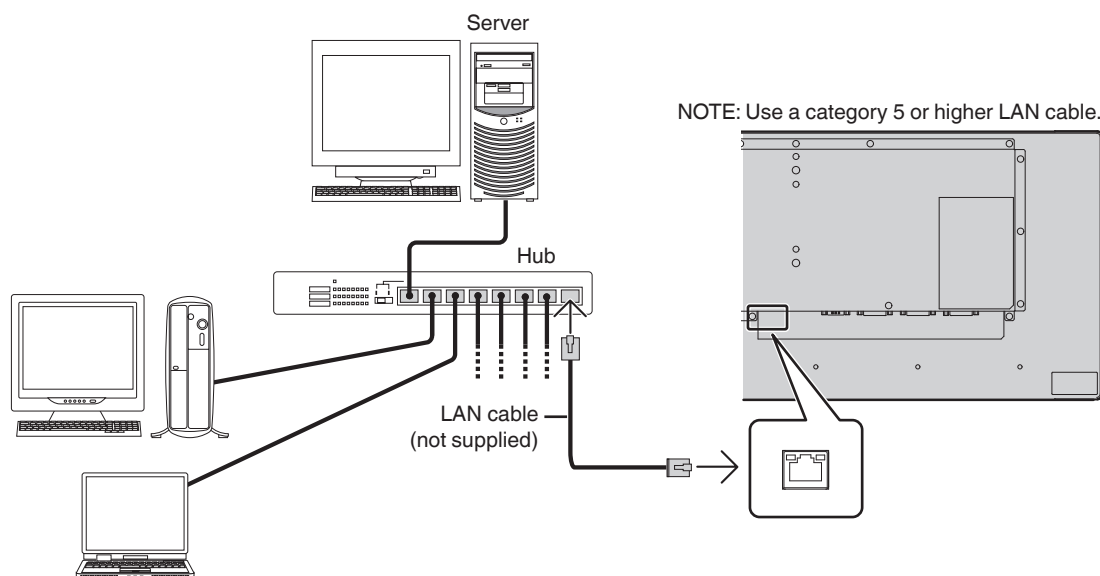

Network Setting by Using an HTTP Browser

Overview

Connecting the monitor to a network allows for monitor control from a computer via the network.

The IP address and subnet mask of the monitor can be set on the Network Setting screen of the web browser by using an HTTP server. Please be sure to use "Microsoft Internet Explorer 10" or a higher version for the web browser.

(This device uses "JavaScript" and "Cookies" and the browser should be set to accept these functions. The setting method will vary depending on the version of the browser. Please refer to the help files and the other information provided in your software.)

HINT: The default IP address is assigned automatically to the monitor.
The exclusive application can be downloaded from our website.

NOTE: If the MONITOR NETWORK SETTINGS screen does not appear in the web browser, press the Ctrl+F5 keys to refresh your web browser (or clear the cache).

If the monitor appears to be slow in response to commands or clicks on buttons in the browser, or the general speed of operation is unacceptable, this may be due to network traffic or the settings on your network. Should this happen, consult your network administrator.

The monitor may not respond if the buttons shown on the browser are repeatedly pressed in rapid intervals. Should this happen, wait a moment and repeat. If you still can't get a response, turn the monitor off and then back on.

To control a monitor please use the control command. See "Control command diagram" ([page 23](#)).

Preparation Before Use

Connect the monitor to the network, using a commercially available LAN cable, before attempting to use browser operations.

Operation with a browser that uses a proxy server may not be possible depending on the type of proxy server and the setting method. Although the type of proxy server will be a factor, it is possible that items that have been set will not be shown, depending on the effectiveness of the cache, and the contents set from the browser may not be reflected in operation. It is recommended that a proxy server is not used unless the network environment requires it.

External Control

Connecting external device

There are two ways to connect an external device to the monitor.

- RS-232C terminal.
Connecting an external device to the RS-232C terminal of the monitor with a RS-232C cable.
- LAN port.
Connecting an external device to the LAN port of the monitor with a LAN cable.
For further information regarding the type of LAN cable to use, please consult your network administrator.

Connecting interface

RS-232C Interface

PROTOCOL	RS-232C
BAUD RATE	9600 [bps]
DATA LENGTH	8 [bits]
PARITY	NONE
STOP BIT	1 [bit]
FLOW CONTROL	NONE

LAN interface

PROTOCOL	TCP
PORT NUMBER	7142
COMMUNICATION SPEED	AUTO setting (10/100Mbps)

Control command diagram

For other commands, please see "External_Control.pdf" file on the CD-ROM supplied with the monitor.

Function (Monitor ID = 1)	Code Data
Power ON	01 30 41 30 41 30 43 02 43 32 30 33 44 36 30 30 30 31 03 73 0d
Power OFF	01 30 41 30 41 30 43 02 43 32 30 33 44 36 30 30 30 34 03 76 0d
Input Source Select DVI1	01 30 41 30 45 30 41 02 30 30 36 30 30 30 30 33 03 71 0d or 01 30 41 30 45 30 41 02 30 30 36 30 30 30 30 34 03 76 0d
Input Source Select DVI2	01 30 41 30 45 30 41 02 30 30 36 30 30 30 31 30 03 73 0d or 01 30 41 30 45 30 41 02 31 31 30 36 30 30 31 30 03 73 0d

ASCII Control command

This monitor supports control command, which is listed in the "External_Control.pdf" file on the CD-ROM supplied with the monitor, but also supports common ASCII control command, which is used for controlling the NEC monitor or projector from a connected PC. For further information please visit our website.

Parameter

Input command

Input signal name	Response	Parameter
DVI1	dvi1	dvi1
DVI2	dvi2	dvi2

Status command

Response	Error status
error:light	Inverter or backlight abnormal
error:system	System error

Features

Reduced Footprint: Provides the ideal solution for environments with superior image quality.

OmniColor: Combines Six-axis color control and the sRGB standard. Six-axis color control permits color adjustments via six axes (R, G, B, C, M and Y) rather than through the three axes (R, G and B) previously available. The sRGB standard provides the monitor with a uniform color profile. This ensures that the colors displayed on the monitor are exactly the same as on the color printout (with sRGB supporting operating system and sRGB printer). This allows you to adjust the colors on your screen and customise the color accuracy of your monitor to a variety of standards.

sRGB Color Control: A color management standard which allows for color matching on computer monitors and other peripherals. The sRGB standard, which is based on a calibrated color space, allows for optimal color representation and backward compatibility with other common color standards.

OSD (On-Screen-Display) Controls: Allows you to quickly and easily adjust all elements of your screen image via easy to use on-screen menus.

Plug and Play: The Microsoft® solution with the Windows® operating system facilitates setup and installation by allowing the monitor to send its capabilities (such as screen size and resolutions supported) directly to your computer, automatically optimizing display performance.

IPM (Intelligent Power Manager) System: Provides innovative power-saving methods that allow the monitor to shift to a lower power consumption level when on but not in use, saving two-thirds of your monitor energy costs, reducing emissions and lowering the air conditioning costs of the workplace.

FullScan Capability: Allows you to use the entire screen area in most resolutions, significantly expanding image size.

ZOOM: Expands/reduces the image size in horizontal and vertical direction.

Self-diagnosis: If an internal error should occur, a failure state will be indicated.

HDCP (High-bandwidth Digital Content Protection): HDCP is a system for preventing illegal copying of video data sent over a digital signal. If you are unable to view material via the digital input, this does not necessarily mean that the monitor is not functioning properly. With the implementation of HDCP, there may be cases in which certain content is protected by HDCP and might not be displayed due to the decision/intention of the HDCP community (Digital Content Protection, LLC).

Troubleshooting

No picture

- The signal cable should be completely connected to the display card/computer.
- The display card should be completely seated in its slot.
- Check the main Power Switch, it should be in the ON position.
- Power Switches for the monitor and computer should be in the ON position.
- Make sure that a supported resolution has been selected on the display card or system being used. If in doubt, please refer to the user's manual of the display controller or system to change the resolution.
- Check the monitor and your display card with respect to compatibility and recommended signal timings.
- Check the signal cable connector for bent or pushed-in pins.
- The monitor automatically goes into standby at the preset time period after the video signal was lost. Press the power button on the remote control or press the power button on the monitor.
- If you unplug the signal cable when starting the computer, images may not be displayed. Turn off the monitor and the computer and then connect the signal cable and turn on the computer and the monitor.
- Check the OPTION POWER setting when you use option board accessories.

Power Button does not respond

- Unplug the power cord of the monitor from the AC outlet to turn off and reset the monitor.
- Check the main Power Switch on the monitor.

Image persistence

- Please be aware that LCD Technology may experience a phenomenon known as Image Persistence. Image Persistence occurs when a residual or "ghost" image of a previous image remains visible on the screen. Unlike CRT monitors, the image persistence of LCD monitors is not permanent, but single still image being displayed for a long period of time should be avoided. To alleviate image persistence, put the monitor into standby via remote control or turn the monitor's main power off for as long as the previous image was displayed. For example, if an image was on the monitor for one hour and a residual image remains, the monitor should be in standby or main power off for one hour to erase the image.

NOTE: As with all personal display devices, NEC DISPLAY SOLUTIONS recommends displaying moving images, using a moving screen saver, or changing still images at regular intervals whenever the screen is idle, or turning it into standby or main power off of the monitor when not in use.

The image is blinking

- If you use a signal repeater or distributor or a long cable, this may cause image roughness or blink for a moment. In this case please connect the cable to the monitor directly without using a repeater or a distributor, or replace the cable with a higher quality cable. Using a twisted pair extender may cause image roughness depending on the environment where the monitor is in or the cable you are using. For further information please ask your supplier.

The image is unstable, unfocused or swimming is apparent

- The signal cable should be completely attached to the computer.
- Use the OSD Image Adjust controls to focus and adjust the display by increasing or decreasing the fine adjustment. When the display mode is changed, the OSD Image Adjust settings may need to be re-adjusted.
- Check the monitor and your display card with respect to compatibility and recommended signal timings.
- If text looks garbled, change the video mode to non-interlaced and use a 60 Hz refresh rate.
- The image may be distorted when turning the power on or changing the settings.

LED on the monitor is not lit (no green or red color can be seen)

- The power Switch should be in the ON position and the power cord should be connected.
- Check the main Power Switch, it should be in the ON position.
- Make certain the computer is not in a power-saving mode (touch the keyboard or move the mouse).
- Check in the OSD that the power indicator option is set to ON.

LED colors, except for green, are blinking or glowing

- A certain failure might have occurred, please contact your supplier.
- The monitor could be in standby. Press the power on button on the remote control or press the power button on the monitor.

The image is not properly reproduced

- Use the OSD Image Adjust controls to increase or decrease the coarse adjustment.
- Make sure that a supported resolution has been selected on the display card or system being used. If in doubt, please refer to the user's manual of the display card or system to change the resolution.

Selected resolution is not displayed properly

- Use OSD Display Mode to enter Information menu and confirm that the appropriate resolution has been selected. If not, select corresponding option.

The Remote Control is not functioning

- Check the batteries status of the Remote Control.
- Check if the batteries are inserted correctly.
- Check if the Remote Control is pointing at the remote control sensor of the monitor.
- Check the status of IR LOCK SETTINGS.
- The remote control system may not function when direct sunlight or strong illumination strikes the remote control sensor of the monitor, or when there is an object in the path.

The SCHEDULE/Sleep Timer function is not working properly

- The "SCHEDULE" function will be disabled when the "Sleep Timer" is set.
- If the "Sleep Timer" function is enabled and the power to the LCD monitor is turned off when the power supply is interrupted unexpectedly, then the "Sleep Timer" will be reset.

Snowy Picture, Poor Sound in TV

- Check antenna/cable connection. Use new cable if necessary.

Interference in TV

- Check components for shielding, move away from monitor if necessary.

RS-232C or LAN control is not available

- Check RS-232C (reverse type) or the LAN cable. A category 5 or higher LAN cable is required for connection.

The monitor goes into standby automatically

- Please check "Sleep Timer" setting.

Either light vertical or horizontal stripes may appear, depending on the specific image pattern. This is not a product fault or degradation.

Specifications - BT421

Product Specifications

LCD Module		42" / 1071.7 mm diagonal	
		Pixel Pitch:	0.542 mm
		Resolution:	1920 x 480
		Color:	Over 16 million colors
		Brightness:	700 cd/m ² (MAX) @25°C
		Contrast Ratio:	4000:1
		Viewing Angle:	Left/Right: 178° (typ) @ CR>10, Up/Down: 178° (typ) @ CR>10
Frequency		Horizontal:	29 - 81 kHz
		Vertical:	56 Hz - 76 Hz
Pixel Clock		25 MHz - 170 MHz	
Viewable Size		1039.68 x 259.92 mm	
Input Signal			
DVI	DVI-D 24pin	Digital RGB	DVI T.M.D.S (HDCP 1.2) VGA60, SVGA60, XGA60, WXGA60, SXGA60, UXGA60, 1920 x 1080 (60Hz)* ¹ , * ³ , 1920 x 480 (60Hz), 1920 x 540 (60Hz), 1920 x 960 (60Hz)
Output Signal			
DVI	DVI-D 24pin	Digital RGB	DVI T.M.D.S
Control		RS-232C In* ⁴ :	9 Pin D-sub
		LAN* ⁴ :	RJ-45 10 BASE-T/100 BASE-TX x 1
Power Supply		0.34 - 0.76 A @ 100-240V AC, 50/60Hz	
Operational Environment		Temperature* ¹ :	0 - 50°C / 32 - 122°F
		Humidity:	20 - 80% (without condensation)
		Altitude:	0 - 2000 m (Brightness may decrease with altitude)
Storage Environment		Temperature:	-20 - 60°C / -4 - 140°F
		Humidity:	10 - 90% (without condensation) / 90% - 3.5% x (Temp - 40 C) regarding over 40°C
Dimension		1059.9 (W) x 288.9 (H) x 64.7 (D) mm / 41.7 (W) x 11.4 (H) x 2.5 (D) inches	
Weight		9.3 kg (20.5 lbs)	
VESA compatible mounting interface		400 mm x 100 mm (M6, 4 Holes)	
Power Management		VESA DPM	
Plug & Play		VESA DDC2B	
Accessories		Setup manual, Power Cord, Video Signal cable, Remote Control, AAA Battery x 2, Clamp, Screw	

NOTE: Technical specifications are subject to change without notice.

*¹: Any image whose resolution is bigger than the limit allowed will be displayed in compressed format.

*²: When you use option board accessories, please contact your supplier for detailed information.

*³: Reproduced text may look blurred.

*⁴: Exclusive specification

Manufacturer's Recycling and Energy Information

NEC DISPLAY SOLUTIONS is strongly committed to environmental protection and sees recycling as one of the company's top priorities in trying to minimize the burden placed on the environment. We are engaged in developing environmentally-friendly products, and always strive to help define and comply with the latest independent standards from agencies such as ISO (International Organisation for Standardization) and TCO (Swedish Trades Union).

Disposing of your old NEC product

The aim of recycling is to gain an environmental benefit by means of re-use, upgrading, reconditioning or reclamation of material. Dedicated recycling sites ensure that environmentally harmful components are properly handled and securely disposed. To ensure the best recycling of our products, **NEC DISPLAY SOLUTIONS offers a variety of recycling procedures** and gives advice on how to handle the product in an environmentally sensitive way, once it has reached the end of its life.

All required information concerning the disposal of the product and country-specific information on recycling facilities can be found on our following websites:

<https://www.nec-display-solutions.com/p/greenvision/en/greenvision.xhtml> (in Europe),

<http://www.nec-display.com> (in Japan) or

<http://www.necdisplay.com> (in USA).

Energy Saving

This monitor features an advanced energy saving capability. When a Display Power Management signal is sent to the monitor, the Energy Saving mode is activated. The monitor enters a single Energy Saving mode.

For additional information visit:

<http://www.necdisplay.com/> (in USA)

<http://www.nec-display-solutions.com/> (in Europe)

<http://www.nec-display.com/global/index.html> (Global)

Power consumption: 2 W or less (Glowing amber).
Time for power management function: 10 sec. (Default setting)
(Except for a condition that the monitor has plural signal inputs.)

Power consumption: 0.5 W or less (Blinking amber).
Time for power management function: 3 min. (Default setting)
(Except for a condition that the monitor has plural signal inputs.)

WEEE Mark (European Directive 2012/19/EU and amendments)



Disposing of your used product: In the European Union

EU-wide legislation as implemented in each Member State requires that used electrical and electronic products carrying the mark (left) must be disposed of separately from normal household waste. This includes monitors and electrical accessories, such as signal cables or power cords. When you dispose of such products, please follow the guidance of your local authority or ask the shop where you purchased the product, or if applicable, follow applicable legislation or agreement you may have. The mark on electrical and electronic products may only apply to the current European Union Member States.

Outside the European Union

If you wish to dispose of used electrical and electronic products outside the European Union, please contact your local authority and ask for the correct method of disposal.



For EU: The crossed-out wheeled bin implies that used batteries should not be put to the general household waste! There is a separate collection system for used batteries, to allow proper treatment and recycling in accordance with legislation.

According to EU directive 2006/66/EC, the battery can't be disposed improperly. The battery shall be separated to collect by local service.