

**OKI**



**smart PrintSuperVision**

**User's Manual**

# How to Read This Manual

## Notations

The following notations may be used in this manual.

- Print job accounting client software → Client software
- Generic name for Windows, Windows 10, Windows 8.1, Windows 8, Windows 7, Windows Vista, Windows Server 2012 R2, Windows Server 2012, Windows Server 2008 R2, Windows Server 2008 → Windows

\*Unless otherwise specified, the 64-bit version is included in Windows 10, Windows 8.1, Windows 8, Windows 7, Windows Vista and Windows Server 2008.

- Mac OS X 10.3 and later → Mac OS X

Unless otherwise specified, Windows 7 is used as an example for Windows, and Mac OS X 10.8 is used as an example for Mac in this manual.

The notations used in this manual may differ from actual interface items depending on your OS or model.

## Terms



**Terms are cautions or restrictions that are required to operate this software correctly. Be sure to read sections with this mark to ensure operations are performed correctly.**



**Indicates information that is useful to know or refer to when using the software. You should read the sections with this mark.**

## Important

### Trademark Information

OKI is a registered trademark of Oki Electric Industry Co., Ltd.

Microsoft, Windows, Windows Server, Windows Vista, Excel, Internet Explorer and Active Directory are the trademarks or registered trademarks of Microsoft Corporation in the United States and other countries.

Macintosh, Mac OS and OS X are the trademarks or registered trademarks of Apple Computers Inc. in the United States and other countries.

PageMaker is the trademark or registered trademark of Adobe Systems Incorporated in the United States and other countries.

SD Memory Card is the trademark or registered trademark of the SD Association.

Other product names and brand names are registered trademarks or trademarks of their proprietors.



## About This Manual

1. Unauthorized copying of this manual in whole or in part is strictly forbidden.
2. The contents of this manual may be changed at any time without prior notice.
3. Every effort has been made to ensure that the information in this manual is complete, accurate and up-to-date. However, in the unlikely event a mistake or missing entry is discovered, contact the local vendor.
4. While all reasonable efforts have been made to make this manual as accurate and helpful as possible, we make no warranty of any kind, expressed or implied, as to the accuracy or completeness of the information contained herein.

## Manual Copyright

Oki Data Corporation owns the entire copyright to this manual. Unauthorized reproduction, transcription, and translation of this document are prohibited.

Prior written permission must be obtained from Oki Data Corporation to reproduce, transcribe, or translate any sections of this manual.

© 2014 Oki Data Corporation

# Contents

How to Read This Manual.....	2
Notations .....	2
Terms.....	2
Important .....	2
Trademark Information .....	2
About This Manual.....	3
Manual Copyright.....	3
<b>1. Introduction .....</b>	<b>10</b>
Merits of smart PrintSuperVision (sPSV).....	10
Mechanisms of sPSV .....	11
Configuration of sPSV .....	12
Information Required for Settings and Examples of Settings.....	12
User Accounts.....	12
Preparing User Information .....	14
Example Settings .....	15
Setting Up sPSV .....	23
Administrator (Administrator PC).....	23
Users (Client Computers) .....	24
Create a Settings Sheet .....	25
<b>2. Setting Up smart PrintSuperVision (sPSV) .....</b>	<b>36</b>
Operating Environments .....	36
Recommended Computer Specs.....	36
Standard Ports.....	36
Supported Browsers .....	36
Other .....	36
How to Install .....	37
<b>3. Setting Up the Print Job Accounting Client Software.....</b>	<b>41</b>
Setting Up in Windows .....	41
Operating Environments.....	41
Installing the Client Software.....	41
Setting Up in Mac OS X .....	43
Operating Environments.....	43
Installing the Client Software.....	43
<b>4. If Using Active Directory .....</b>	<b>45</b>
What Can It Be Used for? .....	45
Settings for Connecting to Active Directory .....	45
Connecting to an Active Directory in a Specified Domain.....	45
Changing the Time or Interval at Which Update of Active Directory is Confirmed ...	46
To update Active Directory Immediately .....	47

<b>5. smart PrintSuperVision (sPSV)</b> .....	<b>49</b>
Top Page.....	49
Login Window .....	50
Main Menu .....	51
[Show Device Usage Status].....	52
[Restrict Device Use] .....	58
[Notify Device Management Status].....	64
Details Screen .....	79
[Manage] Tab .....	80
[Report] Tab.....	89
[Option] Tab.....	92
[Help] Tab.....	101
[Help Icon].....	105
<b>6. Print Job Accounting Client Software</b> .....	<b>107</b>
When Using Windows.....	108
Setting the Job Account Mode .....	108
Using Tab Mode .....	109
Using Pop-up Mode.....	109
Using Hide Mode .....	110
Using in Unsupported Mode .....	113
When Using Mac OS X.....	114
Registering the Job Account ID (PIN) .....	114
Registering Multiple Users Together .....	114
Changing a Job Account ID (PIN) or User Name .....	115
Deleting a Job Account ID (PIN) or User Name.....	116
Exporting Data for Client Software .....	116
<b>7. Registering and Managing Devices</b> .....	<b>118</b>
Registering Devices .....	118
Start sPSV .....	118
Registering Devices .....	119
Configure the Settings of the Registered Devices.....	121
Management Group Registration .....	125
Changing Settings for Management Groups .....	127
Deleting Management Groups.....	128
<b>8. Registering and Managing Users</b> .....	<b>130</b>
Individual Management .....	130
User Registration .....	130
Registering User Group .....	131
Registering Users and User Groups to a Device .....	133
Changing User/User Group Information.....	135
Changing User Group Assignment .....	136
Deleting Users/User Groups.....	137

Active Directory-linked Management.....	138
Adding Users/User Groups.....	138
Changing User Information.....	139
Changing Attributes Displayed in the User List .....	141
Deleting Users/User Groups.....	141
<b>9. Restricting Device Use .....</b>	<b>143</b>
What Can Be Done With Use Restrictions .....	143
Usage Limitations.....	143
Setting Use Restrictions for User Names.....	147
Adding from the User.....	147
Adding Manually .....	149
Adding from the Job Log .....	150
Creating a CSV File to Add in a Batch.....	150
Importing Users Specified in Windows.....	151
Adding by Associating a PIN to an Authentication User Name .....	152
Adding Unregistered User Settings .....	153
Registering Roles .....	153
Setting LDAP Authentication.....	154
Setting Use Restrictions Targeted to the Document Name .....	155
Adding from the Job Log .....	155
Adding Manually .....	157
Adding Unregistered Item Setting.....	157
Setting Use Restrictions Targeted to the Host Name .....	158
Adding from the Job Log .....	158
Adding Manually .....	160
Adding Unregistered Item Settings .....	160
Setting Use Restrictions Targeted to the Application Name .....	161
Adding Manually .....	161
Adding from the Job Log .....	162
Adding Unregistered Item Settings .....	163
Displaying Device Registered Use Restrictions .....	164
Changing Device Registered Use Restrictions .....	164
Delete Device Registered Use Restrictions .....	166
Deleting Individual Use Restrictions .....	166
Deleting All Use Restrictions (Restoring Initial Status) .....	167
Temporarily Disabling Use Restrictions .....	168
Enabling Use Restrictions .....	168
<b>10. Managing Available Usage .....</b>	<b>170</b>
What can be done with available usage.....	170
Setting the Available Usage.....	170
Changing the Priority Level of User Group.....	171
Creating Fee Charge Definitions .....	172
Setting Fee Definitions for Devices .....	176
Changing Fee Charge Definitions.....	177

Deleting Fee Charge Definitions .....	178
Checking and Resetting Usage Statuses .....	178
Sending Print Prohibited/Permitted by Mail .....	179
<b>11. Checking the Device Status, Consumable Life or Printing</b>	
<b>Status .....</b>	<b>182</b>
Checking the Device Usage Status .....	182
Checking the Consumable Life .....	183
Checking the Printing Status .....	185
Checking Device Statuses .....	187
Changing Interval and Time for Acquiring Device Information and Statuses .....	189
<b>12. Managing Job Logs .....</b>	<b>192</b>
What Can Be Done with Job Logs .....	192
Configuring the Job Log Acquisition Settings .....	192
Providing Time Notifications for Devices .....	194
Displaying Job Logs .....	194
Displaying Job Logs .....	194
Displaying All Job Log Items (Detail Display) .....	195
Changing Job Items To Be Displayed .....	196
Deleting Job Logs .....	197
Outputting Job Logs as a CSV File .....	197
Stopping Job Log Acquisition .....	198
Operations When the Log Is Full .....	199
Displaying Totals .....	200
Displaying Totals .....	200
Displaying All Aggregated Items (Detail Display) .....	201
Changing Aggregate Items .....	201
Outputting the Aggregation Results As a CSV File .....	202
Receiving Notifications of Usage Status Totals by Email .....	203
Sending Job Logs by Email .....	204
Changing the Closing Date .....	205
<b>13. Environment Settings .....</b>	<b>207</b>
Changing the Database Destination .....	207
Changing the Web Service Settings .....	208
Setting the Outgoing Mail Function .....	210
Setting the Outgoing Mail Function .....	210
Configuring the Settings for Notification Email .....	211
Sending Database Error Notification Email .....	213
Auto Status Refresh Service .....	214

14. Other Functions .....	217
Receiving Email Notifications of Job Results .....	217
Limiting the Size and Number of Attachments .....	218
Deleting Registered Devices .....	218
If the Device Connection Destination or IP Address Has Been Changed .....	219
Automatically Reconnecting When the Device IP Address Is Changed .....	220
Back Up/Restore .....	221
To Change Device Management to a Different Computer .....	222
Checking the Server ID .....	223
Registering the Installation Position of Devices Belonging to a Management Group.....	223
15. Uninstalling the Software .....	226
Uninstalling sPSV .....	226
Deleting the Print Job Accounting Client Software (Windows).....	227
Deleting the Print Job Accounting Client Software (Mac OS X) .....	227
16. Troubleshooting .....	229
17. Frequently Asked Questions (FAQ).....	235
18. Terms.....	238
19. Resources .....	241
List of Available Functions.....	241
Information That Can Be Acquired as a Job Log.....	243
Items That Can Be Aggregated.....	248
Basic Procedures in Windows.....	253
Index.....	255

# 1. Introduction

---

Merits of smart PrintSuperVision (sPSV) .....	10
Mechanisms of sPSV .....	11
Configuration of sPSV .....	12
Information Required for Settings and Examples of Settings.....	12
User Accounts.....	12
Preparing User Information.....	14
Example Settings .....	15
Setting Up sPSV.....	23
Administrator (Administrator PC).....	23
Users (Client Computers) .....	24
Create a Settings Sheet .....	25

---

# 1. Introduction

---

This section explains the merits, mechanisms and configuration of smart PrintSuperVision (sPSV), and the contents that need to be decided before setup.

## Merits of smart PrintSuperVision (sPSV)

sPSV allows devices such as printers and multifunction printers to be managed in the following ways:

- Detailed configuration of printing limitations according to the user or document
- Acquisition and summary of various forms of information (job logs) related to printing
- Device management such as management of remaining toner and image drum

### Management of Printing Limitations

- It is possible to set whether or not to allow printing for each user, document (file name), application, etc.
- It is also possible to set whether or not to allow color printing in a similar manner.
- Printer restrictions can be set for multiple users or devices at the same time. For example, it is possible to allow the general affairs division to print from any device but only allow the accounting division to print from devices installed in their own division.
- A printing limit (for example a maximum number of pages) can be set for each user or device.

### Job Log Acquisition and Summary

- Information including the printed date and time, user name, quantity and paper size can be acquired and summarized in job logs.
- Job logs can be output as a CSV file for use in commercially available spreadsheet software.



**A CSV file is a text file separated by commas and is a file format that is commonly used for converting data between spreadsheets and database management software.**

### Device Management

- Information such as print volume, usage of consumables and status information can be collected and summarized, and the results can be displayed on the screen or sent as an email notification.

### Support for Both Windows and Mac OS X

- Both Windows and Mac OS X are supported as client environments.



# Mechanisms of sPSV

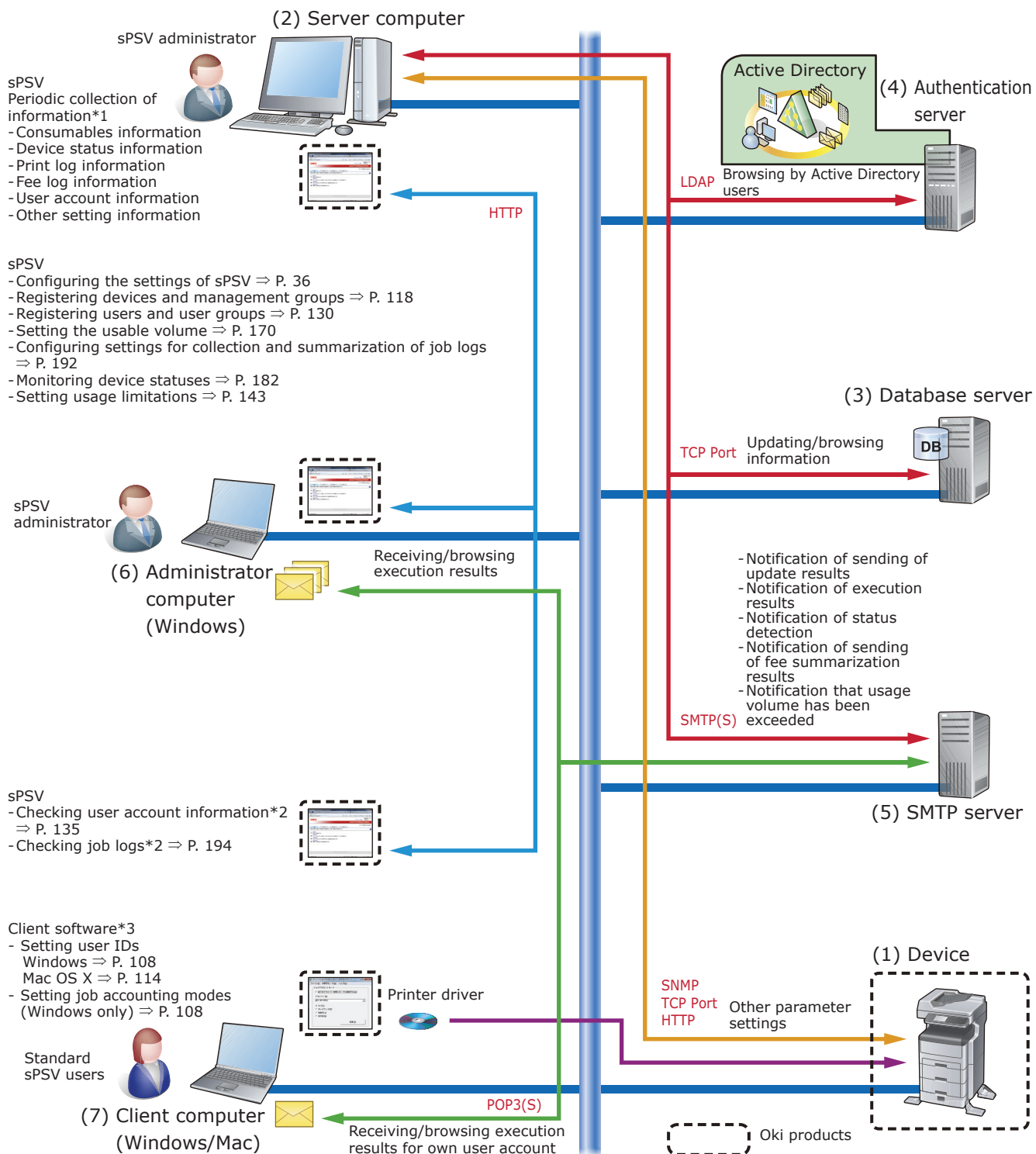

\*1 Information is gathered according to the settings on the administrator computer and client computers.

\*2 Users can only browse this for their own user account

\*3 This needs to be installed if identifying user IDs by user ID (PIN).

No.	Name	Details
(1)	Device	Printers, multifunction printers, etc. managed using sPSV
(2)	Server computer	The server on which sPSV is installed
(3)	Database server	The server that executes database processes
(4)	Authentication server	The server that executes directory services (in the case of sPSV, this refers to Active Directory.)
(5)	SMTP server	The server that executes email processes

No.	Name	Details
(6)	Administrator computer (Windows)	By logging in as an sPSV administrator in a web browser and accessing the server computers from this computer, it is possible to register devices, users and user groups, set usage limitations and manage devices.
(7)	Client computer (Windows/Mac)	A computer on which users can print pages and browse information managed in sPSV. - If users are identified by user IDs (PINs), it is possible to set usage limitations and summarize printing costs for specific users by installing the client software and registering user IDs (PINs).



- **The server computer (2) can also be used for functions (3), (4) and (5).**
- **It is possible to browse information managed by sPSV, set usage limitations and summarize printing costs from the server computer (2). Import/export, database and web service settings can be changed when logged in to the server computer as an administrator.**

## Configuration of sPSV

Name	Installation location	Operating system	Description
Smart PrintSuperVision	Server computer	Windows	This is a management tool for the system administrator. It can be used to register devices, users and user groups, set printing limitations and manage devices. Job logs acquired from devices are saved to the database.
Print job accounting client software (hereinafter abbreviated as "client software")	Client computer	Windows/Mac OS X	Install sPSV on client computers if using user IDs (PINs) to identify users. By registering user IDs (PINs), it is possible to set usage limitations and summarize printing costs for specific users.

## Information Required for Settings and Examples of Settings

Users can be set when necessary by using sPSV and the client software.

Before setup, it is recommended to decide which users will use the device.



- **Users can be added/deleted at a later date. For details, see "8. Registering and Managing Users" (P. 130).**
- **User information from Active Directory can be used when linking to Active Directory. For details, see "Active Directory-linked Management" (P. 138).**

## User Accounts

The functions that can be used differ depending on user authority. For information on creating and changing user accounts, see "User Registration" (P. 130).

Authority	Description
Administrator	This account is used by the information system manager in charge of setting up sPSV and changing settings. All functions in sPSV can be viewed and configured with this account.

Authority	Description
Standard user	Ordinary users are those who have a registered sPSV account. In addition to viewing the same information as guest users, these users can browse information relating to their account and edit some of their account information.
Guest user	Users are those who do not have a registered sPSV account. These users can only browse certain information.

### Main User Authority

For details on functions that can be used, see "List of Available Functions" (P. 241).

●: Can be used ▲: Can be partially used —: Cannot be used

Main functions	Description	User authority		
		Guest User	Standard User	Administrator
Searching and registering devices	Creating management groups, configuring device settings, etc.	—	—	●
Configuring sPSV settings	Configuring web service settings, mail server settings, database settings, etc.	—	—	●
Configuring sPSV user settings	Creating user groups, configuring restriction settings, etc.	—	▲*2	●
Registering schedules	Configuring settings to periodically execute schedule items and provide notifications of the results	—	—	●
Acquisition and summarization of information (report)	Configuring settings to acquire information such as fee logs, consumables information and print counters, summarizing the results and configuring settings for notifications of this information	▲*1	▲*3	●
Monitoring statuses	Monitoring statuses and configuring notification settings	—	—	●
Device usage limitations	Setting access restrictions for devices	—	—	●
Help tab	Viewing help pages	●	●	●

\*1: These users can only view information such as the consumables information and print counter of a device.

\*2: These users can only view their own account information and edit some of their information.

\*3: These users can only view job log information for their own account.

## Preparing User Information

PIN, user name and password are required when registering a user.

Read the explanation below carefully, and prepare the PIN, user name and password according to the objectives of the printing limitations and log.

### sPSV

Setting information	Details	Registration range
PIN	User ID is a number assigned to each user for identification. Settings such as printing limitations and cost burden are set for each user ID in sPSV.	1 - 999999999
User name	The name used when logging in to sPSV.	Up to 32 1- or 2-byte characters (Names cannot include "")
Password	The password used to log in to sPSV.	Up to 32 characters

### Client Software

Setting information	Details	Registration range
User ID (PIN)	The user ID (PIN) used in sPSV When printing limitations or logs are configured for each department, the same ID number is assigned to all users within the department.	1 - 999999999
User name	This setting is for recognizing the actual user who ordered the print job from the client computer. This information is stored in the "User name" section of the job log.	Up to 80 1-byte characters or 40 2-byte characters (Names cannot include "")



**The following restrictions apply depending on the model.**

- When printing is performed without setting the user ID (PIN), printing is performed by an unregistered user and 0 is recorded as the user ID (PIN) in the log.
- When printing is performed from a Windows or Mac OS X computer on which the client software is not set up, the user is an unregistered user, the user ID is 0, and the user name used to log on to either Windows or Mac OS X recorded in the log as the user name.
- In some applications, such as the Windows version of InDesign, data that does not use printer drivers may be created. In this case, the user is an unregistered user, the user ID is 0, and the user name is recorded as a blank space in the job log.
- The user ID (PIN) is registered as a blank space in the job log.

## Example Settings

The table below shows examples of settings for each method of setting use restrictions and summarizing job logs.

### When you want to permit printing for registered users only. (prohibit printing by unregistered users.)

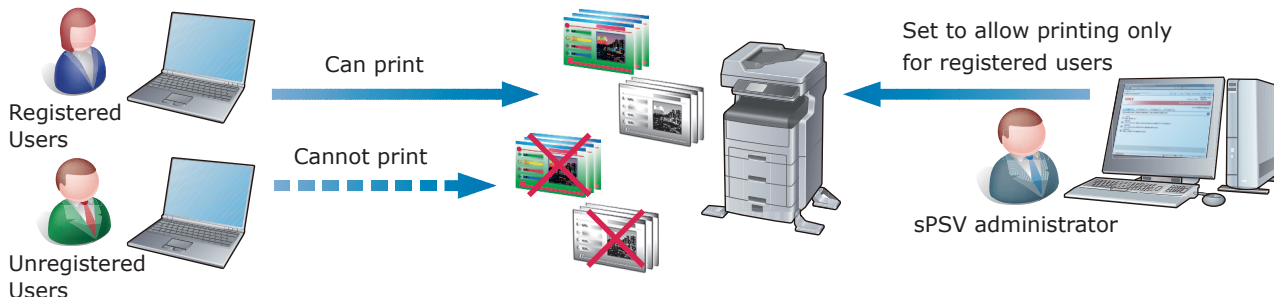

Configuring the settings in sPSV	Configuring the settings in the client software
(1) Register users permitted to print in sPSV. ⇒ P. 130 (2) Assign registered users printing permission for devices and set "Prohibit printing" as the usage restriction for unregistered users (Other Login Names). ⇒ P. 147, P. 153 (3) Set the printing policy as "Identify users by PIN" and register this setting to the device. ⇒ P. 149	Set the user IDs (PINs) of users that are permitted to print. ⇒ P. 107
(1) Register users permitted to print in sPSV. ⇒ P. 130 (2) Assign registered users printing permission for devices and set "Prohibit printing" as the usage restriction for unregistered users (Other Login Names). ⇒ P. 147, P. 153 (3) Set the printing policy as "Identify users by user name" and register this setting to the device. ⇒ P. 149	The client software is not used.

**When you want to permit color printing for registered users only. (prohibit color printing by unregistered users.)**

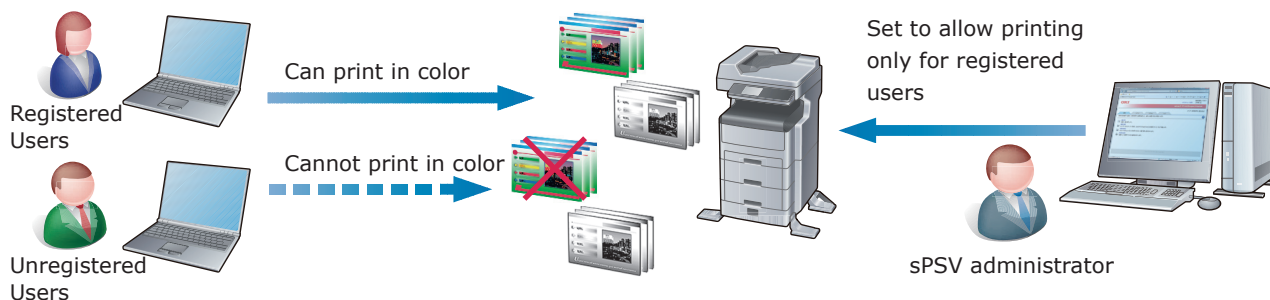

Configuring the settings in sPSV	Configuring the settings in the client software
<ul style="list-style-type: none"> <li>(1) Register users permitted to print in color in sPSV. ⇒ P. 130</li> <li>(2) Assign print permissions to users registered to the device, and prohibit printing by unregistered users (OtherLoginNames) or guests (Guest). ⇒ P. 147, P. 153</li> <li>(3) Set the printing policy as "Identify users by PIN" and register this setting to the device. ⇒ P. 149</li> </ul>	<p>Set the user IDs (PINs) of users to whom color printing is permitted. ⇒ P. 107</p>
<ul style="list-style-type: none"> <li>(1) Register users permitted to print in color in sPSV. ⇒ P. 130</li> <li>(2) Assign print permissions to users registered to the device, and prohibit printing by unregistered users (OtherLoginNames) or guests. ⇒ P. 147, P. 153</li> <li>(3) Set the printing policy as "Identify users by user name" and register this setting to the device. ⇒ P. 149</li> </ul>	<p>The client software is not used.</p>

**When you want to permit color printing to some users but only black and white printing to others.**

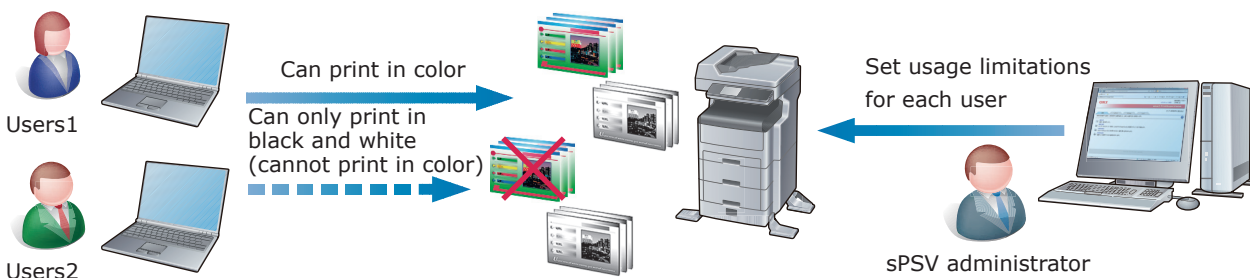

Configuring the settings in sPSV	Configuring the settings in the client software
(1) Register users to be set with printing limitations in sPSV. ⇒ P. 130 (2) Assign color printing permission to users registered to devices and set "Print in black and white" as the usage restriction. ⇒ P. 147 (3) Set the printing policy as "Identify users by PIN" and register this setting to the device. ⇒ P. 149	Set the user IDs (PINs) of the users. ⇒ P. 107
(1) Register users permitted to print in sPSV. ⇒ P. 130 (2) Assign color printing permission to users registered to devices and set "Print in black and white" as the usage restriction. ⇒ P. 147 (3) Set the printing policy as "Identify users by user name" and register this setting to the device. ⇒ P. 149	The client software is not used.

**When you want to keep a record of the printing limitations and job log for each user.**

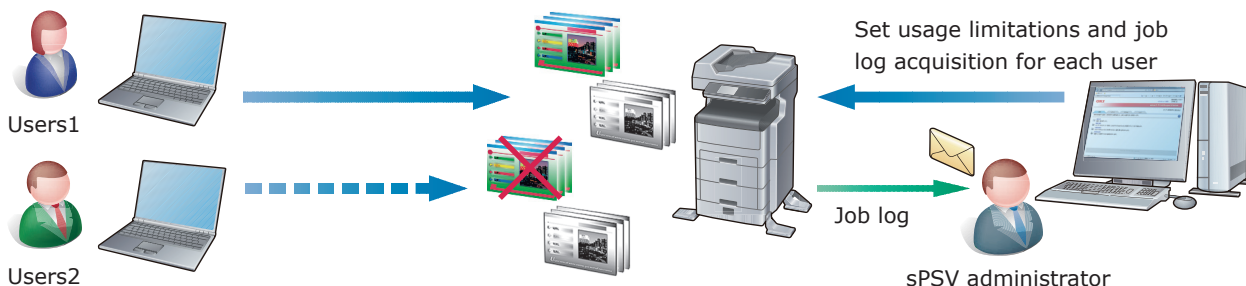

Configuring the settings in sPSV	Configuring the settings in the client software
<ul style="list-style-type: none"> <li>(1) Register users in sPSV. ⇒ P. 130</li> <li>(2) Set usage limitations for each user registered to the device(s). ⇒ P. 147</li> <li>(3) Set the printing policy as "Identify users by PIN" and register this setting to the device. ⇒ P. 149</li> <li>(4) Configure the settings for acquiring job logs from the device(s). ⇒ P. 192</li> <li>(5) Set the job log summarization method. ⇒ P. 200</li> </ul>	<p>Set the user IDs (PINs) of the users. ⇒ P. 107</p>
<ul style="list-style-type: none"> <li>(1) Register users in sPSV. ⇒ P. 130</li> <li>(2) Set usage limitations for each user registered to the device(s). ⇒ P. 147</li> <li>(3) Set the printing policy as "Identify users by user name" and register this setting to the device. ⇒ P. 149</li> <li>(4) Configure the settings for acquiring job logs from the device(s). ⇒ P. 192</li> <li>(5) Set the job log summarization method. ⇒ P. 200</li> </ul>	<p>The client software is not used.</p>



**When you want to keep a record of the printing limitations and job log for each department.**

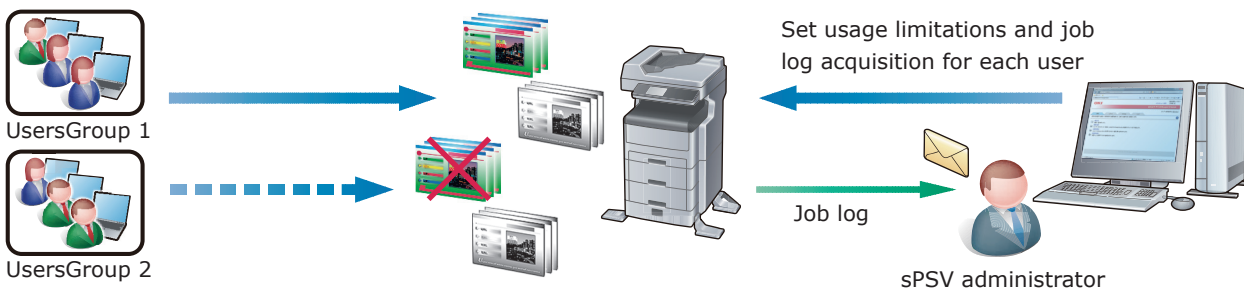

Configuring the settings in sPSV	Configuring the settings in the client software
<ul style="list-style-type: none"> <li>(1) Create a user group for each department and register the users in sPSV. ⇒ P. 130</li> <li>(2) Set usage limitations for each user group registered to the device(s). ⇒ P. 147</li> <li>(3) Set the printing policy as "Identify users by PIN" and register this setting to the device. ⇒ P. 149</li> <li>(4) Configure the settings for acquiring job logs from the device(s). ⇒ P. 192</li> <li>(5) Set the job log summarization method. ⇒ P. 200</li> </ul>	<p>Set the user IDs (PINs) of the users. ⇒ P. 107</p>
<ul style="list-style-type: none"> <li>(1) Create a user group for each department and register the users in sPSV. ⇒ P. 130</li> <li>(2) Set usage limitations for each user group registered to the device(s). ⇒ P. 147</li> <li>(3) Set the printing policy as "Identify users by user name" and register this setting to the device. ⇒ P. 149</li> <li>(4) Configure the settings for acquiring job logs from the device(s). ⇒ P. 192</li> <li>(5) Set the job log summarization method. ⇒ P. 200</li> </ul>	<p>The client software is not used.</p>

**When you want to set printing limitations for each department but keep a record of the job log for each department.**

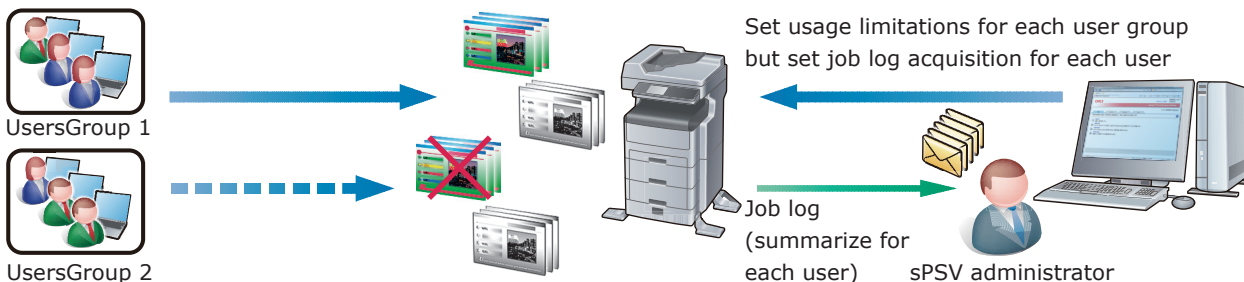

Configuring the settings in sPSV	Configuring the settings in the client software
<ul style="list-style-type: none"> <li>(1) Create a user group for each department and register the users in sPSV. ⇒ P. 130</li> <li>(2) Set usage limitations for each user group registered to the device(s). ⇒ P. 147</li> <li>(3) Set the printing policy as "Identify users by PIN" and register this setting to the device. ⇒ P. 149</li> <li>(4) Configure the settings for acquiring job logs from the device(s). ⇒ P. 192</li> <li>(5) Configure the settings so that job logs are summarized for each user. ⇒ P. 200</li> </ul>	<p>Set the user IDs (PINs) of the users. ⇒ P. 107</p>
<ul style="list-style-type: none"> <li>(1) Create a user group for each department and register the users in sPSV. ⇒ P. 130</li> <li>(2) Set usage limitations for each user group registered to the device(s). ⇒ P. 147</li> <li>(3) Set the printing policy as "Identify users by user name" and register this setting to the device. ⇒ P. 149</li> <li>(4) Configure the settings for acquiring job logs from the device(s). ⇒ P. 192</li> <li>(5) Configure the settings so that job logs are summarized for each user. ⇒ P. 200</li> </ul>	<p>The client software is not used.</p>

**When you want to set usable volumes and summarize job logs for each department but also set individual usable volumes for some users within the department and summarize the corresponding job logs.**

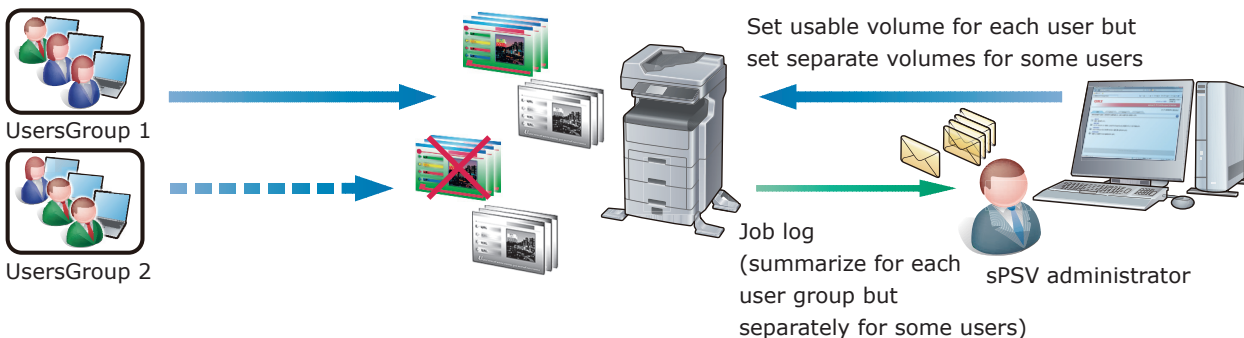

Configuring the settings in sPSV	Configuring the settings in the client software
<p>(1) Create a user group for each department and register the users in sPSV. ⇒ P. 130 Do not check "Include in usable volume summarization for user group" for some users. ⇒ P. 170</p> <p>(2) Set usable volumes for each user group and set of specific users registered to the device(s). ⇒ P. 147</p> <p>(3) Set the printing policy as "Identify users by PIN" and register this setting to the device. ⇒ P. 149</p> <p>(4) Configure the settings for acquiring job logs from the device(s). ⇒ P. 192</p> <p>(5) Configure the settings so that job logs are summarized for each user and for each user group. ⇒ P. 200</p>	<p>Set the user IDs (PINs) of the users. ⇒ P. 107</p>
<p>(1) Create a user group for each department and register the users in sPSV. ⇒ P. 130 Do not check "Include in usable volume summarization for user group" for some users. ⇒ P. 170</p> <p>(2) Set usable volumes for each user group and set of specific users registered to the device(s). ⇒ P. 147</p> <p>(3) Set the printing policy as "Identify users by user name" and register this setting to the device. ⇒ P. 149</p> <p>(4) Configure the settings for acquiring job logs from the device(s). ⇒ P. 192</p> <p>(5) Configure the settings so that job logs are summarized for each user and for each user group. ⇒ P. 200</p>	<p>The client software is not used.</p>

## When you want to just collect a job log without imposing print restrictions.

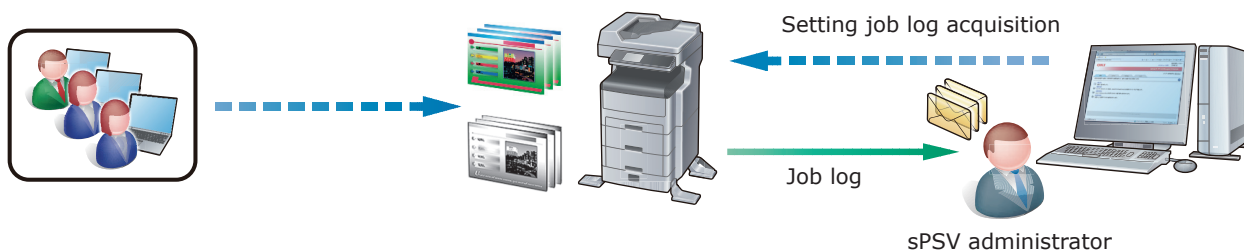

Configuring the settings in sPSV	Configuring the settings in the client software
(1) Configure the settings for acquiring job logs from the device(s). ⇒ P. 192 (2) Set the job log summarization method. ⇒ P. 200	The client software is not used. The login user name used for Windows or Mac OS X is recorded in the job log as the user name.

## When you want to permit printing only for users registered to an Active Directory domain. (prohibit printing by unregistered users.)

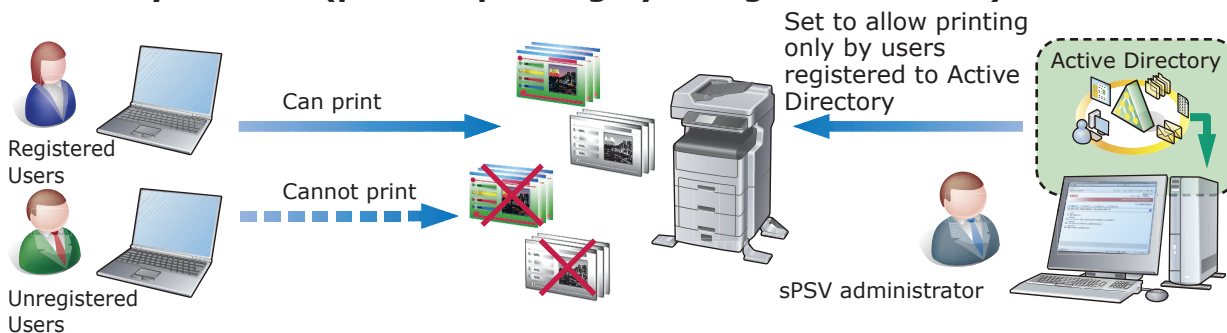

Configuring the settings in sPSV	Configuring the settings in the client software
(1) Configure the settings for connecting to Active Directory. ⇒ P. 45 (2) Register users to whom printing from Active Directory is permitted in sPSV. ⇒ P. 138 (3) Assign registered users printing permission for devices and set "Prohibit color printing" as the usage restriction for unregistered users (Other Login Names). ⇒ P. 147 (4) Set the printing policy as "Identify users by PIN" and register this setting to the device. ⇒ P. 149	Set the user IDs (PINs) of users that are permitted to print. ⇒ P. 107
(1) Configure the settings for connecting to Active Directory. ⇒ P. 45 (2) Register users to whom printing from Active Directory is permitted in sPSV. ⇒ P. 138 (3) Assign registered users printing permission for devices and set "Prohibit color printing" as the usage restriction for unregistered users (Other Login Names). ⇒ P. 147 (4) Set the printing policy as "Identify users by user name" and register this setting to the device. ⇒ P. 149	The client software is not used.

## Setting Up sPSV

### Administrator (Administrator PC)

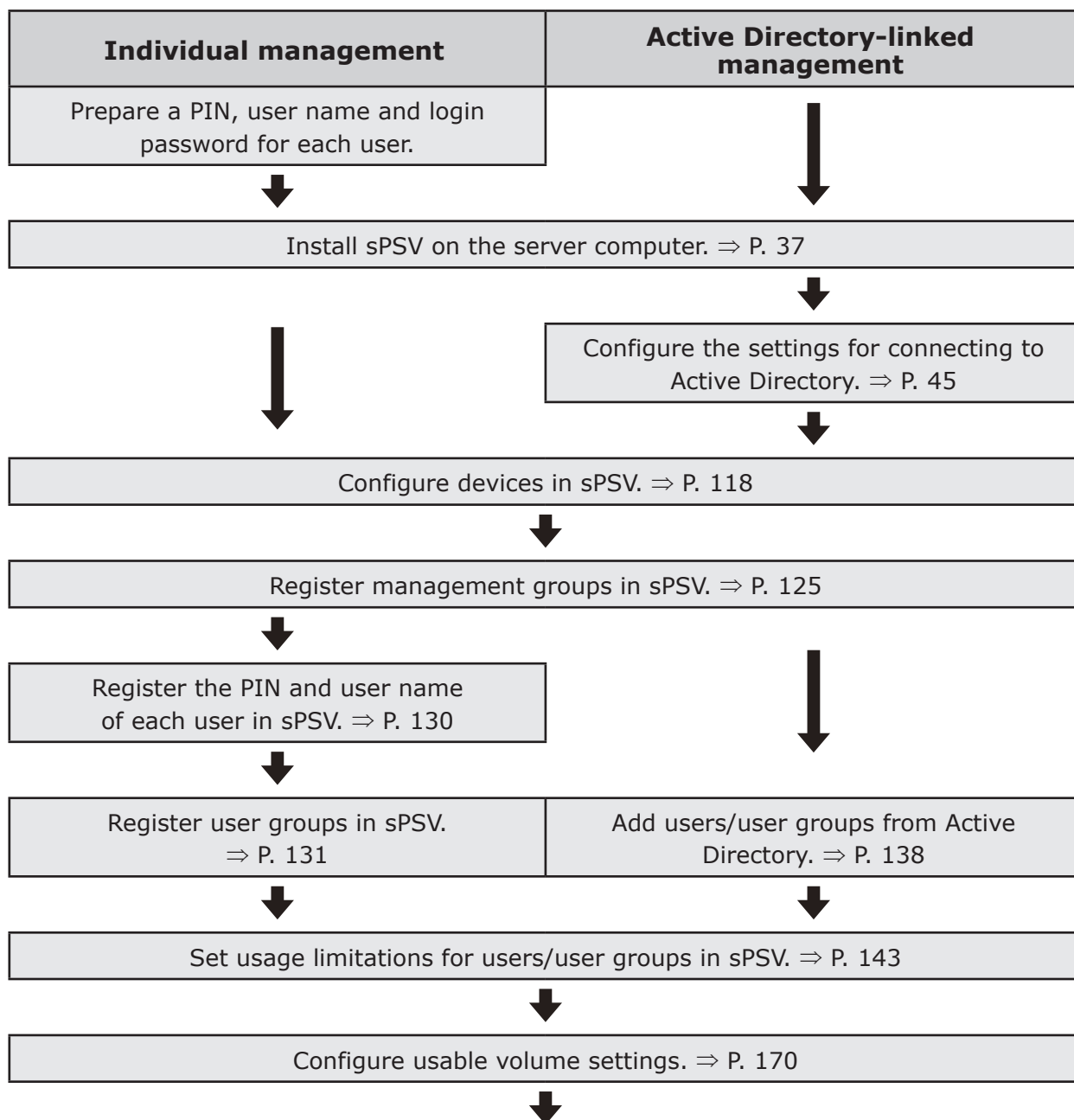

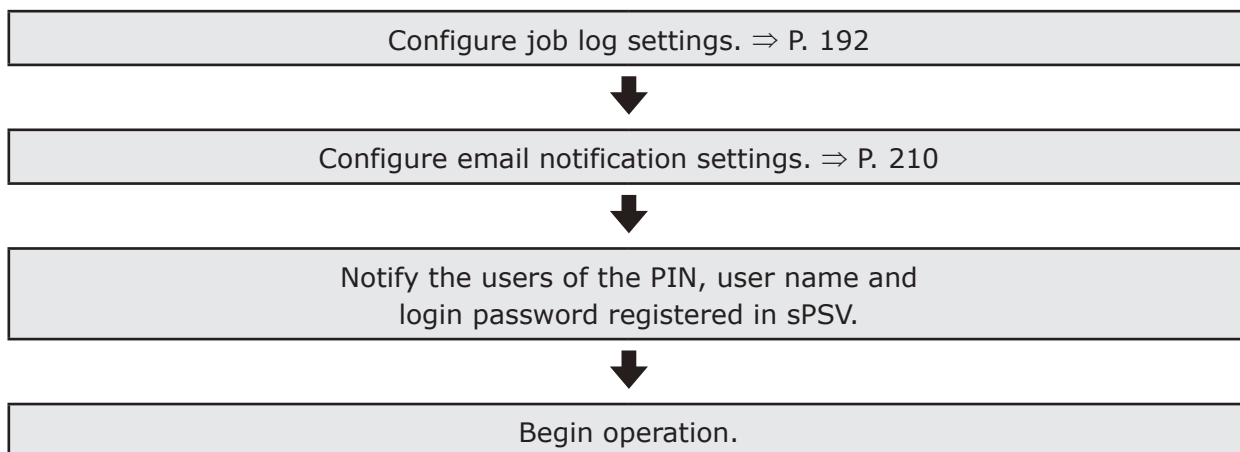

## Users (Client Computers)

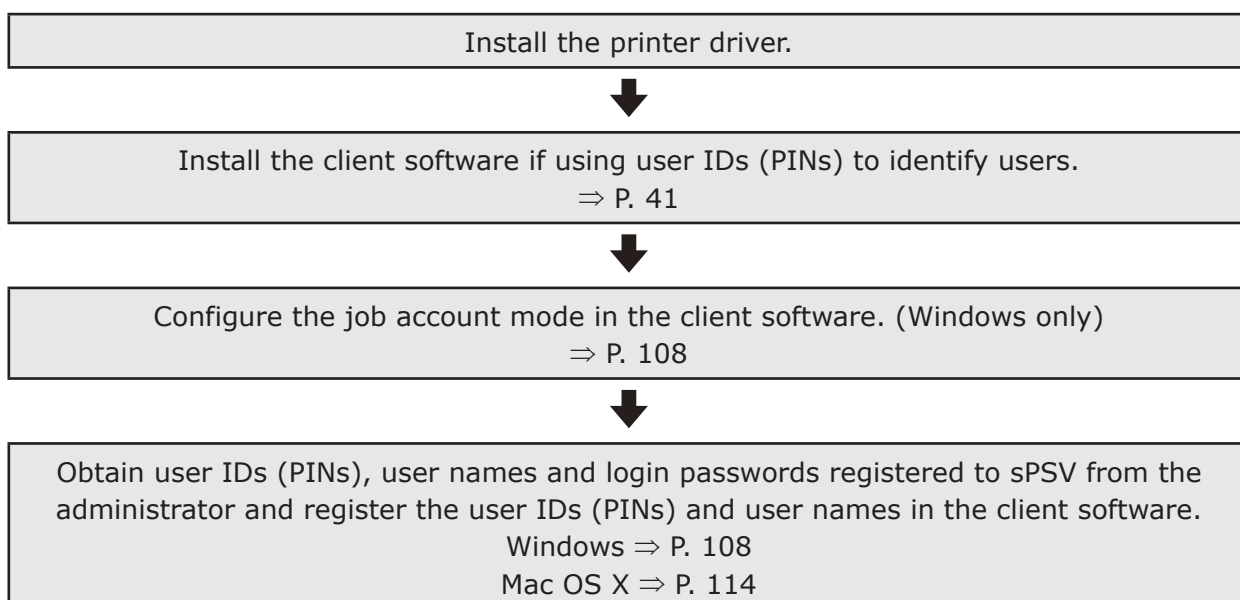

## Create a Settings Sheet

To enable smooth introduction of sPSV, first create a settings sheet. Collect the information required for setup and record it on the sheet below. If unsure, of any items, check with the system administrator before filling them in. Check each box when the corresponding setting is configured.

### Devices to Be Configured

<input type="checkbox"/>	Device	Printers, multifunction printers, etc. managed using sPSV
<input type="checkbox"/>	Server computer	The server on which sPSV is installed
<input type="checkbox"/>	Database server	The server that executes database processes
<input type="checkbox"/>	Authentication server	The server that executes directory services (in the case of sPSV, this refers to Active Directory.)
<input type="checkbox"/>	SMTP server	The server that executes email processes
<input type="checkbox"/>	Client computer (Windows/Mac)	A computer on which users can print pages and browse information managed in sPSV



- **The server computer can also function as the database server, authentication server and SMTP server.**
- **It is possible to browse information managed by sPSV, set usage limitations and summarize printing costs from the server computer.**

### smart PrintSuperVision

<input type="checkbox"/>	Name of installation program	
	Software version	

### Print Job Accounting Client Software (Windows)

<input type="checkbox"/>	Name of installation program	
	Software version	

### Print Job Accounting Client Software (Mac OS X)

<input type="checkbox"/>	Name of installation program	
	Software version	

## Database Information

Select Microsoft SQL Server Compact (if “Use a database prepared on setup” is selected in sPSV) or Microsoft SQL Server as the database for saving and viewing data in sPSV.

⇒ P. 37

<input type="checkbox"/>	Microsoft SQL Server Compact	
<input type="checkbox"/>	Database name (name of the database used by sPSV. Default name: spsv_database)	
<input type="checkbox"/>	Encryption method (UNENCRYPTED/Platform Default/Engine Default Default setting: UNENCRYPTED)	
<input type="checkbox"/>	Password (not required if UNENCRYPTED is set as the encryption method)	
<input type="checkbox"/>	Microsoft SQL Server	
<input type="checkbox"/>	Name of database server to which to connect/Default name: .\SQLEXPRESS	
<input type="checkbox"/>	Database name (name of the database used by sPSV/Default name: spsv_database)	
<input type="checkbox"/>	Authentication Methods (SQL Server Authentication/Windows Authentication. Default setting: SQL Server Authentication)	
<input type="checkbox"/>	User name (user name used for database authentication/Default name: sa)	
<input type="checkbox"/>	Password (password used for database authentication)	

## Web Service Information

Select Internet Information Services (IIS) or Web Service (EWS) as the web service used to display sPSV in a web browser. ⇒ P. 38

<input type="checkbox"/>	Internet Information Services (IIS)	
<input type="checkbox"/>	Port number (port number used by the IIS/Default number: 50081, range: 1-65535)	
<input type="checkbox"/>	Website name (website registered in the IIS for use by sPSV/Default name: smart PrintSuperVision)	
<input type="checkbox"/>	Web Service (EWS)	
<input type="checkbox"/>	Port number (port number used by the EWS/Default number: 50081, range: 1-65535)	



## Communication Settings

<input type="checkbox"/>	Acquire the device name.	
<input type="checkbox"/>	Interval specification: (Default setting: 60 minutes, range: 1-1,440)	
<input type="checkbox"/>	Time specification:	
<input type="checkbox"/>	Acquire the status.	
<input type="checkbox"/>	Interval specification: (Default setting: 60 minutes, range: 1-1,440)	
<input type="checkbox"/>	Time specification:	
<input type="checkbox"/>	Confirm that the IP address has been changed.	
<input type="checkbox"/>	Interval specification: (Default setting: 12 hours, range: 1-24)	
<input type="checkbox"/>	Time specification:	
<input type="checkbox"/>	Confirm that Active Directory has been updated.	
<input type="checkbox"/>	Interval specification: (Default setting: 24 hours, range: 1-24)	
<input type="checkbox"/>	Time specification:	
<input type="checkbox"/>	smart PrintSuperVision website	
<input type="checkbox"/>	Enable session timeout.	
<input type="checkbox"/>	Session timeout time: (Default setting: 10 minutes, range: 1-99)	
<input type="checkbox"/>	Communication with devices	
<input type="checkbox"/>	Timeout time: (Default setting: 5 seconds, range: 1-99)	
<input type="checkbox"/>	Communication retry: (Default setting: once, range: 0-9)	
<input type="checkbox"/>	Monitor sleeping devices.	

## Active Directory Information

Use this if adding user names and user group names by connecting to Active Directory and if using user names and user group names registered in a domain. ⇒ P. 45, P. 138

<input type="checkbox"/>	Domain name	
<input type="checkbox"/>	Login name	
<input type="checkbox"/>	The port number used to connect to the Active Directory server (Default setting: 389, range: 1-65535)	
<input type="checkbox"/>	Base DN (identifying name used as the base of the search range)	

## Mail Settings

<input type="checkbox"/>	Outgoing mail server (SMTP) settings ⇒ P. 210	
<input type="checkbox"/>	Email address (email address used to send outgoing mail from sPSV)	
<input type="checkbox"/>	Displayed name (sender name for email from sPSV)	
<input type="checkbox"/>	SMTP server name	
<input type="checkbox"/>	Port number (port number used in communication with the SMTP server/Default setting: 25, range: 1-65535)	
<input type="checkbox"/>	Authentication method (LOGIN/PLAIN/CRAM-MD5)	
<input type="checkbox"/>	User name (user name for SMTP server)	
<input type="checkbox"/>	Password (password for SMTP server)	
<input type="checkbox"/>	Encryption support (encryption of communication with the SMTP server)	
<input type="checkbox"/>	Email communication settings ⇒ P. 210	

## Registering and Managing Users

Individual Management	
<input type="checkbox"/>	Number of registered users
<input type="checkbox"/>	Number of registered user groups
<input type="checkbox"/>	Registering users ⇒ P. 130
<input type="checkbox"/>	Register user groups ⇒ P. 131
Active Directory-linked Management	
<input type="checkbox"/>	Add users from Active Directory ⇒ P. 138

## User Settings

<input type="checkbox"/>	Set usage limitations ⇒ P. 143
<input type="checkbox"/>	Setting the usable volume ⇒ P. 170
<input type="checkbox"/>	Set fees ⇒ P. 172
<input type="checkbox"/>	Set a closing date ⇒ P. 205

## User

<input type="checkbox"/>	Display Name: (up to 256 characters)
<input type="checkbox"/>	Language Code: (up to 64 characters)
<input type="checkbox"/>	IC Card information: (up to 256 characters)
<input type="checkbox"/>	PIN <sup>(*)</sup> : (1 - 999,999,999, can be assigned when registering users)
<input type="checkbox"/>	User name <sup>(*)</sup> : (up to 32 characters)
<input type="checkbox"/>	Password <sup>(*)</sup> : (up to 32 characters)
<input type="checkbox"/>	Last Name:
<input type="checkbox"/>	First name:
<input type="checkbox"/>	Email address:
<input type="checkbox"/>	Receive summarization results by email.
<input type="checkbox"/>	Phone number: (up to 64 characters)
<input type="checkbox"/>	Description: (up to 1024 characters)
	User groups (settings need to be configured if using)
	Usable volume (settings need to be configured if using)

(\*) denotes a required item.

## User Groups

<input type="checkbox"/>	User group name <sup>(*)</sup> : (up to 256 characters)	
<input type="checkbox"/>	Email address: (up to 256 characters)	
<input type="checkbox"/>	Receive summarization results by email.	
<input type="checkbox"/>	Include in admins user group.	
<input type="checkbox"/>	Description: (up to 1024 characters)	
<input type="checkbox"/>	Time specification:	
	Usable volume (settings need to be configured if using)	

(\*) denotes a required item.

## Usable Volume

<input type="checkbox"/>	Print number [sheets]	
<input type="checkbox"/>	Fee [Yen]	
<input type="checkbox"/>	Stapling [time]	
<input type="checkbox"/>	Include in summarization of use by user groups to which the user belongs.	
<input type="checkbox"/>	Reset interval of used volume	
<input type="checkbox"/>	Unit: (Do not specify/Months/Weeks/Days)	
<input type="checkbox"/>	Period: (1-99)	
<input type="checkbox"/>	Record date: Until last day of month/until X day of week	
<input type="checkbox"/>	Carry over to next period.	
<input type="checkbox"/>	Communication requirements:	
<input type="checkbox"/>	If usable volume is exceeded	
<input type="checkbox"/>	If used volume is reset	
<input type="checkbox"/>	X days before next reset date	

## Registering and Managing Devices

<input type="checkbox"/>	Number of connected devices	
<input type="checkbox"/>	Registering devices ⇒ P. 118	
<input type="checkbox"/>	Registering management groups ⇒ P. 125	
<input type="checkbox"/>	Job log acquisition settings ⇒ P. 122	
<input type="checkbox"/>	Log full settings ⇒ P. 199	

## Device

<input type="checkbox"/>	Device information	
<input type="checkbox"/>	Name:	
<input type="checkbox"/>	Installation location:	
<input type="checkbox"/>	Contact details:	
<input type="checkbox"/>	Management number:	
<input type="checkbox"/>	Management information	
<input type="checkbox"/>	Fee:	
<input type="checkbox"/>	Group(s)	
<input type="checkbox"/>	Communication information	
<input type="checkbox"/>	Device password	
<input type="checkbox"/>	SNMP Read community name: (Default setting: public)	
<input type="checkbox"/>	SNMP Write community name: (Default setting: public)	
<input type="checkbox"/>	SNMP Trap Port Number: (Default setting: 162)	
	Log access control (settings need to be configured if using)	

**Management Groups**

<input type="checkbox"/>	Name <sup>(*)</sup> : (up to 32 characters)	
<input type="checkbox"/>	Description: (up to 255 characters)	
<input type="checkbox"/>	Map:	
<input type="checkbox"/>	Fee:	
<input type="checkbox"/>	Device password <sup>(*)</sup> :	
<input type="checkbox"/>	SNMP Read community name <sup>(*)</sup> : (Default setting: public)	
<input type="checkbox"/>	SNMP Write community name <sup>(*)</sup> : (Default setting: public)	
<input type="checkbox"/>	SNMP Trap Port Number: (Default setting: 162)	
	Log access control (settings need to be configured if using)	

(\*) denotes a required item.

**Log/Access Control**

<input type="checkbox"/>	Log control	
<input type="checkbox"/>	Record job log for device.	
<input type="checkbox"/>	Specify job log acquisition schedule.	
<input type="checkbox"/>	Interval specification: Time minutes	
<input type="checkbox"/>	Time specification:	
<input type="checkbox"/>	Action when log is full: (Cancel job/Do not record in log/Delete old log items)	
<input type="checkbox"/>	Access control	
<input type="checkbox"/>	Enable access control.	
<input type="checkbox"/>	Panel access control (PIN/User name/Password/Do not specify/ Invalidity)	
<input type="checkbox"/>	User authentication method (Local/LDAP/Secure protocol)	
<input type="checkbox"/>	Email printing use (Color / Mono / Invalidity)	
<input type="checkbox"/>	Google Cloud Print use (Color / Mono / Invalidity)	
<input type="checkbox"/>	Guest use	

<input type="checkbox"/>	Specify schedule to acquire device use restrictions.	
<input type="checkbox"/>	Specify Interval: Hour Minutes	
<input type="checkbox"/>	Time specified:	
	Usage limitations (settings need to be configured if using)	

### Usage Limitations

<input type="checkbox"/>	Allow use of device only when printing from a computer.	
<input type="checkbox"/>	User name	
<input type="checkbox"/>	Prohibit printing	
<input type="checkbox"/>	Prohibit color printing	
<input type="checkbox"/>	Print in black and white	
<input type="checkbox"/>	Prohibit copying	
<input type="checkbox"/>	Prohibit color copying	
<input type="checkbox"/>	Prohibit printing from USB memory devices	
<input type="checkbox"/>	Prohibit color printing from USB memory devices	
<input type="checkbox"/>	Prohibit Scan to Email	
<input type="checkbox"/>	Prohibit Scan to Shared Folder	
<input type="checkbox"/>	Prohibit Scan to USB Memory	
<input type="checkbox"/>	Prohibit faxing	
<input type="checkbox"/>	Prohibit Scan to Internet Fax	
<input type="checkbox"/>	Prohibit Scan to Fax Server	
<input type="checkbox"/>	Printing policy	
<input type="checkbox"/>	Identify users by PIN	
<input type="checkbox"/>	Identify users by user name	
<input type="checkbox"/>	Document name	
<input type="checkbox"/>	Prohibit printing	
<input type="checkbox"/>	Prohibit color printing	
<input type="checkbox"/>	Print in black and white	
<input type="checkbox"/>	Host name	

<input type="checkbox"/>		Prohibit printing	
<input type="checkbox"/>		Prohibit color printing	
<input type="checkbox"/>		Print in black and white	
<input type="checkbox"/>	Application name		
<input type="checkbox"/>		Prohibit printing	
<input type="checkbox"/>		Prohibit color printing	
<input type="checkbox"/>		Print in black and white	

### Set a Closing Date

<input type="checkbox"/>	Xth of each month (Default setting: 31st, range: 1st-31st)	
<input type="checkbox"/>	Apply logs past the closing date to current month	

### Client Software

<input type="checkbox"/>	Tab Mode		
<input type="checkbox"/>		User name	
<input type="checkbox"/>		User ID	
<input type="checkbox"/>	Pop-up Mode		
<input type="checkbox"/>		User name	
<input type="checkbox"/>		User ID	
<input type="checkbox"/>	Hide Mode		
<input type="checkbox"/>		ID file	
<input type="checkbox"/>		Login name	
<input type="checkbox"/>		User name	
<input type="checkbox"/>		User ID	
<input type="checkbox"/>	User handling table		
<input type="checkbox"/>		Get user information from a file	
<input type="checkbox"/>		Folders containing user information files	
<input type="checkbox"/>	Set all users as fixed user IDs		
<input type="checkbox"/>		User name	
<input type="checkbox"/>		User ID	



## **2. Setting Up smart PrintSuperVision (sPSV)**

---

Operating Environments.....	36
Recommended Computer Specs.....	36
Standard Ports.....	36
Supported Browsers .....	36
Other .....	36
How to Install.....	37

## 2. Setting Up smart PrintSuperVision (sPSV)

This section explains how to set up sPSV.



The window and setting contents differ depending on the device model.

### Operating Environments

- Windows 10
- Windows 8.1
- Windows 8
- Windows 7
- Windows Vista
- Windows Server 2012 R2
- Windows Server 2012
- Windows Server 2008 R2
- Windows Server 2008



This includes the 64-bit version of Windows 10, Windows 8.1, Windows 8, Windows 7, Windows Vista, Windows Server 2008 and Windows Server 2008 R2.

### Recommended Computer Specs

- CPU: 1 GHz or higher
- Memory: 512 MB or higher
- Hard disk space: 30 MB or more



- The computer on which sPSV is set up needs to remain switched on, or needs to be running at the time when the job log is set to be obtained from the device.
- The above hard disk space is the minimum space required during installation. At least 30 MB of disk space is required to save job logs, etc. when using sPSV.
- Approximately 3 MB of hard disk space is required to save 10,000 job log entries on the computer.

### Standard Ports

sPSV uses the following ports for communication.

- HTTP (TCP 50081)\*
- Port 9100 (TCP Port 9100)
- SNMPv1 (UDP Port 161)
- SNMPv1 Trap (UDP Port 162)
- LDAP (TCP Port 389)
- SMTP(S) (TCP Port 25/587)
- SQL Server (TCP port 1433)

\*If the default port number is set



The firewalls of the server computers and client computers need to be set to allow access to these ports.

### Supported Browsers

- Microsoft Internet Explorer Ver 8.0 /9.0/10.0/11.0

### Other

- Microsoft .NET Framework 4.0/4.5 Full Package
- Internet Information Service (IIS) 7.0/8.0 (if IIS is used as the web service)
- Microsoft SQL Server 2005/2008/2012 (if using SQL Server as the database)
- Microsoft SQL Server Compact (if [Use database prepared during setup] is selected in sPSV)



See the online help for more information on sPSV.

## How to Install



**Log in as a user with Windows administrator authority.**

- 1 Double click the sPSV program downloaded from the Oki Data website (<http://www.okidata.co.jp/>).
- 2 Select the language, and click [Next].

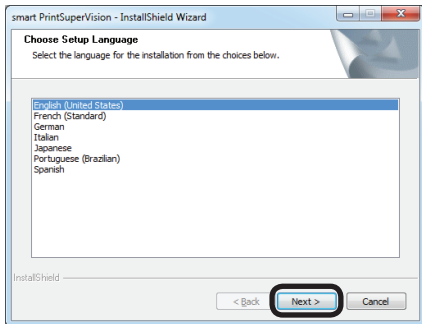

- 3 If .Net Framework 4.0 is not installed on the computer, it is automatically downloaded and installed.
- 4 Click [Next].

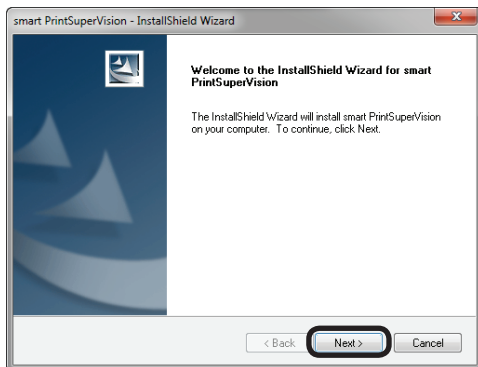

- 5 Read the license agreement and click [Yes].

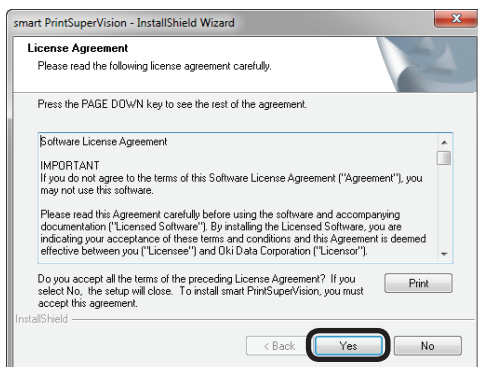

- 6 Specify the program folder and click [Next].

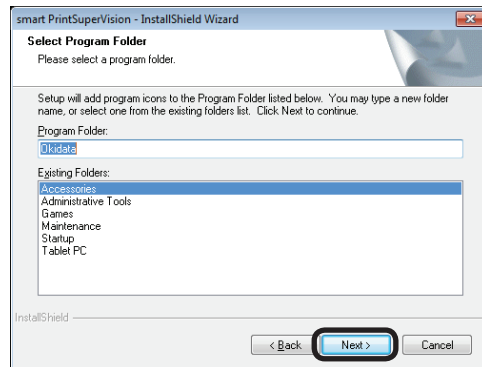

- 7 Specify the location in which to install sPSV and click [Next].

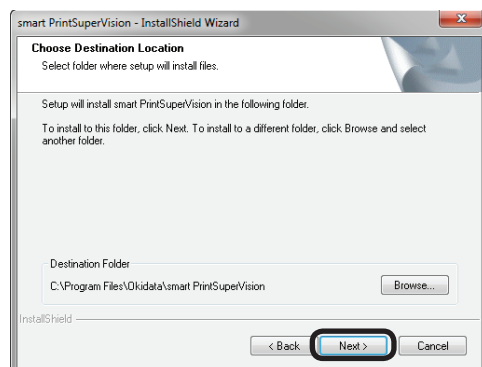

- 8 Select the database.

Select the database. The settings screen varies depending on the type selected.

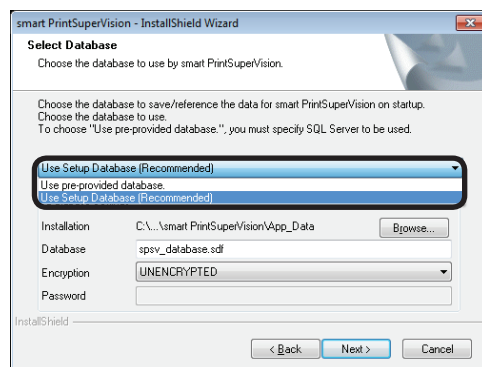

### <If [Use Setup Database (Recommended)] is selected>

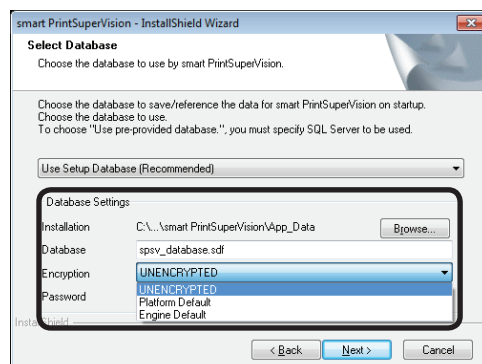

**[Installation]**

Click [Browse] and specify a location to save the database.

**[Database]**

Enter the name of the database to be used in sPSV.

(default name: spsv\_database)

**[Encryption]**

Specify the encryption method for the database.

(Default setting: UNENCRYPTED)

**[UNENCRYPTED]**

Not encrypted.

**[Platform Default]**

Encrypted using AES128\_SHA256.

**[Engine Default]**

Encrypted using AES256\_SHA512.

**[Password]**

Specify the password of the database to connect to. This does not need to be entered if [UNENCRYPTED] is specified.

**<If [Use pre-provided database] is selected>**

Specify the SQL server being used.

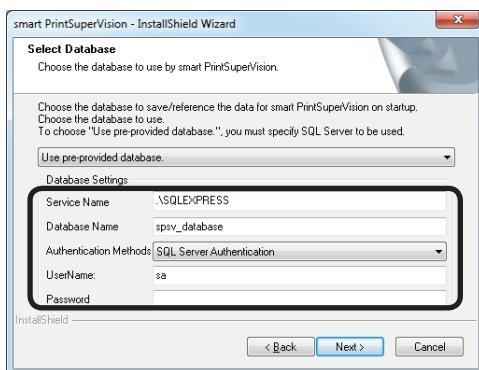
**[Service name]**

Enter the name of the database server to which to connect.

(Example: localhost\SQLEXPRESS)

Default name: .\SQLEXPRESS)

**[Database]**

Enter the name of the database to be used in sPSV.

(default name: spsv\_database)

**[Authentication Methods]**

Specify the database authentication method. (Default setting: SQL Server Authentication)

**[SQL Server Authentication]**

Connect to the database using the user name and password of an SQL Server login.

**[Windows Authentication]**

Connect to the database using a Windows account and password.

**[User Name]**

Specify an SQL Server user name. (default name: sa)

**[Password]**

Specify the SQL Server password.

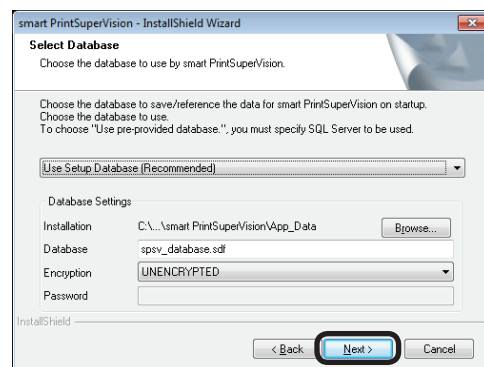
**9** Click [Next].**10** Select the web service to be used from [Web Service]. Internet Information Services (IIS) or an embedded web service (EWS) can be selected as the web service.

The settings screen varies depending on the web service selected.

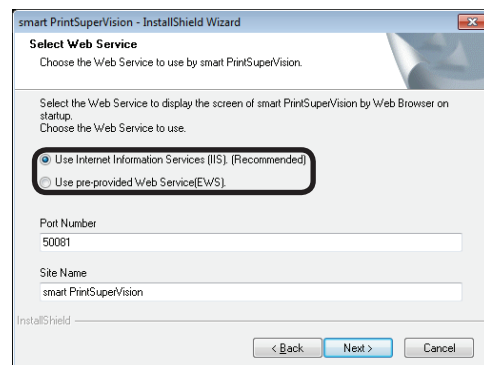

**<If [Use Internet Information Services (IIS) (Recommended).] is selected>**

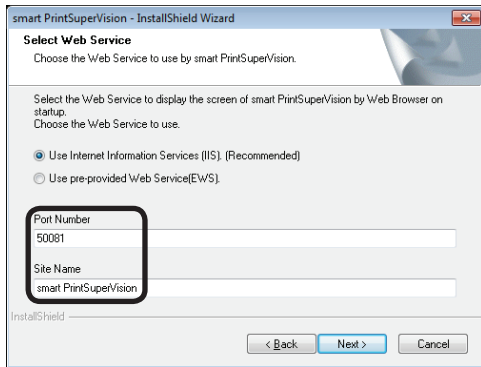

**[Port Number]**

Specify the port number used by IIS.  
(default: 50081, range: 1 - 65535)

**[Site name]**

Specify a website registered to IIS to be used  
by sPSV.

(default name: smart PrintSuperVision)

**<[Use pre-provided Web Service (EWS) is selected>**

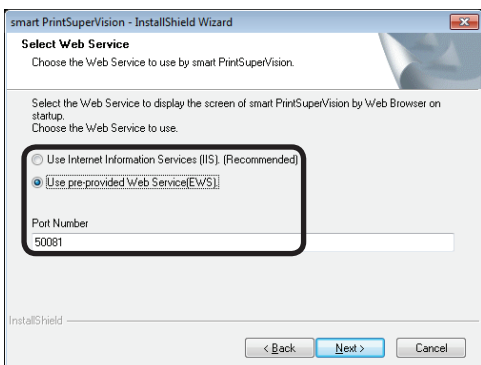

**[Port Number]**

Specify the port number used by the EWS.  
(default: 50081, range: 1 - 65535)

**11** Click [Next].

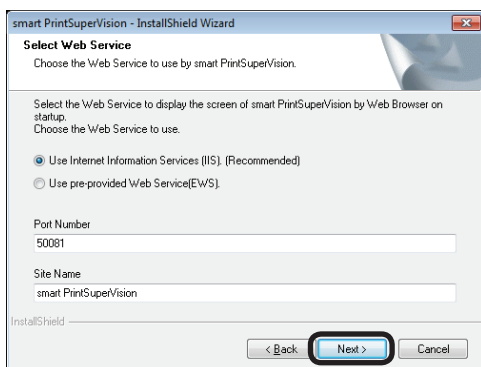

**12** Click [Install].

sPSV is installed.

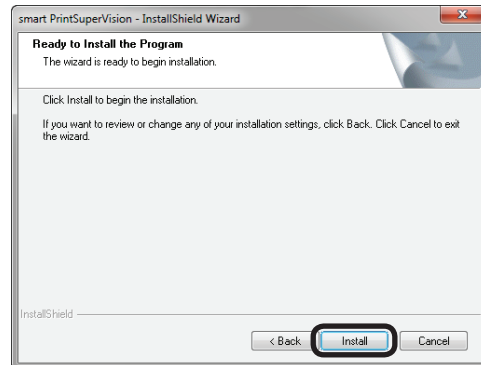

**13** Click [Finish].

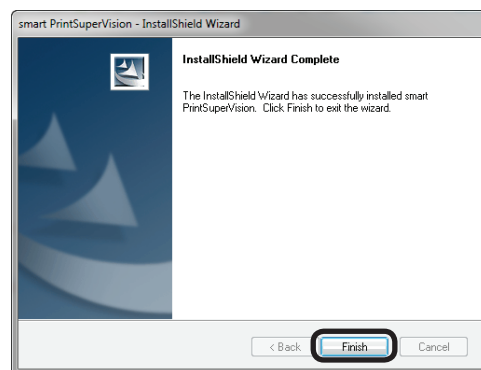

This completes the installation.

A shortcut to sPSV appears in the  
program menu and on the desktop when  
the installation is completed.



**sPSV is accessed from client computers  
using the address at which it was installed  
by the administrator (for example  
<http://192.168.100.10:50081>).**

# 3. Setting Up the Print Job Accounting Client Software

---

- Setting Up in Windows..... 41
  - Operating Environments..... 41
  - Installing the Client Software..... 41
- Setting Up in Mac OS X..... 43
  - Operating Environments..... 43
  - Installing the Client Software..... 43

# 3. Setting Up the Print Job Accounting Client Software

The client software needs to be installed on client computers if identifying users by user ID (PIN). This section explains how to set up the client software.

## Setting Up in Windows

### Operating Environments

- Windows 10
- Windows 8.1
- Windows 8
- Windows 7
- Windows Vista
- Windows Server 2012 R2
- Windows Server 2012
- Windows Server 2008 R2
- Windows Server 2008



This includes the 64-bit version of Windows 10, Windows 8.1, Windows 8, Windows 7, Windows Vista, Windows Server 2008 and Windows Server 2008 R2.

## Installing the Client Software



**Log in as a user with Windows administrator authority.**

- 1 Double click the client software program downloaded from the Oki Data website (<http://www.okidata.co.jp/>).
- 2 When the [User account management] dialog is displayed, click [Continue] or [Yes].
- 3 Select the language, and click [OK].

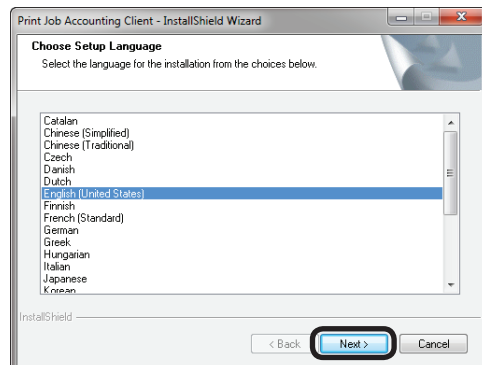

- 4 Click [Next].

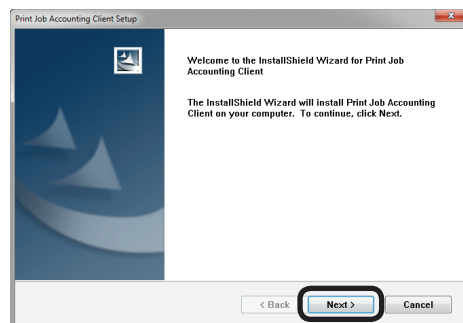

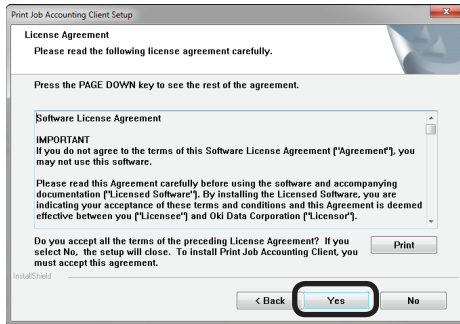
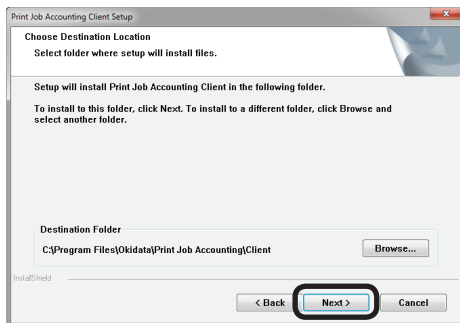
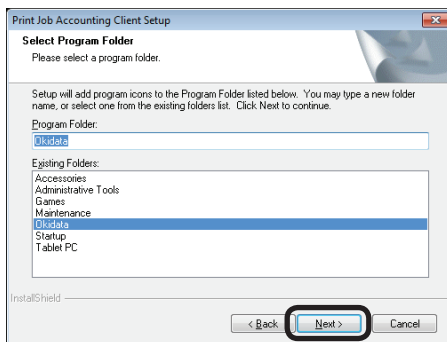
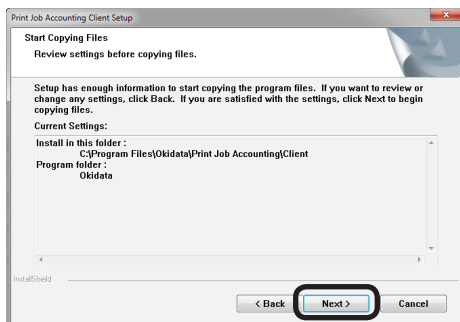
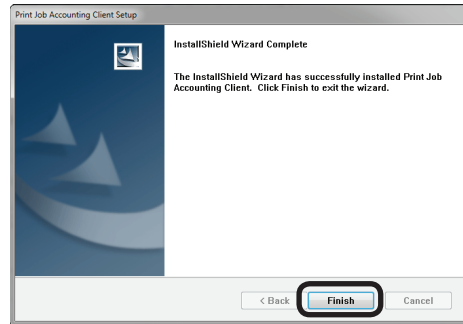
**5** Read the license agreement and click [Yes].**6** Click [Next].**7** Click [Next].**8** Click [Next].**9** Click [Finish].

Next, proceed to "6. Print Job Accounting Client Software" (P. 107) to set the job account mode.



# Setting Up in Mac OS X

## Operating Environments

Mac OS X 10.3 or later



**Depending on the model or print driver used, the operating environment may differ.**

## Installing the Client Software

- 1** Double click the client software program downloaded from the Oki Data website (<http://www.okidata.co.jp/>).
- 2** A disk image is located on the desktop.
- 3** Copy the [Print Job Accounting Client] icon in the disk image to the desired location by dragging and dropping.

Next, proceed to "Registering the Job Account ID (PIN)" (P. 114) to set user IDs

## 4. If Using Active Directory

---

What Can It Be Used for? .....	45
Settings for Connecting to Active Directory .....	45
Connecting to an Active Directory in a Specified Domain.....	45
Changing the Time or Interval at Which Update of Active Directory is Confirmed.....	46
To update Active Directory Immediately .....	47

## 4. If Using Active Directory

### What Can It Be Used for?

Active Directory can be used for uniform management of devices on the network, such as server computers, client computers, printers and multifunction printers, and information on the users who use them, such as identification information and access permission.

Devices and users are managed in fixed groups (referred to as "domains" or "AD domains"). It is also possible to manage large organizations or networks comprised of multiple interconnected domains.

### Settings for Connecting to Active Directory

Active Directory settings need to be configured in sPSV if setting usage limitations for users managed in Active Directory and registering them to devices.



**The operation to register user information managed in the Active Directory to the device can be performed smoothly if all settings for the Active Directory are completed before registering the device in sPSV.**

**Active Directory settings can also be configured after registering the device in sPSV.**

### Connecting to an Active Directory in a Specified Domain

- 1 Configure the settings in the [Function Details] window > [Option] > [Environment Settings] > [Server Settings].

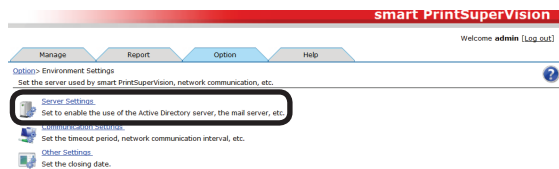

- 2 Click [Active Directory Server] to open the settings window.

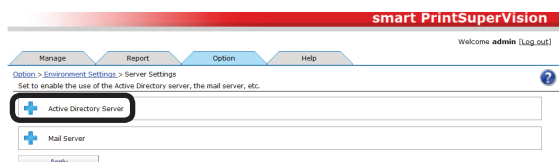

- 3 Enter the domain name, login name and password.

#### Domain Name

Enter the Active Directory domain name for searching for users and groups.

#### Login Name

Enter the user name for logging on to the Active Directory.

#### Password

Enter the password for logging on to the Active Directory.

- 4 To change the port number for connecting to the Active Directory, enter the port number. The range of the port number is from 1-65535 (default: 389).



**The firewall port on the Active Directory server may need to be opened beforehand depending on the port being used.**

- 5 To change the Active Directory to search, enter that target in "Base DN". An example of input when the domain name is [domain.local] is shown below.

When there is no OU: CN=Users,  
DC=domain, DC=local

When OU is specified: OU=OU name,  
DC=domain, DC=local



- If these values are not entered, the search is made based on DC=domain, DC=local.
- The search time can be reduced by specifying the OU because the search is only performed within the specified OU.

- 6 Check [Search for Locked User.] to search for users whose accounts are locked.



Users with locked accounts are users whose accounts have been locked due to a login failure caused by factors beyond their control such as security policies. Checking [Search for Locked User.] when searching prevents these users from being excluded during registration.

- 7 Click [Apply].

## Changing the Time or Interval at Which Update of Active Directory is Confirmed

The user and user group information on the Active Directory Server can be monitored, and changes to information can be updated. Monitoring of auto status refresh is enabled by default, but the monitoring schedule settings can be changed.



**When a new user that belongs to a group that is to be monitored in the Active Directory is added, users can be registered to the device until the maximum number of users that can be registered to the device is reached. After the maximum number of users that can be registered is reached, subsequent users cannot be registered to the device.**

- 1 Set in [Details Screen] > [Option] > [Environment Settings] > [Communication Settings].

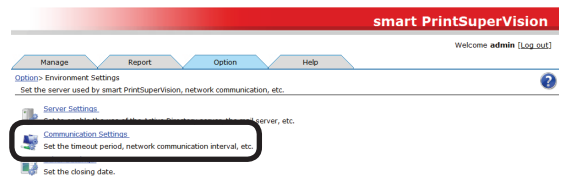

- 2 Click + in [Communication Interval] to open the settings window.

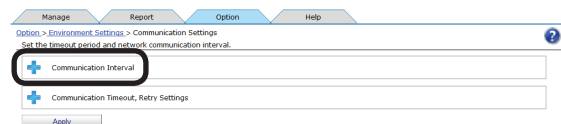

- 3 Check [Confirm the update of Active Directory.] and specify the interval or time of the update.

### [Specify Time]

Updated for each set interval. The maximum interval time that can be set is 24 hours. (Range: 1 to 24 hours)

### [Time specified]

Set the specific update time. Click [Specify Time] and add the time in 24-hour format. Up to 24 acquisition times can be added. After adding, click [OK].

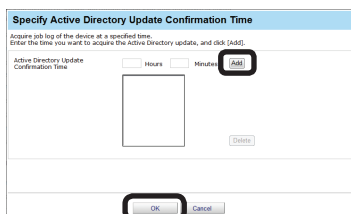

### 4 Click [Apply].

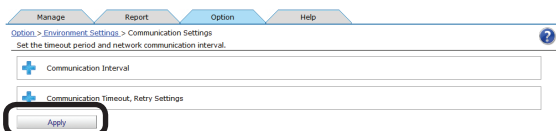

## To update Active Directory Immediately

Updates can be performed immediately in addition to at the automatic update timing set in [Communication Interval].

### 1 Update the information from [Details Screen] > [Option] > [User Settings].

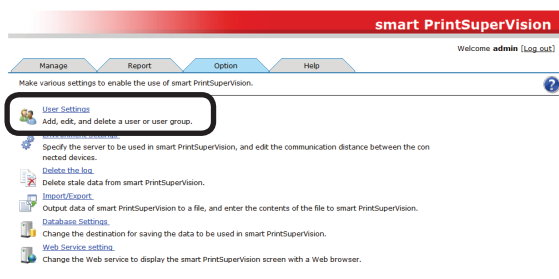

### 2 Click [Update Confirmation].

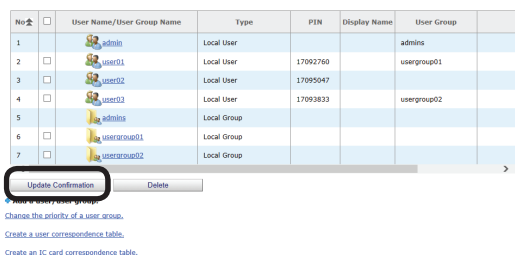

# 5. smart PrintSuperVision (sPSV)

---

- Top Page..... 49
- Login Window ..... 50
- Main Menu ..... 51
  - [Show Device Usage Status]..... 52
  - [Restrict Device Use] ..... 58
  - [Notify Device Management Status]..... 64
- Details Screen ..... 79
  - [Manage] Tab ..... 80
  - [Report] Tab..... 89
  - [Option] Tab..... 92
  - [Help] Tab..... 101
  - [Help Icon]..... 105

## 5. smart PrintSuperVision (sPSV)

This section explains the basic functions of smart PrintSuperVision.

### Top Page

#### Accessing sPSV from the Server PC

Double click the sPSV shortcut on the desktop or select [Start] > [All Programs] > [Oki Data] > [smart PrintSuperVision] > [smart PrintSuperVision].

#### Accessing sPSV from the Client PC

Launch the web browser, enter the address where the sPSV acquired from the administrator is installed in the address bar (e.g.http://192.168.100.10:50081), and press the Enter key.

Settings for each function of sPSV can be configured two ways, in the main menu window and function details window.

**Main Menu:** Window that navigates the target function while selecting according to the status. Settings of the target function can be configured by configuring the sPSV settings as per the navigation.

**Function Detail Window:** Window arranged according to types of function. Users who understand the sPSV settings can configure the function settings directly.

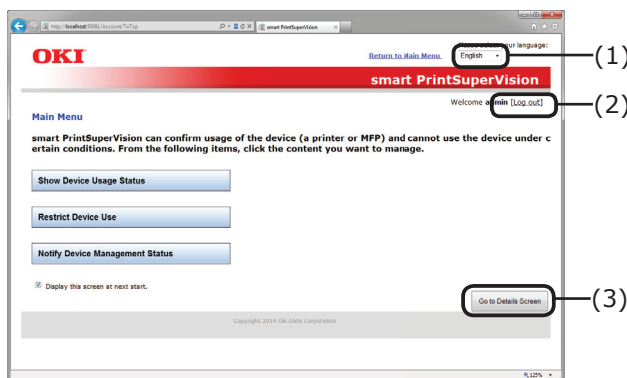

Main Menu Window

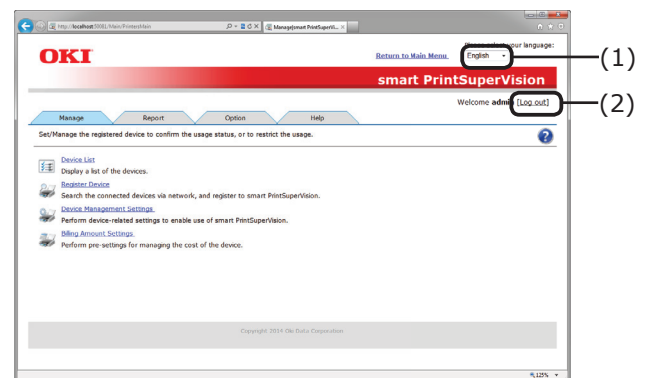

Details Screen

No.	Item	Details
(1)	Select Language List	The displayed language can be switched.
(2)	[Login]/[Log out]	Click [Login] to switch to the login window. Click [Log out] to log out.
(3)	[Go to Details Screen]	Click to switch to the details screen.

## Login Window

Click [Login] to display the login window. Enter the [User Name] and [Password] and click the [Login] button.

The following user is set as the administrator.

[User Name]: admin

[Password]: password



**The default password can be changed. To change the password, see “Changing User/User Group Information” (P. 135).**

OKI [Return to Main Menu](#) Please select your language: English

smart PrintSuperVision

Enter the user name and password, and click the "Login" button.

Please enter username and password and distinguish between capital and lowercase letters.

User Name

Password

Login

User account can be created by logging in with an administrator account.  
The default administrator account is "admin".

Copyright 2016 Oki Data Corporation

[User Name]

[Password]

[Login]

Login Window



## Main Menu

Window that navigates the the target function while selecting according to the status.

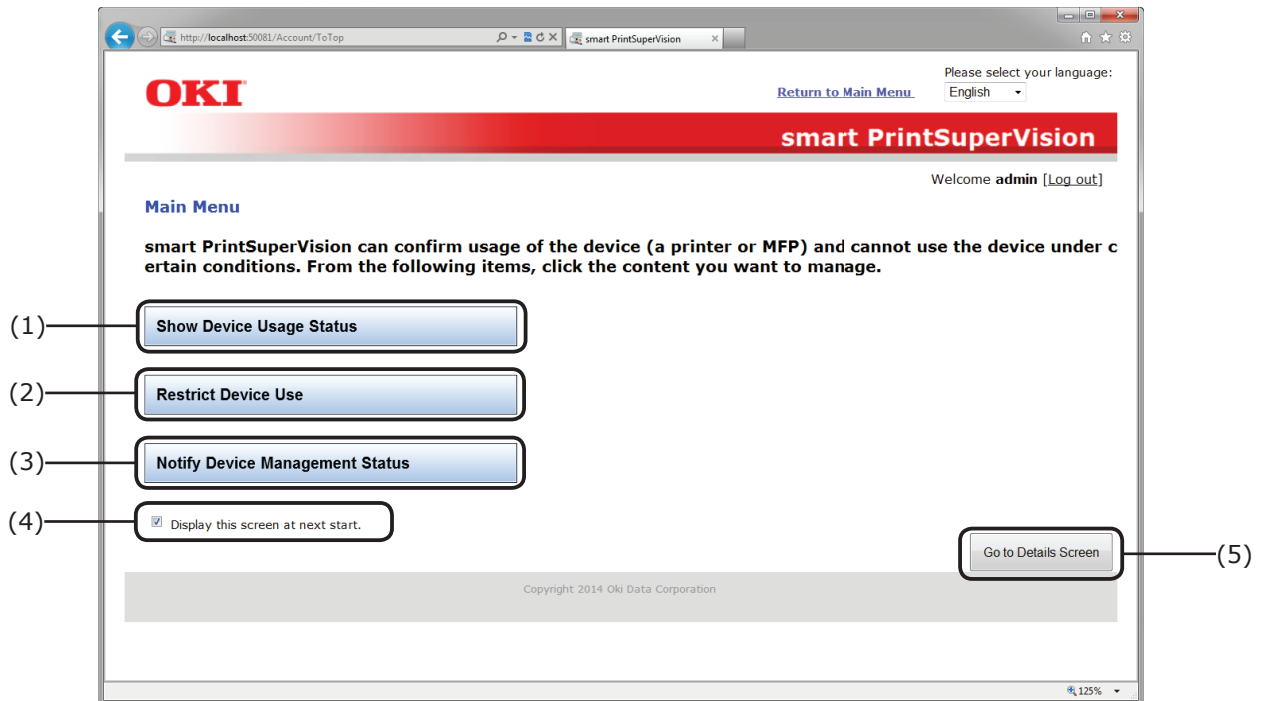

No.	Item	Details
(1)	[Show Device Usage Status]	Check details such as the amount of consumables used and print counter. Click to switch to the options window. ⇒ P. 52
(2)	[Restrict Device Use]*	Configure these settings to add limits to the number of printed sheets or add print limits. Click to switch to the options window. ⇒ P. 58
(3)	[Notify Device Management Status]*	Configure these settings to receive notification on the device usage status, various summarization results and fault information, etc. Click to switch to the options window. ⇒ P. 64
(4)	[Display this screen at next start.]	When the check mark is removed and browser closed, the details screen is displayed as the top page the next time the browser is launched.
(5)	[Go to Details Screen]	Click to switch to the [Details Screen]. ⇒ P. 79

\*Log in to sPSV as an administrator to configure these settings.

## [Show Device Usage Status]

[Main Menu] > [Show Device Usage Status]

You can check the device usage status such as the amount of consumables used by the device, print counter and device usage history for each user.

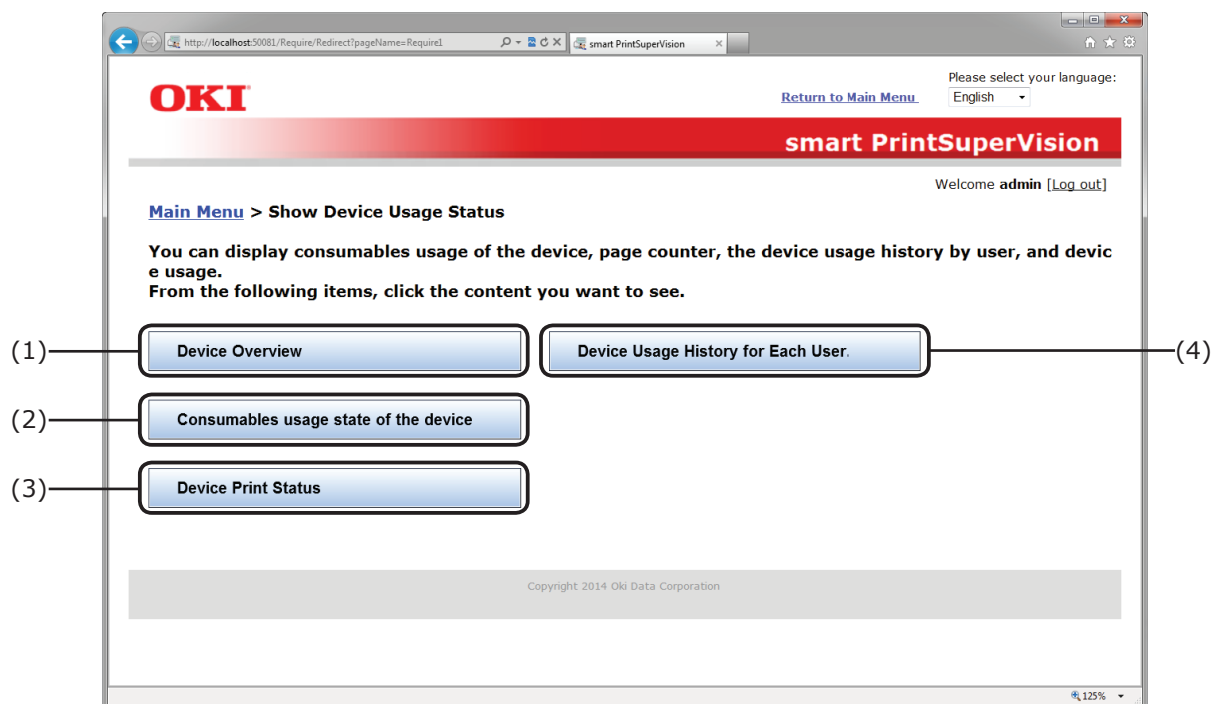

No.	Item	Details
(1)	[Device Overview]	Displays overviews of the devices in a list. Click to switch to the details screen. ⇒ P. 53
(2)	[Consumables usage state of the device ]	You can check aggregated results of the amount of consumables used for each device. Click to switch to the details screen. ⇒ P. 54
(3)	[Device Print Status]	You can check aggregated results of the print counter for each device. Click to switch to the details screen. ⇒ P. 55
(4)	[Device Usage History for Each User.]*	You can check the device usage history for each user. Click to switch to the details screen. ⇒ P. 56



\*Log in to sPSV as an administrator to configure these settings.

**[Device Overview]**

[Main Menu] &gt; [Show Device Usage Status] &gt; [Device Overview]

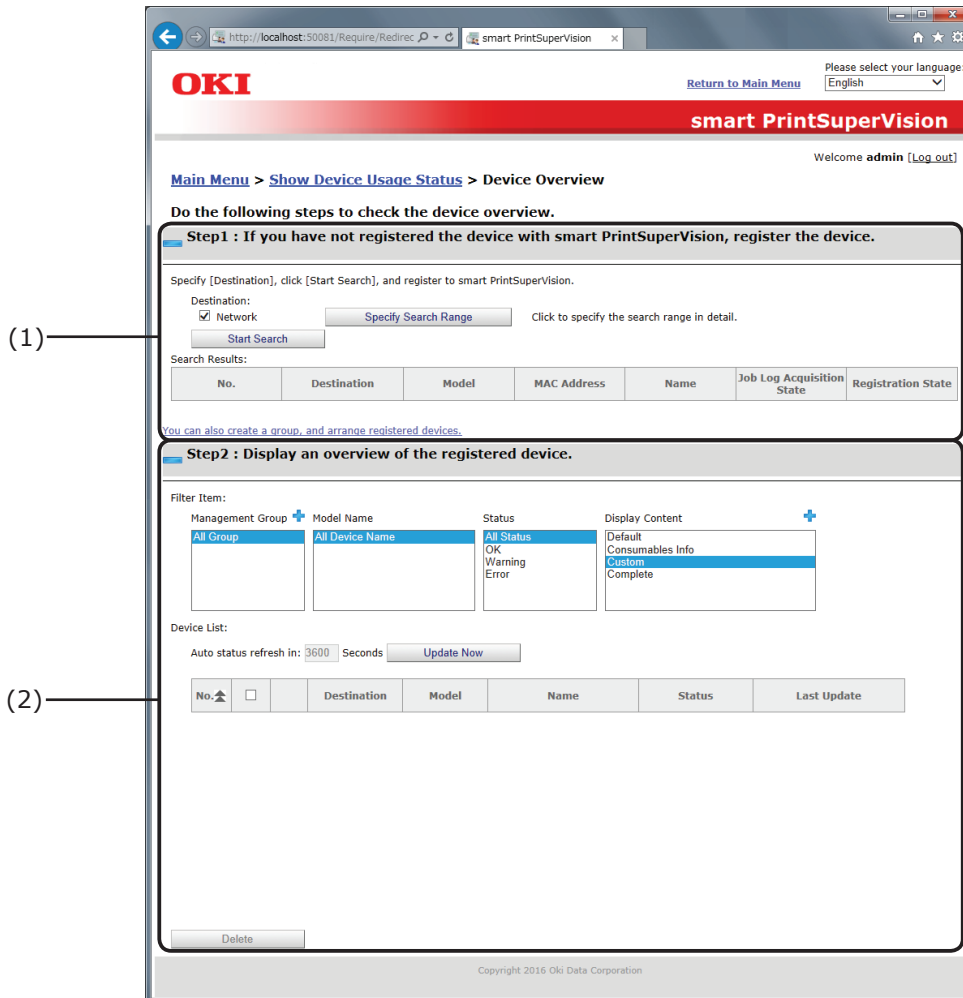
Displays the basic device information in a list.



No.	Item	Details
(1)	Step 1: Device registration*	<p>If the device to display an overview is not registered, specify [Destination] and click [Start Search]. Search for and register the device. Once the device is registered there is no need to perform registration again. (However, device registration is required when adding a new device.) For details, see Details Screen &gt; Management Tab &gt; Register Device (P. 83).</p> <p>To browse group units or assign use restrictions, click [You can also create a group, and arrange registered devices.] to create a management group. For details, see Details Screen &gt; Management Tab &gt; Device Management Settings &gt; Management Group (P. 86).</p> <p> Memo</p> <p>If the setting area is not displayed, click  to open the setting area.</p>
(2)	Step 2: Overview List View	Displays overviews of the devices in a list. For details, see Details Screen > Management Tab > Device List (P. 81).



\*Log in to sPSV as an administrator to configure these settings.

## [Consumables usage state of the device]

[Main Menu] > [Show Device Usage Status] > [Consumables usage state of the device]

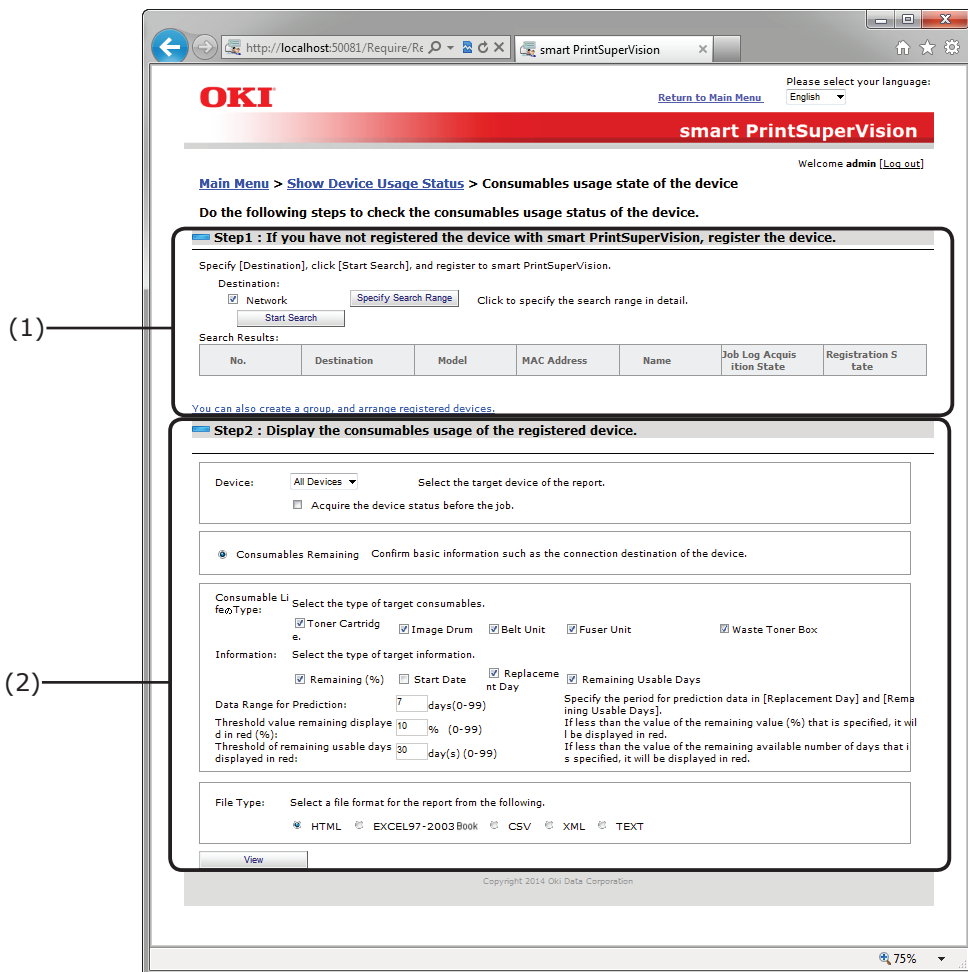
You can check aggregated results of the amount of consumables used for each device.



No.	Item	Details
(1)	Step 1: Device registration*	<p>If the device to display the amount of consumables used is not registered, specify [Destination] and click [Start Search]. Search for and register the device. Once the device is registered there is no need to perform registration again. (However, device registration is required when adding a new device.)</p> <p>For details, see Details Screen &gt; Management Tab &gt; Register Device (P. 83).</p> <p>To browse group units or assign use restrictions, click [You can also create a group, and arrange registered devices.] to create a management group.</p> <p>For details, see Details Screen &gt; Management Tab &gt; Device Management Settings &gt; Management Group (P. 86).</p> <p> Memo</p> <p>If the setting area is not displayed, click  to open the setting area.</p>
(2)	Step 2: Amount of consumable used list display	<p>Displays a list of the amount of consumables used by the device. For details, see Details Screen &gt; Report Tab &gt; Display Report &gt; Device Info (P. 90).</p>



\*Log in to sPSV as an administrator to configure these settings.

## [Device Print Status]

[Main Menu] > [Show Device Usage Status] > [Device Print Status]

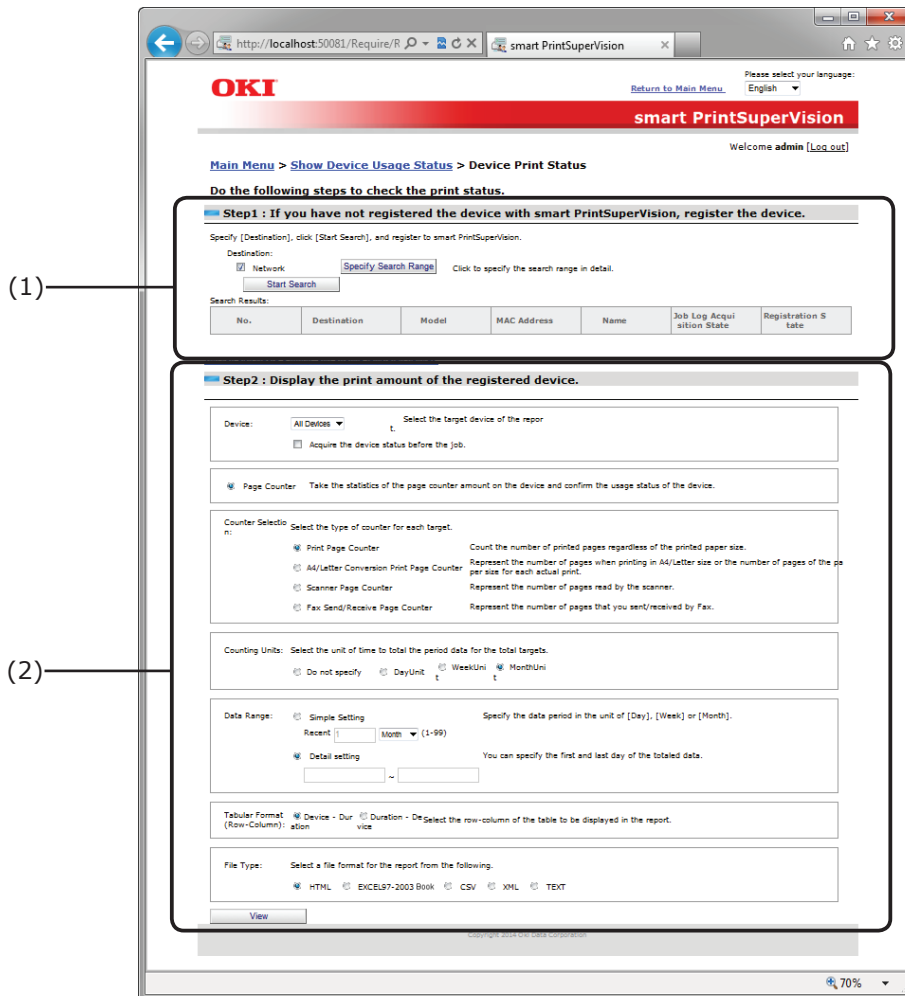
Aggregated results of the page counter for each device can be checked.



No.	Item	Details
(1)	Step 1: Device registration*	<p>If the device to display the print counter is not registered, specify [Destination] and click [Start Search]. Search for and register the device. Once the device is registered you do not need to perform registration again. (However, device registration is required when adding a new device.) For details, see Details Screen &gt; Management Tab &gt; Register Device (P. 83).</p> <p>To browse group units or assign use restrictions, click [You can also create a group, and arrange registered devices.] to create a management group. For details, see Details Screen &gt; Management Tab &gt; Device Management Settings &gt; Management Group (P. 86).</p> <p> Memo</p> <p>If the setting area is not displayed, click  to open the setting area.</p>
(2)	Step 2: Display the print counter list	<p>Display the list of print counters for devices. For details, see Details Screen &gt; Report Tab &gt; Display Report &gt; Device Info (P. 90).</p>



\*Log in to sPSV as an administrator to configure these settings.

## [Device Usage History for Each User.]



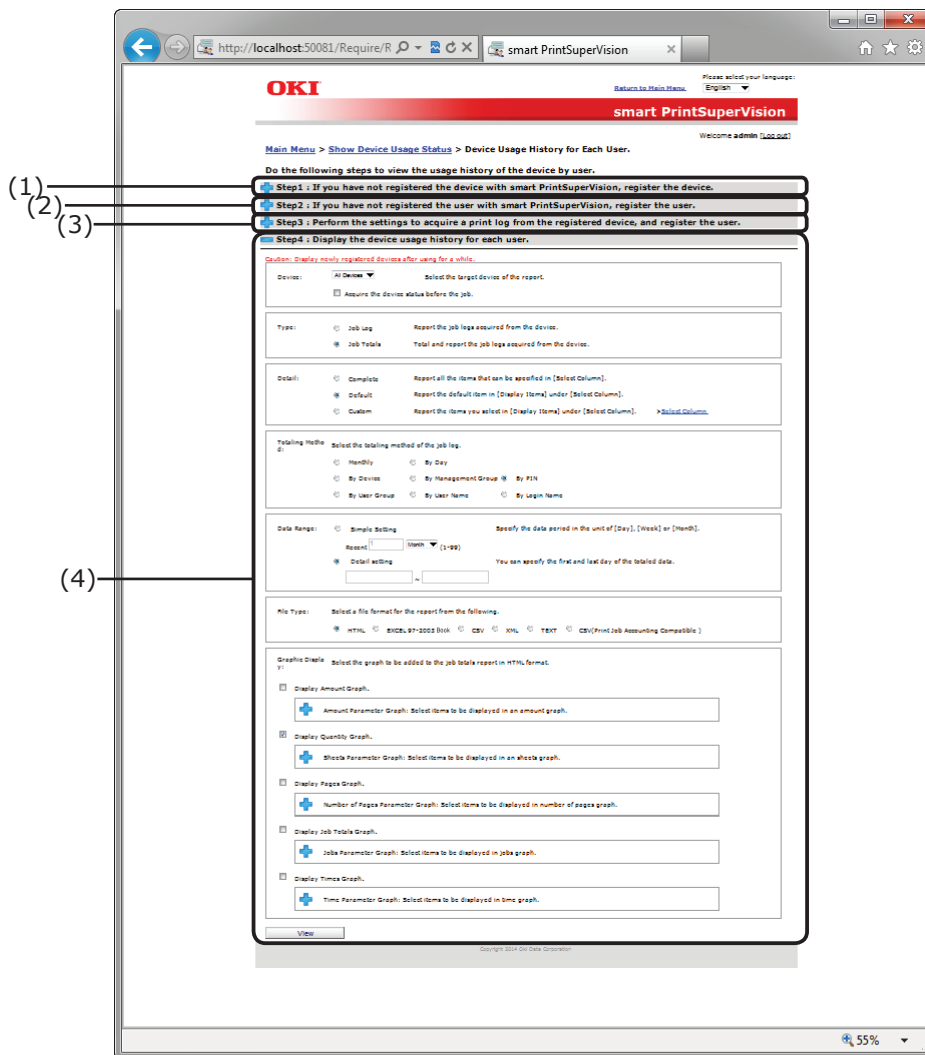

[Main Menu] > [Show Device Usage Status] > [Device Usage History for Each User.]

Results of aggregated job logs as device usage history for each user can be checked.



No.	Item	Details
(1)	Step 1: Device registration*	<p>If the device for which you want to display a usage history is not registered, specify [Destination] and click [Start Search]. Search for and register the device. Once the device is registered there is no need to perform registration again. (However, device registration is required when adding a new device.)</p> <p>For details, see Details Screen &gt; Management Tab &gt; Register Device (P. 83).</p> <p>To browse group units or assign use restrictions, click [You can also create a group, and arrange registered devices.] to create a management group.</p> <p>For details, see Details Screen &gt; Management Tab &gt; Device Management Settings &gt; Management Group (P. 86).</p> <p> Memo</p> <p>If the setting area is not displayed, click  to open the setting area.</p>

\*Log in to sPSV as an administrator to configure these settings.

No.	Item	Details
(2)	Step 2: User Registration*	<p>If the user for which you want to check the usage history is not registered, register the user. Once registration is complete, future registration is not needed. Once the device is registered there is no need to perform registration again. (However, user registration is required when adding a new user.)</p> <p>To browse the device usage status in user group units, click [Add a Local User Group] to create a group.</p> <p>For details, see Details Screen &gt; Options Tab &gt; User Settings (P. 93).</p> <p></p> <p>If the setting area is not displayed, click  to open the setting area.</p>
(3)	Step 3: Add User/Acquire Print Log*	<p>Configure the settings so that the print log can be received by the registered device, and register the user. Once the device is registered there is no need to perform registration again. (However, device registration is required when adding a new device.)</p> <p>For details, see Details Screen &gt; Management Tab &gt; Device Management Settings &gt; Device Settings &gt; Log/Access Control (P. 85).</p> <p></p> <p>If the setting area is not displayed, click  to open the setting area.</p>
(4)	Step 4: List view of device usage history	<p>Display the device usage history for each user.</p> <p>For details, see Details Screen &gt; Report Tab &gt; Display Report &gt; Job Information (P. 90).</p> <p></p> <p>The job log is not reflected immediately after registering/adding the device and user. After a registered user has used the device, the job log is acquired and displayed.</p>

\*Log in to sPSV as an administrator to configure these settings.

## [Restrict Device Use]

[Main Menu] > [Restrict Device Use]

Upper limit of print quality by device user, and limit on the operation of the MFP can be set.

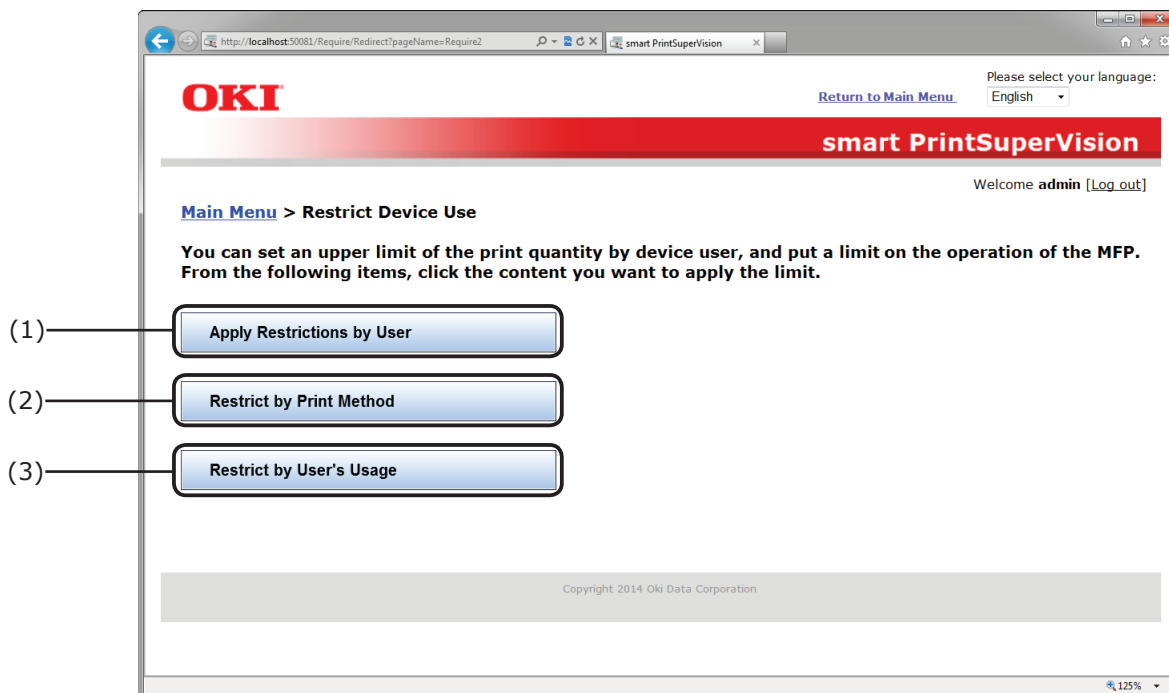

No.	Item	Details
(1)	[Apply Restrictions by User]	Configure use restrictions for each user (each sPSV user account). Click to switch to the options window. ⇒ P. 59
(2)	[Restrict by Print Method]	Configure use restrictions for each print job information (one of computer name, document name or application). Click to switch to the options window. ⇒ P. 61
(3)	[Restrict by User's Usage]	Configure use restrictions for each user (each sPSV user account) according to the usage amount. Click to switch to the options window. ⇒ P. 62





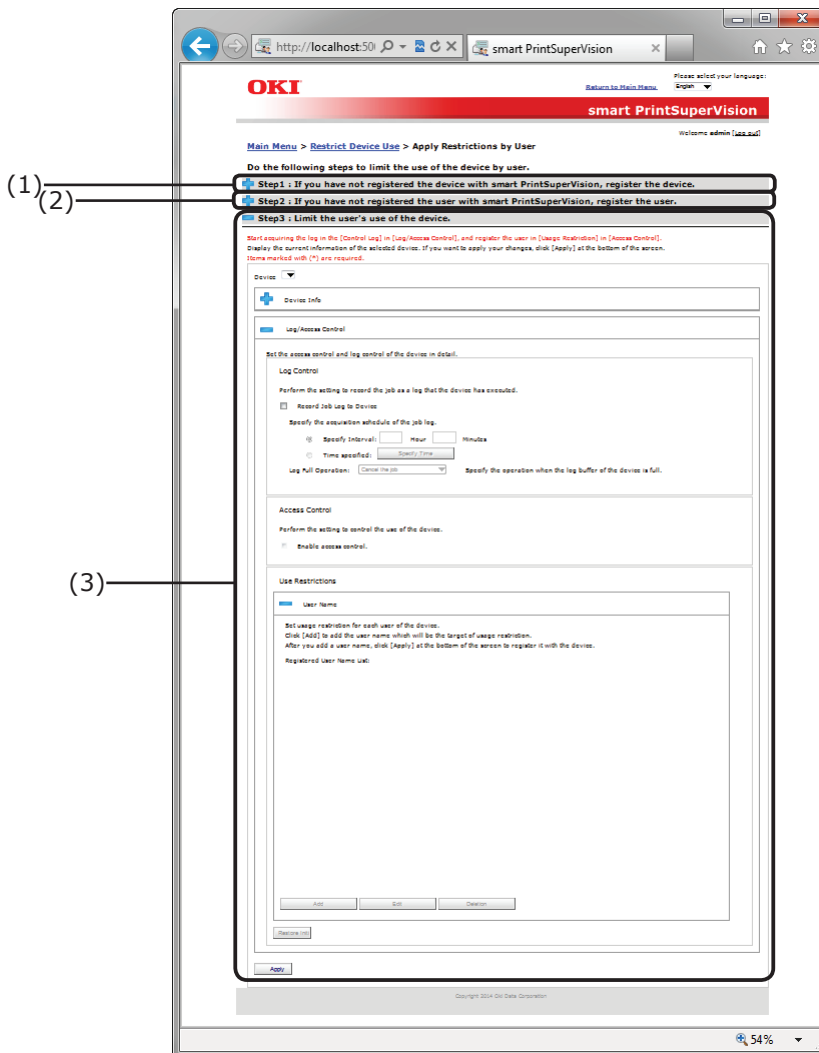

## [Apply Restrictions by User]

[Main Menu] > [Restrict Device Use] > [Apply Restrictions by User]

Configure device use restrictions for each user.



No.	Item	Details
(1)	Step 1: Device registration	<p>If the device to restrict usage of is not registered, specify [Destination] and click [Start Search]. Search for and register the device. Once the device is registered there is no need to perform registration again. (However, device registration is required when adding a new device.)</p> <p>For details, see Details Screen &gt; Management Tab &gt; Register Device (P. 83).</p> <p>To browse group units or assign use restrictions, click [You can also create a group, and arrange registered devices.] to create a management group.</p> <p>For details, see Details Screen &gt; Management Tab &gt; Device Management Settings &gt; Management Group (P. 86).</p> <p> Memo</p> <p>If the setting area is not displayed, click  to open the setting area.</p>



No.	Item	Details
(2)	Step 2: User Registration	<p>If the user whose device use is to be restricted is unregistered, register the user. Once the device is registered there is no need to perform registration again. (However, user registration is required when adding a new user.)</p> <p>To restrict the device usage for user group units, click [Add a Local User Group] to create a group.</p> <p>For details, see Details Screen &gt; Options Tab &gt; User Settings (P. 93).</p> <p> Memo</p> <p>If the setting area is not displayed, click  to open the setting area.</p>
(3)	Step 3: Add Registration	<p>Register the users whose registered device usage is to be restricted.</p> <p>For details, see Details Screen &gt; Management Tab &gt; Device Management Settings &gt; Device Settings (P. 84).</p>

## [Restrict by Print Method]

[Main Menu] > [Restrict Device Use] > [Restrict by Print Method]

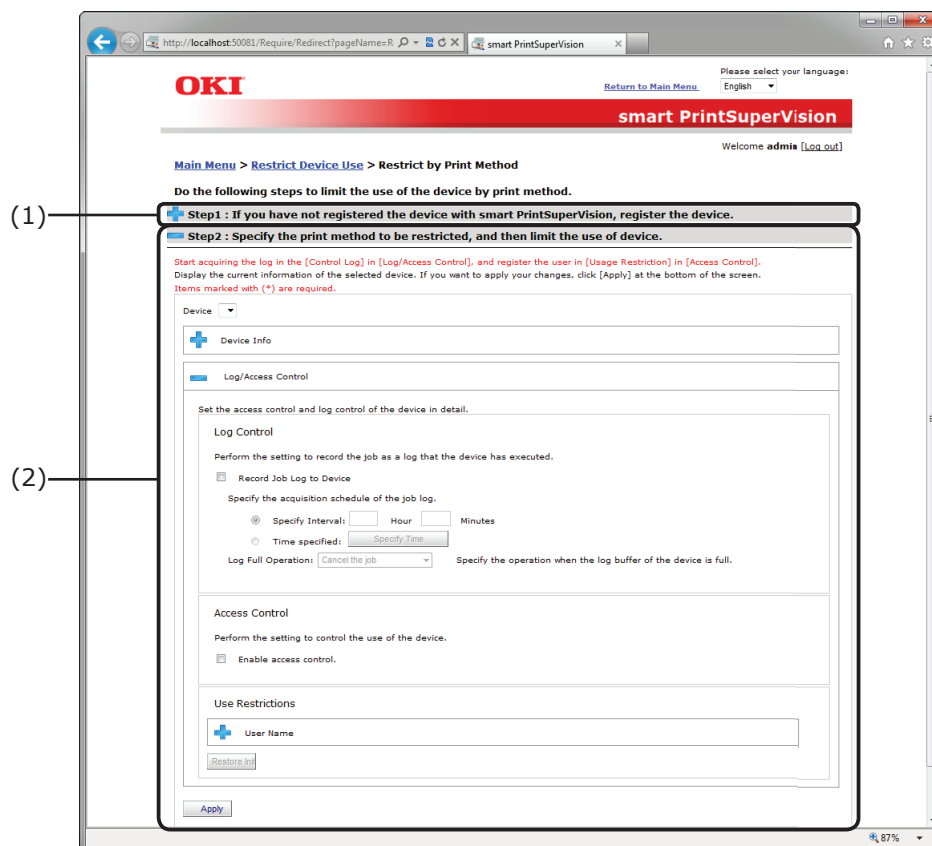
Configure device use restrictions for each user print method (document name, hosts).



No.	Item	Details
(1)	Step 1: Device registration	<p>If the device whose usage is to be restricted is not registered, specify [Destination] and click [Start Search]. Search for and register the device. Once the device is registered there is no need to perform registration again. (However, device registration is required when adding a new device.)</p> <p>For details, see Details Screen &gt; Management Tab &gt; Register Device (P. 83).</p> <p>To browse group units or assign use restrictions, click [You can also create a group, and arrange registered devices.] to create a management group.</p> <p>For details, see Details Screen &gt; Management Tab &gt; Device Management Settings &gt; Management Group (P. 86).</p> <p> Memo</p> <p>If the setting area is not displayed, click  to open the setting area.</p>
(2)	Step 2: Add Restriction	<p>Register the apply restrictions to the registered device.</p> <p>For details, see Details Screen &gt; Management Tab &gt; Device Management Settings &gt; Device Settings (P. 84).</p>

## [Restrict by User's Usage]

[Main Menu] > [Restrict Device Use] > [Restrict by User's Usage]





Configure the device use restrictions according to the user's usage (amount of consumables used, printed sheets, print cost).

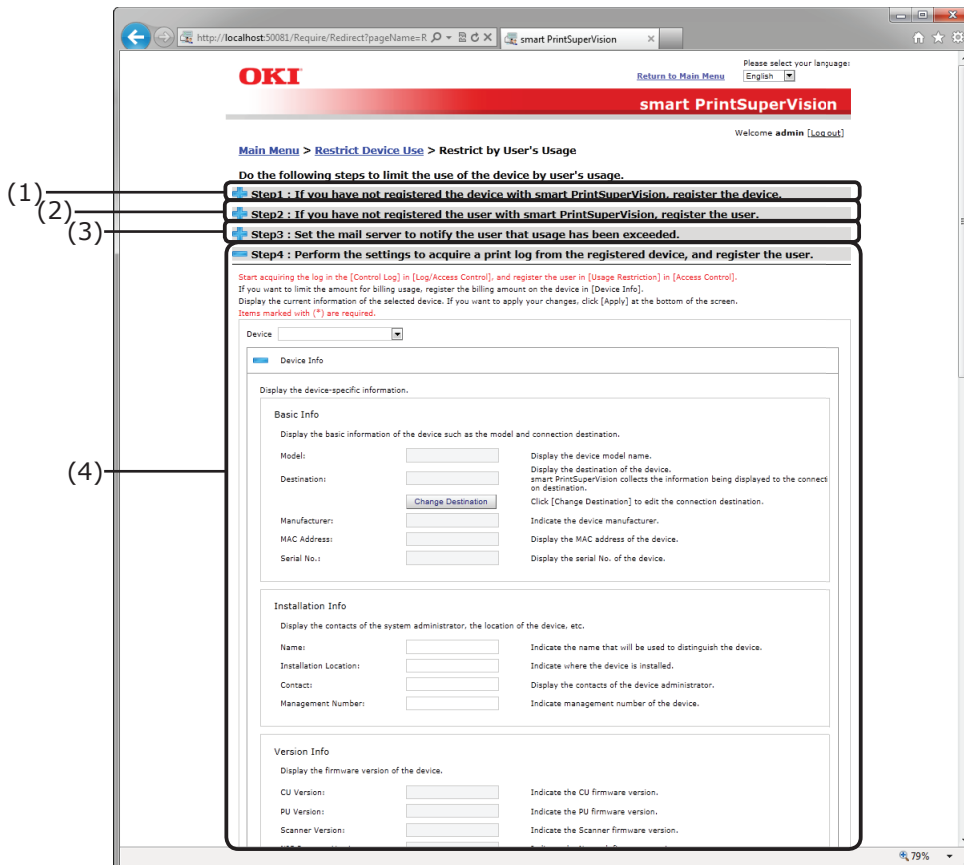

**When this setting is configured, the usage amount is restricted for the device according to user or user group, irrespective of the setting status of the device quota management.**



No.	Item	Details
(1)	Step 1: Device registration	<p>If the device to have restricted usage is not registered, specify [Destination] and click [Start Search]. Search for and register the device. Once the device is registered there is no need to perform registration again. (However, device registration is required when adding a new device.)</p> <p>For details, see Details Screen &gt; Management Tab &gt; Register Device (P. 83).</p> <p>To browse group units or assign use restrictions, click [You can also create a group, and arrange registered devices.] to create a management group.</p> <p>For details, see Details Screen &gt; Management Tab &gt; Device Management Settings &gt; Management Group (P. 86).</p> <p> Memo</p> <p>If the setting area is not displayed, click  to open the setting area.</p>

No.	Item	Details
(2)	Step 2: User Registration	<p>If the user whose usage amount is to be restricted is unregistered, register the user. Once the device is registered there is no need to perform registration again. (However, user registration is required when adding a new user.)</p> <p>Configure the usage amount settings for the registered user. To restrict the device usage according to usage amount for user group units, click [Add a Local User Group] to create a group.</p> <p>For details, see Details Screen &gt; Options Tab &gt; User Settings (P. 93).</p> <p></p> <p>If the setting area is not displayed, click  to open the setting area.</p>
(3)	Step 3: Mail server setting	<p>Configure the mail server settings to notify users when the usage amount is exceeded. Once the user is registered there is no need to perform registration again. (However, the settings need to be changed if the mail server is changed.)</p> <p>For details, see Details Screen &gt; Options Tab &gt; Environment Settings (P. 95).</p> <p>To change the content of comments notified to users, click [You can edit the contents to be notified.] and edit the comment.</p> <p>For details, see Details Screen &gt; Report Tab &gt; Notification Settings &gt; Notification Email Settings (P. 91).</p> <p></p> <p>If the setting area is not displayed, click  to open the setting area.</p>
(4)	Step 4: Add User/Acquire Print Log Settings/Fees Settings	<p>Register the users whose use of the registered device is to be restricted and configure the print log acquisition. Also, when setting usage amount restrictions as fees, register the fees to the restriction target device. (However, re-registration is required if there are changes to the fees.)</p> <p>For details, see Details Screen &gt; Management Tab &gt; Device Management Settings &gt; Device Settings (P. 84).</p>

## [Notify Device Management Status]

[Main Menu] > [Notify Device Management Status]

Users can be notified of the device usage status, such as the amount of device consumables used and print counter, or results of detecting the device status.

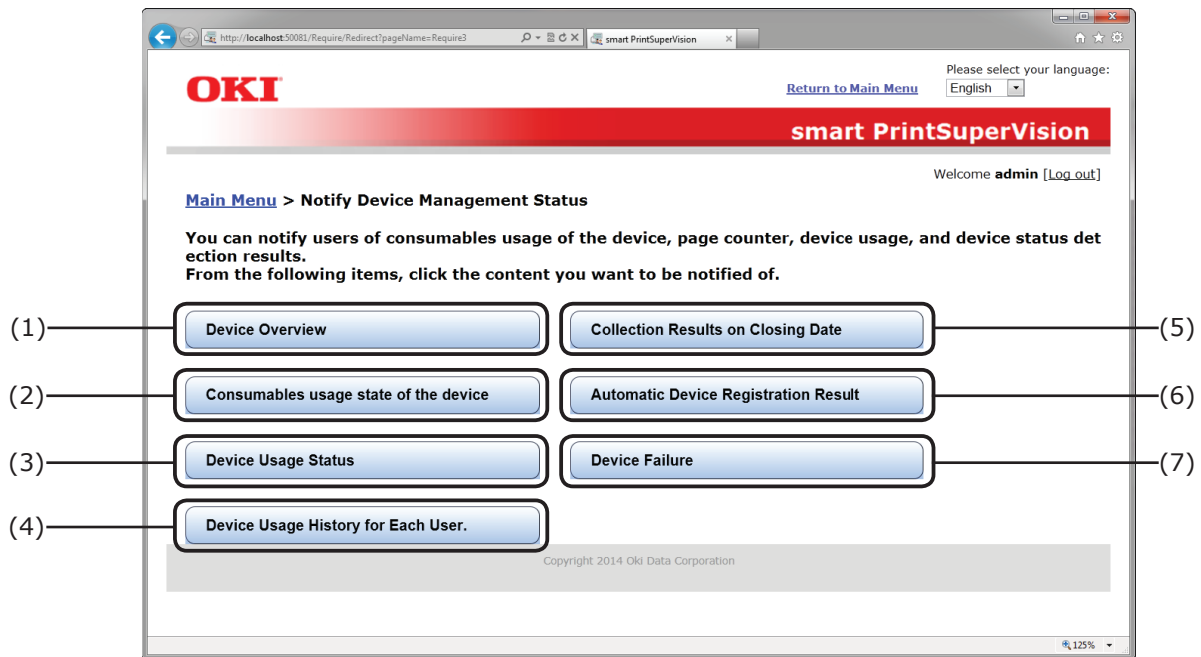



No.	Item	Details
(1)	[Device Overview]	Configure these settings to receive notifications of device information. Click to switch to the options window. ⇒ P. 65
(2)	[Consumables usage state of the device]	Configure the settings for receiving notifications of aggregated results of the amount of consumables used by each device. Click to switch to the options window. ⇒ P. 67
(3)	[Device Usage Status]	Configure the settings for receiving notifications of aggregated results of the print counter of each device. Click to switch to the options window. ⇒ P. 69
(4)	[Device Usage History for Each User.]	Configure the settings for receiving notifications of the aggregate results of the amount of printing for each print job on each device or the management results for each devices or user. Click to switch to the options window. ⇒ P. 71
(5)	[Collection Results on Closing Date]	Configure the settings to create notifications of Device Usage History for Each User. up to the closing date registered in sPSV. Click to switch to the options window. ⇒ P. 73
(6)	[Automatic Device Registration Result]	Configure the settings for receiving notifications of the results of automatic device registrations periodically done by sPSV. Click to switch to the options window. ⇒ P. 75
(7)	[Device Failure]	Configure the notification settings for when a notification target status is detected in each device. Click to switch to the options window. ⇒ P. 77



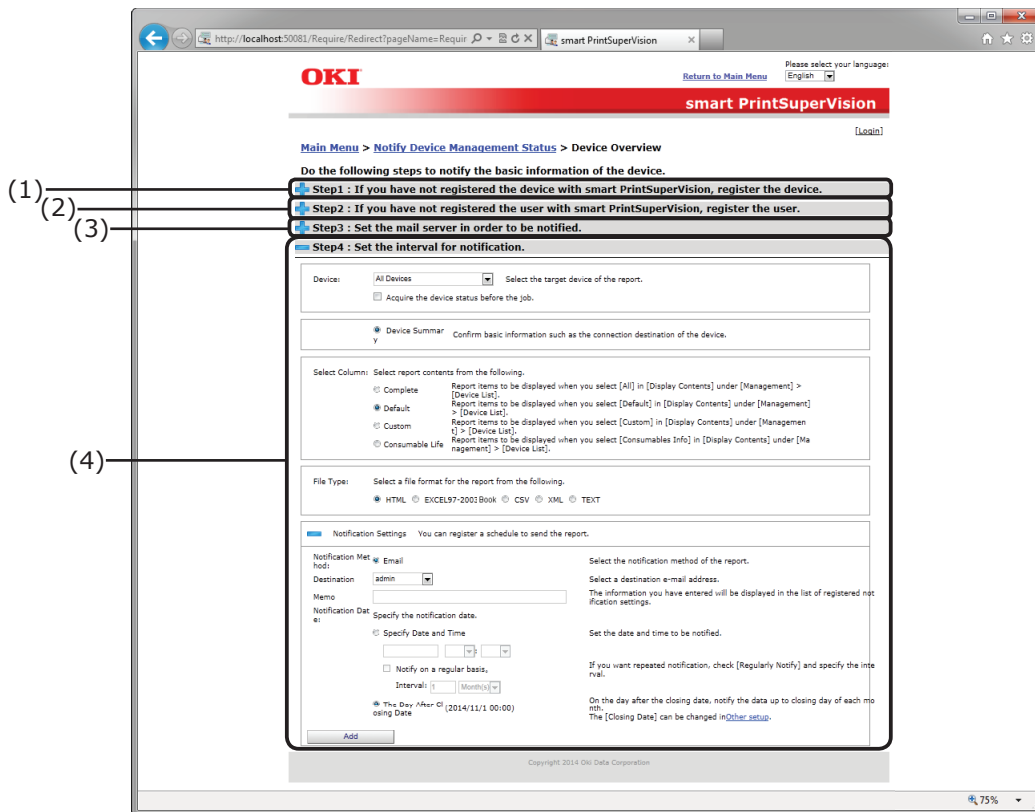

## [Device Overview]

[Main Menu] > [Notify Device Management Status] > [Device Overview]

Configure these settings to receive notifications of basic device information.



No.	Item	Details
(1)	Step 1: Device registration	<p>If the notification target device is not registered, specify [Destination] and click [Start Search]. Search for and register the device. Once the device is registered there is no need to perform registration again. (However, device re-registration is required when a new device is added.)</p> <p>For details, see Details Screen &gt; Management Tab &gt; Register Device (P. 83).</p> <p>To browse group units, click [You can also create a group, and arrange registered devices.] to create a group.</p> <p>For details, see Details Screen &gt; Management Tab &gt; Device Management Settings &gt; Management Group (P. 86).</p> <p> Memo</p> <p>If the setting area is not displayed, click  to open the setting area.</p>

No.	Item	Details
(2)	Step 2: User Registration	<p>If the user who will receive the notification is unregistered, register the user. Once the device is registered there is no need to perform registration again. (However, re-registration is required when a new user is added.)</p> <p>To browse the notification status in user group units, click [Add a Local User Group] to create a group.</p> <p>For details, see Details Screen &gt; Options Tab &gt; User Settings (P. 93).</p> <p> Memo</p> <p>If the setting area is not displayed, click  to open the setting area.</p>
(3)	Step 3: Mail server setting	<p>If the mail server to be used for notification is not configured, configure the mail server settings. Once the user is registered there is no need to perform registration again. (However, re-registration is required if there are changes to the mail server.)</p> <p>For details, see Details Screen &gt; Options Tab &gt; Environment Settings (P. 95).</p> <p>To change the content of comments notified to users, click [You can edit the contents to be notified.] and edit the comment.</p> <p>For details, see Details Screen &gt; Report Tab &gt; Notification Settings &gt; Notification Email Settings (P. 91).</p> <p> Memo</p> <p>If the setting area is not displayed, click  to open the setting area.</p>
(4)	Step 4: Notification schedule settings	<p>Set the interval (schedule) for notifying the device overview list.</p> <p>For details, see Details Screen &gt; Report Tab &gt; Notification Settings &gt; Notification of Device Information (P. 91).</p>







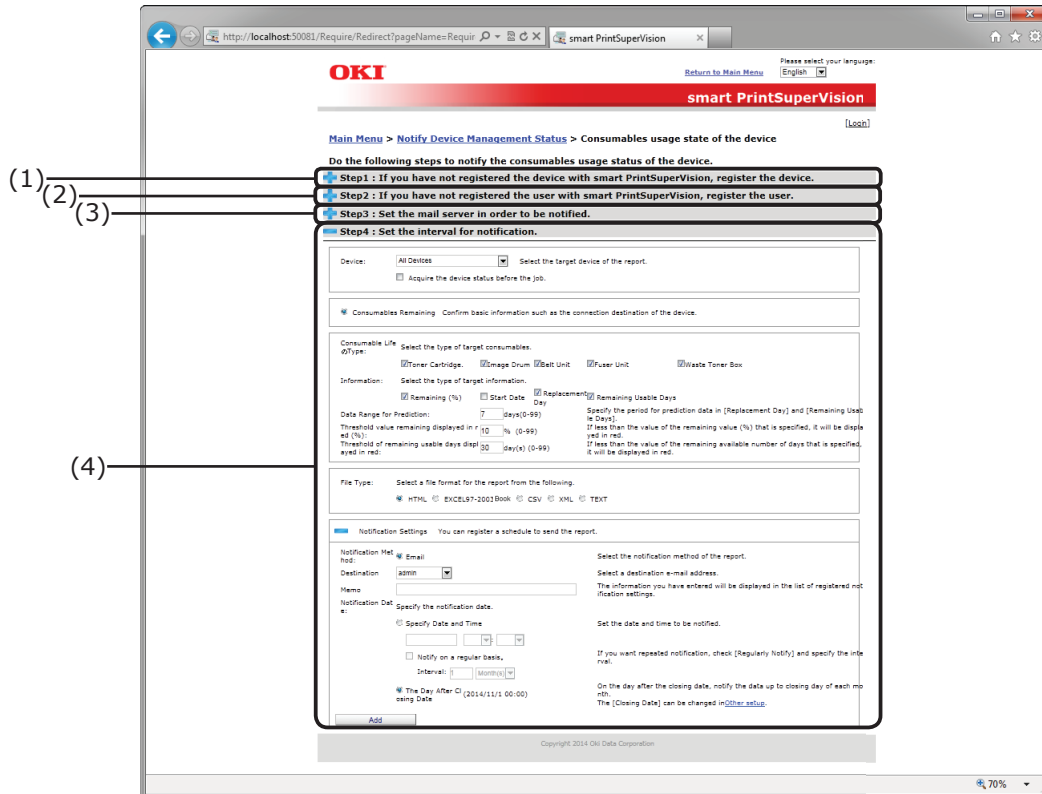

## [Consumables usage state of the device]

[Main Menu] > [Notify Device Management Status] > [Consumables usage state of the device]

Configure the settings for receiving notifications of aggregated results of the amount of consumables used by each device.





No.	Item	Details
(1)	Step 1: Device registration	<p>If the notification target device is not registered, specify [Destination] and click [Start Search]. Search for and register the device. Once the device is registered there is no need to perform registration again. (However, device re-registration is required when a new device is added.) For details, see Details Screen &gt; Management Tab &gt; Register Device (P. 83).</p> <p>To browse group units, click [You can also create a group, and arrange registered devices.] to create a group. For details, see Details Screen &gt; Management Tab &gt; Device Management Settings &gt; Management Group (P. 86).</p> <p> Memo</p> <p>If the setting area is not displayed, click  to open the setting area.</p>





No.	Item	Details
(2)	Step 2: User Registration	<p>If the user who will receive the notification is unregistered, register the user. Once the device is registered there is no need to perform registration again. (However, re-registration is required when a new user is added.)</p> <p>To browse the notification status in user group units, click [Add a Local User Group] to create a group.</p> <p>For details, see Details Screen &gt; Options Tab &gt; User Settings (P. 93).</p> <p> Memo</p> <p>If the setting area is not displayed, click  to open the setting area.</p>
(3)	Step 3: Mail server setting	<p>If the mail server to be used for notification is not configured, configure the mail server settings. Once the device is registered there is no need to perform registration again. (However, re-registration is required if there are changes to the mail server.)</p> <p>For details, see Details Screen &gt; Options Tab &gt; Environment Settings (P. 95).</p> <p>To change the content of comments notified to users, click [You can edit the contents to be notified.] and edit the comment.</p> <p>For details, see Details Screen &gt; Report Tab &gt; Notification Settings &gt; Notification Email Settings (P. 91).</p> <p> Memo</p> <p>If the setting area is not displayed, click  to open the setting area.</p>
(4)	Notification schedule settings Step	<p>Set the interval (schedule) for notifying the device consumable usage state.</p> <p>For details, see Details Screen &gt; Report Tab &gt; Notification Settings &gt; Notification of Device Information (P. 91).</p>

## [Device Usage Status]

[Main Menu] > [Notify Device Management Status] > [Device Usage Status]

Configure the settings for receiving notifications of aggregate results of the page counter for each device.

No.	Item	Details
(1)	Step 1: Device registration	<p>If the notification target device is not registered, specify [Destination] and click [Start Search]. Search for and register the device. Once the device is registered there is no need to perform registration again. (However, device re-registration is required when a new device is added.) For details, see Details Screen &gt; Management Tab &gt; Register Device (P. 83).</p> <p>To browse group units, click [You can also create a group, and arrange registered devices.] to create a group. For details, see Details Screen &gt; Management Tab &gt; Device Management Settings &gt; Management Group (P. 86).</p> <p> Memo</p> <p>If the setting area is not displayed, click  to open the setting area.</p>



No.	Item	Details
(2)	Step 2: User Registration	<p>If the user who will receive the notification is unregistered, register the user. Once the device is registered there is no need to perform registration again. (However, re-registration is required when a new user is added.)</p> <p>To browse the notification status in user group units, click [Add a Local User Group] to create a group.</p> <p>For details, see Details Screen &gt; Options Tab &gt; User Settings (P. 93).</p> <p> Memo</p> <p>If the setting area is not displayed, click  to open the setting area.</p>
(3)	Step 3: Mail server setting	<p>If the mail server to be used for notification is not configured, configure the mail server settings. Once the device is registered there is no need to perform registration again. (However, re-registration is required if there are changes to the mail server.)</p> <p>For details, see Details Screen &gt; Options Tab &gt; Environment Settings (P. 95).</p> <p>To change the content of comments notified to users, click [You can edit the contents to be notified.] and edit the comment.</p> <p>For details, see Details Screen &gt; Report Tab &gt; Notification Settings &gt; Notification Email Settings (P. 91).</p> <p> Memo</p> <p>If the setting area is not displayed, click  to open the setting area.</p>
(4)	Notification schedule settings Step	<p>Set the interval (schedule) for notifying the device usage status.</p> <p>For details, see Details Screen &gt; Report Tab &gt; Notification Settings &gt; Notification of Device Information (P. 91).</p>





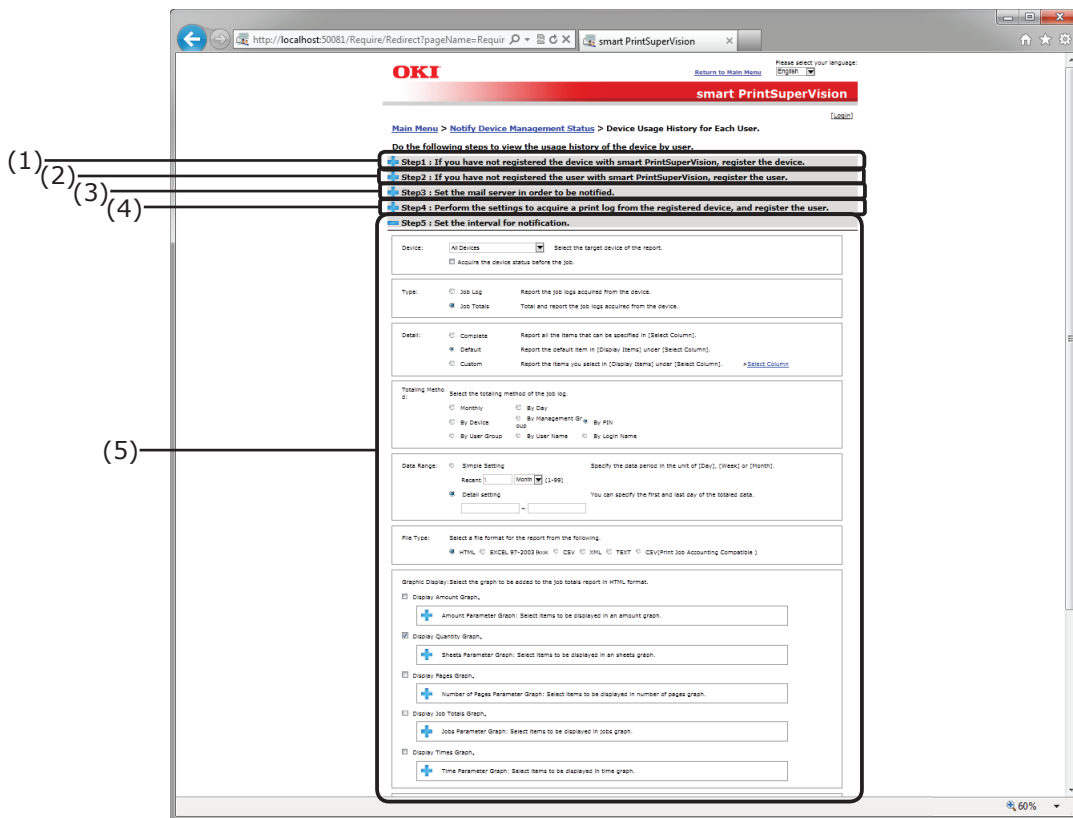

## [Device Usage History for Each User.]

[Main Menu] > [Notify Device Management Status] > [Device Usage History for Each User.]

Configure the settings for receiving notifications of aggregate results of the device usage history for each user.



No.	Item	Details
(1)	Step 1: Device registration	<p>If the notification target device is not registered, specify [Destination] and click [Start Search]. Search for and register the device. Once the device is registered there is no need to perform registration again. (However, device re-registration is required when a new device is added.)</p> <p>For details, see Details Screen &gt; Management Tab &gt; Register Device (P. 83).</p> <p>To browse group units, click [You can also create a group, and arrange registered devices.] to create a group. For details, see Details Screen &gt; Management Tab &gt; Device Management Settings &gt; Management Group (P. 86).</p> <p> Memo</p> <p>If the setting area is not displayed, click  to open the setting area.</p>



No.	Item	Details
(2)	Step 2: User Registration	<p>If the user who will receive the notification is unregistered, register the user. Once the device is registered there is no need to perform registration again. (However, re-registration is required when a new user is added.)</p> <p>To browse the notification status in user group units, click [Add a Local User Group] to create a group.</p> <p>For details, see Details Screen &gt; Options Tab &gt; User Settings (P. 93).</p> <p></p> <p>If the setting area is not displayed, click  to open the setting area.</p>
(3)	Step 3: Mail server setting	<p>If the mail server to be used for notification is not configured, configure the mail server settings. (Once the user is registered you do not need to perform registration again. (However, re-registration is required if there are changes to the mail server.)</p> <p>For details, see Details Screen &gt; Options Tab &gt; Environment Settings (P. 95).</p> <p>To change the content of comments notified to users, click [You can edit the contents to be notified.] and edit the comment.</p> <p>For details, see Details Screen &gt; Report Tab &gt; Notification Settings &gt; Notification Email Settings (P. 91).</p> <p></p> <p>If the setting area is not displayed, click  to open the setting area.</p>
(4)	Step 4: Add User/Acquire Print Log	<p>Configure the settings so that print log can be received by the registered device, and register the user. Once the device is registered there is no need to perform registration again. (However, device re-registration is required when a new device is added.)</p> <p>For details, see Details Screen &gt; Management Tab &gt; Device Management Settings (P. 84).</p> <p></p> <p>If the setting area is not displayed, click  to open the setting area.</p>
(5)	Step 5: Notification schedule settings	<p>Set the interval (schedule) for notifying the device usage history for the user.</p> <p>For details, see Details Screen &gt; Report Tab &gt; Notification Settings &gt; Notification of Job Information (P. 91).</p>





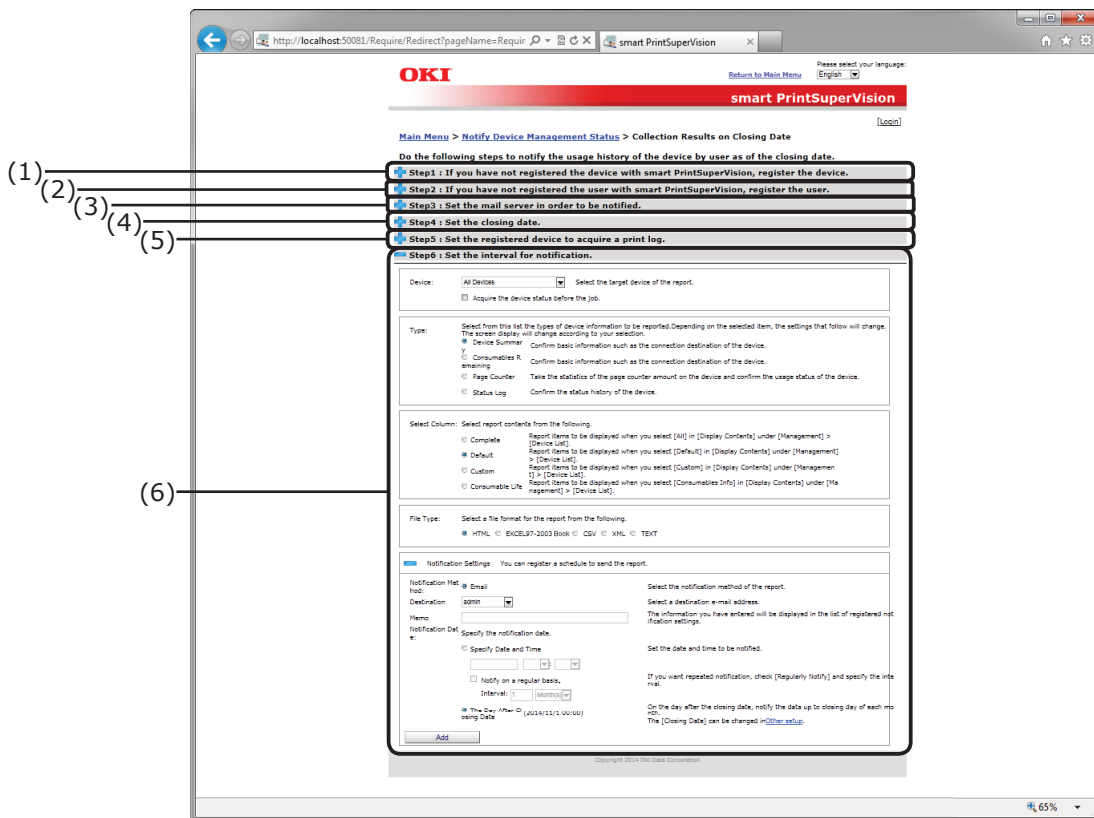

## [Collection Results on Closing Date]

[Main Menu] > [Notify Device Management Status] > [Collection Results on Closing Date]

Configure the settings for receiving notifications of aggregated results of the device usage history for each user based on the closing date.



No.	Item	Details
(1)	Step 1: Device registration	<p>If the notification target device is not registered, specify [Destination] and click [Start Search]. Search for and register the device. Once the device is registered there is no need to perform registration again. (However, device re-registration is required when a new device is added.) For details, see Details Screen &gt; Management Tab &gt; Register Device (P. 83).</p> <p>To browse group units, click [You can also create a group, and arrange registered devices.] to create a group. For details, see Details Screen &gt; Management Tab &gt; Device Management Settings &gt; Management Group (P. 86).</p> <p> Memo</p> <p>If the setting area is not displayed, click  to open the setting area.</p>



No.	Item	Details
(2)	Step 2: User Registration	<p>If the user who will receive the notification is unregistered, register the user. Once the device is registered there is no need to perform registration again. (However, re-registration is required when a new user is added.)</p> <p>To browse the notification status in user group units, click [Add a Local User Group] to create a group.</p> <p>For details, see Details Screen &gt; Options Tab &gt; User Settings (P. 93).</p> <p> Memo</p> <p>If the setting area is not displayed, click  to open the setting area.</p>
(3)	Step 3: Mail server setting	<p>If the mail server to be used for notification is not configured, configure the mail server settings. (Once the user is registered there is no need to perform registration again. (However, re-registration is required if there are changes to the mail server.)</p> <p>For details, see Details Screen &gt; Options Tab &gt; Environment Settings (P. 95).</p> <p>To change the content of comments notified to users, click [You can edit the contents to be notified.] and edit the comment.</p> <p>For details, see Details Screen &gt; Report Tab &gt; Notification Settings &gt; Notification Email Settings (P. 91).</p> <p> Memo</p> <p>If the setting area is not displayed, click  to open the setting area.</p>
(4)	Step 4: Set a closing date	<p>Set the closing date. Once the device is registered there is no need to perform registration again. (However, re-registration is required if there are changes to the closing date.)</p> <p>For details, see Details Screen &gt; Options Tab &gt; Environment Settings &gt; Other Settings (P. 95).</p>
(5)	Step 5: Add User/Acquire Print Log	<p>Configure the settings so that the print log can be received by the registered device, and register the user. Once the device is registered there is no need to perform registration again. (However, device re-registration is required when a new device is added.)</p> <p>For details, see Details Screen &gt; Management Tab &gt; Device Management Settings (P. 84).</p> <p> Memo</p> <p>If the setting area is not displayed, click  to open the setting area.</p>
(6)	Step 6: Notification schedule settings	<p>Set the interval (schedule) for notifying the collection status up to the closing date.</p> <p>For details, see Details Screen &gt; Report Tab &gt; Notification Settings &gt; Notification of Device Information (P. 91).</p>



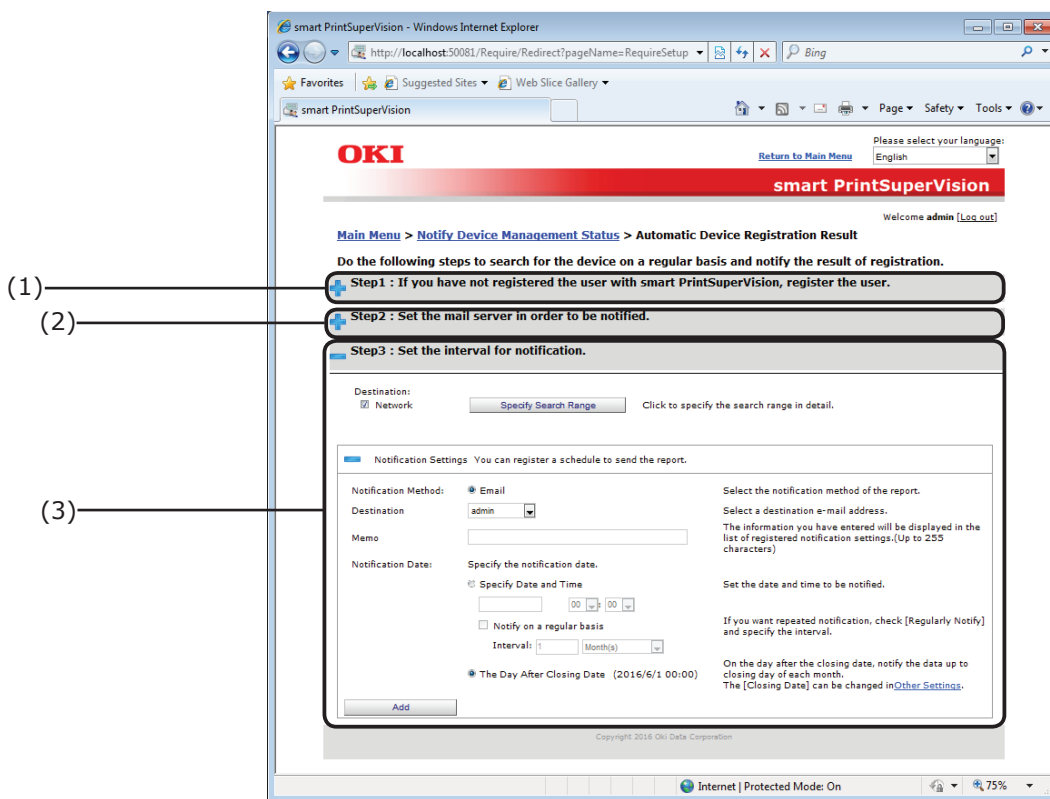

## [Automatic Device Registration Result]

[Main Menu] > [Notify Device Management Status] > [Automatic Device Registration Result]  
 Configure the settings for searching periodically for devices and notifying the results when a device was registered.



No.	Item	Details
(1)	Step 1: User Registration	<p>If the user who will receive the notification is unregistered or the notification destination email address is unregistered, register the user or email address. Once the device is registered there is no need to perform registration again. (However, re-registration is required when a new notification destination user is added or email address is changed.)</p> <p>For details, see Details Screen &gt; Options Tab &gt; User Settings (P. 93).</p> <p> Memo</p> <p>If the setting area is not displayed, click  to open the setting area.</p>



No.	Item	Details
(2)	Step 2: Mail server setting	<p>If the mail server to be used for notification is not configured, configure the mail server settings. (Once the user is registered there is no need to perform registration again. (However, re-registration is required if there are changes to the mail server.)</p> <p>For details, see Details Screen &gt; Options Tab &gt; Environment Settings (P. 95).</p> <p>To change the content of comments notified to users, click [You can edit the contents to be notified.] and edit the comment.</p> <p>For details, see Details Screen &gt; Report Tab &gt; Notification Settings &gt; Notification Email Settings (P. 91).</p> <p> Memo</p> <p>If the setting area is not displayed, click  to open the setting area.</p>
(3)	Step 3: Set a notification schedule	<p>Configure the search criteria and interval (schedule) for periodically searching/registering.</p> <p>For details, see Details Screen &gt; Report Tab &gt; Notification Settings &gt; Automatic Notification on Device Registration (P. 91).</p>



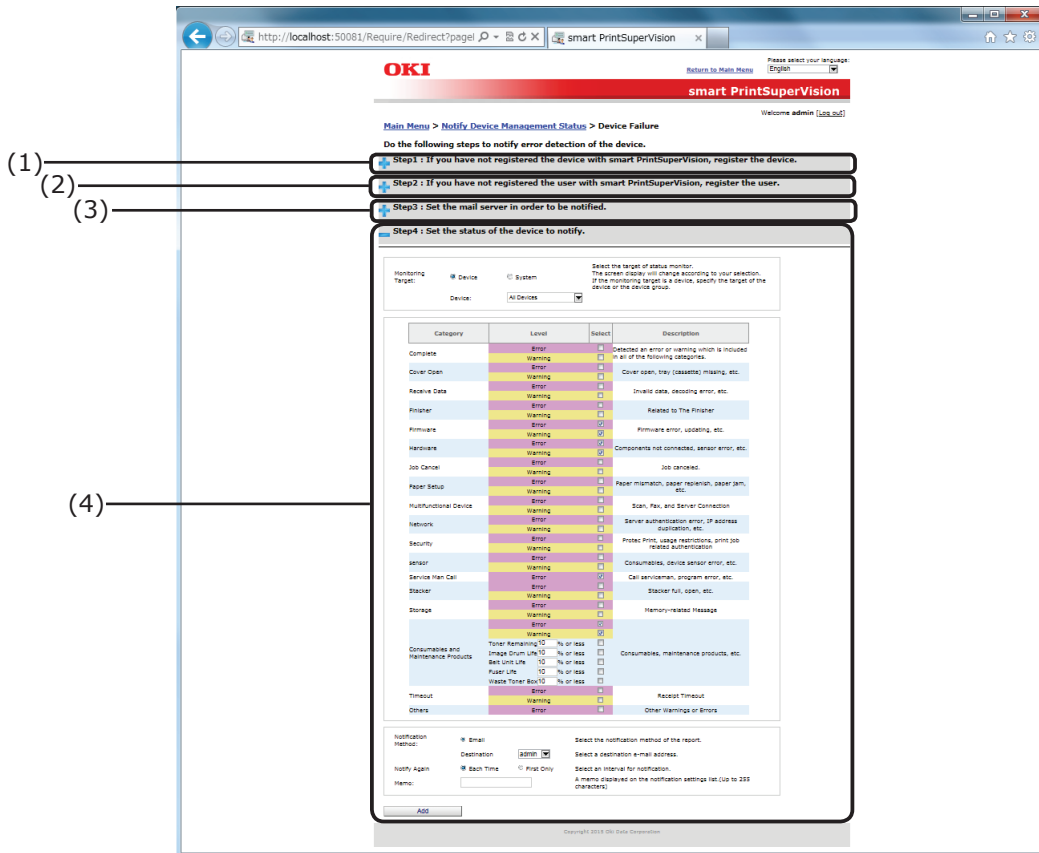

## [Device Failure]

[Main Menu] > [Notify Device Management Status] > [Device Failure]

Configure these settings to receive notifications of detected device failures.



No.	Item	Details
(1)	Step 1: Device registration	<p>If the notification target device is not registered, specify [Destination] and click [Start Search]. Search for and register the device. Once the device is registered there is no need to perform registration again. (However, device re-registration is required when a new device is added.) For details, see Details Screen &gt; Management Tab &gt; Register Device (P. 83).</p> <p>To browse group units, click [You can also create a group, and arrange registered devices.] to create a group. For details, see Details Screen &gt; Management Tab &gt; Device Management Settings &gt; Management Group (P. 86).</p> <p> Memo</p> <p>If the setting area is not displayed, click  to open the setting area.</p>

No.	Item	Details
(2)	Step 2: User Registration	<p>If the user who will receive the notification is unregistered, register the user. Once the device is registered there is no need to perform registration again. (However, re-registration is required when a new user is added.)</p> <p>To browse the notification status in user group units, click [Add a Local User Group] to create a group.</p> <p>For details, see Details Screen &gt; Options Tab &gt; User Settings (P. 93).</p> <p> Memo</p> <p>If the setting area is not displayed, click  to open the setting area.</p>
(3)	Step 3: Mail server setting	<p>If the mail server to be used for notification is not configured, configure the mail server settings. (Once the user is registered there is no need to perform registration again. (However, re-registration is required if there are changes to the mail server.)</p> <p>For details, see Details Screen &gt; Options Tab &gt; Environment Settings (P. 95).</p> <p>To change the content of comments notified to users, click [You can edit the contents to be notified.] and edit the comment.</p> <p>For details, see Details Screen &gt; Report Tab &gt; Notification Settings &gt; Notification Email Settings (P. 91).</p> <p> Memo</p> <p>If the setting area is not displayed, click  to open the setting area.</p>
(4)	Step 4: Detection Status Setting	<p>Set the interval (schedule) for notifying the when the status of the specified device is detected.</p> <p>For details, see Details Screen &gt; Report Tab &gt; Notification Settings &gt; Status Notification (P. 91).</p>

## Details Screen

This window is arranged according to types of sPSV function. Functions are separated by tabs. Click [Go to Details Screen] on the main menu window to display the top page of the Details Screen (top page of the [Manage] tab).

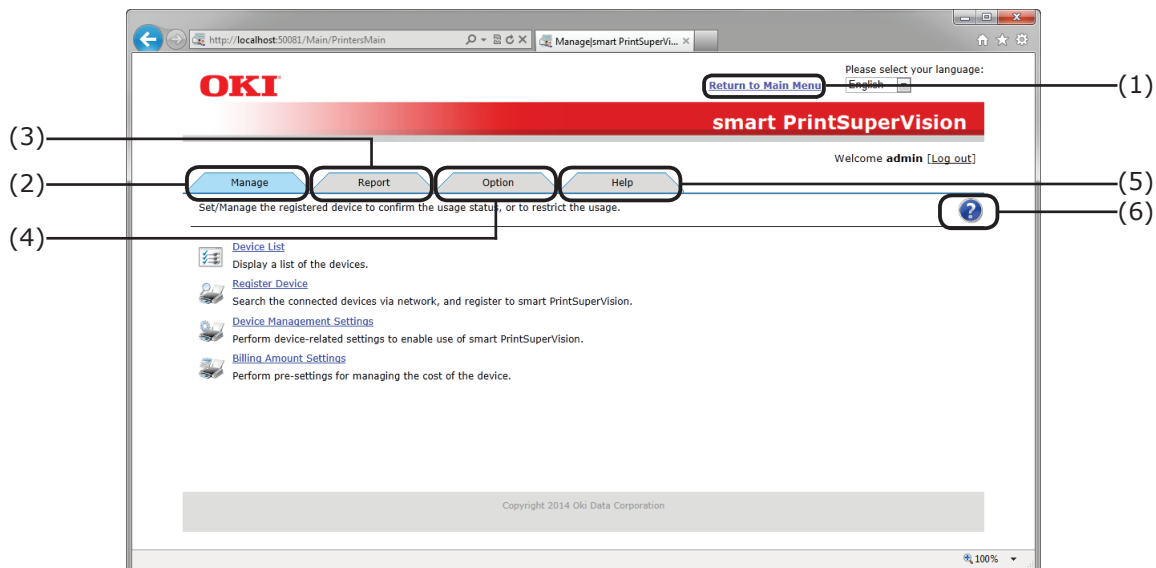

No.	Item	Details
(1)	[Return to Main Menu]	Click to switch to the main menu. ⇒ P. 51
(2)	[Manage] Tab	Configure functions related to the device, such as device registration, access control settings to the device and billing amount settings. Click to switch to the options window. ⇒ P. 80
(3)	[Report] Tab	Check the device usage status or sPSV operating status, and configure settings such as email notification receipt settings. Click to switch to the options window. ⇒ P. 89
(4)	[Option] Tab	Configure the settings of various options used with this software. Click to switch to the options window. ⇒ P. 92
(5)	[Help] Tab	Browse sPSV help information, version information and other related information. ⇒ P. 101
(6)	Help Icon	Click to display help related to the currently displayed page in a different window. ⇒ P. 105

## [Manage] Tab

[Details Screen] > [Manage]

Set/Manage the registered device to confirm the usage status, or to restrict the usage.

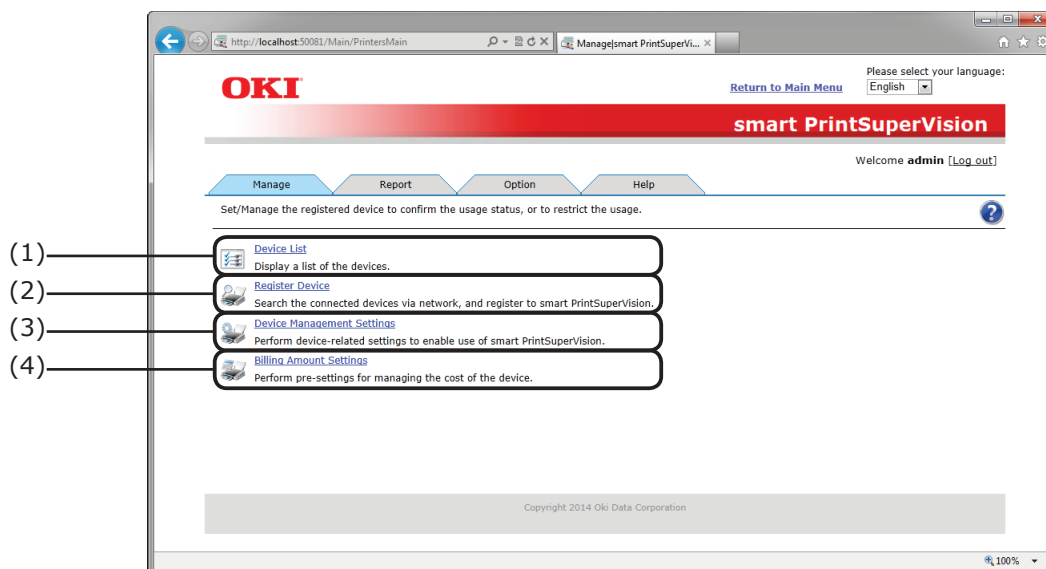

No.	Item	Details
(1)	[Device List]	Check the device list information. Click to switch to the details screen. ⇒ P. 81
(2)	[Register Device]*	Search for devices connected to the network and register to sPSV. Click to switch to the details screen. ⇒ P. 83
(3)	[Device Management Settings]	Configure device settings related to the use of sPSV. Click to switch to the details screen. ⇒ P. 84
(4)	[Billing Amount Settings]*	Perform pre-settings for managing the cost of the device. Click to switch to the details screen. ⇒ P. 87

\*Log in as an administrator to configure these settings.







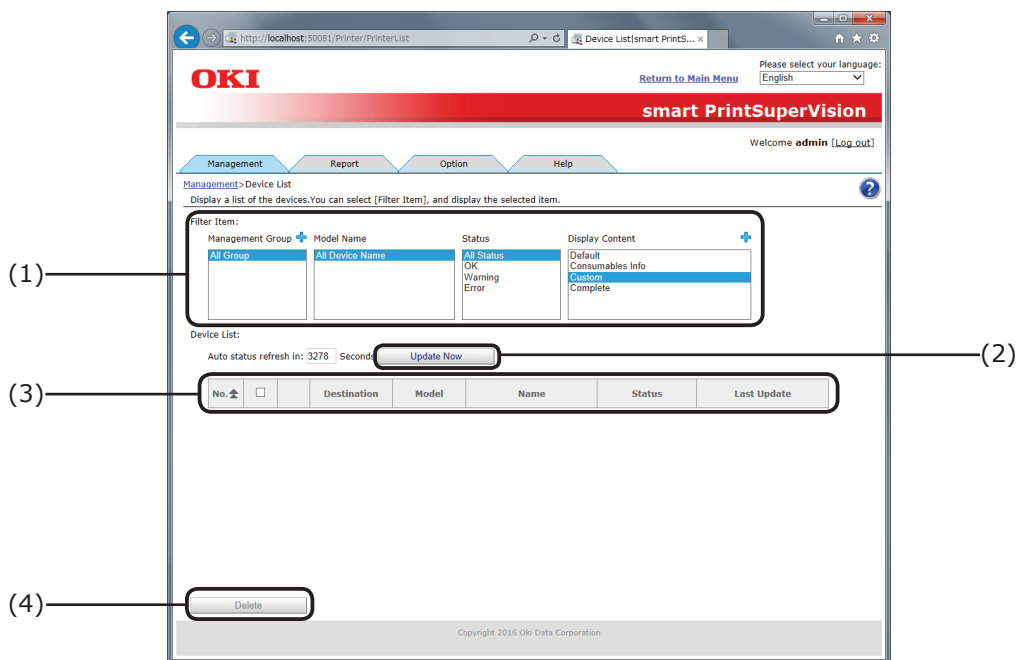





**[Device List]**

[Details Screen] > [Manage] > [Device List]

Display a list of the registered devices.



No.	Item	Details	
(1)	[Filter Item]	Select the [Filter Item] to filter device information displayed in the device list.	
	Management Group	Specify and display the management group name. Click <b>+</b> to switch to the [Management Group] window.	
	Device Name	Specify and display the device model name.	
	Model Name	Specify and display the device status.	
		Status	Details
		All Status	Display all devices.
		OK	Display devices that do not have a warning or error status.
	Warning	Display devices that have a warning status.	
	Error	Display devices that have an error status.	
	Display Content	Specify the items to display from [Device List]. Click <b>+</b> to switch to the [Edit Display Contents] window.	
Item		Details	
Standard		Display default items.	
Consumables Info		Display items related to consumable life.	
Custom		Display items selected in [Edit Display Contents].	
All	Display all items.		

No.	Item	Details										
(2)	[Update Now]	Search for devices to connect to the network and register to sPSV. Click to switch to the details screen.										
(3)	[Device List]	<p>Display device information for each item. Click the icon to switch to the [Device Settings] window of the clicked device.</p> <p> <b>When an item name is clicked, the order is sorted (changed) according to the item contents. When clicked again, the items are sorted in reverse order.</b></p> <table border="1" data-bbox="563 551 1477 954"> <thead> <tr> <th data-bbox="563 551 807 602">Icon</th> <th data-bbox="807 551 1477 602">Details</th> </tr> </thead> <tbody> <tr> <td data-bbox="563 602 807 692"></td> <td data-bbox="807 602 1477 692">Display statuses that are not related to warnings or errors.</td> </tr> <tr> <td data-bbox="563 692 807 759"></td> <td data-bbox="807 692 1477 759">Display status that are related to warnings.</td> </tr> <tr> <td data-bbox="563 759 807 826"></td> <td data-bbox="807 759 1477 826">Display status that are related to errors.</td> </tr> <tr> <td data-bbox="563 826 807 954"></td> <td data-bbox="807 826 1477 954">Display status related to the device not being connected for any reason, such as offline or power off states.</td> </tr> </tbody> </table>	Icon	Details		Display statuses that are not related to warnings or errors.		Display status that are related to warnings.		Display status that are related to errors.		Display status related to the device not being connected for any reason, such as offline or power off states.
Icon	Details											
	Display statuses that are not related to warnings or errors.											
	Display status that are related to warnings.											
	Display status that are related to errors.											
	Display status related to the device not being connected for any reason, such as offline or power off states.											
(4)	[Delete]	Click to delete registration of devices checked in [Device List] from sPSV.										





**[Register Device]**

[Details Screen] &gt; [Manage] &gt; [Register Device]

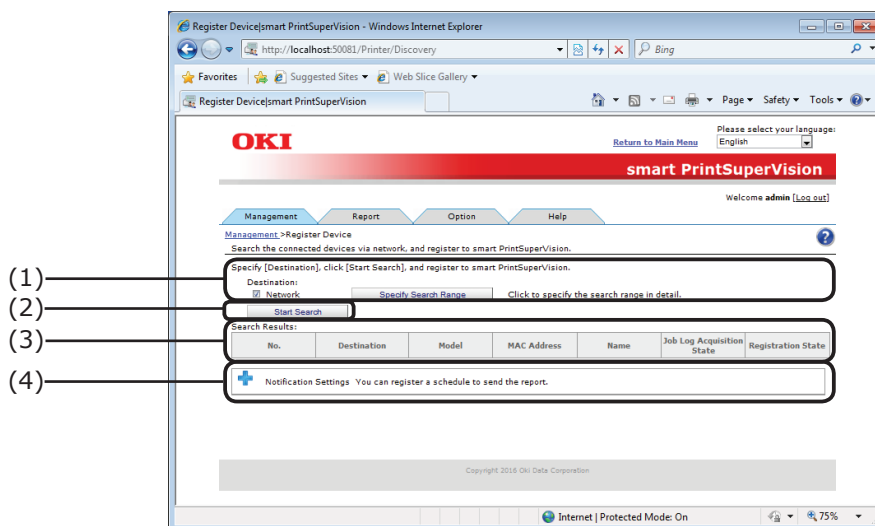
Search for devices to connect to the network and register to sPSV.



No.	Item	Details
(1)	[Destination]	Specify the connection destination of the searched device. Click [Specify Search Range] to configure detailed settings for network searching.
(2)	[Start Search]	Device search is performed based on the conditions specified in [Destination], and the found devices are displayed in [Search Results].
(3)	[Search Results]	Displays the search results.
	[Registration State]	Displays whether the device is already registered in sPSV.
	[Newly Registered]	Displays devices that were unregistered in sPSV.
(4)	[Registered]	Displays devices that are registered in sPSV.
	[Notification Settings]	<p>Adds a schedule for periodically searching for and registering devices.</p> <p></p> <p>If the setting area is not displayed, click  to open the setting area.</p>

**[Device Management Settings]**

[Details Screen] &gt; [Manage] &gt; [Device Management Settings]

Configure device settings related to the use of sPSV.

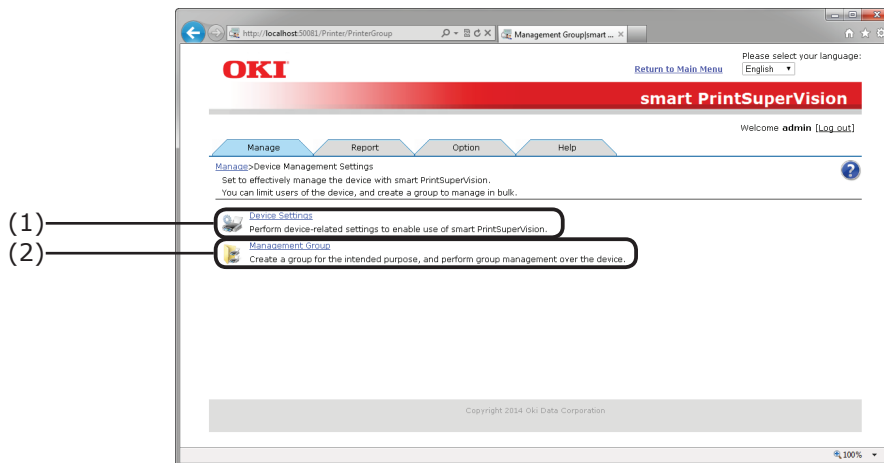

No.	Item	Details
(1)	[Device Settings]*	Configure device settings related to the use of sPSV. Click to switch to the details screen. ⇒ P. 85
(2)	[Management Group]*	Create a group for the intended purpose, and perform group management over the device. Click to switch to the [Management Group] window. ⇒ P. 86

\*Log in as an administrator to configure these settings.

**[Device Settings]**

[Details Screen] > [Manage] > [Device Management Settings] > [Device Settings]

Configure settings for displaying device information, controlling device logs and configuring device use restrictions.

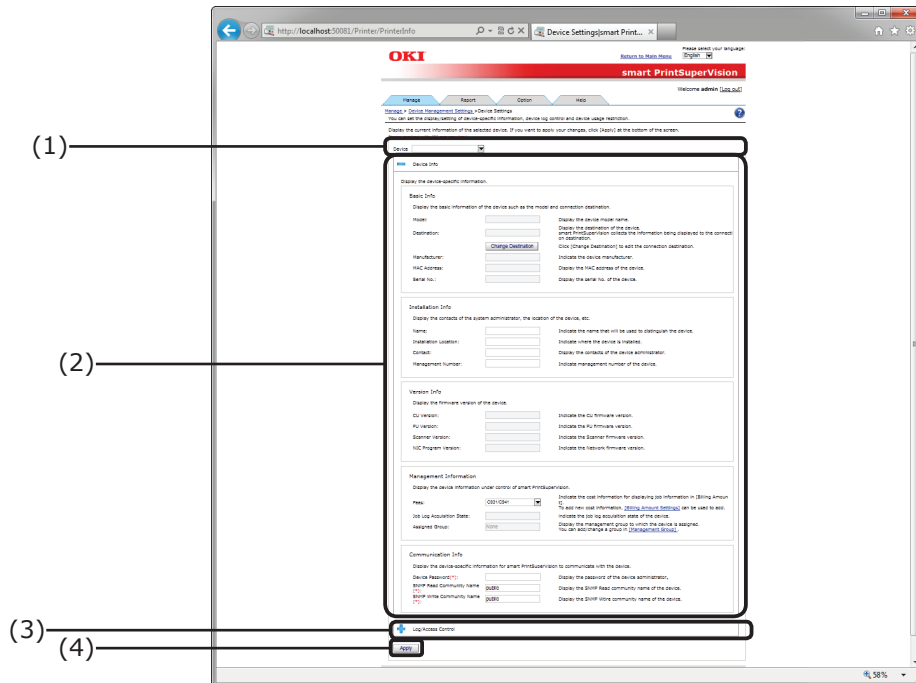





No.	Item	Details
(1)	[Device]	Select devices that are registered in sPSV.
(2)	[Device Info]	Display/configure basic device information.
(3)	[Log/Access Control]	Display/configure device job log (fee log) settings and access controls.
(4)	[Apply]	Click to apply the [Device Info] and [Log/Access Control] settings. <div style="border: 1px solid black; padding: 2px; display: inline-block; margin: 5px 0;">Memo</div> After clicking, some devices require authentication using the administrator password for the device.

**[Management Group]**

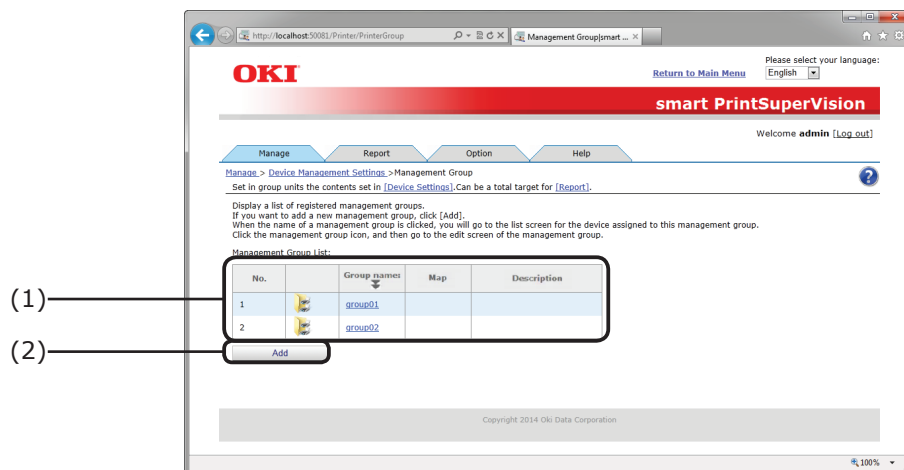
[Details Screen] &gt; [Manage] &gt; [Device Management Settings] &gt; [Management Group]

Create a group for the intended purpose, and perform group management over the device.



No.	Item	Details
(1)	[Management Group List]	Display the management group registered in sPSV in the list box. 
	[Management Group Icon  ]	Click to display the [Device List] window for the devices assigned to the clicked management group.
	[Group name]*	Display the management group name. Click to switch to the management group edit window.
	[Map]	When a map is set for the management group, a map icon  is displayed. Click to switch to the management group map window. However, nothing is displayed when there is no map set for the management group. For information on how to configure the map settings, see "Registering the Installation Position of Devices Belonging to a Management Group" (P. 223).
	[Description]	The description of the management group is displayed. (Details specified at registration.)
(2)	[Add]*	Click to switch to the add management group window.



\*Log in as an administrator to configure these settings.

## [Billing Amount Settings]

[Details Screen] > [Manage] > [Billing Amount Settings]

Configure settings for managing the cost of the device.

The screenshot shows the 'Billing Amount Settings' page in a web browser. At the top, there's a navigation bar with 'Management', 'Report', 'Option', and 'Help'. Below that, there's a section for 'Billing Amount Settings' with instructions. A dropdown menu labeled 'Fees' (1) is set to 'Default'. Below it is a text input field for 'Name (\*)' (2). A large section titled 'Pages' (3) contains several sub-sections: 'Pages' (with a checked box for including page quantity), 'Color Printing Cost' (10), 'Mono Printing Cost' (10), 'Spot color 1 Printing Cost' (10), 'Spot color 2 Printing Cost' (10), and 'Include in the billing amount the quantity of printed sheets of the job information.' (unchecked). Below these are expandable sections for 'Toner use amount', 'Drum use amount', 'Belt/Fuser use amount', 'Paper Size', 'Media Type', 'Tray', and 'Finisher'. At the bottom of the form are 'Apply' and 'Delete' buttons (4). A red box highlights the 'Pages' section, and a blue box highlights the 'Apply' and 'Delete' buttons. A copyright notice 'Copyright 2016 Oki Data Corporation' is visible at the bottom.

No.	Item	Details
(1)	[Fees]	Select billing amount setting names registered in sPSV.
(2)	[Name]	Enter the billing amount setting name. (A maximum of 32 1- or 2-byte characters can be input) When a fee registered in [Fees] is selected, the name of the fee is displayed.
(3)	[Cost Target]	Configure cost settings.  Pages other than [Pages] are displayed in the closed state. Therefore, click  to display the details window whenever necessary.
	[Pages]	Specify the printing cost per page or per sheet.
	[Toner use amount]	The toner use amount is divided into 6 levels per page, and the cost is specified for each level.
	[Drum use amount]	Specify the drum use amount cost per page.
	[Belt/fuser use amount]	Specify the belt/fuser use amount cost per page.
	[Paper Size]	Specify the paper size cost per sheet.
	[Media Type]	Specify the media type cost per sheet.
	[Tray]	Specify the cost per sheet from the supply tray.
	[Finisher]	Specify the cost per one staple used in the finisher.

---

No.	Item	Details
(4)	[Apply]	Click to apply the details of the settings configured in the [Billing Amount Settings] page. Newly created fees are added to [Fees].
(5)	[Delete]	Delete the selected billing amount settings. (This button cannot be used while changing or creating new billing amount settings.)

## [Report] Tab

[Details Screen] > [Report]

Check the device usage status or sPSV operating status, and configure settings such as email notification receipt settings.



No.	Item	Details
(1)	[Display Report]	Check the device usage status or sPSV operating status. Click to switch to the display report page. ⇒ P. 90
(2)	[Notification Settings]	Configure settings for the device usage status or sPSV operating status notifications. Click to switch to the notification settings page. ⇒ P. 91 Can be used by the administrator.

**[Display Report]**

[Details Screen] &gt; [Report] &gt; [Display Report]

Check the status or usage amount of registered devices.

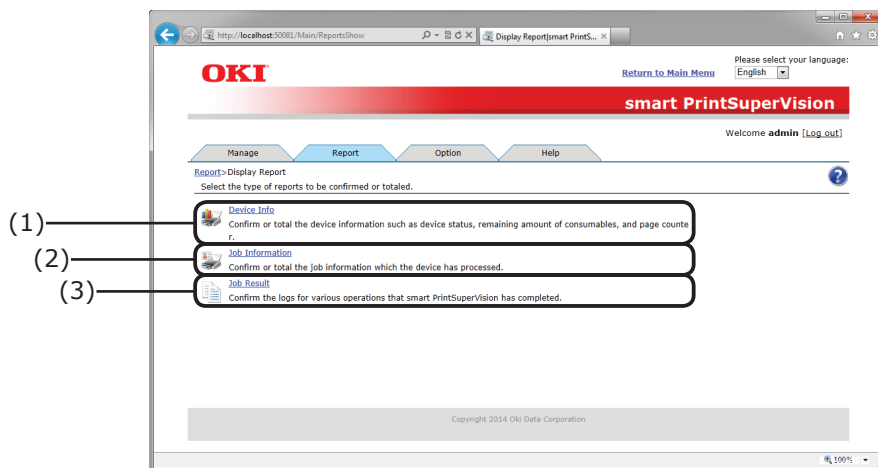

No.	Item	Details
(1)	[Device Info]	Check the amount of maintenance items used, remaining amount of consumables or the device usage status. Switch to the device info page.
(2)	[Job Information]	Check the information jobs in which the device was used. Switch to the job information page. Can be used by the administrator or default user.
(3)	[Job Result]	Check the sPSV operating status. Switch to the job result page. Can be used by the administrator.



## [Notification Settings]

[Details Screen] > [Report] > [Notification Settings]

The addition of report sending schedules, and editing and deletion of registered schedules are available.

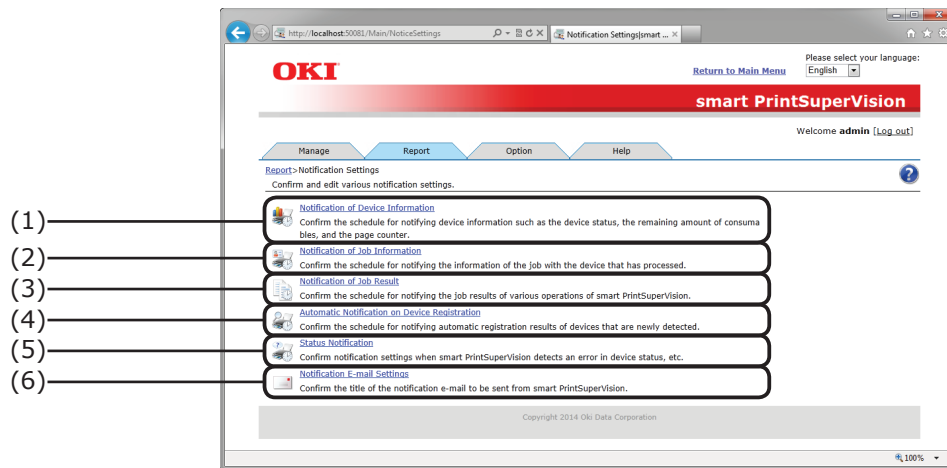

No.	Item	Details
(1)	[Notification of Device Information]	Configure the schedule for notifying the amount of maintenance items used or remaining amount of consumables. Switch to the device information notification page.
(2)	[Notification of Job Information]	Set the schedule by which information of jobs processed by the device is displayed. Switch to the job information notification page.
(3)	[Notification of Job Result]	Set the schedule for notifying the sPSV operating status. Switch to the job result notification page.
(4)	[Automatic Notification on Device Registration]	Set the schedule for notifying the results of searching for new devices. Switch to the automatic device registration notification page.
(5)	[Status Notification]	Configure settings for detecting and notifying the device status. Switch to the status notification page.
(6)	[Notification E-mail Settings]	Set the title and email content when sending the notification email described above. Switch to the email settings notification page.

## [Option] Tab

[Details Screen] > [Option]

Configure the settings of various options used with this software.

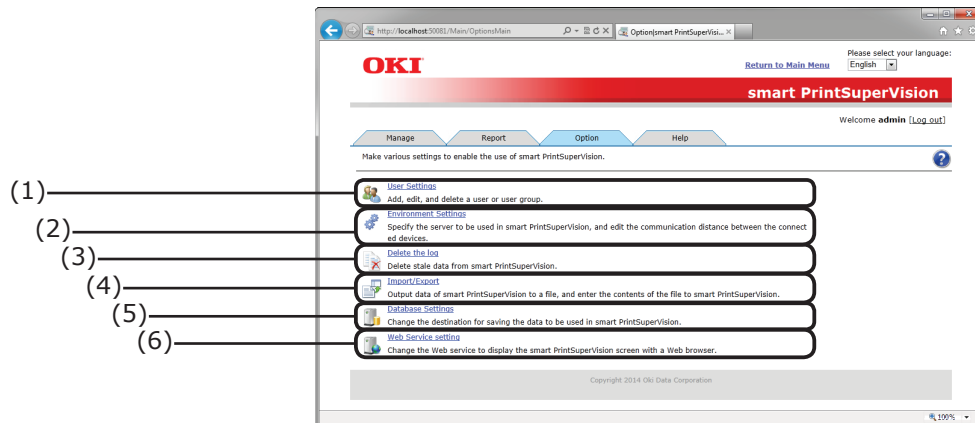

No.	Item	Details
(1)	[User Settings]	Add/edit/delete users and user groups. Device use restrictions can be configured for registered users. Click to switch to the user settings page. ⇒ P. 93 Can be used by the administrator or default user. (General users can only view their own account and change their password.)
(2)	[Environment Settings]	Edit server specifications and the time before network timeout. Click to switch to the environment settings page. ⇒ P. 95 Can be used by the administrator
(3)	[Delete the log]	Delete old data from the database. Click to switch to delete log page. ⇒ P. 96 Can be used by the administrator
(4)	[Import/Export]**	Export sPSV database data or import an existing database into an sPSV database. Click to switch to the import/export page. ⇒ P. 97 Only displayed on the sPSV server Can be used by the administrator
(5)	[Database Settings]**	Used when changing the data save location of a database. Click to switch to the database settings page. ⇒ P. 98 Only displayed on the sPSV server Can be used by the administrator
(6)	[Web Service]**	Configure settings for displaying sPSV in a web browser. Click to switch to the web service page. ⇒ P. 100 Only displayed on the sPSV server. Can be used by the administrator.



Configure settings marked with \*\* using the computer on which sPSV is installed.

## [User Settings]

[Details Screen] > [Option] > [User Settings]

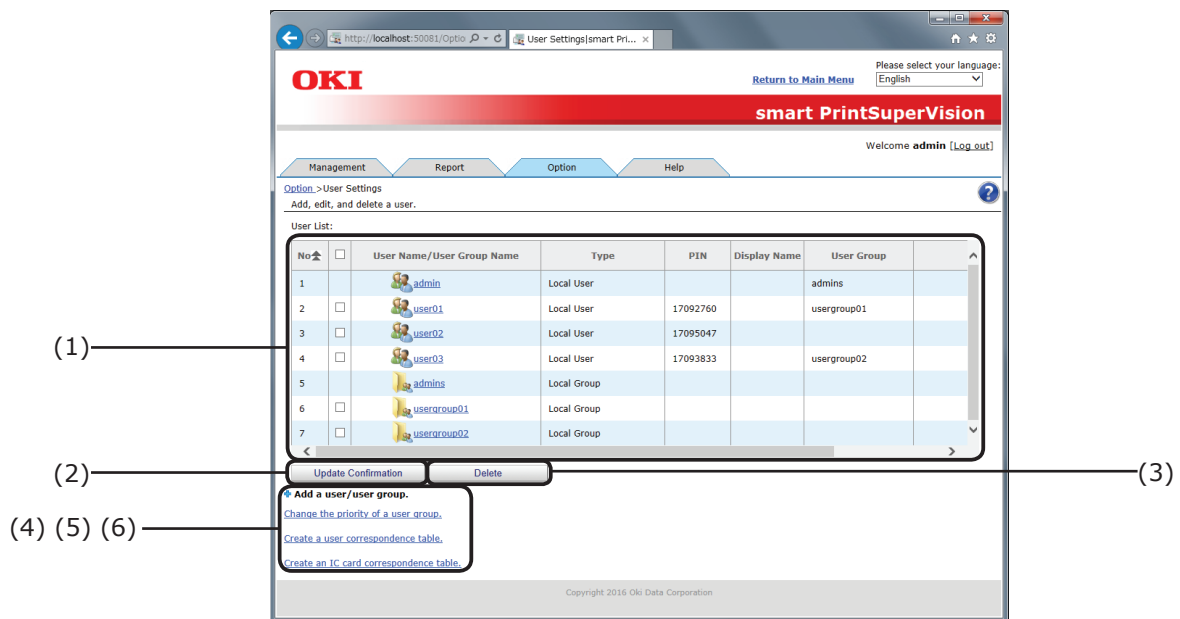
Add/edit/delete users and user groups



No.	Item	Details
(1)	[User/User Group List]	<p>Display a list of sPSV users and user groups. All users and user groups are displayed in a list when logging in as the administrator. However, when logging in as a general user, only the said user and assigned user groups are displayed in the list.</p> <p>Click the user name/user group name to switch to the information page of the user/user group.</p> <p> Memo</p> <p>“admin” (administrator) and “admins” (administrator groups) are always displayed. (The initial admin password is “password”.)</p>
(2)	[Update Confirmation]	Active Directory changes are reflected in sPSV.
(3)	[Delete]	<p>Delete the user/user group selected in [User/User Group List].</p> <p>The user/user group deletion confirmation window is displayed before deletion to request confirmation.</p>
(4)	[Add a user/user group.]	Click  to display the following items.
	[Add a user/user group by searching the Active Directory.]	Click to switch to the page for adding a user/user group from the Active Directory.
	[Add a Local User Group]	Click to switch to the user group information page.
	[Add a Local User]	Click to switch to the local user information page.

---

No.	Item	Details
(5)	[Change the priority of a user group.]	Click to switch to the user group priority order page.
(6)	[Create a user correspondance table]	Click to switch to the user correspondance table page.

## [Environment Settings]

[Details Screen] > [Option] > [Environment Settings]

Configure settings for server linkage, network communications, etc.

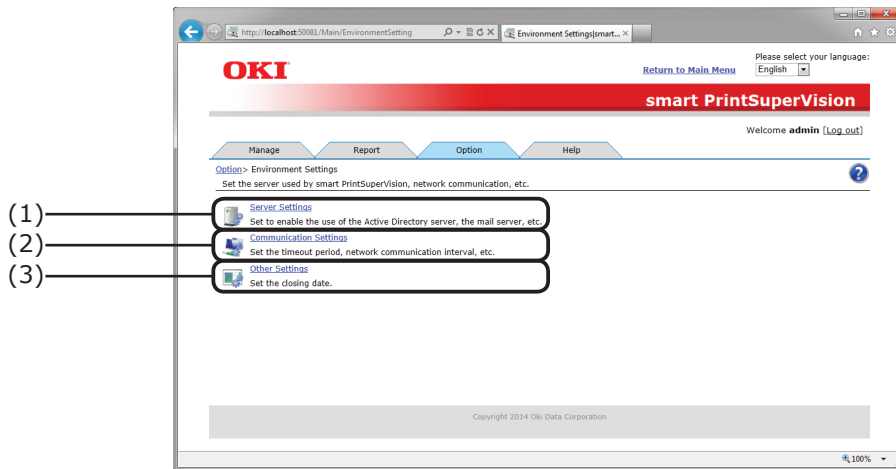



No.	Item	Details
(1)	[Server Settings]	Configure Active Directory Server and email server settings. Click to switch to the server settings page.
(2)	[Communication Settings]	Set the timeout period, network communication interval, etc. Click to switch to the communication settings page.
(3)	[Other setup]	Set the closing date. Click to switch to the other settings page.

## [Delete the log]

[Details Screen] > [Option] > [Delete the log]

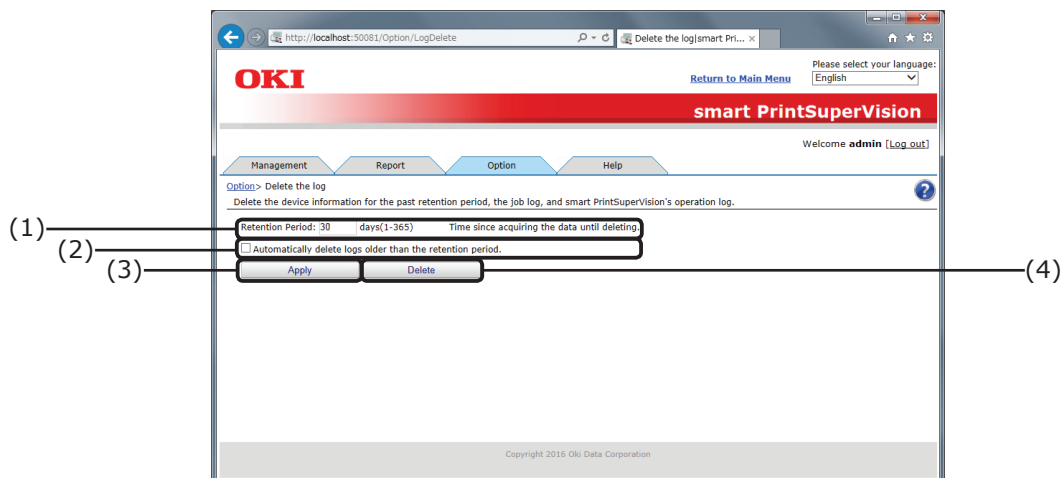
Delete device information whose retention period has expired, print job logs and sPSV operation logs.



No.	Item	Details
(1)	[Retention Period]	Enter/display the log storage period. Default setting: 30 Range: 1 to 365 hours
(2)	[Delete Automatically]	This check box is not checked by default. Off: Logs whose retention period has expired are not automatically deleted. On: Logs whose retention period has expired are automatically deleted.   At 0:00 each day, the logs that exceed the number of days specified in [Retention Period] are deleted.
(3)	[Apply]	Save the configured settings.
(4)	[Delete]	Delete logs whose retention period has expired. A confirmation window appears before deletion.

**[Import/Export]**

[Details Screen] > [Option] > [Import/Export]

Export sPSV database data as a backup, or import an existing database into an sPSV database.



- **Log in as an administrator to configure these settings.**
- **Configure these settings using a computer on which sPSV is installed.**

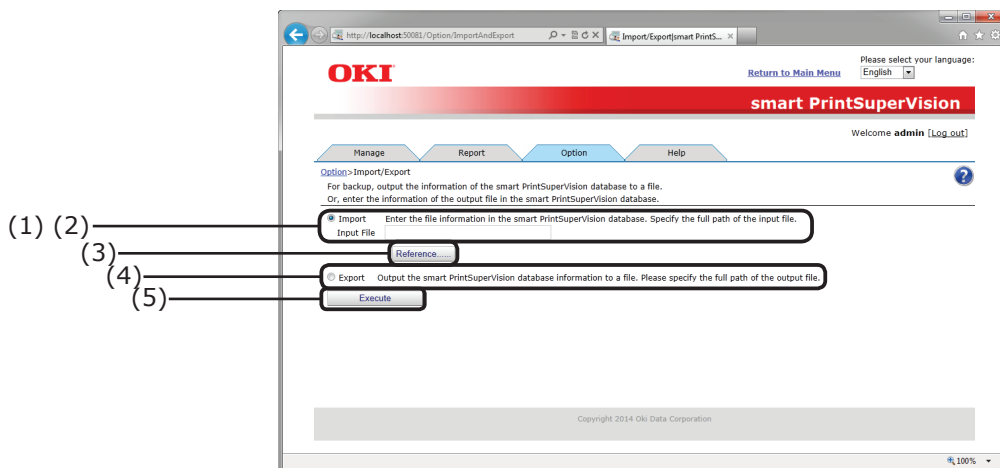

No.	Item	Details
(1)	[Import]	Input an existing database into the sPSV database.
(2)	[File Name]	Display the save destination file name.
(3)	[Reference...]	Specify the save destination file name.
(4)	[Export]	Output the sPSV database data as a backup.
(5)	[Execute]	Perform export or import processing.

## [Database Settings]

[Details Screen] > [Option] > [Database Settings]

Settings for connecting to the database where data will be saved.



**Configure these settings using a computer with sPSV is installed.**

### When [Microsoft SQL Server Compact] is selected

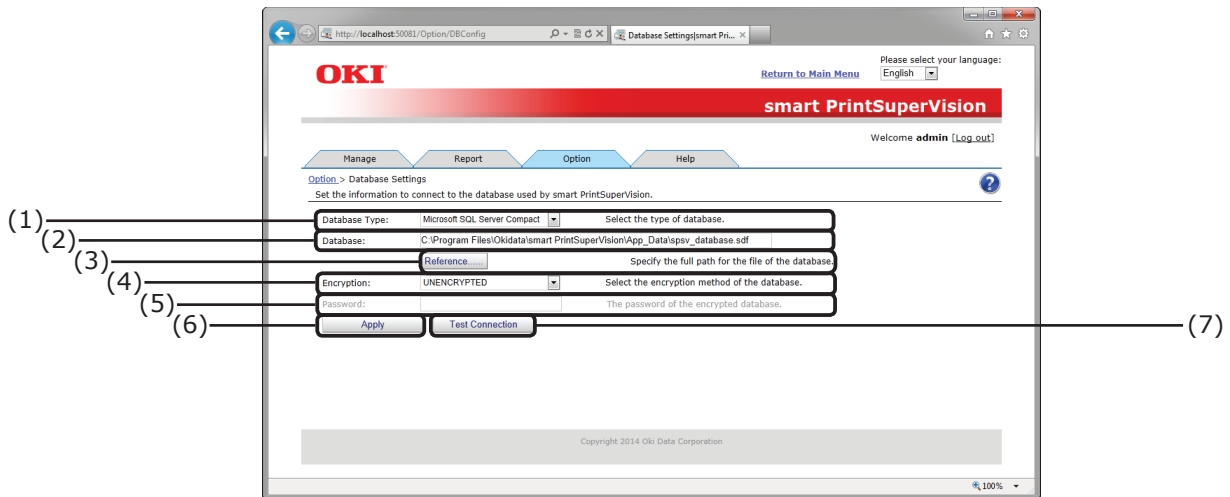

No.	Item	Details
(1)	[Database Type]	The type of database to be connected to is displayed. (Selection: Microsoft SQL Server Compact or Microsoft SQL Server)
(2)	[Database]	The SQL Server Compact database file name (*.sdf).
(3)	[Reference...]	Open the file selection dialog, and when the file is specified the file name is displayed in the [(2) Database] text box.
(4)	[Encryption]	Select the encryption method for the database file. Selection: UNENCRYPTED, Platform Default or Engine Default Default setting: UNENCRYPTED
(5)	[Password]	Password of the encrypted data file. This is not required when [(4) Encryption] is [UNENCRYPTED].
(6)	[Apply]	Click to save the configured details, connect to the specified database and restart sPSV.
(7)	[Test Connection]	Check the database connection using the configured settings.



## When [Microsoft SQL Server] is selected

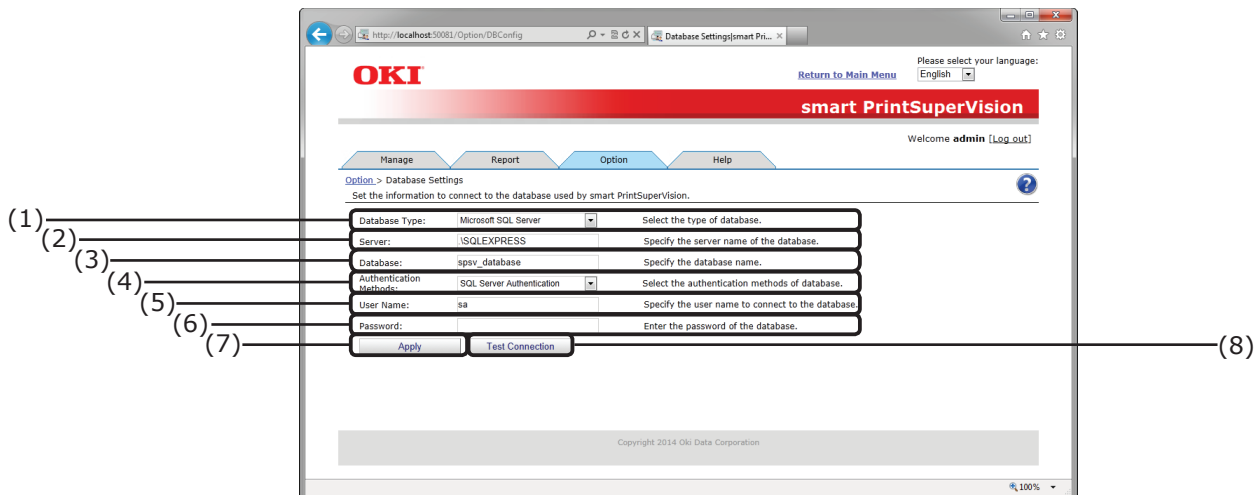

No.	Item	Details
(1)	[Database Type]	The type of database to be connected to is displayed. (Selection: Microsoft SQL Server Compact or Microsoft SQL Server)
(2)	[Server]	Specify the name of the database server to which to connect. Example) localhost\SQLEXPRESS
(3)	[Database]	Name of the database to be used in sPSV
(4)	[Authentication Methods]	Select the authentication methods for database. Selection: Windows Authentication or SQL Server Authentication. Default setting: SQL Server Authentication.
(5)	[User Name]	User name when SQL Server Authentication is used. This cannot be entered when Windows Authentication is selected.
(6)	[Password]	Specify the user password for SQL Server authentication. This cannot be entered when Windows Authentication is selected. The value is masked in the display.
(7)	[Apply]	Click to save the configured details, connect to the specified database and restart sPSV.
(8)	[Test Connection]	Check the database connection using the configured settings.

## [Web Service Setting]

[Details Screen] > [Option] > [Web Service Setting]

Configure settings for displaying sPSV in a web browser.



**Configure these settings using the computer on which sPSV is installed.**

### Web Service Page (EWS)

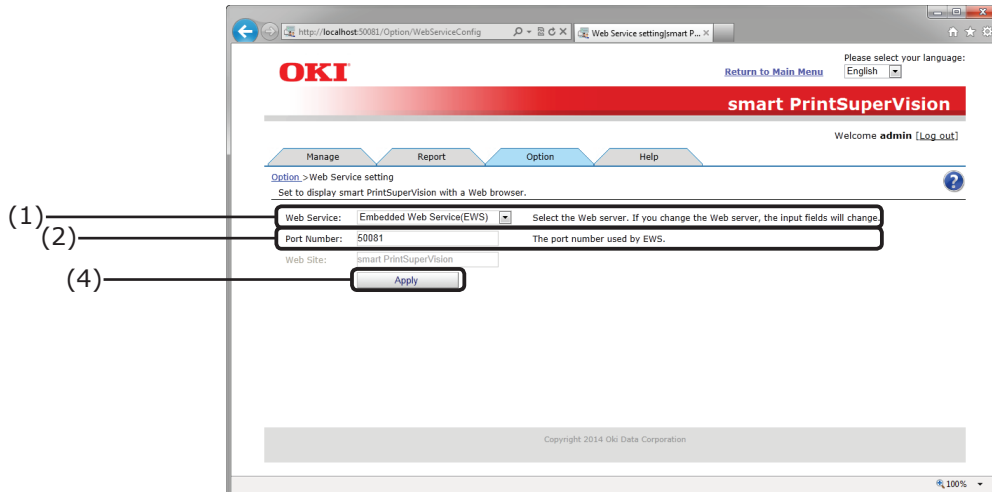

### Web Service Page (IIS)

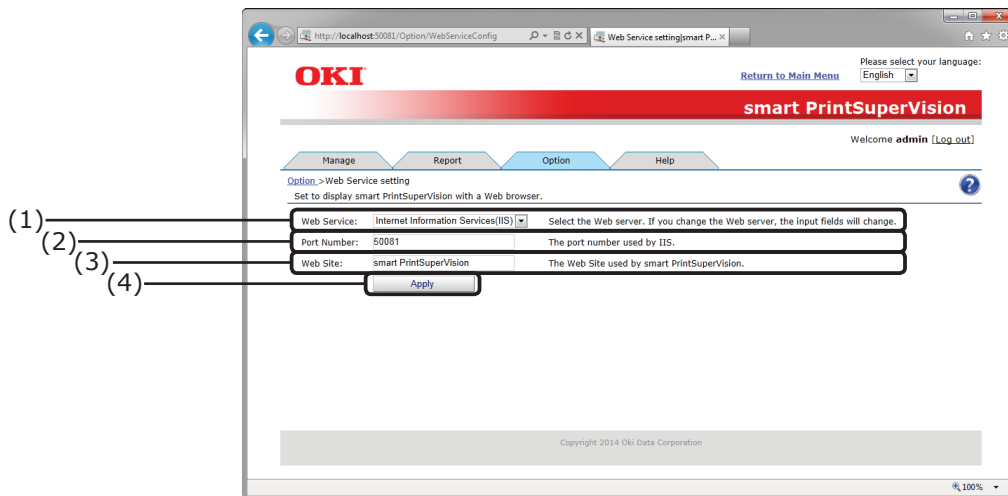

No.	Item	Details
(1)	[Web Service]	Select the web service to be used for releasing sPSV. Selection: Embedded web service (EWS) or Internet Information Services (IIS) Default setting: EWS
(2)	[Port Number]	The port number used by the web service. Default setting: 50081 (range: 1 - 65535)
(3)	[Web Site]	The name of the website being registered to IIS. Default setting: Smart PrintSuperVision Web site used by sPSV. Enabled when [Web Service] is changed to IIS.
(4)	[Apply]	Click to save the configured details and restart sPSV.

## [Help] Tab

[Details Screen] > [Help]

Browse sPSV help information, version information and other related information.

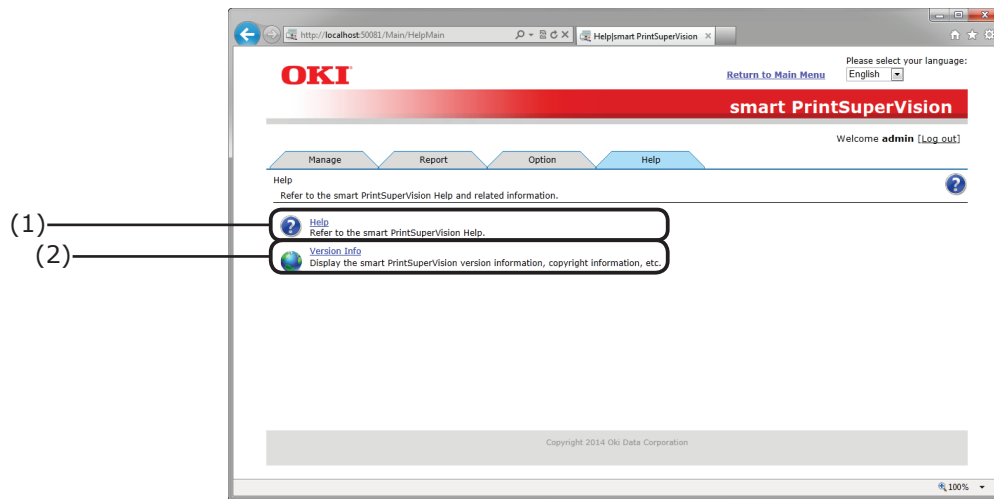

No.	Item	Details
(1)	[Help]	Click to switch to the help page. ⇒ P. 102
(2)	[Version Info]	Click to switch to the version info page. ⇒ P. 104

**[Help]**

[Details Screen] &gt; [Help] &gt; [Help]

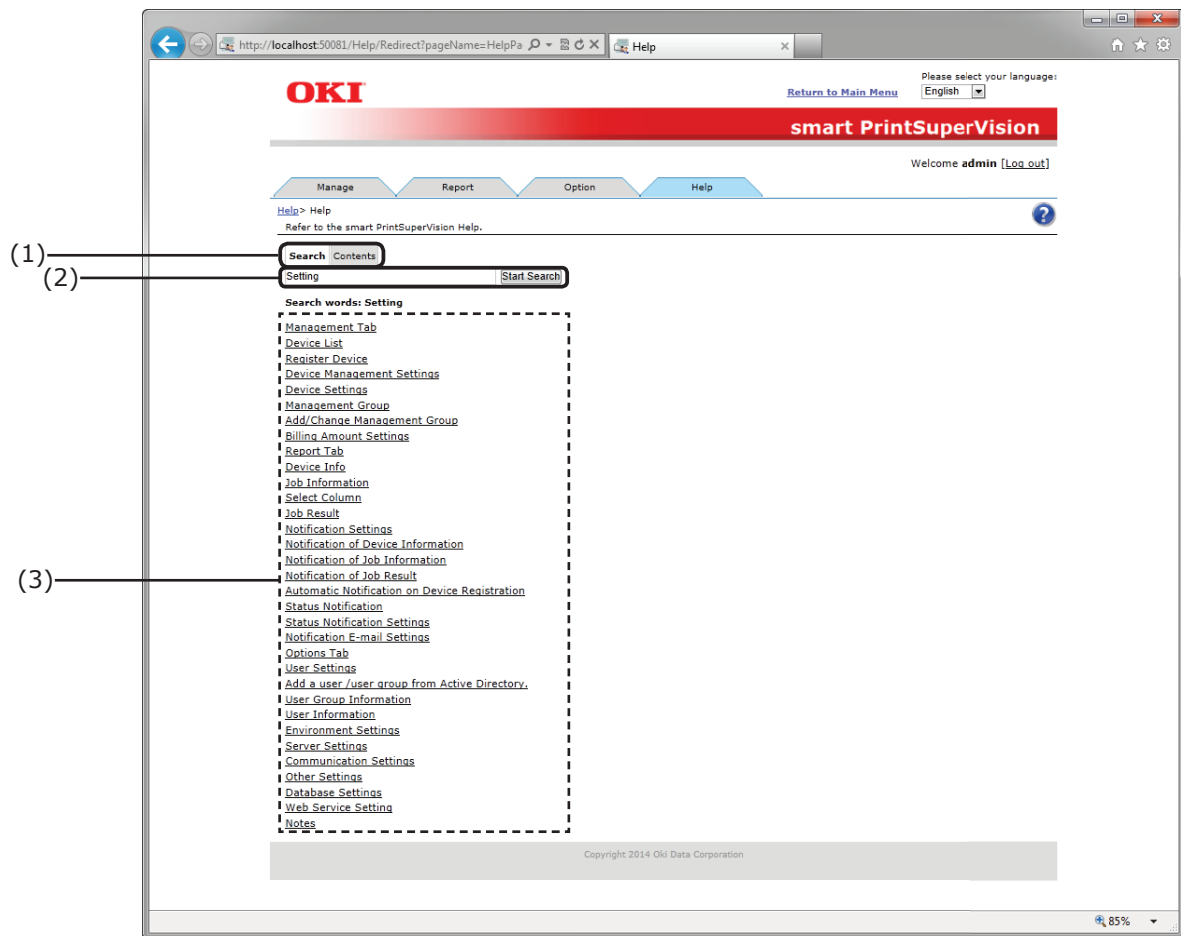
**[Search Window]**

No.	Item	Details
(1)	[Search]/[Contents] Tab	Select whether to display the help contents or display the help search window.
(2)	Keyword input form/ [Start Search] button	Enter the keyword to search for and click [Search].
(3)	[Search Results]	Search results (related topic) are displayed. Click the topic to display the related help topic page in a different window.

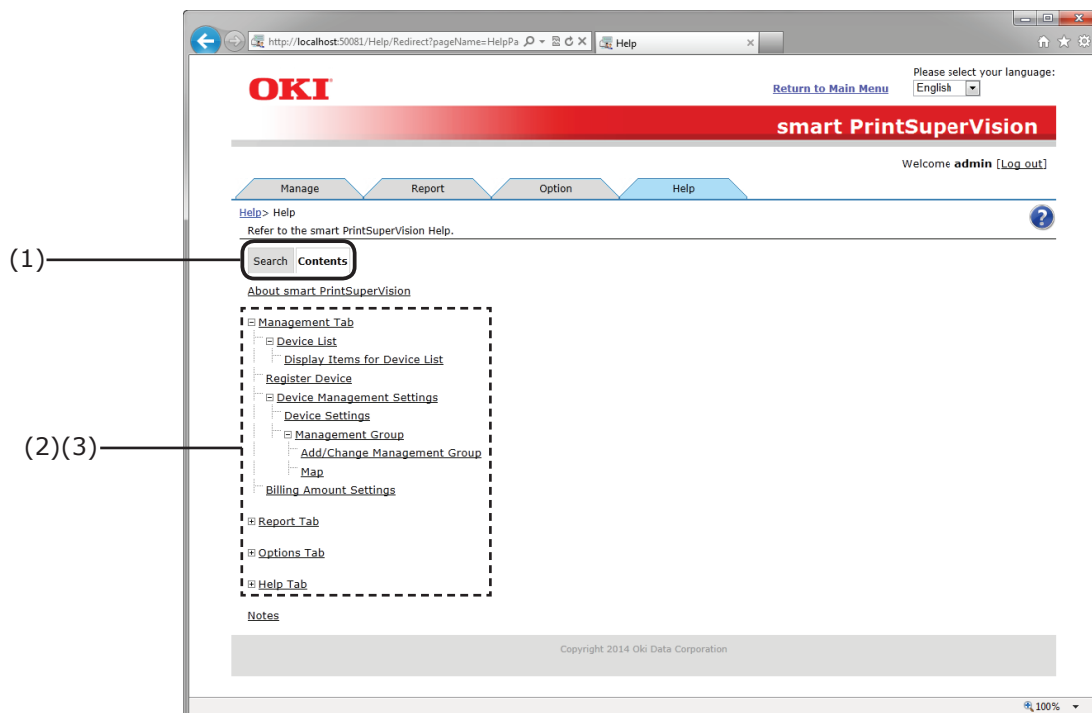
**[Contents Window]**

No.	Item	Details
(1)	[Search]/[Contents] Tab	Select whether to display the help contents or display the help search window.
(2)	Expand/Collapse Item Button	+ button: Click to display the sub-items of the item that corresponds to the selected button. The button display changes to -. - button: Click to hide the displayed sub-items. The button display changes to +.
(3)	Topic	Click the topic to display the related help topic page in a different window.

**[Version Info]**

[Details Screen] &gt; [Help] &gt; [Version Info]

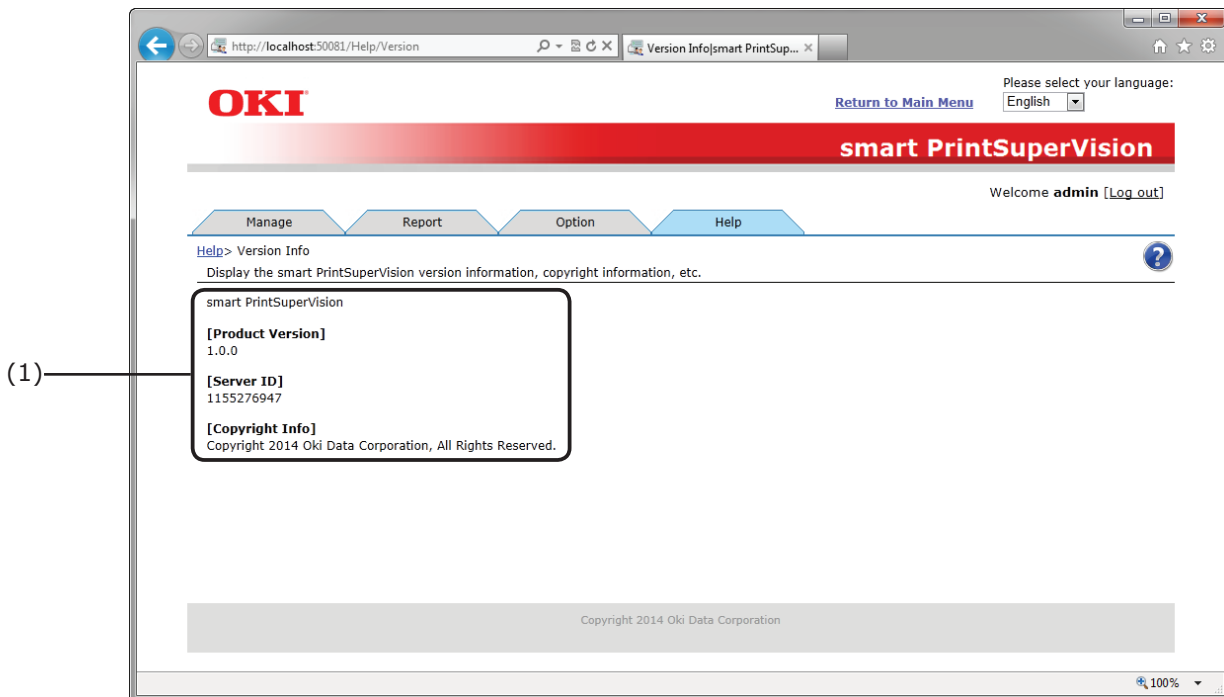

No.	Item	Details
(1)	sPSV Version information	Displays sPSV version information.

## [Help Icon]

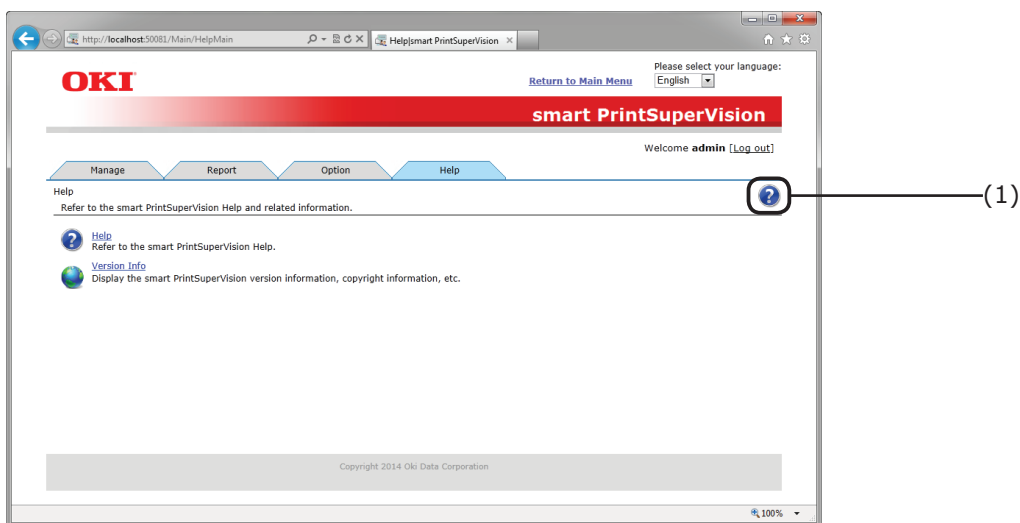

No.	Item	Details
(1)	Help icon	Click to display the help topic page in a different window.

## [Help Topic Page]

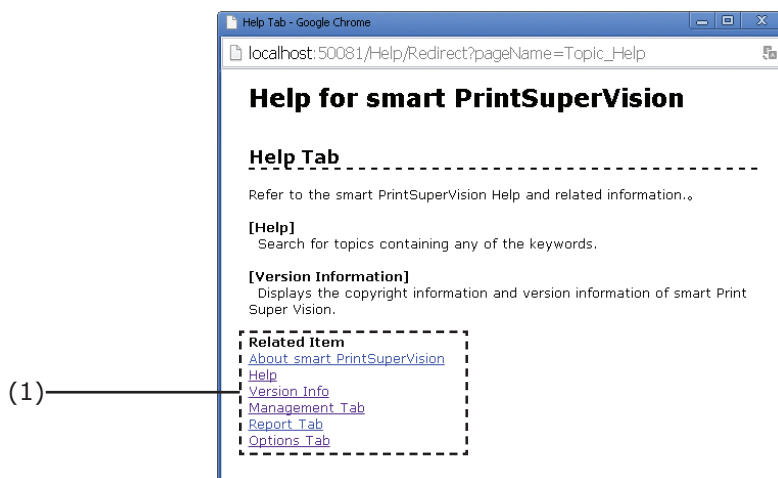

No.	Item	Details
(1)	Related Item	Links to topics related to the currently displayed topic are displayed. Click a link to switch to the related topic page.

# 6. Print Job Accounting Client Software

---

When Using Windows .....	108
Setting the Job Account Mode .....	108
Using Tab Mode.....	109
Using Pop-up Mode.....	109
Using Hide Mode .....	110
Using in Unsupported Mode .....	113
When Using Mac OS X .....	114
Registering the Job Account ID (PIN) .....	114
Registering Multiple Users Together .....	114
Changing a Job Account ID (PIN) or User Name .....	115
Deleting a Job Account ID (PIN) or User Name .....	116
Exporting Data for Client Software.....	116



## 6. Print Job Accounting Client Software

The client software needs to be installed on client computers if identifying users by user ID (PIN). Configure the [Print Policy] settings if identifying users. ⇒ P. 146

By installing the client software on the computers that the users use for their printing (client computers) and setting user IDs (PINs), Usage limitations (print limitations, print volume limitations) for the users can be set and job logs can be collected.

Set the job account modes of the client software and then set user names and user IDs (PINs) to identify printing users in sPSV.

There are four job account modes for setting user names and user IDs.



**The job account mode does not change in Mac OS X. For information on setting user IDs in Mac OS X, see "When Using Mac OS X" (P. 114).**



**Job account mode settings can only be configured with a driver that supports print job accounting.**

### (1) Tab Mode

The tab for setting the user name and user ID to the print driver properties is displayed.

It is used by the users themselves to set or change the user name and user ID.

### (2) Pop-up Mode

A pop-up window for setting the user name and user ID to be sent for each print job is displayed.

It is used when 1 computer is used by multiple users.



- **Do not select this when using the simple user switching function.**
- **Even if printing is performed on the shared printer client side, the input window is not displayed. Use the hide Mode for shared printers.**

### (3) Hide Mode

The screen for setting the user name and user ID is not displayed.

When printing, users are first identified as Windows login users. Their user ID (PIN) is then acquired according to the cross-referencing table set in the client software. A cross-referencing table therefore needs to be set beforehand by the administrator.



**Furthermore, the same user ID can be set for multiple login users. This is used when batch-managing users by department.**

### (4) Unsupported Mode (Default setting)

User identification is not performed, and all jobs are recognized as "unregistered ID". The user name is the user name used to log in to Windows, and the user ID is 0 in the job log. Used when user recognition is not needed.



**When the drivers are updated or reinstalled, the mode returns to unsupported mode. Therefore, the job account mode must be reset. However, it is not necessary to reconfigure the mode settings when a check mark is used to set a function that sets all drivers to the same mode.**

## When Using Windows

### Setting the Job Account Mode

- 1 Select [Start] > [All Programs] > [Oki Data] > [Print Job Accounting Client] > [Change Job Account Mode].

When the [User account management] window is displayed, click [Continue] or [Yes].

- 2 Select the device driver on which to set user names and user IDs from the [Driver] list. To set all of the drivers to the same mode, check [Set all drivers to the same mode].

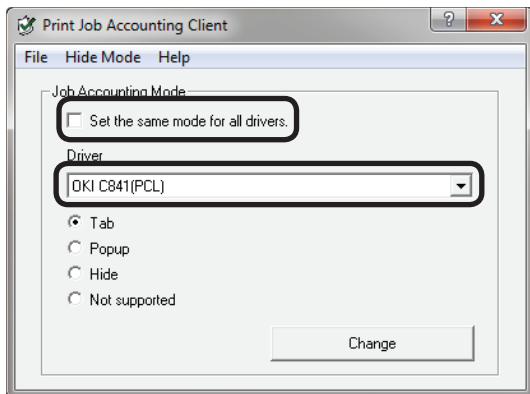

#### ! Note

**If a shared printer is used, do not use the [Set all drivers to the same mode] function. When using a shared printer on the client side to print, the account information is not output.**

- 3 Select the mode you want to set, and click [Change].

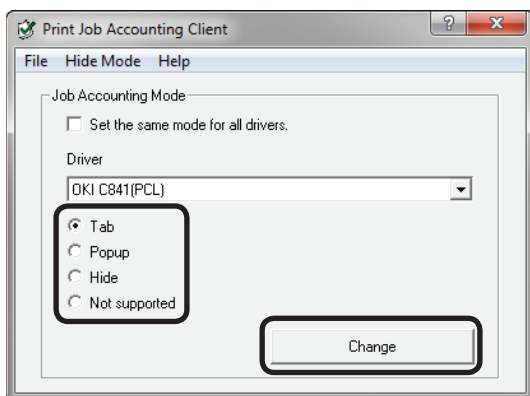

- 4 Click [OK] in the confirmation window.

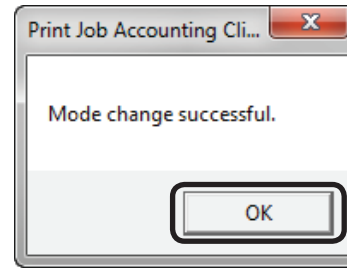

- 5 Select [File] menu > [Close].

If tab mode is set as the job account mode, proceed to "Using Tab Mode" (P. 109) to set the user names and user IDs.

## Using Tab Mode

- 1 Follow the instructions in "Setting the Job Account Mode" (P. 108) to switch to Hide Mode.
- 2 Select [Start] > [Devices and Printers] to display the printer driver icon.
- 3 On the printer driver icon, right-click the mouse button and select [Printer Properties].

 Memo

**Steps 2 and 3 describe the process for displaying the printer properties window in Windows 7. If using a different operating system, see "Basic Procedures in Windows" (P. 253).**

- 4 In the [Job Account] tab, enter the user name and user ID and click [OK].

 Memo

- If tab mode is set, the [Job Account] tab is added as shown in the figure below.
- In the default settings, the user name is the user name used to login to Windows, and the user ID is 1.

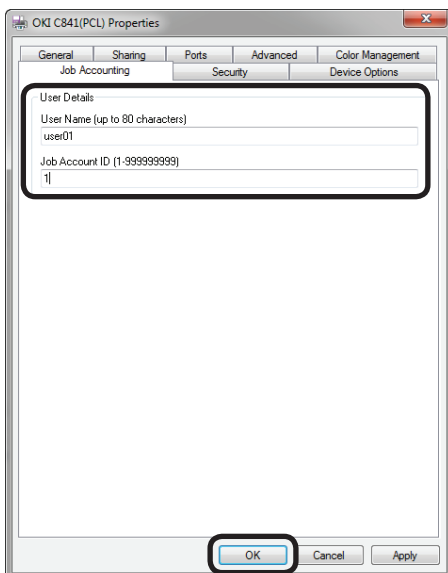

- 5 Print from the application.

## Using Pop-up Mode

- 1 Follow the instructions in "Setting the Job Account Mode" (P. 108) to switch to pop-up mode.
- 2 Print from the application.
- 3 When the Pop-up window is displayed, enter the user name and user ID, and click [OK].

 Memo

**When [Cancel] is clicked, the user name is blank and the user ID is 0 in the log. The print job is not cancelled.**

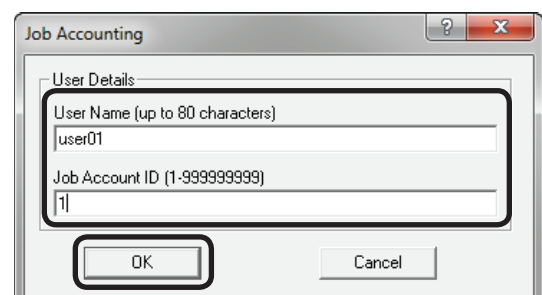

## Using Hide Mode

There are four methods for setting user names and user IDs in Hide Mode.

- (1) Adding items by creating an ID file ⇒ "Switching the User ID for Each User" (P. 110)
- (2) Entering each item manually ⇒ "Displaying and Editing Registered User IDs" (P. 111)
- (3) Adding items by using a file exported from sPSV ⇒ "Acquiring User Information from Files" (P. 112)
- (4) Setting a fixed user ID for all users ⇒ "Setting the Same User ID for All Users" (P. 113)

### Switching the User ID for Each User

- 1 Create an ID file using software such as Notepad, Excel, etc.

#### <For Notepad>

- (1) The login user name and user ID are included for each user individually on a separate line. The login user name, user ID and user name are separated with a comma (,).

#### Login User Name:

User name entered when logging in to Windows

#### User ID:

PIN of user registered in sPSV that corresponds to the user name of the logged in user

#### User Name:

User name recorded in the job log

The user name can be omitted. When it is omitted, the login user name is used as the user name.

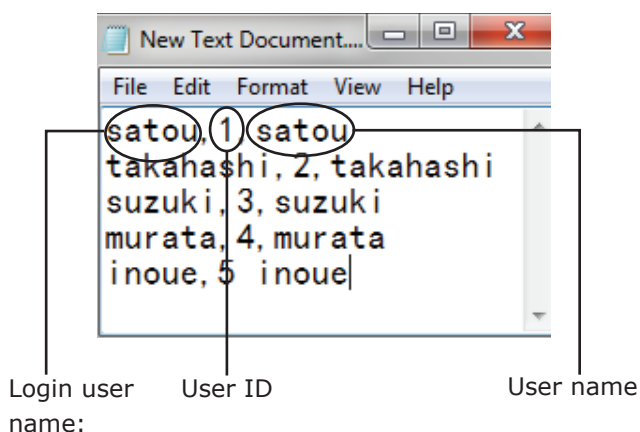

- (2) Save in text format with the extension "CSV".

#### <For Excel>

- (1) The login user name and user ID are included for each user individually on a separate line.

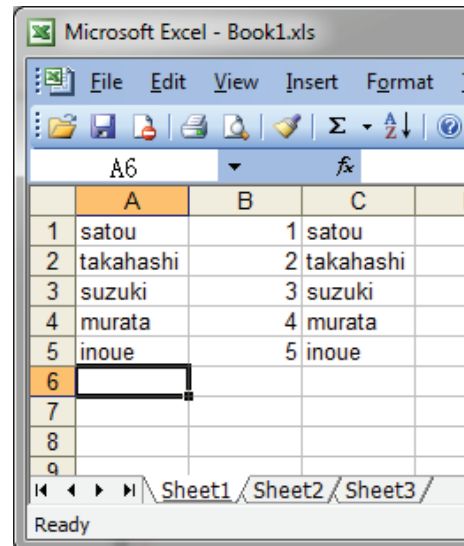

- (2) Save the file in CSV format.

- 2 Follow the instructions in "Setting the Job Account Mode" (P. 108) to switch to hidemode.

- 3 Select [Import ID File] in the [Hide Mode] menu.

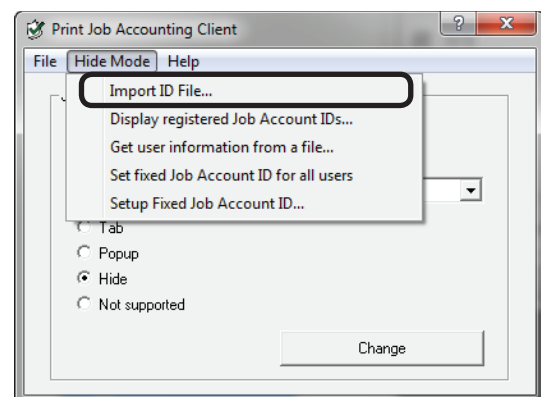

- 4 Specify the ID file created in **1**, and click [Open].

**Note**

- If [Set fixed Job Account ID for all users] is checked in the [Hide Mode] menu, remove the check.
- If [Get user information from a file] is checked in the [Hide Mode] menu, remove the check.

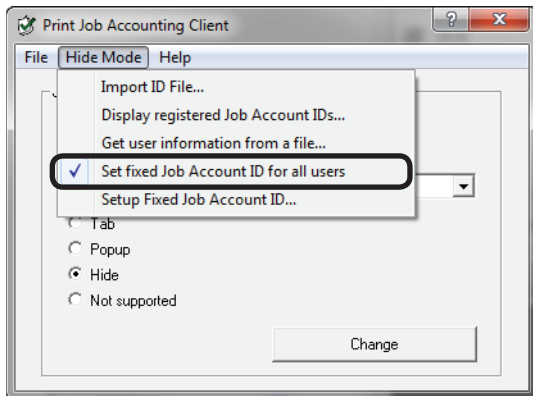

- 5 Select [File] menu > [Close].

- 6 Print from the application.

**Note**

If printing is performed by a user who has logged in to Windows with a login user name that has not been registered by importing an ID file, the user name is the user name of the currently logged in user and the user ID is 0 in the job log.

**Memo**

Select [Display registered Job Account IDs] in the hide Mode menu, and you can authenticate user IDs that have already been registered, delete unneeded user IDs, and import ID files.

## Displaying and Editing Registered User IDs

- 1 Follow the instructions in "Setting the Job Account Mode" (P. 108) to switch to hidden mode.

- 2 Select [Display registered Job Account IDs] in the [Hide Mode] menu.

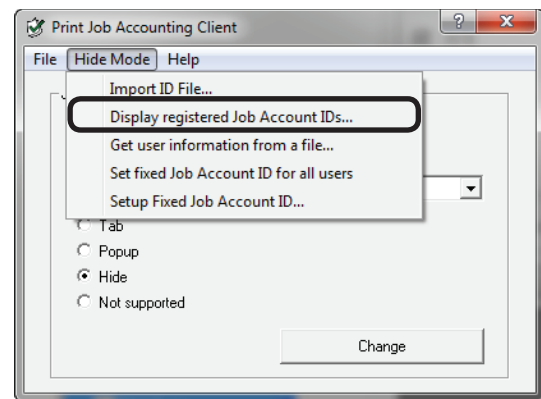

- 3 Information on registered users is displayed.

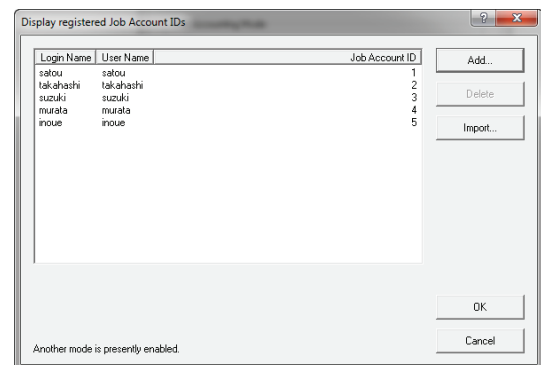

- 4 To add a user ID, click [Add].

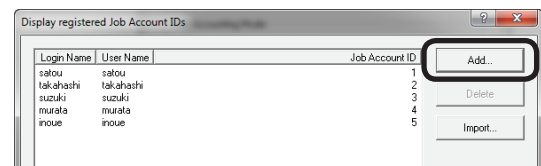

**Memo**

- To add IDs by importing the ID file created in "Switching the User ID for Each User" (P. 110), click [Import] and specify a file in CSV format.

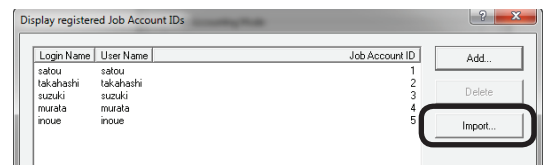

- To delete a registered user, select the user to be deleted and click the [Delete] button.

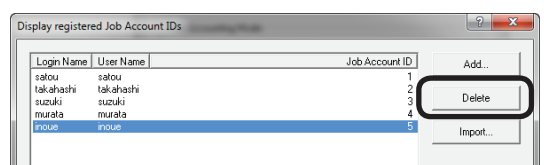

- 5 Enter the login names, user names and user IDs of the user IDs to be added and click [OK].

- 6 Click [OK].

Login Name	User Name	Job Account ID
salou	salou	1
takahashi	takahashi	2
suzuki	suzuki	3
murata	murata	4
inoue	inoue	5
tanaka	tanaka	6

**Note**

If "Another mode is currently enabled." is displayed in the bottom left corner of the window, confirm the following:

- If [Get user information from a file] is checked in [Hide Mode], remove the check.
- If [Set fixed Job Account ID for all users] is checked in [Hide Mode], remove the check.

### Acquiring User Information from Files

User information can be acquired from a specific file. The file created in "Switching the User ID for Each User" (P. 110) can be specified.

- 1 Follow the instructions in "Setting the Job Account Mode" (P. 108) to switch to hidden mode.

- 2 Select [Get user information from a file] in the [Hide Mode] menu.

- 3 Check "Get user information from a file" and click "Change".

- 4 Select the file used to obtain the user information, and click [OK].

- 5 Click [OK].

**Note**

If "Another mode is currently enabled." is displayed in the bottom left corner of the window, check the following:

- If [Set fixed Job Account ID for all users] is checked in the [Hide Mode] menu, remove the check.

## Setting the Same User ID for All Users

- 1 Follow the instructions in "Setting the Job Account Mode" (P. 108) to switch to hidden mode.
- 2 Check [Set fixed Job Account ID for all users] in the [Hide Mode] menu.

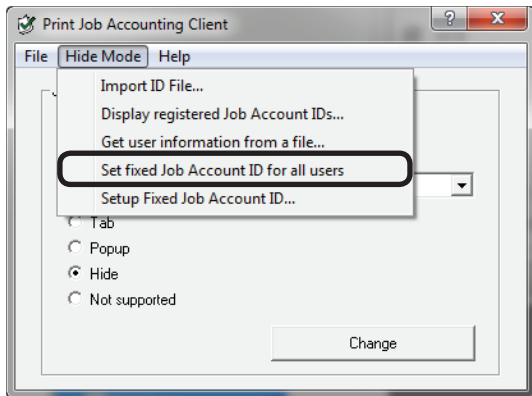

- 3 Select [Setup Fixed Job Account ID] in the [Hide Mode] menu.

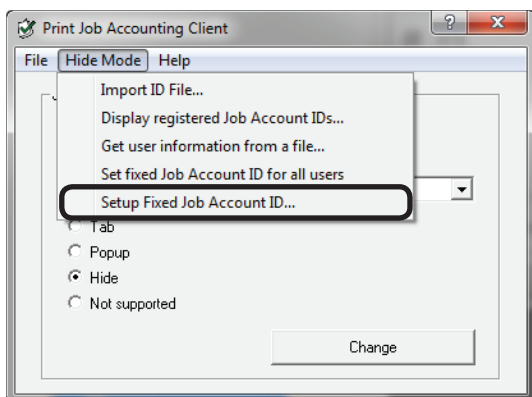

- 4 Enter the user name and user ID, and click [OK].



**When the user name is omitted, the login user name is used as the user name.**

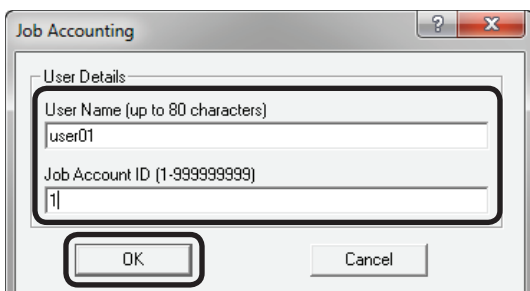

- 5 Select [File] menu > [Close].
- 6 Print from the application.

## Using in Unsupported Mode

- 1 Follow the instructions in "Setting the Job Account Mode" (P. 108) to switch to unsupported mode.

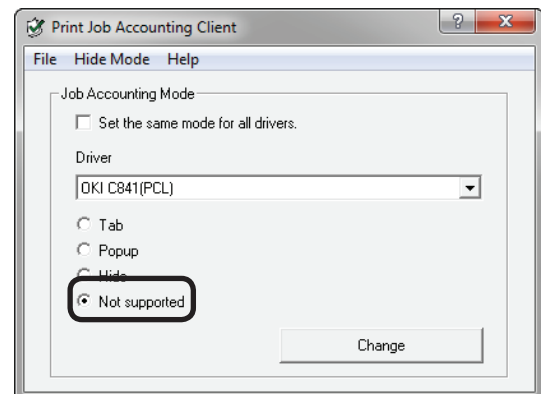

- 2 Print from the application.

## When Using Mac OS X

### Registering the Job Account ID (PIN)

Double click the print job accounting icon.

- 1 Click [New].

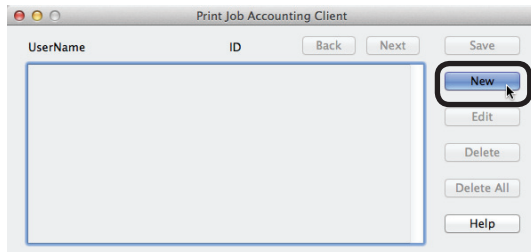

- 2 Enter the Mac OS X login name, user name and job account ID (PIN) to be used in sPSV and click [Save].

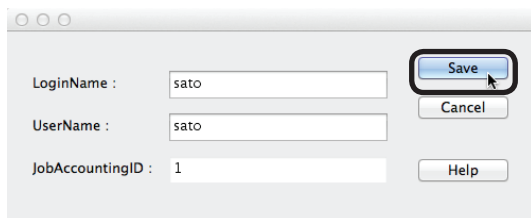

**Repeat this operation to register multiple users.**

- 3 Click [Save].

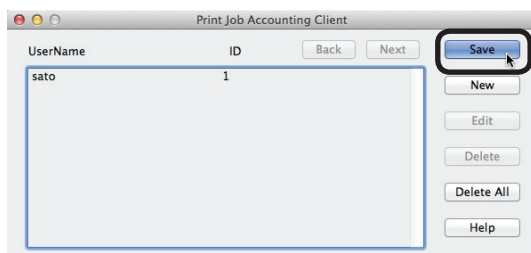

- 4 Enter the Mac OS X password, and click [OK].

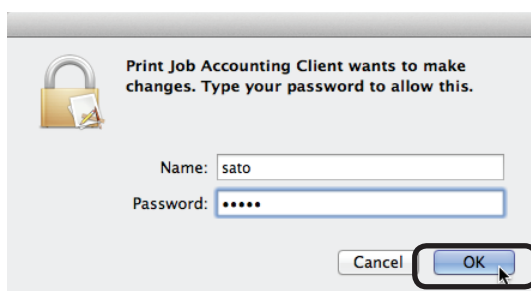

- 5 Quit the client software.

## Registering Multiple Users Together

Multiple job account IDs (PINs) and user names can be registered at once using a CSV file. This is useful when multiple users log in to use the Mac OS X.

- 1 Use commercially available software to prepare a CSV file.

In the CSV file, enter the Mac OS X login name, job account ID (PIN) and user name in this order.

- (1) The Mac OS X login name, job account ID (PIN) and user name are included for each user individually on a separate line.

	A	B	C
1	satou		1 satou
2	takahashi		2 takahashi
3	suzuki		3 suzuki
4	murata		4 murata
5	inoue		5 inoue
6			
7			
8			
9			
10			



**Enter the job account ID (PIN) in one-byte characters.**

- (2) Save the file in CSV format.

- 2 Use the client software to register.

- (1) Double click the print job accounting icon.
- (2) Select Import from the file menu.
- (3) Import the CSV file created in **1**.

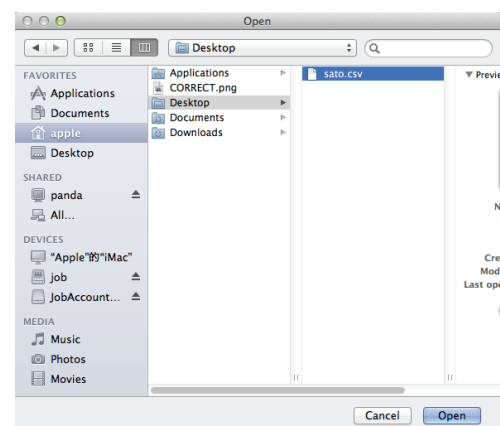



(4) Click [Save].

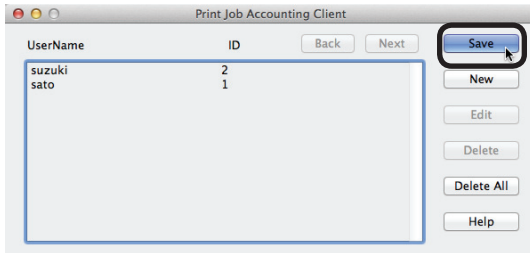

(5) Enter the password, and click [OK].

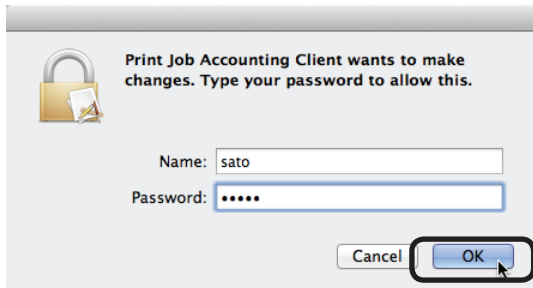

(6) Quit the client software.

## Changing a Job Account ID (PIN) or User Name

The client software can be used to change user IDs and user names that have already been registered.

- 1 Double click the print job accounting icon.
- 2 Select the user that you want to change, and click [Edit].
- 3 Enter the new job account ID (PIN) and user name, and click [OK].
- 4 Click [Save].

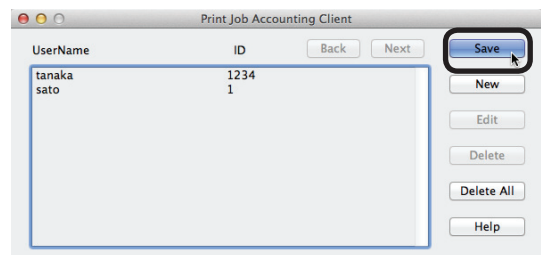

- 5 Enter the Mac OS X password, and click [OK].

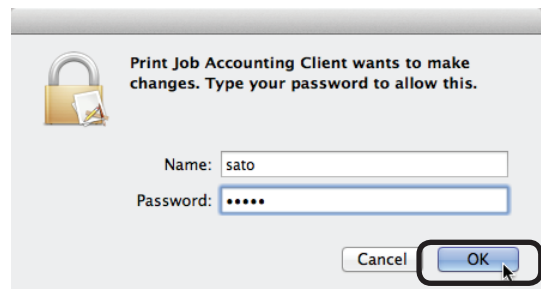

- 6 Quit the client software.

## Deleting a Job Account ID (PIN) or User Name

- 1 Double click Print Job Accounting.
- 2 Select the user that you want to delete, and click [Delete].

 Memo

To delete all registered users, click [Delete All].

- 3 Click [Save].

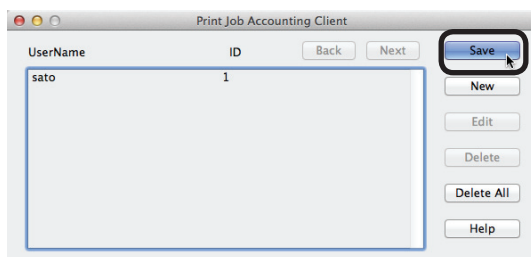

- 4 Enter the Mac OS X password, and click [OK].

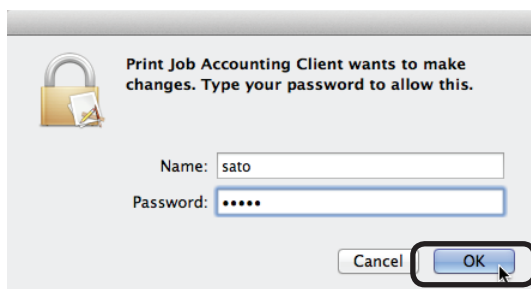

- 5 Quit the client software.

## Exporting Data for Client Software

Can be used in the hide Mode of the client software. For details on the client software hidden mode, see "Setting the Job Account Mode" (P. 108).

- 1 Configure the output settings of the user handling table in [Function Detail Window] > [Option] > [User Settings].

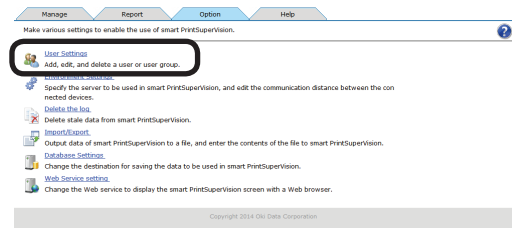

- 2 Click [Create a user correspondence table.].

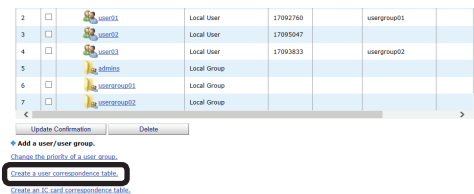

- 3 Check [Create a user correspondence table.] and click [Reference...].

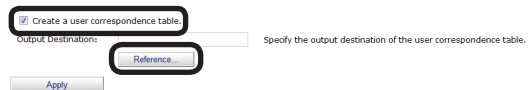

- 4 Select the folder that you want to save, and click [Apply].

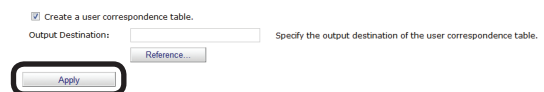

# 7. Registering and Managing Devices

---

Registering Devices .....	118
Start sPSV.....	118
Registering Devices .....	119
Configure the Settings of the Registered Devices.....	121
Management Group Registration .....	125
Changing Settings for Management Groups .....	126
Deleting Management Groups .....	128

# 7. Registering and Managing Devices

## Registering Devices



**Log in as an sPSV administrator to register devices. You can only browse device information if you are logged in as a standard sPSV user.**

### Start sPSV

- 1 Check that the power of the device is turned on.
- 2 Double click the sPSV shortcut on the desktop or select [Start] > [All Programs] > [Oki Data] > [smart PrintSuperVision] > [smart PrintSuperVision].
- 3 The web browser launches and accesses the sPSV website.



- **The sPSV service is registered as a Windows service. If the sPSV service does not start automatically, open the [Control Panel] > [System and Security] > [Administrative Tools] > [Service], check the startup type for [Oki sPSVService] and change it to automatic startup.**
- **To access sPSV from a client computer, see "Accessing sPSV from the Client PC" (P. 49).**

- 4 Click [Login].

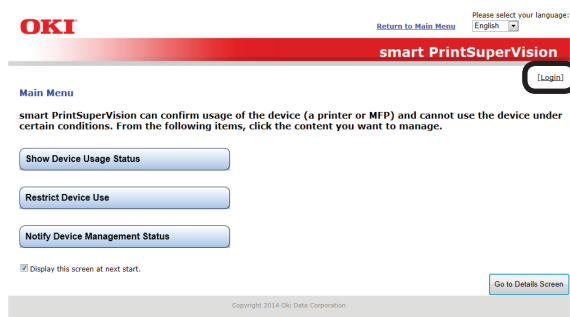

- 5 Enter the user name and password of an sPSV user with administrator authority and click [Login].

The following user is set for the administrator.  
[User Name]: admin  
[Password]: password



**The default password can be changed. To change the password, see "Changing User/ User Group Information" (P. 135).**

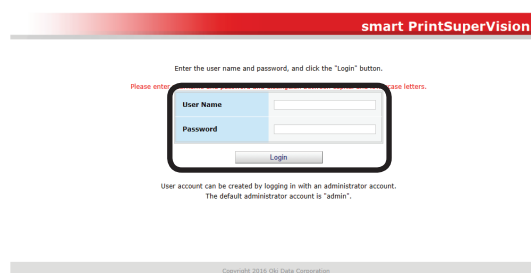

Next, proceed to "Registering Devices" (P. 119).

## Registering Devices

- 1 Register a device in [Function Details] > [Manage] > [Register Device].

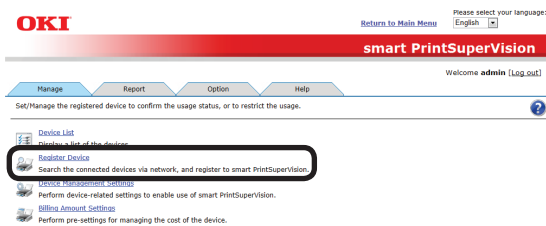

- 2 Specify a connection destination for the device you are searching for and click [Specify Search Range].

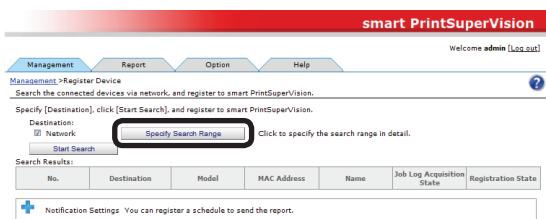

- 3 Select the search method.

### <Searching by [Network Search Range]>

- (1) Add search ranges for the network search in the entry field (up to 200 can be added).



Either broadcast IP addresses (e.g. 255.255.255.255) or a unicast IP addresses can be added.

- (2) Click [Add].

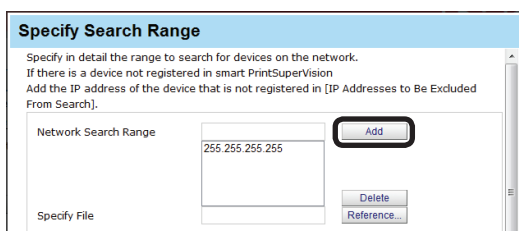

### <Adding Printers from a CSV file>

- (1) Create a CSV file using software such as Notepad, Excel, etc.

#### <For Notepad>

- (1) Write the IP address of each printer on one line for each printer.

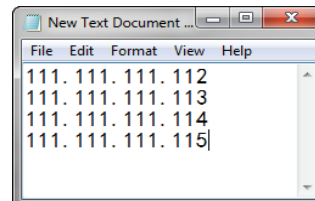

- (2) Save in text format with the extension "CSV".

#### <For Excel>

- (1) Write the IP address of each printer on one line for each printer.

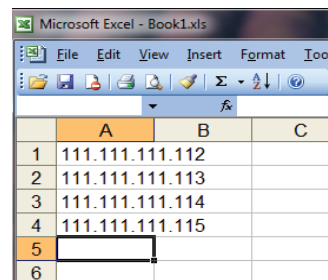

- (2) Save the file in CSV format.

- (2) Click [Reference...] in [Specify File].

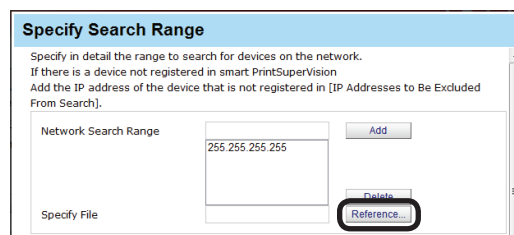

- (3) Specify the CSV file created in ( 1 ), and click [Open].

### <Adding [IP Addresses to Be Excluded From Search]>

- (1) Add IP addresses to be omitted from the network search for devices in the entry field (up to 200 can be added).



Only unicast IP addresses can be added.

(2) Click [Add].

### <Searching by [SNMP Community Name]>

- (1) Enter community names for SNMP communication in the entry field (range of characters that can be entered: ASCII code, 0x20 - 0x7E, up to 128 characters per item, up to 200 items).
- (2) Check [Use "public" as the community name.] to execute communication with "public" as the community name (This is checked by default).



The network is searched for the community names added in this window. (For example, if "public" and "private" are registered as communities and "10.49.132.255" is specified as the search range, "10.49.132.255" is searched for "public" and "private" respectively.)

(3) Click [Add].

4 Click [OK] and close the [Specify Search Range] window.

5 Click [Start Search].

6 A list of detected devices is displayed in [Search Results]. [Newly Registered] is displayed as the [Registration State] of devices automatically registered in sPSV.



If there are devices that you do not want to register, these devices need to be omitted by adding their IP addresses to [IP addresses to be omitted].

No.	Destination	Model	MAC Address	Name	Job Log Acquisition State	Registration State
1	10.0.0.1	CP11	00 00 00 00 01	3F Printer	Not acquired	Newly Registered
2	111.111.111.112	CP11	00 00 00 00 02	3F Printer	Not acquired	Newly Registered
3	111.111.111.113	MC362	00 00 00 00 03	3F MFP	Acquired by Other Software	Newly Registered
4	111.111.111.114	BS40	00 00 00 00 04		Acquired	Registered
5	111.111.111.115	BS40	00 00 00 00 05		Acquired by Other Software	Newly Registered
6	111.111.111.116	MC362	00 00 00 00 06	3F Printer	Acquired	Registered

Next, proceed to "Configure the Settings of the Registered Devices" (P. 121).

## Configure the Settings of the Registered Devices

### Set the device information

- 1 Set the device information in [Function Details] > [Manage] > [Device Management Settings] > [Device Settings].

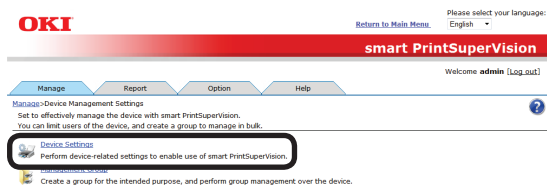

- 2 Select a registered device from [Device].

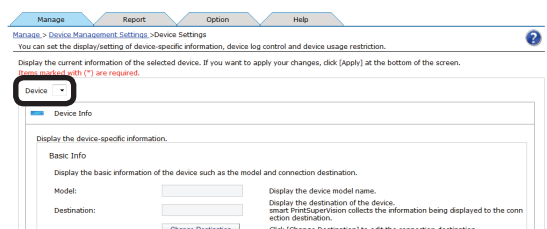

- 3 Check the device information and configure the settings. The set information is reflected in the content displayed in the [Device List].

The items below marked with (\*) cannot be edited.

### [Basic Info]

Basic Info	
Display the basic information of the device such as the model and connection destination.	
Model:	<input type="text"/> Display the device model name.
Destination:	<input type="text"/> Display the destination of the device. smart PrintSuperVision collects the information being displayed to the connection destination. <input type="button" value="Change Destination"/> Click [Change Destination] to edit the connection destination.
Manufacturer:	<input type="text"/> Indicate the device manufacturer.
MAC Address:	<input type="text"/> Display the MAC address of the device.
Serial No.:	<input type="text"/> Display the serial No. of the device.

### [Model](\*)

The model name of the device is displayed.

### [Destination]

The connection destination of the device is displayed. Click [Change Destination] to change the connection destination.

### [Manufacturer](\*)

The manufacturer of the device is displayed.

### [MAC Address](\*)

The MAC address of the device is displayed.

### [Serial No.](\*)

The serial number of the device is displayed.

### [Installation Info]



**SNMPv1 Set needs to be enabled in the SNMP settings of the device before setting the installation information.**

Installation Info	
Display the contacts of the system administrator, the location of the device, etc.	
Name:	<input type="text"/> Indicate the name that will be used to distinguish the device.
Installation Location:	<input type="text"/> Indicate where the device is installed.
Contact:	<input type="text"/> Display the contacts of the device administrator.
Management Number:	<input type="text"/> Indicate management number of the device.

### [Name]

Set the name of the device. (up to 31 1-byte alphanumeric characters)

### [Installation Location]

Set the installation location of the device. (up to 255 1-byte alphanumeric characters)

### [Contact]

Set contact details for the device. (up to 255 1-byte alphanumeric characters)

### [Management Number]

Set the control number of the device. (up to 32 1-byte alphanumeric characters)

### [Version Info]

Version Info	
Display the firmware version of the device.	
CU Version:	<input type="text"/> Indicate the CU firmware version.
PU Version:	<input type="text"/> Indicate the PU firmware version.
Scanner Version:	<input type="text"/> Indicate the Scanner firmware version.
NIC Program Version:	<input type="text"/> Indicate the Network firmware version.

### [CU Version](\*)

The CU version of the device is displayed.

### [PU Version](\*)

The PU version of the device is displayed.

### [Scanner Version](\*)

The scanner version of the device is displayed.

### [NIC Program Version](\*)

The NIC program version of the device is displayed.

### [Management Information]

Management Information	
Display the device information under control of smart PrintSuperVision.	
Fees:	<input type="text"/> C931C941 Indicate the cost information for displaying job information in [Billing Amount]. To add new cost information, [Billing Amount Settings] can be used to add. Indicate the job log acquisition state of the device.
Job Log Acquisition State:	<input type="text"/>
Assigned Group:	<input type="text"/> None Display the management group to which the device is assigned. You can add/change a group in [Management Group].

**[Fees]**

Specify the fee registered in sPSV. Click [Billing Amount Settings] to create a new definition. For information on how to configure the settings, see “Changing Fee Charge Definitions” (P. 177).

**[Job Log Acquisition Status](\*)**

The job log acquisition status of the device is displayed.

**[Assigned Group](\*)**

The management groups to which the device belongs are displayed. Click [Management Group] to register a management group. For information on how to configure the settings, see “Management Group Registration” (P. 125).

**[Communication Info]**

Communication Info	
Display the device-specific information for smart PrintSuperVision to communicate with the device.	
Device Password(*):	Display the password of the device administrator.
<input checked="" type="checkbox"/> Apply the management group password.	
SNMP Read Community Name(*): public	Display the SNMP Read community name of the device.
SNMP Write Community Name(*): private	Display the SNMP Write community name of the device.

**[Device Password]**

Enter an administrator password for the device (6-12 1-byte alphanumeric characters).

**[Apply the management group password]**

When the Management Group settings have been changed, select the password to use when communicating with the device.

When this is checked, the [Device Password] specified in Management group is used.

When this is unchecked, the [Device Password] specified on the device is used.

**[SNMP Read Community Name]**

Enter the SNMP read community name of the device (default: “public”) (ASCII code, 0x20 - 0x7E, up to 128 characters)

**[SNMP Write Community Name]**

Enter the SNMP write community name of the device (default: Differs depending on the model.) (ASCII code, 0x20 - 0x7E, up to 128 characters)

**[SNMP Trap Port Number]**

Enter the SNMP Trap port number of the device. (default: “162”) (1-65535 in single byte numbers)



**Depending on the device, this may not be displayed.**

**4 Click [Apply].**

The screenshot shows the 'Device Management Settings' page with the 'Apply' button highlighted. The page title is 'Manage > Device Management Settings > Device Settings'. Below the title, there is a section for 'Device' with a dropdown menu and a '+' icon. The 'Apply' button is located at the bottom of the page.

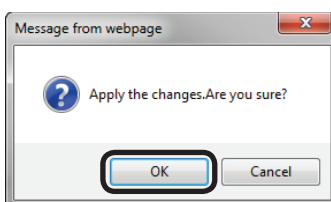
**5 Click [OK] in the confirmation window.****Configuring the Job Log Acquisition Settings**

Job logs are stored in the devices temporarily and acquired from devices according to a schedule set in sPSV. For details on job logs, see “12. Managing Job Logs” (P. 192).

**1 Set the job log acquisition information in [Function Details] > [Manage] > [Device Management Settings] > [Device Settings].**

The screenshot shows the 'smart PrintSuperVision' web interface. The 'Device Settings' link is circled in red. The page title is 'Manage > Device Management Settings > Device Settings'. Below the title, there is a section for 'Device' with a dropdown menu and a '+' icon.

**2 Select the device from which to acquire the job log in [Device].**

The screenshot shows the 'Device Management Settings' page with the 'Device' dropdown menu open. The 'Device Info' option is selected and circled in red.

**3 Click + in [Log/Access Control] to open the settings window.**

The screenshot shows the 'Communication Info' section with the '+' icon next to 'Log/Access Control' circled in red.



#### 4 Configure the settings of the device.

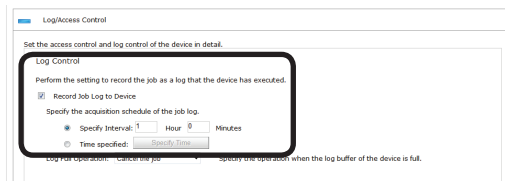

#### [Record Job Log to Device]

Check this and click [Apply] for the device to start recording the log. Remove the check and click [Apply] for the device to stop recording the log.

#### [Job Log Acquisition Schedule Settings]

Set the schedule by which the job log is acquired. This is enabled when [Record Job Log to Device] is checked.

#### [Specify Time]

Acquired for each set interval. The maximum interval time that can be set is 24 hours. The default setting is set as an optimized value detected from the state of the added device. If the interval is set to a time that is longer than the default settings, some of the job logs may not be acquired.

#### [Time specified]

Set the specific time. Click [Specify Time] and add the time. Up to 24 acquisition times can be added. After adding, click [OK].

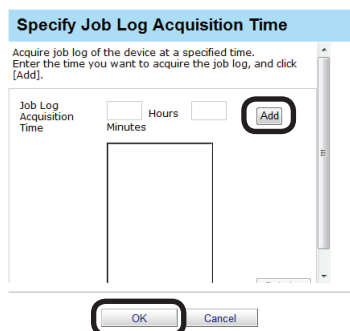

**Always set a time when the computer where the sPSV is set up and device are both switched ON.**  
**The job log is not acquired if the power is not ON.**  
**If the device is printing or an error is occurring, the job log is not acquired.**

#### 5 Click [Apply].

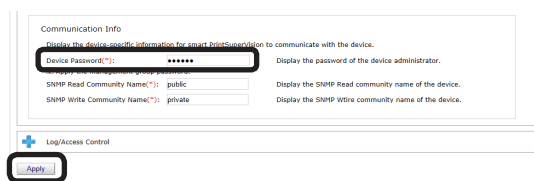

When the "Enter an administrator password for the device" window is displayed, open the [Device Info] input window, enter the administrator password for the device and click [Apply].



- Depending on the device, this may not be displayed.
- For details on the device's factory set administrator password, see the User's Manual of the device.
- If the device server ID is already set from a different server, a confirmation dialog box is displayed.
- To change the setting, enter the Server ID.

#### 6 Click [OK] in the confirmation window.

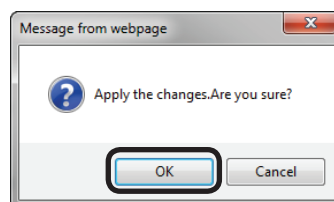

### Set Access Controls

Check this check box when you want to activate access control for multifunction printers that have an access control function on the control panel.



**Users cannot be registered when the access control is disabled.**

- 1 Set the job log acquisition information in [Function Details] > [Manage] > [Device Management Settings] > [Device Settings].

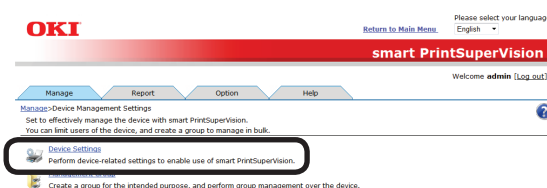

- 2 Select the device from which to acquire the job log in [Device].

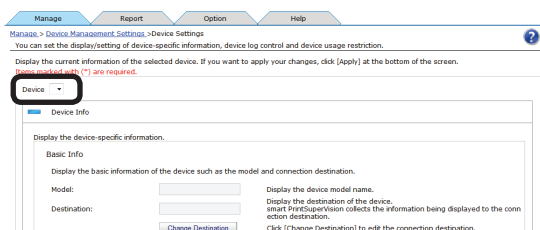

- 3 Click **+** in [Log/Access Control] to open the settings window.

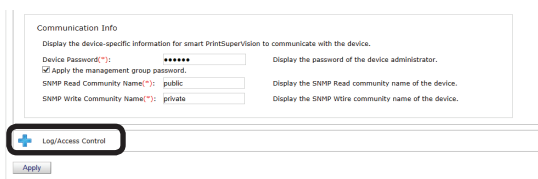

- 4 Check [Enable access control.] in [Access Control], and specify [Panel Access Control] and [User Auth. Method].

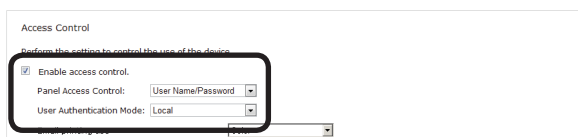

### [Panel access control]

#### [User Name/Password]

A user name and password are entered when logging in from the panel of the device.

#### [PIN]

A PIN ID is entered when logging in from the panel of the device.

#### [Do not specify]

The default method of the device is used when logging in from the panel of the device.

#### [Invalidity]

It is possible to disable the panel access control of the device and use the print restriction function.

### [User Auth. Method]

#### [User Name/Password]

This is enabled if [User Name/Password] is set in [Panel access control]. Specify a method from [Local], [LDAP] and [Secure Protocol].

### [Email printing use]

Sets the email print restrictions.

#### [Color]

Allows color and monochrome printing.

#### [Mono]

Prohibits color printing, prints in monochrome.

#### [Invalidity]

Prohibits color and monochrome printing.

### [Google Cloud Print use]

Sets restrictions for printing with Google Cloud Print.

#### [Color]

Allows color and monochrome printing.

#### [Mono]

Prohibits color printing, prints in monochrome.

#### [Invalidity]

Prohibits color and monochrome printing.

### [Guest use]

Enables/disables guest user settings. Check to enable [Guest authority settings] and specify usable functions.

### [Specify schedule to acquire device use restrictions.]

Set the schedule to which usage restrictions registered in the device are acquired. When updates are detected, information in this software is updated with settings from the device.

Enabled when [Enable access control] is checked.

#### [Specify Interval]

Acquired for each set interval. The maximum interval time that can be set is 24 hours.

#### [Time specified]

Set the specific time. Click [Specify Time] and add the time. Up to 24 acquisition times can be added. After adding, click [OK].

**Note**

- Displayed items differ depending on the device.
- The settings in [Panel Access Control] cannot be changed while the device is acquiring the job log.

5 Click [Apply].

When the "Enter an administrator password for the device" window is displayed, open the [Device Info] input window, enter the administrator password for the device and click [Apply].

**Note**

- Depending on the device, this may not be displayed.
- For details on the device's factory set administrator password, see the User's Manual of the device.

6 Click [OK] in the confirmation window.

To manage multiple device groups, proceed to "Management Group Registration" (P. 125).

## Management Group Registration

Multiple devices can be managed as one group. When managed as a group, the log can be displayed in group units. Furthermore, the user available usage can be set to all of the devices that belong to the group.

- 1 Register a group in [Function Details] > [Manage] > [Device Management Settings] > [Management Group].

- 2 Click [Add].

No.	Group Name	Map	Description
1	group01		
2	group02		

- 3 Enter the management group information in the entry field.

(\* ) denotes a required item.

**[Name](\*)**

Enter the management group name.

**[Description]**

A description of the management group can be entered.

**[Map]**

You can visually grasp the setting position by placing the device in the specified image file. For information on how to configure the map settings, see "Registering the Installation Position of Devices Belonging to a Management Group" (P. 223).

**[Device Password](\*)**

Enter an administrator password for the device (6-12 1-byte alphanumeric characters).

**[SNMP Read Community Name](\*)**

Enter the SNMP read community name of the device (default: "public") (ASCII code, 0x20 - 0x7E, up to 128 characters)

**[SNMP Write Community Name](\*)**

Enter the SNMP write community name of the device (default: "public") (ASCII code, 0x20 - 0x7E, up to 128 characters)

**[SNMP Trap Port Number]**

Enter the SNMP Trap port number of the device. (default: "162") (1-65535 in single byte numbers)  
This setting is applied to all devices in the management group on which the [SNMP Trap Port Number] is enabled.

- 4 Click [Add a device to the management group.].

The screenshot shows a configuration page with various fields: Map, Fees (CR9HC941), Device Password, SNMP Read Community Name (public), SNMP Write Community Name (public), and SNMP Trap Port Number (162). A red circle highlights the 'Add a device to the management group.' button at the bottom left.

- 5 Select the device to add to the group from [Device List], click  and switch to [Assigned Device List].

The dialog box has two lists: 'Device List' with one entry '(192.168.0.210)' and an empty 'Assigned Device List'. A red circle highlights the right arrow button between the lists. Below the lists are 'OK' and 'Cancel' buttons.



- Click  to switch from [Assigned Device List] to [Device List].

- 6 Click [OK] to register the device to the group.



**When available usage is set for users or user groups that are registered to management groups, the available usage is enabled for the total amount of usage for users and user groups of all devices that belong to the management group.**

**However, the amount of usage for users who do not have "Include the total usage of the assigned user group." checked is not included.**

- 7 Click [Apply].

The screenshot shows the configuration page with the 'Apply' button at the bottom left circled in red. The page includes fields for Device Password, SNMP Read Community Name, SNMP Write Community Name, and SNMP Trap Port Number.

- 8 Click [OK] in the confirmation window.

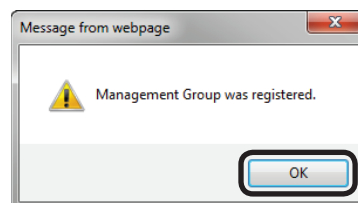

# Changing Settings for Management Groups

The device can be changed to a different group. This is useful for when the device is relocated to a different department.

- 1 Change the group in [Function Details] > [Manage] > [Device Management Settings] > [Management Group].

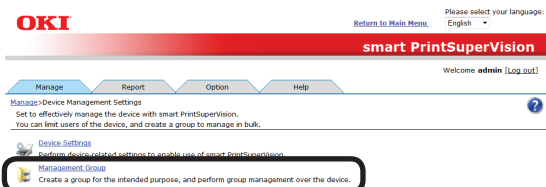

- 2 Click the current group.

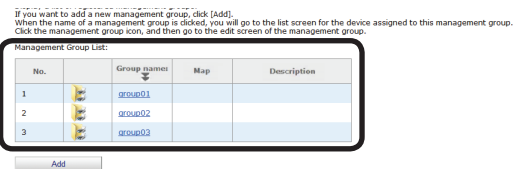

- 3 Click [Add a device to the management group.].

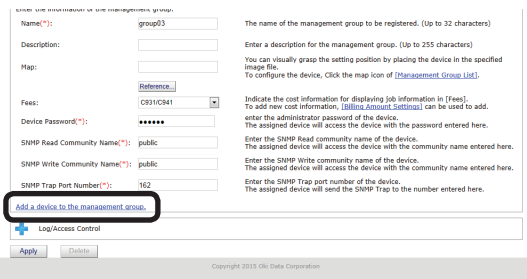

- 4 Select the device to omit from [Assigned Device List], click [Left Arrow], switch to [Device List] and click [OK].

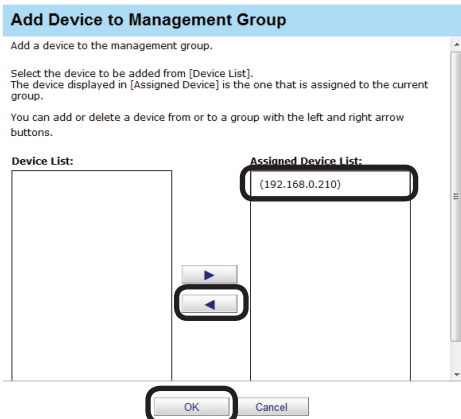

- 5 Enter the administrator password for the device and click [Apply].

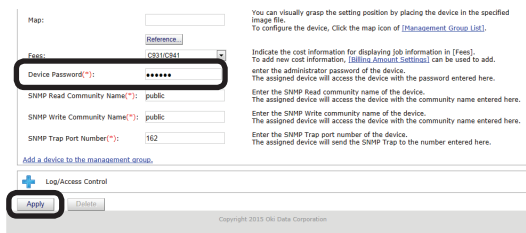

**For details on the device's factory set administrator password, see the User's Manual of the device.**

- 6 Click [OK] in the confirmation window.

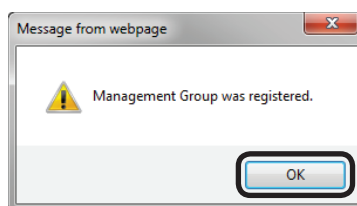

- 7 Click the new group to be assigned to and display the [Device List].

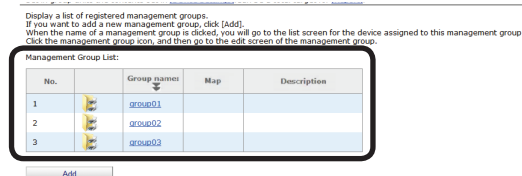

- 8 Select the device to add to the group from [Device List], click [Right Arrow] and switch to [Assigned Device List].

Click [OK] to register the device to the group.

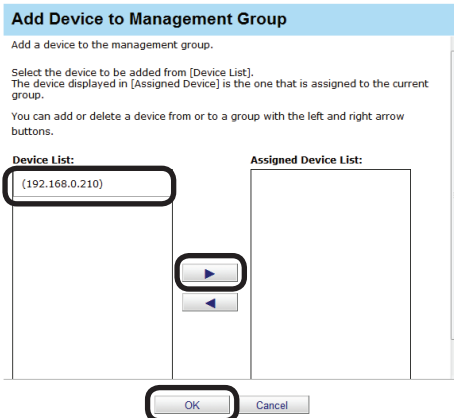

**Click [Left Arrow] to switch from [Assigned Device List] to [Device List].**

- Enter the administrator password for the device and click [Apply].

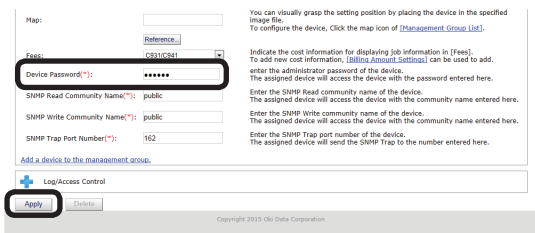

**Note**

For details on the device's factory set administrator password, see the User's Manual of the device.

- Click [OK] in the confirmation window.

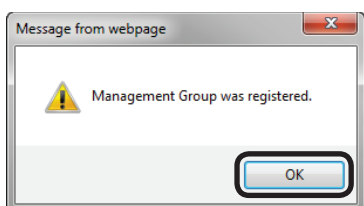

## Deleting Management Groups

- Delete the group from [Function Details] > [Manage] > [Device Management Settings] > [Management Group].

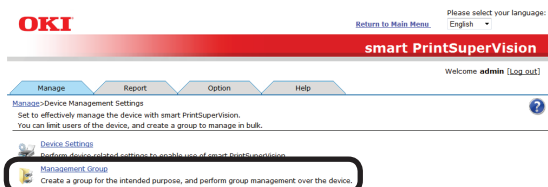

- Click the management group that you want to delete.

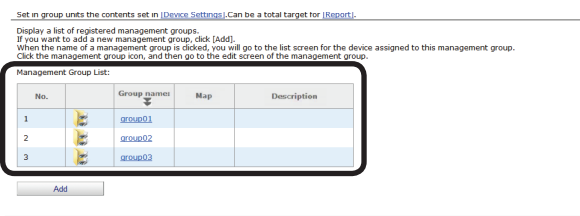

- Click [Delete].



- Click [OK] in the confirmation window.

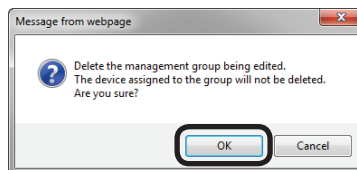

**Note**

Devices that belonged to the deleted management group are changed to "None".

# 8. Registering and Managing Users

---

Individual Management.....	130
User Registration .....	130
Registering User Group .....	131
Registering Users and User Groups to a Device .....	133
Changing User/User Group Information .....	135
Changing User Group Assignment .....	136
Deleting Users/User Groups .....	137
Active Directory-linked Management .....	138
Adding Users/User Groups.....	138
Changing User Information.....	139
Changing Attributes Displayed in the User List .....	141
Deleting Users/User Groups.....	141

# 8. Registering and Managing Users

Users/user groups can be registered in the sPSV by entering the user name and user group name into the sPSV (individual management) or by adding user names and user group names registered in the Active Directory domain (Active Directory-linked management).

## Individual Management

### User Registration

#### Create a New User.



**For details on the number of users that can be registered, see the User's Manual of the device.**

- 1 Add a user from [Details Screen] > [Option] > [User Settings].

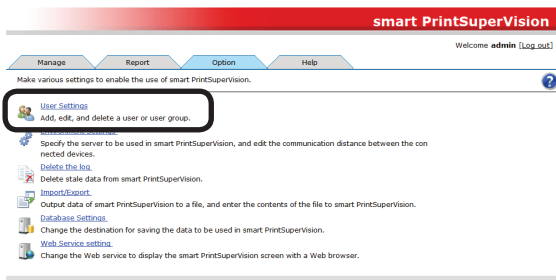

- 2 Click in [Add a user/user group.] to open the tree, and then click [Add a Local User].

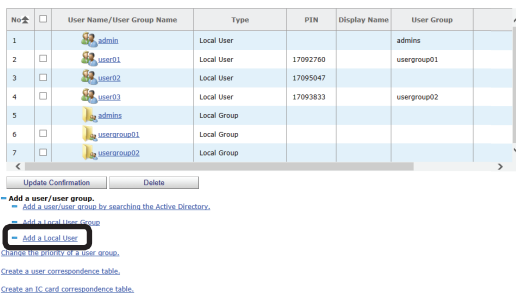

- 3 Enter user information into the entry field of each item. (\*) denotes a required item.

Management Report Option Help

Default > User Settings > User Information

Enter or edit the user information.

General

Enter the user information. Items marked with (\*) are required.

PIN (\*)  The ID that identifies the user. (1 - 999,999,999) Click [Numbering] to retrieve a random unused PIN. (Usable values: 1 to 999999999)

User Name (\*)  The name used to log in to smart PrintSuperVision, or to register with the device. (Up to 32 characters)

Password (\*)  Password used to log in to smart PrintSuperVision. (Up to 32 characters)

Password(Check) (\*)  Confirm the password used to log in to smart PrintSuperVision. (Up to 32 characters)

Last Name:  The user's last name.

First Name:  The user's first name.

E-mail Address:  The e-mail address to be used for various notifications.

Notify the totals by e-mail. Notify the device usage totals of a user on the day after the closing date.

Telephone Number:  The user's telephone number.(Up to 64 characters)

Description:  The user's description.(Up to 1024 characters)

Display Name:  The user's display name. (Up to 256 characters)

Language Code:  other The user's language code. (Up to 64 characters)

IC Card Information:  The user's card ID. (Up to 256 characters)

User Group

Available Usage

Display Usage

#### [PIN](\*)

ID that identifies the user.

(Usable values: 1 to 999999999)

Click [Numbering] to display a random unused PIN ID in the [PIN] text box.

#### [User Name](\*)

Used when logging in to the sPSV or registering the user to the device.

(up to 32 characters)

#### [Password](\*)

Password used to log in to the sPSV.

(up to 32 characters)

#### [Password(Check)](\*)

Password (for confirmation) used to log in to the sPSV. (up to 32 characters)

#### [Last Name]

Last (family) name of the user.

(up to 32 characters)

#### [First Name]

First name of the user. (up to 32 characters)

#### [E-mail Address]

Email address of the user. (up to 256 characters)

Mail destination when [Notify the totals by e-mail.] is on.

#### [Notify the totals by e-mail.]

Check this to receive notifications of the total amount of device use each month.

#### [Telephone Number]

The telephone number of the user.

(up to 64 characters)

#### [Description]

Description of the user. (up to 1024 characters)

#### [Display Name]

The name displayed for the user. (up to 256 characters)

#### [Language Code]

The language code of the user. (up to 64 characters)



**[IC Card information]**

The card ID of the user. (up to 256 characters)

**4** Click [Apply] to register the user.

Telephone Number :	<input type="text"/>	The user's telephone number (up to 64 characters)
Description :	<input type="text"/>	The user's description (up to 1024 characters)
Display Name :	<input type="text"/>	The user's display name (up to 256 characters)
Language Code :	other <input type="text"/>	The user's language code. (up to 64 characters)
IC Card information :	<input type="text"/>	The user's card ID. (up to 256 characters)
+ User Group		
+ Available Usage		
+ Display Usage		
<input type="button" value="Apply"/>		

Next, proceed to "Registering Users and User Groups to a Device" (P. 133).

-To manage registered users by groups, proceed to "Registering User Group" (refer to right section).

**Registering User Group**

Multiple users can be managed as one group. When managed as a group, the log can be displayed in group units. Furthermore, the available usage can be set as a total for all of the users that are assigned to the group.

**Creating a New User Group**

- 1 Create a user group from [Details Screen] > [Option] > [User Settings].

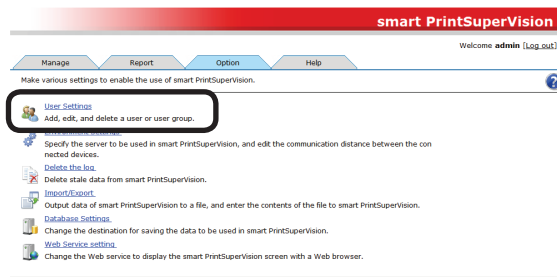

- 2 Click **+** in [Add a user/user group.] to open the tree, and then click [Add a Local User Group].

No	User Name/User Group Name	Type	PIN	Display Name	User Group
1	admin	Local User			admin
2	user01	Local User	17092760		usergroup01
3	user02	Local User	17095047		usergroup02
4	user03	Local User	17093833		usergroup02
5	admin	Local Group			
6	usergroup01	Local Group			
7	usergroup02	Local Group			

Update Confirmation    Delete

[Change the priority of a user group.](#)  
[Create a user correspondence table.](#)  
[Create an IC card correspondence table.](#)

- 3 Enter User group information into the entry field of each item. (\*) denotes a required item.

**[User group name](\*)**

Name of the user group.  
(up to 256 characters)

**[E-mail Address]**

Email address of the user group.  
(up to 256 characters)  
Mail destination when [Notify the totals by e-mail.] is on.

**[Notify the totals by e-mail.]**

Check this to receive notifications of the total amount of device use each month.

**[Assign to the admins user group.]**

Assign administrator privileges to a user who is assigned to the user group.

**[Description]**

Description of the user group.  
(up to 1024 characters)

4 Click [Apply] to register the user group.

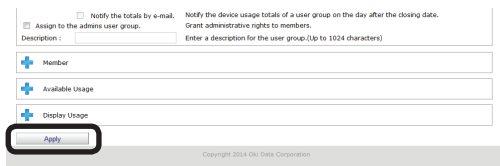

Next, proceed to "Registering Users to the Group" (refer to the section below).

**Registering Users to the Group**

1 Register a user group from [Details Screen] > [Option] > [User Settings].

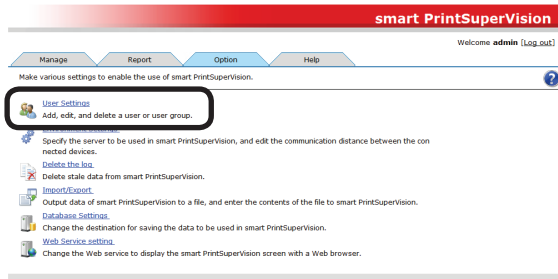

2 Click the user group to which you want to register the user in [User List].

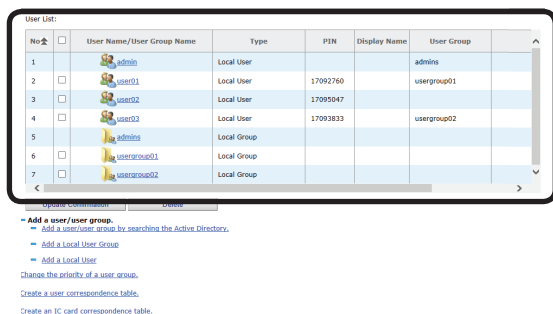

3 Click **+** in [Member].

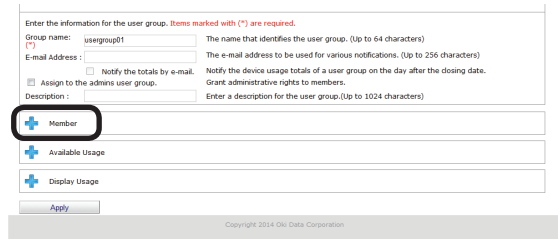

4 Click [Add].

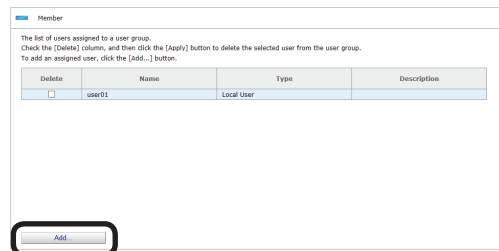

5 A list of users registered to sPSV is displayed. Check the user to be registered and click [OK].

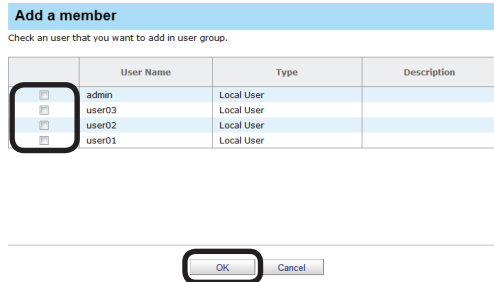

6 Click [Apply] to register users to the user group.

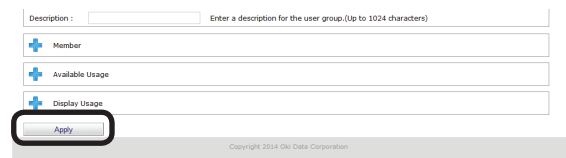

Next, proceed to "Registering Users and User Groups to a Device" (P. 133).

# Registering Users and User Groups to a Device

- 1 Register from [Details Screen] > [Manage] > [Device Management Settings] > [Device Settings].

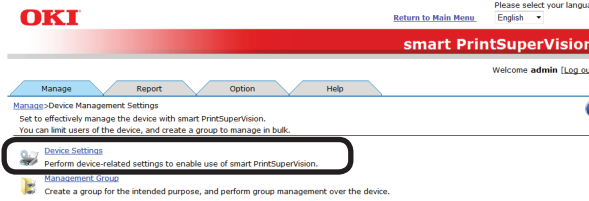

- 2 Select the device to register from [Device].

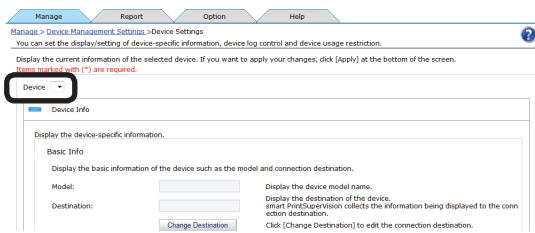

- 3 Click **+** in [Log/Access Control] to open the settings window.

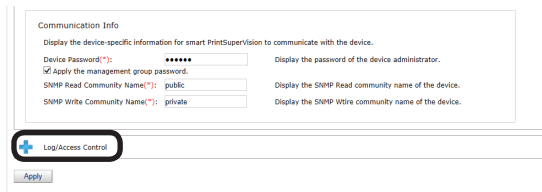

- 4 Check [Enable access control.], and set [Panel Access Control] and [User Auth. Method:].



## [Panel Access Control] [User Name/Password]

Enter the user name and password when logging in from the device panel.

## [PIN]

Enter the PIN ID when logging in from the device panel.

## [Do not specify]

Use the default device method when logging in from the device panel.

## [Invalidity]

It is possible to disable the panel access control of the device and use the print restriction function.

## [User Auth. Method] [User Name/Password]

This is enabled when [User Name/Password] is set in [Panel Access Control]. Specify from [Local], [LDAP] and [Secure Protocol].



- Displayed items differ depending on the device.
- The settings in [Panel Access Control] cannot be changed while the device is acquiring the job log.
- In some devices, [Access Control] settings can be operated after changing the "Record Job Log to Device" check mark and clicking [Apply].

- 5 Click **+** in [User Name] to open the use restrictions setting window for the [User Name].

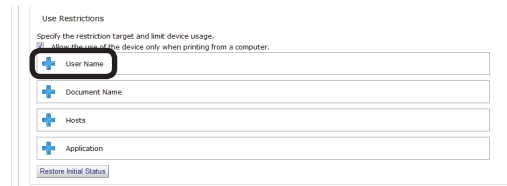

- 6 Click [Add].

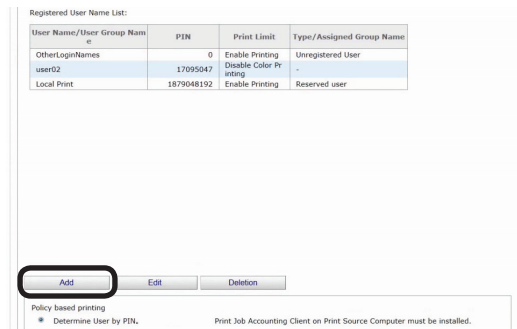

If the following buttons are displayed, see 9.

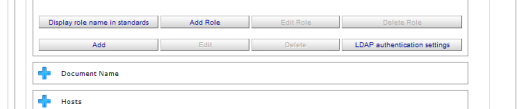

- 7 Select the user or user group to register from [User Name List].

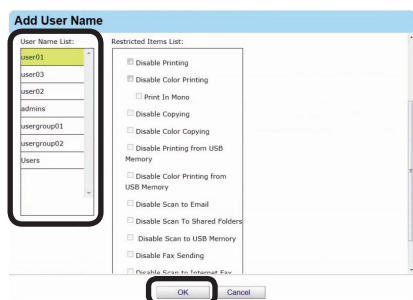

- 8 Click [OK] to register to the device. See 12.

- 9 Select the registered user or user group from the [User Name List].

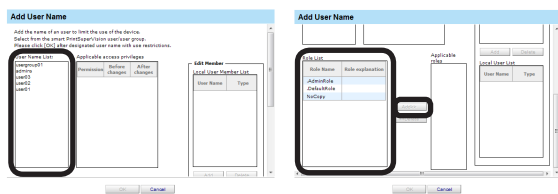

- 10 Select the roles to assign to the user from [Role List] and click [Add>>].  
For details on registering roles, see "Registering Roles" (P. 153)



**Users that are not assigned the roles perform the [DefaultRole] operation.**

- 11 Click [OK].  
12 Click [Apply].



When the "Enter an administrator password for the device" window is displayed, open the [Device Info] input window, enter the administrator password for the device and click [Apply].



- Depending on the device, this may not be displayed.
- For details on the device's factory set administrator password, see the User's Manual of the device.
- When user group use restrictions are changed at a later date, the changes are applied to the use restrictions of users that are assigned to multiple groups. The priority level of available usage for user groups can be changed. For information on these settings, see "Changing the Priority Level of User Group" (P. 171).

- 13 Click [OK] in the confirmation window.

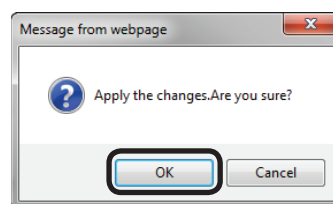

Proceed to "9. Restricting Device Use" (P. 143) to set use restrictions for added users/user groups.

# Changing User/User Group Information

## Changing User Information

- 1 Change the information from [Details Screen] > [Option] > [User Settings].

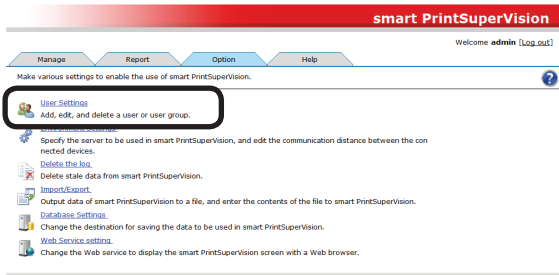

- 2 Click the user in [User List].

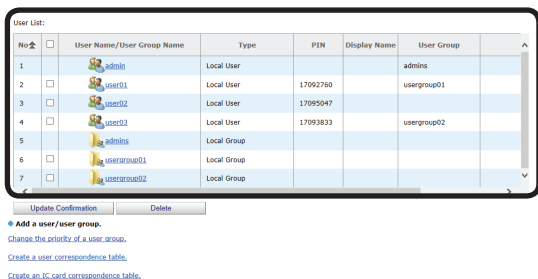

- 3 Changing User Information.  
For details on each item, see "User Registration" (P. 130).



**General users can only view their own information and change their password.**

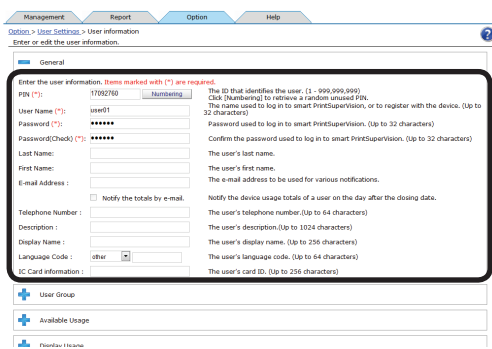

- 4 Click [Apply] to change the user settings.

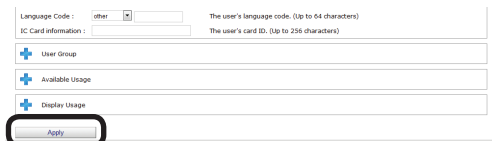

## Changing User Group Information

- 1 Change the information from [Details Screen] > [Option] > [User Settings].

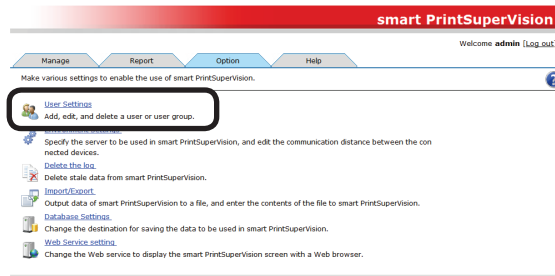

- 2 Click the user group in [User List].

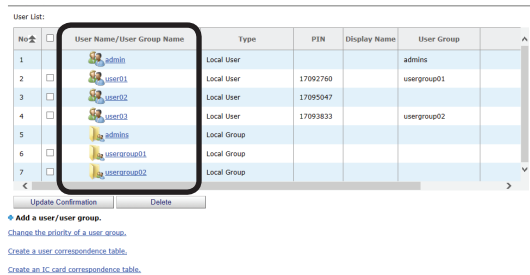

- 3 Changing User Group Information.  
For details on each item, see "Registering User Group" (P. 131).

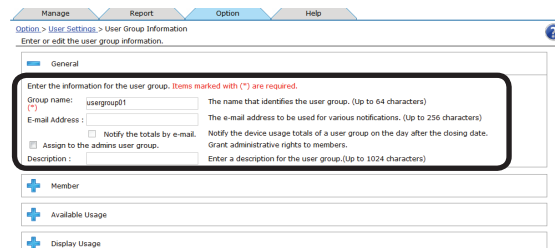

**General users can only view information on the user group where they are assigned.**

- 4 Click [Apply] to change the user group settings.

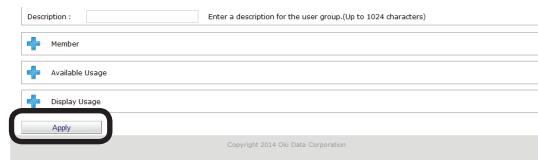

# Changing User Group Assignment

1 Change the information from [Details Screen] > [Option] > [User Settings].

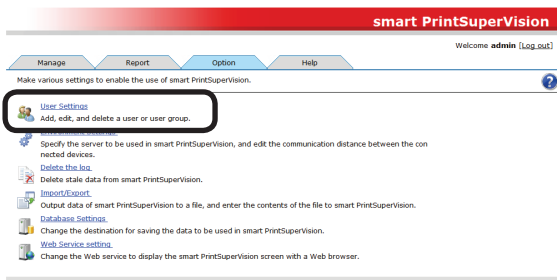

2 Click the user group in [User List].

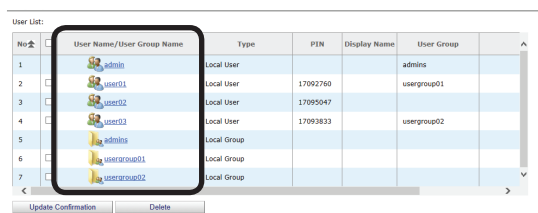

3 Click + in [Member].

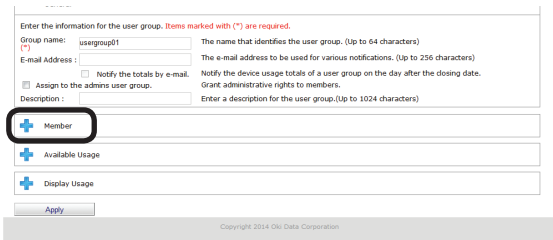

4 A list of users registered to sPSV is displayed. Check the users to remove from the group.

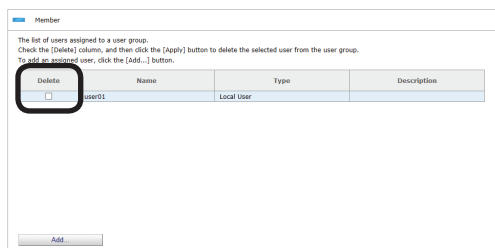

5 Click [Apply], and the users are removed from the group.

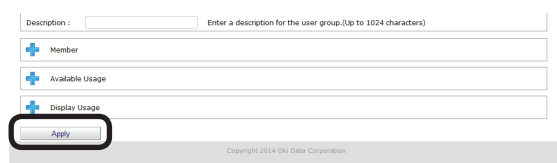

6 Click [OK] in the confirmation window.

## Check

Delete a user/user group.



7 Click the user group to be newly assigned in the [User List].

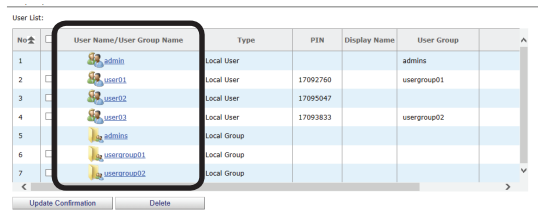

8 Click + in [Member].

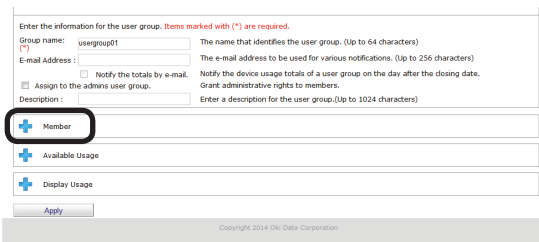

9 Click [Add].

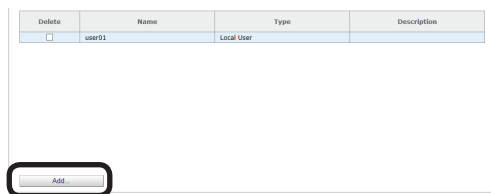

10 A list of users registered to sPSV is displayed. Check the users to be registered in this group and click [OK].

## Add a member

Check an user that you want to add in user group.

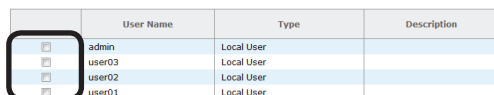

- 11 Click [Apply] to register users to the user group.

Description :  Enter a description for the user group.(Up to 1024 characters)

Member

Available Usage

Display Usage

**Apply**

Copyright 2014 Oki Data Corporation

## Deleting Users/User Groups

- 1 Delete the information from [Details Screen] > [Option] > [User Settings].

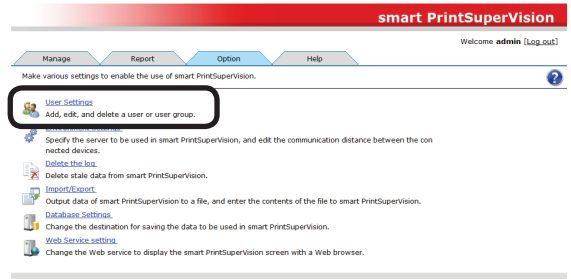

- 2 Check the user/user group to be deleted in the [User List].

No.	<input type="checkbox"/>	User Name/User Group Name	Type	PIN	Display Name	User Group
1	<input checked="" type="checkbox"/>	admin	Local User			admins
2	<input checked="" type="checkbox"/>	user01	Local User	17092760		usergroup01
3	<input checked="" type="checkbox"/>	user02	Local User	17095047		usergroup02
4	<input type="checkbox"/>	user03	Local User	17093833		usergroup02
5	<input type="checkbox"/>	admin	Local Group			
6	<input type="checkbox"/>	usergroup01	Local Group			
7	<input type="checkbox"/>	usergroup02	Local Group			

Update Confirmation Delete

◆ Add a user/user group.  
[Change the priority of a user group.](#)  
[Create a user correspondence table.](#)  
[Create an IC card correspondence table.](#)



**Multiple users/user groups can be selected.**

- 3 Click [Delete].

No.	<input type="checkbox"/>	User Name/User Group Name	Type	PIN	Display Name	User Group
3	<input checked="" type="checkbox"/>	user02	Local User	17095047		usergroup02
4	<input checked="" type="checkbox"/>	user02	Local User	17093833		usergroup02
5	<input type="checkbox"/>	admin	Local Group			
6	<input type="checkbox"/>	usergroup01	Local Group			
7	<input type="checkbox"/>	usergroup02	Local Group			

Update Confirmation **Delete**

◆ Add a user/user group.  
[Change the priority of a user group.](#)  
[Create a user correspondence table.](#)  
[Create an IC card correspondence table.](#)

- 4 Click [OK] in the confirmation window.

### Check

Delete a user/user group.



**When a user group is deleted, the users that belonged to the deleted user group are changed to "Unassigned".**

## Active Directory-linked Management

User and user group information on the Active Directory server is monitored and if the information changes, it is updated at the interval or time set in sPSV.



For information on setting the update interval or time, see “Changing the Time or Interval at Which Update of Active Directory is Confirmed” (P. 46). For information on updating the information immediately, see “To update Active Directory Immediately” (P. 47).

## Adding Users/User Groups

You can search for users or user groups from the Active Directory and set use restrictions or available usage.

- 1 Add a user from [Details Screen] > [Option] > [User Settings] > [User Settings].

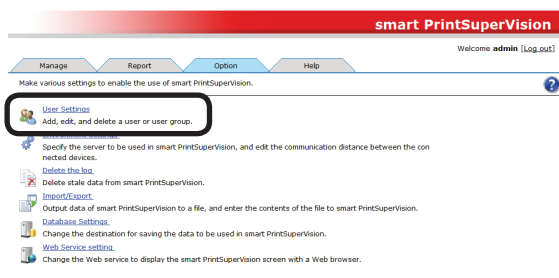

- 2 Click in [Add a user/user group.] to open the tree, and then click [Add a user/user group by searching the Active Directory.].

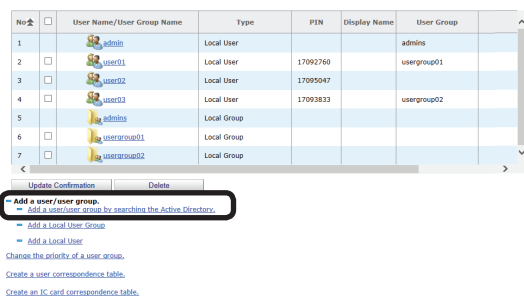

- 3 Enter the search criteria in [Search Criteria] and click [Start Search].

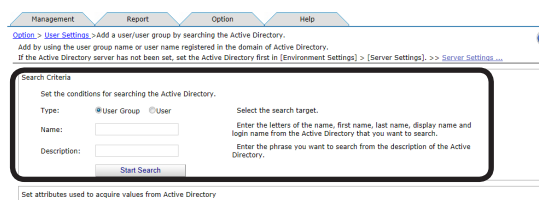

The search cannot be performed unless the Database Active Directory connects to is set. For details, see “Settings for Connecting to Active Directory” (P. 45).

### [Type]

Select what to search on the Active Directory. Select the search target from [User Group] or [User].

### [Name]

To search for a user, enter a character string including the first letter of the last name, first name, display name and login name of the user. (up to 256 characters)

To search for a user group, enter a character string including the first letter of the Active Directory user group name. (up to 256 characters)

### [Description]

Enter a character string including the first letter of the description of the user or user group registered in the Active Directory. (up to 1024 characters)



- If both [Name] and [Description] are entered, items that match both are displayed.
- If the [Start Search] button is clicked when the [Name] and [Description] sections are blank, the search is performed for all users or groups.
- “\*” can be entered as a wild card for [Name] and [Description]. “\*” represents more than 0 character strings.
- When acquiring the Language Code and IC card information from Active Directory, enter [Set attributes used to acquire values from Active Directory], click [Save] and then click [Start Search].



- 4 The user group or user is displayed in [Search Results].  
 Check the user group or user to be registered and click [Registration].

Search Results:

No.	<input type="checkbox"/>	User Name/User Group Name	Type	Option	Display Name	Last Name	First Name	E-mail Address	Telephone Number
1	<input type="checkbox"/>	Administrators	Group	No Setting					
2	<input type="checkbox"/>	Users	Group	No Setting					
3	<input type="checkbox"/>	Users	Group	No Setting					
4	<input type="checkbox"/>	Print Operators	Group	No Setting					
5	<input type="checkbox"/>	Backup Operators	Group	No Setting					
6	<input type="checkbox"/>	Operator	Group	No Setting					
7	<input type="checkbox"/>	Remote Desktop Users	Group	No Setting					
8	<input type="checkbox"/>	Network Configuration Operators	Group	No Setting					
9	<input type="checkbox"/>	Performance Monitor Users	Group	No Setting					
10	<input type="checkbox"/>	Performance Log Users	Group	No Setting					
11	<input type="checkbox"/>	Distributed COM Users	Group	No Setting					
12	<input type="checkbox"/>	Administrators	Group	No Setting					
13	<input type="checkbox"/>	Administrators	Group	No Setting					

Registration

Next, proceed to "Changing User Information" (P. 139).

## Changing User Information

The PIN is automatically assigned when a user is registered from Active Directory. Change the assigned PIN and user information.

- 1 Change the information from [Details Screen] > [Option] > [User Settings].

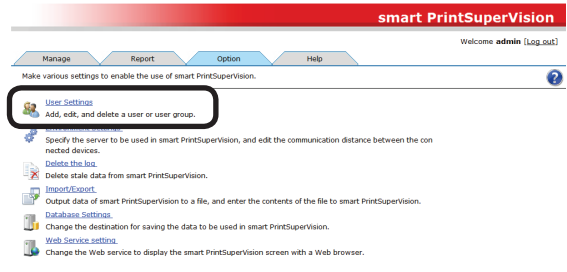

- 2 Click the user or user group in [User List].

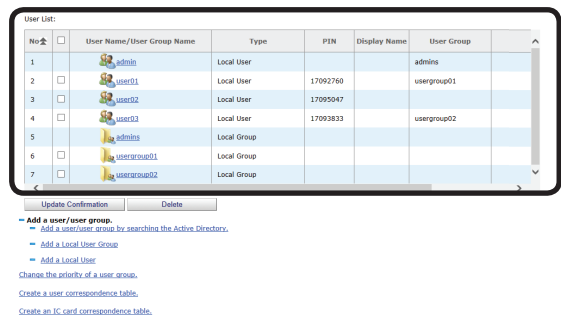

- 3 Change the user information in the entry field of each item. (\*) indicates items that can be changed.

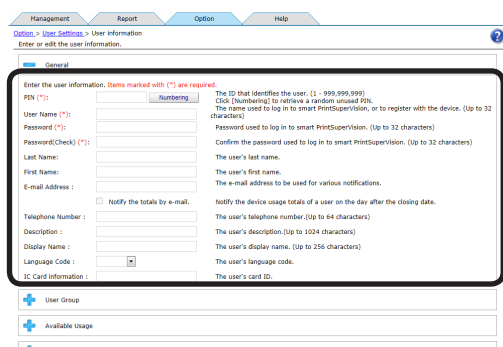

### [PIN](\*)

ID that identifies the user. A PIN is automatically assigned when users and user groups are added by searching Active Directory.

(Usable values: 1 to 999999999)

Click [Numbering] to extract a random unused PIN and display it in the [PIN] text box.

**[User Name]**

Used when logging in to sPSV or registering the user to the device.

(up to 32 characters)

Users registered from Active Directory use the Active Directory login name.

**[Password](\*)**

Password used to log in to sPSV.

(up to 32 characters)

**[Password(Check)](\*)**

Password (for confirmation) used to log in to sPSV.

(up to 32 characters)



**“password” is set as the initial password for users registered from Active Directory.**

**[Last Name]**

Last (family) name of the user.

(up to 32 characters)

**[First Name]**

First name of the user. (up to 32 characters)

**[E-mail Address]**

Email address of the user. (up to 256 characters)

Mail destination when [Notify the totals by e-mail.] is on.

**[Notify the totals by e-mail.] (\*)**

Check this to receive notifications of the total amount of device use each month.

**[Telephone Number]**

The telephone number of the user.

(up to 64 characters)

**[Description]**

Description of the user. (up to 1024 characters)

**[Display Name]**

The name displayed for the user. (up to 256 characters)

**[Language Code]**

The language code of the user. (up to 64 characters)

**[IC Card information]**

The card ID of the user. (up to 256 characters)

**4 Click [Apply] to change the user information.**

Proceed to “9. Restricting Device Use” (P. 143) to set use restrictions for added users/user groups.

## Changing Attributes Displayed in the User List

Add columns that are displayed as results when searching users/user groups from the Active Directory.

- 1 Add in [Details Screen] > [Option] > [Environment Settings] > [Server Settings].

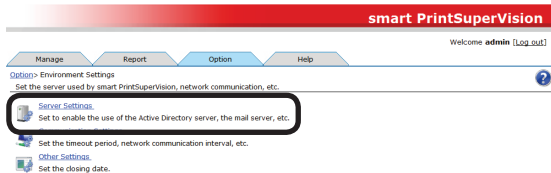

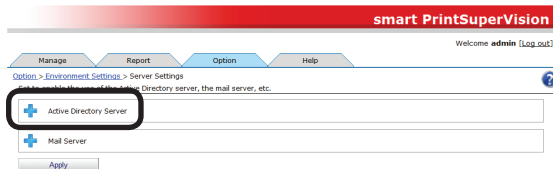

- 2 Click  in the [Active Directory Server] to open the file tree.



- 3 Select the item to be changed and follow the steps below to change it.

To display: Select the items to display from [Displayable Column], and click  to switch to [Display Column].

To hide: Select the items to hide from [Display Column], and click  to switch to [Displayable Column].

To change order: Select the items in [Display Column] and click  or  to change the order.

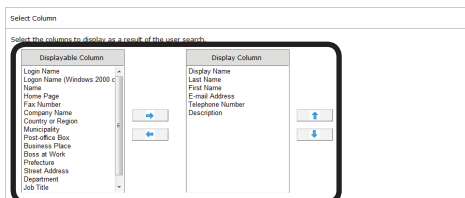

- 4 Click [Apply].

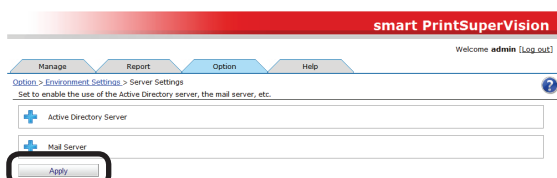

## Deleting Users/User Groups

Delete users/user groups from Active Directory.

- 1 Change the information from [Details Screen] > [Option] > [User Settings].

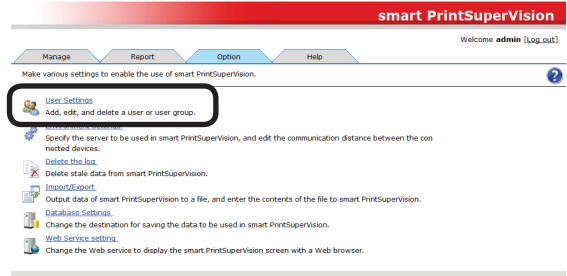

- 2 Check the Active Directory user/user group in the [User List].

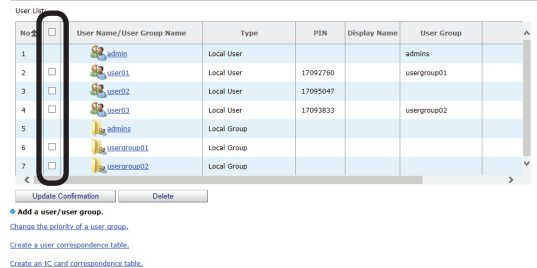

- 3 Click [Delete].

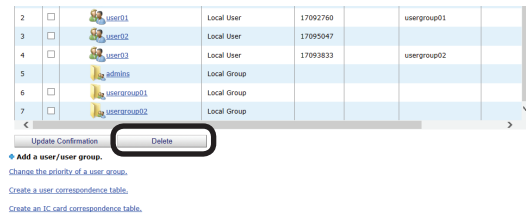

- 4 Click [OK] in the confirmation window.

### Check

Delete a user/user group.



## 9. Restricting Device Use

---

What Can Be Done With Use Restrictions.....	143
Usage Limitations.....	143
Setting Use Restrictions for User Names.....	147
Adding from the User.....	147
Adding Manually .....	149
Adding from the Job Log .....	150
Creating a CSV File to Add in a Batch.....	150
Importing Users Specified in Windows.....	151
Adding by Associating a PIN to an Authentication User Name .....	152
Adding Unregistered User Settings .....	153
Registering Roles .....	153
Setting LDAP Authentication .....	154
Setting Use Restrictions Targeted to the Document Name .....	155
Adding from the Job Log .....	155
Adding Manually .....	157
Adding Unregistered Item Setting.....	157
Setting Use Restrictions Targeted to the Host Name.....	159
Adding from the Job Log .....	159
Adding Manually .....	160
Adding Unregistered Item Settings .....	161
Setting Use Restrictions Targeted to the Application Name .....	161
Adding Manually .....	162
Adding from the Job Log .....	163
Adding Unregistered Item Settings .....	164
Displaying Device Registered Use Restrictions .....	164
Changing Device Registered Use Restrictions .....	165
Delete Device Registered Use Restrictions .....	166
Deleting Individual Use Restrictions .....	166
Deleting All Use Restrictions (Restoring Initial Status) .....	167
Temporarily Disabling Use Restrictions .....	168
Enabling Use Restrictions .....	169

## 9. Restricting Device Use

### What Can Be Done With Use Restrictions

The use of a device can be restricted by specifying restriction targets from the user name, document name, host name and application name, and setting limit items for a registered device.

Setting use restrictions for each device prevents unintended use of devices and enables management of information leakage risks.

### Usage Limitations

#### Restriction Targets that Can Be Registered

Use one of the following methods to specify the restriction target and register use restrictions.

Restriction Targets that Can Be Registered	Description
[User Name]	Register the user to restrict from printing from a computer or accessing the panel.
(1) [User]	Select the user name/user group name registered in sPSV (including those added from Active Directory) and register use restrictions. ⇒ P. 147
(2) [Direct Input]	Enter the user name manually and register use restrictions. ⇒ P. 149
(3) [Job Log]	Select from the user names extracted from the job log acquired by the device, and register use restrictions. ⇒ P. 150
(4) [File]	Select the user name from those extracted from the specified file name, and register use restrictions. ⇒ P. 150
(5) [Other Computers]	Select the user name from those extracted from the computers that can participate in the network, and register use restrictions. ⇒ P. 151
(6) [Other Users]	Associate a different user name to the PIN registered in the device, and register use restrictions. ⇒ P. 152
(7) [Role]	Registers usage restrictions to roles. Roles are used to set whether an operation is permitted or prohibited, and are assigned to device user information. ⇒ P. 153
[Document Name]	Register the document name to be restricted from printing from the computer.
(8) [Job Log]	Select from the document names extracted from the job log acquired by the device, and register use restrictions. ⇒ P. 157
(9) [Direct Input]	Enter the document name manually and register use restrictions. ⇒ P. 157
[Hosts]	Register the hosts to be restricted from printing from the computer.
(10) [Job Log]	Use restrictions are applied to hosts extracted from the job log acquired by the device. ⇒ P. 158

Restriction Targets that Can Be Registered	Description
(11) [Direct Input]	Enter the hosts manually and register use restrictions. ⇒ P. 160



**Numbers (1) to (7) of [User Name], [Document Name] and [Hosts] may not be configurable depending on the connected device. Depending on the device, if [Record Job Log to Device] (P. 123) is checked, the [User Name], [Document Name] and [Hosts] print restrictions registered to the device are enabled.**

### Restriction Items that Can Be Set

Items that can be restricted from use with the device differ according to the specified restriction target.

Restriction Items and Permissions that Can Be Registered	Restriction Details	Specified Restriction Target
[Prohibit Printing]	The device prohibits all print jobs.	(1) to (11)
[Prohibit Color Printing]	The device prohibits all color print jobs. If there is a color page in a print job, all printing from that page onwards including that page is canceled.	(1) to (11)
[Print in Mono]	When prohibit color printing is set, the device converts color data into monochrome data and prints the data.	(1) to (11)
[Prohibit Copy]	Copying using panel operations is prohibited. When this is disabled, the prohibit printing settings are applied.	(1), (6)
[Prohibit Color Copy]	Color copying using panel operations is prohibited.	(1), (6)
[Prohibit Printing from USB Memory]	Prohibits printing from a USB flash drive using panel operations.	(1), (6)
[Prohibit Color Printing from USB Memory]	Prohibits color printing from a USB flash drive using panel operations.	(1), (6)
[Disable Fax Sending]	Prohibits fax sending using panel operations. Fax sending that uses the fax driver is also canceled.	(1), (6)
[Disable Scan to Email]	Prohibits Scan to Email using panel operations.	(1), (6)
[Disable Scan To Shared Folders]	Prohibits scanning to shared folders using panel operations.	(1), (6)
[Disable Scan to USB Memory]	Prohibits scanning to a USB flash drive using panel operations.	(1), (6)
[Disable Scan to Internet Fax]	Prohibits scan to Internet fax using panel operations.	(1), (6)

<b>Restriction Items and Permissions that Can Be Registered</b>	<b>Restriction Details</b>	<b>Specified Restriction Target</b>
[Disable Scan to Fax Server]	Prohibits scan to fax server using panel operations.	(1), (6)
[Print]	Sets the print job attributes.	(7)
[Print(Color)]	Sets the color print job attributes.	(7)
[Print(IF Color To Monochrome)]	Sets the color print job attributes.	(7)
[PC Fax]	Sets the Fax Sending attributes.	(7)
[Copy]	Sets the copy attributes.	(7)
[Copy(Color)]	Sets the color copy attributes.	(7)
[Scan To Fax]	Sets the Scan To Fax attributes.	(7)
[Scan To Server]	Sets the Scan To Shared Folder attributes.	(7)
[Scan To Email]	Sets the Scan To Email attributes.	(7)
[Scan To UsbMemory]	Sets the Scan To USB memory attributes.	(7)
[Scan To FaxServer]	Sets the Scan To Fax Server attributes.	(7)
[Scan To IFax]	Sets the Scan To Internet Fax attributes.	(7)
[Print From USBMemory]	Sets the printing from USB memory attributes.	(7)
[Print From USBMemory(Color)]	Sets the color printing from USB memory attributes.	(7)
[Read Log]	Sets the Read Log attributes.	(7)
[Edit JobMacro]	Sets the job macro edit attributes.	(7)
[Edit Indexed Scan]	Sets the index scan edit attributes.	(7)
[Delete Log]	Sets the log delete attributes.	(7)
[Edit User]	Sets the user edit attributes.	(7)
[Edit Role]	Sets the role edit attributes.	(7)
[Edit Account]	Sets the account edit attributes.	(7)

Attributes are [Enable], [Prohibit] and [Forced prohibit]. If multiple roles set with permissions that have different attributes are registered to the same user, the priority of attributes is [Forced prohibit], [Enable], [Prohibit].

Displayed items differ depending on the device.

### Client Software Required for [User Name] Restriction Targets

The method (print policy) used to determine device users that can configure settings differs depending on the specified restriction target.

Specified Restriction Target	Print Policy Settings	Determination Method
Restriction targets (1) and (6)	Determine Users by PIN	It is necessary to install the client software on the client computer and set a user ID.
Restriction targets (1), (2), (3), (4) and (5)	Determine users by user name	It is not necessary to install the client software because processing is performed with the user name.



**Client software is not required when specifying [Document Name] and [Hosts] as the restriction target.**



## Setting Use Restrictions for User Names

If required, use restrictions can be set to the user name. Add the settings using one of the following methods.

- Adding from the user.
- Adding manually.
- Adding from the job log.
- Adding by association to a different user name.
- Creating a user name list file and adding in a batch.
- Users registered in Windows on the network are read.

### Adding from the User

Configure use restriction settings for the device and device management group.

- 1 Configure from [Details Screen] > [Manage] > [Device Management Settings] > [Device Settings].

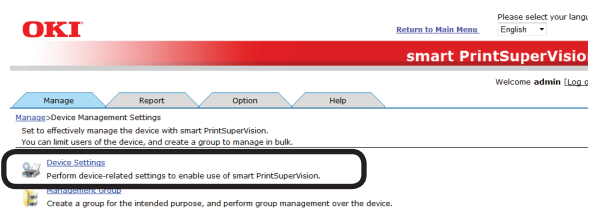

- 2 Select the device to configure from [Device].

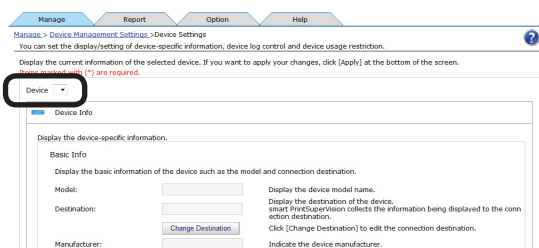

- 3 Click  in [Log/Access Control] to open the settings window.

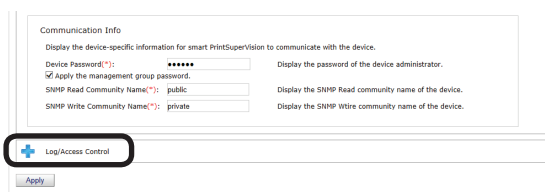

- 4 Check [Enable access control.], and set [Panel Access Control] and [User Auth. Method:].



#### [Panel Access Control] [User Name/Password]

Enter the user name and password when logging in from the device panel.

#### [PIN]

Enter the PIN ID when logging in from the device panel.

#### [Do not specify]

Use the default device method when logging in from the device panel.

#### [Invalidity]

It is possible to disable the panel access control of the device and use the print restriction function.

#### [User Auth. Method]

##### [User Name/Password]

This is enabled when [User Name/Password] is set in [Panel Access Control]. Specify from [Local], [LDAP] and [Secure Protocol].

#### [Email printing use]

Sets the email print restrictions.

#### [Color]

Allows color and monochrome printing.

#### [Mono]

Prohibits color printing, prints in monochrome.

#### [Invalidity]

Prohibits color and monochrome printing.

#### [Google Cloud Print use]

Sets restrictions for printing with Google Cloud Print.

#### [Color]

Allows color and monochrome printing.

#### [Mono]

Prohibits color printing, prints in monochrome.

**[Invalidity]**

Prohibits color and monochrome printing.

**[Guest use]**

Enables/disables guest user settings. Check to enable [Guest authority settings] and specify usable functions.

**[Specify schedule to acquire device use restrictions.]**

Set the schedule to which usage restrictions registered in the device are acquired. When updates are detected, information in this software is updated with settings from the device.

Enabled when [Enable access control] is checked.

**[Specify Interval]**

Acquired for each set interval. The maximum interval time that can be set is 24 hours.

**[Time specified]**

Set the specific time. Click [Specify Time] and add the time. Up to 24 acquisition times can be added. After adding, click [OK].

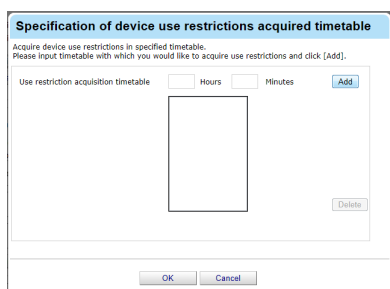

**! Note**

- Displayed items differ depending on the device.
- The settings in [Panel Access Control] cannot be changed while the device is acquiring the job log.

5 Click **+** in [User Name] to open the use restrictions setting window for the [User Name].

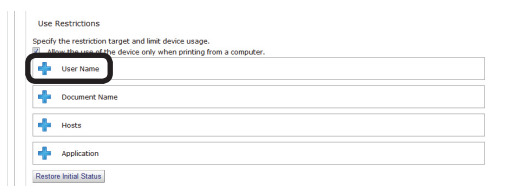

6 Click [Add].

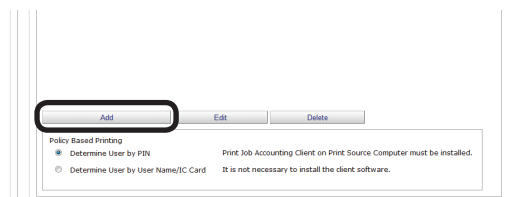

If the following buttons are displayed, see 11.

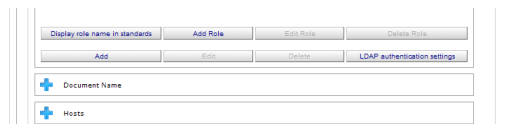

7 Select [User] from [How to Specify User Name].

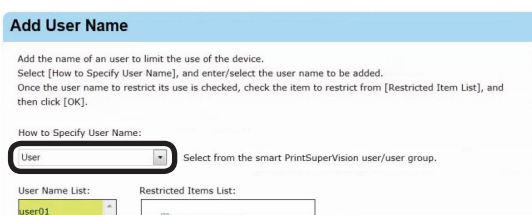

8 Select the user name to add from the [User Name List] and configure the settings in the [Restricted Items List].

For details on restriction items, see "Usage Limitations" (P. 143).

**! Note**

Displayed items differ depending on the specifications of the device.

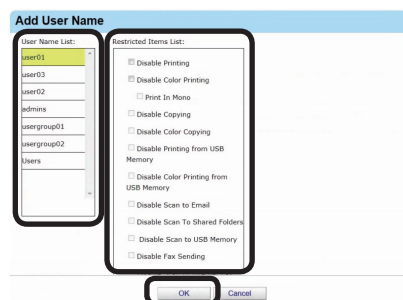

9 Click [OK].

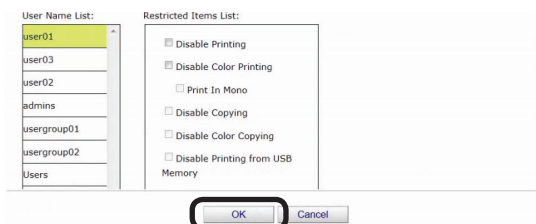

**10** Specify the [Policy based printing] for determining the device user.

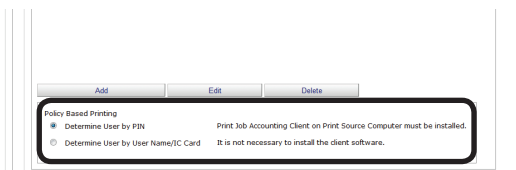

See **14**.

**[Determine User by PIN]**

It is necessary to install the print job client software and configure the user ID on the print source client computer. => P. 41, P. 107

**[Determine users by user name.]**

It is not necessary to install the print job client software because processing is performed with the user name.

**11** Select the registered user from the [User Name List].

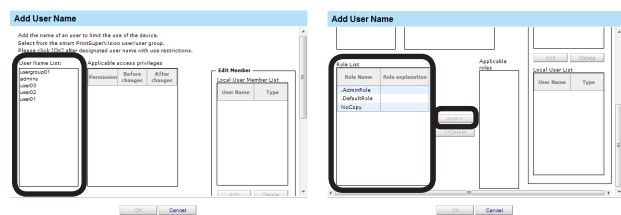

**12** Select the roles to assign to the user from [Role List] and click [Add>>].

For details on registering roles, see "Registering Roles" (P. 153).



**Users that are not assigned roles perform the [DefaultRole] operation.**

**13** Click [OK].

**14** Click [Apply].

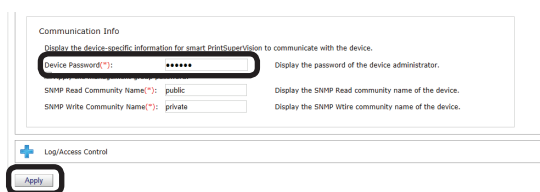

When the "Enter an administrator password for the device" window is displayed, open the [Device Info] input window, enter the administrator password for the device and click [Apply].



- Depending on the device, this may not be displayed.
- For details on the device's factory set administrator password, see the User's Manual of the device.
- User group use restrictions set at a later date are enabled for use restrictions of users assigned to multiple groups.

**15** Click [OK] in the confirmation window.

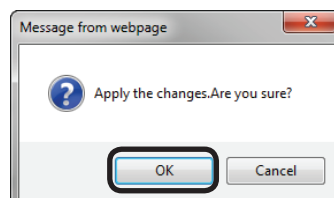

**Adding Manually**

- 1 Refer to "Adding from the User" (P. 147) steps **1** to **6** to open the [Add User Name] window.
- 2 Select [Direct Input] from [How to Specify User Name].

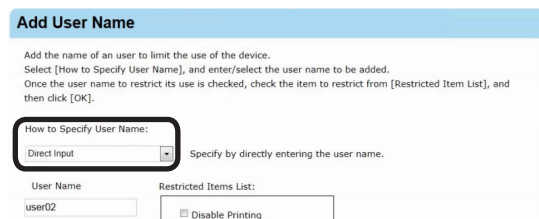

**3** Enter the user name to set from [User Name] and configure the settings in the [Restricted Items List].

For details on restriction items, see "Usage Limitations" (P. 143).



**When specifying the user name using direct input, items other than [Prohibit Printing] and [Prohibit Color Printing] are gray because the user name is not registered as an sPSV user.**

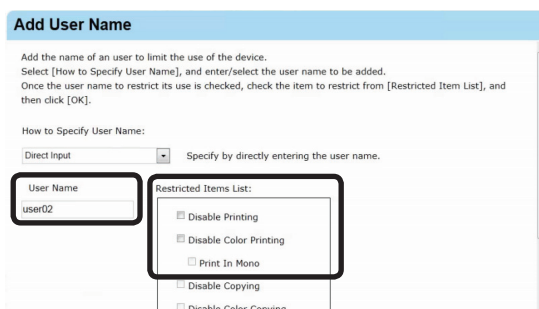

## 4 Click [OK].



## 5 Refer to "Adding from the User" (P. 147) steps 14 and 15 to register the device.

## Adding from the Job Log

Use restrictions can be set to the user names included in an acquired job log.

- 1 Refer to "Adding from the User" (P. 147) steps 1 to 6 to open the [Add User Name] window.
- 2 Select [Job Log] from [How to Specify User Name].

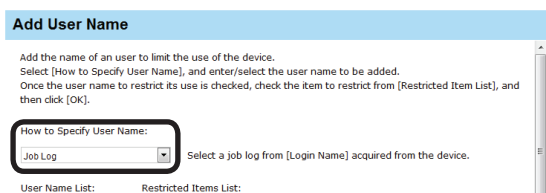

- 3 Select the user name to add from the [User Name List] and configure the settings in the [Restricted Items List].

For details on restriction items, see "Usage Limitations" (P. 143).



**When specifying the user name using job log, items other than [Prohibit Printing] and [Prohibit Color Printing] are gray because the user name is not registered as an sPSV user.**

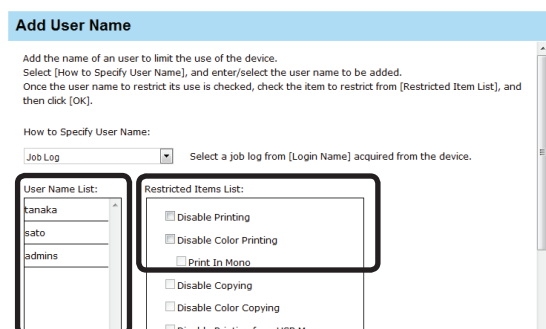

## 4 Click [OK].



## 5 Refer to "Adding from the User" (P. 147) steps 14 and 15 to register the device.

## Creating a CSV File to Add in a Batch

You can create a CSV file that contains the user names, and add settings to the user names by importing the file.

- 1 Create a CSV file using software such as Notepad, Excel, etc.

### <For Notepad>

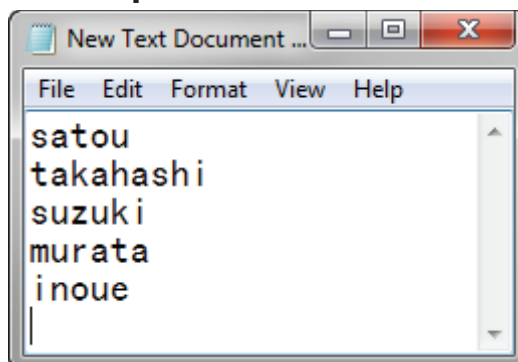

- (1) Write one user name on each line.
- (2) Save in text format with the extension "CSV".

### <For Excel>

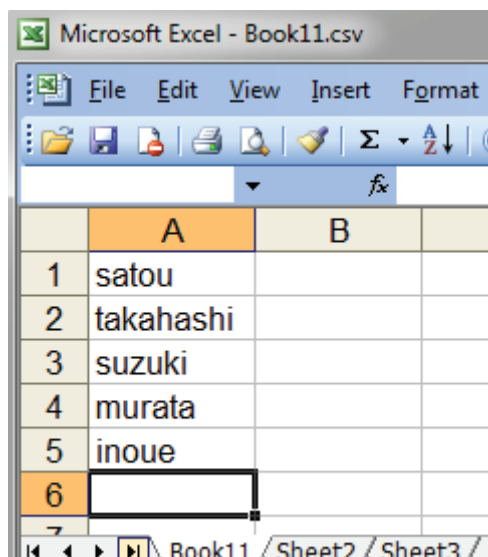

- (1) Write one user name on each line.
  - (2) Save the file in CSV format.
- 2 Refer to "Adding from the User" (P. 147) steps **1** to **6** to open the [Add User Name] window.
  - 3 Select [File] from [How to Specify User Name].

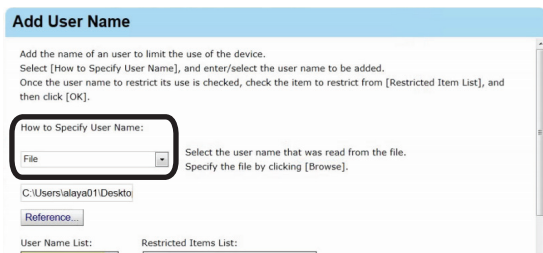

- 4 Click [Reference...] and specify the CSV file created in **1**, then click [Open].
- 5 Select the user name to add from the [User Name List] and configure the settings in the [Restricted Items List].  
For details on restriction items, see "Usage Limitations" (P. 143).



**When specifying the user name using the CSV file, items other than [Prohibit Printing] and [Prohibit Color Printing] are gray because the user name is not registered as an sPSV user.**

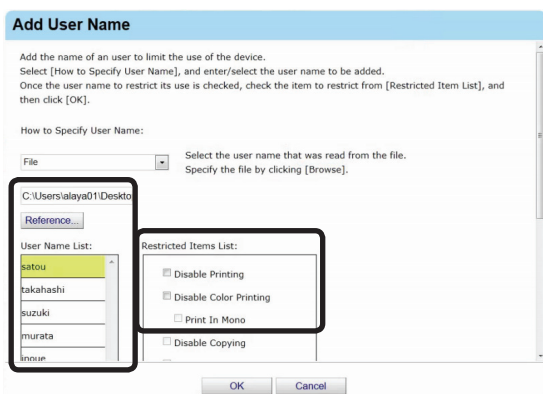

- 6 Click [OK].

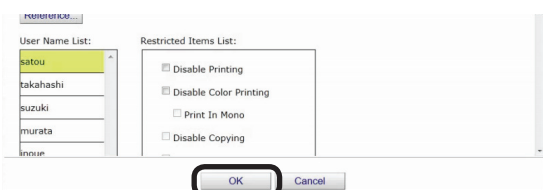

- 7 Refer to "Adding from the User" (P. 147) steps **14** and **15** to register the device.

## Importing Users Specified in Windows

User name information from Windows specified on the network can be obtained and added as a batch to sPSV. Names that can be obtained are accounts registered on the specified computer.



- **Access permission for the specified computer is required.**
- **Active Directory Server settings are required to detect the computer. For details, see "Settings for Connecting to Active Directory" (P. 45).**
- **If the names of users that are already registered to the device and those registered to the computer are duplicated, the device information is not imported, and only names that are not duplicated are added.**

- 1 Refer to "Adding from the User" (P. 147) steps **1** to **6** to open the [Add User Name] window.
- 2 Select [Other Computers] from [How to Specify User Name] and click [Modified].

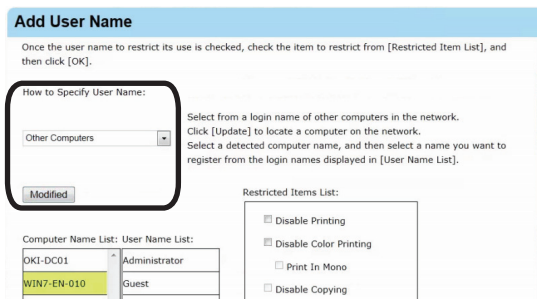

- 3 Select the network computer from [Computer Name List] and the user name to add the settings to from [User Name List].

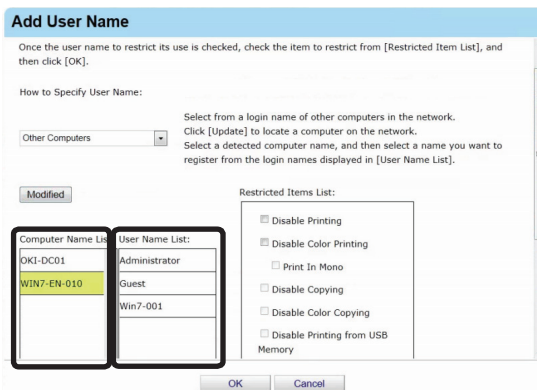

#### 4 Configure the settings in [Restricted Items List].

For details on restriction items, see “Usage Limitations” (P. 143).



**When specifying the user name from other computers, items other than [Prohibit Printing] and [Prohibit Color Printing] cannot be configured because there are no associated user PIN.**

#### 5 Click [OK].

#### 6 Refer to “Adding from the User” (P. 147) steps 14 and 15 to register the device.

## Adding by Associating a PIN to an Authentication User Name

When the user name/password are authenticated by the access control function of a multifunctional device, a PIN can be associated with the user names that perform authentication. When a PIN is associated with a user name, the use restrictions associated with the PIN are enabled when that user name/password are used to login to the control panel, or when the user name/password are set in the device driver when printing is performed.



- **“Admin” cannot be specified as the user name.**
- **The same PIN can be associated with different user names.**

- 1 Refer to “Adding from the User” (P. 147) steps 1 to 6 to open the [Add User Name] window.
- 2 Select [Other Users] from [How to Specify User Name].

- 3 Select a PIN that is registered to the device from [Registered PIN], and enter the user name and password to be associated with the PIN.

#### 4 Configure the settings in [Restricted Items List].

For details on restriction items, see “Usage Limitations” (P. 143).



**Displayed items differ depending on the specifications of the device.**



## 5 Click [OK].

## 6 Refer to "Adding from the User" (P. 147) steps 14 and 15 to register the device.

## Adding Unregistered User Settings

Use restrictions can be set for user names that are not registered on the device.

## 1 Refer to "Adding from the User" (P. 147) steps 1 to 5 to open the [User Name] window.

## 2 Click [Edit].

## 3 Select [OtherLoginNames] from [Registered User Name List].

User Name/User Group Name	PIN	Type/Assigned Group Name
OtherLoginNames	0	Unregistered User
Local Print	1879048192	Reserved user

## 4 Configure the settings in [Restricted Items List].

For details on restriction items, see "Usage Limitations" (P. 143).



- Displayed items differ depending on the specifications of the device.
- When a user name that does not have an associated PIN is selected, items other than [Prohibit Printing] and [Prohibit Color Printing] cannot be configured.

## 5 Click [OK].

## 6 Specify the [Policy based printing] for determining the device user.

### [Determine User by PIN]

It is necessary to install the print job client software and configure the user ID on the print source client computer. ⇒ P. 41, P. 107

### [Determine users by user name.]

It is not necessary to install the print job client software because processing is performed with the user name.

## 7 Refer to "Adding from the User" (P. 147) steps 14 and 15 to register the device.

## Registering Roles

Use restrictions can be set for users by assigning roles to users.

## 1 Refer to steps 1 to 5 in "Adding from the User" (P. 147) to display the [User Name].

## 2 Click [Add Role].

### 3 Enter the [Role Name].

### 4 To set permissions, select the permission whose attribute you want to change in [Permissions list], select the attribute from [Attribute] and click [Change].

For details on permissions, see "Usage Limitations" (P. 143)



**Displayed items differ depending on the specifications of the device.**

### 5 To assign a user to a roll, select the user from [Local User List] and click [Add].

### 6 Click [OK].

### 7 Refer to steps 14 and 15 in "Adding from the User" (P. 147) to register the device.

## Setting LDAP Authentication

Configure settings for performing LDAP server authentication on the device.

- 1 Refer to steps 1 to 5 in "Adding from the User" (P. 147) to display the [User Name].
- 2 Click [LDAP authentication settings].

- 3 Specify the attribute information used for registering the user from the LDAP server to the device.

### [LDAP authentication settings]

Specify the LDAP Key of the user information to be registered to the device from the LDAP server.

### [Display Name]

Specify the LDAP Key of the display name.

### [E-mail Address]

Specify the LDAP Key of the e-mail address.

### [Language Code]

Specify the LDAP Key of the language code.

### [Group]

Specify the LDAP Key of the group.

### [IC card authentication LDAP Key settings]

Specify the LDAP Key of the IC card authentication information of the user to be registered to the device from the LDAP server.

### [IC Card Information]

Specify the LDAP Key of the IC card information.



### [PIN authentication LDAP Key settings]

Specify the LDAP Key of the user PIN to be registered to the device from the LDAP server.

#### [PIN]

Specify the LDAP Key of the PIN.

4 Enter the [LDAP Key] and [LDAP Value].

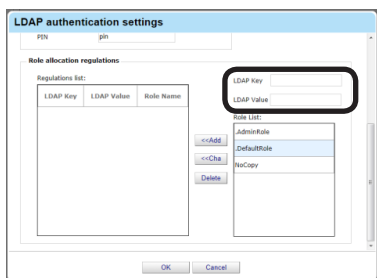

5 Select the role from the [Role List] and click [<<Add].

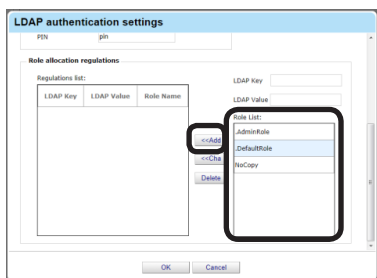

6 Click [OK].

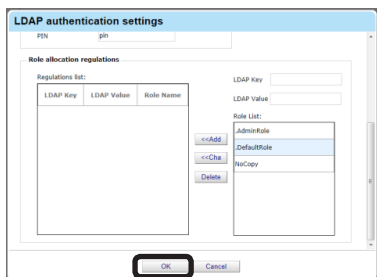

7 Refer to steps 14 and 15 in "Adding from the User" (P. 147) to register to the device.

## Setting Use Restrictions Targeted to the Document Name

If required, use restrictions can be set to the document name. Add the settings using one of the following methods.

- Adding from the Job Log
- Adding Manually

### Adding from the Job Log

Use restrictions can be set to the document names included in an acquired job log.

- 1 Configure from [Details Screen] > [Manage] > [Device Management Settings] > [Device Settings].

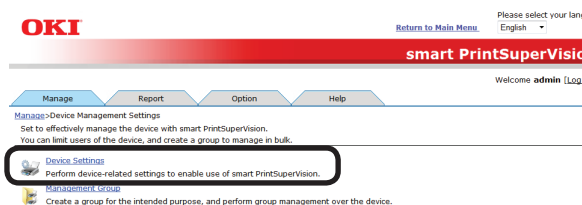

- 2 Select the device to configure from [Device].

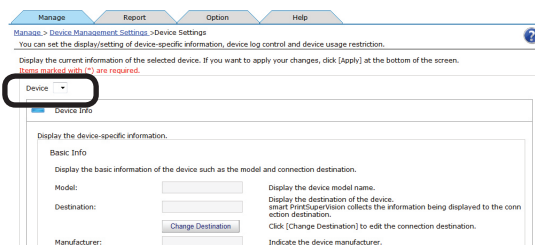

- 3 Click + in [Log/Access Control] to open the settings window.

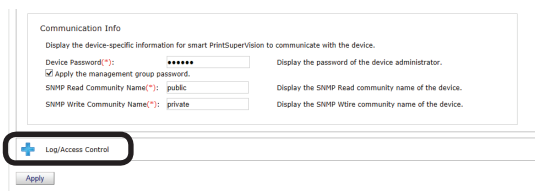

- 4 Check [Enable access control.], and set [Panel Access Control] and [User Auth. Method:].

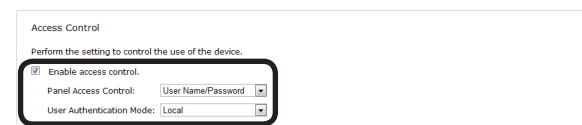

**[Panel Access Control]**  
**[User Name/Password]**

Enter the user name and password when logging in from the device panel.

**[PIN]**

Enter the PIN ID when logging in from the device panel.

**[Do not specify]**

Use the default device method when logging in from the device panel.

**[Invalidity]**

It is possible to disable the panel access control of the device and use the print restriction function.

**[User Auth. Method]**  
**[User Name/Password]**

This is enabled when [User Name/Password] is set in [Panel Access Control]. Specify from [Local], [LDAP] and [Secure Protocol].

**! Note**

- **Displayed items differ depending on the device.**
- **The settings in [Panel Access Control] cannot be changed while the device is acquiring the job log.**

5 Click **+** in [Document Name] to open the use restrictions setting window for [Document Name].

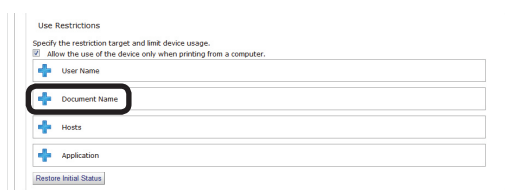

6 Click [Add].

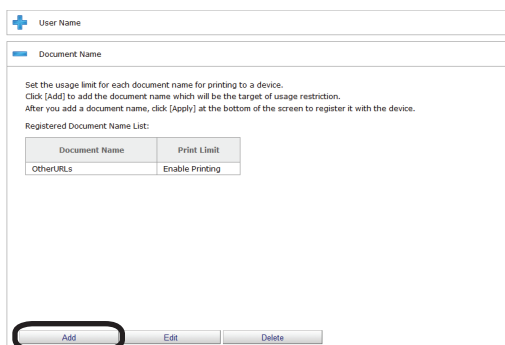

7 Select [Job Log] from [How to Specify Document Name].

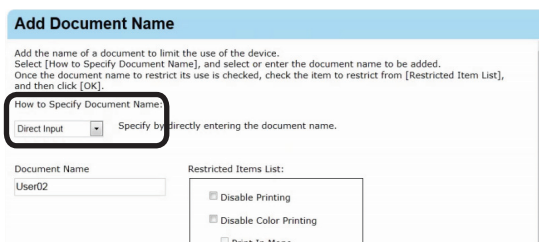

8 Enter the document name to add settings to in [Document Name].

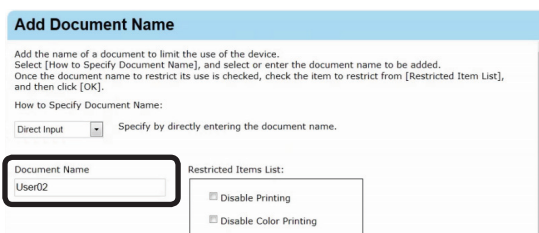

9 Configure the settings in [Restricted Items List].

For details on restriction items, see "Usage Limitations" (P. 143).

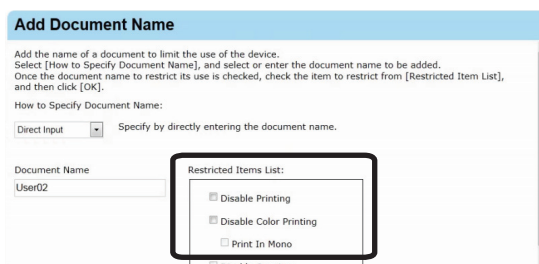

10 Click [OK].



11 Click [Apply].

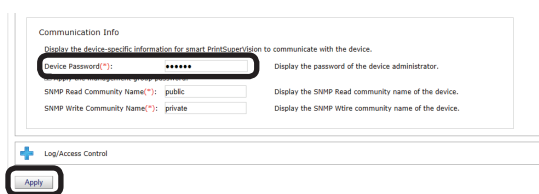

When the "Enter an administrator password for the device" window is displayed, open the [Device Info] input window, enter the administrator password for the device and click [Apply].



- Depending on the device, this may not be displayed.
- For details on the device's factory set administrator password, see the User's Manual of the device.

**12** Click [OK] in the confirmation window.

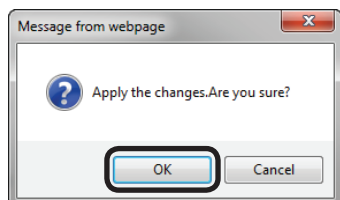

## Adding Manually

- 1 Refer to "Adding from the Job Log" (P. 155) steps **1** to **6** to open the [Add Document Name] window.
- 2 Select [Direct Input] from [How to Specify Document Name].

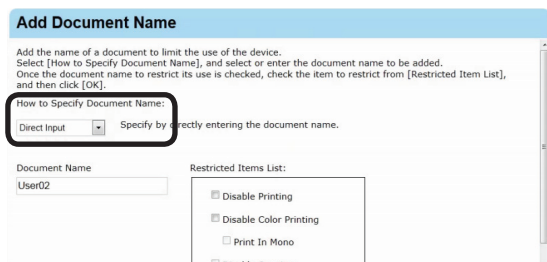

- 3 Select the document name to add settings from [Document Name].

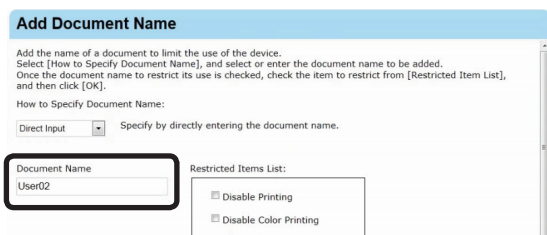

**\* (Asterisk) can be used as a wild card in the document name. However, items that are just \* or contain \*\* cannot be registered.**

- 4 Configure the settings in [Restricted Items List].

For details on restriction items, see "Usage Limitations" (P. 143).

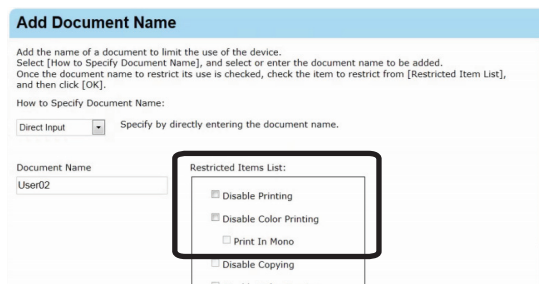

- 5 Click [OK].

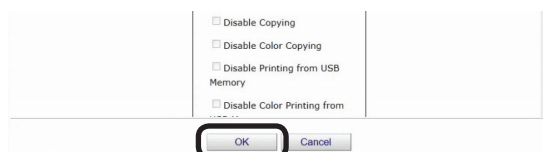

- 6 Refer to "Adding from the Job Log" (P. 155) steps **11** and **12** to register the device.

## Adding Unregistered Item Setting

Use restrictions can be set for document names that are not registered on the device.

- 1 Refer to "Adding from the Job Log" (P. 155) steps **1** to **5** to open the [Document Name] window.
- 2 Click [Edit].

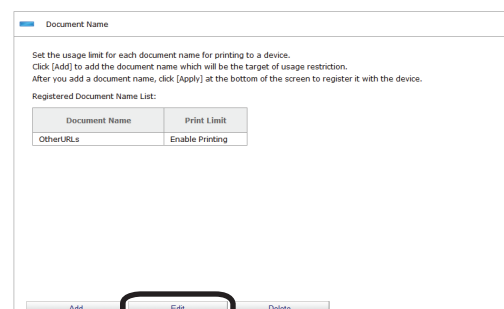

- 3 Select [Other URLs] from [Registered Document Name List].

**Edit Usage Restriction by Document Name**

Edit the restricted document name to limit the use of the device.  
Select the desired document name from [Registered Document Name List], and change the usage restriction.  
Select [OtherURLs] to set use restrictions for the document name not registered on the device.

Registered Document Name List:

Document Name	Print Limit
OtherURLs	Enable Printing

Restricted Items List:

- Disable Printing
- Disable Color Printing
- Print In Mono
- Disable Copying
- Disable Color Copying
- Disable Printing from USB Memory
- Disable Color Printing from

- 4 Configure the settings in [Restricted Items List].

For details on restriction items, see "Usage Limitations" (P. 143).

**Edit Usage Restriction by Document Name**

Edit the restricted document name to limit the use of the device.  
Select the desired document name from [Registered Document Name List], and change the usage restriction.  
Select [OtherURLs] to set use restrictions for the document name not registered on the device.

Registered Document Name List:

Document Name	Print Limit
OtherURLs	Enable Printing

Restricted Items List:

- Disable Printing
- Disable Color Printing
- Print In Mono
- Disable Copying
- Disable Color Copying

- 5 Click [OK].

Disable Copying

Disable Color Copying

Disable Printing from USB Memory

Disable Color Printing from USB Memory

Disable Scan to Email

Disable Scan To Shared Folders

OK Cancel

- 6 Refer to "Adding from the Job Log" (P. 155) steps 11 and 12 to register the device.

## Setting Use Restrictions Targeted to the Host Name

If required, use restrictions can be set to the host name. Add the settings using one of the following methods.

- Adding from the Job Log
- Adding Manually

### Adding from the Job Log

Use restrictions can be set to the host names included in an acquired job log.

- 1 Configure from [Details Screen] > [Manage] > [Device Management Settings] > [Device Settings].

**OKI** Return to Main Menu Please select your language English

**smart PrintSuperVision**

Welcome admin [Logout](#)

Manage Report Option Help

Manage > Device Management Settings

Set to effectively manage the device with smart PrintSuperVision.  
You can limit users of the device, and create a group to manage in bulk.

Device Settings

Perform device-related settings to enable use of smart PrintSuperVision.

Management Setup

Create a group for the intended purpose, and perform group management over the device.

- 2 Select the device to configure from [Device].

Manage Report Option Help

Manage > Device Management Settings > Device Settings

You can set the display/setting of device-specific information, device log control and device usage restriction.

Display the current information of the selected device. If you want to apply your changes, click [Apply] at the bottom of the screen.  
*These fields are required.*

Device

Device Info

Display the device-specific information.

Basic Info

Display the basic information of the device such as the model and connection destination.

Model:  Display the device model name.

Destination:  Display the destination of the device.  
smart PrintSuperVision collects the information being displayed to the connection destination.  
Click [Change Destination] to edit the connection destination.

Manufacturer:  Indicate the device manufacturer.

Change Destination

Communication Info

Display the device-specific information for smart PrintSuperVision to communicate with the device.

Device Password(\*):  Display the password of the device administrator.

Apply the management group password.

SNMP Read Community Name(\*): public Display the SNMP Read community name of the device.

SNMP Write Community Name(\*): private Display the SNMP Write community name of the device.

Log/Access Control

Apply

- 4 Check [Enable access control.], and set [Panel Access Control] and [User Auth. Method:].

Access Control

Perform the setting to control the use of the device.

Enable access control.

Panel Access Control:

User Authentication Mode:

**[Panel Access Control]**  
**[User Name/Password]**

Enter the user name and password when logging in from the device panel.

**[PIN]**

Enter the PIN ID when logging in from the device panel.

**[Do not specify]**

Use the default device method when logging in from the device panel.

**[Invalidity]**

It is possible to disable the panel access control of the device and use the print restriction function.

**[User Auth. Method]**

**[User Name/Password]**

This is enabled when [User Name/Password] is set in [Panel Access Control]. Specify from [Local], [LDAP] and [Secure Protocol].



- **Displayed items differ depending on the device.**
- **The settings in [Panel Access Control] cannot be changed while the device is acquiring the job log.**

5 Click **+** in [Hosts] to open the use restrictions setting window for [Hosts].

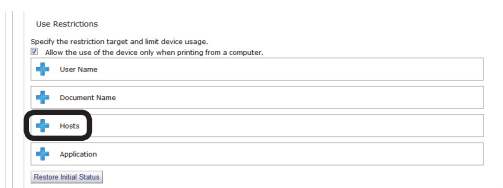

6 Click [Add].

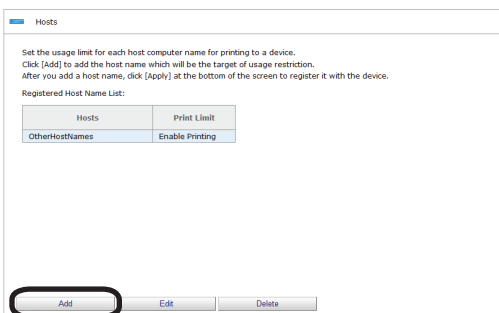

7 Select [Direct Input] from [How to Specify Host Name].

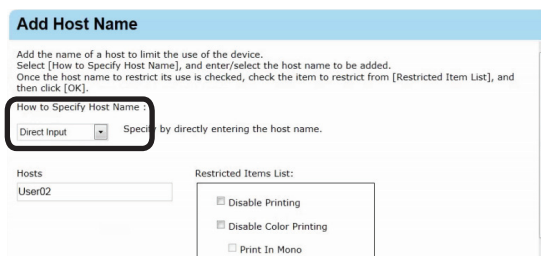

8 Enter the host name to add settings to in [Hosts].

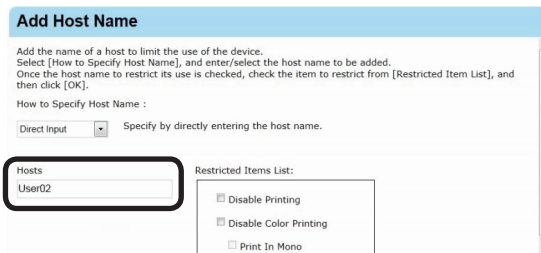

9 Configure the settings in [Restricted Items List].

For details on restriction items, see "Usage Limitations" (P. 143).

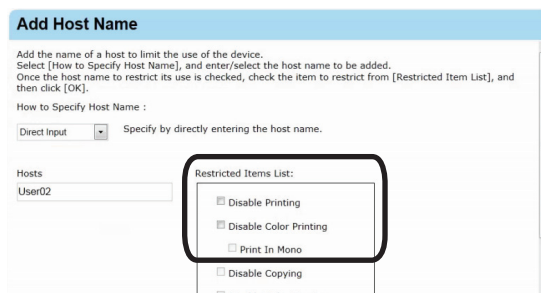

10 Click [OK].

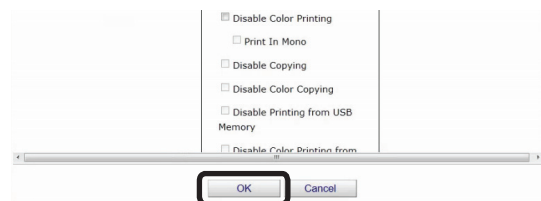

11 Click [Apply].

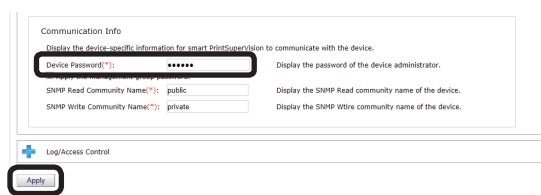

When the “Enter an administrator password for the device” window is displayed, open the [Device Info] input window, enter the administrator password for the device and click [Apply].



- Depending on the device, this may not be displayed.
- For details on the device’s factory set administrator password, see the User’s Manual of the device.

12 Click [OK] in the confirmation window.

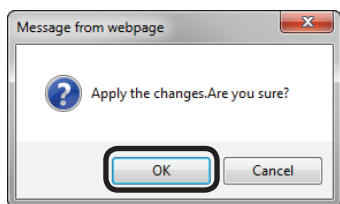

## Adding Manually

- 1 Refer to “Adding from the Job Log” (P. 158) steps 1 to 6 to open the [Add Host Name] window.
- 2 Select [Job Log] from [How to Specify Host Name].

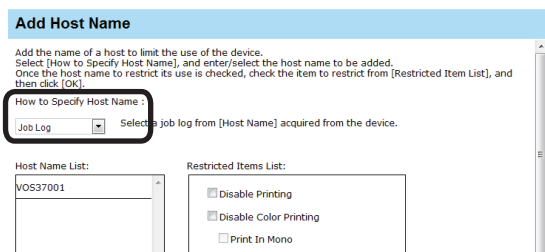

3 Select the host name to add settings to from [Host Name List].

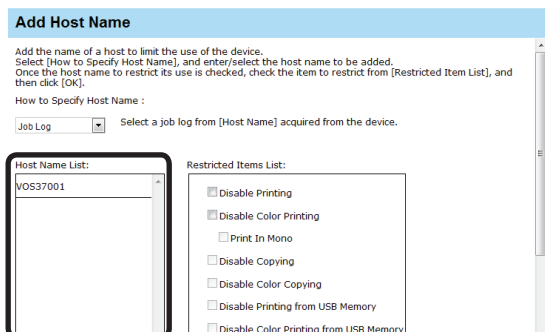

4 Configure the settings in [Restricted Items List].

For details on restriction items, see “Usage Limitations” (P. 143).

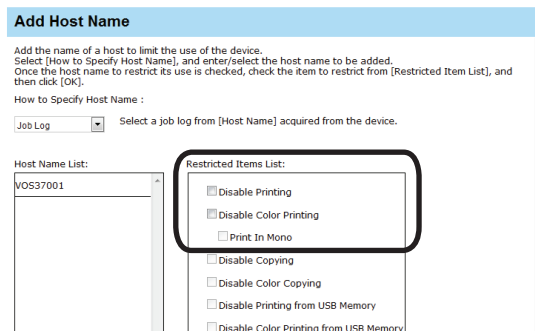

5 Click [OK].

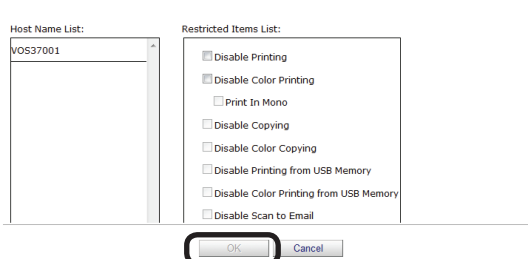

6 Refer to “Adding from the Job Log” (P. 158) steps 11 and 12 to register the device.

## Adding Unregistered Item Settings

Use restrictions can be set for hosts that are not registered on the device.

- 1 Refer to “Adding from the Job Log” (P. 158) steps 1 to 5 to open the [Hosts] window.
- 2 Click [Edit].

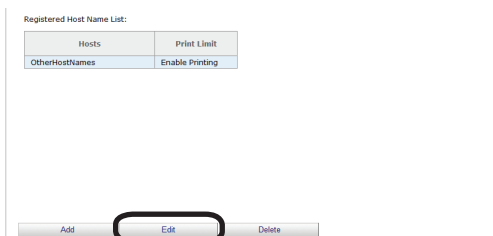



- 3 Select [OtherHostNames] from [Registered Host Name List].

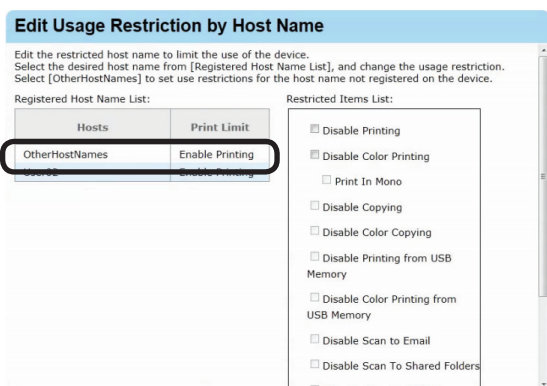

- 4 Configure the settings in [Restricted Items List].

For details on restriction items, see "Usage Limitations" (P. 143).

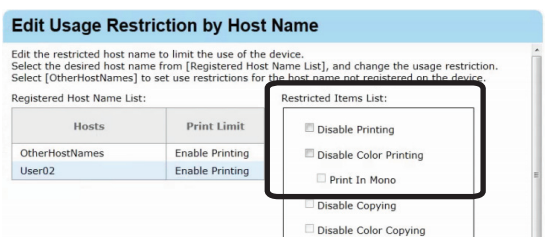

- 5 Click [OK].

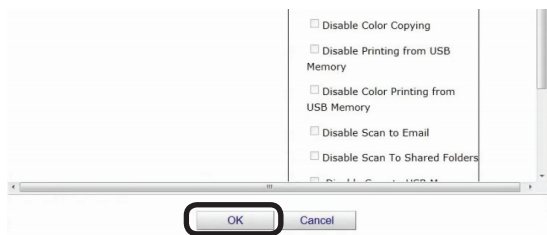

- 6 Refer to "Adding from the Job Log" (P. 158) steps 11 and 12 to register the device.

## Setting Use Restrictions Targeted to the Application Name

If required, use restrictions can be set to the application name. Add the settings using one of the following methods.

- Adding manually
- Adding from the job log

## Adding Manually

- 1 Configure from [Details Screen] > [Manage] > [Device Management Settings] > [Device Settings].

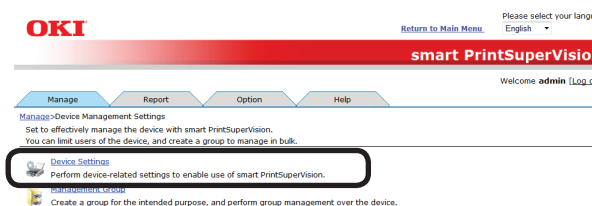

- 2 Select the device to configure from [Device].

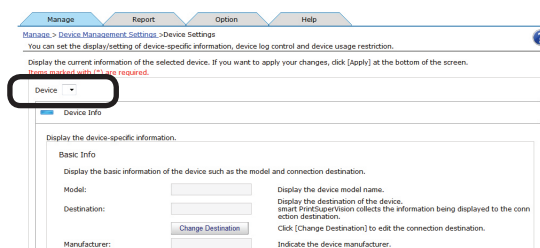

- 3 Click + in [Log/Access Control] to open the settings window.

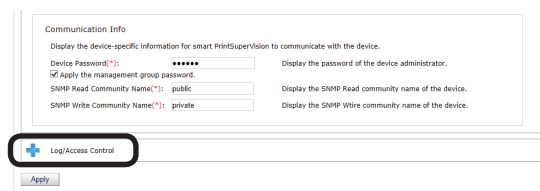

- 4 Check [Enable access control.], and set [Panel Access Control] and [User Auth. Method:].



- Depending on the device, some items may not be displayed.
- Depending on the used application, a space may be included in the application name. When the application name is specified using [Direct Input] and the restrictions are not enabled, select and register the application name that you want to restrict in [Job Log].

5 Click **+** in [Application] to open the use restrictions setting window for [Application].

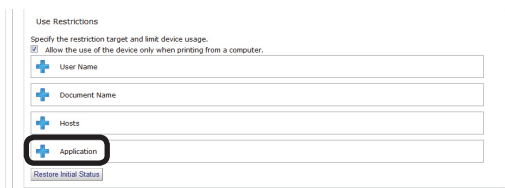

6 Click [Add].

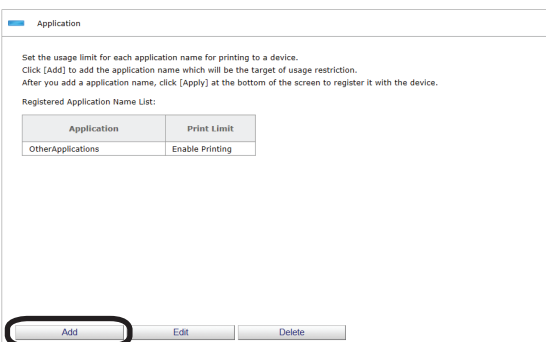

7 Select [Direct Input] from [How to Specify Host Name].

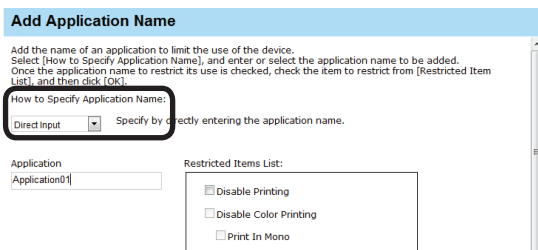

8 Enter the application name to which settings are to be added in [Application].

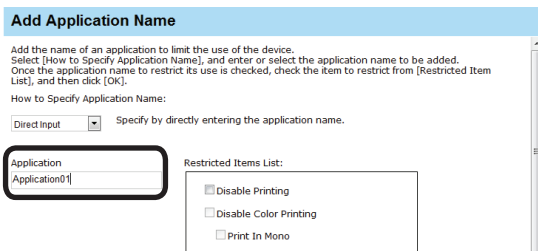

9 Configure the settings in [Restricted Items List].

For details on restriction items, see "Usage Limitations" (P. 143).

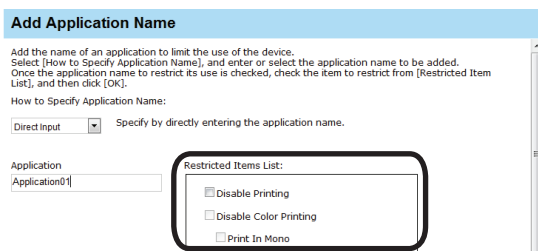

10 Click [OK].

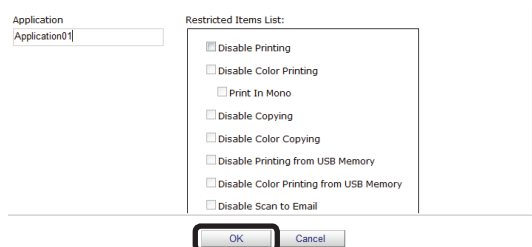

11 Click [Apply].

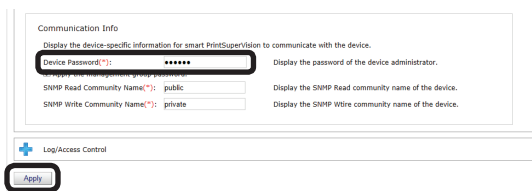

When the "Enter an administrator password for the device" window is displayed, open the [Device Info] input window, enter the administrator password for the device and click [Apply].

**Note**

- Depending on the device, this may not be displayed.
- For details on the device's factory set administrator password, see the User's Manual of the device.

12 Click [OK] in the confirmation window.

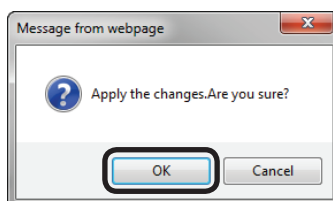

### Adding from the Job Log

Use restrictions can be set to the application names included in an acquired job log.

- 1 Refer to "Adding Manually" (P. 161) steps 1 to 6 to open the [Add Application Name] window.



- 2 Select [Job Log] from [How to Specify Application Name].

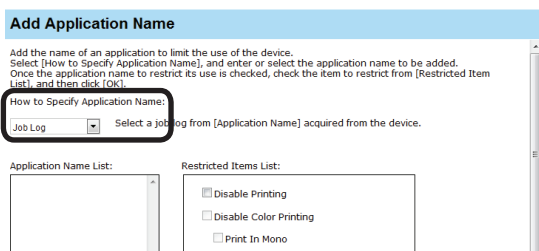

- 3 Select the application that you want to add settings to from [Application Name List].

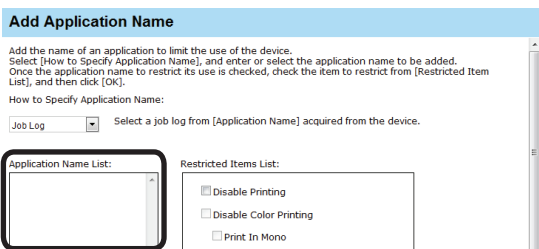

- 4 Configure the settings in [Restricted Items List].

For details on restriction items, see "Usage Limitations" (P. 143).

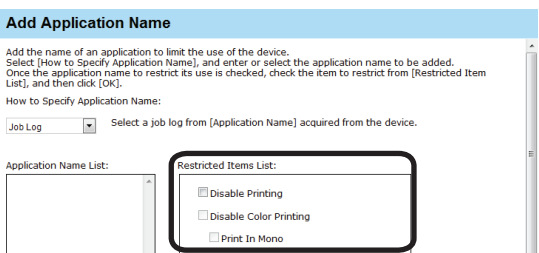

- 5 Click [OK].

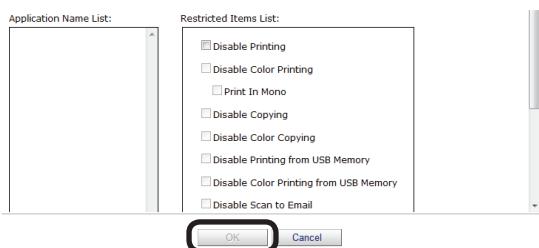

- 6 Refer to "Adding Manually" (P. 161) steps 11 and 12 to register the device.

## Adding Unregistered Item Settings

Use restrictions can be set for application names that are not registered on the device.

- 1 Refer to "Adding Manually" (P. 161) steps 1 to 5 to open the [Application] window.
- 2 Click [Edit].

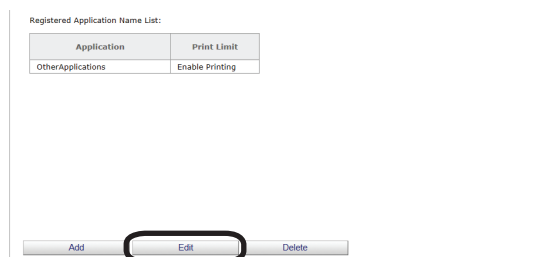

- 3 Select [OtherApplications] from [Registered Application Name List].

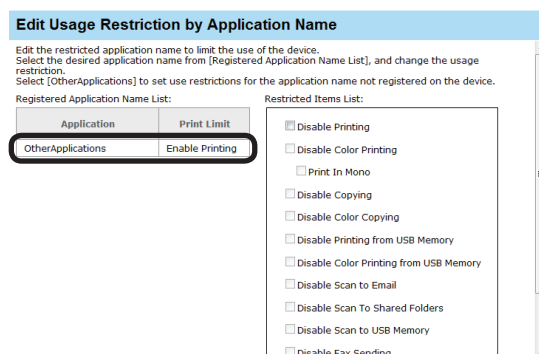

- 4 Configure the settings in [Restricted Items List].

For details on restriction items, see "Usage Limitations" (P. 143).

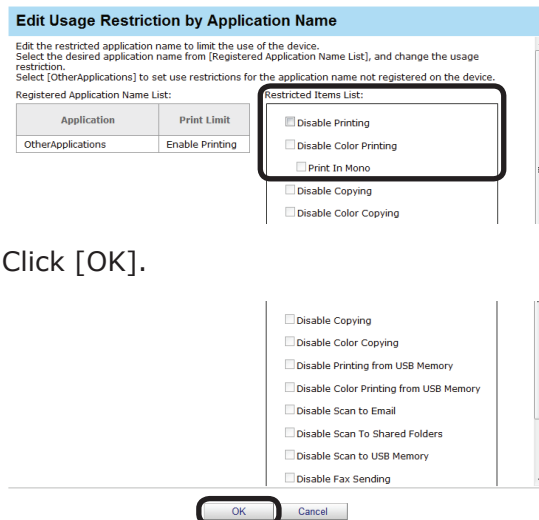

- 5 Click [OK].

- 6 Refer to "Adding Manually" (P. 161) steps 11 and 12 to register the device.

# Displaying Device Registered Use Restrictions

- 1 Check the registered use restrictions in [Details Screen] > [Manage] > [Device Management Settings] > [Device Settings].

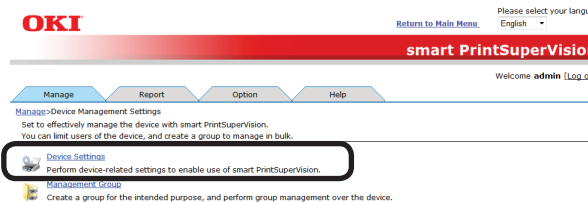

- 2 Select the device to check from [Device].

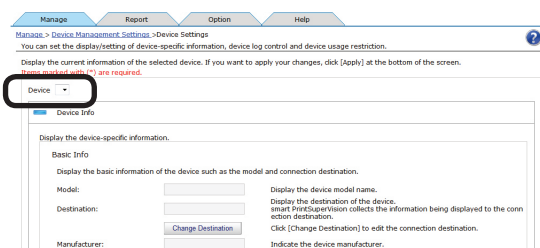

- 3 Click + in [Log/Access Control] to open the settings window.

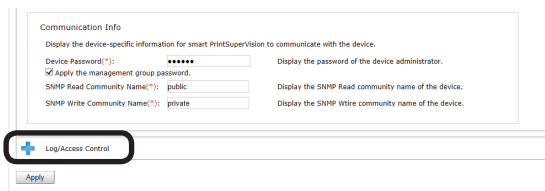

- 4 Click + of the item ([User Name], [Document Name], [Hosts], [Application]) to display to open the use restrictions window.

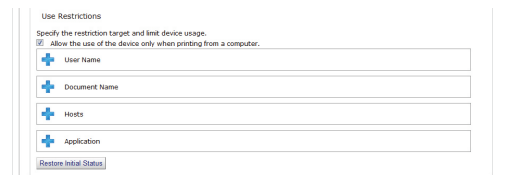

- 5 The registered use restrictions are displayed in the use restrictions list.

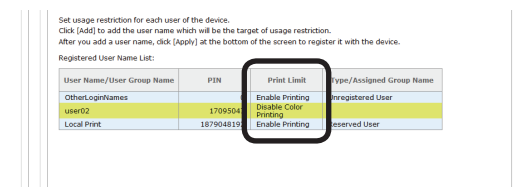

# Changing Device Registered Use Restrictions

Device registered usage restrictions can be changed.

- 1 Change the registered use restrictions in [Details Screen] > [Manage] > [Device Management Settings] > [Device Settings].

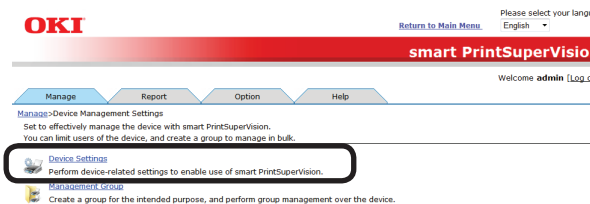

- 2 Select the device to change from [Device].

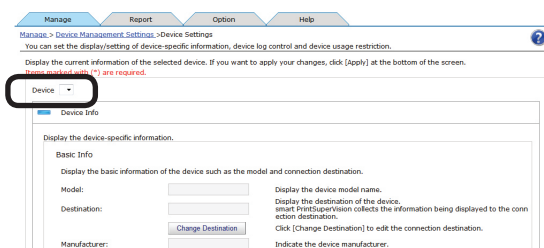

- 3 Click + in [Log/Access Control] to open the settings window.

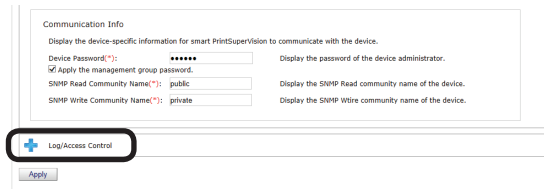

- 4 Click + of the item ([User Name], [Document Name], [Hosts], [Application]) to change to open the use restrictions window.

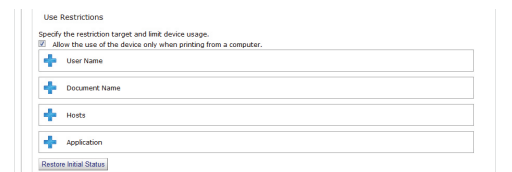

5 Check [Enable access control], and set [Panel Access Control] and [User Auth. Method:].



**Note**

Depending on the device, some items may not be displayed.

6 Click [Edit].

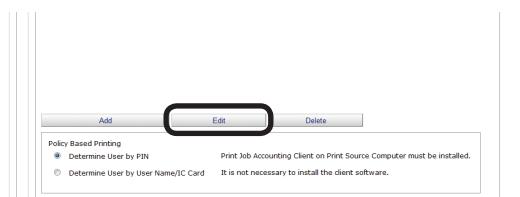

7 Select the item ([User Name], [Document Name], [Hosts], [Application]) to change from the list display and change the use restrictions using [Restricted Items List].

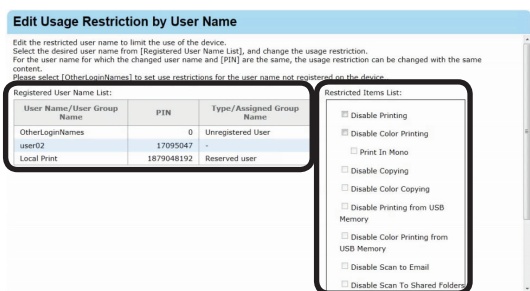

8 Click [OK] to close the dialog box.

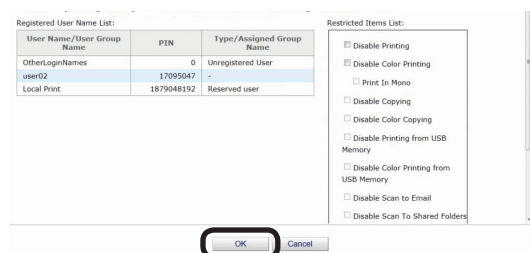

9 Click [Apply].

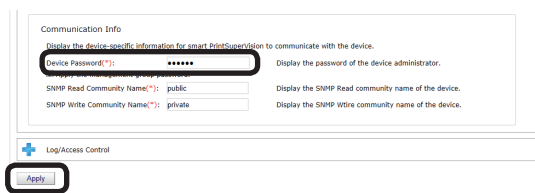

When the “Enter an administrator password for the device” window is displayed, open the [Device Info] input window, enter the administrator password for the device and click [Apply].

**Note**

- Depending on the device, this may not be displayed.
- For details on the device’s factory set administrator password, see the **User’s Manual of the device**.

10 Click [OK] in the confirmation window.

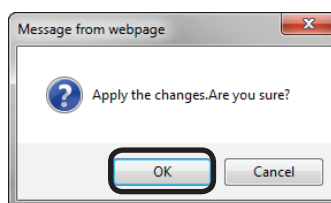

# Delete Device Registered Use Restrictions

## Deleting Individual Use Restrictions

Delete device registered use restrictions individually.

- 1 Check the use restrictions to be individually deleted in [Details Screen] > [Manage] > [Device Management Settings] > [Device Settings].

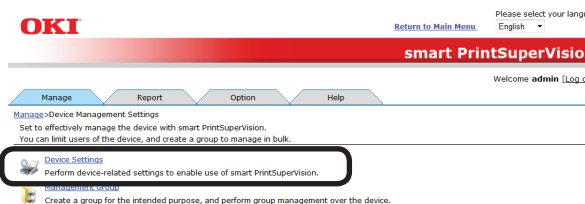

- 2 Select the device from which to delete the use restrictions from [Device].

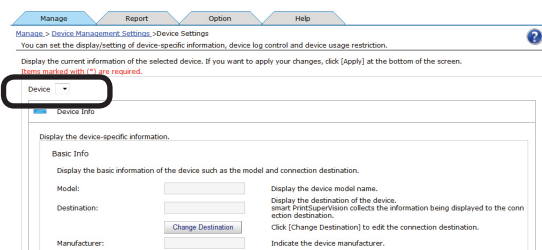

- 3 Click **+** in [Log/Access Control] to open the settings window.

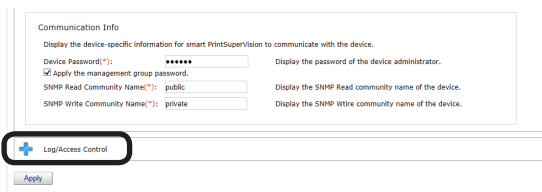

- 4 Click **+** of the item ([User Name], [Document Name], [Hosts], and [Application]) to delete to open the use restrictions window.

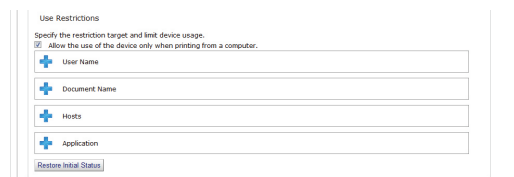

- 5 The registered use restrictions are displayed in the list display of the item.

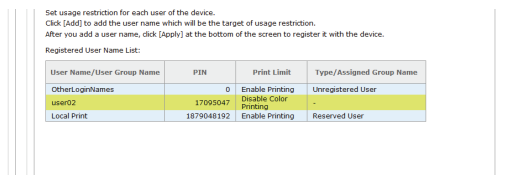

- 6 Select the item to delete ([User Name], [Document/User Group Name], [Hosts], and [Application]) from the list display and click "Delete". The selected item is deleted from the list display.

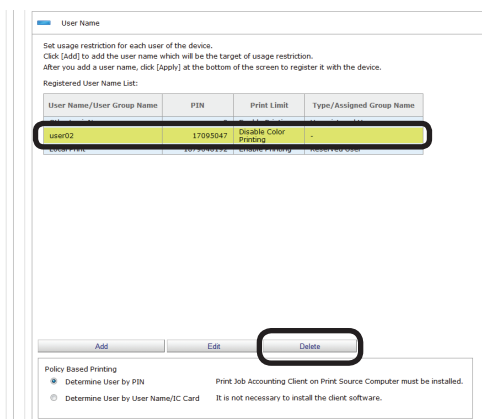

- 7 Click [OK] in the confirmation window.



- 8 Click [Apply].

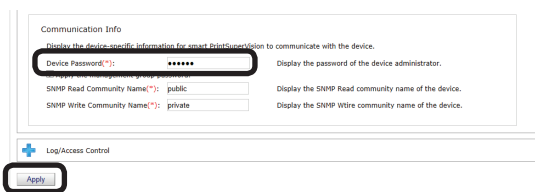

When the "Enter an administrator password for the device" window is displayed, open the [Device Info] input window, enter the administrator password for the device and click [Apply].

**! Note**

- Depending on the device, this may not be displayed.
- For details on the device's factory set administrator password, see the User's Manual of the device.

9 Click [OK] in the confirmation window.

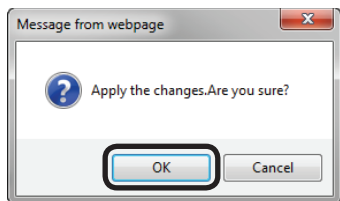

**Note**

**Unregistered information such as OtherLoginNames, OtherURLs, or Other HostNames cannot be deleted.**

## Deleting All Use Restrictions (Restoring Initial Status)

All of the use restrictions set for the user name, document name, hosts and applications can be deleted.

1 Check the use restrictions to be batch deleted in [Details Screen] > [Manage] > [Device Management Settings] > [Device Settings].

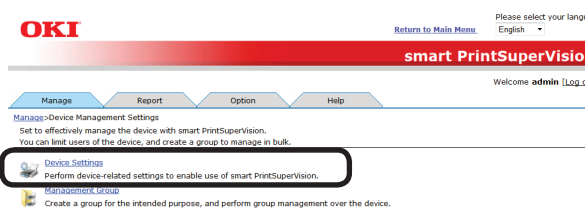

2 Select the device from which to delete the use restrictions from [Device].

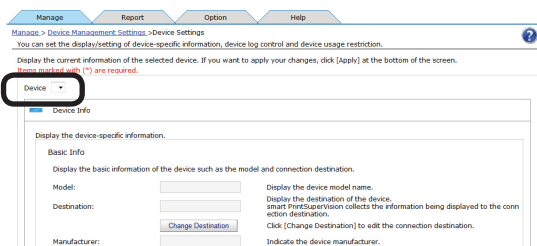

3 Click **+** in [Log/Access Control] to open the settings window.

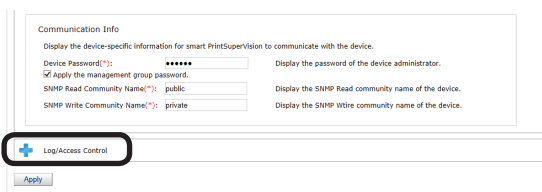

4 Click "Restore Initial Status".

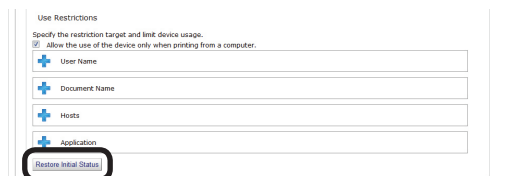

5 Click [OK] in the confirmation window.

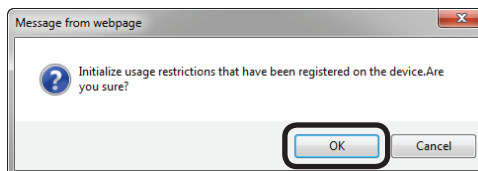

6 Click [Apply].

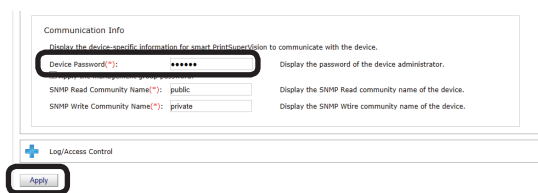

When the "Enter an administrator password for the device" window is displayed, open the [Device Info] input window, enter the administrator password for the device and click [Apply].

**Note**

- Depending on the device, this may not be displayed.
- For details on the device's factory set administrator password, see the User's Manual of the device.

7 Click [OK] in the confirmation window.

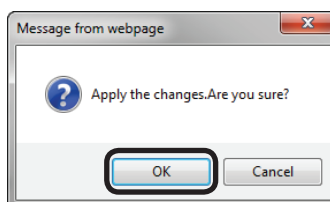

**Note**

**Unregistered information such as OtherLoginNames, OtherURLs, OtherHostNames, or OtherApplications cannot be deleted. Temporarily Disabling Use Restrictions**

## Temporarily Disabling Use Restrictions

Use restrictions can be temporarily disabled.



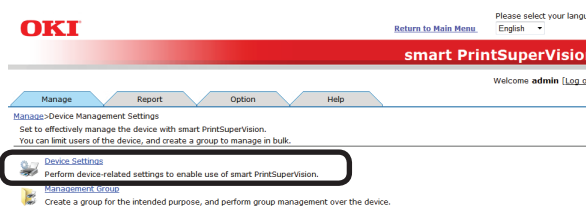

The use restrictions set for the PIN for printing jobs from a PC are also disabled.

- 1 Disable the use restrictions in [Details Screen] > [Manage] > [Device Management Settings] > [Device Settings].

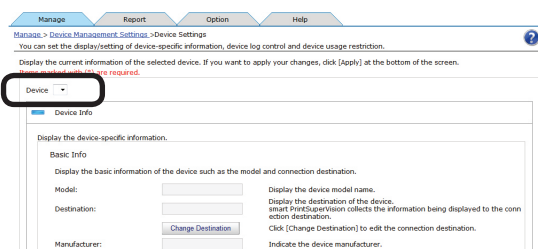

- 2 Select the device whose user restrictions are to be disabled from [Device].



- 3 Click  in [Log/Access Control] to open the settings window.

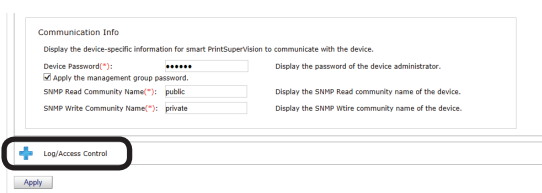

- 4 Remove the check from [Enable access control].



- 5 When a confirmation message is displayed, click [Cancel].

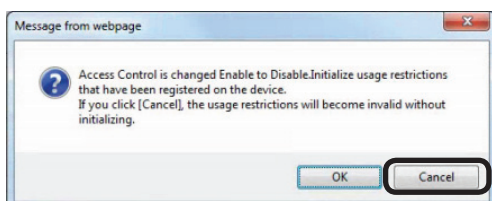

- 6 Click [Apply].

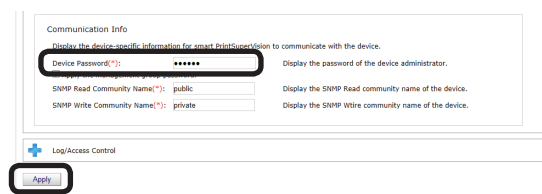

When the “Enter an administrator password for the device” window is displayed, open the [Device Info] input window, enter the administrator password for the device and click [Apply].



- Depending on the device, this may not be displayed.
- For details on the device’s factory set administrator password, see the User’s Manual of the device.

- 7 Click [OK] in the confirmation window.

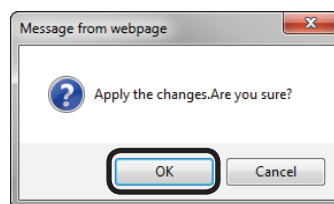

## Enabling Use Restrictions

Use restrictions that were temporarily disabled can be enabled again.

- 1 Refer to “Unregistered information such as OtherLoginNames, OtherURLs, OtherHostNames, or OtherApplications cannot be deleted. Temporarily Disabling Use Restrictions” (P. 167) steps 1 to 3 to display the [Log Control/Access Control] window.

- 2 Check [Enable access control].



- 3 Refer to “Unregistered information such as OtherLoginNames, OtherURLs, OtherHostNames, or OtherApplications cannot be deleted. Temporarily Disabling Use Restrictions” (P. 167) steps 6 and 7 to register the device.

# 10. Managing Available Usage

---

What can be done with available usage .....	170
Setting the Available Usage .....	170
Changing the Priority Level of User Group.....	171
Creating Fee Charge Definitions .....	172
Setting Fee Definitions for Devices .....	176
Changing Fee Charge Definitions .....	177
Deleting Fee Charge Definitions .....	178
Checking and Resetting Usage Statuses .....	178
Sending Print Prohibited/Permitted by Mail .....	179



# 10. Managing Available Usage

## What can be done with available usage

Available usage (maximum values) can be set for users and user groups registered in sPSV. Printing is prohibited for users who have exceeded their available usage.

Usage is counted by the number of sheets printed or by fees (defined according to factors such as the paper size for printing).



**The window and setting contents differ depending on the device model.**

## Setting the Available Usage

Set available usage for users and user groups registered to sPSV.

Printing is prohibited when the total usage of a set user or user group exceeds the available usage.



**When setting available usage for user groups, the same settings are applied for the users that belong to that group. However, available usage can also be set for specific users or user groups that belong to the user group.**

- 1 Set the information from [Details Screen] > [Option] > [User Settings].

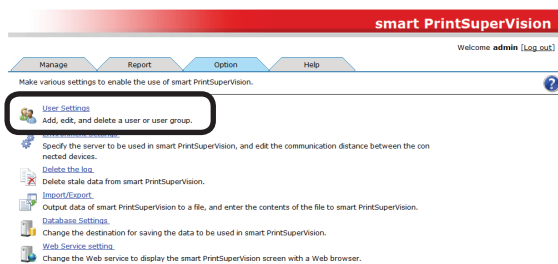

- 2 Click the user or user group in [User List].

No.	User Name / User Group Name	Type	PIN	Display Name	User Group
1	admin	Local User			admins
2	user01	Local User	17092760		usergroup01
3	user02	Local User	17095047		
4	user03	Local User	17093833		usergroup02
5	admins	Local Group			
6	usergroup01	Local Group			
7	usergroup02	Local Group			

Update Confirmation    Delete

• Add a user / user group.  
 • Change the priority of a user group.  
 • Create a user correspondence table.  
 • Create an IC card correspondence table.

- 3 Click in [Available Usage].

- 4 Set available usage for each item.

If one of these available usage values is exceeded, printing is canceled for the remainder of the period set in [Reset Usage Interval].



**The available usage settings are enabled from the point at which sPSV obtains the log when the available usage has been exceeded. Printing can still be performed when the available usage is exceeded until sPSV receives the log.**

### [Printed Sheets]

Check this to set the number of sheets that can be printed.

### [Fees]

Check this to set the maximum fee that can be occurred.



**[Staple]**

When the optional finisher is installed, check this to set the number of times that the stapler can be used.

**[Include the total usage of the assigned user group.]**

Check this to manage use restrictions according to the available usage.

**[Reset Usage Interval]**

Set the interval at which to reset the used volume.

**[Unit]**

Select the time unit of the reset interval.

- [Do not specify]
- [Month]
- [Week]
- [Day]

**[Duration]**

Specify the duration in hours. This is enabled when [Month], [Week] or [Day] is selected for [Unit]. (1-99)

**[Reference Date]**

Select the reference date to perform a reset. This is enabled when [Month], [Week] or [Day] is selected for [Unit]. (1-99)

- If [Month] is selected: [To the end of the month]/[Up to 10 Days]/[Up to 20 Days]/[To closing date]
- If [Week] is selected: [To Sunday]/[To Monday]/[To Tuesday]/[To Wednesday]/[To Thursday]/[To Friday]/[To Saturday]

**[Carry over to the next time.]**

If this is checked, available usage time remaining at the time of reset is added to the available usage for the next period.

When the [Carry over to the next time.] check box is checked, and the available usage value is not exceeded, the unused amount can be carried over to the next valid period.

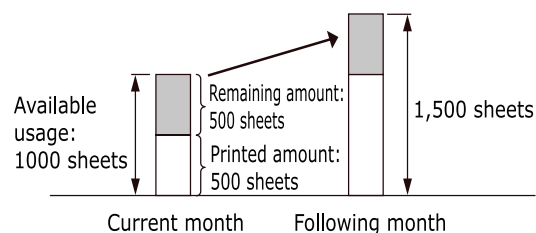
**[Notification Conditions]**

Set conditions for notifications of usage status.

Notifications are sent to the email address registered in [General].

**[If available usage is exceeded]**

Check this to receive a notification by email if the available usage is exceeded.

**[When you reset the usage]**

Check this to receive a notification by email if the available usage is reset.

**[X days before next reset date]**

Check this and enter a numerical value to receive a notification by email the specified number of days before the next reset date.

**5** Click [Apply].



**The available usage value is taken as that from the user group with the highest priority level. See “Changing the Priority Level of User Group” (P. 171) for information on priority levels of user groups.**

**Changing the Priority Level of User Group**

When users that are set with available usage belong to multiple user groups, the priority level at which available usage for user groups are applied to users can be changed. The available usage of the highest priority level user group are assigned to the user.

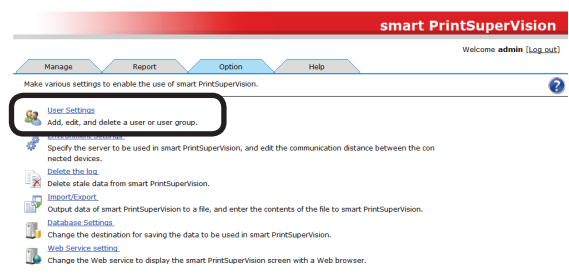
**1** Change the information from [Details Screen] > [Option] > [User Settings].

## 2 Click [Change the priority of a user group].

No.	User Name/User Group Name	Type	PIN	Display Name	User Group
1	admin	Local User			admins
2	user01	Local User	17092760		usergroup01
3	user02	Local User	17095047		
4	user03	Local User	17093833		usergroup02
5	admin	Local Group			
6	usergroup01	Local Group			
7	usergroup02	Local Group			

Update Confirmation Delete

Change the priority of a user group.

Assign a user to a user group.

Create an IC card correspondence table.

## 3 Select a user group from [User Group Name] and click or to change the order.

Manage Report Option Help

Option > User Settings > Change the priority of a user group.  
If a user is assigned to multiple user groups, apply the available amount to the user group with the highest priority.

Name	Type	Description
admins	LocalGroup	
usergroup01	LocalGroup	
usergroup02	LocalGroup	

Apply

## 4 Click [Apply].



**The priority order settings are applied to all users that belong to the user group.**

# Creating Fee Charge Definitions

“Fees” refers to the unit prices set for items such as paper and consumables for the purposes of totaling output costs.

Detailed fees can be defined in sPSV according to information such as the number of printed sheets and the paper size. Printing can be prohibited for users who have exceeded the available usage set according to the defined fees.

## 1 Configure the settings from [Details Screen] > [Manage] > [Billing Amount Settings].

OKI Return to Main Menu English

**smart PrintSuperVision**

Welcome admin (Logout)

Manage Report Option Help

Set/Manage the registered device to confirm the usage status, or to restrict the usage.

Device List  
Display a list of the devices.

Register Device  
Search the connected devices via network, and register to smart PrintSuperVision.

Device Management Settings  
Perform device-related settings to enable use of smart PrintSuperVision.

**Billing Amount Settings**  
Perform pre-settings for managing the cost of the device.

## 2 Select a registered definition from [Fees].

When creating a new definition, enter a name for the definition in [Name].



**The initial settings definition shows a rough guide to the running costs calculated from the standard prices of various consumables and the number of prints.**

Fees: [09310341]

Contents of Billing Amount Settings:  
Items marked with (\*) are required.

Name (\*): Cost The name of the registered billing amount settings. (Up to 32 characters)

In (Fees) under [Job Info], the checked total cost is displayed.

Paper

Specify the print billing amount per print or per page.

Include in the billing amount the quantity of printed pages of the job information.

Specify the cost in accordance with each print pattern.

Color Printing Cost  Represent the cost per page when printing in color.

Mono Printing Cost  Represent the cost per page when printing in mono.

- 3 Click  for the item to be configured to open the settings window.

## [Pages]

The cost of one print and one page based on the total number of prints and print pages can be set. Print pages can be set separately for [Color] printing, [Mono] printing, [Spot Color 1] printing and [Spot Color 2] printing.

- Check [Include in the billing amount the quantity of printed pages of the job information.] and enter cost values per print page for [Color Printing Cost], [Mono Printing Cost], [Spot color 1 Printing Cost] and [Spot color 2 Printing Cost].
- Check [Include in the billing amount the quantity of printed sheets of the job information.] and enter the cost per print page.

## [Toner use amount]

Set to include the toner use amount in the fees.

- If including the toner use amount in the fee, check [Include in the billing amount the quantity of toner usage of the job information.] and set the cost per page for each toner use amount level.

- To set the cost per page for each level, select the level for which to set this and click the [Change] button.

In the cost change screen, enter the cost per page in the [Color Fee], [Mono Fee], [White Cost] and [Clear Cost] fields and click [OK].

### Change

Color Cost	<input type="text" value="0"/>
Mono Cost	<input type="text" value="0"/>
White Cost	<input type="text" value="0"/>
Clear Cost	<input type="text" value="0"/>

OK

Cancel

- (3) If automatically calculating fees, enter the color toner price in the [Color Price] field, the mono toner price in the [Mono Price] field, the white toner price in the [White Price] field and the clear toner price in the [Clear Price] field and then click [Auto Calculation].

- (4) Set the life values.

Automatically calculating from life values acquired from devices:

Select the device for which to use auto calculation from [Auto Calculation Device] and check [Use the device life value].

Automatically calculating from manually entered life values for devices:

Remove the check from [Use the device life value], as the device for which to use auto calculation does not need to be selected from [Auto Calculation Device].

Enter values in the [Color Life], [Mono Life], [White Life] and [Clear Life] fields and click [Auto Calculation].

- (5) If calculating automatically from life values acquired from devices, a message saying [Acquire toner life values set in the current device for calculation?] appears. Check that the power of the device is turned on and click [OK]. When [Cancel] is clicked or if information cannot be obtained from the device, the values entered in [Setting life] are used for the automatic calculation.

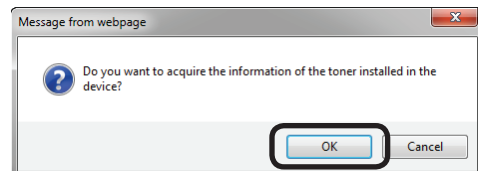

See “Checking the Consumable Life” (P. 183) for information on the toner use amount level.

## [Drum use amount]

Set to include the drum use amount in the fees.

- (1) If including the drum use amount in the fees, check [Include in the billing amount] the usage of drum of the job information.] and then enter the color drum use cost per A4/letter size page in the [Color Fee] field, the mono drum use cost per A4/letter size page in the [Mono Fee] field, the white drum use cost per A4/letter size page in the [White Cost] field and the clear drum use cost per A4/letter size page in the [Clear Cost] field.

- (2) If acquiring device information for automatic calculation of fees, select the device to be used for automatic calculation from [Auto Calculation Device], enter the color drum price in the [Color Price] field, the mono drum (or 4-in-one color drum) price in the [Mono Price] field, the white drum price in the [White Price] field and the clear drum price in the [Clear Price] field, and then click [Auto Calculation].



**For 4 color combined unit drums, the [Color Fee] and [Color Price] fields cannot be entered.**

### [Belt/fuser use amount]

Set to include the amount of belt and fuser used in the fees.

- (1) If including the amount of belt and fuser used in the fees, check [Include in the billing amount the paper size of the job information.] and enter the belt use cost per A4/letter size page in the [Belt Fee] field and the fuser use cost per A4/letter size page in the [Fuser Fee] field.

- (2) If acquiring device information for automatic calculation of fees, select the device to be used for automatic calculation from [Auto Calculation Device], enter the belt price in the [Belt Price] field and the fuser price in the [Fuser Price] field and click [Auto Calculation].

### [Paper Size]

Costs can be set for 1 page of each paper size. Fees can also be applied just to specific sizes.

Paper Size	Cost
Other Size	0
A4	0
A5	0
A6	0
B4	0
B5	0
Letter	0
Legal14	0
Legal15	0
Legal13	0

To set fees per page for each paper size, check [Include in the billing amount the paper size of the job information.] and enter the cost of each paper size.



**A4, A4 wide (SRA4), B5, letter, 16K 184×260mm, 16K 195×270mm and 16K 197×273mm are different paper sizes with longitudinal feed and cross feed. When cross feed is used, add A4 horizontal, A4 wide (SRA4) horizontal, B5 horizontal, A5 horizontal, letter horizontal, 16K 184×260mm horizontal, 16K 195×270mm horizontal, and 16K 197×273mm horizontal.**

## [Media Type]

Costs can be set for 1 page of each paper type. Fees can also be applied just to specific paper types.

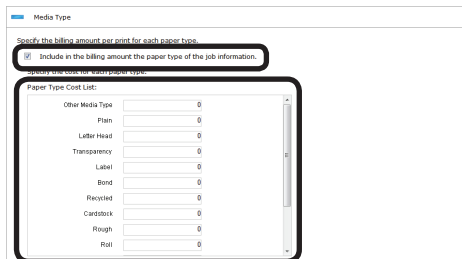

To set fees per page for each paper type, check [Include in the billing amount the paper type of the job information.] and enter the cost of each paper type.

## [Tray]

Costs can be set for 1 page from each used tray. Fees can also be applied just to specific trays.

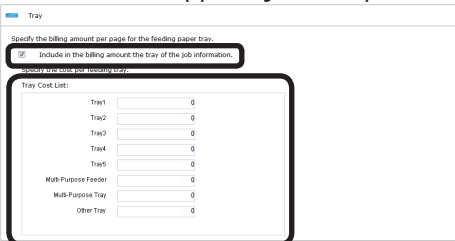

To set fees per page for each tray, check [Include in the billing amount the tray of the job information.] and enter the cost of each tray.

## [Finisher]

When the optional finisher is installed, set the cost for each time that the stapler is used.



If including the cost for each time that the stapler is used in the fees, check [Include in the billing amount the stapler of the job information.] and enter the cost.

4 Click [Apply].



## Setting Fee Definitions for Devices

1 Set from [Details Screen] > [Manage] > [Device Management Settings] > [Device Settings].

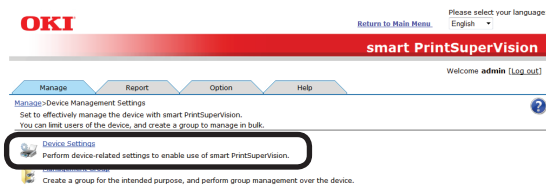

2 Select the device from which to acquire the job log in [Device].

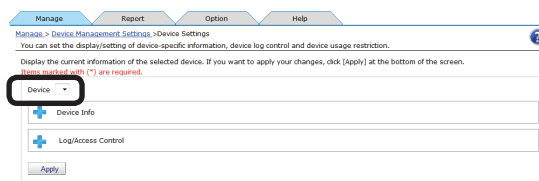

3 Click + in [Device Info] to open the settings window.

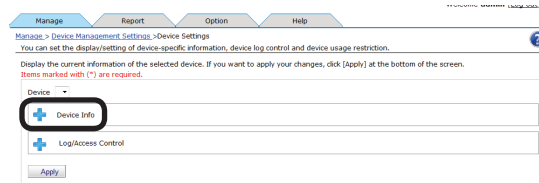

4 Select the fee definition to be used from [Fees].

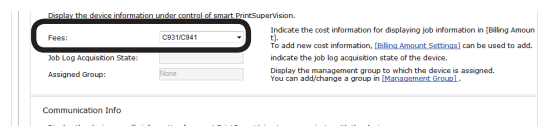

5 Click [Apply].

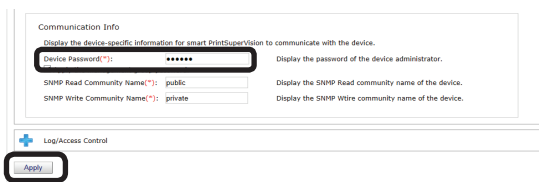

When the "Enter an administrator password for the device" window is displayed, open the [Device Info] input window, enter the administrator password for the device and click [Apply].



- Depending on the device, this may not be displayed.
- For details on the device's factory set administrator password, see the User's Manual of the device.

6 Click [OK] in the confirmation window.

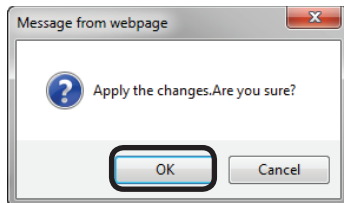

## Changing Fee Charge Definitions

- 1 Change the settings from [Details Screen] > [Manage] > [Billing Amount Settings].

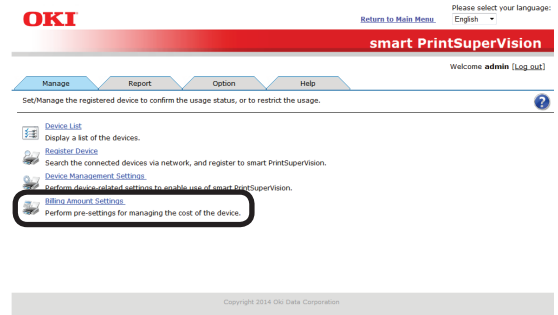

- 2 Select the definition to be changed from [Fees] and click [Apply].

For details on settings, see "Creating Fee Charge Definitions" (P. 172).



**When the name is changed, it is registered as a new definition. The previous settings remain under the former definition name.**

## Deleting Fee Charge Definitions

- 1 Delete the settings from [Details Screen] > [Manage] > [Billing Amount Settings].

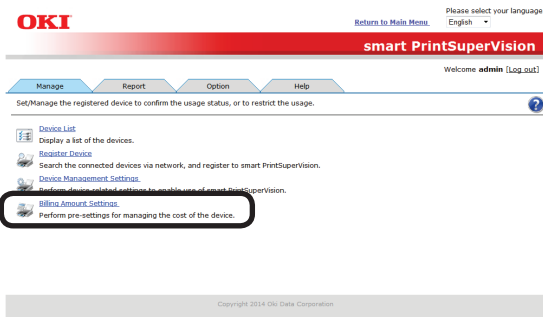

- 2 Select the definition to be deleted from [Fees] and click [Delete].

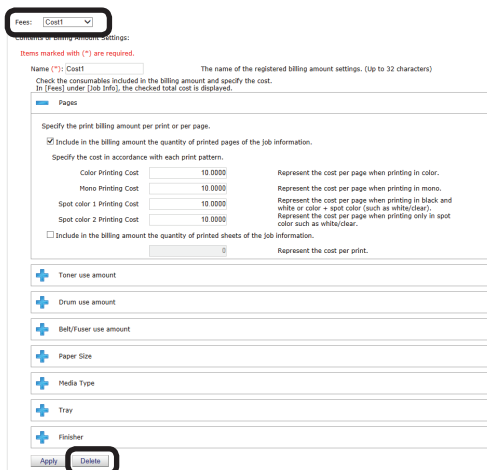

- 3 Click [OK] in the confirmation window.

### Check

Delete the settings of billing amount being edited. Are you sure?



## Checking and Resetting Usage Statuses



**To check or reset usage statuses including job logs remaining in the device, display the [Details Screen] > [Report] > [Display Report] > [Job Information], check [Acquire the device status before the job.] and click [View] to acquire the job log.**

- 1 Set the information from [Details Screen] > [Option] > [User Settings].

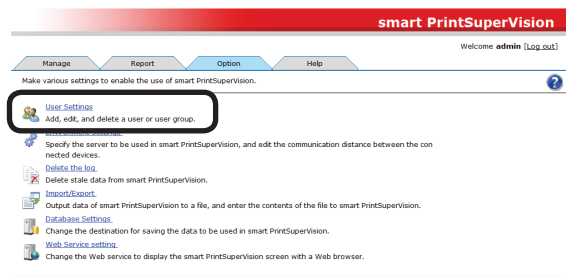

- 2 Click the user or user group in [User List].

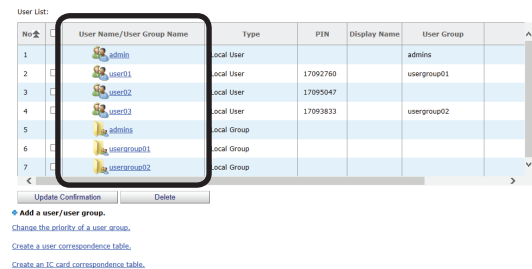

- 3 Click + in [Display Usage] to open the information screen.

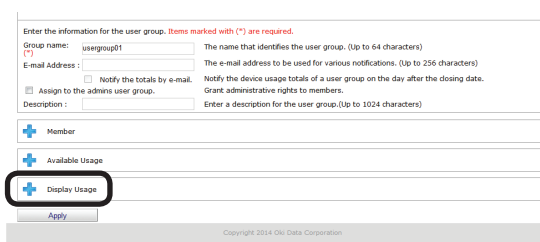

- 4 The usage status of the items for which available usage is set are displayed.

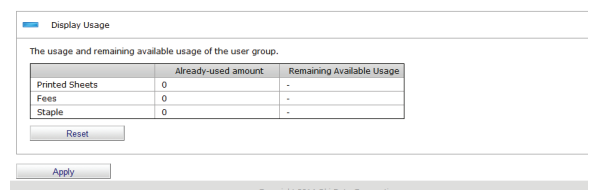



5 Click [Reset] to reset the usage status.

	Already-used amount	Remaining Available Usage
Printed Sheets	0	-
Fees	0	-
Stamps	0	-

**Note**

If "Prohibit Printing" is set in the user or user group settings, the status cannot be reset unless the power of the device is turned on.

**Memo**

- The usage status of the users and user groups registered to the device group are the total usage amount of the users and user groups from all devices that belong to the device group. Also, the usage status of the user group is the total usage amount of all users that belong to the user group. However, the usage amount of users and user groups that have the [Do not process Available Usage as a group] check mark checked are not included.
- If a usage amount reset interval is set for users or user groups, the usage amount is automatically reset at the end of the set duration.

6 Click [Apply].

## Sending Print Prohibited/ Permitted by Mail

When [If available amount is exceeded] is checked, users are notified by email when the available usage is exceeded and printing cannot be executed.

Also, users are notified by email when usage is reset when [When you reset the usage] is checked.

**Note**

The outgoing mail server and sender's email address need to be configured in advance according to "Setting the Outgoing Mail Function" (P. 210).

1 Configure the information from [Details Screen] > [Option] > [User Settings].

2 Click the user or user group in [User List].

No.	User Name/User Group Name	Type	PIN	Display Name	User Group
1	admins	Local User			admins
2	user01	Local User	17092760		usergroup01
3	user02	Local User	17095047		
4	user03	Local User	17093833		usergroup02
5	admins	Local Group			
6	usergroup01	Local Group			
7	usergroup02	Local Group			

3 Click [Available Usage].

4 Configure the [Notification Conditions].

**[If available amount is exceeded]**

When this is checked, users are notified by email when the usage limit value is exceeded.

**[When you reset the usage]**

When this is checked, users are notified by email when the valid period runs out or the usage status is reset.

**5** Click [Apply].

First Name :	<input type="text"/>	The user's first name.
E-mail Address :	<input type="text"/>	The e-mail address to be used for various notifications.
	<input type="checkbox"/> Notify the totals by e-mail.	Notify the device usage totals of a user on the day after the closing date.
Telephone Number :	<input type="text"/>	The user's telephone number. (Up to 64 characters)
Description :	<input type="text"/>	The user's description. (Up to 1024 characters)
Display Name :	<input type="text"/>	The user's display name. (Up to 256 characters)
Language Code :	other <input type="text"/>	The user's language code. (Up to 64 characters)
IC Card Information :	<input type="text"/>	The user's card ID. (Up to 256 characters)
+ User Group <input type="text"/>		
+ Available Usage <input type="text"/>		
+ Display Usage <input type="text"/>		
<input type="button" value="Apply"/>		

**! Note**

**Users are not notified when the mail address is not entered. Enter the mail address.**

**Memo**

**To set multiple users, repeat the steps from 2 to 6.**

# 11. Checking the Device Status, Consumable Life or Printing Status

---

Checking the Device Usage Status.....	182
Checking the Consumable Life .....	183
Checking the Printing Status.....	185
Checking Device Statuses .....	187
Changing Interval and Time for Acquiring Device Information and Statuses.....	189

# 11. Checking the Device Status, Consumable Life or Printing Status

Check the device usage status, the usage quantity of maintenance items and the remaining life of consumables.

## Checking the Device Usage Status

A report is created according to basic information, such as the connection destination of the device.

- 1 Check that the power of the device to be checked is turned on.
- 2 Check this from [Details Screen] > [Report] > [Display Report] > [Device Info].

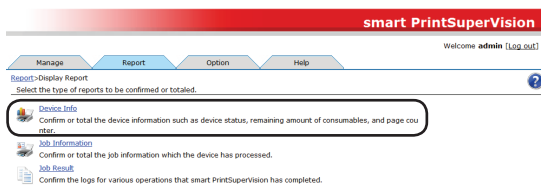

- 3 Select the device to be confirmed from [Device] and check [Acquire the device status before the job.].

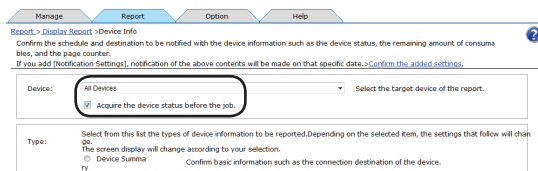

- 4 Select [Device Summary] from [Type].



When [Device Summary] is selected, the control window for detailed settings at the bottom changes.

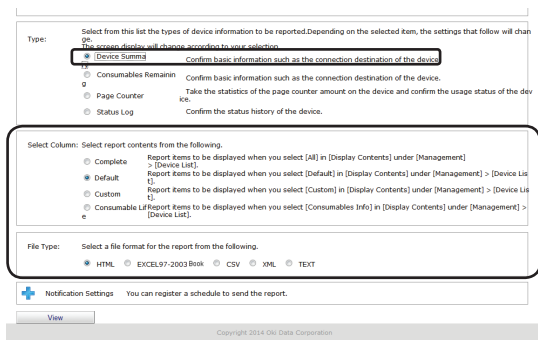

- 5 Check the items to be confirmed in [Select Column].

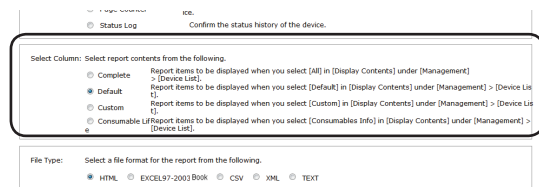

### [Complete]

Creates a report on items displayed when [Complete] is selected in [Manage] > [Device List] > [Display Content].

### [Default]

Creates a report on items displayed when [Default] is selected in [Manage] > [Device List] > [Display Content].

### [Custom]

Creates a report on items displayed when [Custom] is selected in [Manage] > [Device List] > [Display Content].



The content displayed in [Custom] can be changed from [Manage] > [Device List] > [Display Content] > [Edit Display Contents].

### [Consumable Life]

Creates a report on items displayed when [Default] is selected in [Manage] > [Device List] > [Consumable Life].

- 6 Select the format in which to output the results.

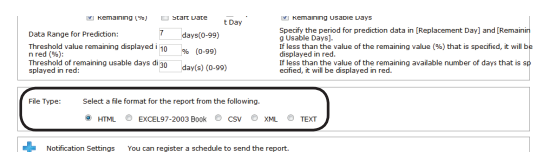

**[HTML]**

Outputs a report in an HTML file.

**[EXCEL 97-2003 book]**

Outputs a report in an XLS file (extension “.xls”).

**[CSV]**

Outputs a report in a CSV file (extension “.csv”).

**[XML]**

Outputs a report in an XML file (extension “.xml”).

**[TEXT]**

Outputs a report in a TXT file (extension “.txt”).

**7** Click [View] to check the results.

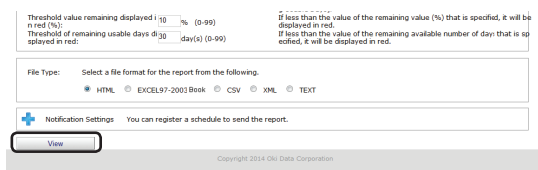

# Checking the Consumable Life

A report is created according to the job log acquired by sPSV concerning maintenance items and consumables.

- 1** Check that the power of the device to be checked is turned on.
- 2** Check this from [Details Screen] > [Report] > [Display Report] > [Device Info].

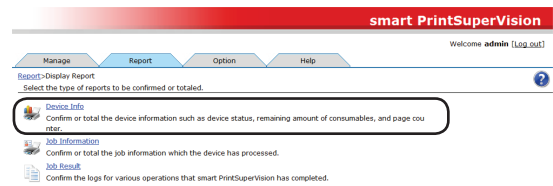

- 3** Select the device to be confirmed from [Device] and check [Acquire the device status before the job.].

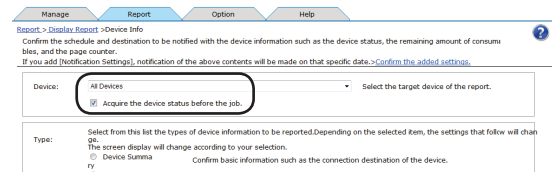

- 4** Select [Consumables Remaining] from [Type].



**When [Consumables Remaining] is selected, the control window for detailed settings at the bottom changes.**

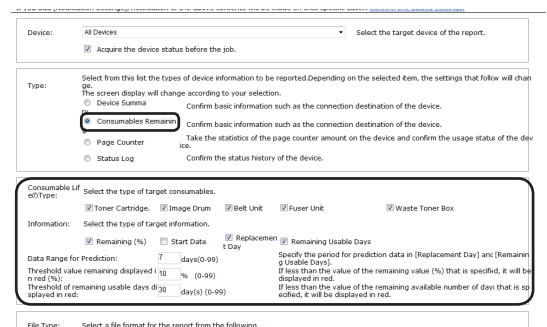

**5** Check the items to be confirmed in [Consumable Life Type].



**If a setting does not exist on the device, the corresponding field is left blank in the report.**

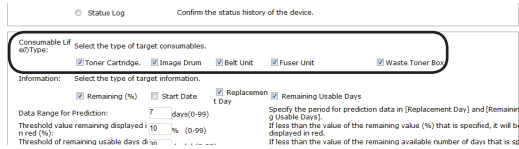

**[Toner Cartridge.]**

Displays information on the toner cartridge.

**[Image Drum]**

Displays information on the image drum.

**[Belt Unit]**

Displays information on the belt unit.

**[Fuser Unit]**

Displays information on the fuser unit.

**[Waste Toner Box]**

Displays information on the waste toner box.

**6** Select the information to be included in the report from [Information].

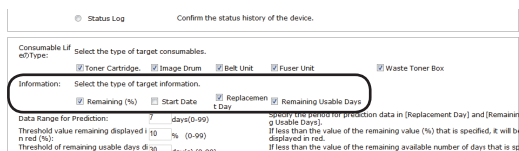

**[Remaining (%)]**

Displays the remaining life of the consumable or maintenance item as a percentage.

**[Start Date]**

Displays the monitoring start date of the consumable or maintenance item.

**[Replacement Day]**

Displays the predicted replacement date of the consumable or maintenance item based on the current value and the usage status range specified in step 7.

**[Remaining Available Usage Days]**

Displays the number of days until the replacement date.

**7** Specify the data range to be used to predict the replacement date and the remaining available usage days.

(default: 7, range: 0 - 99)

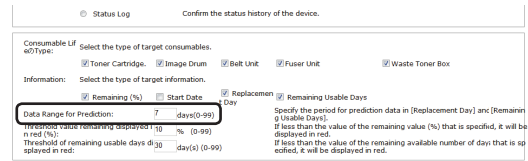

**8** Specify the percentage from which to display the remaining life (%) of consumables and maintenance items in red.

(default: 10, range: 0 - 99)



**The remaining life is displayed in red once it falls below the percentage specified here.**

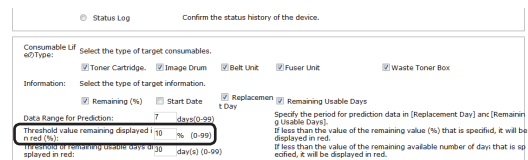

**9** Specify the threshold for the remaining available usage days for consumables and maintenance items.

(default: 30, range: 0 - 99)



**The remaining life is displayed in red once it falls below the value specified here.**

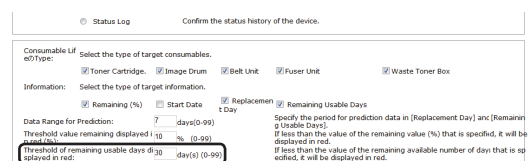

**10** Select the format in which to output the results.

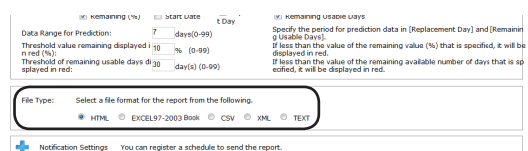

**[HTML]**

Outputs a report in an HTML file.

**[EXCEL 97-2003 book]**

Outputs a report in an XLS file (extension ".xls").

**[CSV]**

Outputs a report in a CSV file (extension ".csv").

**[XML]**

Outputs a report in an XML file (extension “.xml”).

**[TEXT]**

Outputs a report in a TXT file (extension “.txt”).

**11** Click [View] to check the results.

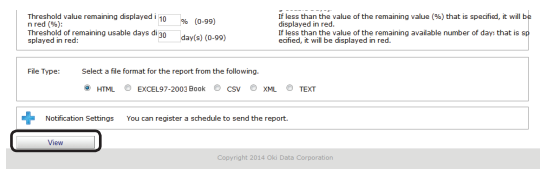

# Checking the Printing Status

A report is created according to the page counter value obtained by sPSV for the device.



**The settings in sPSV cannot be configured without computer administrator authority.**

- 1** Check that the power of the device to be checked is turned on.
- 2** Check this from [Details Screen] > [Report] > [Display Report] > [Device Info].

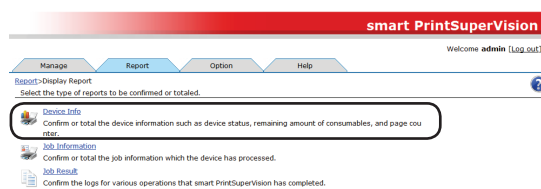

- 3** After checking that the power of the device is turned on, select the device to be confirmed from [Device] and check [Acquire the device status before the job.].

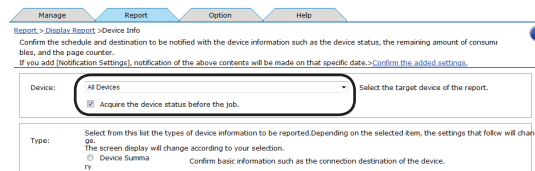

- 4** Select [Page Counter] from [Type].



**When [Page Counter] is selected, the control window for detailed settings at the bottom changes.**

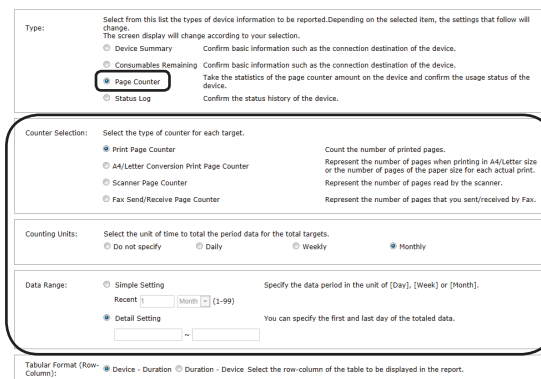

**5** Select the counter to be checked from [Counter Selection].

**[Print Page Counter]**

Displays the printed page counts for [Color], [Mono], [Spot Color 1] and [Spot Color 2], and the total printed pages.

**[A4/Letter Conversion Print Page Counter]**

Displays the printed page counts converted to A4/letter format for [Color], [Mono], [Spot Color 1] and [Spot Color 2], and the total printed pages.

**[Scanner Page Counter]**

Displays the [Scanner Scan] page count and [Scanner ADF Scan] page count.

**[Fax Send/Receive Page Counter]**

Displays the number of pages sent and received by fax.

**6** Select the counting unit for the duration from [Counting Units].

(default: Monthly)

**[Do not specify]**

Calculates the overall total.

**[Daily]**

Calculates the total for each day.

**[Weekly]**

Calculates the total for each week (Sunday - Saturday).

**[Monthly]**

Calculates the total for each month (day after closing date of previous month - closing date of current month).

**7** Specify the duration for which to check the information from [Data Range]. This is the range of page count data used in the report.

(range: 2000/01/01 - 2099/12/31, default: -)

**[Basic Specification]**

Specify the data duration in [Day], [Week] or [Month].

**[Detail setting]**

Specify the start date and end date of the data to be summarized. Click the input fields and specify the date from the displayed calendar. Dates can also be directly input into the text box.



- If no start date is input, the data duration starts from the earliest collected data.
- If no end date is input, the data duration continues to the last collected data.

**8** Select the format of the table.

Specify the parameters for the row and column arrangement of the table displayed in the displayed result report.

**[Device - Duration]**

A table is created with devices displayed in rows and durations (counting units) displayed in columns.

**[Duration-Device]**

A table is created with durations (counting units) displayed in rows and devices displayed in columns.



9 Select the format in which to output the results.

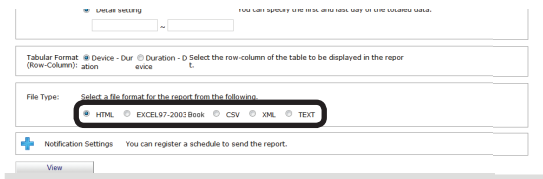

**[HTML]**

Outputs a report in an HTML file.

**[EXCEL 97-2003 book]**

Outputs a report in an XLS file (extension “.xls”).

**[CSV]**

Outputs a report in a CSV file (extension “.csv”).

**[XML]**

Outputs a report in an XML file (extension “.xml”).

**[TEXT]**

Outputs a report in a TXT file (extension “.txt”).

10 Click [View] to check the results.

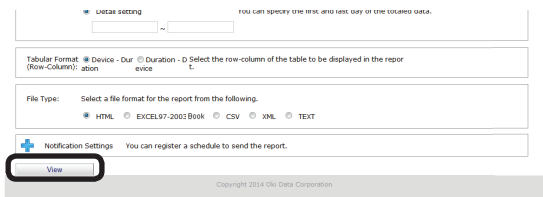

# Checking Device Statuses

A report is created according to the status history of the device.

- 1 Check that the power of the device to be checked is turned on.
- 2 Check this from [Details Screen] > [Report] > [Display Report] > [Device Info].

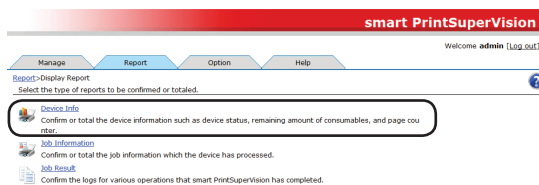

- 3 Select the device to be confirmed from [Device] and check [Acquire the device status before the job.].

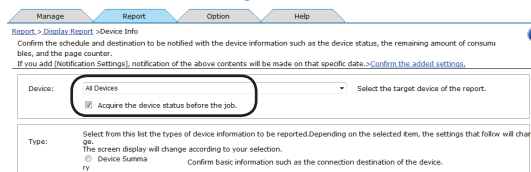

- 4 Select [Status Log] from [Type].



**When [Status Log] is selected, the control window for detailed settings at the bottom changes.**



**5** Check the items to be confirmed in [Device Status].

Category	Level	Select	Description
Complete	Error	<input type="checkbox"/>	Detected an error or warning which is included in all of the following categories.
	Warning	<input type="checkbox"/>	
Cover Open	Error	<input type="checkbox"/>	Cover open, tray (cassette) missing, etc.
	Warning	<input type="checkbox"/>	
Receive Data	Error	<input type="checkbox"/>	Invalid data, decoding error, etc.
	Warning	<input type="checkbox"/>	
Finisher	Error	<input type="checkbox"/>	Related to The Finisher
	Warning	<input type="checkbox"/>	
Firmware	Error	<input type="checkbox"/>	Firmware error, updating, etc.
	Warning	<input type="checkbox"/>	
Hardware	Error	<input type="checkbox"/>	Components not connected, sensor error, etc.
	Warning	<input type="checkbox"/>	
Job Cancel	Error	<input type="checkbox"/>	Job canceled.
	Warning	<input type="checkbox"/>	
Paper Setup	Error	<input type="checkbox"/>	Paper mismatch, paper replenish, paper Jam, etc.
	Warning	<input type="checkbox"/>	
Multifunctional Device	Error	<input type="checkbox"/>	Scan, Fax, and Server Connection
	Warning	<input type="checkbox"/>	
Network	Error	<input type="checkbox"/>	Server authentication error, IP address duplication, etc.
	Warning	<input type="checkbox"/>	
Security	Error	<input type="checkbox"/>	Protect Print, usage restrictions, print job related authentication
	Warning	<input type="checkbox"/>	
Sensor	Error	<input type="checkbox"/>	Consumables, device sensor error, etc.
	Warning	<input type="checkbox"/>	
Service Man Call	Error	<input type="checkbox"/>	Call serviceman, program error, etc.
	Warning	<input type="checkbox"/>	
Stacker	Error	<input type="checkbox"/>	Stacker full, open, etc.
	Warning	<input type="checkbox"/>	
Storage	Error	<input type="checkbox"/>	Memory-related Message
	Warning	<input type="checkbox"/>	
Consumables and Maintenance Products	Error	<input type="checkbox"/>	Consumables, maintenance products, etc.
	Warning	<input type="checkbox"/>	
Timeout	Error	<input type="checkbox"/>	Receipt Timeout
	Warning	<input type="checkbox"/>	
Others	Error	<input type="checkbox"/>	Other Warnings or Errors
	Warning	<input type="checkbox"/>	

**[Complete]**

Detects errors and warnings in all categories.

**[Cover Open]**

Detects errors and warnings such as open covers and missing trays (cassettes).

**[Receive Data]**

Detects errors and warnings such as invalid data, decoding errors, etc.

**[Finisher]**

Detects errors and warnings such as status errors relating to the finisher, including missing connections, paper jams, staples, punching, etc.

**[Firmware]**

Detects errors and warnings such as firmware errors, updating, etc.

**[Hardware]**

Detects errors and warnings such as components not connected, sensor errors, etc.

**[Job Cancel]**

Detects job cancellations occurring as a result of access control or print commands in combinations for which printing is not possible.

**[Paper Setup]**

Detects errors and warnings such as wrong paper, out of paper and paper jams

**[Multifunctional Device]**

Detects errors and warnings such as scan, fax, and server connections.

**[Network]**

Detects errors and warnings such as server authentication errors, IP address duplication, etc.

**[Security]**

Detects errors and warnings such as Protec Print, usage restrictions, print job related authentication, etc.

**[Sensor]**

Detects errors and warnings such as consumables, device sensor errors, etc.

**[Service Man Call]**

Detects errors such as Call Serviceman, program error, etc.

**[Stacker]**

Detects errors and warnings such as stacker full, open, etc.

**[Storage]**

Detects errors and warnings such as insufficient memory, insufficient disk space, no memory device, etc.

**[Consumables and Maintenance Products]**

Detects errors and warnings such as consumables, maintenance products, etc.

**[Timeout]**

Detects errors and warnings such as data receipt timeouts.

**[Others]**

Detects errors and warnings other than those above.

**6** Specify the duration for which to check the information from [Data Range]. This is the status range used in the report.

(range: 2000/01/01 - 2099/12/31, default: -)

The screenshot shows a configuration window for a report. At the top, there are two tabs: 'Timeout' and 'Receipt Timeout'. Under 'Timeout', there are 'Warning' and 'Error' options. Under 'Receipt Timeout', there is 'Other Warnings or Errors'. The 'Data Range' section has two radio buttons: 'Simple Setting' (selected) and 'Detail Setting'. Below 'Simple Setting', there is a 'Recent' dropdown set to 'Month' and a range '(1-99)'. A note says 'You can specify the first and last day of the totalized data.' Below 'Detail Setting', there are two empty input fields. The 'File Type' section has a note 'Select a file format for the report from the following.' and radio buttons for 'HTML', 'Excel 97-2003 Workbook' (selected), 'CSV', 'XML', and 'TEXT'.

**[Basic Specification]**

Specify the data duration in [Day], [Week] or [Month].

## [Detail setting]

Specify the start date and end date of the data to be summarized. Click the input fields and specify the date from the displayed calendar. Dates can also be directly input into the text box.

### ! Note

- If no start date is input, the data duration starts from the earliest collected data.
- If no end date is input, the data duration continues to the last collected data.

- 7 Select the format in which to output the results.

## [HTML]

Outputs a report in an HTML file.

## [EXCEL 97-2003 book]

Outputs a report in an XLS file (extension “.xls”).

## [CSV]

Outputs a report in a CSV file (extension “.csv”).

## [XML]

Outputs a report in an XML file (extension “.xml”).

## [TEXT]

Outputs a report in a TXT file (extension “.txt”).

- 8 Click [View] to check the results.

## Changing Interval and Time for Acquiring Device Information and Statuses

It is possible to regularly monitor device information and device status information for registered devices and update the information if there are any changes. Monitoring of auto status refresh is enabled by default, but the monitoring schedule settings can be changed.

- 1 Set in [Details Screen] > [Option] > [Environment Settings] > [Communication Settings].

- 2 Click + in [Communication Interval] to open the settings window.

- 3 Check the items for which to regularly acquire and confirm information.

## [Acquire Device Info]

Specify the interval at which to acquire information such as consumables remaining and the remaining life of maintenance items.

### [Specify Time]

Updated for each set interval. (Range: 1 to 1440 minutes)

**[Time specified]**

Set the specific update time. Click [Specify Time] and add the time. After adding, click [OK].

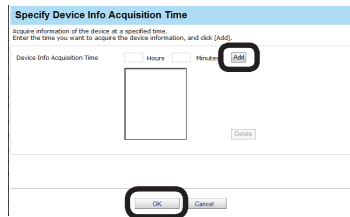
**[Acquire Status]**

Specify the interval at which to acquire status information.

**[Specify Time]**

Updated for each set interval. (Range: 1 to 1440 minutes)

**[Time specified]**

Set the specific update time. Click [Specify Time] and add the time. After adding, click [OK].

**[Confirm changes to the IP address.]**

Specify the interval at which to check the IP address of the device. sPSV automatically reconnects if the IP address has changed.

**[Specify Time]**

Updated for each set interval. (Range: 1 to 24 hours)

**[Time specified]**

Set the specific update time. Click [Specify Time] and add the time. After adding, click [OK].

**[Confirm the update of Active Directory.]**

See P. 46 "Changing the Time or Interval at Which Update of Active Directory is Confirmed".

4 Click [Apply].

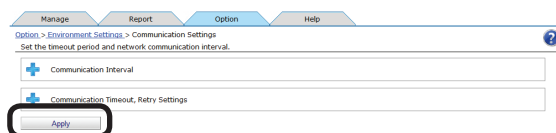

## 12. Managing Job Logs

---

What Can Be Done with Job Logs .....	193
Configuring the Job Log Acquisition Settings .....	193
Providing Time Notifications for Devices .....	195
Displaying Job Logs .....	195
Displaying Job Logs .....	195
Displaying All Job Log Items (Detail Display)....	196
Changing Job Items To Be Displayed.....	197
Deleting Job Logs.....	198
Outputting Job Logs as a CSV File .....	198
Stopping Job Log Acquisition .....	199
Operations When the Log Is Full.....	200
Displaying Totals .....	201
Displaying Totals .....	201
Displaying All Aggregated Items (Detail Display).....	202
Changing Aggregate Items .....	202
Outputting the Aggregation Results As a CSV File.....	203
Receiving Notifications of Usage Status Totals by Email .....	204
Sending Job Logs by Email .....	205
Changing the Closing Date .....	206

## 12. Managing Job Logs

This section explains settings for acquiring job logs, and operations such as displaying, deleting or summarizing job logs.

### What Can Be Done with Job Logs

In sPSV, various information about print jobs such as who, when, and which device was used for print jobs and operational information for copies, faxes, etc. is stored on the device's SD memory card, built-in hard disk or flash memory. This information is called the job log. sPSV acquires job logs from devices according to a set schedule.

By collecting job logs, it is possible to check how much individuals are printing, and how much a specific device is being used.

#### ! Note

- A job log entry is made when one or more sheets are printed. Furthermore, job log entries are made in the event of usage limitations such as when printing is prohibited, or when a print job is canceled because color printing is prohibited.
- However, job log entries are not made when the device power is turned OFF during processing or printing, or if printing cannot be performed because the device has an error.

#### Memo

See "Information That Can Be Acquired as a Job Log" (P. 243) for information that can be acquired as job log entries and "Items That Can Be Aggregated" (P. 248) for items that can be summarized.

### Configuring the Job Log Acquisition Settings

In order for sPSV to acquire job logs, the devices need to be set to record job logs.

To acquire job logs, set the device to record job logs.

- 1 Check that the power of the device from which to acquire job logs is turned on.
- 2 Set from [Details Screen] > [Manage] > [Device Management Settings] > [Device Settings].

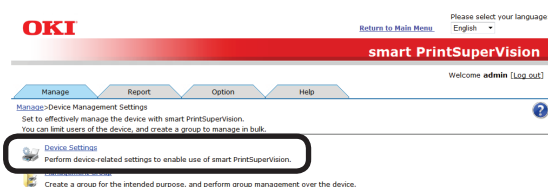

- 3 Select the device from which to acquire the job log in [Device].

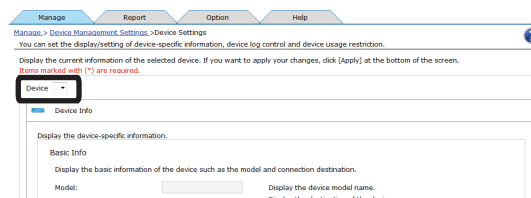

- 4 Click + in [Log/Access Control] to open the settings window.

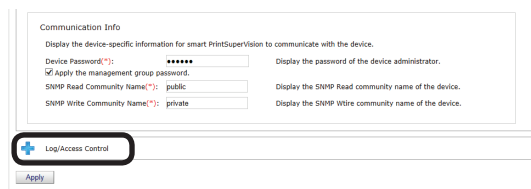

- 5 Check [Record Job Log to Device].

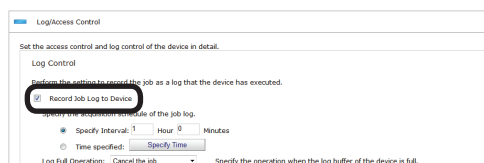

## [Record Job Log to Device]

The device starts recording the log when this is checked and the change is applied. The device stops recording the log when the check is removed and the change is applied.

 Memo

- If the device server ID is already set from a different server, a confirmation dialog box is displayed.
- To change the setting, enter the Server ID.
- In some devices, the [Restrictions] (page 143) functions that can be used differ according to the check status of [Record Job Log to Device].
- In some devices, [Access Control] settings can be operated after changing the "Record Job Log to Device" check mark and clicking [Apply].

- 6 Set the schedule by which the job log is acquired.

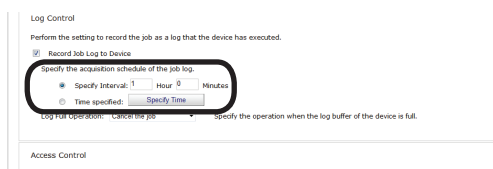

### [Specify Time]

Acquired for each set interval. The maximum interval time that can be set is 24 hours. The default setting is set as an optimized value detected from the state of the added device. If the interval is set to a time that is longer than the default settings, some of the job logs may not be acquired. (Range: 1 to 24 hours)

### [Time specified]

Set the specific time. Click [Specify Time] and add the time in 24-hour format. Up to 24 acquisition times can be added. After adding, click [OK].

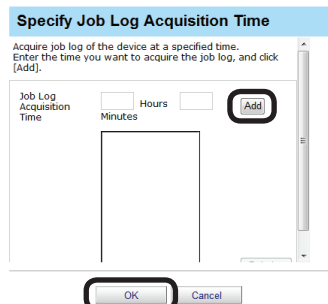

 Note

**Always set the time when the computer in which sPSV is set up and the device are both switched ON.**  
**The job log is not acquired if the power is not ON.**

- 7 Click [Apply].

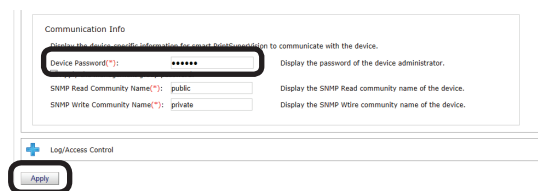

When the "Enter an administrator password for the device" window is displayed, enter the administrator password for the device and click [OK].

 Note

- Depending on the device, this may not be displayed.
- For details on the device's factory set administrator password, see the User's Manual of the device.

- 8 Click [OK] in the confirmation window.

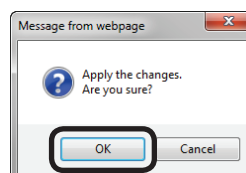

## Providing Time Notifications for Devices

sPSV needs to provide time notifications to devices that do not have an internal clock and devices for which SNTP is not set.

Timing at which sPSV provides time notifications to devices:

- When the job log is acquired
- When device information is acquired ([Option] > [Environment Settings] > [Communication Settings])

Follow the steps below to configure the settings for providing time notifications to devices.

- 1 Check that the power of the device to which to provide time notifications is turned on.
- 2 Configure the settings from [Details Screen] > [Report] > [Display Report] > [Job Information].

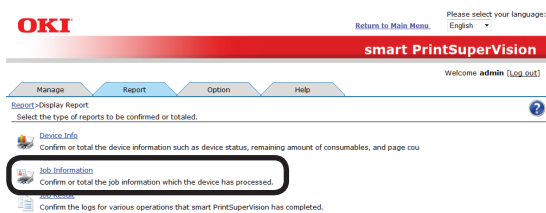

- 3 Select the device to which to provide time notifications from [Device] and check [Acquire the device status before the job.].

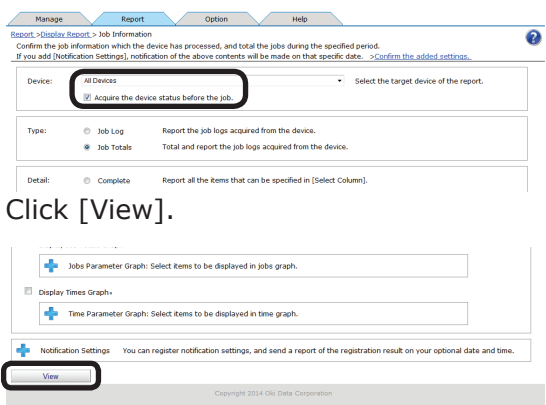

- 4 Click [View].

## Displaying Job Logs

Job logs can be displayed for a specified device and/or duration.

When devices are managed in groups, the job log can be displayed as a group.

It is not possible to specify and delete a specific job log.

### Displaying Job Logs

- 1 Configure the settings from [Details Screen] > [Report] > [Display Report] > [Job Information].

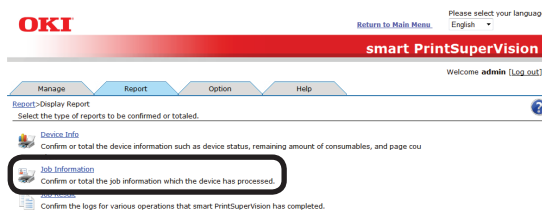

- 2 Select [Job Log] from [Type].

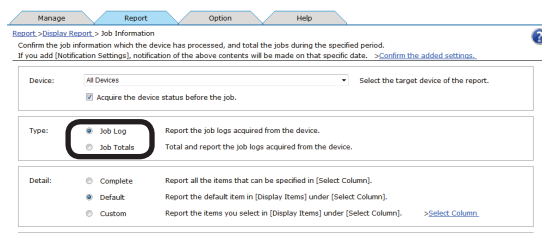

- 3 Specify the job log to display and click [View].

If acquiring the job log before a job, check that the power of the device for which to display the job log is turned on and check [Acquire the device status before the job.].

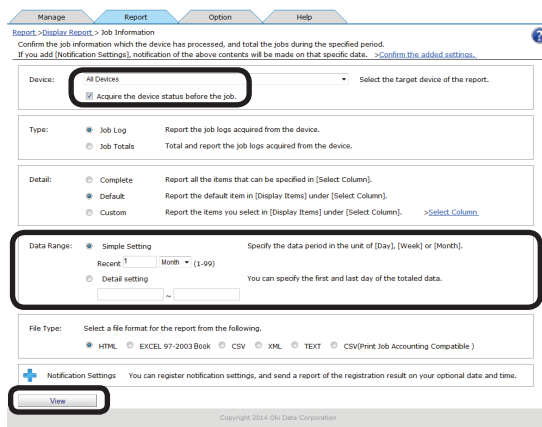





The input format in [Detail setting] is [YYYY/MM/DD] (YYYY refers to the year, MM refers to the month and DD refers to the day). If no start date is input, the job log is acquired from the first entry onward. If no end date is input, the job log is acquired up to the last entry.

### (1) Displaying all job logs for all devices

Select [All Devices] for [Device].  
Select [Detail setting] for [Data Range]  
(leave the date blank).

### (2) Displaying all job logs for a specific device

Select the specific device for [Device].  
Select [Detail setting] for [Data Range]  
(leave the date blank).

### (3) Displaying all job logs for a specific month

Select [All Devices] for [Device].  
Select [Detail setting] for [Data Range]  
and specify a start date and end date  
for a specific month.

### (4) Displaying job logs for a specific device for a specific month

Select the specific device for [Device].  
Select [Detail setting] for [Data Range]  
and specify a start date and end date  
for a specific month.

### (5) Displaying all job logs for a specific device group

Select the specific device group for  
[Device].  
Select [Detail setting] for [Data Range]  
(leave the date blank).

### (6) Displaying job logs for a specific device group for a specific month

Select the specific device group for  
[Device].  
Select [Detail setting] for [Data Range]  
and specify a start date and end date  
for a specific month.

## Displaying All Job Log Items (Detail Display)

- 1 Configure the settings from [Details Screen] > [Report] > [Display Report] > [Job Information].

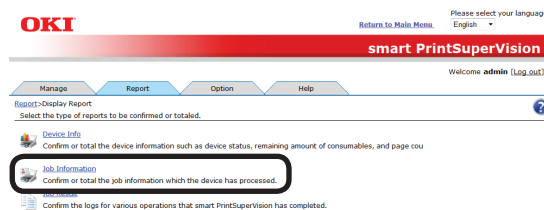

- 2 Select the device for which to display the job log in [Device].

If acquiring the job log before a job, check that the power of the device for which to display the job log is turned on and check [Acquire the device status before the job].

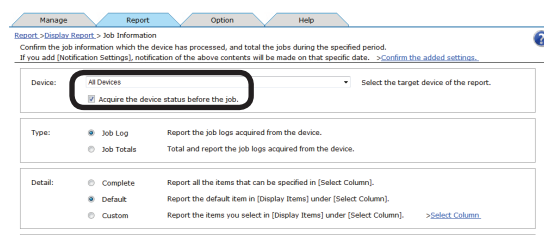

- 3 Select [Job Log] from [Type].

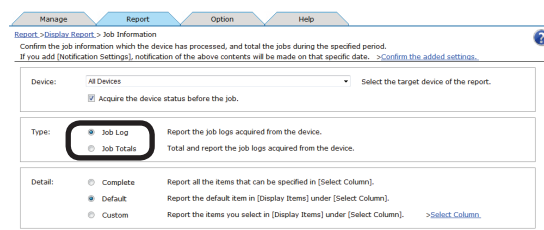

#### 4 Select [Complete] from [Detail] and click [View].

## Changing Job Items To Be Displayed

### 1 Configure the settings from [Details Screen] > [Report] > [Display Report] > [Job Information].

### 2 Select [Custom] from [Detail] and click [Select Column].

### 3 In [Column Settings for Job Log], click + to open the file tree.

### 4 Change the job log items to be displayed.

#### (1) Items to be displayed:

Select the items to display from [Displayable Items], and click → to switch to [Display Items].

#### (2) Items to be hidden:

Select the items to hide from [Display Items], and click ← to switch to [Displayable Items].

#### (3) Changing the order of items:

Select the items in [Display Items] and click ↑ or ↓ to change the order.



**Press and hold the Shift key or Ctrl key when selecting more than one attribute.**

### 5 Click [Apply].

### 6 Click [OK] in the confirmation window.

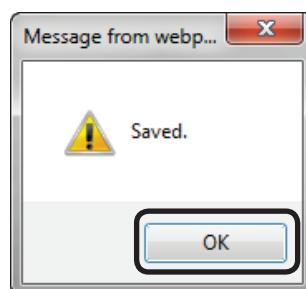

## Deleting Job Logs

**Note**

- It is not possible to specify and delete a specific job log.
- Deleted job logs cannot be recovered.

- 1 Click [Details Screen] > [Option] > [Delete the log].

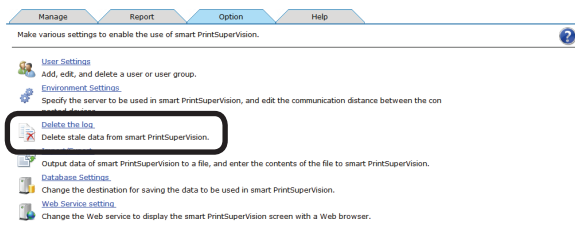

- 2 Set the job log storage period (maximum: 365 days).

**Note**

**Check this so that the log is not automatically deleted.**

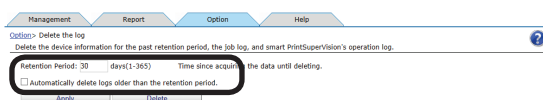

- 3 Click [Delete] to delete job logs that have exceeded the storage period.

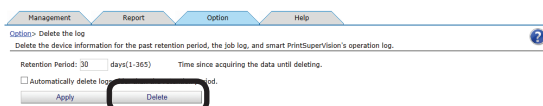

- 4 Click [OK] in the confirmation window.

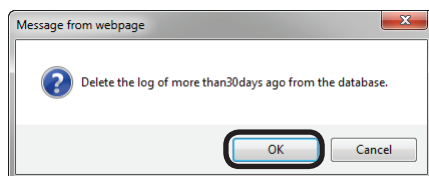

## Outputting Job Logs as a CSV File

The acquired job log can be output as a CSV format file, and used in commercially available spreadsheet software.

- 1 Configure the settings from [Details Screen] > [Report] > [Display Report] > [Job Information].

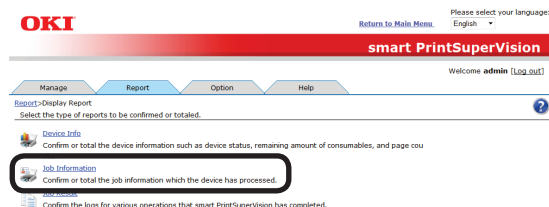

- 2 Select the device for which to output the job log in [Device].

If acquiring the job log before a job, check that the power of the device for which to display the job log is turned on and check [Acquire the device status before the job.].

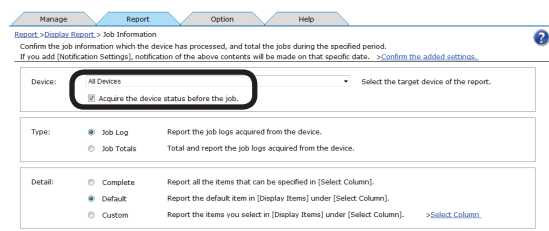

- 3 Select [Job Log] from [Type].

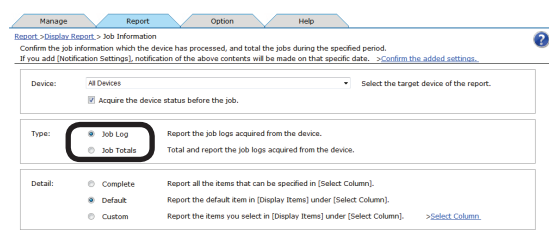

- 4 If changing the job log to be output, see "Changing Job Items To Be Displayed" (P. 196) (steps 2 to 6).

- 5 Specify the duration for which to output the job log from [Data Range].

- 6 Select [CSV] from [File Type].



In addition to CSV files, job logs can be output to file formats such as HTML or Microsoft Excel 97-2003 book files.

- 7 Click [View].

- 8 The data is output to the application associated with the file specified in step 6.

- 9 Specify the folder and file name to be saved, and click [Save].



Items within the exported items that are not numbers are enclosed in "" marks.

## Stopping Job Log Acquisition

Job log acquisition can be stopped and restarted.

- 1 Check that the power of the device from which to stop acquiring job logs is turned on.
- 2 Set from [Details Screen] > [Manage] > [Device Management Settings] > [Device Settings].

- 3 Select the device from which to stop acquiring job logs in [Device].

- 4 Click + in [Log/Access Control] to open the settings window.

- 5 Remove the check from [Record Job Log to Device].

- 6 Click [Apply].

When the “Enter an administrator password for the device” window is displayed, enter the administrator password for the device and click [OK].

**Note**

- Depending on the device, this may not be displayed.
- For details on the device’s factory set administrator password, see the **User’s Manual of the device**.

7 Click [OK] in the confirmation window.

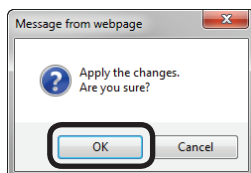

## Operations When the Log Is Full

The processes when the device log buffer is full before the log is acquired by sPSV can be set.

- 1 Set the log full operation in [Function Details] > [Manage] > [Device Management Settings] > [Device Settings].

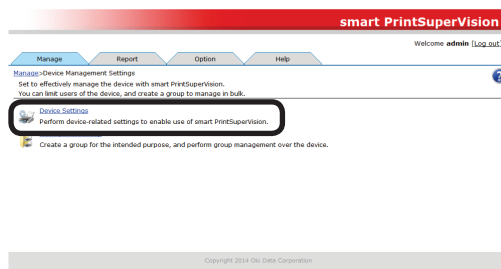

- 2 Select the device to configure from [Device].

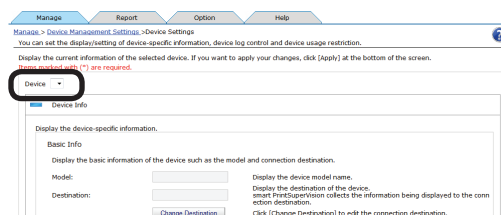

- 3 Click **+** in [Log/Access Control] to open the settings window.

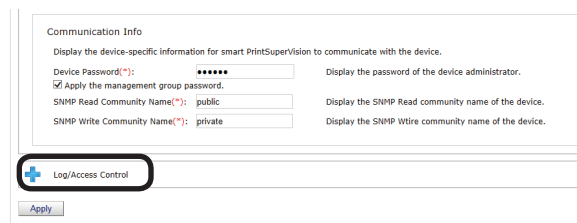

- 4 Change the [Log Full Operation].

**Memo**

The options vary depending on the device.

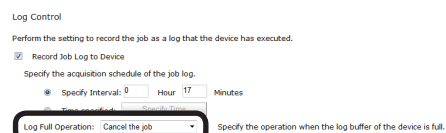

### [Cancel the job]

Cancels print jobs received by the device after the log is full.

### [No Logging]

Print jobs received by the device after the log is full are executed but not recorded to the log.

### [Delete Old Log]

Print jobs received by the device after the log is full are executed and recorded to the log, overwriting the oldest entry.

5 Click [Apply].

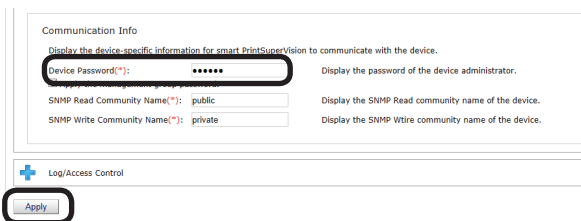

When the "Enter an administrator password for the device" window is displayed, enter the administrator password for the device and click [OK].

**! Note**

- Depending on the device, this may not be displayed.
- For details on the device's factory set administrator password, see the User's Manual of the device.

6 Click [OK] in the confirmation window.

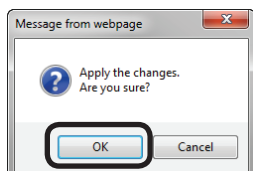

## Displaying Totals

### Displaying Totals

- 1 Configure the settings from [Details Screen] > [Report] > [Display Report] > [Job Information].

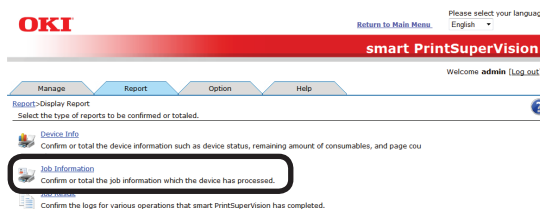

- 2 Select [Job Totals] from [Type].

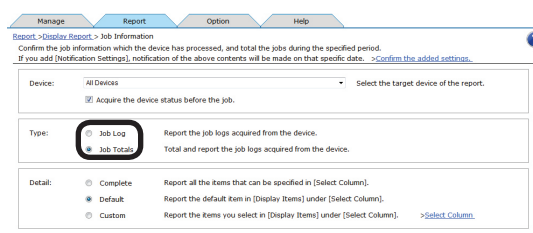

- 3 Specify the device, log range, totaling method, display (file) format, etc. and click [View].

If acquiring the job log before a job, check that the power of the device for which to display the job log is turned on and check [Acquire the device status before the job.].

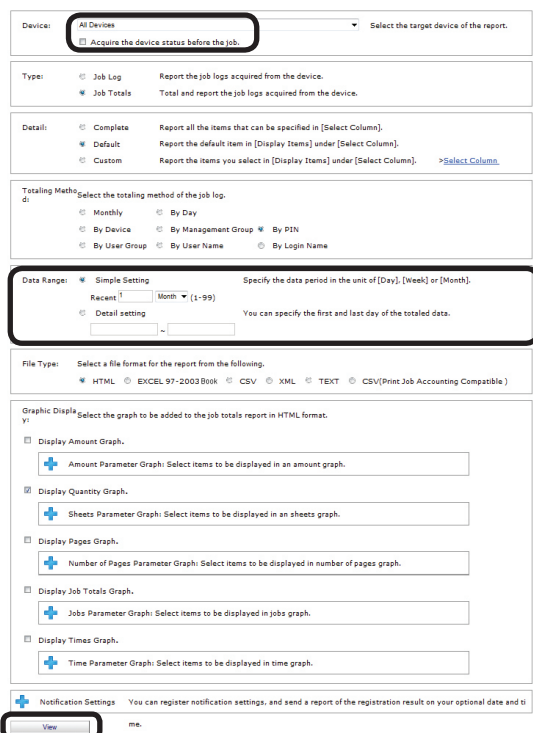

**(1) Aggregating all job logs for all devices**

Select [All Devices] for [Device].  
Select [Detail setting] in [Data Range].

**(2) Aggregating all job logs for a registered device**

Select the registered device for [Device].  
Select [Detail setting] in [Data Range].

**(3) Aggregating all job logs for a specific month**

Select [All Devices] for [Device].  
Select [Detail setting] for [Data Range] and specify a start date and end date for a specific month.

**(4) Aggregating job logs for a registered device for a specific month**

Select the registered device for [Device].  
Select [Detail setting] for [Data Range] and specify a start date and end date for a specific month.

**(5) Aggregating all job logs for a registered device group**

Select the registered device group for [Device].  
Select [Detail setting] in [Data Range].

**(6) Aggregating job logs for a registered device group for a specific month**

Select the registered device group for [Device].  
Select [Detail setting] for [Data Range] and specify a start date and end date for a specific month.

## Displaying All Aggregated Items (Detail Display)

- 1 Configure the settings from [Details Screen] > [Report] > [Display Report] > [Job Information].

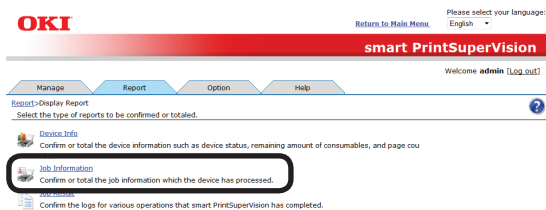
**2 Select the device for which to display the totals in [Device].**

If acquiring the job log before a job, check that the power of the device for which to display the job log is turned on and check [Acquire the device status before the job.].

Device:	All Devices	Select the target device of the report.
	<input checked="" type="checkbox"/> Acquire the device status before the job.	
Type:	<input type="radio"/> Job Log	Report the job logs acquired from the device.
	<input checked="" type="radio"/> Job Totals	Total and report the job logs acquired from the device.
Details:	<input checked="" type="radio"/> Complete	Report all the items that can be specified in [Select Column].
	<input type="radio"/> Default	Report the default item in [Display Items] under [Select Column].
	<input type="radio"/> Custom	Report the items you select in [Display Items] under [Select Column]. <a href="#">&gt;Select Column</a>
Totalling Method:	Select the totalling method of the job log.	

**3 Select [Job Totals] from [Type].**

Device:	All Devices	Select the target device of the report.
	<input checked="" type="checkbox"/> Acquire the device status before the job.	
Type:	<input type="radio"/> Job Log	Report the job logs acquired from the device.
	<input checked="" type="radio"/> Job Totals	Total and report the job logs acquired from the device.
Details:	<input checked="" type="radio"/> Complete	Report all the items that can be specified in [Select Column].
	<input type="radio"/> Default	Report the default item in [Display Items] under [Select Column].
	<input type="radio"/> Custom	Report the items you select in [Display Items] under [Select Column]. <a href="#">&gt;Select Column</a>
Totalling Method:	Select the totalling method of the job log.	

**4 Select [Complete] in [Detail].**

Device:	All Devices	Select the target device of the report.
	<input checked="" type="checkbox"/> Acquire the device status before the job.	
Type:	<input type="radio"/> Job Log	Report the job logs acquired from the device.
	<input checked="" type="radio"/> Job Totals	Total and report the job logs acquired from the device.
Details:	<input checked="" type="radio"/> Complete	Report all the items that can be specified in [Select Column].
	<input type="radio"/> Default	Report the default item in [Display Items] under [Select Column].
	<input type="radio"/> Custom	Report the items you select in [Display Items] under [Select Column]. <a href="#">&gt;Select Column</a>
Totalling Method:	Select the totalling method of the job log.	

**5 Click [View].**

+ Amount Parameter Graph: Select items to be displayed in an amount graph.	
<input checked="" type="checkbox"/>	Display Quantity Graph.
+ Sheets Parameter Graph: Select items to be displayed in an sheets graph.	
<input type="checkbox"/>	Display Pages Graph.
+ Number of Pages Parameter Graph: Select items to be displayed in number of pages graph.	
<input type="checkbox"/>	Display Job Totals Graph.
+ Jobs Parameter Graph: Select items to be displayed in jobs graph.	
<input type="checkbox"/>	Display Times Graph.
+ Time Parameter Graph: Select items to be displayed in time graph.	
+ Notification Settings: You can register notification settings, and send a report of the registration result on your optional date and time.	
<input type="button" value="View"/>	

## Changing Aggregate Items

- 1 Configure the settings from [Details Screen] > [Report] > [Display Report] > [Job Information].

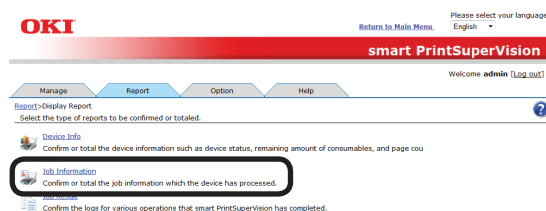



2 Select [Custom] from [Detail] and click [Select Column].

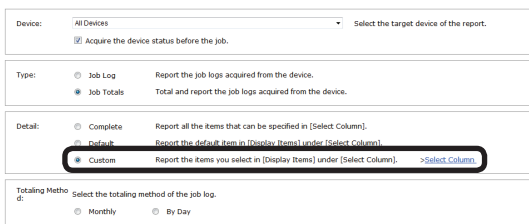

3 In [Column Settings for Job Totals], click + to open the file tree.

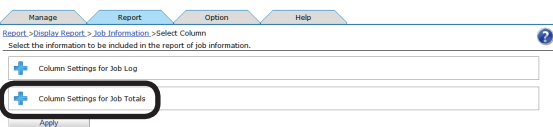

4 Change the job log items to be summarized.

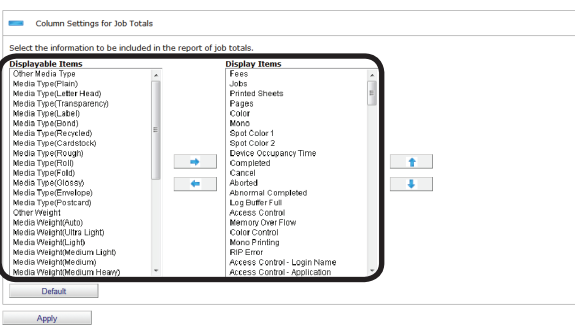

- (1) Items to be displayed:  
Select the items to display from [Displayable Items], and click ➡ to switch to [Display Items].
- (2) Items to be hidden:  
Select the items to hide from [Display Items], and click ⬅ to switch to [Displayable Items].
- (3) Changing the order of items:  
Select the items in [Display Items] and click ⬆ or ⬇ to change the order.



**Press and hold the Shift key or Ctrl key when selecting more than one attribute.**

5 Click [Apply].

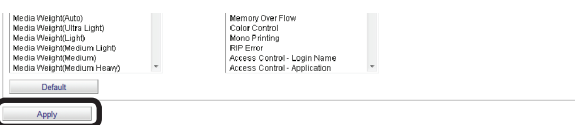

6 Click [OK] in the confirmation window.

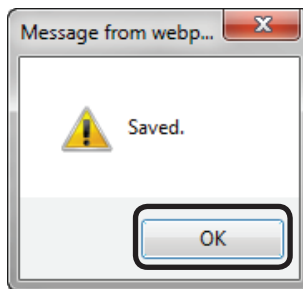

## Outputting the Aggregation Results As a CSV File

The aggregated results can be output as a CSV format file and used in commercially available spreadsheet software.

1 Configure the settings from [Details Screen] > [Report] > [Display Report] > [Job Information].

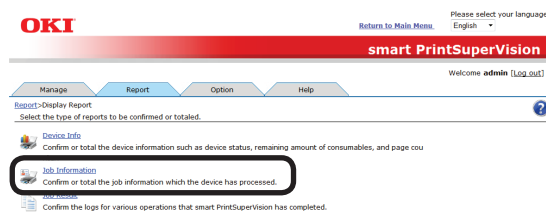

2 Select the device for which to output the aggregation results in [Device].

If acquiring the job log before a job, check that the power of the device for which to output the aggregation results is turned on and check [Acquire the device status before the job].

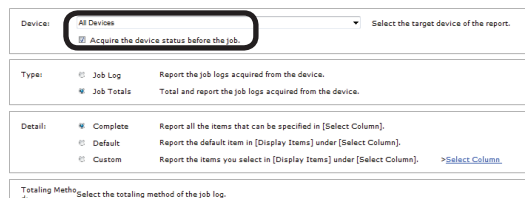

3 Select [Job Totals] from [Type].

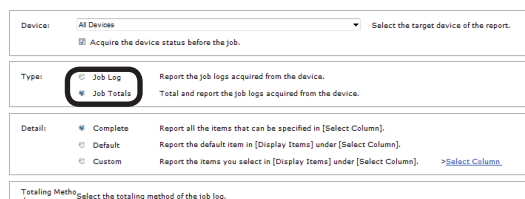

4 If changing the job log to be output, see "Changing Aggregate Items" (P. 201) (steps 2 to 6).



5 Specify the duration for which to output the job log from [Data Range].

6 Select [CSV] from [File Type].



In addition to CSV files, job logs can be output to file formats such as HTML or Microsoft Excel 97-2003 book files.

7 Click [View].

8 The data is output to the application associated with the file specified in step 6.

9 Specify the folder and file name to be saved, and click [Save].



Items within the exported items that are not numbers are enclosed in "" marks.

## Receiving Notifications of Usage Status Totals by Email

Log results can be notified by email to the user every month.



The send mail server and sender's email address need to be configured in advance according to "Setting the Outgoing Mail Function" (P. 210).



- The mail is sent the day after the deadline (default setting is end of the month) set in "Changing the Closing Date" (P. 205).
- The items to be aggregated can be changed in "Changing Aggregate Items" (P. 201).

1 Set the information from [Details Screen] > [Option] > [User Settings].

2 Click the user or user group to be changed in [User List].

No.	User Name/User Group Name	Type	PIN	Display Name	User Group
1	admin	Local User			admins
2	user01	Local User	17092760		usergroup01
3	user02	Local User	17095047		
4	user03	Local User	17093833		usergroup02
5	admins	Local Group			
6	usergroup01	Local Group			
7	usergroup02	Local Group			

3 Check [Notify the totals by e-mail.]

4 Click [Apply].

A screenshot of a configuration form with various input fields and a red-bordered 'Apply' button at the bottom.

## Sending Job Logs by Email

Acquired job logs can be automatically output to CSV files, and the output file can be sent as an email attachment every month to the administrator.



**The send mail server, sender's email address and administrator's email address need to be configured in advance according to "Setting the Outgoing Mail Function" (P. 210).**



- The mail is sent the day after the deadline (default setting is end of the month) set in "Changing the Closing Date" (P. 205).
- The items to be output from the log can be changed in "Changing Job Items To Be Displayed" (P. 196).

1 Configure the settings from [Details Screen] > [Report] > [Display Report] > [Job Information].

A screenshot of a navigation menu with 'Job Information' highlighted by a red box.

2 Select [Job Log] for [Type].

A screenshot of the 'Job Information' settings screen. The 'Type' dropdown is set to 'Job Log', which is circled in red.

3 Select [Simple Setting] in [Data Range] and specify [Last 1 Month].

A screenshot of the 'Data Range' settings screen. The 'Simple Setting' radio button is selected, and the 'Recent' dropdown is set to 'Month (1-99)', both circled in red.

4 Select [CSV] for [File Type].

A screenshot of the 'File Type' settings screen. The 'CSV' radio button is selected and circled in red.

5 Click + in [Notification Settings] to open the file tree.

A screenshot of the 'Notification Settings' menu item, which is circled in red.

6 Select the administrator from [Destination].

A screenshot of the 'Notification Settings' form. The 'Destination' dropdown is set to 'admin' and circled in red.

7 Select [Day after closing date] for [Notification Date] and click [Add].

A screenshot of the 'Notification Settings' form. The 'The Day After Closing Date' radio button is selected and circled in red, and the 'Add' button is also circled in red.

# Changing the Closing Date

The deadline date on which the job log is collected can be set.

- 1 Set in [Details Screen] > [Option] > [Environment Settings] > [Other setup].

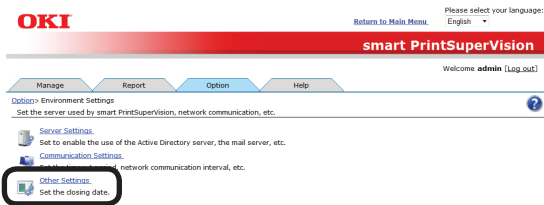

- 2 Specify the date to set as the closing date.

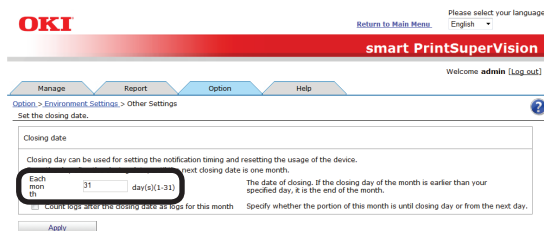

The log contents from the day after the set closing date are counted for one month.

For example, if the closing date is set for the 15th, the job log entries from January 16th to February 15th are collected as entries for February.



**If the closing date is set as the 31st, the closing date for February is the 28th.**



When [Count logs after the closing date as logs for this month] is checked, the logs for the day after the set deadline are counted in the current month.

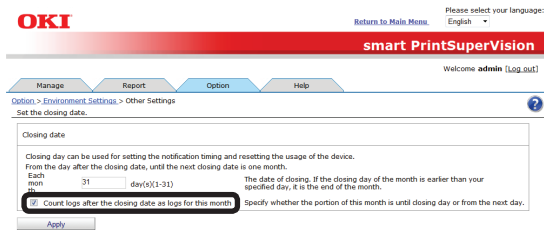

For example, if the closing date is set for the 15th and [Count logs after the closing date as logs for this month] is checked, the job log entries from February 16th to March 15th are collected as entries for February.



- 3 Click [Apply].

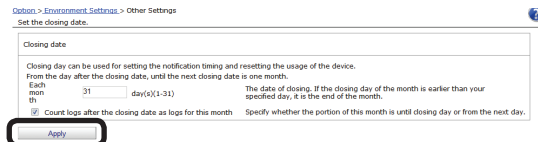

- 4 Click [OK] in the confirmation window.

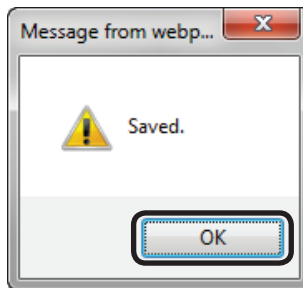

# 13. Environment Settings

---

Changing the Database Destination .....	207
Changing the Web Service Settings .....	208
Setting the Outgoing Mail Function .....	210
Setting the Outgoing Mail Function .....	210
Configuring the Settings for Notification Email.....	211
Sending Database Error Notification Email .....	213
Auto Status Refresh Service .....	214

# 13. Environment Settings

## Changing the Database Destination

The database to which data is saved can be changed.

**Note**

- Database settings can only be configured from computers on which sPSV is installed.
- Log in as a sPSV administrator to configure the settings.

- 1 Configure the settings from [Details Screen] > [Option] > [Database Settings].

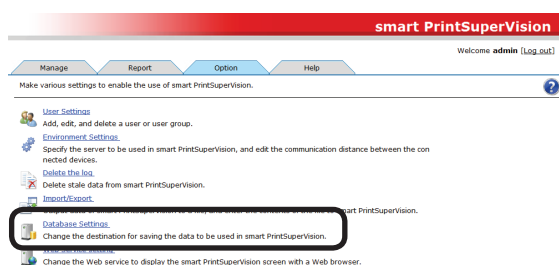

- 2 Select the type of database to which to connect from [Database Type]. The types of database that can be selected are Microsoft SQL Server Compact and Microsoft SQL Server.

The settings window varies depending on the type selected.

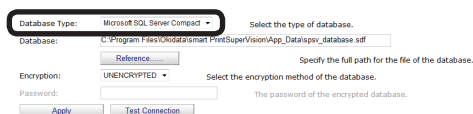

### <Microsoft SQL Server Compact>

**Memo**

This is installed when [Use database prepared during setup] is selected during setup of sPSV.

Configure the settings for each item.

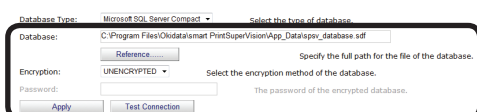

### [Database]

Enter the name of the database (\*.sdf). To specify a file, click [Reference...] and specify the file.

### [Encryption]

Specify the encryption method for the database.

#### [UNENCRYPTED]

Not encrypted.

#### [Platform Default]

Encrypted using AES128\_SHA256.

#### [Engine Default]

Encrypted using AES256\_SHA512.

### [Password]

Specify the password of the database to connect to. This does not need to be entered if [UNENCRYPTED] is specified.

### [Test Connection]

Performs a test connection with the above settings.

### <Microsoft SQL Server>

Configure the settings for each item.



### [Server]

Specify the name of the database server to which to connect.

(example: localhost\SQLEXPRESS)

### [Database]

Enter the name of the database to be used in sPSV.

### [Authentication Methods]

Specify the authentication method used when connecting to the database.

### [Windows Authentication]

Authenticated connection will be made using the Windows user permission registered in the database.

**[SQL Server Authentication]**

Authenticated connection will be made using the user permission for user authentication registered in the database.

**[Password]**

Specify the user authentication password for SQL Server. This does not need to be entered if [Windows Authentication] is specified.

**[User Name]**

Specify a user name for authentication with SQL Server. This does not need to be entered if [Windows Authentication] is specified.

**[Test Connection]**

Performs a test connection with the above settings.

**3** Click [Apply].

**4** Select the confirmation method in the connection method confirmation window.

**[Access]**

Connects to the existing database and restarts sPSV. Registered data is retained.

**[New]**

Creates a new database and restarts sPSV.

**Changing the Web Service Settings**

This section explains how to change the web service settings for displaying the management window.

**! Note**

- **Web service settings can only be configured from computers on which sPSV is installed.**
- **Log in as a sPSV administrator to configure the settings.**

- 1 Configure the settings from [Details Screen] > [Option] > [Web Service setting].

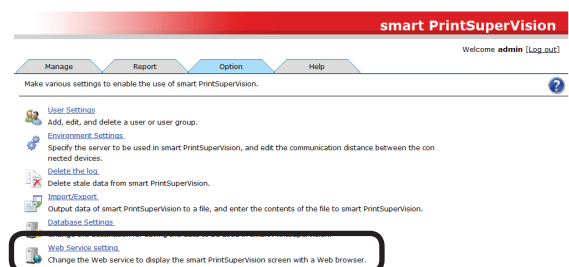

- 2 Select the web service to be used from [Web Service]. An embedded web service (EWS) or Internet Information Services (IIS) can be selected as the web service.

The setting window varies depending on the web service selected.

**<Web Service (EWS)>**

Configure the settings for each item.

**[Port Number]**

Specify the port number used by the EWS. (default: 50081, range: 1 - 65535)

**<Internet Information Services (IIS)>**

Configure the settings for each item.

**[Port Number]**

Specify the port number used by IIS.  
(default: 50081, range: 1 - 65535)

**[Web Site]**

Specify a website registered to IIS to be used by sPSV.

**3** Click [Apply].

Web Service: Embedded Web Service(EWS) Select the Web server. If you change the Web server, the input fields will change.  
Port Number: 50081 The port number used by EWS.  
Web Site:   
Apply

**4** Click [OK] in the confirmation window to restart sPSV and change the web service.**Check**

Restart the smart PrintSuperVision and change the Web service.

OK Cancel

## Setting the Outgoing Mail Function

Configure the settings for using the mail send function. The outgoing mail server, outgoing mail format, sender mail address and administrator mail address settings can be configured.

## Setting the Outgoing Mail Function

- 1 Configure the settings in the [Function Details] window > [Option] > [Environment Settings] > [Server Settings].

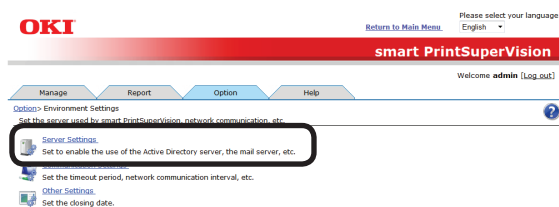

- 2 Click  in the [Mail Server] to open the file tree.

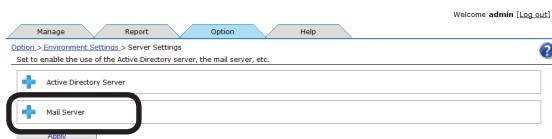

- 3 Configure the settings for each item.

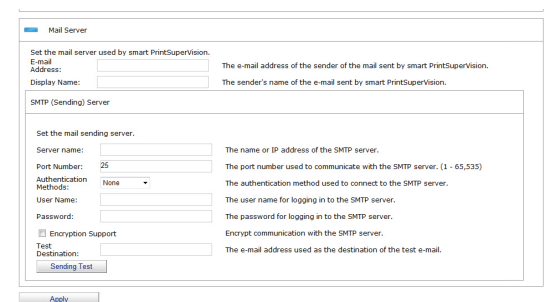

### [E-mail Address]

Enter the email address to be used as the sender address when sending email from sPSV.

### [Display Name]

Enter the sender name to be used in email from sPSV.

### [SMTP (Sender) Server]

Setting the mail sending server.

#### [Server name]

Enter the server name or IP address of the SMTP server. If the server name is unknown, contact the network administrator.

### [Port Number]

The port number used in communication with the SMTP server. This is usually [25]. (Range: 1 to 65535 hours)

### [Authentication Methods]

Select the authentication method used when connecting to the SMTP server.

#### [None]

Authentication is not performed.

#### [LOGIN]

A login is used for communication with the SMTP server.

#### [PLAIN]

PLAIN is used for communication with the SMTP server.

#### [CRAM-MD5]

CRAM-MD5 authentication is used for communication with the SMTP server.

### [User Name]

Enter the user name for the SMTP server.

### [Password]

Enter the password for the SMTP server.

### [Encryption Support]

Check this to encrypt of communication with the SMTP server.

### [Test Destination]

Enter the email address of the test destination.

### [Sending Test]

Click this to send a test email with the above settings.

- 4 Click [Apply].





## Configuring the Settings for Notification Email

- 1 Configure the settings from [Details Screen] > [Report] > [Notification Settings] > [Notification E-mail Settings].

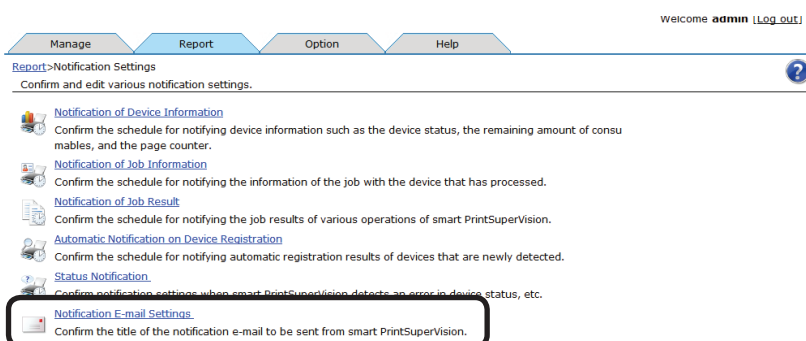

- 2 Click a notification type to move to the comment editing window.

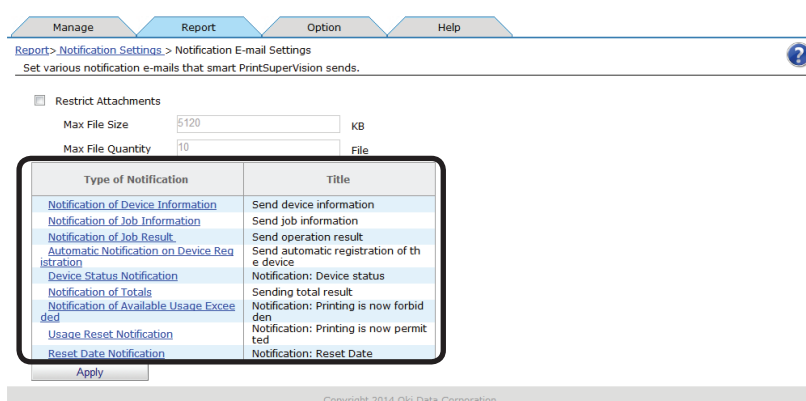

Item	Description
[Notification of Device Information]	Notification email registered to [Notification of Device Information].
[Notification of Job Information]	Notification email registered to [Notification of Job Information].
[Notification of Job Result]	Notification email registered to [Notification of Job Result].
[Automatic Notification on Device Registration]	Notification email registered to [Automatic Notification on Device Registration].
[Device Status Notification]	Notification email registered to [Status Notification].
[Notification of Totals]	Email sent to users/user groups indicated in the aggregation result notification settings.
[Notification when Available Usage is Exceeded]	Email sent to users/user groups indicated in the settings for notifications when the available usage is exceeded.
[Used Volume Reset Notification]	Email sent to users/user groups indicated in the reset notification settings.
[Reset Date Notification]	Email sent to users/user groups indicated in the settings for advance notifications of the end of the valid period.



**[Title]** and **[Header]** are displayed in English in each email notification template, but the template can be changed by entering text in the desired language and saving the template. One template (one language) can be saved for each type.

3 Click [Apply] after editing the content of the notification email.

### [Title]

Enter the title. (range: 0 to 255 characters)

### [Header]

Enter the header. (range: 0 to 1024 characters)

### [Footer]

Enter the footer. (range: 0 to 1024 characters)

4 Click [Apply].

Type of Notification	Title
<a href="#">Notification of Device Information</a>	Send device information
<a href="#">Notification of Job Information</a>	Send job information
<a href="#">Notification of Job Result</a>	Send operation result
<a href="#">Automatic Notification on Device Registration</a>	Send automatic registration of the device
<a href="#">Device Status Notification</a>	Notification: Device status
<a href="#">Notification of Totals</a>	Sending total result
<a href="#">Notification of Available Usage Exceeded</a>	Notification: Printing is now forbidden
<a href="#">Usage Reset Notification</a>	Notification: Printing is now permitted
	Notification: Reset Date

## Sending Database Error Notification Email

If additions to the log database fail, an email that contains the error details can be sent once a day to the administrator.



**The send mail server, sender's email address and administrator's email address need to be configured in advance according to "Setting the Outgoing Mail Function" (P. 210).**

- 1 Configure the settings from [Details Screen] > [Report] > [Notification Settings] > [Status Notification].

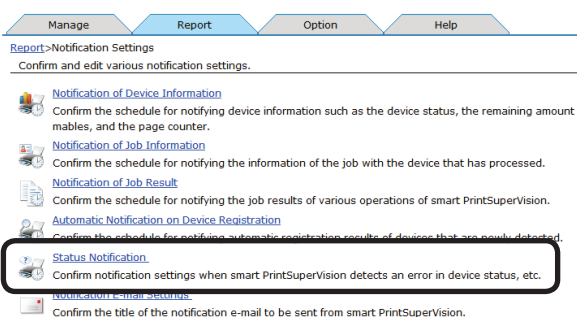

- 2 Click [Add Status Notification Conditions].

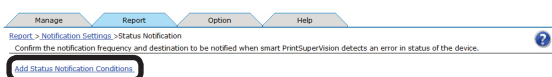

- 3 In [Monitoring Target], check [System] to display the detailed settings.

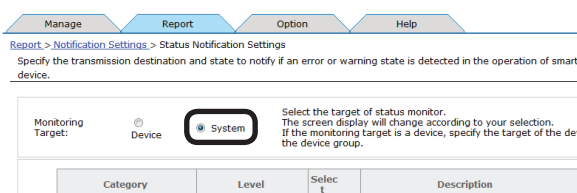

- 4 Check [Database].

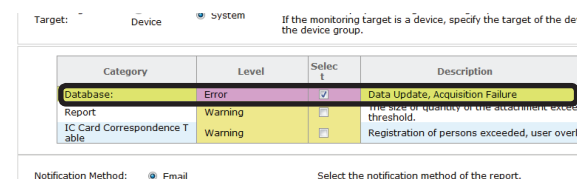

- 5 Set the destination and interval for sending notifications.

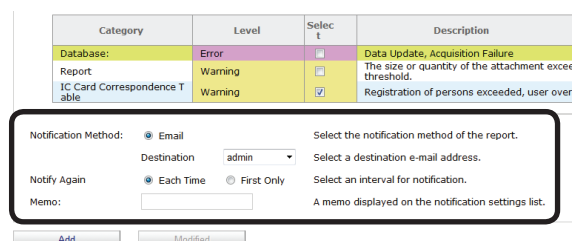

### [Notification Method]

Select the notification method.

### [Email]

A report is sent to the users or user groups specified in [Destination] by email.

### [Destination]

Specify the destination users or user groups. If the destination is a user group, notifications are sent to all members of the group (excluding users without a registered email address).

### [Notify Again]

Specify the date, time and interval for notification.

### [Each Time]

A notification is sent each time an error is detected.

### [First Only]

A notification is sent the first time an error is detected.

### [Memo]

Enter content to be displayed in the notification schedule list for registered notifications. (range: 0 to 255 characters).

- 6 Click [Add].

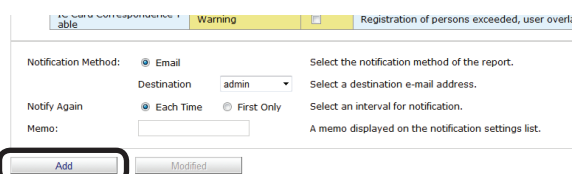

## Auto Status Refresh Service

It is possible to regularly monitor device information and user/user group information for registered devices and update the information if there are any changes. Monitoring of auto status refresh is enabled by default, but the monitoring schedule settings can be changed.



**When a new user that belongs to a group that is to be monitored in the Active Directory is added, users can be registered to the device until the maximum number of users that can be registered to the device is reached. After the maximum number of users that can be registered is reached, subsequent users are not registered to the device.**

- 1 Set in [Details Screen] > [Option] > [Environment Settings] > [Communication Settings].

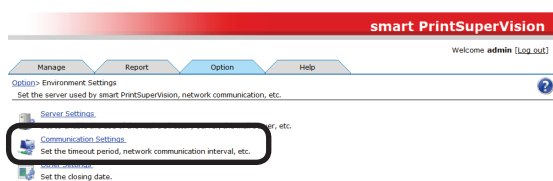

- 2 Click  in [Communication Interval] to open the settings window.

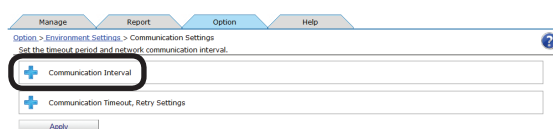

- 3 Set the [Communication Interval].

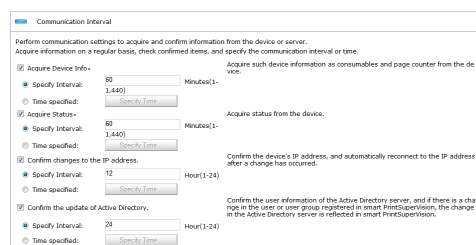

### [Acquire Device Info]

Specify the interval at which to acquire information such as consumables remaining and the remaining life of maintenance items.

### [Specify Time]

Updated for each set interval. (Range: 1 to 1440 minutes)

### [Time specified]

Set the specific update time. Click [Specify Time] and add the time. After adding, click [OK].

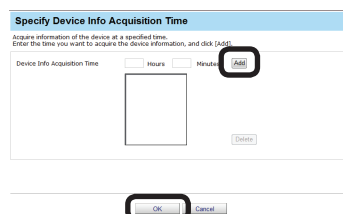

### [Acquire Status]

Specify the interval at which to acquire status information.

### [Specify Time]

Updated for each set interval. (Range: 1 to 1440 minutes)

### [Time specified]

Set the specific update time. Click [Specify Time] and add the time. After adding, click [OK].

### [Confirm changes to the IP address.]

Specify the interval at which to check the IP address of the device. sPSV automatically reconnects if the IP address has changed.

### [Specify Time]

Updated for each set interval. (Range: 1 to 24 hours)

### [Time specified]

Set the specific update time. Click [Specify Time] and add the time. After adding, click [OK].

### [Confirm the update of Active Directory.]

Specify the interval at which to check the Active Directory user and group status and update the user settings.

(Range: 1 to 24 hours)

- 4 Click  in [Communication Timeout, Retry Settings] to open the settings window.

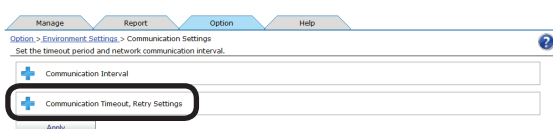

- 5 Configure the [Communication Timeout, Retry Settings].

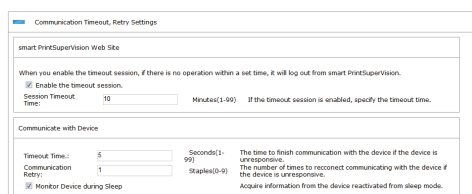

## [smart PrintSuperVision Webpage]

Configure the settings for cases in which there are no operations in smart PrintSuperVision for a set period of time.

### [Enable session timeout.]

Check this to log out of smart PrintSuperVision if there are no operations for a set period of time.

### [Session Timeout Time]

If session timeout is enabled, enter the period of time (minutes) after which a session timeout will occur  
(range: 1-99 minutes, default: 10 minutes).

## [Communicate with Device]

### [Timeout Time]

Enter the time (seconds) after which communication with a device times out if there is no response from the device.  
(range: 1-99 seconds, default: 5 seconds)

### [Communication Retry]

Enter the number of times communication with a device is retried if there is no response from the device.  
(range: 0 - 9 times, default: 1 time)

### [Monitor Device during Sleep]

Check this to wake devices from sleep mode and acquire information if information cannot be acquired due to the device being in sleep mode.

- 6 Click [Apply].

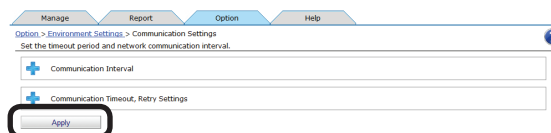

# 14. Other Functions

---

Receiving Email Notifications of Job Results .....	217
Limiting the Size and Number of Attachments .....	218
Deleting Registered Devices .....	218
If the Device Connection Destination or IP Address Has Been Changed .....	219
Automatically Reconnecting When the Device IP Address Is Changed.....	220
Back Up/Restore .....	221
To Change Device Management to a Different Computer .....	222
Checking the Server ID.....	223
Registering the Installation Position of Devices Belonging to a Management Group .....	223

# 14. Other Functions

## Receiving Email Notifications of Job Results

You can receive email notifications of job log acquisition statuses, acquisition of statuses, etc., job results for processes such as checking the IP address of devices, and user login histories.

- 1 Configure the settings from [Details Screen] > [Report] > [Display Report] > [Job Result].

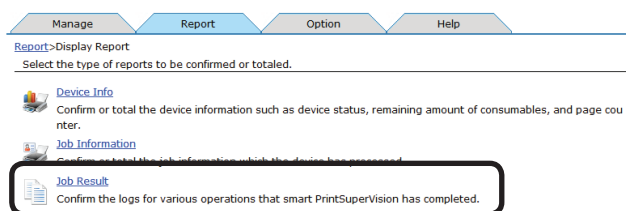

- 2 Click  in [Notification Settings] to open the file tree.

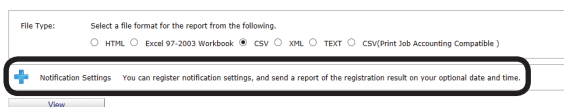

- 3 Configure the settings for each item.

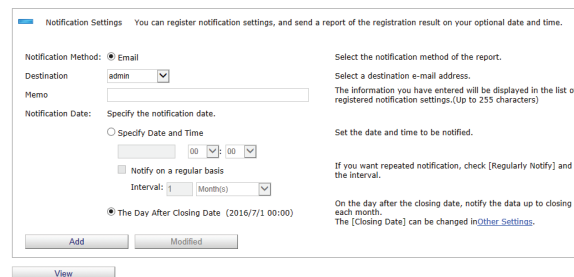

### [Notification Method]

Select the notification method.

#### [Email]

A report is sent to the users or user groups specified in [Destination] by email.

#### [Destination]

Specify the destination users or user groups. If the destination is a user group, notifications are sent to all members of the group (excluding users without a registered email address).

### [Memo]

Enter content to be displayed in the notification schedule list for registered notifications. (range: 0 to 255 characters)

### [Notification Date]

Specify the date, time and interval for notification.

### [Specify Date and Time]

Specify the date and time for notification.

To receive notifications repeatedly, check [Notify on a regular basis] and specify the interval.

- [Day(s)]  
Notifications are sent daily.
- [Each Weeks]  
Notifications are sent weekly on the same day of the week as the date specified in [Specify Date and Time].
- [Month(s)]  
Notifications are sent monthly on the same day of the month as the date specified in [Specify Date and Time].

### [The Day After Closing Date]

Notifications are sent at 0:00 on the day after the closing date.



For information on the closing date settings, see "Changing the Closing Date" (P. 205).

- 4 Click [Add] if registering a new notification schedule or [Modified] if modifying an existing notification schedule.

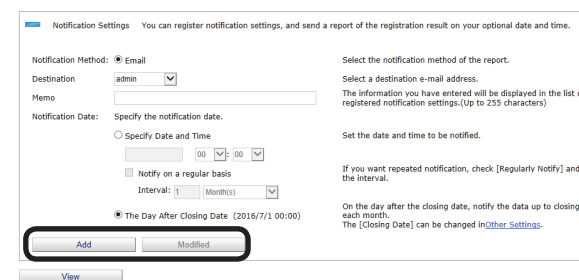

## Limiting the Size and Number of Attachments

The size and number of attachments can be limited, and sent separately in different email.

- 1 Limit the size and number of attachments from [Details Screen] > [Report] > [Notification Settings] > [Notification E-mail Settings].

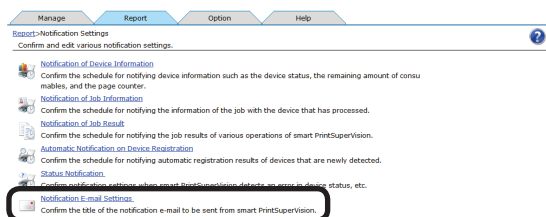

- 2 Check [Restrict Attachments] and enter a [Max File Size] and [Max File Quantity].

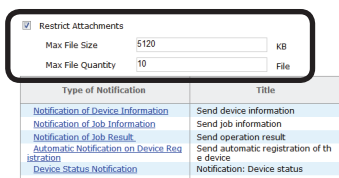

### [Max File Size]

(Range: 1-1048576 KB, default setting: 5120 KB)

### [Max File Quantity]

(Range: 1-50, default setting: 10)

- 3 Click [Apply].

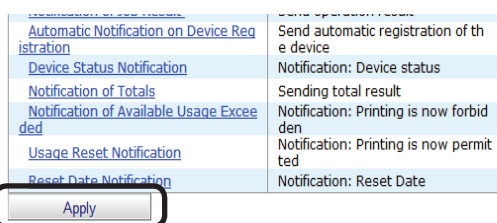

**When the size limit is exceeded for 1 file, mail is sent notifying that the attachment cannot be sent.**

## Deleting Registered Devices

To remove a device from management by SPSV because the device is to be moved or scrapped, delete the device from the server software before moving or scrapping it.



**Acquisition of job logs needs to be stopped first by following the steps in "Stopping Job Log Acquisition" (P. 198).**

- 1 Delete registered devices from [Details Screen] > [Manage] > [Device List].

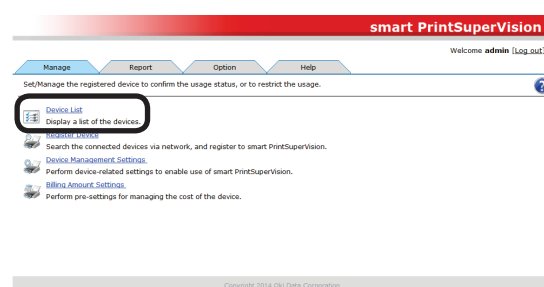

- 2 Check the device to be deleted and click [Delete].

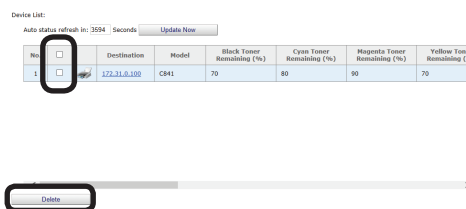

**Multiple devices can be selected.**

- 3 A confirmation message is displayed. Click [OK] to delete the selected devices.

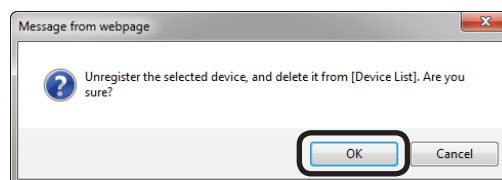

**An error message appears if a device currently recording to its job log is selected for deletion.**



- In the confirmation window, select the item for deregistering along with deletion and click [OK] to delete the selected device.

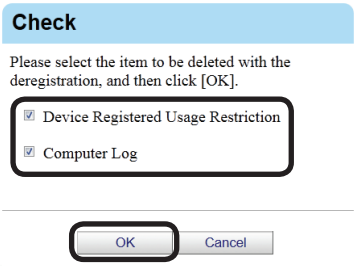

## If the Device Connection Destination or IP Address Has Been Changed

If the device connection destination or IP address has been changed, change the device settings.

- Change the device settings in [Function Details] > [Manage] > [Device Management Settings] > [Device Settings].

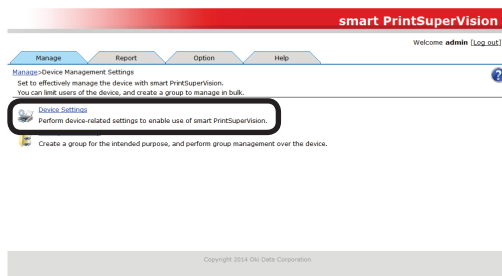

- Select the device to configure from [Device].

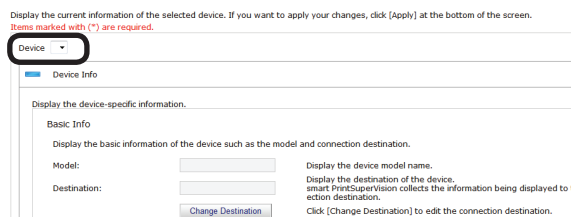

- Click [Change Destination] in [Basic Info] to change the destination.

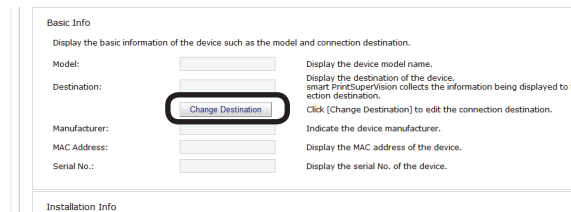

- 4 To change the connection destination, select the connection destination from the list and click [OK].

To change the IP address, enter a new IP address, and click [OK].

**Change Destination**

Specify [Destination] to change the connection destination of the device.  
If you specify [Network] to the destination, enter the IP address of the device in [IP address].

Destination: Network

IP Address:

OK Cancel

- 5 Click [Apply].

Communication Info

Display the device-specific information for smart PrintSuperVision to communicate with the device.

Device Password(\*):  Display the password of the device administrator.

SNMP Read Community Name(\*): public Display the SNMP Read community name of the device.

SNMP Write Community Name(\*): private Display the SNMP Write community name of the device.

Log/Access Control

Apply

When the "Enter an administrator password for the device" window is displayed, enter the administrator password for the device and click [OK].



- Depending on the device, this may not be displayed.
- For details on the device's factory set administrator password, see the User's Manual of the device.

- 6 Click [OK] in the confirmation window.

Message from webpage

Apply the changes.  
Are you sure?

OK Cancel

## Automatically Reconnecting When the Device IP Address Is Changed

When the device IP address is changed, the new IP address can be automatically connected, and the log can still be acquired. This is effective when the IP address is dynamically assigned in the DHCP environment, or when the administrator changes the IP address.

- 1 Specify the interval at which to check for changes to the device IP address from [Details Screen] > [Option] > [Environment Settings] > [Communication Settings].

smart PrintSuperVision

Welcome admin! (Log out)

Management Report Option Help

Option > Environment Settings > Communication Settings

Set the timeout period and network communication interval.

Communication Settings

Set the timeout period, network communication interval, etc.

Set the issuing date.

- 2 Click + in [Communication Interval] to open the [Communication Interval] settings window.

Management Report Option Help

Option > Environment Settings > Communication Settings

Set the timeout period and network communication interval.

Communication Interval

Communication Timeout, Retry Settings

Apply

- 3 Check [Confirm changes to the IP address] and enter the interval at which to confirm the IP address.

Communication Interval

Perform communication settings to acquire and confirm information from the device or server.  
Acquire information on a regular basis, check confirmed items, and specify the communication interval or time.

Acquire Device Info- Acquire such device information as consumables and page counter from the device.

Specify Interval: 60 Minutes(1,440)

Time specified: Specify Time

Acquire Status- Acquire status from the device.

Specify Interval: 60 Minutes(1,440)

Time specified: Specify Time

Confirm changes to the IP address- Confirm the device's IP address, and automatically reconnect to the IP address for a change has occurred.

Specify Interval: 12 Hour(1-24)

Time specified: Specify Time

Confirm the update of Active Directory- Confirm the user information of the Active Directory server, and if there is a change in the user or user group registered in smart PrintSuperVision, the change in the Active Directory server is reflected in smart PrintSuperVision.

Specify Interval: 24 Hour(1-24)

Time specified: Specify Time

Communication Timeout, Retry Settings

- 4 Click [Apply].

Management Report Option Help

Option > Environment Settings > Communication Settings

Set the timeout period and network communication interval.

Communication Interval

Communication Timeout, Retry Settings

Apply



**Perform the following steps to change the range in which to search for devices whose IP address has changed.**

- 1 Change the range in which to search for devices whose IP address has changed from [Details Screen] > [Manage] > [Register Device] > [Specify Search Range].

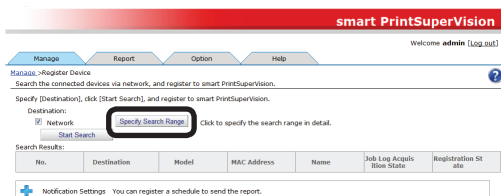

- 2 To add a search range, enter the range of IP addresses to be searched in [Network Search Range] and click [Add]. Either broadcast IP addresses or unicast IP addresses can be added.

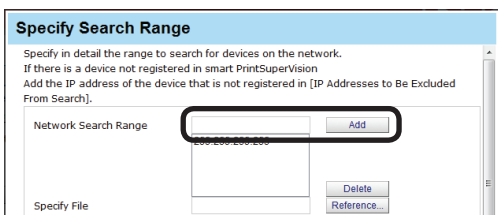

- 3 To delete a search range, select the search range to be deleted from the search range list, and click [Delete].

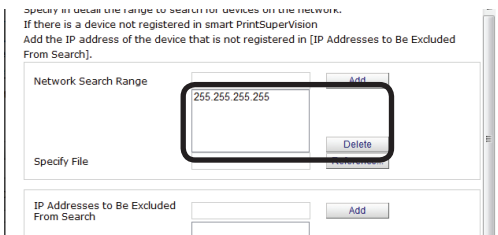

- 4 Click [OK].



## Back Up/Restore

Information in sPSV databases can be backed up.

The files containing the backed up information can be restored on other computers where sPSV is installed.

This makes it possible to manage the information on another computer in the event of a malfunction in the computer currently being used.



- Imports and exports can only be configured from computers on which sPSV is installed.
- Log in as an sPSV administrator to configure the settings.

- 1 Configure the settings from [Details Screen] > [Option] > [Import/Export].

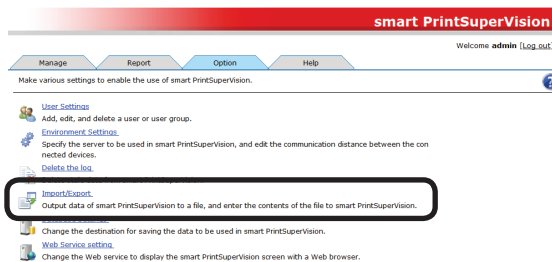

### <Backing up>

- (1) Select [Export], and click [Execute].
- (2) Click [Save] in the web browser dialog window.

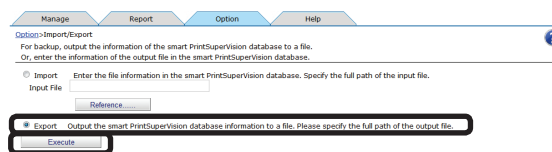

### <Restoring>

- (1) Select [Import], and click [Reference...].
- (2) Select the file to be imported and click [Execute].

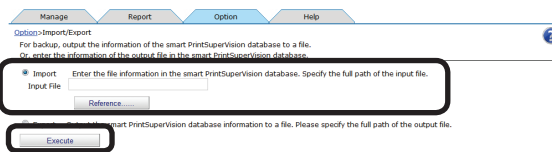

**Store exported files on a different computer.**

# To Change Device Management to a Different Computer

To change the server that currently acquires the job log to a different computer, delete the device on the current server (P. 218), and then re-add it to the new server. (P. 119)

However, if the current server cannot be used due to a malfunction etc., perform the following operations on the new server.



**The server ID of the current server needs to be checked before changing the server. For information on checking the server ID, see "Checking the Server ID" (P. 223).**

- 1 Check that the power of the device is turned on.
- 2 Start the server software on the new server and then register the device.
- 3 Configure the server ID settings in [Function Details] > [Manage] > [Device Management Settings] > [Device Settings].

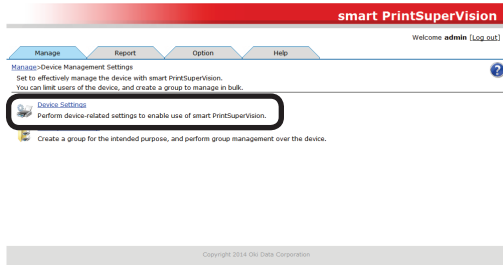

- 4 Click in [Log/Access Control] to open the settings window.

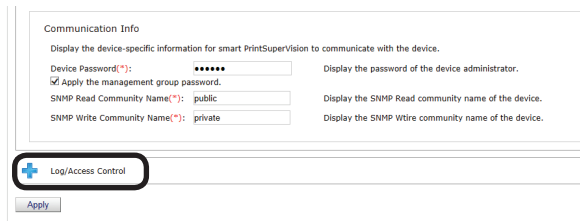

- 5 Check [Record Job Log to Device].

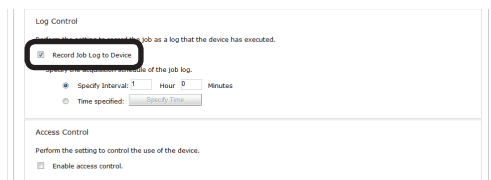

- 6 Click [Apply].

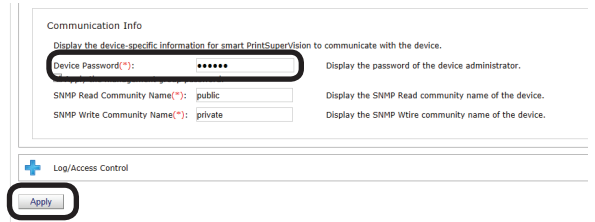

When the "Enter an administrator password for the device" window is displayed, enter the administrator password for the device and click [OK].



- Depending on the device, this may not be displayed.
- For details on the device's factory set administrator password, see the User's Manual of the device.

- 7 When the [Check Server ID] window is displayed, enter the server ID of the server that acquires the current job log, and click [OK].



Some devices have been set to acquire the log from other servers. To switch to acquiring the log from the device, please enter the ID of the server that is being acquired from.



- 8 Continue setup by following the instructions on the screen.

## Checking the Server ID

- 1 Check the server ID from [Details Screen] > [Help] > [Version Info].

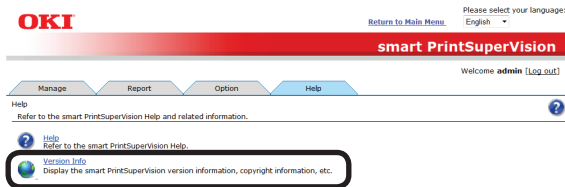

- 2 Check the server ID.

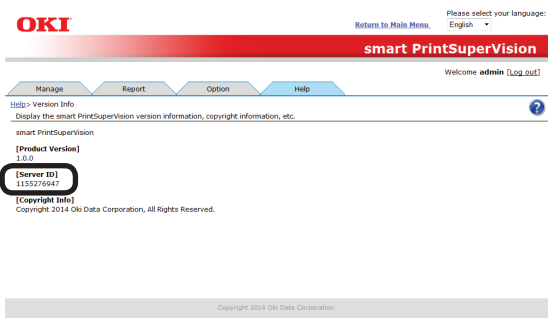

## Registering the Installation Position of Devices Belonging to a Management Group

Icons for devices belonging to a management group can be displayed on a map image to visually indicate their installation location.

- 1 Configure the settings from [Details Screen] > [Manage] > [Device Management Settings] > [Management Group].

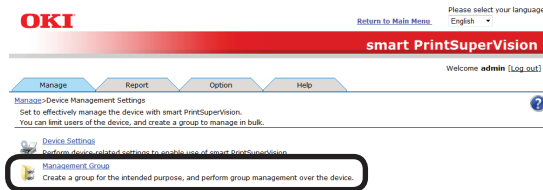

- 2 Click the management group to be arranged on a map from [Group name].

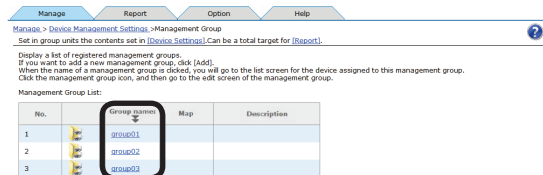

- 3 Click [Reference...] and specify a map image.

Memo

**Standard image files (\*.jpg, \*.bmp, \*.gif, \*.png) can be specified as map images.**

- 4 Click [Apply].

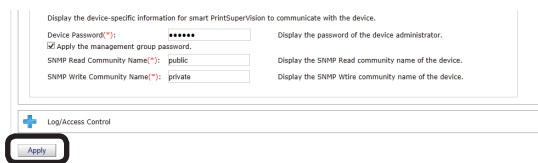

- 5 Click [OK] in the confirmation window.

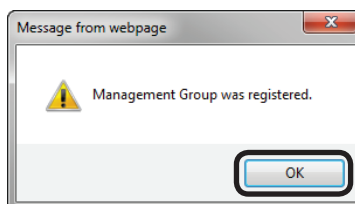

6 Click [Management Group List] in [Map].

management group info

Enter the information of the management group.

Name(\*):  The name of the management group to be registered. (Up to 32 characters)

Description:  Enter a description for the management group. (Up to 255 characters)

Map:  You can visually grasp the setting position by putting the device on the specified image file. To configure the device, click the map icon **[Management Group List]**.

Fees:  Indicate the cost information for displaying job information in [Billing Amount]. To add new cost information, [Billing Amount Settings] can be used to add.

Device Password(\*):  enter the administrator password of the device. The assigned device will access the device with the password entered here.

SNMP Read Community Name (\*):  Enter the SNMP Read community name of the device. The assigned device will access the device with the community name entered here.

7 Click the map icon (  ) of the management group to be arranged on a map.

Management Group List

No.	Group icon	Map	Description
1			
2			
3			

8 Select a device to be arranged from [Assigned Device].

Assigned Device:  Save



9 Move the cursor to the installation position of the device on the map and click that spot.

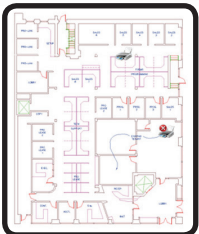

10 Click [Save].

Assigned Device:  Save



# 15. Uninstalling the Software

---

Uninstalling sPSV .....	226
Deleting the Print Job Accounting Client Software (Windows) .....	227
Deleting the Print Job Accounting Client Software (Mac OS X).....	227

# 15. Uninstalling the Software

## Uninstalling sPSV

If uninstalling sPSV, make sure to delete all registered devices before uninstalling sPSV.

- 1 Delete devices registered to sPSV according to "Deleting Registered Devices" (P. 218).
- 2 Exit sPSV.
- 3 Select [Start] - [All Programs] > [Oki Data] > [smart PrintSuperVision] > [Uninstall smart PrintSuperVision]. When the [User account management] window is displayed, click [Continue] or [Yes].
- 4 Click [Next].

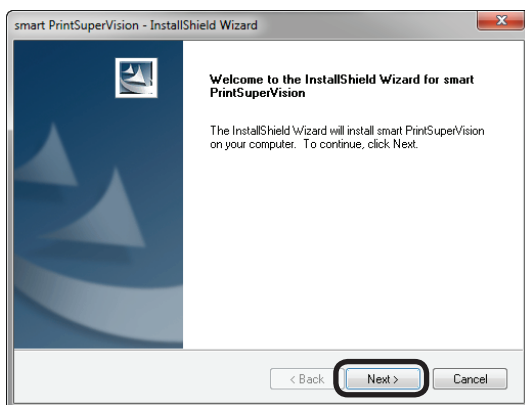

- 5 Click [Yes] in the confirmation window saying [Do you want to completely remove the selected application and all of its functions?].

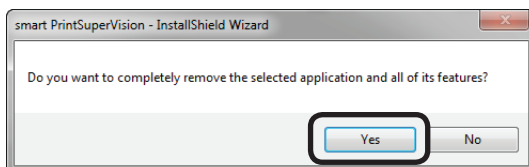

- 6 Click [Yes] in the confirmation window saying [Do you want to delete the smart PrintSuperVision databases?].

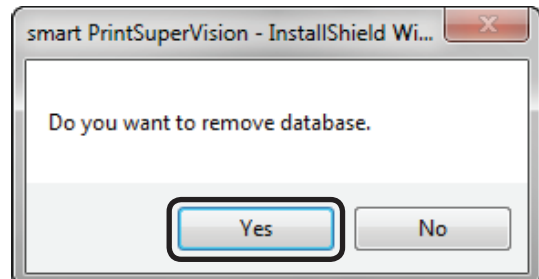

- 7 Click [Finish].

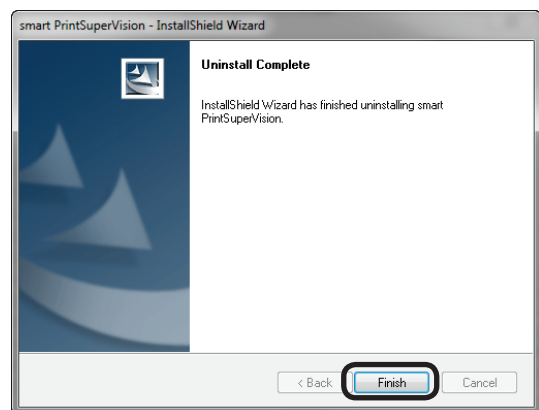

### ! Note

**When the following window is displayed, the device has not been deleted. Always click [No] to cancel the uninstallation, then delete the devices before uninstalling sPSV.**

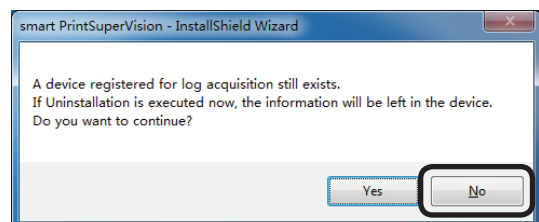



## Deleting the Print Job Accounting Client Software (Windows)

- 1 Quit the print job accounting client software if it is running.
- 2 Select [Start] > [All Programs] > [Oki Data] > [Print Job Accounting Client] > [Uninstall Print Job Accounting Client].



**When the [User account management] window is displayed, click [Continue] or [Yes].**

- 3 Follow the instructions on the screen to uninstall.
- 4 Click [Finish].



**Restart the computer when a window instructs you to do so.**

## Deleting the Print Job Accounting Client Software (Mac OS X)

Delete the print job accounting icon that was copied to the desired location during installation.

# **16. Troubleshooting**

---

## 16. Troubleshooting

This chapter explains some of the problems that could possibly occur when using sPSV, and provides hints to their solutions.

Item	Details
<p>Cannot register use restrictions to the device or acquire use restrictions that are registered to the device.</p>	<p>Communication with the device may fail in an environment where use of a proxy server is set using a browser. Configure the settings so that a proxy server is not used for communication with the device. (Internet Explorer is used as an example in the procedure.)</p> <ol style="list-style-type: none"> <li>(1) Click the [Tools] menu &gt; [Internet Options] in Internet Explorer to display the [Internet Options].</li> <li>(2) Select the [Connections] tab.</li> <li>(3) Click [LAN Settings] to display the [Local Area Network (LAN) Settings].</li> <li>(4) Click [Advanced] under [Proxy Server] to display the [Proxy Settings].</li> <li>(5) Enter the IP address of the device in [Exceptions] and click [OK].</li> <li>(6) Click [OK] in [Local Area Network (LAN) Settings].</li> <li>(7) Click [OK] in [Internet Options].</li> </ol>
<p>The device is not found when searching for devices using [Register Device].</p>	<ul style="list-style-type: none"> <li>- Check that the power of the device is turned on.</li> <li>- Check whether the device is processing or offline, or whether an error has occurred (no paper, etc.). Check that the device is online, and click [Start Search].</li> <li>- Check the network connection status.</li> <li>- Check that the correct search option check boxes are checked.</li> <li>- When the search target is [Network], check whether the broadcast address is correct. If you are unsure of any items, check [Specify Search Range].</li> <li>- Broadcast (255.255.255.255) or multicast (xxx.xxx.xxx.255, etc.) communication may be restricted. Specify the IP address of the device directly as the search range.</li> <li>- If the [Do not allow exceptions] check mark is checked in the Windows Vista or later firewall settings, devices cannot be searched beyond the router segments. Therefore, select [Network] in [Destination], and add the IP address to [Network Search Range] in [Specify Search Range].</li> </ul>

Item	Details
<p>When adding devices or changing settings or when directly acquiring the job log, the "Cannot connect to printer. Please wait for a while then try again.", "Cannot connect to the printer. Please check the printer." or "Printer is busy. Please wait for a while then try again." message is displayed.</p>	<ul style="list-style-type: none"> <li>- Check that the power of the device is turned on.</li> <li>- Check whether the device is processing or offline, or whether an error has occurred (no paper, etc.). Check that the device is online and try again.</li> </ul>
<p>When the ID file for setting the hide Mode in the client software is imported, "An error was found in the import file" error message is displayed.</p>	<ul style="list-style-type: none"> <li>- Check whether the CSV file format is correct.</li> <li>- Check that the user names and IDs do not exceed the registration range. The user ID is registered from 1 to 999999999 (one-byte characters), and user name within 80 characters.</li> <li>- Check that the "symbol is not included in the user names. Names that include" cannot be registered.</li> </ul>
<p>When printing, the print job is automatically cancelled and cannot be executed.</p>	<ul style="list-style-type: none"> <li>- Check whether the user ID used to print is set to "Printing Prohibited" or "Color Printing Prohibited".</li> <li>- Check whether the limit value for the user ID is exceeded, and check the limit values and valid period.</li> <li>- The operation when log is full is set to "Cancel the job", and the device log buffer is full. Check [Acquire the device status before the job.] in [Details Screen] &gt; [Report] &gt; [Display Report] &gt; [Job Information], click [View] and acquire the job log stored in the device. Next, reset the job log acquisition schedule to a shorter time.</li> </ul>
<p>The job log cannot be acquired according to the set schedule.</p>	<p>Click [Update Now] in [Details Screen] &gt; [Manage] &gt; [Device List]. When an error is displayed, check that the device power is ON. Also, check whether the device is processing or offline, or whether an error has occurred (no paper, etc.). Check the job log acquisition schedule when the device power is ON but the printer is not processing or offline, or an error has not occurred (no paper, etc.). Check that the acquisition time is at the same time as when the device and server power are usually ON. If there are no problems in the above settings, restart Windows.</p>
<p>Not all of the job logs are acquired.</p>	<p>The operation when log is full is set to "Delete Old Logs" or "Do not acquire log", and the device log buffer is full. Reset the job log acquisition schedule to a shorter time.</p>
<p>Some job logs are not displayed at the start time or end time.</p>	<p>If the device does not have a built-in clock, when the device power is switched OFF/ON, time information cannot be stored in the log until the device is notified of the time. For information on how to notify the device of the time, see "Providing Time Notifications for Devices" (P. 194). For devices that have a built-in clock, the time needs to be set in the device.</p>

Item	Details
When attempting to delete the device, the "Perform after acquisition of the log is complete" message is displayed.	A device cannot be deleted while the job log is being acquired. For details, see "Deleting Registered Devices" (P. 218).
[Acquired by Other Servers] is displayed in [Job Log Acquisition State] of the [Device List].	Either the job log is set to be acquired by a different server, or the device flash memory was initialized. Select the device in [Details Screen] > [Manage] > [Device Management Settings] > [Device Settings], and then uncheck and recheck [Record Job Log to Device]. When the device is set to acquire the job log from a different server, see "To Change Device Management to a Different Computer" (P. 222).
Cannot perform menu printing or demo printing from the control panel of the device.	<ul style="list-style-type: none"> <li>- Check whether local print is set to printing prohibited or color printing prohibited.</li> <li>- Check the available usage and valid period to ensure that the local print available usage is not exceeded.</li> </ul>
Cannot initialize the flash memory from the device control panel. Also, the hard disk or SD memory card cannot be initialized for devices equipped with an internal hard disk or SD memory card.	In this state, the flash memory, built-in hard disk and SD memory card cannot be initialized. Delete the device according to "Deleting Registered Devices" (P. 218), and initialize the flash memory, built-in hard disk or SD memory card. After initializing, select the [Printer] menu > [Add a Printer], and follow the steps to re-add the device.
Cannot access sPSV from the web browser.	<ul style="list-style-type: none"> <li>- Check the address where sPSV is installed.</li> <li>- Check that OKI sPSVService has started.</li> </ul>

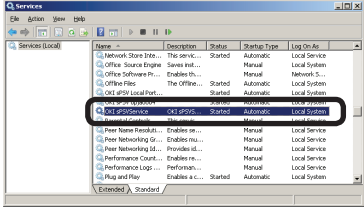
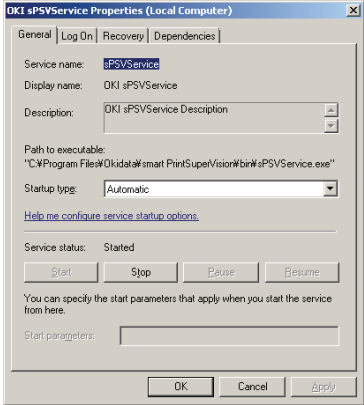
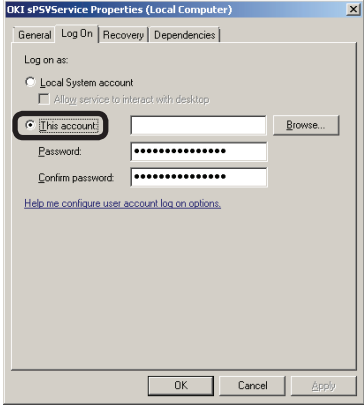
Item	Details
<p>An authentication error occurred and the settings could not be configured, even though Microsoft SQL Server was specified as the database to connect to and [Windows Authentication] was specified as the authentication method in [Database Settings].</p>	<p>If the database settings cannot be configured in Microsoft SQL Server with Windows authentication from the user account used by the sPSV Service for logging in, the user account settings need to be changed. Follow the steps below to change the settings. (These instructions are for Windows 7.)</p> <p>(1) Open [Control Panel] &gt; [System and Security] &gt; [Administrative Tools] &gt; [Services] and stop [Oki sPSVService].</p>  <p>(2) Open the [Oki sPSVService] properties.</p>  <p>(3) Display the [Login] tab and select [Account].</p> 
<p>If the sPSV service is not used and the device settings are changed, the sPSV settings are not reflected in the device.</p>	<p>Delete the device from the sPSV service, and then add the device to the sPSV service. You can unify the sPSV service setting status with the device setting status.</p>

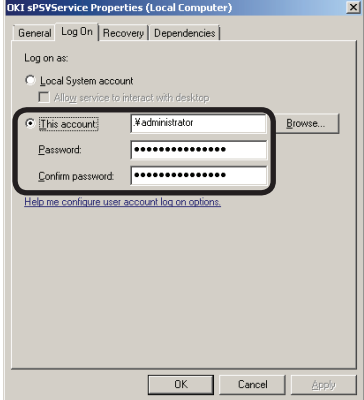
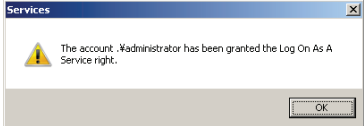
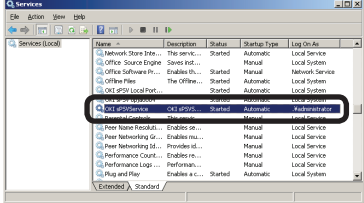
Item	Details
	<p>(4) Enter the user account and password used by the sPSV Service for logging in and click [OK]. When entering the user account, specify a user account that enables the following:</p> <ul style="list-style-type: none"> <li>- Logging in to Microsoft SQL Server with Windows authentication</li> <li>- Creating and updating databases.</li> </ul>  <p>(5) When a message saying [The account %the account specified in (4)% has been granted the Log On As A Service right.] is displayed, click [OK].</p>  <p>(6) The sPSV service starts.</p> 

## **17. Frequently Asked Questions (FAQ)**

---



# 17. Frequently Asked Questions (FAQ)

This section provides the answers to frequently asked questions about sPSV.

Q	A
How to configure the settings in sPSV when a user has been added to an Active Directory user group?	Follow the steps below. (1) Add User A to User Group A in Active Directory. (2) Update Active Directory in sPSV. ⇒ P. 47
How to configure the settings in sPSV when a user has been removed from an Active Directory user group?	Follow the steps below. (1) Delete User A from User Group A in Active Directory. (2) Update Active Directory in sPSV. ⇒ P. 47
How to configure the settings in sPSV when a user has been moved from one Active Directory user group to another?	Follow the steps below. (1) Move User A from Group A to Group B in Active Directory. (2) Update Active Directory in sPSV. ⇒ P. 47
A user cannot print even though the usage limit for the device limit has not been exceeded.	If available usage is set for a user group and [Include in the total usage of the assigned user group.] is checked in [User Settings] > [Available Usage] for the users in the group, the members of the group can no longer print once their total usage exceeds the limit for the group. Example 1: If 100 printed sheets are set as the available usage for User Group A <ul style="list-style-type: none"> <li>• If User A prints 40 sheets and User B prints 60 sheets, all members in User Group A can no longer print.</li> </ul> Example 2: If 100 printed sheets are set as the available usage for User Group A and users in the group print on multiple devices <ul style="list-style-type: none"> <li>• If User A prints 40 sheets on Device A, User B prints 50 sheets on Device B and User C prints 10 sheets on Device C, all members in User Group A can no longer print.</li> </ul> To print again, see "Setting the Available Usage" (P. 170) and change the maximum available usage.
Can a user print even if the user group they belong to has reached its maximum available device usage?	If User A belongs to multiple user groups, their available usage is judged according to the maximum for the group for which the highest priority is set. Example: If User Group B has a higher priority than User Group A <ul style="list-style-type: none"> <li>• If User A belongs to both groups, User A can print up to the limit for User Group B.</li> </ul> To change the maximum available usage, see "Changing Fee Charge Definitions" (P. 177). To change the priority levels, see "Changing the Priority Level of User Group" (P. 171).

Q	A
<p>When trying to print color data in monochrome, it did not print, even though the use restriction is set to [Print In Mono].</p>	<p>If multiple conditions are set for use restrictions, the stronger restriction is applied.            Example: If [Print In Mono] is set for the user name "user01") and [Prohibit Printing] is set for the host name "PC01")</p> <ul style="list-style-type: none"> <li>• Printing is not possible when User A (user01) gives a print command from Computer A (PC01).</li> </ul> <p>To change the use restriction settings, see "9. Restricting Device Use" (P. 143).</p>
<p>Excel file (Excel 97-2003 format) print attempt failed.</p>	<p>".xls") is specified as the [Document Name] in the use restrictions and [Prohibit Printing] is set as a [Restricted Item].            To change the use restriction settings, see "Adding Manually" (P. 157).</p>
<p>Unable to change passwords.</p>	<p>For information on how to change passwords, see "Changing User/User Group Information" (P. 135).</p>
<p>How to assign administrator authority to another user.</p>	<p>Add the user to receive administrator authority as a member of a user group for which [Assign to the admins user group.] is checked.            For information on how to add users, see "Changing User Group Assignment" (P. 136).</p>

# **18. Terms**

---

## 18. Terms

### **Active Directory**

A directory service developed by Microsoft and included in Windows.

### **CN (Common Name)**

An attribute used for LDAP services, denoting a person's name.

### **DC (Domain Component)**

An attribute used for LDAP services, denoting a domain name element.

### **LDAP (Lightweight Directory Access Protocol)**

A communication protocol for accessing directory services.

### **MAC address (Media Access Control address)**

A unique physical address assigned to a device connected to a network.

### **Microsoft SQL Server**

A relational database management system developed by Microsoft.

### **Microsoft SQL Server Compact**

A compact relational database management system developed by Microsoft.

### **OU (Organization Unit)**

An attribute used for LDAP services, denoting a department name.

### **PIN (Personal Identification Number)**

An identification number used to verify a user's identity.

### **SMTP (Simple Mail Transfer Protocol)**

A protocol for sending email via the Internet.

### **SMTP authentication (SMTP-AUTH)**

User authentication performed using an SMTP server. Authentication methods include login, PLAIN and CRAM-MD5.

### **LOGIN**

A user authentication method using plain text.

### **PLAIN**

A user authentication method using plain text, as with the login method.

### **CRAM-MD5**

A user authentication method performed by using challenge-response authentication.

### **SNMP (Simple Network Management Protocol)**

A protocol for monitoring and controlling devices connected to a network.

### **Web service (EWS [Embedded Web Services])**

Inbuilt web server software used if the environment where sPSV is installed does not contain IIS.

### **Internet Information Services (IIS)**

The standard Windows web server service, which supports basic protocols such as HTTP/HTTPS, FTP, SMTP and NNTP.

### **Secure Protocol**

A protocol that uses encoding and authentication technology to communicate safely with remote computers.

### **Broadcast format**

A form of data communication in which data is conveyed from one user to an unspecified large number of other users by specifying all destinations in the same data link.

### **Buffer**

A memory device or memory domain that temporarily stores data to compensate for differences in processing speed or transfer speed when data is sent or received by multiple independent users.

### **Port number**

A sub-address assigned after the IP address so that network connections can be made to multiple destinations at the same time. Port numbers from 0 to 65535 can be used.

**Unicast format**

A form of one-on-one data communication using a single address.

# 19. Resources

---

List of Available Functions .....	242
Information That Can Be Acquired as a Job Log ....	244
Items That Can Be Aggregated .....	249
Basic Procedures in Windows .....	253

# 19. Resources

## List of Available Functions

The following functions in smart PrintSuperVision are available for those with user authority.

●: Available -: Unavailable

Large categories	Medium categories	Small categories			User authority				
		Level 1	Level 2	Level 3	Guest user	Standard user	Administrator		
Management	Device List	Viewing			●	●	●		
		Modifying Lists			●	●	●		
		Deleting Devices			-	-	●		
		Editing Displayed Content			-	-	●		
	Registering Devices				-	-	●		
	Device Management Settings	Configuring Device Settings				-	-	●	
		Management Groups	Viewing Lists			●	●	●	
			Adding/Modifying/Deleting			-	-	●	
		Browsing Maps			●	●	●		
	Billing Amount Settings				-	-	●		
Reports	Viewing Reports	Device Information	Viewing		●	●	●		
		Job Information	Viewing Job Logs			-	-	●	
			Viewing Job Totals	By Month			-	●	●
				By Day			-	●	●
				By Device			-	●	●
				By Management Group			-	●	●
				By PIN			-	●*1	●
				User By Group			-	●*2	●
				By User Name			-	●*1	●
			By Login Name			-	●*1	●	
		Selecting Display Items			-	●	●		
Job Result	Viewing			-	-	●			

●: Available -: Unavailable

Large categories	Medium categories	Small categories			User authority		
		Level 1	Level 2	Level 3	Guest user	Standard user	Administrator
Reports	Notification Settings	Notification of Device Information	Viewing Lists		-	-	●
			Adding/Modifying/Deleting		-	-	●
		Notification of Job Information	Viewing Lists		-	-	●
			Adding/Modifying/Deleting		-	-	●
		Notification of Job Result	Viewing Lists		-	-	●
			Adding/Modifying/Deleting		-	-	●
		Automatic Notification on Device Registration	Viewing Lists		-	-	●
			Adding/Modifying/Deleting		-	-	●
Status Notification	Viewing Lists		-	-	●		
	Adding/Modifying/Deleting		-	-	●		
	Notification Email Settings	Adding/Modifying/Deleting		-	-	●	
Option	User Settings	User Lists	Viewing		-	●*3	●
			Adding		-	-	●
			Deleting		-	-	●
			(AD) Update Confirmations		-	-	●
			Modifying User Information		-	●*4	●*6
			Modifying User Group Information		-	●*5	●*6
	Priority Order of User Groups			-	-	●	
	User Handling Table			-	-	●	
	Environment Settings			-	-	●	
	Delete the log			-	-	●	
	Import/Export			-	-	●*7	
Database Settings			-	-	●*7		
Web Service setting			-	-	●*7		
Help	Help				●	●	●
	Version Information				●	●	●

\*1: Content is displayed only for the logged in user.

\*2: Content is displayed only for user groups to which the logged in user belongs.

\*3: Content is displayed only for the logged in user and user groups to which the logged in user belongs.

\*4: Only the password of the logged in user can be modified.

\*5: It is only possible to browse information on user groups to which the logged in user belongs.

\*6: User/user group information acquired from AD cannot be modified (excluding settings assigned in sPSV).

\*7: Only available on computers on which sPSV is running.



## Information That Can Be Acquired as a Job Log

Information that can be acquired as a job log is as shown below. ( ) denotes the name displayed in the CSV file (compatible with print job accounting).



**The items that can be aggregated differ depending on the device model or whether options are used.**

Item	Details
Device (Printer)	The name of the device that executed the printing. This cannot be moved as it is always displayed in the report.
Destination	The connection destination of the device that executed the printing. This cannot be moved as it is always displayed in the report.
Date* <sup>1</sup>	The date (year and month) on which the job log was acquired. This is calculated from the set [Log Acquire Time]. If the output file format is CSV, this cannot be moved as it is always displayed in the report.
Log No. (Log No.)	The job log number which is assigned monthly starting with 1.
PIN (User ID)	The user ID set in the client computer that executed the printing job, or the PIN ID entered into the control panel.
User name (User)	User name set in the client computer that executed the printing job.
Summary Account Type	The type of summary account set in the client computer used for printing.
Summary Account Name	The name of the summary account set in the client computer used for printing.
Login Name (Login Name)	Login name of the client computer that executed the print job.
Document name (Document name)	Name of the printed document. If the document name contains a "symbol, the" symbol is replaced with a one-byte space. In some cases, the correct document name cannot be acquired.
Host Name (Host Name)	Name of the client computer that executed the print job.
Port (Port)	Name of the port used for printing. When using over a network, the IP address of the client computer is displayed.
Fee	Fees incurred for the print job.
Points Used	The point at which the summary account for the print job is consumed.
Total Sheets* <sup>2</sup>	Number of sheets printed.
Pages* <sup>2</sup> (Printed Pages)	Number of pages printed. When duplex printing is used, one sheet is counted as two pages. This number is the actual number of printed pages as opposed to the document page number. For example, when a 6 page document is printed using 2-UP printing, the number of pages is 3 pages.
Print Job Type	The type of print job.

Item	Details
Status (Status)	<p>The job processing result</p> <ul style="list-style-type: none"> <li>- Completed: Job completed normally.</li> <li>- Canceled: Job cancelled by user operation. (For printing, when one or more sheets are printed)</li> <li>- Aborted: Job cancelled for a reason other than user operation.</li> <li>- Abnormal Completed: Job completed abnormally.</li> </ul>
Detailed Status (Detailed Status)	<ul style="list-style-type: none"> <li>- Log Buffer Full: Job cancelled because the device log buffer is full.</li> <li>- Access Control: Job cancelled by use restrictions.</li> <li>- Memory Overflow: Job cancelled by memory overflow.</li> <li>- Prohibit color printing: Job cancelled by use restriction (Prohibit Color Printing).</li> <li>- Mono Printing (Color Control): Job printed in monochrome due to use restriction (Prohibit Color Printing).</li> <li>- RIP Error Job cancelled by RIP error.</li> </ul>
Paper Size* <sup>3</sup> (Paper Size)	Size of the printed paper. If a there are multiple paper sizes used in the same print job, this item is displayed over a number of lines.
Media Type* <sup>3</sup> (Media Type)	Type of the printed paper. If there are multiple paper types used in the same print job, this item is displayed over a number of lines.
Media Weight* <sup>3</sup>	Thickness of the printed paper. If a there are multiple paper thicknesses used in the same print job, this item is displayed over a number of lines.
Duplex* <sup>3</sup>	This distinguishes between single-sided or duplex printing. If both single-sided and duplex printing used in the same print job, this item is displayed over a number of lines.
Printed Sheets* <sup>2</sup> * <sup>3</sup>	When one print job is displayed over a number of lines, the number of printed sheets is displayed on each line.
Color* <sup>2</sup> * <sup>3</sup> (Color)	Number of color pages printed. When one print job is displayed over a number of lines, the number of pages is displayed on each line.
Mono* <sup>2</sup> * <sup>3</sup> (Mono)	Number of monochrome pages printed. When one print job is displayed over a number of lines, the number of pages is displayed on each line.

Item	Details														
Spot Color 1*2*3 (White/Clear)	Number of pages printed in a spot color, such as white, clear, or monochrome. When one print job is displayed over a number of lines, the number of pages is displayed on each line.														
Spot Color 2*2*3 (White/Clear only)	Number of pages printed only in a spot color, such as white or clear. When one print job is displayed over a number of lines, the number of pages is displayed on each line.														
N-up (N-up)	Displays how many pages of data are reduced and printed within the printing range of 1 page.														
Toner (C) (Toner (C))	<p>The level of toner (toner usage density for each A4/letter size page) used for each color is displayed as one of the following 6 levels, from 0 to 5.</p> <table border="1" data-bbox="715 701 1390 925"> <thead> <tr> <th data-bbox="715 701 874 734">Level</th> <th data-bbox="874 701 1390 734">Density of the amount of toner used</th> </tr> </thead> <tbody> <tr> <td data-bbox="715 734 874 768">0</td> <td data-bbox="874 734 1390 768">0%</td> </tr> <tr> <td data-bbox="715 768 874 801">1</td> <td data-bbox="874 768 1390 801">Up to 5%</td> </tr> <tr> <td data-bbox="715 801 874 835">2</td> <td data-bbox="874 801 1390 835">Up to 15%</td> </tr> <tr> <td data-bbox="715 835 874 869">3</td> <td data-bbox="874 835 1390 869">Up to 30%</td> </tr> <tr> <td data-bbox="715 869 874 902">4</td> <td data-bbox="874 869 1390 902">Up to 60%</td> </tr> <tr> <td data-bbox="715 902 874 925">5</td> <td data-bbox="874 902 1390 925">61% and over</td> </tr> </tbody> </table> <p>Toner (W/L) is Toner (W) + Toner (CL).</p>	Level	Density of the amount of toner used	0	0%	1	Up to 5%	2	Up to 15%	3	Up to 30%	4	Up to 60%	5	61% and over
Level		Density of the amount of toner used													
0		0%													
1		Up to 5%													
2		Up to 15%													
3		Up to 30%													
4		Up to 60%													
5	61% and over														
Toner (M) (Toner (M))															
Toner (Y) (Toner (Y))															
Toner (K) (Toner (K))															
Toner (W) (Toner (W/L))															
Toner (CL) (Toner (W/L))															
Drum (C) (Drum (C))	<p>Amount of drum used for each color (converted to amount of drum used for each A4/letter size page). The amount of drum use of a 4-in-1 color drum unit is displayed as drum (K). Drum (W/L) is Drum (W) + Drum (CL).</p>														
Drum (M) (Drum (M))															
Drum (Y) (Drum (Y))															
Drum (K) (Drum (K))															
Drum (W) (Drum (W/L))															
Drum (CL) (Drum (W/L))															
Belt (Belt)	Amount of belt used (converted to the amount of belt used for each A4/letter size page)														
Fuser	Amount of fuser used (converted to the amount of fuser used for each A4/letter size page)														
Staple (Staple)	When the optional finisher is installed, this shows the number of times the stapler is used.														
Log Acquire Time	The time at which the job log was acquired by sPSV.														
Start Time	Time at which the device received the job.														
Process Start Time	Time at which the device started processing.														
Process End Time	Time at which the device finished processing.														
Print Start Time	Time at which the device started printing.														
End Time	Time at which the device finished printing.														

Item	Details
Processing Off-line Time (Processing Off-line Time)	The time during which device processing stopped due to an error, such as a paper jam during processing, paper size error, or no paper, or the amount of time (seconds) the device is set to offline on the control panel.
Printing Off-line Time (Printing Off-line Time)	The time during which device printing stopped due to an error, such as a paper jam during processing, paper size error, or no paper, or the amount of time (seconds) the device is set to offline on the control panel.
Tray1 (Tray1)* <sup>2</sup>	Number of sheets supplied from tray 1.
Tray2 (Tray2)* <sup>2</sup>	Number of sheets supplied from tray 2.
Tray3 (Tray3)* <sup>3</sup>	Number of sheets supplied from tray 3.
Tray4 (Tray4)* <sup>4</sup>	Number of sheets supplied from tray 4.
Tray5 (Tray5)* <sup>5</sup>	Number of sheets supplied from tray 5.
Multi-Purpose Tray* <sup>2</sup> (Multi-Purpose Tray)	Number of sheets supplied from the multi-purpose tray/manual feeding tray.
Multi-Purpose Feeder* <sup>2</sup> (Multi-Purpose Feeder)	Number of sheets supplied from the optional multi-purpose feeder.
300dpi* <sup>2</sup>	Number of pages printed at 300dpi.
600dpi* <sup>2</sup>	Number of pages printed at 600dpi.
1200×600dpi* <sup>2</sup>	Number of pages printed at 1200 x 600dpi.
2400×600dpi* <sup>2</sup>	Number of pages printed at 2400 x 600dpi.
1200dpi* <sup>2</sup>	Number of pages printed at 1200dpi.
Color Scan Page* <sup>2</sup> (Color Scan Page)	Number of pages scanned in color.
Mono Scan Page* <sup>2</sup> (Mono Scan Page)	Number of pages scanned in monochrome.
Scan Operation (Print While Scanning)	Indicates whether the scanned pages were printed. <ul style="list-style-type: none"> <li>• Print While Scanning: Yes Number of scan jobs that are accompanied with printing.</li> <li>• Print While Scanning: No Number of scan jobs that are not accompanied with printing.</li> </ul>
Job ID* <sup>3</sup> (Job ID)	Number used to identify the job. When multiple job logs are generated for the same job, the ID number is the same. If there are multiple settings used in the same print job, this item is displayed over a number of lines.

Item	Details
Function	Displays the name of the function processed by the device.
Service (Service)	Displays the name of the service processed by the device.
Scan Page Size (Scan Page Size)	Size of the scanned document
Destination	<p>When the service is Fax or PC Fax, the destination is one of the following: Telephone number of the Fax source or destination, recipient ID, or equipment information.</p> <p>If the service is a server, this is the file save destination folder.</p> <p>When the service is a USB memory, this is fixed as USBMEM01.</p> <p>When the service is email, this is the email address of the sender or receiver.</p>
Communication Mode (Communication Mode)	<p>The communication type is either Fax or Email.</p> <ul style="list-style-type: none"> <li>• Send: Fax sends job.</li> <li>• Receive: Fax receives job.</li> <li>• Send to multiple recipients: Fax send job to multiple recipients.</li> <li>• Send from PC: Fax sends job from a PC.</li> <li>• Send to multiple recipients from a PC:</li> </ul> <p>Fax sends job to multiple recipients from a PC.</p> <ul style="list-style-type: none"> <li>• Email send: Email sends job.</li> <li>• Send Email to multiple recipients:</li> </ul> <p>Email sends job to multiple recipients.</p>
Communication Time	Time required to send or receive a fax.
Manual	Turns "ON" when a fax is transmitted manually.
Time specified	Turns "ON" when the time is specified in a fax.
Polling (Polling)	Turns "ON" when polling transmission is used in a fax.
F-Code (F-Code)	Turns "ON" when F code transmission is used in a fax.
Call/Receipt	<p>Call: Indicates when the receiver is called by fax.</p> <p>Receipt: Indicates when a call is received from the sender fax.</p>
Fax Forwarding	Turns "ON" when a fax is forwarded.
Communication Page (Communication Page)	Number of pages sent or received by fax.
Service Code (Service Code)	Fax transmission error code.

**\*1 The time is acquired from the device if the device has a built-in clock. If the device does not have a built-in clock, the time at which the job log was acquired by sPSV is used.**

**\*2 Unconverted paper size value.**

**\*3 When multiple lines are displayed, items other than this main item are displayed as blank spaces in the second and subsequent lines.**

## Items That Can Be Aggregated

Items that are displayed for aggregation are as shown below. ( ) denotes the name displayed in the CSV file (compatible with print job accounting).



**The items that can be aggregated differ depending on the device model or whether options are used.**

Item	Details
Device (Printer)	This is the name of the device that executed the aggregation. It is displayed for aggregations [By Device] and [By Management Group].
Destination	This is the connection destination of the device that executed the aggregation. It is displayed for aggregations [By Device] and [By Management Group].
PIN (User ID)	This is the PIN (user ID) with which the aggregation was executed. It is displayed for aggregations [By PIN] and [By User Group].
Name	This is the user name corresponding to the PIN with which the aggregation was executed. It is displayed for aggregations [By PIN], [By User Group] and [By Login].
Date* <sup>1</sup>	This is the month in which the aggregation was executed. It is displayed when logs are aggregated [Monthly].
Month and Year and Day* <sup>1</sup>	This is the day on which the aggregation was executed. It is displayed when logs are aggregated [By Day].
User Name (User)	This is the name of the user who executed the aggregation. It is displayed when logs are aggregated [By User Name].
Login Name (Login Name)	This is the login by which the aggregation was executed. It is displayed when logs are aggregated [By Login Name].
Group (Group)	This is the name of the group that the aggregated device or user belongs to.
Shared Account	Total number of Shared Account logs.
Group Account & Personal Account	Total number of Group Account & Personal Account logs.
Personal Account	Total number of Personal Account logs.
Fee	This is the fee total.
Jobs (Jobs)	This is the total number of jobs.
Printed Sheets* <sup>2</sup>	This is the total number of sheets printed.
Printed Pages (Printed Pages)* <sup>2</sup>	This is the total number of pages printed. When one print job is displayed over a number of lines, the number of pages is displayed on each line.
Color (Color)* <sup>2</sup>	This is the total number of color pages printed.
Mono (Mono)* <sup>2</sup>	This is the total number of monochrome pages printed.
Spot Color 1 (White/Clear)* <sup>2</sup>	This is the total number of pages printed in a spot color such as white or clear and in a color other than white/clear.
Spot Color 2 (White/Clear only)* <sup>2</sup>	This is the total number of pages printed only in a spot color such as white or clear.
Device Occupancy Time	This is the total time the device was used.
Normal	Total number of normal print jobs.

Item	Details
Store for Re-print	Total number of jobs saved on the printer.
Secure Print	Total number of Secure Print jobs.
Encrypted Secure Print	Total number of Encrypted Secure Print jobs.
ID Secure Print	Total number of ID Secure Print jobs.
Completed	This is the total number of jobs that completed normally.
Cancel (Cancel)	This is the total number of jobs cancelled by user operation. (For printing, when one or more sheets are printed)
Aborted	This is the total number of jobs cancelled by reasons other than user operation.
Abnormal Completed	This is the total number of jobs that completed abnormally.
Log Buffer Full (Log Buffer Full)	This is the total number of jobs cancelled because the device log is full.
Access Control (Access Control)	This is the total number of jobs cancelled because the use restrictions (Prohibit Printing) or limit values for a user ID was exceeded.
Memory Over Flow (Memory Over Flow)	This is the total number of jobs cancelled due to memory overflow.
Color Control (Color Control)	This is the total number of jobs cancelled because the use restrictions (Prohibit Color Printing) or limit values for a user ID was exceeded.
Mono Printing (Color Control) (Mono Printing (Color Control))	This is the total number of jobs printed in monochrome due to use restrictions (Prohibit Color Printing) for a user ID.
RIP Error	This is the total number of jobs cancelled due to RIP error.
Access Control - Login Name (Access Control - Login Name)	This is the total number of jobs cancelled because the use restrictions (Prohibit Printing) or limit values for a login name were exceeded.
Access Control - Document Name (Access Control - Document Name)	This is the total number of jobs cancelled because the use restrictions (Prohibit Printing) or limit values for a document name were exceeded.
Access Control - Host Name (Access Control - Host Name)	This is the total number of jobs cancelled because the use restrictions (Prohibit Printing) or limit values for a host name were exceeded.
Color Control - Login Name (Color Control - Login Name)	This is the total number of jobs cancelled due to use restrictions (Prohibit Color Printing) for a login name.
Color Control - Document Name (Color Control - Document Name)	This is the total number of jobs cancelled due to use restrictions (Prohibit Color Printing) for a document name.

Item	Details
Color Control - Host Name (Color Control - Host Name)	This is the total number of jobs cancelled due to use restrictions (Prohibit Color Printing) for a host name.
Mono Printing - Login Name (Mono Printing - Login Name)	This is the total number of jobs printed in monochrome due to use restrictions (Prohibit Color Printing) for a login name.
Mono Printing - Document Name (Mono Printing - Document Name)	This is the total number of jobs printed in monochrome due to use restrictions (Prohibit Color Printing) for a document name.
Mono Printing - Host Name (Mono Printing - Host Name)	This is the total number of jobs printed in monochrome due to use restrictions (Prohibit Color Printing) for a host name.
A4 A5 A6 :	This is the total print number for each paper size.
Simplex	This is the total number of sheets printed for simplex printing.
Duplex	This is the total number of sheets printed for duplex printing.
1-Up 2-Up 3-Up :	This is the total number of jobs for each N-up setting.
Toner (C) (Toner (C))	This is the total number of pages for each level of used cyan toner.
Toner (M) (Toner (M))	This is the total number of pages for each level of used magenta toner.
Toner (Y) (Toner (Y))	This is the total number of pages for each level of used yellow toner.
Toner (K) (Toner (K))	This is the total number of pages for each level of used black toner.
Toner (W) (Toner (W/L))* <sup>3</sup>	This is the total number of pages for each level of used white toner.
Toner (CL) (Toner (W/L))* <sup>3</sup>	This is the total number of pages for each level of used clear toner.
Drum (C) (Drum (C))	This is the total amount of use of cyan drum.
Drum (M) (Drum (M))	This is the total amount of use of magenta drum.
Drum (Y) (Drum (Y))	This is the total amount of use of yellow drum.
Drum (K) (Drum (K))	This is the total amount of use of black drum and 4-in-one color drum.
Drum (W) (Drum (W/L))* <sup>4</sup>	This is the total amount of use of white drum.
Drum (CL) (Drum (W/L))* <sup>4</sup>	This is the total amount of use of clear drum.
Belt (Belt)	This is the total amount of use of belt.
Fuser	This is the total amount of belt and fuser used.
Staple (Staple)	When the optional finisher is installed, this shows the number of times the stapler is used.



Item	Details
Standard Paper Letterhead (Letterhead) OHP Sheet (OHP Sheet) :	This is the total print number for each paper type.
Auto Thin Paper (Thin) Standard Paper (Standard) :	This is the total print number for each paper thickness.
Tray1 (Tray1)	This is the total number of sheets supplied from tray 1.
Tray2 (Tray2)	This is the total number of sheets supplied from tray 2.
Tray3 (Tray3)	This is the total number of sheets supplied from tray 3.
Tray4 (Tray4)	This is the total number of sheets supplied from tray 4.
Tray5 (Tray5)	This is the total number of sheets supplied from tray 5.
Multi-Purpose Tray (Multi-Purpose Tray)	This is the total number of sheets supplied from the multi-purpose tray/manual feeding tray.
Multi-Purpose Feeder (Multi-Purpose Feeder)	This is the total number of sheets supplied from the optional multi-purpose feeder.
300dpi	This is the total number of pages printed at 300dpi.
600dpi	This is the total number of pages printed at 600dpi.
1200×600dpi	This is the total number of pages printed at 1200 x 600dpi.
2400×600dpi	This is the total number of pages printed at 2400 x 600dpi.
1200dpi*1 *2	This is the total number of pages printed at 1200dpi.
Color Scan Page (Color Scan Page)	This is the total number of scanned color pages.
Mono Scan Page (Mono Scan Page)	This is the total number of scanned monochrome pages.
Print and Scan (Print and Scan)	This is the total number of scan jobs that are accompanied with printing.
Scan Only (Scan Without Printing)	This is the total number of scan jobs that are not accompanied with printing.
Print Fax To Print PC Scan (PC Scan) :	This is the total log number for each function.
Print Scan (Scan) Fax :	This is the total log number for each service.
Communication Time	This is the total time required to send or receive faxes.
Send	This is the total number of jobs sent by fax.
Receive	This is the total number of jobs received by fax.
Multi-cast Send	This is the total number of jobs sent by fax to multiple recipients.
Send on PC	This is the total number of jobs sent by fax from a PC.

Item	Details
Multi-cast Send on PC	This is the total number of jobs sent by fax to multiple recipients from a PC.
Email Send (Email Send)	This is the total number of jobs sent by email.
Multi-cast Email Send (Multi-cast Email Send)	This is the total number of jobs sent to multiple recipients by email.
Communication Page (Communication Page)	This is the total number of pages sent and received by fax.

- \*1 The time is acquired from the device if the device has a built-in clock. If the device does not have a built-in clock, the time at which the job log was acquired by sPSV is used.**
- \*2 When one job is displayed over a number of lines, the number of pages is displayed on each line. When multiple lines are displayed, items other than this main item are displayed as blank spaces in the second and subsequent lines.**
- \*3 Toner (W/L) indicates the total for Toner (W) and Toner (CL).**
- \*4 Drum (W/L) indicates the total for Drum (W) and Drum (CL).**

---

## Basic Procedures in Windows

This section explains procedures for displaying the Printer Properties window for OS other than Windows 7, the OS that was used as an example in this manual.



**The procedures for Windows Server 2008 R2 are the same as for Windows 7.**

### Windows 10

- 1 Right-click [Start], then click [Control Panel] > [View devices and printers].
- 2 Right-click the printer driver icon and select [Printer Properties].

### Windows 8/Windows Server 2012

- 1 If the [Start] screen is displayed, click [Desktop] on the screen.
- 2 Move the cursor to the top right of the screen to display the charm bar and then click [Settings] > [Control Panel] from the displayed items. (If using a computer that supports touch operations, the charm bar can be displayed by flicking the right side of the screen.)
- 3 Select [Devices and Printers].
- 4 Right-click the printer driver icon and select [Printer Properties].

### Windows Vista/Windows Server 2008

- 1 Click [Start] and select [Control Panel] > [Printers].
- 2 Right-click the printer driver icon and select [Properties].

# Index

---

# Index

## A

Acquire Print Log .....	57
Active Directory	
Linked Management.....	138
Add User .....	57
Authentication server .....	25
Auto Status Refresh Service.....	46, 189, 214

## B

[Belt/Fuser Use Amount] .....	87
Belt Unit.....	184

## C

Client computer.....	12, 25
Closing date .....	205
[Color Copying Disabled] .....	144
Consumable Life.....	182
[Copying Disabled] .....	144
[Cost Target] .....	87
CSV files .....	10

## D

Database.....	207
Database server .....	25
Details Screen .....	49
Device Usage History .....	52
[Disable Fax Sending] .....	144
Displaying totals.....	200
Domain name .....	45
[Drum Use Amount] .....	87

## E

Email Notification	
Print Prohibited/Permitted .....	179
Email notifications	
Database error .....	213
Job logs .....	204
Job results.....	217
Usage status aggregation results .....	203
Embedded web service (EWS) .....	38

## F

Fees	
Changing definitions .....	177
Definitions .....	172
Deleting definitions .....	178
Setting definitions for devices.....	176
[Filter Item] .....	81
[Finisher] .....	87
Fuser Unit .....	184

## H

[Help] Tab .....	79
------------------	----

## I

Image Drum .....	184
Internet Information Services (IIS).....	38
Items that can be aggregated .....	248

## J

Job account mode.....	107
Job log acquisition schedule settings .....	123
Job logs .....	192
Deleting .....	197
Displaying .....	194
Outputting as a CSV file .....	197
Stopping acquisition.....	198

## L

[Limit Fees.] .....	170
[Limit Number of Staples.] .....	171
[Limit Print Number.] .....	170
[Log Full Operation] .....	123
Login name .....	45
Login Window .....	50
Log Storage Period .....	96

## M

Mail Server Settings .....	63
Main Menu .....	49
[Manage] Tab.....	79
[Media Type].....	87, 176

**O**

[Option] Tab .....	79
Output cost .....	170
Outputting the aggregation results as a CSV file .....	202

**P**

[Pages] .....	173
[Pages] .....	87
[Paper Size].....	87
Password.....	45
[Print In Mono] .....	144
[Prohibit Color Printing].....	144
[Prohibit Printing] .....	134, 144
[Prohibit USB Memory To Color Print] .....	144
[Prohibit USB Memory To Print] .....	144

**R**

Register Device .....	118
[Report] Tab .....	79

**S**

Server computer .....	11
Settings sheet.....	25
SMTP server .....	25

**T**

[Toner use amount] .....	173
[Toner Use Amount] .....	87
[Tray] .....	87

**U**

Usage Status .....	178
Use Restrictions .....	143
Change .....	164
Delete.....	166
Delete All .....	167
Temporarily Disable .....	167
User ID (PIN).....	130
User information .....	14
User name.....	14

**V**

[Valid Period] .....	171
----------------------	-----

**W**

Waste Toner Box .....	184
-----------------------	-----

