

Integrator's Complete Guide to the

OneLINK HDMI

Camera Extension

Document 411-0019-30 Rev. B
February 2018

Contents

Overview	1
What's in this Guide	2
Features	2
Unpacking the OneLINK HDMI Camera Extension	3
OneLINK HDMI for HDBaseT Cameras	3
OneLINK HDMI For HDBaseT Cameras Used with Codecs	3
OneLINK HDMI for HDMI Cameras	4
OneLINK HDMI for HDMI Cameras Used with Codecs	5
A Quick Look at the OneLINK Device	7
Front Panel of the Receiver	7
Connector Panel of the Receiver	8
Connector Panel of the EZCamera Interface Module (EZIM)	9
Installing the OneLINK Device	10
Don't Void Your Warranty!	10
Cabling Notes	10
Mounting the OneLINK Device	11
RS-232 Connector Pin-Outs	11
IR Forwarding Connector Pin-Out	11
Visual Conventions for Connection Diagrams	12
Connections for HDBaseT Cameras	12
Kits and Systems for HDBaseT Cameras	12
Connecting a Vaddio HDBaseT Camera	13
Connections for HDBaseT Cameras Used with Codecs	14
Kits for HDBaseT Cameras Used with Codecs	14
Connecting a Vaddio HDBaseT Camera and Polycom Codec	15
Connecting a Vaddio HDBaseT Camera and Cisco Codec	18
Connections for HDMI Cameras	22
Kits for HDMI Cameras	22
Connecting a RoboSHOT HDMI Camera	23
Connecting a Polycom EagleEye IV Camera	24
Connecting a Cisco Camera	25
Connecting a Sony or Panasonic HDMI Camera	27
Connections for HDMI Cameras Used with Codecs	29
Kits for HDMI Cameras Used with Codecs	29
Connecting a RoboSHOT HDMI Camera and Polycom Codec	30
Connecting a Polycom EagleEye IV Camera and Polycom Codec	33
Connecting a RoboSHOT HDMI Camera and Cisco Codec	36
Connecting a Cisco Camera and Codec	41
Powering Up the Equipment	46
Configuration and Administration Tasks	46

Compatible Web Browsers	46
Accessing the Web Interface	47
Web Interface Cheat Sheet	48
Configuring Network Settings	49
Assigning a Hostname	50
Specifying Time Zone and NTP Server	50
Managing Access and Passwords	51
Adding Room Information to the Web Interface	52
Viewing System Information	53
Saving (Exporting) or Restoring (Importing) a Configuration	53
Rebooting the OneLINK Device	54
Restoring Factory Settings	55
Starting a Firmware Update	56
Contacting Vaddio Technical Support and Viewing Diagnostics	57
Telnet Serial Command API	58
link power	59
network settings get	59
network ping	60
system reboot	60
system factory-reset	61
sleep	61
version	62
history	62
help	62
exit	63
Specifications	64
Troubleshooting	65
Operation, Storage, and Care	66
Compliance and Declarations of Conformity	67
FCC Part 15 Compliance	67
ICES-003 Compliance	67
European Compliance	68
Warranty Information	69
Index	70

Overview

This guide covers the OneLINK™ HDMI camera extension, which is available in the following kit configurations for use with Vaddio or third-party cameras, with or without third-party codecs.

- 999-1105-043/143/943, OneLINK HDMI
- 999-9520-000/001/009, OneLINK HDMI camera extension for Polycom EagleEye IV cameras with Polycom codecs
- 999-9530-000/001/009, OneLINK HDMI camera extension for Sony and Panasonic cameras
- 999-9540-000/001/009, OneLINK HDMI camera extension for RoboSHOT HDMI cameras with Polycom codecs
- 999-9545-000/001/009, OneLINK HDMI camera extension for Vaddio HDBaseT cameras with Polycom codecs
- 999-9560-000/001/009, OneLINK HDMI camera extension for Cisco cameras with Cisco codecs
- 999-9570-000/001/009, OneLINK HDMI camera extension for RoboSHOT HDMI cameras with Cisco codecs
- 999-9575-000/001/009, OneLINK HDMI camera extension for Vaddio HDBaseT cameras with Cisco codecs
- 999-9590-000/001, OneLINK HDMI camera extension for RoboSHOT HDMI cameras

The OneLINK HDMI camera extension is also available as a component of several Vaddio camera systems.

Part number suffixes indicate power cord set types. Those ending in -000 include cord sets for use in North America; -001 kits include cord sets for use in Europe and the UK; -009 kits include cord sets for use in Australia and New Zealand.



If the camera extension is sold for use with an HDMI camera, it is shipped with a OneLINK EZCamera Interface Module (EZIM).



What's in this Guide

This guide provides information about:

- Unpacking
- Physical features
- Installation
- Configuration and system administration
- Telnet API for third-party control
- Specifications
- Troubleshooting and maintenance
- Warranty

For your convenience, most of this information is also available in smaller, limited-purpose manuals:

- **Installation Guide for the OneLINK HDMI Camera Extension** – Unpacking, physical features, installation, and initial power-on.
- **Configuration and Administration Guide for the OneLINK HDMI Camera Extension** – Physical features, web interface for device configuration and system administration, and troubleshooting.

Download manuals, dimensional drawings, and other information from support.vaddio.com.

Features

- Simple, fast, clutter-free camera installation – power, control, video, and network connectivity on a single Cat-5e(or better) cable
- Extends installation distance for HDMI and HDBaseT™ cameras up to 100 m (328 ft.)
- Passes uncompressed HDMI® video up to 2160p/29.97
- Bidirectional control via Ethernet and RS-232
- Compatible with Vaddio HDBaseT cameras – no EZCamera Interface Module (EZIM) needed
- Compatible with RoboSHOT HDMI and other HDMI cameras
- Available in system configurations with Vaddio cameras
- Kits available for use with Polycom and Cisco codecs and other HDMI cameras

Unpacking the OneLINK HDMI Camera Extension

Make sure you received all the items you expected. Here are the packing lists for the OneLINK HDMI kits. Every OneLINK device ships with a power supply and at least one AC cord set. The last three digits of the kit part number contain the regional code that specifies which cord set(s). For most OneLINK kits, the part numbers follow this convention:

- Kits with part numbers ending in -000 include one AC cord set for North America.
- Kits with part numbers ending in -001 include two AC cord sets, one for Europe and one for the UK.
- Kits with part numbers ending in -009 include one AC cord set for Australia and New Zealand.

Exceptions are noted case by case in the following packing lists.

OneLINK HDMI for HDBaseT Cameras

OneLINK HDMI Camera Extension for Vaddio HDBaseT Cameras, 999-1105-043/143/943

Camera not included.

- OneLINK HDMI Receiver, 998-1105-043
- Power supply, 48 VDC/1.36 A, with AC cord set(s)
 - Kit 999-1105-043 includes one AC cord set for North America.
 - Kit 999-1105-143 includes two AC cord sets, one for Europe and one for the UK.
 - Kit 999-1105-943 includes one AC cord set for Australia and New Zealand.
- EZCamera RS-232 control adapter (998-1001-232)
- Quick-Start Guide 411-0019-01



OneLINK HDMI For HDBaseT Cameras Used with Codecs

OneLINK HDMI for Vaddio HDBaseT Cameras with Polycom Codecs, 999-9545-000/001/009

Camera and codec not included.

- OneLINK HDMI Receiver
- Power supply, 48 VDC/1.36 A, with AC cord set(s)
- 3-position Euro-style connector, 5 mm
- Fan-out cable, codec side, 2 ft. (0.6 m)
- EZCamera RS-232 control adapter 998-1001-232
- Quick-Start Guide 411-0019-01



OneLINK HDMI for Vaddio HDBaseT Cameras with Cisco Codecs, 999-9575-000/001/009

Camera and codec not included.

Note

If connecting to a Cisco SX20 codec, you will need to provide a Cisco split cable, Cisco part number CAB-PHD4XS2-SPLIT.

- OneLINK HDMI Receiver
- Power supply, 48 VDC/1.36 A, with AC cord set(s)
- HDMI cable, 3 ft. (0.9 m)
- Custom-pinout Cat-5e cable for Cisco, 3 ft. (0.9 m)
- EZCamera RS-232 control adapter 998-1002-232
- Cat-5e patch cable, 3 ft. (0.9 m)
- Quick-Start Guide 411-0019-01



OneLINK HDMI for HDMI Cameras

OneLINK HDMI for RoboSHOT HDMI Cameras, 999-9590-000/001/009

Camera not included.

- OneLINK HDMI Receiver
- OneLINK EZCamera Interface Module (EZIM) with mounting screws
- Power supply, 48 VDC/1.36 A, with AC cord set(s)
- Power cable EIAJ-04 to EIAJ-04, 1 ft. (0.3 m)
- Cat-5e patch cable, 1 ft. (0.3 m), qty. 2
- HDMI cable, 1 ft. (0.3 m)
- EZCamera RS-232 control adapter
- Quick-Start Guide 411-0019-02



OneLINK HDMI for Sony and Panasonic Cameras, 999-9530-000/001/009

Camera not included.

- OneLINK HDMI Receiver
- OneLINK EZCamera Interface Module (EZIM)
- Power supply, 48 VDC/1.36 A, with AC cord set(s)
- Power cable EIAJ-04 to EIAJ-04, 1 ft. (0.3 m)
- Power cable EIAJ-04 to 3x6.3mm, 1 ft (0.3 m)
- Wall mount with mounting hardware for Sony and Panasonic cameras
- HDMI cable, 1 ft. (0.3 m)
- RJ-45 to 8-pin mini-DIN cable, 1 ft. (0.3 m)
- Cat-5e patch cable, 1 ft. (0.3 m)
- Quick-Start Guide 411-0019-02



OneLINK HDMI for HDMI Cameras Used with Codecs

OneLINK HDMI for Polycom Cameras with Polycom Codecs, 999-9520-000/001/009

Camera and codec not included.

- OneLINK HDMI Receiver
- OneLINK EZCamera Interface Module (EZIM)
- Power supply, 48 VDC/1.36 A, with AC cord set(s)
- Wall mount with mounting hardware for Polycom codec and camera
- Fan-out cable, EZIM side, 1 ft. (0.3 m)
- Fan-out cable, codec side, 2 ft. (0.6 m)
- 3-position Euro-style connector, 5 mm
- EZCamera RS-232 control adapter 998-1001-232
- Quick-Start Guide



OneLINK HDMI for RoboSHOT HDMI with Polycom Codecs, 999-9540-000/001/009

Camera and codec not included.

- OneLINK HDMI Receiver
- OneLINK EZCamera Interface Module (EZIM), with mounting screws
- Power supply, 48 VDC/1.36 A, with AC cord set(s)
- Fan-out cable, codec side, 2 ft. (0.6 m)
- 3-position Euro-style connector, 5 mm
- HDMI cable, 1 ft. (0.3 m)
- Power cable EIAJ-04 to EIAJ-04, 1 ft. (0.3 m)
- Cat-5e patch cable, 1 ft. (0.3 m), qty. 2
- Quick-Start Guide 411-0019-02



OneLINK HDMI for Cisco Cameras with Cisco Codecs, 999-9560-000/001/009

Camera and codec not included.

Note

If connecting to a Cisco SX20 codec, you will need to provide a Cisco split cable, Cisco part number CAB-PHD4XS2-SPLIT. This cable is also required when connecting to a Cisco Precision 40 or Precision HD 1080p2.5x camera; you will need two of them if connecting one of these cameras and an SX20 codec.

- OneLINK HDMI Receiver
- OneLINK EZCamera Interface Module (EZIM)
- Power supply, 48 VDC/1.36 A, with AC cord set(s)
- Power cable EIAJ-04 to 5.5x2.1 mm, 1 ft. (0.3 m)
- Wall mount with mounting hardware for Cisco codec and camera
- HDMI cable, 3 ft. (0.9 m)
- HDMI cable, 1 ft. (0.3 m)
- Custom-pinout Cat-5e cable for Cisco, 3 ft. (0.9 m)
- Custom-pinout Cat-5e cable for Cisco, 1 ft. (0.3 m)
- Cat-5e patch cable, 1 ft. (0.3 m)
- Cat-5e patch cable, 3 ft. (0.9 m)
- EZCamera RS-232 control adapter 998-1002-232
- Quick-Start Guide 411-0019-02



OneLINK HDMI for RoboSHOT HDMI with Cisco Codecs, 999-9570-000

Camera and codec not included.

Note

If connecting to a Cisco SX20 codec, you will need to provide a Cisco split cable, Cisco part number CAB-PHD4XS2-SPLIT.

- OneLINK HDMI Receiver
- OneLINK EZCamera Interface Module (EZIM) with mounting screws
- Power supply, 48 VDC/1.36 A, with AC cord set(s)
- Power cable EIAJ-04 to EIAJ-04, 1 ft. (0.3 m)
- HDMI cable, 3 ft. (0.9 m)
- HDMI cable, 1 ft. (0.3 m)
- Custom-pinout Cat-5e cable for Cisco, 3 ft. (0.9 m)
- Cat-5e patch cable, 1 ft. (0.3 m), qty. 2
- Cat-5e patch cable, 3 ft. (0.9 m)
- EZCamera RS-232 control adapter 998-1002-232
- Quick-Start Guide 411-0019-02



A Quick Look at the OneLINK Device

This section covers the physical features of the OneLINK HDMI camera extension.

All OneLINK kits include a receiver, which is typically co-located with other equipment, up to 328 ft (100 m) away from the camera. OneLINK kits for use with HDMI cameras also include an EZCamera Interface Module (EZIM) HDBaseT converter, which is mounted adjacent to the camera.

Front Panel of the Receiver

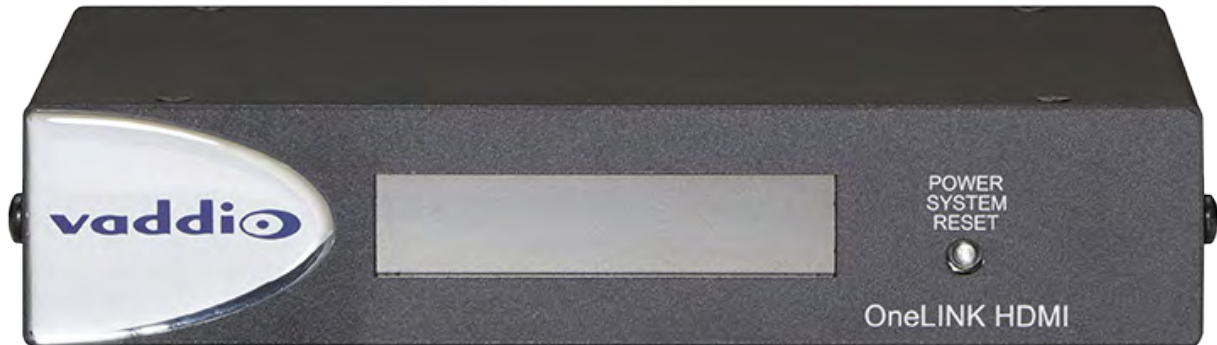

- **Data Display** – Shows the IP and MAC addresses for the OneLINK HDMI camera extension (not the camera). Use the IP address to access the OneLINK HDMI web interface.
- **Power System Reset** button (illuminated red) – reboots the OneLINK Bridge without affecting the connected camera.

Note

The OneLINK device does not control the camera; it passes IP and RS-232 traffic to and from the camera. Use the camera's IP address to access the camera's web interface. The OneLINK device's IP address only provides access to the OneLINK device, not to the connected camera.

Note

To discover the attached Vaddio camera's IP address, point the IR Remote Commander at the camera and press the Data Screen button. The camera's IP and MAC addresses are displayed on the connected HDMI video output.

Connector Panel of the Receiver

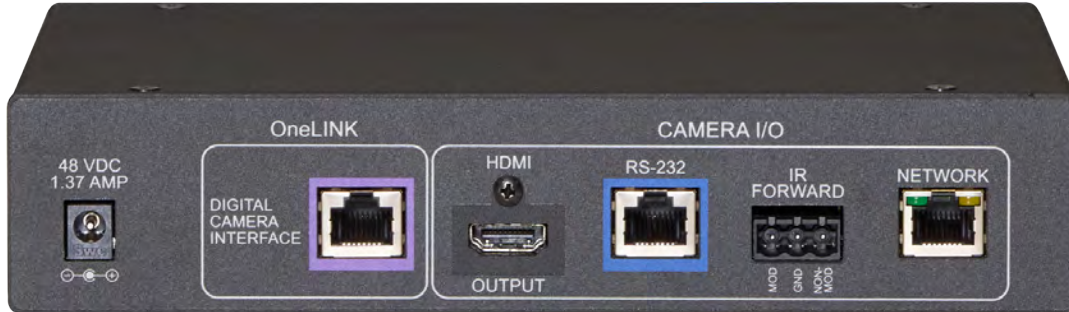

From the left:

- **Power input jack** – Use the supplied 48VDC, 1.36A power supply.
- **OneLINK interface port** – Connect a Cat-5e (or better) cable to the EZIM, or to the camera if your OneLINK kit or system did not include an EZIM. This bidirectional connection carries video, network connectivity including H.264 IP streaming from the camera (if available), RS-232 control, and 12 VDC power.
- **HDMI output** – HDMI output to a connected display.
- **RS-232 port** – Connect to a camera controller.
- **IR forwarding port** – To forward IR signals from the camera, if available. Modulated and non-modulated outputs provided.
- **Network port** – H.264 IP streaming (if available from the camera), web interface access, and third-party IP control via Telnet API.

Connector Panel of the EZCamera Interface Module (EZIM)

If the OneLINK device is used with an HDMI camera, the EZIM is required.



From the left:

- **Power output jack** – Supplies power to the camera. The kit you purchased includes the appropriate cable to connect your camera's power input to this jack.
- **Network port** – Provides network connectivity to the camera for H.264 IP streaming (if available from the camera), web interface access, and third-party control via Telnet API. Connect to the camera's network port.
- **RS-232 port** – Provides RS-232 connectivity to the camera, for third-party control. The kit you purchased may include a cable and/or an RS-232 adapter to connect to the camera's RS-232 port.
- **HDMI input** – Receives HDMI video from the camera. Connect to the camera's HDMI output.
- **OneLINK port** – Single-cable connection to the OneLINK receiver. This bidirectional connection carries all video, power, and control.

Note

Cat-6 or Cat-7 cabling may provide better performance in noisier RF or EMF environments. When in doubt, use shielded Cat-6 cable. Cable distance between the EZIM and the OneLINK device is a maximum of 328 feet (100 m).

Installing the OneLINK Device

This section covers:

- Things to know before you start the installation
- Basic connection examples

Rack mounting brackets are available for the OneLINK receiver.

Don't Void Your Warranty!

Caution

Use only the power supply included with this product. Using a different one will void the warranty, and could create unsafe operating conditions or damage the product.

Do not connect the OneLINK power supply to a camera. It does not provide the correct voltage for Vaddio cameras, and will damage the camera and void the camera's warranty.

This product is for indoor use only. Do not install it outdoors or in a humid environment. Do not allow it to come into contact with any liquid.

Do not install or operate this product if it has been dropped, damaged, or exposed to liquids. If any of these things happen, return it to Vaddio for safety and functional testing.

All information about this product is available for download at www.vaddio.com/support – no cost, no registration required.

Cabling Notes

Cat-6 or Cat-7 cabling may provide better performance in noisier RF or EMF environments. When in doubt, use shielded Cat-6 cable. Cable distance between the EZIM and the OneLINK device is a maximum of 328 feet (100 m).

Note

Use standard RJ-45 connectors and a good crimping tool. Do not use pass-through RJ-45 connectors. Poorly crimped connectors can damage the connectors on the product, cause intermittent connections, and degrade signal quality. Test cable pin-outs and continuity before connecting them.



Intact – Contact fingers will make reliable contact with the cable connector



Damaged – Some contact fingers are bent and will NOT make reliable contact with the cable connector



Pro Tip

To prevent tragic mishaps, label both ends of every cable.

Mounting the OneLINK Device

If you are installing the OneLINK device with a OneLINK EZIM, mount the EZIM with or near the camera. Most Vaddio Thin Profile Wall Mounts include two mounting holes to attach the EZIM to the underside of the mount using two 6-32 screws. Connect all required cables during camera installation.

Rack and under-table mounting kits are available for the receiver. Follow the mounting instructions supplied with the kit.

RS-232 Connector Pin-Outs

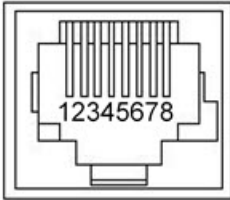

OneLINK Receiver - RS-232 Control Port

1. Unused
2. Unused
3. Unused
4. Unused
5. Unused
6. GND – green
7. RX (from TX of controller) – brown/white
8. TX (to RX of controller) – brown

OneLINK EZIM - RS-232 Control Port

1. Unused
2. Unused
3. Unused
4. IR GND
5. IR (non-mod)
6. GND – green
7. TX (to RX of camera) – brown/white
8. RX (from TX of camera) – brown

Note

Vaddio recommends adhering to the 568B cabling standard for Cat-5 cabling.

IR Forwarding Connector Pin-Out

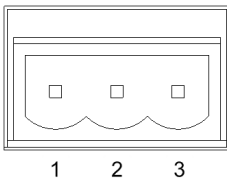

1. Modulated IR
2. Common Ground
3. Non-modulated IR

Visual Conventions for Connection Diagrams

The following sections provide representative connection diagrams for the various OneLINK kit and system configurations available. All diagrams in this guide use these visual conventions for connection type.

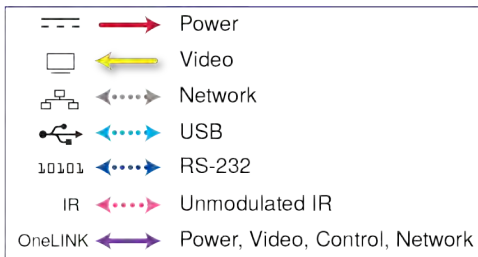

Connections for HDBaseT Cameras

In this configuration, the OneLINK HDMI extends network connectivity, power, and control to an HDBaseT camera, and brings HDMI video from the camera to a display. The camera can optionally be controlled by a camera controller on an RS-232 serial connection to the OneLINK HDMI or over the network, depending on the controller.

If an IP stream is available from the camera, the OneLINK device passes it to the network. IP streaming resolutions up to 2160p/30 are supported. HDMI output resolution and streaming parameters (including resolution) are configured on the camera, not the OneLINK device.

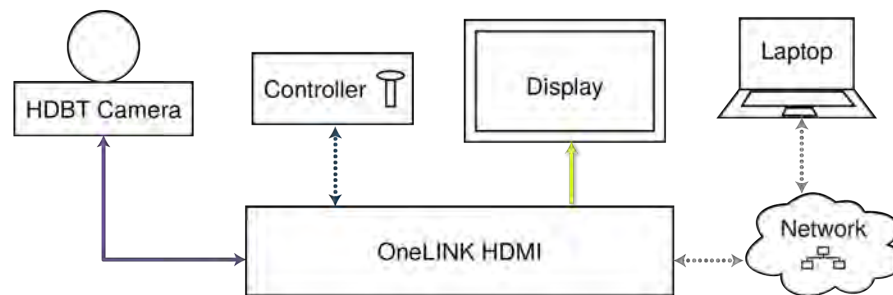

Kits and Systems for HDBaseT Cameras

This block diagram applies to:

- OneLINK HDMI for HDBaseT Cameras, 999-1105-043/143/943 – compatible with all Vaddio HDBaseT cameras.
- RoboSHOT 12 HDBT OneLINK HDMI System, 999-9960-100/101
- RoboSHOT 30 HDBT OneLINK HDMI System, 999-9963-100/100W/101/101W
- RoboSHOT 20 UHD OneLINK HDMI System, 999-9950-100/101/109
- DocCAM 20 HDBT OneLINK HDMI System, 999-9968-200/201/209
- Future systems consisting of a Vaddio HDBaseT camera and a OneLINK HDMI receiver

Connecting a Vaddio HDBaseT Camera

999-1105-043/143/943

This diagram is also valid for the following systems:

- RoboSHOT 12 HDBT OneLINK HDMI System, 999-9960-100/101
- RoboSHOT 30 HDBT OneLINK HDMI System, 999-9963-100/100W/101/101W
- DocCAM 20 HDBT OneLINK HDMI System, 999-9968-200/201/209

In this diagram, the OneLINK HDMI extends network connectivity, power, and control to a RoboSHOT HDBT camera, and brings camera video to the connected HDMI display. The OneLINK HDMI passes the camera's IP stream (if available) to the network.

Items in this diagram:

- OneLINK HDMI receiver
- RoboSHOT 12 HDBT camera (not included in kit 999-1105-043/143/943)
- HDMI display and HDMI cable (not included)
- Laptop receiving the camera's IP stream (not included)
- Cat-5e cables for OneLINK and network connections (not included)

RoboSHOT HDBT Camera

Other Vaddio HDBaseT cameras connect in the same way.



Camera Configuration

Keep in mind that the OneLINK HDMI displays its own IP address, not the camera's IP address.

You can configure the following settings on your Vaddio HDBaseT camera:

- HDMI output resolution: Depending on the camera, set this using the rotary switch on the back of the camera or the virtual rotary switch on DIP Switches tab of the System page.
- IP streaming: Streaming page. Settings include Enable/disable, streaming quality, and streaming resolution.

Point the remote at the camera and press the Data Screen button to see the camera's IP address on the connected display.

No additional configuration is required.

Connections for HDBaseT Cameras Used with Codecs

In this configuration, the OneLINK HDMI extends network connectivity, power, and control to an HDBaseT camera, and brings HDMI video from the camera to the codec. The codec may be connected to the OneLINK device directly via RS-232, or they may communicate over the IP network, depending on the codec.

If an IP stream is available from the camera, the OneLINK device passes it to the network. IP streaming resolutions up to 2160p/30 are supported. HDMI output resolution and streaming parameters (including resolution) are configured on the camera, not the OneLINK device.

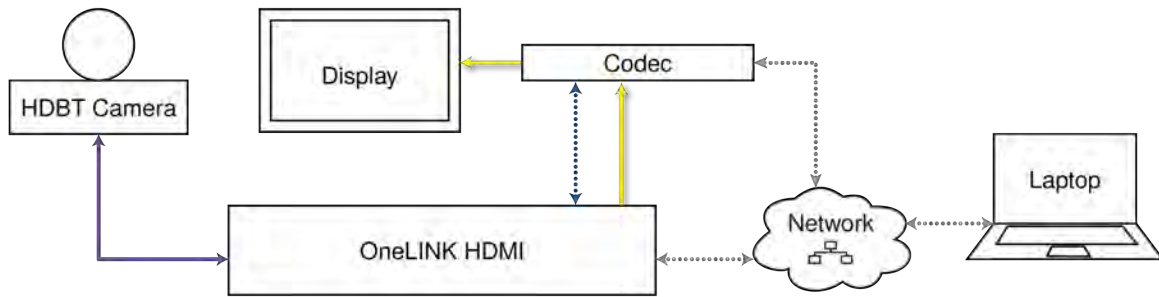

Kits for HDBaseT Cameras Used with Codecs

This block diagram applies to:

- OneLINK HDMI for Vaddio HDBaseT Cameras with Polycom Codecs, 999-9545-000/001/009 – compatible with all Vaddio HDBT cameras and with Polycom RealPresence Group Series codecs.
- OneLINK HDMI for Vaddio HDBaseT Cameras with Cisco Codecs, 999-9575-000/001/009 – compatible with all Vaddio HDBT cameras and with Cisco C20, C40, C60, SX20, and SX80 codecs.

Connecting a Vaddio HDBaseT Camera and Polycom Codec

999-9545-000/001/009

In these diagrams, the OneLINK device extends network connectivity, power, and control to a RoboSHOT HDBT camera, and connects it to a Polycom RealPresence Group Series codec. The OneLINK device passes the camera's IP stream (if available) to the network. The codec provides HDMI video to the connected display.

Other Vaddio HDBaseT cameras would be connected in exactly the same way.

Items in these diagrams:

- OneLINK HDMI receiver
- Power supply with AC cord set
- Codec-side fan-out cable, bare wires terminated with 3-position, 5mm Euro-style connector
- RoboSHOT 12 HDBT camera (not included)
- Polycom RealPresence Group Series codec (not included)
- HDMI display and HDMI cable (not included)
- Laptop receiving the camera's IP stream (not included)
- Cat-5e cables for OneLINK and network connections (not included)

RoboSHOT HDBT Camera and Polycom RealPresence Group 310 Codec

The Group 500 codec looks very similar and connects in the same way.

Other Vaddio HDBaseT cameras connect in the same way.

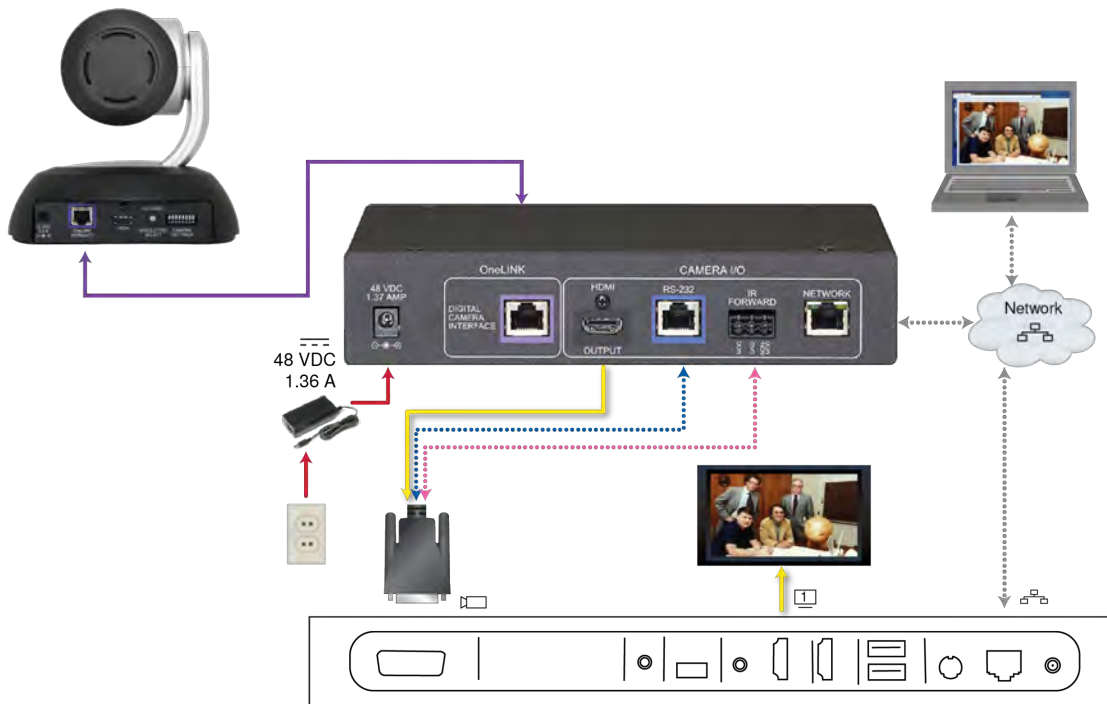

RoboSHOT HDBT Camera and Polycom RealPresence Group 700 Codec

Other Vaddio HDBaseT cameras connect in the same way.

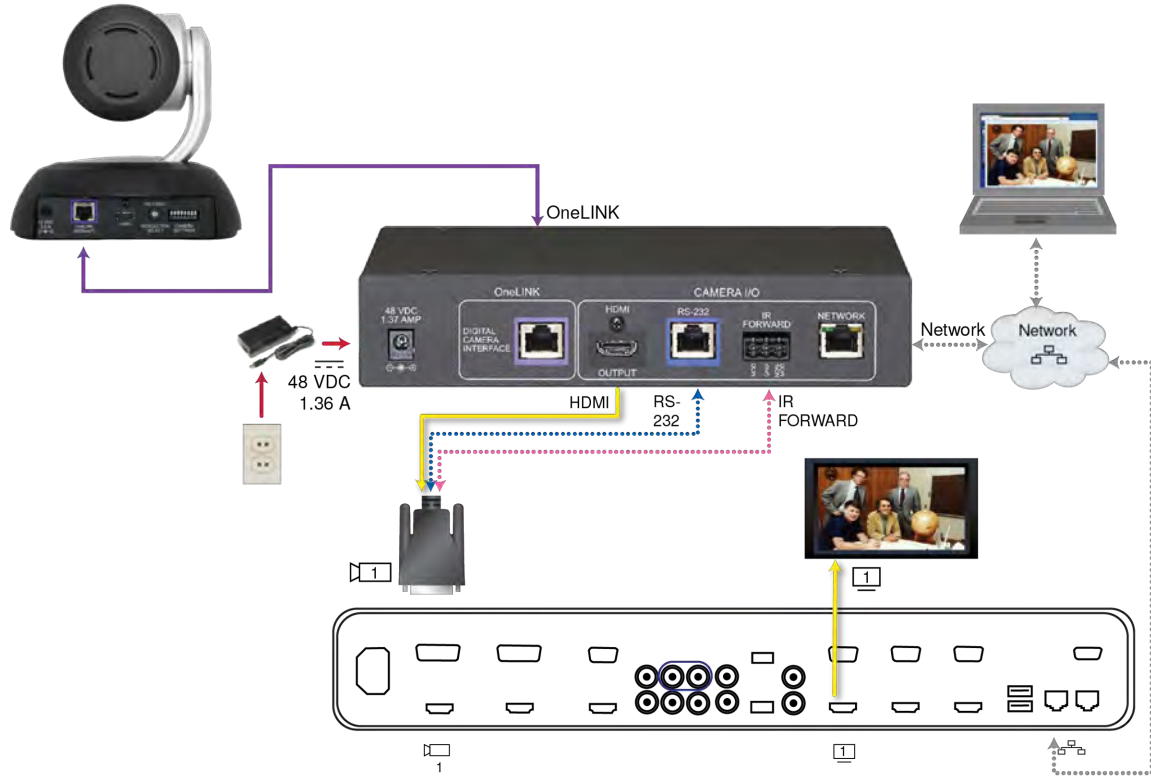

Hardware Note: IR Forwarding

Use the supplied 3-position Euro-style connector to terminate the two unterminated wires of the codec-side fan-out cable as follows:

- Black wire: Center position (pin 2)
- Red wire: Right position (pin 3)

Connect this part of the fan-out cable to the IR FORWARD connector on the OneLINK HDMI receiver.

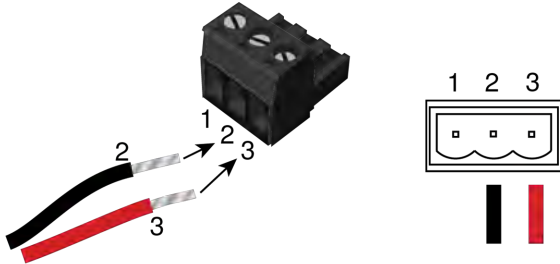

Note

Some fan-out cables have a black/white wire instead of a red one. Wiring is the same – black to pin 2, black/white to pin 3.

Some older fan-out cables have the wires reversed. This will not damage the equipment. If IR forwarding does not work when you terminate the cable per these instructions, remove power from the OneLINK device, disconnect the fan-out cable, and re-terminate the wires with red (or black/white) to pin 2 and black to pin 3. Then reconnect the cable and power up the OneLINK device again.

Hardware Note: Connection and Configuration Changes

After connecting or configuring the equipment, reboot the OneLINK device, camera, and codec. Note that rebooting the OneLINK device does not affect the camera and codec; they must be rebooted separately.

Camera Configuration

Keep in mind that the OneLINK HDMI displays its own IP address, not the camera's IP address.

Point the remote at the camera and press the Data Screen button to see the camera's IP address on the connected display.

You can configure the following settings on your Vaddio HDBaseT camera:

- HDMI output resolution: Depending on the camera, set this using the rotary switch on the back of the camera or the virtual rotary switch on DIP Switches tab of the System page.
- IP streaming: Streaming page. Settings include Enable/disable, streaming quality, and streaming resolution.
- Codec Control Mode: Soft DIP on the DIP Switches tab of the System page.
- IR: ON (default). DIP switch 3 on the back of RoboSHOT 20 UHD or RoboSHOT HDBT cameras, soft DIP 3 on the DIP Switches tab of the System page for DocCAM 20 HDBT.

Note

Codec Control Mode was added to Vaddio cameras in early 2018. Your camera may require a firmware update to add this capability.

Connecting a Vaddio HDBaseT Camera and Cisco Codec

999-9575-000/001/009

In these diagrams, the OneLINK device extends network connectivity, power, and control to a RoboSHOT 12 HDBT camera, and connects it to a Cisco codec. The OneLINK device passes the camera's IP stream (if available) to the network. The codec provides HDMI video to the connected display.

Other Vaddio HDBaseT cameras would be connected in exactly the same way.

Items in these diagrams:

- OneLINK HDMI receiver
- Power supply and AC cord set
- RS-232 adapter 998-1002-232 (used with standard Cat-5 cable on C20, C60. and SX80 codecs)
- Cisco split cable CAB-PHD4XS2-SPLIT(not included; required for SX20 codec)
- Codec-side null modem cable (used with split cable on SX20 codec)
- RoboSHOT 12 HDBT camera (not included)
- Cisco codec (not included)
- HDMI display and HDMI cable (not included)
- Laptop receiving the camera's IP video stream (not included)
- Cat-5e cables for OneLINK and network connections (not included)

RoboSHOT HDBT Camera and Cisco C20 Codec

Other Vaddio HDBaseT cameras connect in the same way.

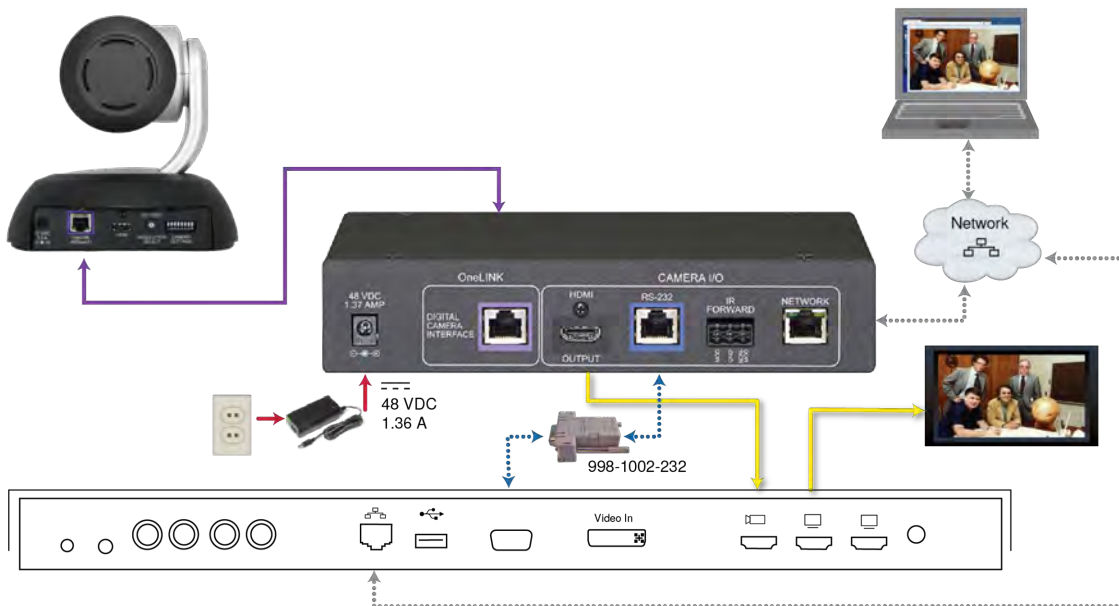

RoboSHOT HDBT Camera and Cisco C60 Codec

The C40 codec looks very similar and connects in the same way.
Other Vaddio HDBaseT cameras connect in the same way.

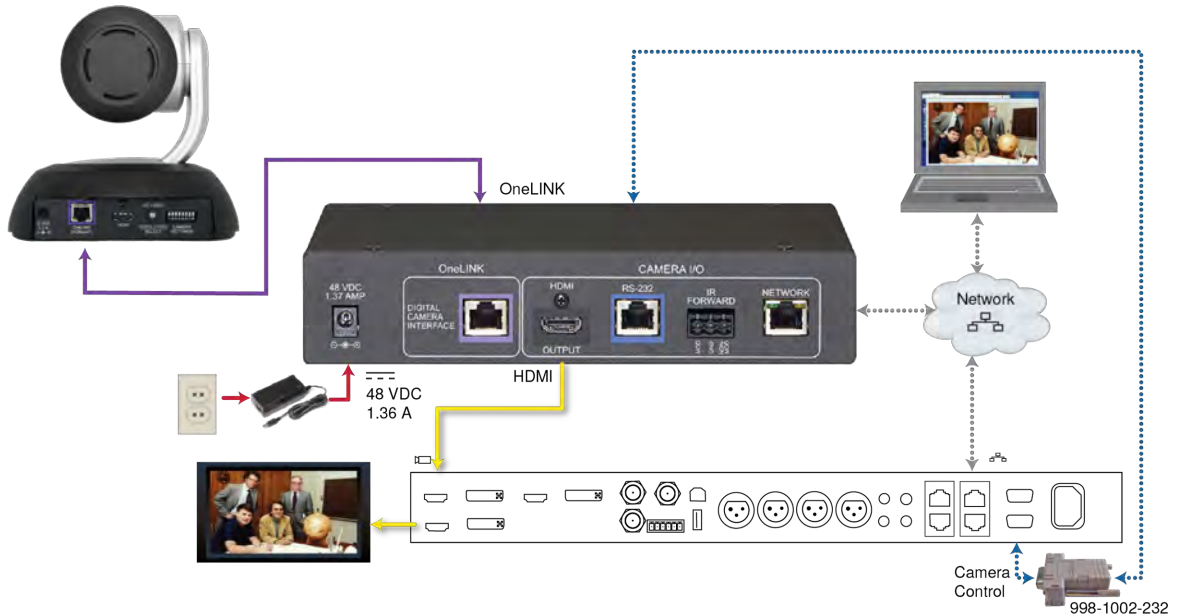

RoboSHOT HDBT Camera and Cisco SX20 Codec

Other Vaddio HDBaseT cameras connect in the same way.

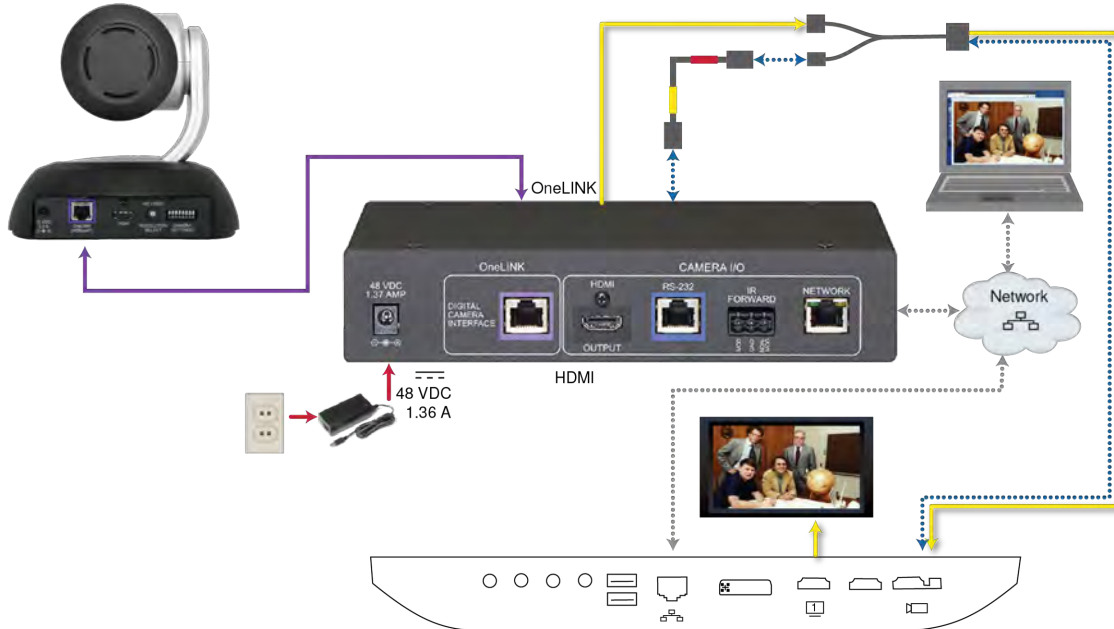

Note

If connecting to a Cisco SX20 codec, you will need to provide a Cisco split cable, Cisco part number CAB-PHD4XS2-SPLIT.

RoboSHOT HDBT Camera and Cisco SX80 Codec

Other Vaddio HDBaseT cameras connect in the same way.

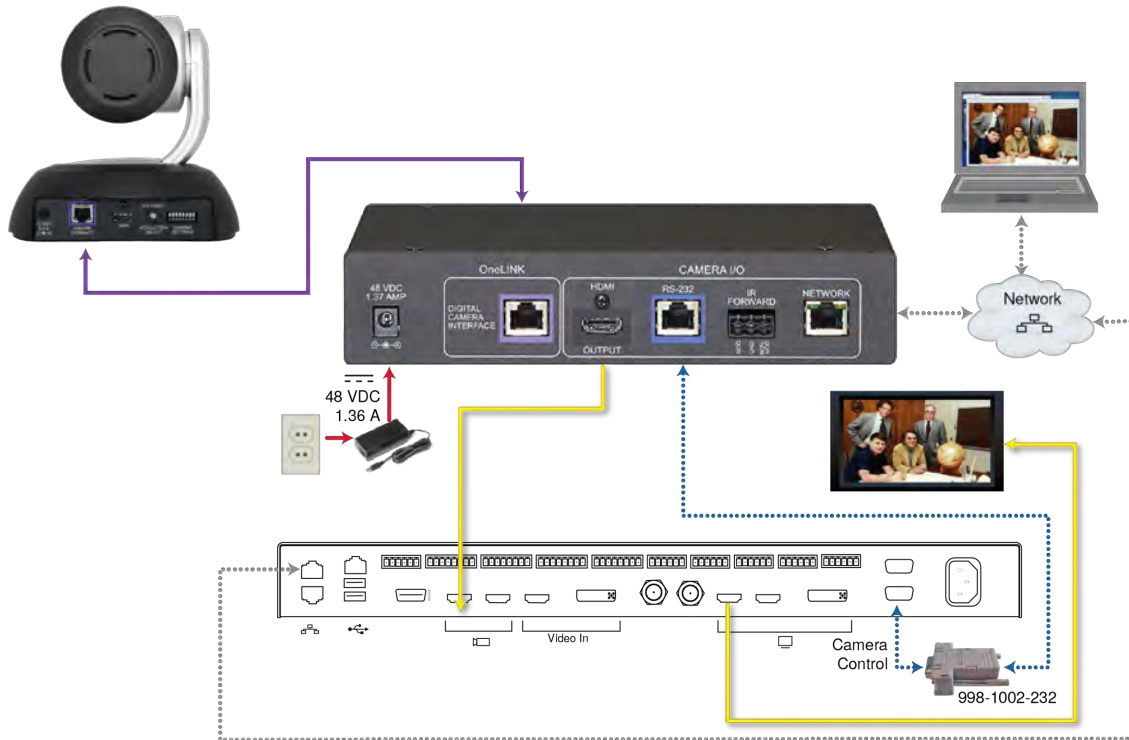

Hardware Note: RS-232 Connections

For RS-232 connections to Cisco gear using DE-9 connectors, use the 998-1002-232 RJ-45 to DE-9 adapter. Its wiring differs from the 998-1001-232 adapter shipped with many Vaddio products. For RS-232 connections to Cisco gear using the Cisco split cable, use the appropriate null-modem cable to the RJ-45 side of the split cable. Connect the null-modem cable as indicated on the cable labels.

Hardware Note: Connection and Configuration Changes

After connecting or configuring the equipment, reboot the OneLINK device, camera, and codec. Note that rebooting the OneLINK device does not affect the camera and codec; they must be rebooted separately.

Camera Configuration

Keep in mind that the OneLINK HDMI displays its own IP address, not the camera's IP address.

Point the remote at the camera and press the Data Screen button to see the camera's IP address on the connected display.

You can configure the following settings on your Vaddio HDBaseT camera:

- HDMI output resolution: Depending on the camera, set this using the rotary switch on the back of the camera or the virtual rotary switch on DIP Switches tab of the System page.
- IP streaming: Streaming page. Settings include Enable/disable, streaming quality, and streaming resolution.
- Codec Control Mode: Soft DIP on the DIP Switches tab of the System page.
- IR: ON (default). DIP switch 3 on the back of RoboSHOT 20 UHD or RoboSHOT HDBT cameras, soft DIP 3 on the DIP Switches tab of the System page for DocCAM 20 HDBT.

Note

Codec Control Mode was added to Vaddio cameras in early 2018. Your camera may require a firmware update to add this capability.

Connections for HDMI Cameras

In this configuration, the OneLINK HDMI extends network connectivity, power, and control to an HDMI camera, and brings HDMI video from the camera to a display. The camera can optionally be controlled by a camera controller on an RS-232 serial connection to the OneLINK HDMI or over the network, depending on the controller.

If an IP stream is available from the camera, the OneLINK device passes it to the network. IP streaming resolutions up to 2160p/30 are supported. HDMI output resolution and streaming parameters (including resolution) are configured on the camera, not the OneLINK device.

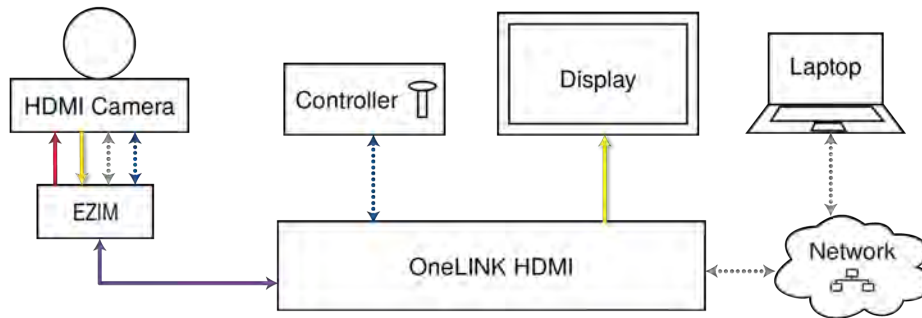

Kits for HDMI Cameras

This block diagram applies to:

- OneLINK HDMI camera extension for Polycom cameras with Polycom Codecs, 999-9520-000/001/009, when used without a codec – compatible with Polycom EagleEye IV camera.
- OneLINK HDMI camera extension for Sony and Panasonic Cameras, 999-9530-000/001/009 – compatible with Panasonic HE-series, Sony EVI-D series, and Sony BRC-H series cameras.
- OneLINK HDMI camera extension for Cisco Cameras with Cisco Codecs, 999-9660-000/001/009, when used without a codec – compatible with Cisco Precision series cameras.
- OneLINK HDMI camera extension for RoboSHOT HDMICameras, 999-9590-000/001/009

Connecting a RoboSHOT HDMI Camera

999-9590-000/001/009

In this diagram, the OneLINK device extends network connectivity, power, and control to a RoboSHOT HDMI camera, and brings camera video to the connected HDMI display.

Items in this diagram:

- OneLINK HDMI receiver and OneLINK EZIM
- OneLINK power supply and AC cord set
- RoboSHOT 12 HDMI camera (not included)
- Power cable, HDMI cable, and Cat-5e cables from the OneLINK EZIM to the camera
- HDMI display and HDMI cable (not included)
- Laptop providing access to the camera's web interface (not included)
- Cat-5e cables for OneLINK and network connections (not included)

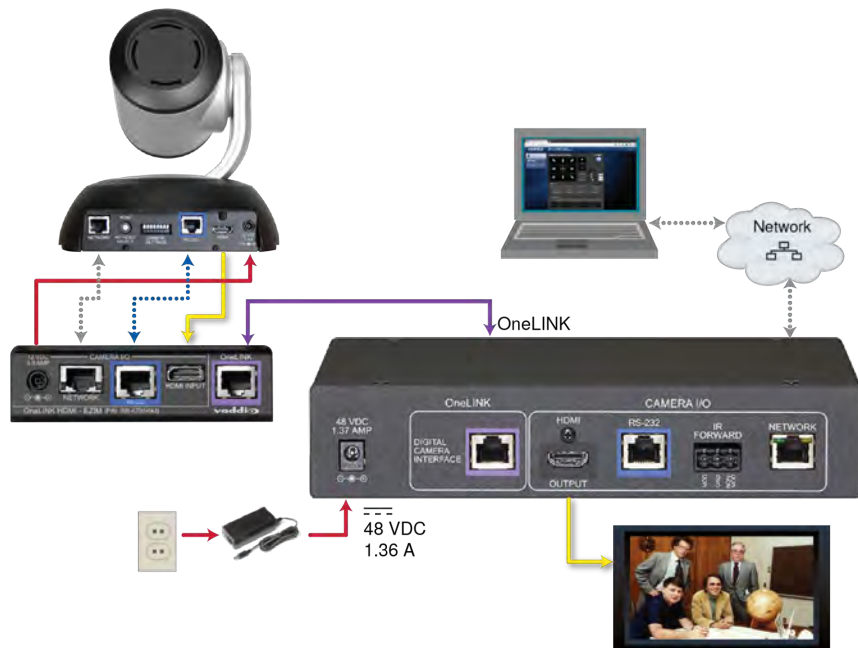

Camera Configuration

Set HDMI output resolution using the rotary switch on the back of the camera. No additional configuration is required; if desired, additional configuration is available via the camera's web interface. Point the remote at the camera and press the Data Screen button to see the camera's IP address on the connected HDMI display.

Keep in mind that the OneLINK HDMI receiver displays its own IP address, not the camera's IP address.

Connecting a Polycom EagleEye IV Camera

999-9520-000/001/009

In this diagram, the OneLINK device extends network connectivity, power, and control to a Polycom EagleEye IV camera. The OneLINK device provides HDMI video to the connected display.

Items in this diagram:

- OneLINK HDMI receiver and OneLINK EZIM
- Power supply and AC cord set
- Camera-side fan-out cable
- Polycom EagleEye IV camera (not included)
- HDMI display and cable (not included)
- Cat-5e cables for OneLINK and network connections (not included)

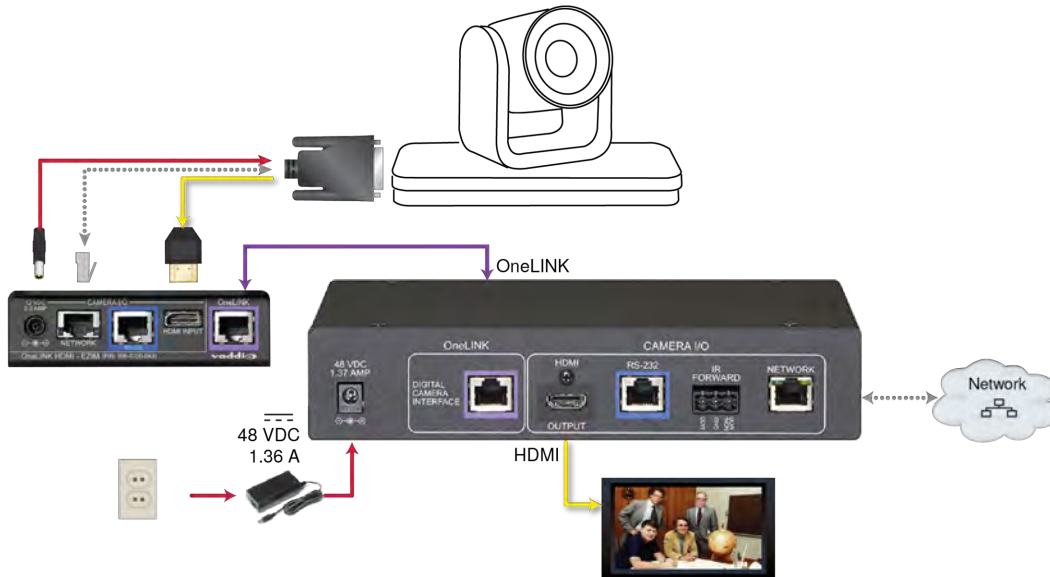

Connecting a Cisco Camera

999-9560-000/001/009

In these diagrams, the OneLINK device extends power and control to a Cisco camera, and brings camera video to the connected HDMI display.

Items in these diagrams:

- OneLINK HDMI receiver and OneLINK EZIM
- Camera-side fan-out cable (not included; used with Precision 40 and Precision HD 1080p2.5x)
- Cisco camera (not included)
- HDMI display and HDMI cable (not included)
- Cat-5e cables for OneLINK and network connections (not included)

Cisco Precision 40 or Precision HD Series Camera

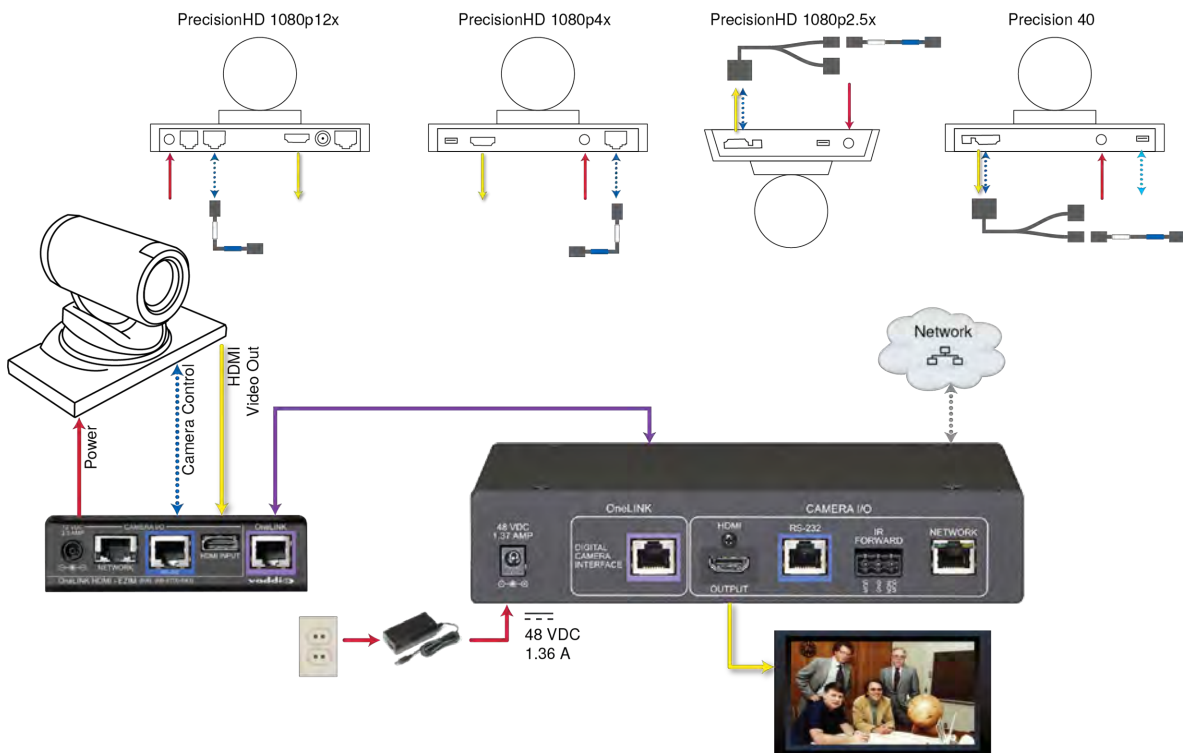

Note

If connecting to a Cisco Precision 40 or Precision HD 1080p2.5x camera, you will need to provide a Cisco split cable, Cisco part number CAB-PHD4XS2-SPLIT.

Cisco Precision 60 Camera

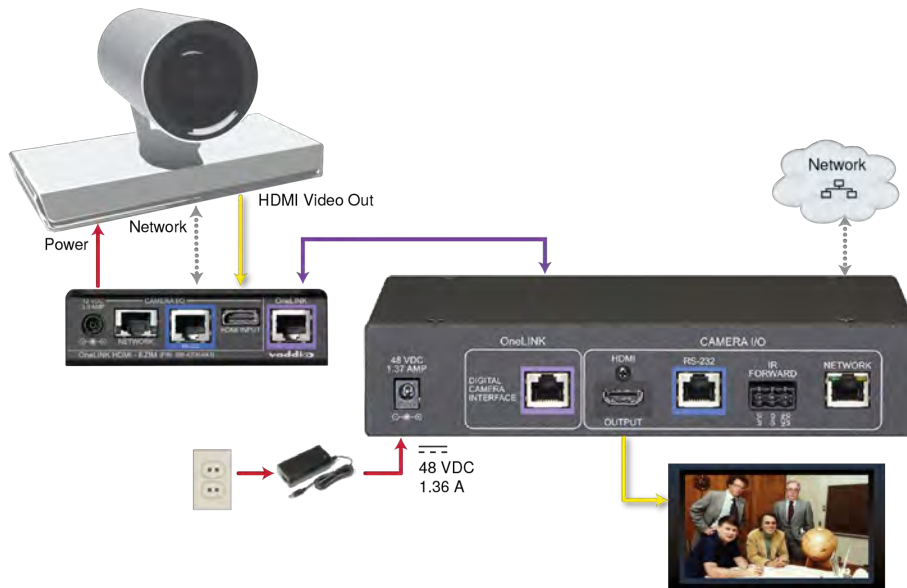

Hardware Note: RS-232 Connections

For RS-232 connections to Cisco cameras, use the appropriate null-modem cable. Connect it as indicated on the cable labels. This cable is used with the Cisco split cable CAB-PHD4XS2-SPLIT for some cameras.

Connecting a Sony or Panasonic HDMI Camera

999-9530-000/001/009

In these diagrams, the OneLINK device extends power and control to a Sony or Panasonic HDMI camera. The OneLINK device provides HDMI video to the connected display.

Items in this diagram:

- OneLINK HDMI receiver and OneLINK EZIM
- Power supply and AC cord set
- Camera with cables (not included)
- HDMI display and cable (not included)

Panasonic AW-HE130 Camera

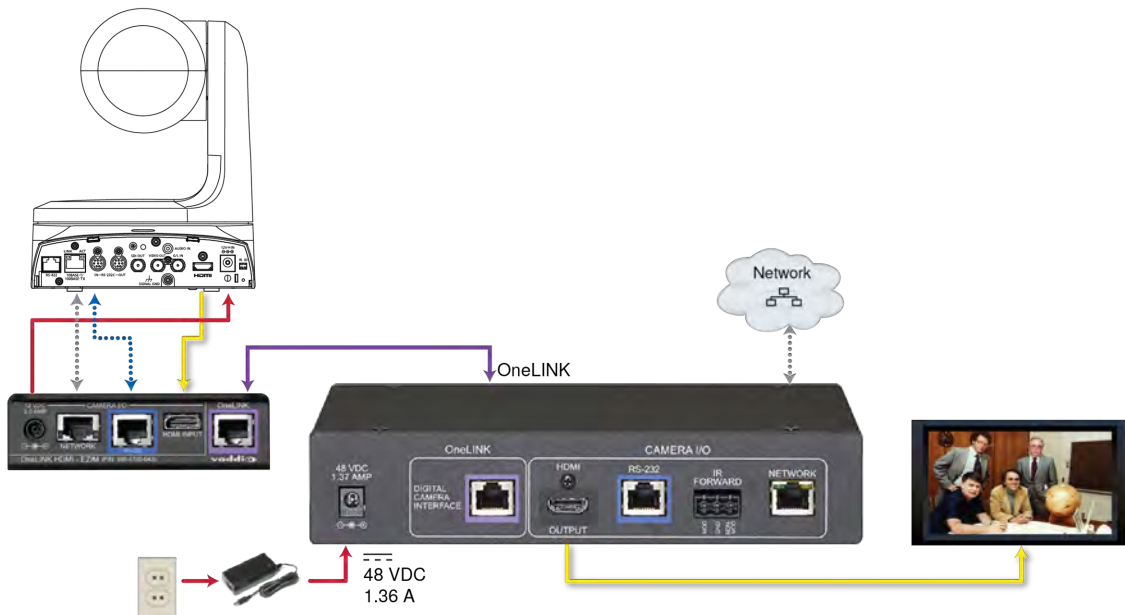

Sony SRG300 Camera

The SRG120 camera's connector panel looks very similar, and connects in the same way.

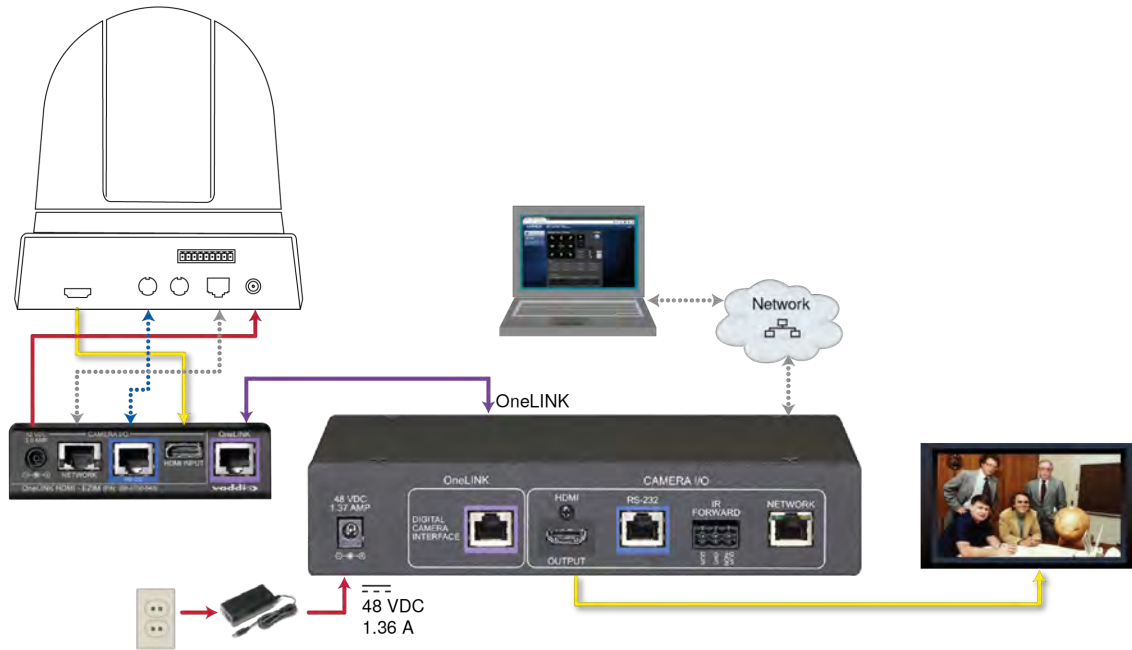

Connections for HDMI Cameras Used with Codecs

In this configuration, the OneLINK HDMI extends network connectivity, power, and control to an HDMI camera, and brings HDMI video from the camera to the codec. The codec may be connected to the OneLINK device directly via RS-232, or they may communicate over the IP network, depending on the codec.

If an IP stream is available from the camera, the OneLINK device passes it to the network. IP streaming resolutions up to 2160p/30 are supported. HDMI output resolution and streaming parameters (including resolution) are configured on the camera, not the OneLINK device.

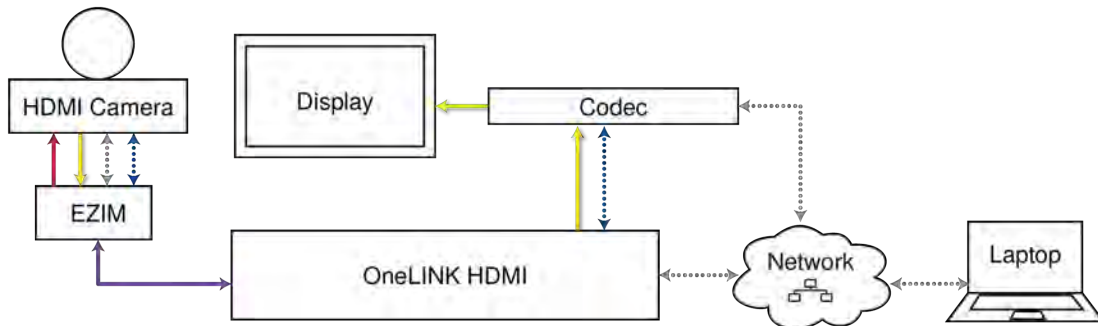

Kits for HDMI Cameras Used with Codecs

This block diagram applies to:

- OneLINK HDMI for Polycom Cameras with Polycom Codecs, 999-9520-000/001/009 – compatible with Polycom EagleEye IV camera and Polycom RealPresence Group Series codecs.
- OneLINK HDMI for RoboSHOT HDMI Cameras with Polycom Codecs, 999-9540-000/001/009 – compatible with RoboSHOT HDMI cameras and Polycom RealPresence Group Series codecs.
- OneLINK HDMI for Cisco Cameras with Cisco Codecs, 999-9660-000/001/009 – compatible with Cisco Precision series cameras and Cisco C20, C40, C60, SX20, and SX80 codecs.
- OneLINK HDMI for RoboSHOT HDMI Cameras with Cisco Codecs, 999-9570-000/001/009 – Compatible with RoboSHOT HDMI cameras and Cisco C20, C40, C60, SX20, and SX80 codecs.

Connecting a RoboSHOT HDMI Camera and Polycom Codec

999-9540-000/001/009

In these diagrams, the OneLINK device extends network connectivity, power, and control to a RoboSHOT HDMI camera, and connects it to a Polycom RealPresence Group Series codec. The codec provides HDMI video to the connected display.

Items in these diagrams:

- OneLINK HDMI receiver and OneLINK EZIM
- Power supply with AC cord set
- RoboSHOT 12 HDMI camera (not included)
- Polycom RealPresence Group Series codec (not included)
- Codec-side fan-out cable, bare wires terminated with 3-position, 5mm Euro-style connector
- HDMI display and HDMI cable (not included)
- Laptop providing access to the camera's web interface (not included)
- Cat-5e cables for OneLINK and network connections (not included)

RoboSHOT HDMI Camera and Polycom RealPresence Group 310 Codec

The Group 500 codec looks very similar and connects in the same way.

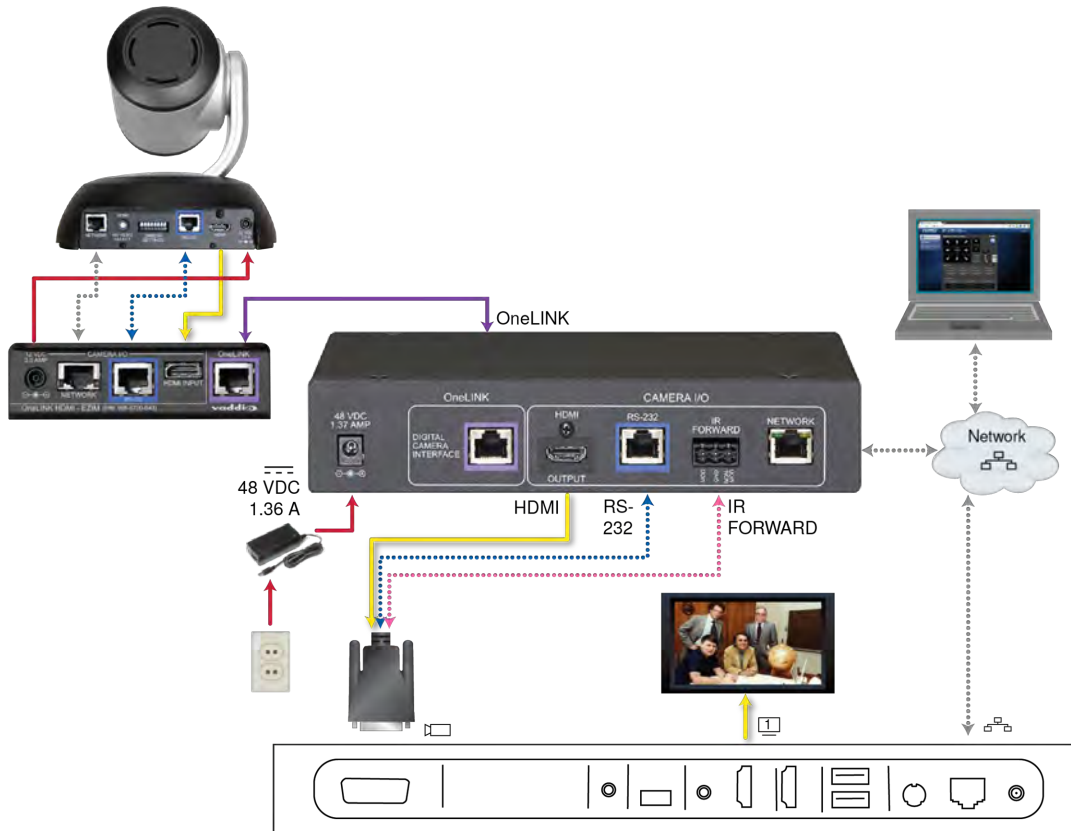

RoboSHOT HDMI Camera and Polycom RealPresence Group 700 Codec

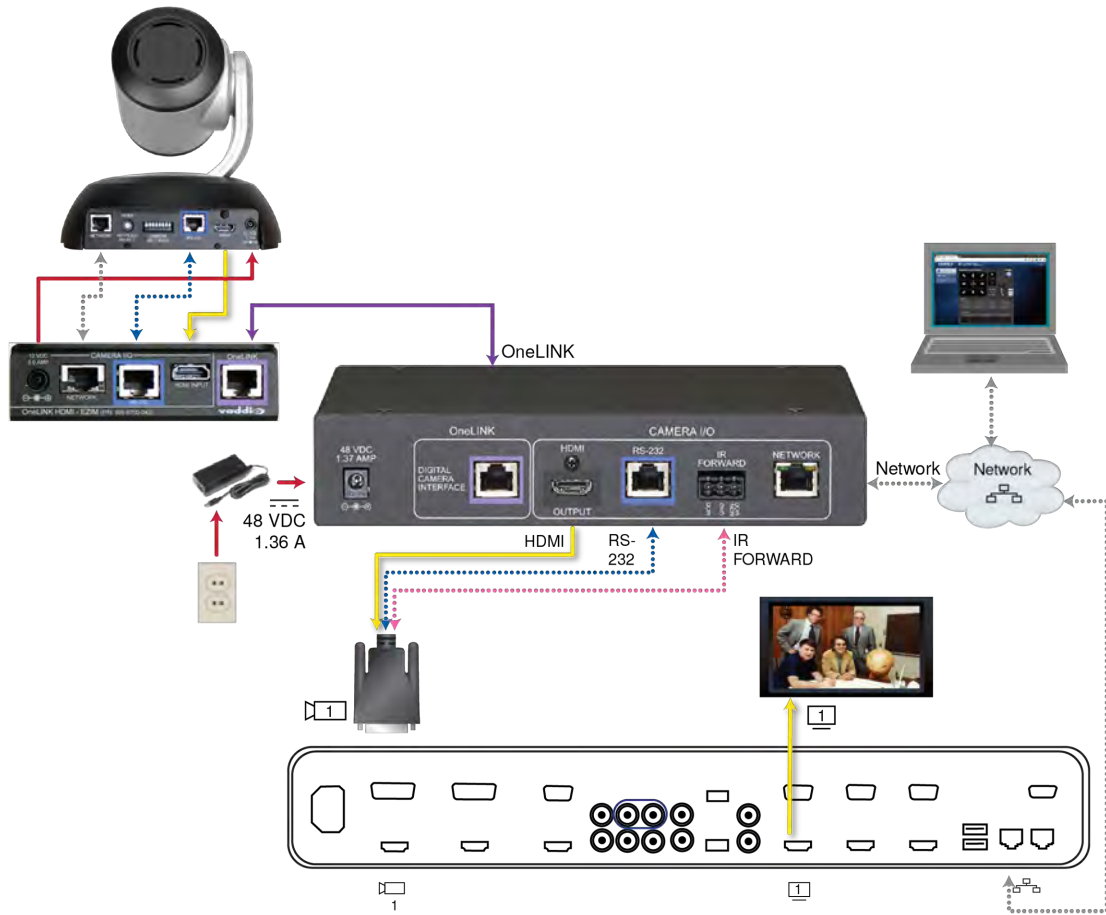

Hardware Note: IR Forwarding

Use the supplied 3-position Euro-style connector to terminate the two unterminated wires of the codec-side fan-out cable as follows:

- Black wire: Center position (pin 2)
- Red wire: Right position (pin 3)

Connect this part of the fan-out cable to the IR FORWARD connector on the OneLINK HDMI receiver.

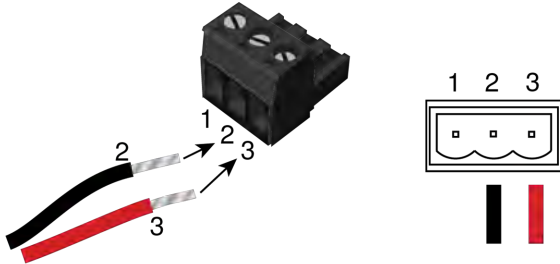

Note

Some fan-out cables have a black/white wire instead of a red one. Wiring is the same – black to pin 2, black/white to pin 3.

Some older fan-out cables have the wires reversed. This will not damage the equipment. If IR forwarding does not work when you terminate the cable per these instructions, remove power from the OneLINK device, disconnect the fan-out cable, and re-terminate the wires with red (or black/white) to pin 2 and black to pin 3. Then reconnect the cable and power up the OneLINK device again.

Hardware Note: Connection and Configuration Changes

After connecting or configuring the equipment, reboot the OneLINK device, camera, and codec. Note that rebooting the OneLINK device does not affect the camera and codec; they must be rebooted separately.

Camera Configuration

Set HDMI resolution and IR forwarding using the switches on the back of the camera:

- Set HDMI output resolution using the rotary switch.
- Set DIP switch 3 DOWN to enable IR forwarding.

Codec Control Mode and other configuration settings are available from the camera's web interface. Point the remote at the camera and press the Data Screen button to see the camera's IP address on the connected HDMI display.

Enable Codec Control Mode on the DIP Switches tab of the System page.

Keep in mind that the OneLINK HDMI receiver displays its own IP address, not the camera's IP address.

Note

Codec Control Mode was added to Vaddio cameras in early 2018. Your camera may require a firmware update to add this capability.

Connecting a Polycom EagleEye IV Camera and Polycom Codec

999-9520-000/001/009

In these diagrams, the OneLINK device extends network connectivity, power, and control to a Polycom EagleEye IV camera, and connects it to a Polycom codec. The codec provides HDMI video to the connected display.

Items in these diagrams:

- OneLINK HDMI receiver and OneLINK EZIM
- Power supply with AC cord set
- Polycom EagleEye IV camera (not included)
- Polycom RealPresence Group Series codec (not included)
- Codec-side fan-out cable, bare wires terminated with 3-position, 5mm Euro-style connector
- HDMI display and HDMI cable (not included)
- Cat-5e cables for OneLINK and network connections (not included)

Polycom EagleEye IV Camera and Polycom RealPresence Group 310 Codec

The Group 500 codec looks very similar and connects in the same way.

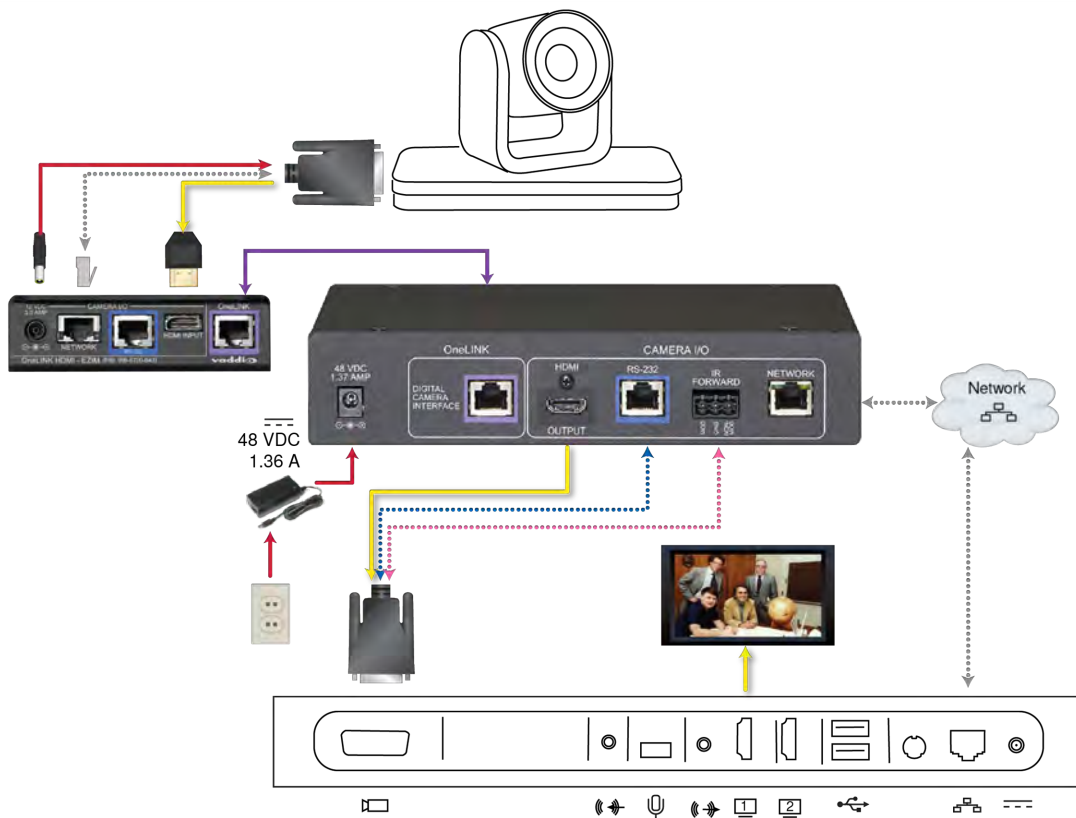

Polycom EagleEye IV Camera and Polycom RealPresence Group 700 Codec

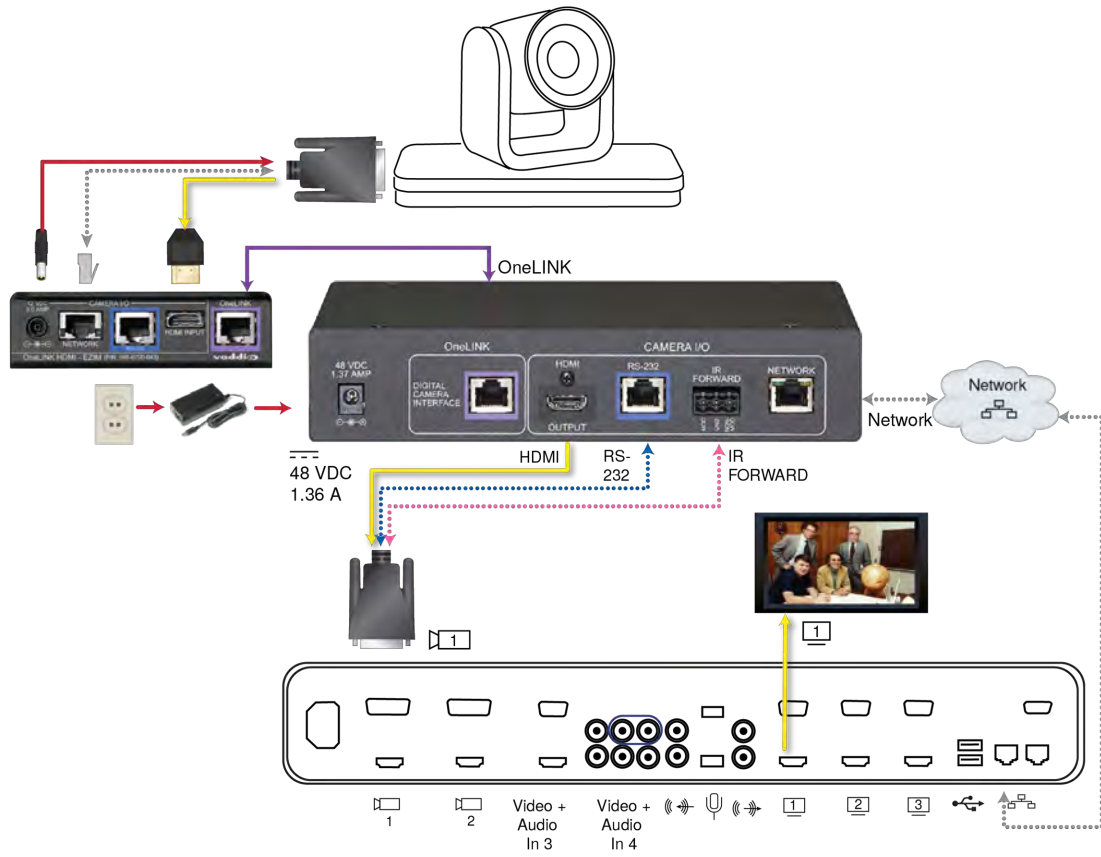

Hardware Note: IR Forwarding

Use the supplied 3-position Euro-style connector to terminate the two unterminated wires of the codec-side fan-out cable as follows:

- Black wire: Center position (pin 2)
- Red wire: Right position (pin 3)

Connect this part of the fan-out cable to the IR FORWARD connector on the OneLINK HDMI receiver.

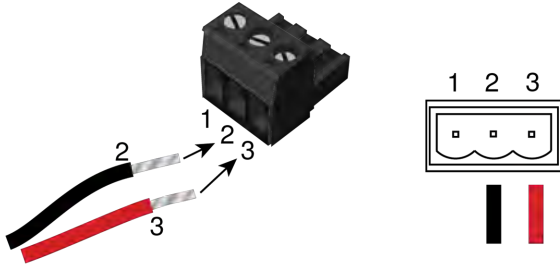

Note

Some fan-out cables have a black/white wire instead of a red one. Wiring is the same – black to pin 2, black/white to pin 3.

Some older fan-out cables have the wires reversed. This will not damage the equipment. If IR forwarding does not work when you terminate the cable per these instructions, remove power from the OneLINK device, disconnect the fan-out cable, and re-terminate the wires with red (or black/white) to pin 2 and black to pin 3. Then reconnect the cable and power up the OneLINK device again.

Hardware Note: Connection and Configuration Changes

After connecting or configuring the equipment, reboot the OneLINK device, camera, and codec. Note that rebooting the OneLINK device does not affect the camera and codec; they must be rebooted separately.

Connecting a RoboSHOT HDMI Camera and Cisco Codec

999-9570-000/001/009

In these diagrams, the OneLINK device extends network connectivity, power, and control to a RoboSHOT HDMI camera, and connects it to a Cisco codec. The codec provides HDMI video to the connected display.

Items in these diagrams:

- OneLINK HDMI receiver and OneLINK EZIM
- Power supply and AC cord set
- RS-232 adapter 998-1002-232 (used with standard Cat-5 cable on C20, C60. and SX80 codecs)
- Cisco split cable CAB-PHD4XS2-SPLIT (not included; required for SX20 codec)
- Codec-side null modem cable (used with split cable on SX20 codec)
- RoboSHOT 12 HDMI camera (not included)
- Cisco codec (not included)
- HDMI display and HDMI cable (not included)
- Laptop providing access to the camera's web interface (not included)
- Cat-5e cables for OneLINK and network connections (not included)

RoboSHOT HDMI Camera and Cisco C20 Codec

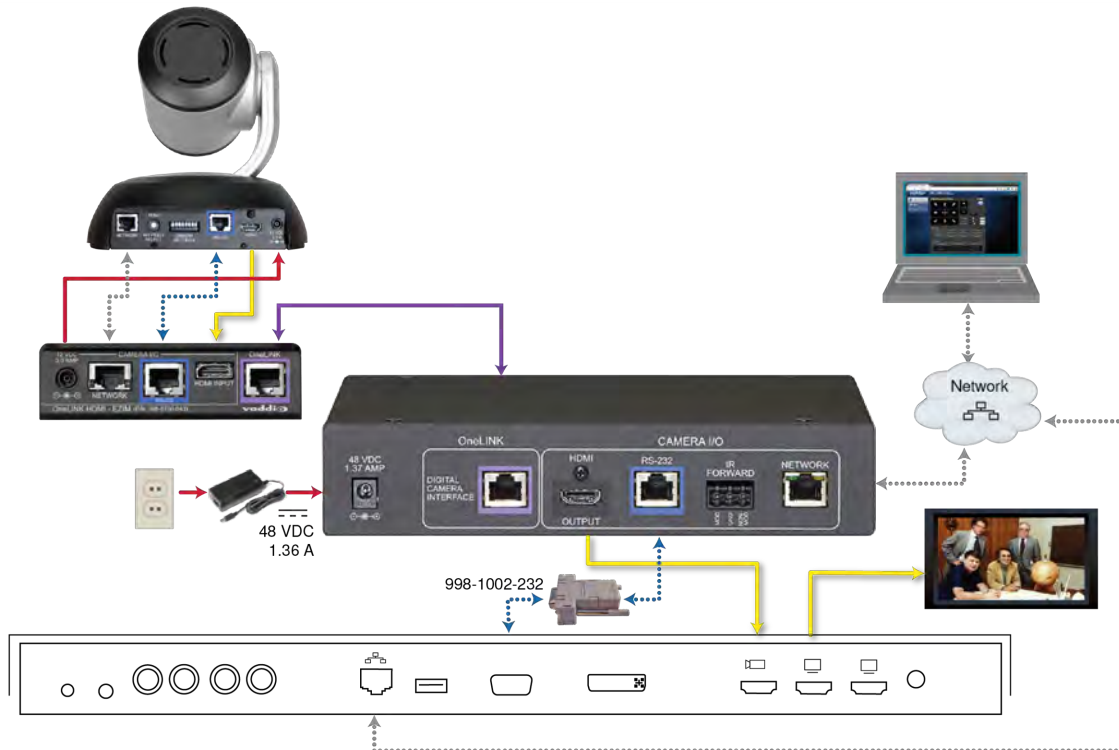

RoboSHOT HDMI Camera and Cisco C60 Codec

The C40 codec looks very similar and connects in the same way.

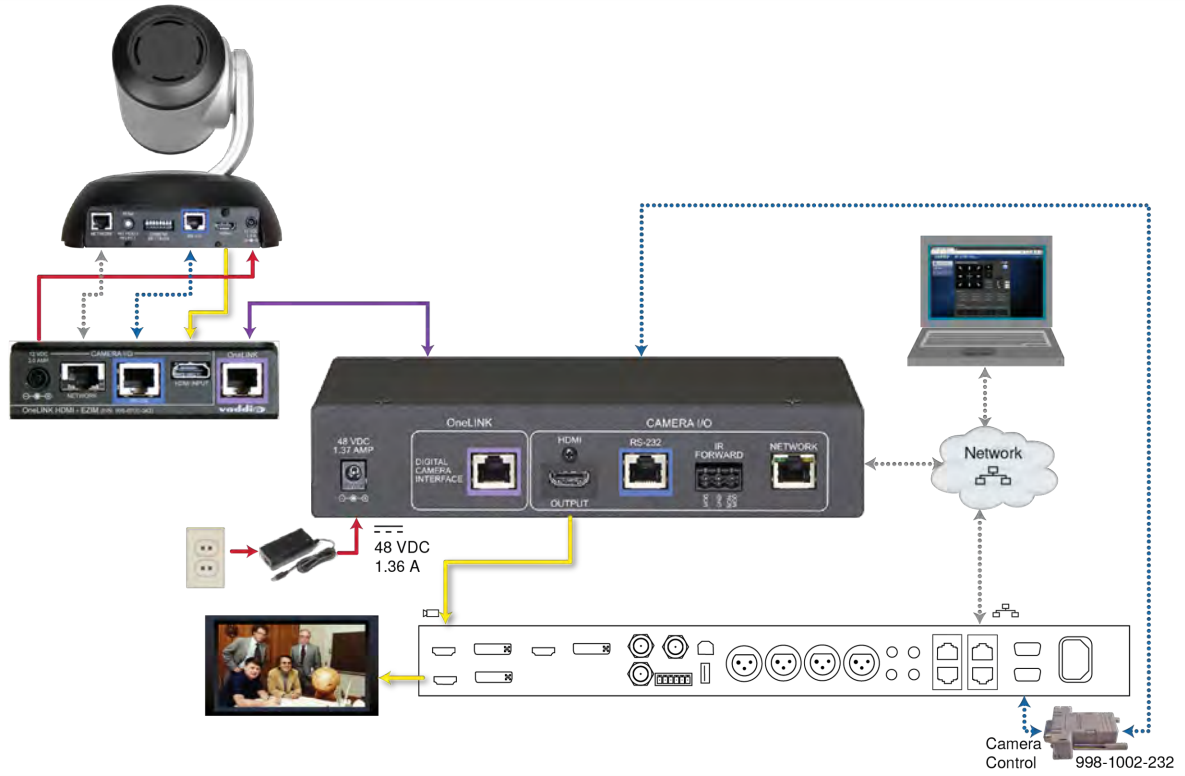

RoboSHOT HDMI Camera and Cisco SX20 Codec

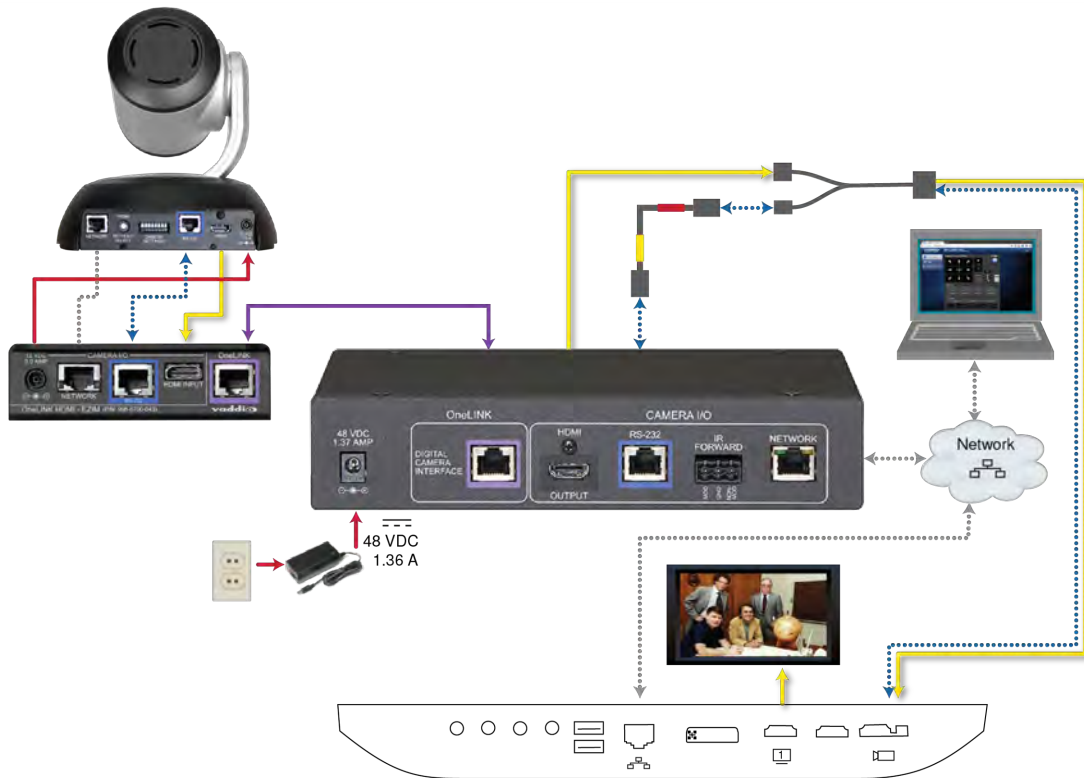

Note

If connecting to a Cisco SX20 codec, you will need to provide a Cisco split cable, Cisco part number CAB-PHD4XS2-SPLIT.

RoboSHOT HDMI Camera and Cisco SX80 Codec

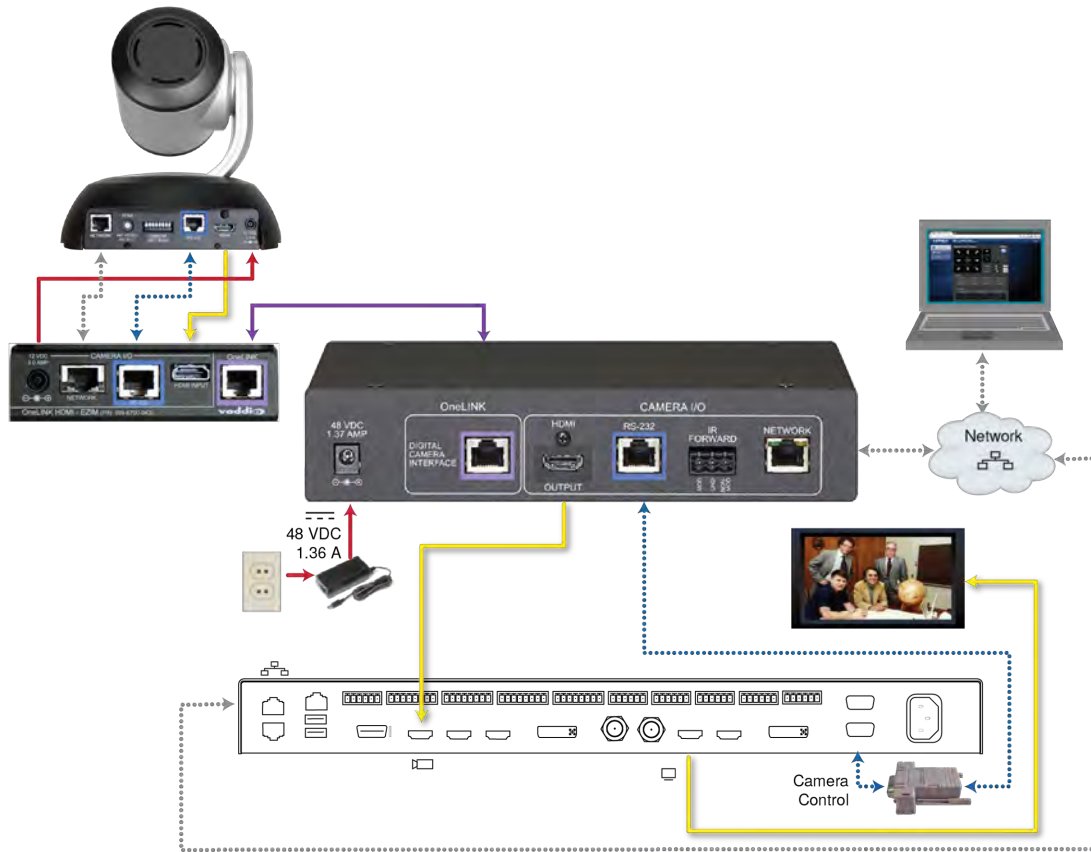

Hardware Note: RS-232 Connections

For RS-232 connections to Cisco gear using DE-9 connectors, use the 998-1002-232 RJ-45 to DE-9 adapter. Its wiring differs from the 998-1001-232 adapter shipped with many Vaddio products.

For RS-232 connections to Cisco gear using the Cisco split cable, use the appropriate null-modem cable to the RJ-45 side of the split cable. Connect the null-modem cable as indicated on the cable labels.

Hardware Note: Connection and Configuration Changes

After connecting or configuring the equipment, reboot the OneLINK device, camera, and codec. Note that rebooting the OneLINK device does not affect the camera and codec; they must be rebooted separately.

Camera Configuration

Set HDMI resolution and IR forwarding using the switches on the back of the camera:

- Set HDMI output resolution using the rotary switch.
- Set DIP switch 3 DOWN to enable IR forwarding.

Codec Control Mode and other configuration settings are available from the camera's web interface. Point the remote at the camera and press the Data Screen button to see the camera's IP address on the connected HDMI display.

Enable Codec Control Mode on the DIP Switches tab of the System page.

Keep in mind that the OneLINK HDMI receiver displays its own IP address, not the camera's IP address.

Note

Codec Control Mode was added to Vaddio cameras in early 2018. Your camera may require a firmware update to add this capability.

Connecting a Cisco Camera and Codec

999-9560-000/001/009

In these diagrams, the OneLINK device extends power and control to a Cisco camera, and connects it to a Cisco codec. The codec provides HDMI video to the connected display.

Items in these diagrams:

- OneLINK HDMI receiver and OneLINK EZIM
- Cisco split cable CAB-PHD4XS2-SPLIT (not included; required for SX20 codec and for Precision 40 and Precision HD 1080p2.5x cameras)
- Camera-side null modem cable (used on all supported Cisco cameras)
- Codec-side null modem cable (used with Cisco split cable on SX20 codec)
- RS-232 adapter 998-1002-232 (used with standard Cat-5 cable on C20, C60. and SX80 codecs)
- Cisco camera (not included)
- Cisco codec (not included)
- HDMI display and HDMI cable (not included)
- Cat-5e cables for OneLINK and network connections (not included)

Note

If connecting to a Cisco SX20 codec, you will need to provide a Cisco split cable, Cisco part number CAB-PHD4XS2-SPLIT. This cable is also required when connecting to a Cisco Precision 40 or Precision HD 1080p2.5x camera; you will need two of them if connecting one of these cameras and an SX20 codec.

Cisco Precision 40 or Precision HD Series Camera and Cisco C20 Codec

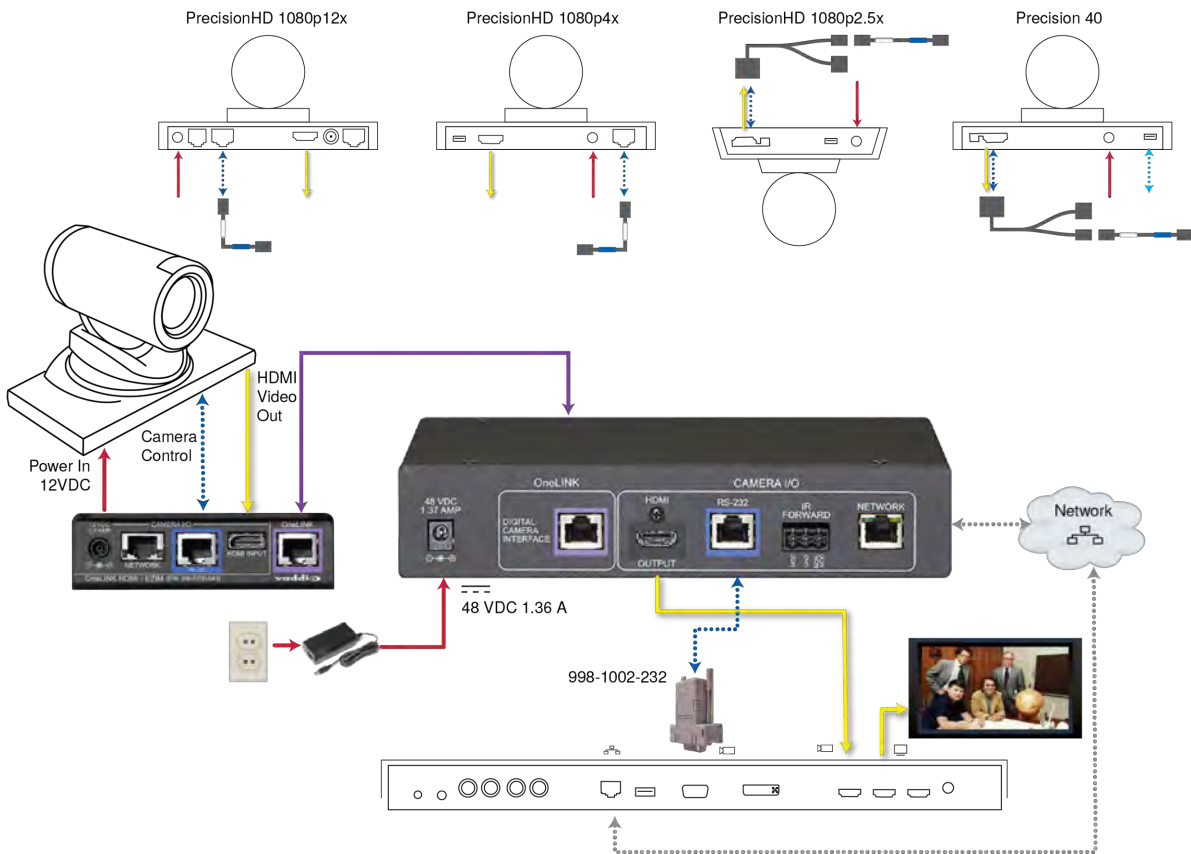

Cisco Precision 40 or Precision HD Series Camera and Cisco C60 Codec

The C40 codec looks very similar and connects in the same way.

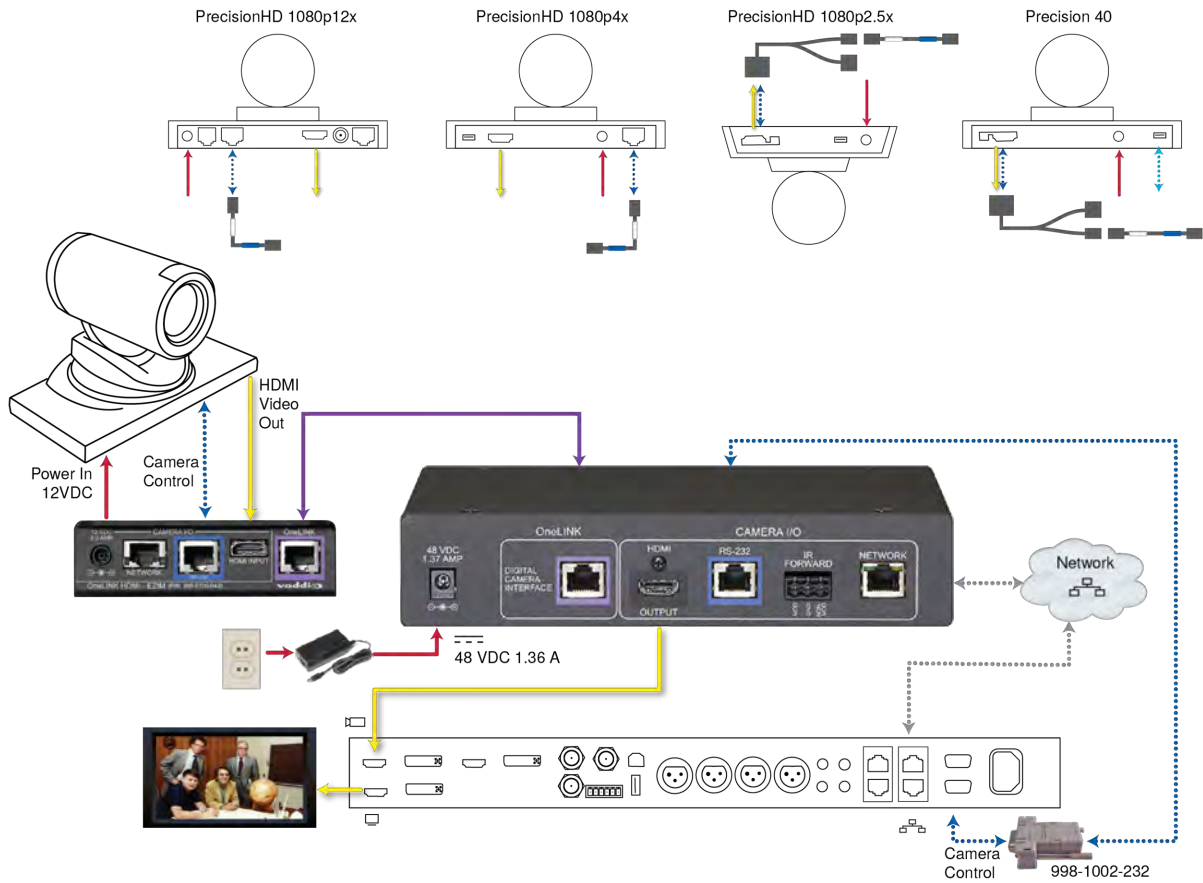

Cisco Precision 40 or Precision HD Series Camera and Cisco SX20 Codec

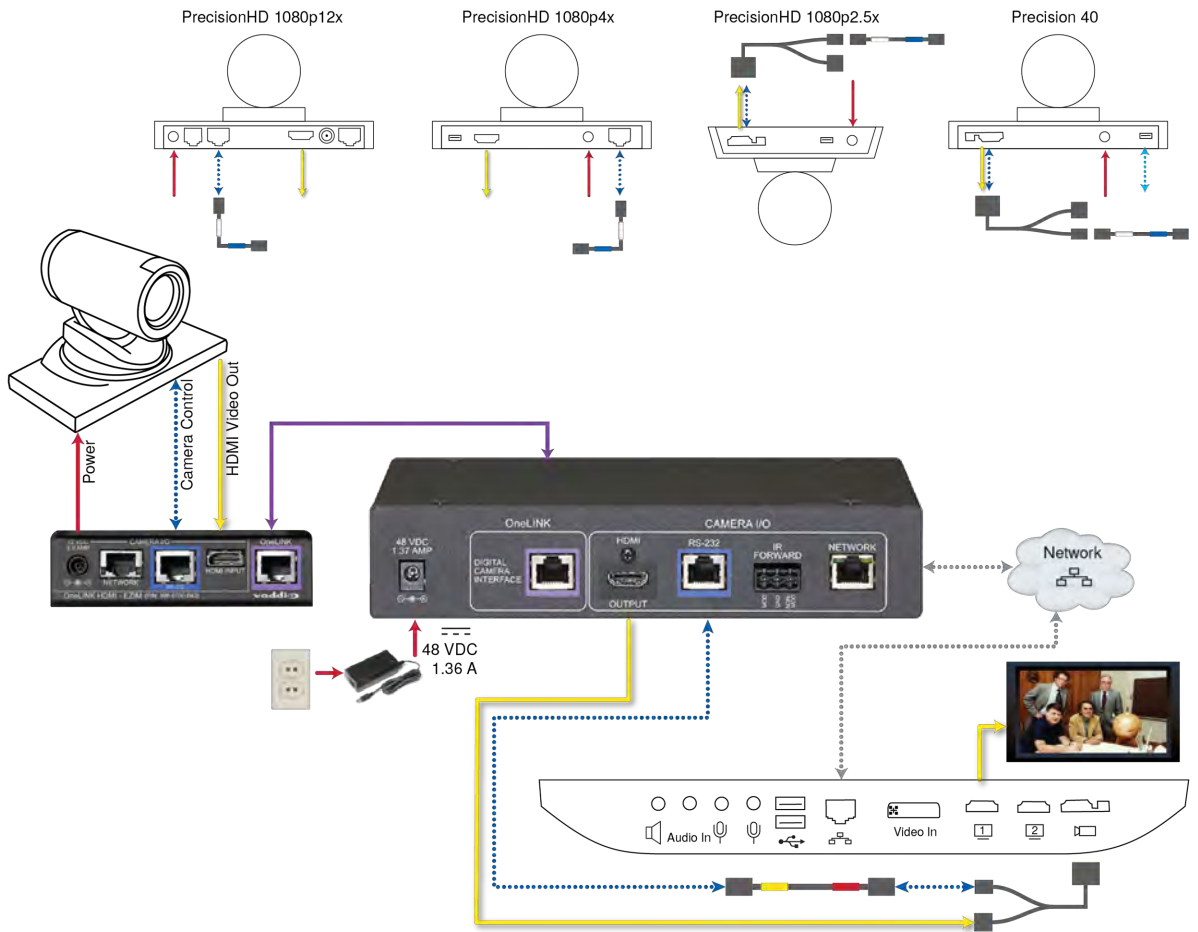

Cisco Precision 40 or Precision HD Series Camera and Cisco SX80 Codec

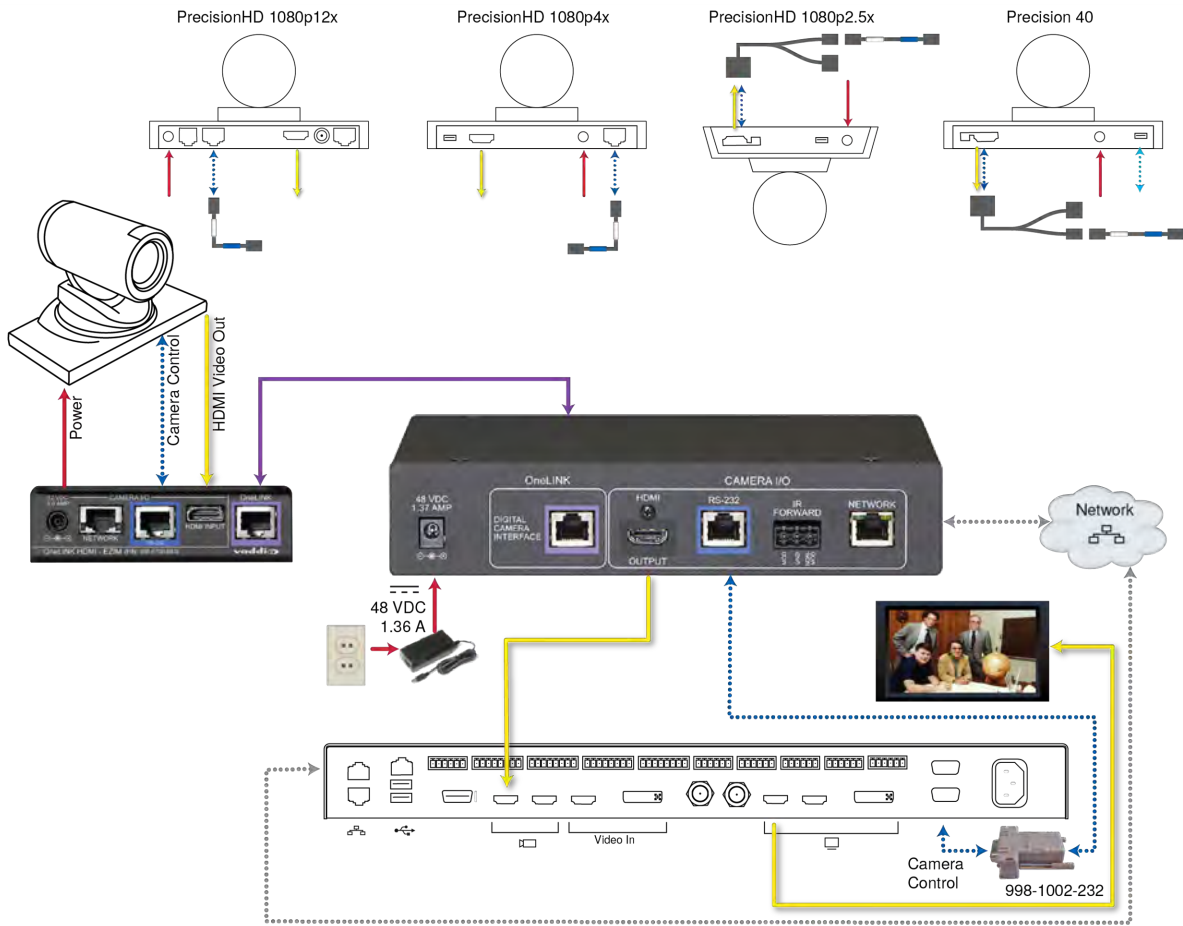

Cisco Precision 60 Camera and Cisco SX80 Codec

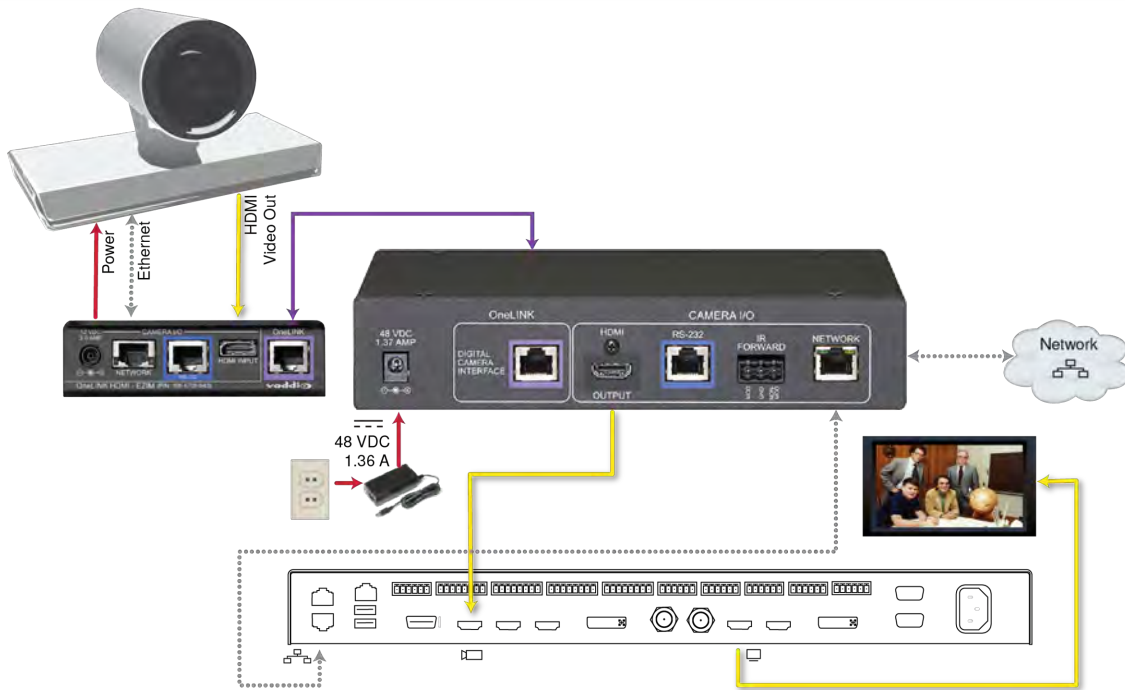

Hardware Note: RS-232 Connections

For RS-232 connections to Cisco gear using DE-9 connectors, use the 998-1002-232 RJ-45 to DE-9 adapter. Its wiring differs from the 998-1001-232 adapter shipped with many Vaddio products.

For RS-232 connections to Cisco gear using the Cisco split cable, use the appropriate null-modem cable to the RJ-45 side of the split cable. Connect the null-modem cable as indicated on the cable labels.

Hardware Note: Connection and Configuration Changes

After connecting or configuring the equipment, reboot the OneLINK device, camera, and codec. Note that rebooting the OneLINK device does not affect the camera and codec; they must be rebooted separately.

Camera Configuration

To use IR forwarding on Cisco cameras with Cisco C-series codecs, go to the camera's admin settings and set IR to Auto.

To use IR forwarding on Cisco cameras with Cisco SX20 and SX80 codecs, go to the camera's admin settings and set IR to On.

Powering Up the Equipment

Power up the connected equipment that is not powered by the OneLINK device (such as displays and third-party control devices), then connect power to the OneLINK device. The connected camera and the OneLINK device power up together.

Configuration and Administration Tasks

The OneLINK HDMI camera extension provides a web interface to allow configuration and administration using a browser.

The web interface allows password-protected access to tasks such as setting passwords, changing the IP address, viewing diagnostics, and installing firmware updates.

Note

The OneLINK device is not a camera control device. To configure or operate the camera, use the camera's web interface. Refer to the camera's documentation for details.

Note

The connected camera is configured separately from the OneLINK device. Changes to the OneLINK device's configuration do not affect the configuration of the camera or other connected equipment. If you need to change the way the camera is configured, log in to the camera's web interface.

Compatible Web Browsers

We have tested this product with these web browsers:

- Chrome®
- Firefox®
- Microsoft® Internet Explorer®
- Safari®

We test using the browser version available from the vendor at that time. Older versions of these browsers are likely to work, and other browsers may also work.

Accessing the Web Interface

To get the IP address:

Ensure that the OneLINK device is connected to the network, or directly to a PC, and read the IP address from the display on the front.

The OneLINK device will use the default address of 169.254.10.1 if no DHCP server is available. In this situation, you will need to connect a computer to the OneLINK device's network port and configure network settings. Depending on the computer, you may need a crossover cable.

To access the web interface:

Enter the IP address or hostname in your browser's address bar. If you use the hostname, you may need to enter `http://` as a prefix to keep the browser from treating it as a search query.

Either a login dialog or the Help page opens. The username `admin` and the default password is `password`.



After you log in, the System page opens.

Note

For best security, Vaddio strongly recommends changing the default password. Using default passwords leaves the product vulnerable to tampering. See [Managing Access and Passwords](#).

Web Interface Cheat Sheet

You must log in as Admin to access the pages for all system administration tasks.

Note

The OneLINK device's web interface does not provide access to the connected camera. To configure the camera, use the camera's web interface, which is at a separate IP address.

What do you need to do?	Go to this page
Find the current firmware version	System
Change the Admin password	Security
Reboot, restore factory defaults, or run firmware updates	System
Add or change information about the room where the equipment is installed, or the phone number for A/V support	Room Labels
Configure time zone or NTP settings	Networking
Specify whether idle sessions close automatically	Security
Configure IP addressing	Networking
View or change the OneLINK device's hostname	Networking
Access contact information for Vaddio technical support	Help
View or download diagnostic logs for technical support	Diagnostics

For your convenience, the navigation panel also provides an elegant Logout button for ending your session gracefully – and leaving the web interface in a password-protected state.

Configuring Network Settings

NETWORKING PAGE

These settings are for the OneLINK device only. The camera is configured separately.

DHCP addressing is the default setting. In a DHCP environment, you will not need to change the network configuration.

The OneLINK device will use the default address of 169.254.10.1 if no DHCP server is available. In this situation, you will need to connect a computer to the OneLINK device's network port and configure network settings. Depending on the computer, you may need a crossover cable.

Caution

Consult your IT department before changing network settings. Errors in network configuration can make the OneLINK device and connected equipment inaccessible from the network. Do not change DHCP/Static addressing, IP address, subnet mask, or gateway unless you are very familiar with the characteristics and configuration of the network where you install the equipment.

To assign a static IP address:

1. Select static IP addressing.
2. Specify the IP address, subnet mask, and gateway address.
3. Save your changes.

Pro Tip

*Make sure you have a way to remember the IP address. **There is no hardware factory reset.***

The screenshot displays the Vaddio OneLINK HDMI web interface. The top header includes the Vaddio logo and the text "Sirius Cybernetics Corporation, Board Room Rm Tel 763-971-4400, Help Tel 800-572-2011". A left sidebar contains navigation links for System, Room Labels, Networking (selected), Security, Diagnostics, Help, and Logout. The main content area is divided into two sections: "DATE & TIME SETTINGS" and "NETWORK CONFIGURATION".

DATE & TIME SETTINGS

- Device System Time: Wed Jan 24 21:23 UTC 2018 (with a Refresh button)
- Automatic NTP Updating: Enabled
- Time Zone: Universal (dropdown menu)
- NTP Server: pool.ntp.org
- Buttons: Cancel, Save

NETWORK CONFIGURATION

Hostname: vaddio-onelink-hdmi-50-65-83-5C-F5-94

NETWORK INTERFACES

Ethernet Port (eth0:WAN)

IP Address: DHCP Static

MAC Address: 50:65:83:5C:F5:94

IP Address: 10.30.20.116

Subnet Mask: 255.255.255.0

Gateway: 10.30.20.1

Buttons: Cancel, Save

Assigning a Hostname

NETWORKING PAGE

The default hostname for the OneLINK HDMI camera extension is the string `vaddio-onelink-hdmi-` followed by the device's MAC address. You can change this in the Hostname field.

If your network supports hostname resolution, you can browse to the OneLINK device by hostname even if you cannot readily determine its IP address. In this situation, you may wish to assign a hostname according to your IT department's naming guidelines.

To edit the hostname:

Enter the desired hostname in the Hostname text box, and save your changes.

Specifying Time Zone and NTP Server

NETWORKING PAGE

To ensure that data exports receive accurate time stamps, and to display the correct date and time on the Networking page, NTP updating must be enabled.

1. Enable Automatic NTP Updating.
2. Select the desired time zone from the list.
3. If desired, specify the NTP server to use. Otherwise, use the default.
4. Select Refresh to update the displayed date and time.

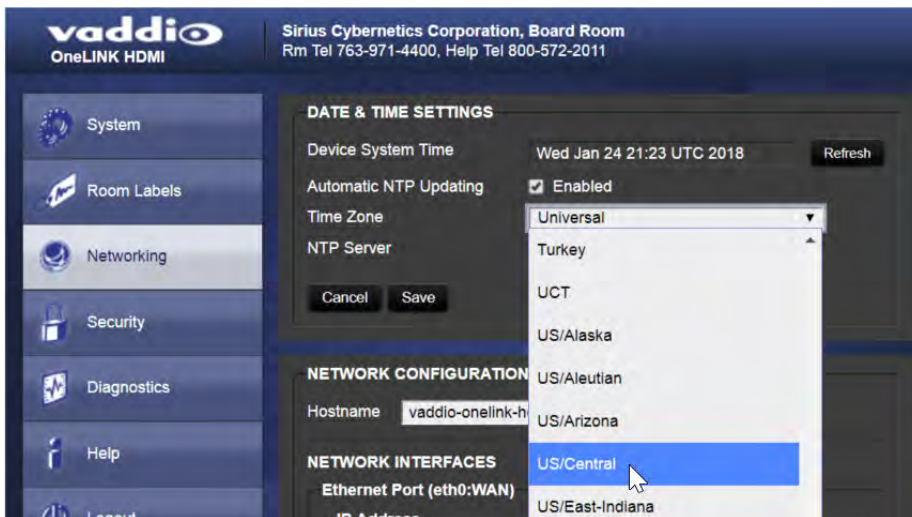

Managing Access and Passwords

SECURITY PAGE

Things you can do on this screen:

- Allow people to view the Help screen without logging on (Allow Guest Access)
- Set whether inactive sessions log off automatically or not
- Change the password for the admin account (default is `password`)
- Change the password for the user account (default is `password`)

Note

For best security, Vaddio strongly recommends changing passwords from the default. Using default passwords leaves the product vulnerable to tampering.

Pro Tip

Make sure you have a way to remember the admin password. **There is no hardware factory reset.**



Adding Room Information to the Web Interface

ROOM LABELS PAGE

On this page, you can provide information about the OneLINK HDMI camera extension's location:

- Name of the organization
- Name of the room where the equipment is installed
- Phone number of the room where the equipment is installed
- Phone number for the AV or IT support team

This information appears on every page of the OneLINK web interface.

Note

This does not affect the room information (if any) presented on the web interface for the attached camera.



Viewing System Information

SYSTEM PAGE

The information on the System page includes the version – so you don't need to guess about whether the latest update has already been installed.

The System page also provides controls to:

- Reboot the OneLINK device
- Back up or restore configuration data
- Restore factory presets
- Update the firmware

The screenshot shows the vaddio OneLINK HDMI web interface. The header includes the vaddio logo and contact information for Sirius Cybernetics Corporation. The main content area is divided into three sections:

- SYSTEM INFORMATION:** Displays System Version (OneLINK HDMI 1.0.1), Commit (9116ca13deff8990088d5ef9fa40903c094da1bb), and HDLink (RX4.6.1*0.04-TX4.6.1*0.03).
- FIRMWARE UPDATE:** Includes a 'Firmware File:' field with a 'Choose File' button and 'No file chosen' text, and a 'Begin Firmware Update...' button.
- SYSTEM UTILITIES:** Contains buttons for 'Reboot...', 'Restore Factory Settings...', 'Export Data', and 'Import Data...'.

A left-hand navigation menu includes links for System, Room Labels, Networking, Security, Diagnostics, Help, and Logout.

Saving (Exporting) or Restoring (Importing) a Configuration

SYSTEM PAGE

You can save a known good configuration by exporting it. This allows you to quickly configure several OneLINK devices the same way, by importing the configuration to all of them. It also gives you a quick way to go back to a known good configuration if you are concerned about planned changes on a specific unit.

The configuration file can only be imported to a OneLINK device using the same version of firmware from which the file was exported. You cannot export a configuration, update the firmware, and import the configuration – but you won't need to. Firmware updates do not change the device configuration.

To export the current configuration:

Select Export Data. The configuration file downloads to your computer's default download location as a .dat file. The filename is the device's hostname.

Note

You can import a configuration file from another OneLINK device; however, the configuration file can only be imported to a device that is using the same version of firmware from which the file was exported. The OneLINK device cannot import a configuration file that was exported from a different version of firmware.

To import a configuration file:

1. Select Import Data. The Import Data dialog opens.
2. Select Choose File, and select the configuration file. The filename is the OneLINK device's hostname, with the file extension .dat. The OneLINK device loads the configuration and reboots.

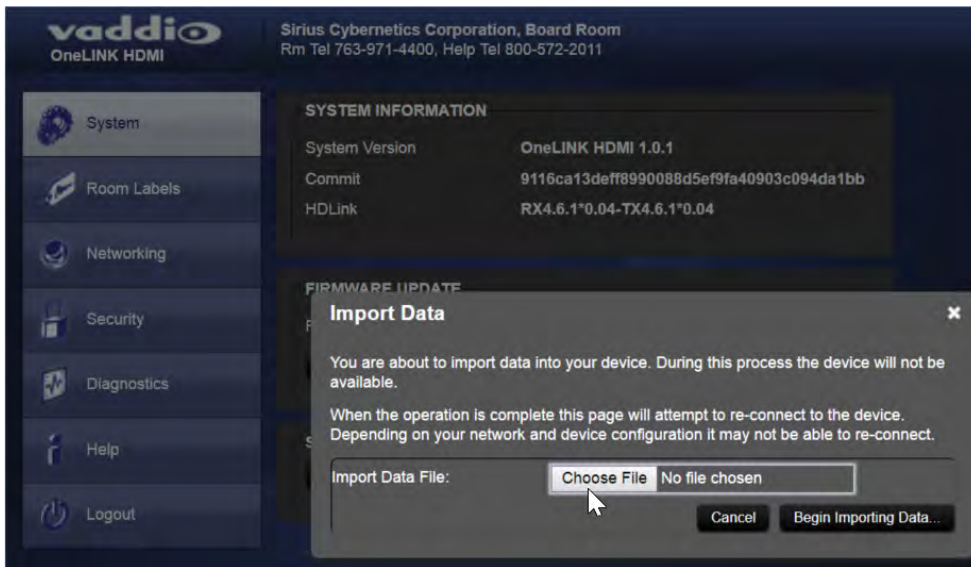

Rebooting the OneLINK Device

SYSTEM PAGE

This may help if the OneLINK device stops responding as you expect. In the System Utilities section of the System page, select Reboot.

Restoring Factory Settings

SYSTEM PAGE

Select Restore Factory Settings to return to the default configuration. Read the confirmation message before you select Continue or Cancel.



Starting a Firmware Update

SYSTEM PAGE

Caution

Do not remove power or disconnect the OneLINK device while a firmware update in progress. Interrupting a firmware update can make the OneLINK device unusable.

1. Be sure you have downloaded the appropriate update file to your computer.
2. Select Choose File, browse to the firmware update file that you downloaded, and select it. The filename ends with .p7m. The System page then displays the filename beside the Choose File button.



3. OPTIONAL: Select Export Data to save a copy of the OneLINK device's current configuration. You probably won't need it, but it could save time if you need to roll back the update.
4. Select Begin Firmware Update.
5. READ the information in the Confirm dialog box and be sure you understand it. It's boring, but it could save you a lot of time and aggravation.

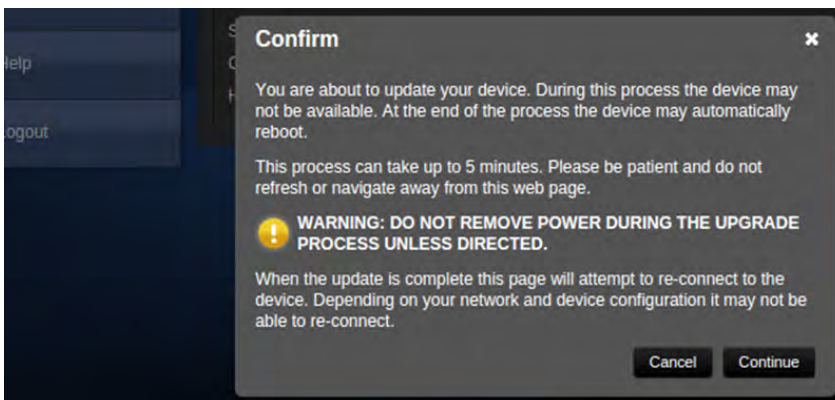

6. When you are ready to start the update, select Continue.
7. If the update process presents warnings or error messages, read them carefully.
8. Contact Vaddio technical support if you encounter any problems with the update.

Contacting Vaddio Technical Support and Viewing Diagnostics

HELP PAGE, DIAGNOSTICS PAGE

If you encounter an issue that you can't resolve using your superior troubleshooting skills (and perhaps the [Troubleshooting](#) section of this guide), go to the Help page. This page provides Vaddio Technical Support contact information.

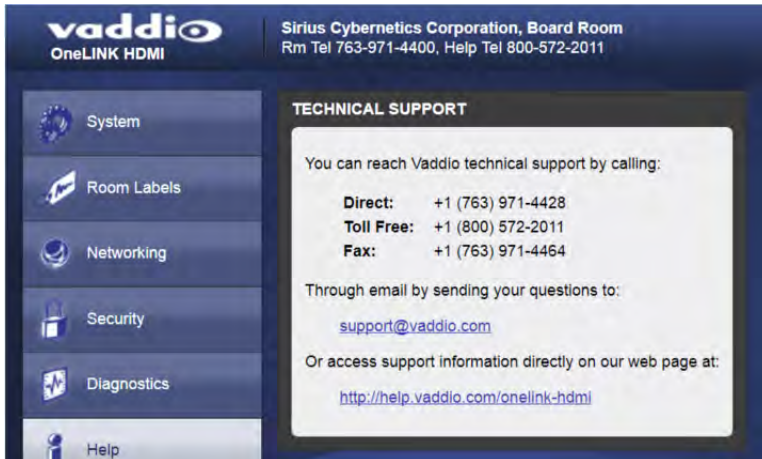

Your Vaddio technical support representative may ask you to download and email the log file available from the Diagnostics page.

The information on this page does not necessarily indicate errors or problems. Most of it is a log of code execution that can be helpful later if technical support or engineering staff need to research an issue.

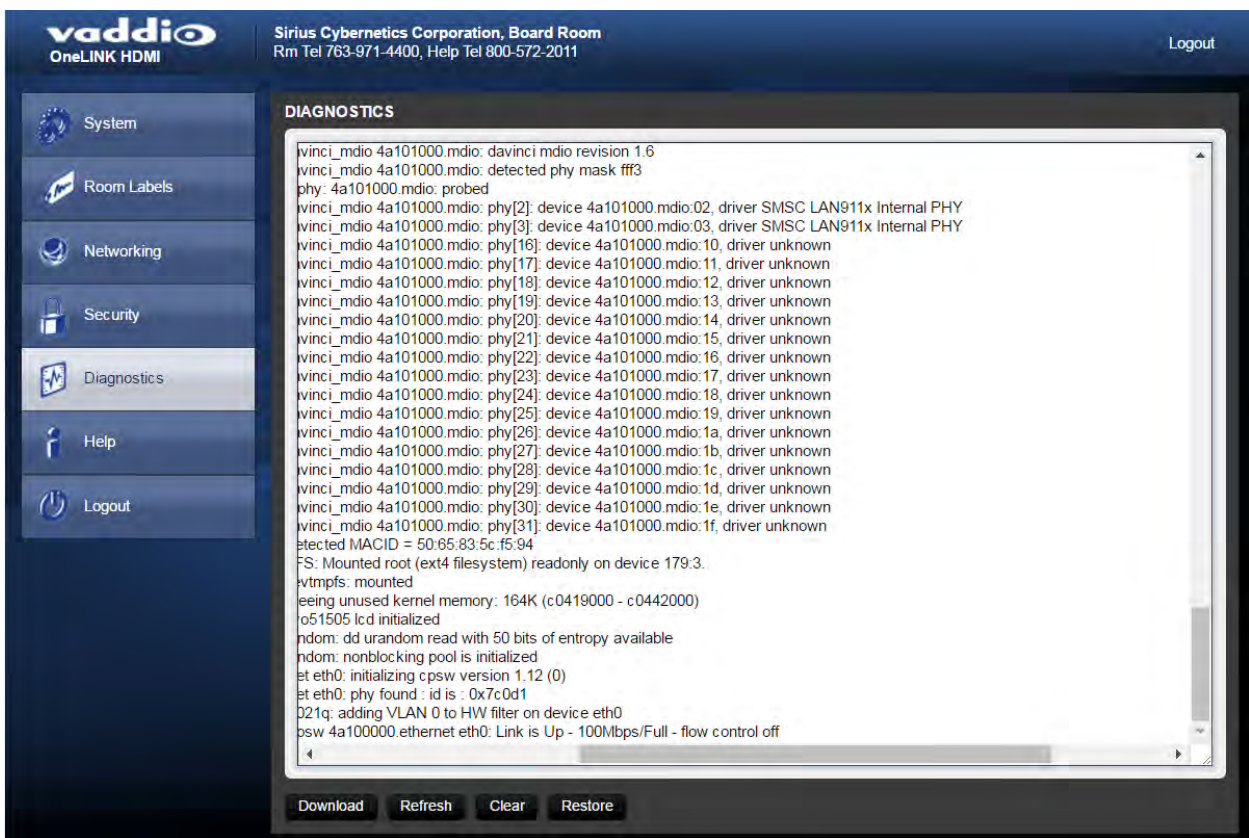

Telnet Serial Command API

The Vaddio Telnet serial command API is a high-level, text-based command line interface to allow an external device such as AMX or Crestron to control the OneLINK device. Use a Telnet client to access the API via the network. The default Telnet port is 23. Telnet sessions require the `admin` account login.

Using a question mark as a command parameter will bring up a list of available commands for the menu you are in.

Things to know about control via Telnet session:

- Command lines are terminated with a carriage return.
- All ASCII characters (including carriage returns) are echoed to the terminal program and appended with the VT100 string ESC[J (hex 1B 5B 4A), which most terminal programs automatically strip.
- CTRL-5 Clears the current serial buffer on the device.

Typographical conventions:

- {x | y | z} – Choose x, y, or z.
- <variable> – Substitute the desired value here.
- < x - y > – Valid range of values is from x through y.
- [parameter] – Parameter is not required.

Note

The commands in this guide refer to the OneLINK device. To control the camera itself, open a Telnet session to the camera's IP address and use the camera's Telnet commands.

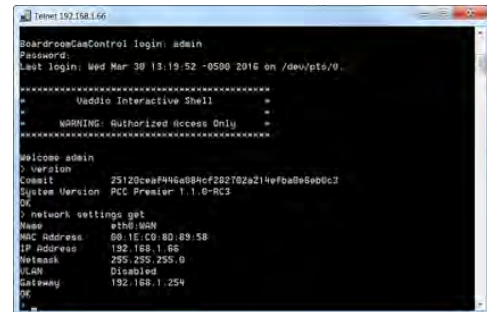

```

Telnet 192.168.1.66
BoardroomCamControl login: admin
Password:
Last login: Wed Mar 30 13:19:52 -0500 2016 on /dev/pts/0
*****
*          Vaddio Interactive Shell          *
*****
*          WARNING: Authorized Access Only          *
*****
Welcome admin
? version
Commit      25120ceaF446a889cf282702a214efba8e580c3
System Version PCC Premier 1.1.0-RC3
OK
? network settings get
Name        eth0:MAN
MAC Address 08:1E:CB:8D:89:5B
IP Address  192.168.1.66
Netmask     255.255.255.0
VLAN        Disabled
Gateway     192.168.1.254
?

```

link power

Sets the camera connection on or off.

Note

The OneLINK device does not provide camera control. To set the camera to standby instead of powering it off, use the camera's remote or other camera control interface to issue a standby command directly to the camera.

Synopsis	link power { on off }	
Options	off	Powers off the camera connection.
	on	Powers on the camera connection.
Examples 	<pre>>link power off OK > Powers off the camera connection.</pre>	

network settings get

Returns the current network settings for MAC address, IP address, subnet mask, and gateway.

Synopsis	network settings get
Example	<pre>> network settings get Name eth0:WAN MAC Address 00:1E:C0:F6:CA:7B IP Address 192.168.1.67 Netmask 255.255.255.0 VLAN Disabled Gateway 192.168.1.254 OK ></pre>

network ping

Sends an ICMP ECHO_REQUEST to the specified IP address or hostname.

Synopsis	network ping [count <count>] [size <size>] <destination-ip>	
Options	<count>	The number of ECHO_REQUEST packets to send. Default is five packets.
	<size>	The size of each ECHO_REQUEST packet. Default is 56 bytes.
	<destination-ip>	The IP address where the ECHO_REQUEST packets will be sent.
Examples	<pre>>network ping 192.168.1.66 PING 192.168.1.66 (192.168.1.66): 56 data bytes 64 bytes from 192.168.1.66: seq=0 ttl=64 time=0.476 ms 64 bytes from 192.168.1.66: seq=1 ttl=64 time=0.416 ms 64 bytes from 192.168.1.66: seq=2 ttl=64 time=0.410 ms 64 bytes from 192.168.1.66: seq=3 ttl=64 time=0.410 ms 64 bytes from 192.168.1.66: seq=4 ttl=64 time=3.112 ms --- 192.168.1.66 ping statistics --- 5 packets transmitted, 5 packets received, 0% packet loss round-trip min/avg/max = 0.410/0.964/3.112 ms ></pre> <p>Sends five ECHO_REQUEST packets of 56 bytes each to the host at 192.168.1.66.</p>	
	<pre>>network ping count 10 size 100 192.168.1.1</pre> <p>Sends 10 ECHO_REQUEST packets of 100 bytes each to the host at 192.168.1.1. The command returns data in the same form as above.</p>	

system reboot

Reboots the system either immediately or after the specified delay. Note that a reboot is required when resetting the system to factory defaults (system factory-reset).

Synopsis	system reboot [<seconds>]	
Options	<seconds>	The number of seconds to delay the reboot.
Examples	<pre>>system reboot OK ></pre> <p>The system is going down for reboot NOW! onelink-hdmi-D8-80-39-62-A7-C5</p> <p>Reboots the system immediately.</p> <pre>>system reboot 30</pre> <p>Reboots the system in 30 seconds. The response appears at the end of the delay.</p>	

system factory-reset

Gets or sets the factory reset status. When the factory reset status is on, the OneLINK device resets to factory defaults on reboot.

Note

This does not reset the camera.

Synopsis	system factory-reset { get on off }	
Options	get	Returns the camera's current factory reset status.
	on	Enables factory reset on reboot.
	off	Disables factory reset on reboot.
Examples	<pre>>system factory-reset get factory-reset (software): off factory-reset (hardware): off OK ></pre> <p>Returns the factory reset status.</p> <p>This evaluates the most recent <code>system factory-reset on</code> or <code>off</code> command, if one has been received, then reads the rear panel DIP switches and returns the status <code>on</code> if they are all in the down position.</p> <pre>>system factory-reset on factory-reset (software): on factory-reset (hardware): off OK ></pre> <p>Enables factory reset upon reboot.</p> <p>Note <i>This command does not initiate a factory reset. The factory reset takes place on the next reboot.</i></p>	

sleep

Pauses for the specified number of milliseconds before evaluating and executing the next command.

Synopsis	sleep <milliseconds>	
Options	<milliseconds>	The number of milliseconds (1 to 10000) to pause.
Example	<pre>>sleep 7000 OK ></pre> <p>Pause for 7 seconds (7000 milliseconds) before returning.</p>	



version

Returns the current firmware version of the OneLINK device.

Synopsis	version
Example	<p>version</p> <p>Returns current firmware version information in a form something like this:</p> <pre>Commit 9116ca13deff8990088d5ef9fa40903c094da1bb HDLink RX4.6.1*0.04-TX4.6.1*0.03 System Version OneLINK HDMI 1.0.1 OK ></pre>

history

Returns the most recently issued commands from the current Telnet session. Since many of the programs read user input a line at a time, the command history is used to keep track of these lines and recall historic information.

Synopsis	history <limit>	
Options	<limit>	Integer value specifying the maximum number of commands to return.
Examples	<p>history</p> <p>Displays the current command buffer.</p> <p>history 5</p> <p>Sets the history command buffer to remember the last 5 unique entries.</p>	
Additional information	<p>You can navigate the command history using the up and down arrow keys. This command supports the expansion functionality from which previous commands can be recalled from within a single session. History expansion is performed immediately after a complete line is read.</p> <p>Examples of history expansion:</p> <ul style="list-style-type: none"> * !! Substitute the last command line. * !4 Substitute the 4th command line (absolute as per 'history' command) * !-3 Substitute the command line entered 3 lines before (relative) 	



help

Displays an overview of the CLI syntax.

Synopsis	help
Example	

exit

Ends the command session and closes the socket.

Synopsis	<code>exit</code>
Example	<code>exit</code>

Specifications

Capabilities

Video output	HDMI 1.4b – matches camera resolution, up to 2160p/29.97	IP Streaming	Passes the stream from the camera, if enabled
Control Features	Web interface for configuration via browser Telnet API for third-party external control Ethernet and RS-232 control pass-through to camera IR forwarding from camera		
Maximum cable length	328 ft (100m) Cat-5e cable; shielded Cat-6 recommended where EMI/RF interference is an issue		

Power, Physical, and Environmental

Input Power	48 VDC, 1.36 A	Output Power to Camera	12 VDC, 3.0 A
Height	1.72 in. (4.4 cm)/1U	Width	8.38 in. (21.3 cm)
Depth	6.0 in. (15.2 cm)	Weight	1.55 lb. (0.7 kg)
Operating/Storage Temperature	32° to 104° F (0° to 40° C)	Operating/Storage Humidity	20% to 80% RH, non-condensing

Troubleshooting

When the Vaddio camera connected to the OneLINK device doesn't behave as you expect, check the color of the camera's indicator light before you do anything else – but keep in mind that the camera's indicator can be turned off in the administrative interface.

- Purple – booting or in standby (low power) mode.
- Blue – normal operation.
- Red – Tally function; the camera is on-air.
- Blinking red – fault condition.
- Yellow – firmware update in progress.

Now check the OneLINK device's web interface for error messages. The EZIM (if one is used) tends to run warm, which is normal. If the system detects that the temperature is too high, a temperature fault message will appear at the top of the web interface page.

If neither of these reveal the problem, use this table to determine whether it's time to call Vaddio Technical Support.

What is it doing?	Possible causes	Check and correct
Nothing. The camera is not receiving power. 	The camera is not connected to the EZIM (if an EZIM is used).	Plug the EZIM into the camera.
	The OneLINK device's power pack is not plugged in to main power, or the EZIM (if one is used) is not connected to the main OneLINK unit.	Plug the power pack into a wall outlet, or connect the EZIM to its OneLINK base unit.
	At least one of the cables is bad.	Replace the bad cable.
	The wall outlet is not active. (Check by finding out if it powers something else, such as a laptop or phone charger.)	Plug the OneLINK power pack into a different outlet.
	"He's dead, Jim."	Contact your reseller or Vaddio Technical Support.
Camera does not finish booting or does not go to the ready state.	Camera firmware may be out of date.	Check the camera's firmware version; update the camera firmware if necessary.
	Possible cable issue.	Test with shorter cables. Try re-terminating the cable.
The camera is on, but its web interface is not available.	A cable is not connected.	Make sure all network and OneLINK cables are connected.
	The network or OneLINK cable is bad.	Replace the bad cable.
	The camera is not using the IP address you browsed to.	Vaddio cameras: Press the Data Screen button on the remote to see the camera's IP address.
No communication with camera	Ethernet or RS-232 cable is connected to the wrong port at one end.	Check the cables from the EZIM or OneLINK device to the camera.
	The wrong cable is connected (standard Cat-5e cable where a custom Cisco cable is needed, or vice-versa) or the	Be sure you are using the right cable. If using a custom Cisco cable, be sure it is connected according to the instructions

What is it doing?	Possible causes	Check and correct
	custom cable is connected the wrong direction.	on its labels.
	The camera is not compatible with the OneLINK device.	Be sure you are using your OneLINK device with a compatible camera.
The camera is on but not transmitting video.	Possible cable length issue.	Check the HDMI output from the camera by connecting a display directly to it. If video is good using a relatively short cable directly to the display, then a better grade of cable (Cat-6 or Cat-7) may correct the problem.
Video drops out repeatedly.	If this happens during PTZ movements, the camera is not getting adequate power.	Check how the camera behaves when it and the attached EZIM are connected to the main interface with a short (6 to 10 ft/ 2 to 3 m) cable. If the camera performs properly, then the problem is the length of the cable from the main interface to the EZIM. A better grade of cable (Cat-6 or Cat-7) may correct the problem.
	Possible cable inductance issue.	Do not store excess cable by coiling it neatly. Best practice: Build cables to the required length.

Operation, Storage, and Care

For smears or smudges on the product, wipe with a clean, soft cloth. Use a lens cleaner on the lens. Do not use any abrasive chemicals.

Keep this device away from food and liquids.

Do not operate or store the device under any of the following conditions:

- Temperatures above 40°C (104°F) or below 0°C (32°F)
- High humidity, condensing or wet environments
- Inclement weather
- Severe vibration
- Lateral acceleration of more than 27G
- Dry environments with an excess of static discharge

Do not attempt to take this product apart. There are no user-serviceable components inside.

Compliance and Declarations of Conformity

Compliance testing was performed to the following regulations:

- FCC Part 15 (15.107, 15.109), Subpart B Class A
- ICES-003, Issue 4: 2004 Class A
- EN 55022 A: 2006 + A1: 2007 Class A
- KN24 2008 (CISPR 24: 1997 + A1: 2000 + A2: 2002) Class A
- KN22 2008 (CISPR 22: 2006) Class A
- EMC Directive 2004/108/EC Class A
- EN 55024: A2: 2003 Class A
- EN 60950-1:2006+A11: 2009+A1: 2010+A12: 2011 Safety

FCC Part 15 Compliance



This equipment has been tested and found to comply with the limits for a Class A digital device, pursuant to Part 15, Subpart B, of the FCC Rules. These limits are designed to provide reasonable protection against harmful interference when the equipment is operated in a commercial environment. This equipment generates, uses, and can radiate radio frequency energy and, if not installed and used in accordance with the instruction manual, may cause harmful interference to radio communications. Operation of this equipment in a residential area is likely to cause harmful interference in which case the user will be required to correct the interference at his/her own expense.

Operation is subject to the following two conditions: (1) This device may not cause interference, and (2) This device must accept any interference including interference that may cause undesired operation of the device.

Changes or modifications not expressly approved by Vaddio can affect emission compliance and could void the user's authority to operate this equipment.

ICES-003 Compliance



This digital apparatus does not exceed the Class A limits for radio noise emissions from digital apparatus set out in the Radio Interference Regulations of the Canadian Department of Communications.

Le présent appareil numérique n'émet pas de bruits radioélectriques dépassant les limites applicables aux appareils numériques de la classe A prescrites dans le Règlement sur le brouillage radioélectrique édicté par le ministère des Communications du Canada.

European Compliance



This product has been evaluated for Electromagnetic Compatibility under the EMC Directive for Emissions and Immunity and meets the requirements for a Class A digital device. In a domestic environment this product may cause radio interference in which case the user may be required to take adequate measures.

Standard(s) To Which Conformity Is Declared:

EMC Directive 2004/108/EC

EN 55022:2010 Conducted and Radiated Emissions

EN 55024: 1998 + Amendments A1: 2001 + A2: 2003 Immunity

- EN 61000-4-2: 1995 + Amendments A1: 1998 + A2: 2001 Electrostatic Discharge
- EN 61000-4-3: 2006 + A1: 2008 Radiated Immunity
- EN 61000-4-4: 2004 + Corrigendum 2006 Electrical Fast Transients
- EN 61000-4-5: 2006 Surge Immunity
- EN 61000-4-6: 2009 Conducted Immunity
- EN 61000-4-8: 2010 Power Frequency Magnetic Field
- EN 61000-4-11: 2004 Voltage Dips, Interrupts and Fluctuations

KN24 2008 (CISPR 24: 1997 + A1: 2000 + A2: 2002) IT Immunity Characteristics

- EN 61000-4-2 Electrostatic Discharge
- EN 61000-4-3 Radiated Immunity
- EN 61000-4-4 Electrical Fast Transients
- EN 61000-4-5 Surge Immunity
- EN 61000-4-6 Conducted Immunity
- EN 61000-4-8 Power Frequency Magnetic Field
- EN 61000-4-11 Voltage Dips, Interrupts and Fluctuations

IEC 60950-1:2005 (2nd Edition); Am 1:2009 Safety

EN 60950-1: 2006+A11: 2009+A1: 2010+A12: 2011 Safety



Warranty Information

See Vaddio Warranty, Service and Return Policies posted on support.vaddio.com for complete details.

Hardware* warranty: Two (2) year limited warranty on all parts and labor for Vaddio manufactured products. Vaddio warrants its manufactured products against defects in materials and workmanship for a period of two years from the day of purchase, to the original purchaser, if Vaddio receives notice of such defects during the warranty. Vaddio, at its option, will repair or replace products that prove to be defective. Vaddio manufactures its hardware products from parts and components that are new or equivalent to new in accordance with industry standard practices.

Exclusions: The above warranty shall not apply to defects resulting from improper or inadequate maintenance by the customer, customers applied software or interfacing, unauthorized modifications or misuse, mishandling, operation outside the normal environmental specifications for the product, use of the incorrect power supply, modified power supply or improper site operation and maintenance. OEM and special order products manufactured by other companies are excluded and are covered by the manufacturer's warranty.

Vaddio Customer Service: Vaddio will test, repair, or replace the product or products without charge if the unit is under warranty. If the product is out of warranty, Vaddio will test then repair the product or products. The cost of parts and labor charge will be estimated by a technician and confirmed by the customer prior to repair. All components must be returned for testing as a complete unit. Vaddio will not accept responsibility for shipment after it has left the premises.

Vaddio Technical Support: Vaddio technicians will determine and discuss with the customer the criteria for repair costs and/or replacement. Vaddio Technical Support can be contacted by email at support@vaddio.com or by phone at one of the phone numbers listed on support.vaddio.com.

Return Material Authorization (RMA) number: Before returning a product for repair or replacement request an RMA from Vaddio's technical support. Provide the technician with a return phone number, e-mail address, shipping address, product serial numbers and original purchase order number. Describe the reason for repairs or returns as well as the date of purchase. See the General RMA Terms and Procedures section for more information. RMAs are valid for 30 days and will be issued to Vaddio dealers only. End users must return products through Vaddio dealers. Include the assigned RMA number in all correspondence with Vaddio. Write the assigned RMA number clearly on the shipping label of the box when returning the product. All products returned for credit are subject to a restocking charge without exception. Special order product are not returnable.

Voided warranty: The warranty does not apply if the original serial number has been removed or if the product has been disassembled or damaged through misuse, accident, modifications, use of incorrect power supply, use of a modified power supply or unauthorized repair.

Shipping and handling: Vaddio will not pay for inbound shipping transportation or insurance charges or accept any responsibility for laws and ordinances from inbound transit. Vaddio will pay for outbound shipping, transportation, and insurance charges for all items under warranty but will not assume responsibility for loss and/or damage by the outbound freight carrier. If the return shipment appears damaged, retain the original boxes and packing material for inspection by the carrier. Contact your carrier immediately.

Products not under warranty: Payment arrangements are required before outbound shipment for all out of warranty products.

Index

A

- admin login 47, 51
- anatomy of the EZCamera Interface Module 9
- anatomy of the OneLINK device 7-8
- API 58, 62
 - syntax help 62
- automatic inactivity time-out (web session) 51
- automatic NTP updating 50

B

- backing up a configuration 53
- browser compatibility 46

C

- cable connectors 8-10
- cables 2, 10, 17-18, 20, 26, 32, 35, 39, 45, 64
 - Cisco split 18, 26, 39, 45
 - maximum length 2, 10, 64
 - null-modem 20, 26, 39, 45
 - Polycom fan-out, codec, terminating 17, 35
 - Polycom fan-out, codec, terminating | Models.All OneLINK HDMI | Models.All OneLINK HDMI [54] 32
- capabilities 2
- cheat sheet, web interface 48
- cleaning 66
- Codec Control Mode (Vaddio cameras) 17, 21, 32, 40
- command execution delay 61
- command history 62
- compatibility, browsers 46
- configuration, saving or restoring 53
- configuring 13, 17, 21, 23, 32, 40, 45
 - connected RoboSHOT HDMI camera 23, 32, 40
 - connected Vaddio HDBaseT camera 13, 17, 21
 - IR forwarding on Cisco cameras 45
- connection diagram 12-16, 18-20, 22-31, 33-34, 36-39, 41-45
 - block, HDBaseT camera 12
 - block, HDBaseT camera with codec 14
 - block, HDMI camera 22
 - block, HDMI camera with codec 29
 - Cisco Precision 40 25

- Cisco Precision 40 with Cisco C20 41
- Cisco Precision 40 with Cisco C40 42
- Cisco Precision 40 with Cisco C60 42
- Cisco Precision 40 with Cisco SX20 43
- Cisco Precision 40 with Cisco SX80 44
- Cisco Precision 60 26
- Cisco Precision 60 with Cisco SX80 45
- Cisco Precision HD 25
- Cisco Precision HD with Cisco C20 41
- Cisco Precision HD with Cisco C40 42
- Cisco Precision HD with Cisco C60 42
- Cisco Precision HD with Cisco SX20 43
- Cisco Precision HD with Cisco SX80 44
- Panasonic AW-HE130 27
- Polycom EagleEye IV 24
- Polycom EagleEye IV with Polycom RPG 310 33
- Polycom EagleEye IV with Polycom RPG 500 33
- Polycom EagleEye IV with Polycom RPG 700 34
- RoboSHOT HDMI 23
- RoboSHOT HDMI with Cisco C20 36
- RoboSHOT HDMI with Cisco C40 37
- RoboSHOT HDMI with Cisco C60 37
- RoboSHOT HDMI with Cisco SX20 38
- RoboSHOT HDMI with Cisco SX80 39
- RoboSHOT HDMI with Polycom RPG 310 30
- RoboSHOT HDMI with Polycom RPG 500 30
- RoboSHOT HDMI with Polycom RPG 700 31
- Sony SRG120 28
- Sony SRG300 28
- Vaddio HDBaseT 13
- Vaddio HDBaseT with Cisco C20 18
- Vaddio HDBaseT with Cisco C40 19
- Vaddio HDBaseT with Cisco C60 19
- Vaddio HDBaseT with Cisco SX20 19
- Vaddio HDBaseT with Cisco SX80 20
- Vaddio HDBaseT with Polycom RPG 310 15
- Vaddio HDBaseT with Polycom RPG 500 15
- Vaddio HDBaseT with Polycom RPG 700 16
- visual conventions 12
- connectors 8-11
 - identification 8-9

- pin-out, IR forwarding 11
- pin-outs, RS-232 11
- customer-provided items 13, 15, 18, 23-25, 27, 30, 33, 36, 41
- cycle power to the camera 59

D

- damage, preventing 10
- date and time 50
- default password 47
- default settings, restoring 55, 61
- DHCP 49
- Diagnostics page (web) 57

E

- equipment location information 52

F

- factory defaults, restoring 55, 61
- fault isolation 65
- firmware update 56
- firmware version 62
- front panel display 7

G

- getting help 57
- guest access, allowing 51

H

- hardware reset 7
- hardware specifications 64
- Help page (web) 57
- hostname, assigning 50

I

- importing a configuration 53
- inactive sessions (web interface) 51
- indicator lights 65
- information, equipment location 52
- installation 11
 - mounting 11
- IP address 47, 49
 - default 49
- IP address display 7
- IR forwarding 11, 17, 32, 35, 45
 - connector pin-out 11
- items you will need 13, 15, 18, 23-25, 27, 30, 33, 36, 41

K

- key for connection diagrams 12
- kits 1, 3-6, 12-15, 18, 22-25, 27, 29-30, 33, 36, 41
 - for Cisco cameras 6, 25
 - for Cisco cameras with Cisco codecs 6, 22, 29, 41
 - for Panasonic cameras 4, 22, 27
 - for Polycom cameras 5, 24
 - for Polycom cameras with Polycom codecs 5, 22, 29, 33
 - for RoboSHOT HDMI cameras 4, 22-23
 - for RoboSHOT HDMI cameras with Cisco codecs 6, 29, 36
 - for RoboSHOT HDMI cameras with Polycom codecs 29-30
 - for RoboSHOT HDMI cameras with Polycom Codecs 5
 - for Sony cameras 4, 22, 27
 - for Vaddio HDBaseT cameras 3, 12-13
 - for Vaddio HDBaseT cameras with Cisco codecs 4, 14, 18
 - for Vaddio HDBaseT cameras with Polycom codecs 3, 14-15

L

- line types in diagrams 12
- locations of connectors 8-9

M

- MAC address display 7

N

- network configuration 49
 - changing 49
 - default 49
- network configuration information (Telnet) 59
- Networking page (web) 49-50
- NTP server 50

O

- operating environment 66

P

- packing lists 3-6
 - 999-1105-043/143/943 3
 - 999-9520-000/001/009 5
 - 999-9530-000/001/009 4
 - 999-9540-000/001/009 5

- 999-9545-000/001/009 3
- 999-9560-000/001/009 6
- 999-9570-000/001/009 6
- 999-9575-000/001/009 4
- 999-9590-000/001/009 4
- page 49-53, 55-57
 - Diagnostics 57
 - Help 57
 - Networking 49-50
 - Room Labels 52
 - Security 51
 - System 53, 55-56
- passwords 47, 51
 - changing 51
 - default 47
- performance specifications 64
- physical and environmental specifications 64
- pin-outs 11
 - for IR forwarding connector 11
 - for RS-232 connectors 11
- ping command 60
- Polycom fan-out cable, codec, terminating 17
- power on/power off 46, 59
 - camera 59
- problems, solving 65
- product capabilities 2
- product returns and repairs 69
- product SKUs 1, 3-6

Q

- quick reference, web interface 48

R

- rebooting 54, 60
- regulatory information 67
- reset button location 7
- restoring a configuration 53
- restoring default settings 55, 61
- RJ-45 connectors, recommendation 10
- room information, adding 52
- Room Labels page (web) 52
- RS-232 adapter for Cisco products 20, 39, 45
- RS-232 connector pin-out 11

S

- saving a configuration 53
- Security page (web) 51
- settings, default, restoring 55, 61
- software update 56

- solving problems 65
- specifications 64
- static IP address 49
- storage environment 66
- storing a configuration 53
- supported web browsers 46
- System page (web interface) 53, 55
- System page (web) 56
- system time 50

T

- technical support 57
- Telnet command help 62
- Telnet session 58, 62-63
 - ending 63
 - history 62
- temperature, operating and storage 66
- time zone 50
- troubleshooting 65
- typographical conventions for command reference 58

U

- updating firmware 56
- user login 51
 - changing 51

V

- version, firmware 62

W

- warranty 10, 69
- web browsers supported 46
- web interface 48-53, 55-57
 - cheat sheet 48
 - Diagnostics page 57
 - Help page 57
 - Networking page 49-50
 - Room Labels page 52
 - Security page 51
 - System page 53, 55-56

Vaddio is a brand of Milestone AV Technologies · www.vaddio.com · Phone 800.572.2011 / +1.763.971.4400 · Fax +1.763.971.4464 · Email info@vaddio.com

Visit us at support.vaddio.com for firmware updates, specifications, drawings, manuals, and technical support information. Vaddio, OneLINK, and RoboSHOT are trademarks or registered trademarks of Milestone AV Technologies. The terms HDMI and HDMI High-Definition Multimedia Interface, and the HDMI logo, are trademarks or registered trademarks of HDMI Licensing LLC in the United States and other countries. HDBaseT™ and the HDBaseT Alliance logo are trademarks of the HDBaseT Alliance. Exmor® is a trademark of Sony Corporation. All other brand names or marks are used for identification purposes and are trademarks of their respective owners. In British Columbia, Milestone AV Technologies ULC carries on business as MAVT Milestone AV Technologies ULC.

©2018 Milestone AV Technologies

The logo for Vaddio, featuring the word "vaddio" in a bold, blue, lowercase sans-serif font. The final letter "o" is stylized as a circle with a smaller solid blue circle inside it, and a registered trademark symbol (®) is positioned to the upper right of the circle.