



ZenScreen Touch MB16AMT

Portable Touch Monitor

User Guide

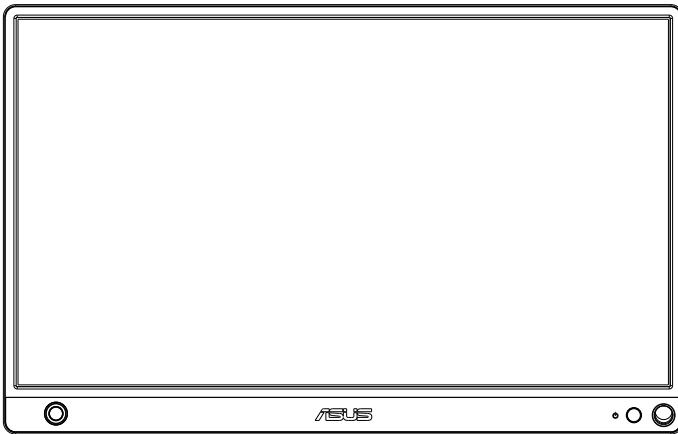

Table of contents

Notices.....	iii
Safety information	iv
Care & cleaning.....	v
Takeback services	vi
Caution	vi
1.1 Welcome!	1-1
1.2 Package contents.....	1-1
1.3 Monitor introduction	1-2
1.3.1 Front View and Charging Instructions.....	1-2
1.3.2 QuickFit Function	1-4
2.1 Monitor standing positions	2-1
2.2 Connect the USB monitor with system.....	2-2
2.3 Announcements	2-4
2.4 Touch Operation	2-5
3.1 OSD (On-Screen Display) menu	3-1
3.1.1 How to reconfigure.....	3-1
3.1.2 OSD Function Introduction.....	3-2
3.2 Specifications.....	3-10
3.3 Troubleshooting (FAQ).....	3-11
3.4 Supported Timing List.....	3-13

Copyright © 2019 ASUSTeK COMPUTER INC. All Rights Reserved.

No part of this manual, including the products and software described in it, may be reproduced, transmitted, transcribed, stored in a retrieval system, or translated into any language in any form or by any means, except documentation kept by the purchaser for backup purposes, without the express written permission of ASUSTeK COMPUTER INC. (“ASUS”).

Product warranty or service will not be extended if: (1) the product is repaired, modified or altered, unless such repair, modification or alteration is authorized in writing by ASUS; or (2) the serial number of the product is defaced or missing.

ASUS PROVIDES THIS MANUAL “AS IS” WITHOUT WARRANTY OF ANY KIND, EITHER EXPRESS OR IMPLIED, INCLUDING BUT NOT LIMITED TO THE IMPLIED WARRANTIES OR CONDITIONS OF MERCHANTABILITY OR FITNESS FOR A PARTICULAR PURPOSE. IN NO EVENT SHALL ASUS, ITS DIRECTORS, OFFICERS, EMPLOYEES OR AGENTS BE LIABLE FOR ANY INDIRECT, SPECIAL, INCIDENTAL, OR CONSEQUENTIAL DAMAGES (INCLUDING DAMAGES FOR LOSS OF PROFITS, LOSS OF BUSINESS, LOSS OF USE OR DATA, INTERRUPTION OF BUSINESS AND THE LIKE), EVEN IF ASUS HAS BEEN ADVISED OF THE POSSIBILITY OF SUCH DAMAGES ARISING FROM ANY DEFECT OR ERROR IN THIS MANUAL OR PRODUCT.

SPECIFICATIONS AND INFORMATION CONTAINED IN THIS MANUAL ARE FURNISHED FOR INFORMATIONAL USE ONLY, AND ARE SUBJECT TO CHANGE AT ANY TIME WITHOUT NOTICE, AND SHOULD NOT BE CONSTRUED AS A COMMITMENT BY ASUS. ASUS ASSUMES NO RESPONSIBILITY OR LIABILITY FOR ANY ERRORS OR INACCURACIES THAT MAY APPEAR IN THIS MANUAL, INCLUDING THE PRODUCTS AND SOFTWARE DESCRIBED IN IT.

Products and corporate names appearing in this manual may or may not be registered trademarks or copyrights of their respective companies, and are used only for identification or explanation and to the owners’ benefit, without intent to infringe.

Notices

Federal Communications Commission Statement

This device complies with Part 15 of the FCC Rules. Operation is subject to the following two conditions:

- This device may not cause harmful interference, and
- This device must accept any interference received including interference that may cause undesired operation.

This equipment has been tested and found to comply with the limits for a Class B digital device, pursuant to Part 15 of the FCC Rules. These limits are designed to provide reasonable protection against harmful interference in a residential installation. This equipment generates, uses and can radiate radio frequency energy and, if not installed and used in accordance with the instructions, may cause harmful interference to radio communications. However, there is no guarantee that interference will not occur in a particular installation. If this equipment does cause harmful interference to radio or television reception, which can be determined by turning the equipment off and on, the user is encouraged to try to correct the interference by one or more of the following measures:

- Reorient or relocate the receiving antenna.
- Increase the separation between the equipment and receiver.
- Connect the equipment to an outlet on a circuit different from that to which the receiver is connected.
- Consult the dealer or an experienced radio/TV technician for help.

Canadian Department of Communications Statement

This digital apparatus does not exceed the Class B limits for radio noise emissions from digital apparatus set out in the Radio Interference Regulations of the Canadian Department of Communications.

This class B digital apparatus complies with Canadian ICES-003.



Safety information

- Before setting up this Portable Touch Monitor, carefully read all the documentation that came with the package.
- To prevent fire or shock hazard, never expose this Portable Touch Monitor to rain or moisture.
- Never try to open this Portable Touch Monitor cabinet.
- Before using this Portable Touch Monitor, make sure all cables are correctly connected and the power cables are not damaged. If you detect any damage, contact your dealer immediately.
- Avoid dust, humidity, and temperature extremes. Do not place this Portable Touch Monitor in any area where it may become wet. Place this Portable Touch Monitor on a stable surface.
- Never push objects or spill liquid of any kind into the slots on this Portable Touch Monitor cabinet.
- If you encounter technical problems with this Portable Touch Monitor, contact a qualified service technician or your retailer.
- This Portable Touch Monitor is powered by USB port which complies with LPS and SELV circuit according to IEC60950-1:2005.
- DO NOT dispose of the product in fire
- DO NOT use monitor near heating equipment or in places where there is likelihood of high temperature
- Keep your monitor away from sharp objects
- DO NOT place objects on top of your monitor

Care & cleaning

- Cleaning. Turn your monitor off and unplug the cable. Clean the monitor surface with a lint-free, non-abrasive cloth. Stubborn stains may be removed with a cloth dampened with mild cleaner.
- Avoid using a cleaner containing alcohol or acetone. Use a cleaner intended for use with the LCD. Never spray cleaner directly on the screen, as it may drip inside the monitor and cause an electric shock.

The following symptoms are normal with the monitor:

- You may find slightly uneven brightness on the screen depending on the desktop pattern you use.
- When the same image is displayed for hours, an afterimage of the previous screen may remain after switching the image. The screen will recover slowly or you can turn off the Power Switch for hours.
- When the screen becomes black or flashes, or cannot work anymore, contact your dealer or service center to fix it. Do not repair the screen by yourself!

Conventions used in this guide



WARNING: Information to prevent injury to yourself when trying to complete a task.



CAUTION: Information to prevent damage to the components when trying to complete a task.



IMPORTANT: Information that you **MUST** follow to complete a task.



NOTE: Tips and additional information to aid in completing a task.

Where to find more information

Refer to the following sources for additional information and for product and software updates.

1. **ASUS websites**

The ASUS websites worldwide provide updated information on ASUS hardware and software products. Refer to <http://www.asus.com>

2. **Optional documentation**

Your product package may include optional documentation that may have been added by your dealer. These documents are not part of the standard package.

Takeback services

ASUS recycling and takeback programs come from our commitment to the highest standards for protecting our environment. We believe in providing solutions for our customers to be able to responsibly recycle our products, batteries and other components as well as the packaging materials.

Please go to <http://csr.asus.com/english/Takeback.htm> for detail recycling information in different region.

Caution

We suggest to use the attached pen or any pen or stick that can fit in the hole at the corner as a simple stand for the monitor.

Please reserve at least 10cm/4 inch of the pen at the back of the monitor to stabilize.

Please be noted the pen attached is not a stylus pen.

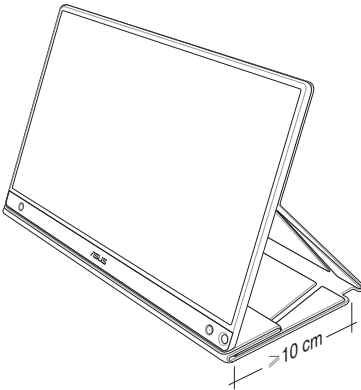

1.1 Welcome!

Thank you for purchasing the ASUS® Portable Touch Monitor!

The latest ASUS Portable Touch Monitor provides great portability and simplicity to your daily life, enhancing both of your viewing experience and style.

1.2 Package contents

Check your package for the following items:

- ✓ Portable Touch Monitor
- ✓ Quick Start Guide
- ✓ Warranty Card
- ✓ USB Type-C Cable
- ✓ Smart Cover
- ✓ USB Type-C to A Adapter
- ✓ Micro HDMI to HDMI cable
- ✓ Touch Pen
- ✓ Power Adapter



-
- If any of the above items is damaged or missing, contact your retailer immediately.
 - Inbox pen is not included in the warranty.
-

1.3 Monitor introduction

1.3.1 Front View and Charging Instructions

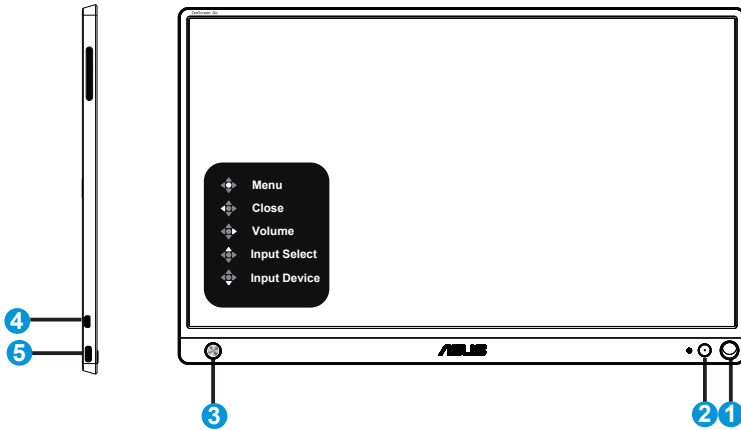

1. Pen hole
 - Use the attached pen to insert into the hole, the monitor can stand up directly without the smart cover.
2. Power button/Power LED
 - Press this button to turn the monitor on/off when connected to a valid source.
 - The color definition of the power indicator is as the below table.

Status	Description
Blue	ON/Standby mode
Dark	OFF
Red	Charging Mode
Green	Finished charging

3. 5 way key
 - Press the Central button to enter OSD when in connection to a valid source.
 - Long pressing the Central button allows you to have a quick check on battery % even the device is OFF.

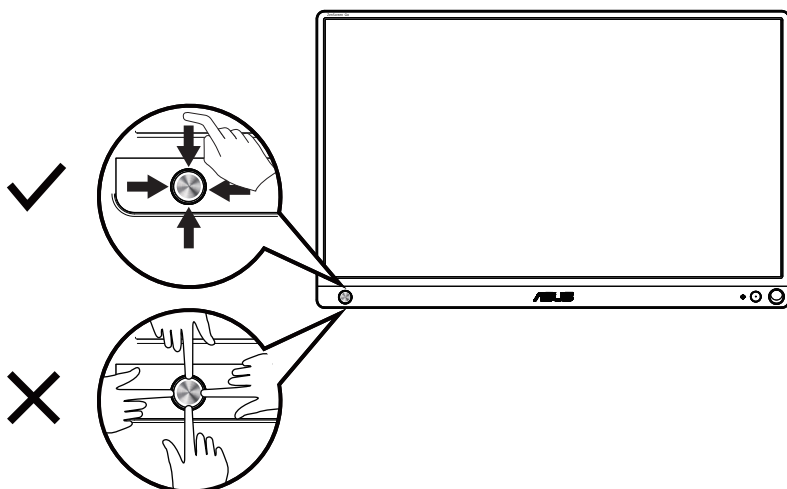

4. Micro-HDMI port

- Connect your computer with Micro-HDMI cable.

5. USB Type-C port

- Used to connect to a valid source such as PC or mobile phone for monitor to work when there's enough power
- Used to do battery charging when the monitor is in OFF mode
- Up to 9V@2A 18W power supply, signal input supported, maximum resolution 1920 x 1080@60Hz



IMPORTANT:

- Charge the monitor for 4 hours before using it for the first time
- Use only bundled power adapter and USB cable to charge your monitor. Using different power adapter and cable might bring potential damage to your device.



WARNING: The adapter may become warm to hot while in use. DO NOT cover the adapter and keep it away from your body while it is connected to a power source. If your device become unusual hot, disconnect the USB cable from your device and send the device including the power adapter and USB cable to an ASUS qualified service personnel

1.3.2 QuickFit Function

The QuickFit function contains two patterns: (1) Grid (2) Photo size.

1. Grid pattern: Facilitates designers and users to organize content and layout on one page and achieve a consistent look and feel.

Alignment grid 1 will be rotated automatically if auto rotation is enabled.

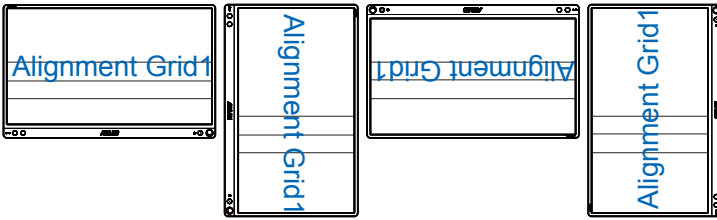

- Auto rotation function is only working under Windows OS by installing DisplayWidget software.



2. Photo size: Provides photographers and other users to accurately view and edit their photos in real size on the screen.

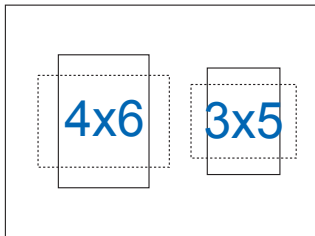

2.1 Monitor standing positions

You can stand up the monitor by several positions with the smart cover.

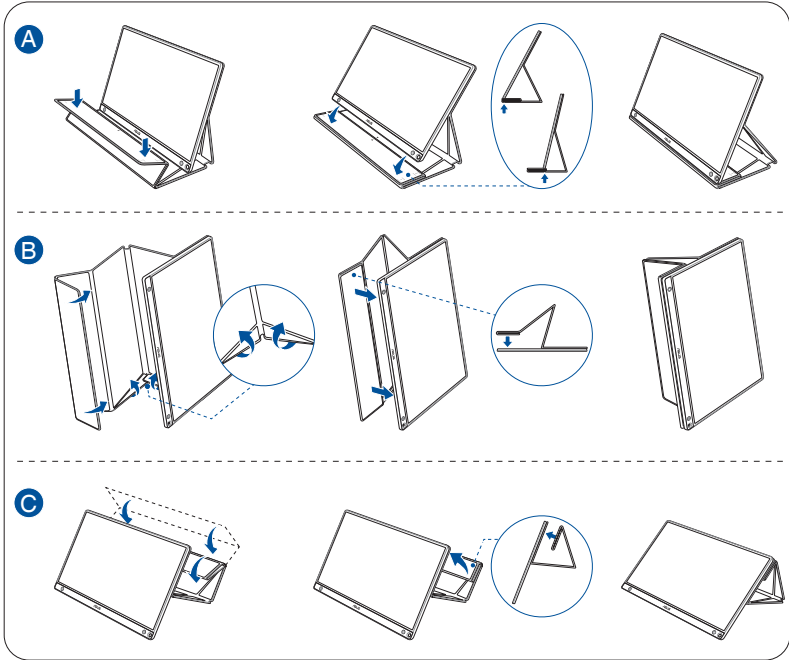

2.2 Connect the USB monitor with system

A

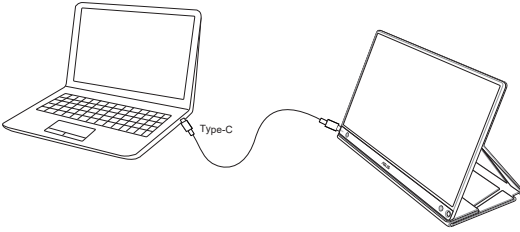

B

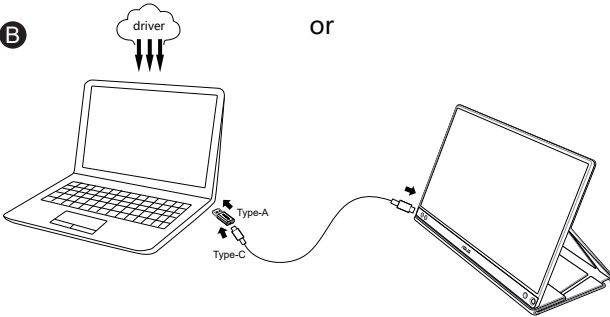

C

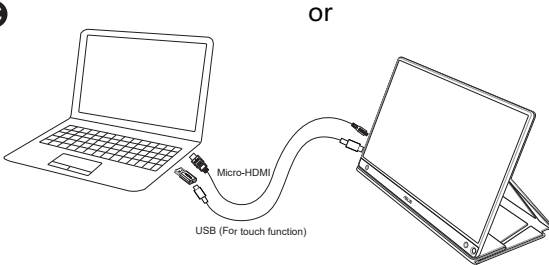

D

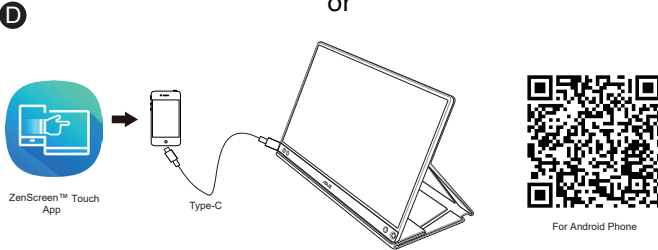

Before connecting with your Android phone, please download “ZenScreen Touch” app on Google Play Store or ASUS website. This app helps perfectly match multi-touch points between ZenScreen™ Touch monitor and Android phones. While launching it, it’s able to use and control phone apps directly on MB16AMT.



-
- MB16AMT touch feature is only available if your Android phone offers/ supports HID multi-touch. Please confirm with your phone manufacturer to be sure its function availability.
-

In case the computer does not support Type-C interface but only USB3.0 interface, please install the official driver from ASUS website firstly.

Please make sure the USB Type-C cable and Type-C to A adapter is connected between the USB monitor and the system.



-
- Please check ASUS website for latest driver and DisplayWidget software.
-

2.3 Announcements

As this product and attached smart cover includes magnet in the structure, there could be potential risk to cause the damage of computer hard disc and objects that are sensitive to magnet.

Please ensure not to stack the product with the computer when computer is in use (power on or standby mode) otherwise the hard drive could possibly be influenced by the result of permanent data missing or the computer display could be switched off due to computer auto protection mechanism. When place this product together with computer in the bag, must have the computer power off to avoid possible hard drive damage problem.(Check Picture A)

The battery capacity will vary depending on the environment temperature, humidity, and monitor usage

The battery used in this device may present a risk of fire or chemical burn if removed or disassembled

Risk of explosion if the battery is placed by an incorrect type

Never attempt to short-circuit your monitor battery

Never attempt to disassemble and reassemble the monitor battery

Discontinue usage if leakage is found

The battery and its components must be recycled or disposed of properly

Keep the battery and other small components away from children

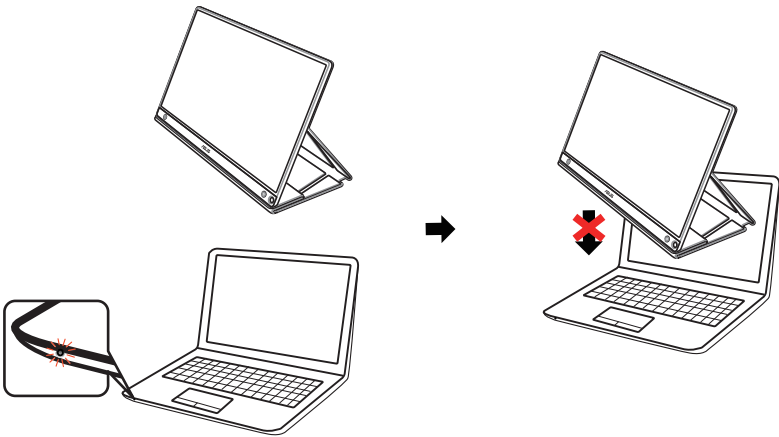

Picture A

2.4 Touch Operation

- ASUS MB16AMT is a touch monitor which uses 10 point touch panel technology. Please use with latest OS like Windows 10.
- You can use either single finger touch, or multi-finger touch up to maximum simultaneous 10 touch points.

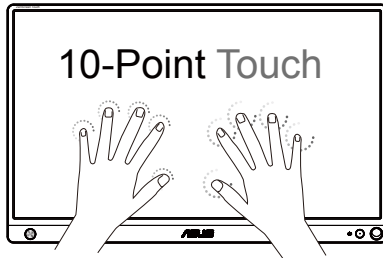

- To activate touch functionality, you need to connect the display with the USB Type-C cable to your computer.
- You do not need to install any other touch driver.
- ASUS MB16AMT offers you groovy touch gestures like tap, grab, pinch, rotate, zoom, swipe, etc. The gestures allow you to launch programs and access the setting of your ASUS MB16AMT Display. The functions can be activated by using the hand gestures to ASUS MB16AMT.

Left edge swipe (on Windows 7/8/8.1/10 only)

Swipe from the left edge of the screen to shuffle your running apps.

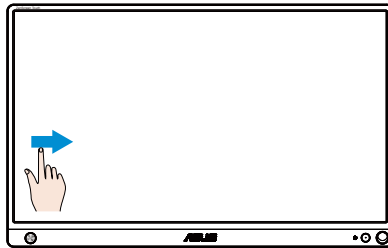

Right edge swipe (on Windows 7/8/8.1/10 only)

Swipe from the right edge of the screen to launch the Charm bar.

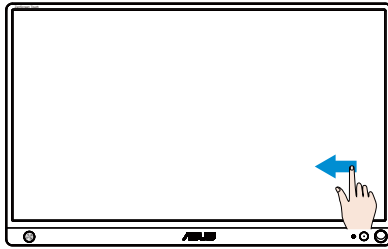

Finger slide (on Windows 7/8/8.1/10 only)

Slide your finger to scroll up and down and slide your finger to pan the screen left or right.

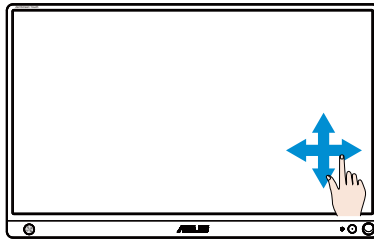

Zoom out

Bring together your two fingers on the touch panel.

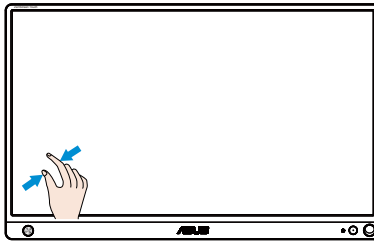

Zoom in

Spread apart your two fingers on the touch panel.

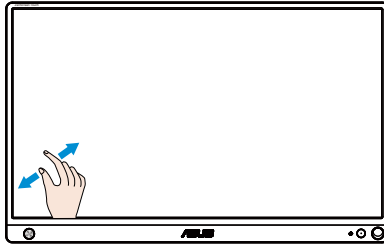

Single Tap/Double tap

Single Tap

Touch the target on the screen with one fingertip for one quick tap, then release.

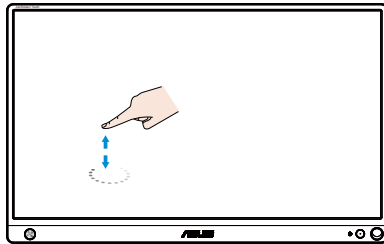

Double Tap

Touch the target on the screen with one fingertip for two quick taps, then release.

Tap an app to launch it (on Windows 7/8/8.1/10 only).

Double-tap an item to launch it.

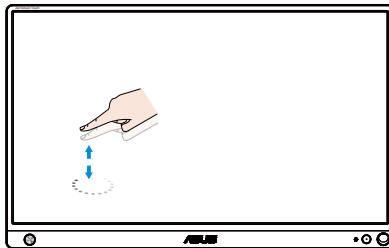

Tap and hold

To move an app, tap and hold the app tile and drag it to a new location. To close an app (on Windows 7/8/8.1/10 only), tap and hold the top side of the running app and drag it down to the bottom of the screen to close it.

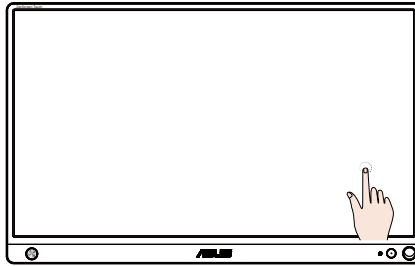

NOTE:

- You can access to OS website to get more description on touch operation.
- Do not touch the screen with sharp objects, it may result in damage, and void warranty.
- Do not push hard, or rest anything on the glass surface (if in horizontal position) as it will damage the screen and void warranty.
- Please keep your hands clean and dry before touching the screen to ensure fluid touch operation.
- The touch function works only on OS and applications which support touch functions.

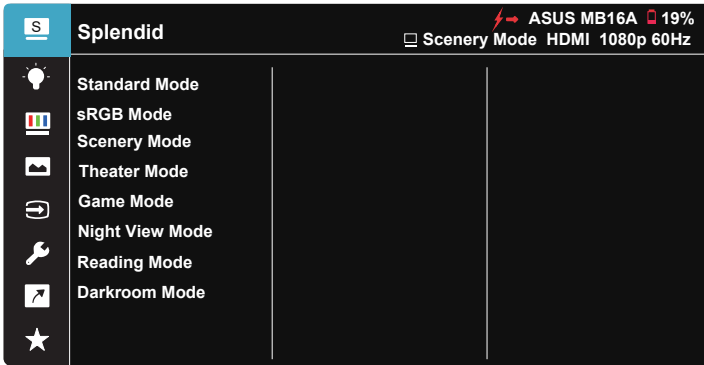

3.1 OSD (On-Screen Display) menu

3.1.1 How to reconfigure



1. Press the Central of 5-way button to display the OSD menu.
2. Move the Up and Down keys to switch the options in the menu. When you move from one icon to another, the option name is highlighted.
3. To select a highlighted item from the menu, move the Right key or the Central button.
4. Move the Up and Down keys to select the desired parameters.
5. Move the Right key or the Central button to enter the slide bar, and then use the Up or Down keys (depending on the indicators in the menu) to make changes.
6. Move the Left key to return to the previous menu.



-
-  : Get power from source when this icon is shown
 -  : Battery power
 -  : Battery is being charged
-

3.1.2 OSD Function Introduction

1. Splendid

This function contains eight sub-functions that you can select for your preference.

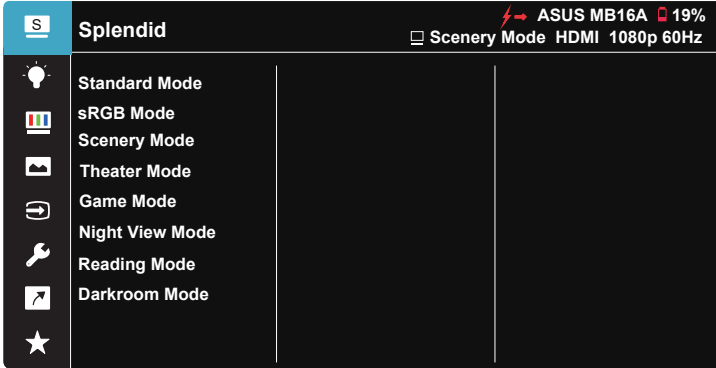

- **Standard Mode:** This is the best choice for document editing with SPLENDID™ Video Intelligence Technology.
- **sRGB Mode:** This is the best choice for viewing photos and graphics from PCs.
- **Scenery Mode:** This is the best choice for scenery photo displaying with SPLENDID™ Video Intelligence Technology.
- **Theater Mode:** This is the best choice for movie watching with SPLENDID™ Video Intelligence Technology.
- **Game Mode:** This is the best choice for game playing with SPLENDID™ Video Intelligence Technology.
- **Night View Mode:** This is the best choice for playing dark-scene game or watching dark-scene movie with SPLENDID™ Video Intelligence Technology.
- **Reading Mode :** This is the best choice for book reading.
- **Darkroom Mode :** This is the best choice for a weak ambient light environmen.



-
- In the Standard Mode, the Saturation, SkinTone, Sharpness, and ASCR functions are not user-configurable.
 - In the sRGB, the Saturation, Color Temp., SkinTone, Sharpness, Brightness, Contrast and ASCR functions are not user-configurable.
 - In the Reading Mode, the Saturation, SkinTone, Sharpness, ASCR, contrast, and Color Temp functions are not user-configurable.
-

2. Blue Light Filter

Adjust the energy level of blue light emitted from LED backlight.

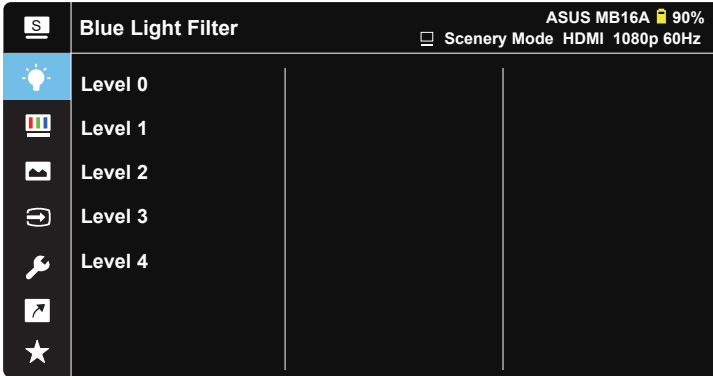

- **Level 0:** No change.
- **Level 1~4:** The higher the level, the more blue light will be reduced.



- When Blue Light Filter is activated, the default settings of Standard Mode will be automatically imported.
- Between Level 1 to Level 3, the Brightness function is user-configurable.
- Level 4 is optimized setting. It is compliance with TUV Low Blue Light Certification. The Brightness function is not user-configurable.



Please refer to the following to alleviate eye strains:

- Users should take some time away from the display if working for long hours. It is advised to take short breaks (at least 5 mins) after around 1 hour of continuous working at the computer. Taking short and frequent breaks is more effective than a single longer break.
- To minimize eye strain and dryness in your eyes, users should rest the eye periodically by focusing on objects that are far away.
- Eye exercises can help to reduce eye strain. Repeat these exercises often. If eye strain continues please consult a physician. Eye exercises: (1) Repeating look up and down (2) Slowly roll your eyes (3) Move your eyes diagonal.
- High energy blue light may lead to eye strain and AMD (Age-Related Macular Degeneration). Blue light Filter to reduce 70% (max.) harmful blue light to avoiding CVS (Computer Vision Syndrome).

3. Color

Select the image color you like from this function.

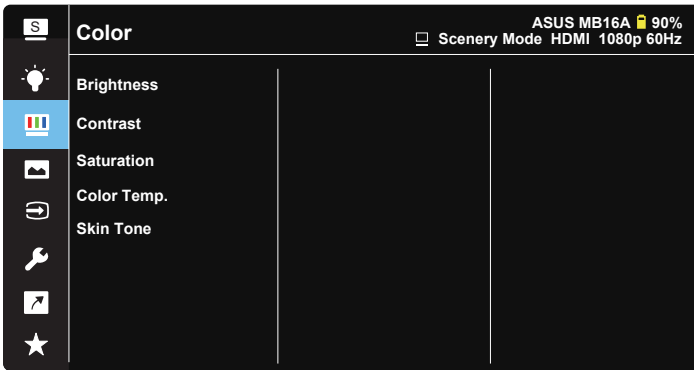

- **Brightness:** The adjusting range is from 0 to 100.
- **Contrast:** The adjusting range is from 0 to 100.
- **Saturation:** The adjusting range is from 0 to 100.
- **Color Temp.:** Contains three preset color modes (**Cool**, **Normal**, **Warm**) and **User Mode**.
- **Skin Tone:** Contains three color modes including **Reddish**, **Natural**, and **Yellowish**.



- In the User Mode, colors of R (Red), G (Green), and B (Blue) are user-configurable; the adjusting range is from 0 ~ 100.

4. Image

You can adjust the image Sharpness, Trace Free, Aspect Control, VividPixel and ASCR from this main function.

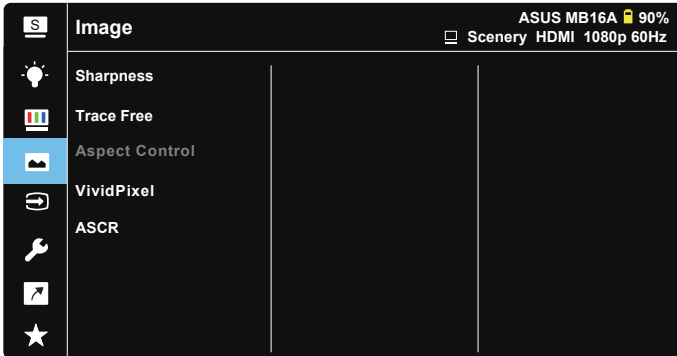

- **Sharpness:** Adjusts the picture sharpness. The adjusting range is from 0 to 100.
- **Trace Free:** Speeds up the response time by Over Drive technology. The adjusting range is from lower 0 to faster 100.
- **Aspect Control:** Adjusts the aspect ratio to “Full”, “4:3”.
- **VividPixel:** ASUS Exclusive Technology that brings lifelike visuals for crystal-clear and detail-oriented enjoyment. The adjusting range is from 0 to 100.
- **ASCR:** Select **ON** or **OFF** to enable or disable dynamic contrast ratio function.



-
- 4:3 is only available when input resolution H:V < 16:9.
-

5. Input Select

Select the input source from HDMI or Type-C input signal.



6. System Setup

Adjusts the system configuration.

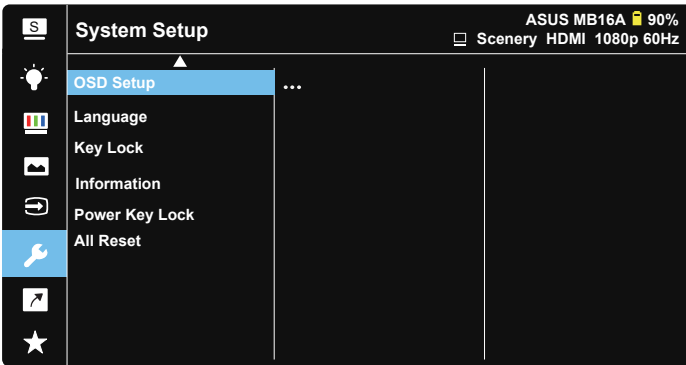
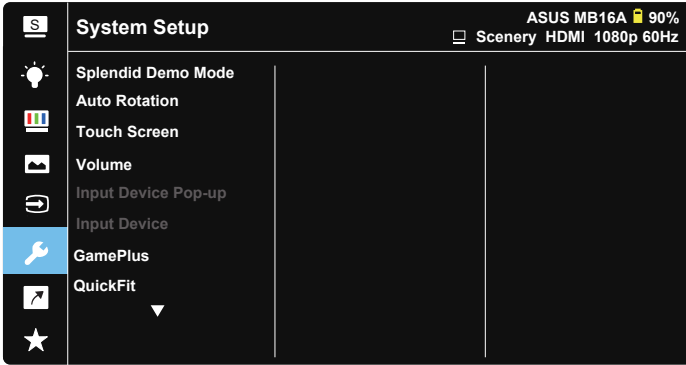

- **Splendid Demo Mode:** Activate the demo mode for the Splendid function.
- **Auto Rotation:** To enable/disable rotate image automatically. Please be noted that Auto rotation function is only working under **Windows OS** by installing **DisplayWidget** software.
- **Touch Screen:** To enable/disable the touch function.
- **Volume:** Adjusts the output volume level.
- **Input Device Pop-up :** To enable/disable Input Device & Power Supply from PC pop-up questions **WHENEVER** in connection.





- **Input Device :**

Select “Phone” if connect to mobile phone (Power supply function is not provided under “Phone” due to common mobile devices cannot provide enough power output). Select “NB/PC” if connect to NB/PC and then select “Charging From NB/PC” with charging function. This function allows you to sustain the working time for longer. In PC sub-function, you can disable power supply function by selecting “No Charging From NB/PC”

* No Charging here means getting power under 100mA, and this does not affect the battery life/usage of host devices connected.

* ZenScreen battery could still be consumed after choosing Charging From NB/PC due to insufficient power supply from NB/PC USB.

- **GamePlus:** The GamePlus Function provides a toolkit and creates a better gaming environment for users when playing different types of games. Particularly, Crosshair function is specially designed for new gamers or beginners interested in First Person Shooter (FPS) games. To active GamePlus:

- Press **GamePlus** Button to enter the GamePlus main menu.
- Activate Crosshair, Timer, FPS Counter or Display Alignment function.
- Move the  button up/down to select and press  to confirm the function needed. Press  to go off, and exit.
- Crosshair/Timer/FPS Counter is movable by moving  5-way key.

GamePlus main menu

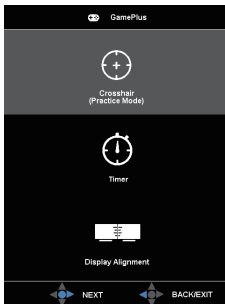

GamePlus-Crosshair

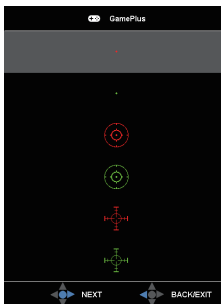

GamePlus-Timer



- **QuickFit:** See page 1-3 for details.
- **OSD Setup:** Adjusts the **OSD Timeout**, **DDC/CI**, and **Transparency** of the OSD screen.
- **Language:** Select OSD language. The selections are: **English, French, German, Spanish, Italian, Dutch, Russian, Poland, Czech, Croatia, Hungary, Romania, Portugal, Turkey, Simplified Chinese, Traditional Chinese, Japanese, Korean, Persian, Thai** and **Indonesian**.

- **Key Lock:** Pushing the 5-way button to the left for more than 5 seconds to disable key locking.
- **Information:** Displays the monitor information.
- **Power Key Lock:** To disable / enable power key.
- **All Reset:** Selects “**Yes**” to revert all settings to the factory default mode.

7. Shortcut

Selecting this option allows you to set shortcut key.

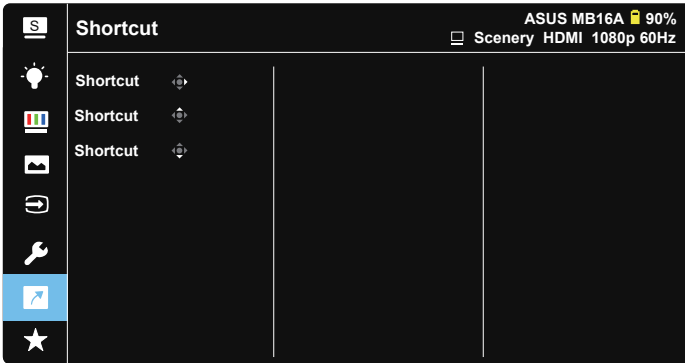

- **Shortcut** : User can select from “Blue Light Filter” “Splendid”, “Brightness”, “Contrast”, “Auto Rotation”, “Touch Screen”, “Input Select”, “Volume”, “Input Device” and set as shortcut key.

8. MyFavorite

Load/Save all settings on the monitor.

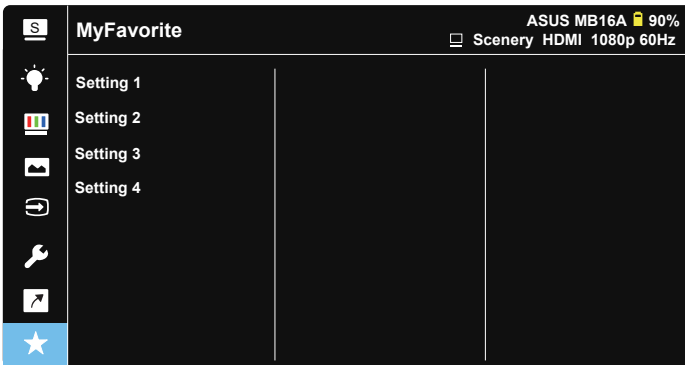

3.2 Specifications

Model	MB16AMT
Panel Size	15.6" (16:9, 39.49cm) wide screen
Resolution	1920 x 1080
Brightness (Typ.)	250 cd/m ²
Contrast (Typ.)	700:1
Display Colors	262 K
Digital Input	DisplayPort™ Alt Mode for USB Type-C™
Colors	Dark Gray
Power Consumption	≤ 12 W
Operating Temp.	5°C ~ 35°C
Operating Humidity	20-90% RH
Micro-HDMI Input	Yes
Touch function	Yes
Speaker	1W x 2
Phys. Dimension (WxHxD)	359.66 x 227.39 x 9 mm
Box Dimension (WxHxD)	485 x 305 x 76 mm
Net Weight (Esti.)	0.9 kg
Gross Weight (Esti.)	3.1 kg
Regulation Approvals	UL/cUL, CB, CE, CCC, KCC, FCC, BSMI, EAC(CU), RCM, VCCI, J-Moss, UkrSEPRO, RoHS, WEEE, Windows 7 & 8.1 & 10 WHQL, Blue light filter, Flicker free, BIS
Voltage Rating	5 - 9V ---, 2.0A QC3.0 charging spec is supported
Adapter	ASUS/AD2068M20 100-240V~50/60Hz 0.5A 5V ---, 2A(Normal model) OR 9V ---, 2A(Quick charge model)

*Specifications are subject to change without notice.

3.3 Troubleshooting (FAQ)

Problem	Possible Solution
Power LED is not ON	<ul style="list-style-type: none">• Check if the Type-C port connected to source of signal.• Check if the signal source is ON.• Connect to the ASUS adapter and check if the battery is low; if so, charge the battery before using it.• Press the ⏻ button to check if the monitor is in the ON mode.• Check the “Power Indicator” option in the OSD main menu, select the “ON” option and the power LED indicator lights up.
The power LED lights blue and there is no screen image	<ul style="list-style-type: none">• Check if the monitor and the computer are in the ON mode.• Make sure the USB Type-C cable is properly connected between the Portable Touch Monitor and the computer.• Inspect the signal cable and make sure none of the pins are bent.• Connect the computer with another available monitor to check if the computer is properly working.
Screen image is too light or dark	<ul style="list-style-type: none">• Adjust the Brightness settings via the button.
Screen image bounces or a wave pattern is present in the image	<ul style="list-style-type: none">• Make sure the USB Type-C cable is properly connected between the Portable Touch Monitor and the computer.• Move electrical devices that may cause electrical interference.
Screen image has color defects (white does not look white)	<ul style="list-style-type: none">• Inspect the USB Type-C cable and make sure that none of the pins are bent.
The monitor automatically turns off	<ul style="list-style-type: none">• The monitor automatically turns off when the battery power is zero. Please connect to the ASUS adapter and check if the battery is low; if so, charge the battery before using it.• Please check if the source of signal went into sleep mode. The monitor automatically turns off after the signal source slept for more than 15 seconds to save power consumption.

The signal source is shown in power supply mode

- The monitor will get a small amount of electricity from the signal source. This is normal.

3.4 Supported Timing List

PC Supported Primary Timing

Resolution	Refresh Rate	Horizontal Frequency
640x480	60Hz	31.469kHz
800x600	60Hz	37.879kHz
1024x768	60Hz	48.363kHz
1280x960	60Hz	60kHz
1280x1024	60Hz	63.981kHz
1440x900	60Hz	55.935kHz
1680x1050	60Hz	65.29kHz
1920x1080	60Hz	67.5kHz

VESA Modes, User Available Timing

Resolution	Refresh Rate	Horizontal Frequency
848x480	60Hz	31.02kHz
1280x720	60Hz	44.772kHz
1280x800	60Hz	49.702kHz
1920x1080	60Hz	66.587kHz