



Simply Better Connections

CL5708i / CL5716i

LCD KVM overIP Switch
User Manual

Compliance Statements

FEDERAL COMMUNICATIONS COMMISSION INTERFERENCE STATEMENT

This equipment has been tested and found to comply with the limits for a Class A digital device, pursuant to Part 15 of the FCC Rules. These limits are designed to provide reasonable protection against harmful interference when the equipment is operated in a commercial environment. This equipment generates, uses, and can radiate radio frequency energy and, if not installed and used in accordance with the instruction manual, may cause harmful interference to radio communications. Operation of this equipment in a residential area is likely to cause harmful interference in which case the user will be required to correct the interference at his own expense.

The device complies with Part 15 of the FCC Rules. Operation is subject to the following two conditions: (1) this device may not cause harmful interference, and (2) this device must accept any interference received, including interference that may cause undesired operation.

FCC Caution

Any changes or modifications not expressly approved by the party responsible for compliance could void the user's authority to operate this equipment.

Warning

Operation of this equipment in a residential environment could cause radio interference.

Achtung

Der Gebrauch dieses Geräts in Wohnumgebung kann Funkstörungen verursachen.



KCC Statement

유선 제품용 / A 급 기기 (업무용 방송 통신 기기)
이 기기는 업무용 (A 급) 전자파적합기기로서 판매자 또는 사용자는 이
점을 주의하시기 바라며, 가정 외의 지역에서 사용하는 것을 목적으로
합니다.

Industry Canada Statement

This Class A digital apparatus complies with Canadian ICES-003.

CAN ICES-003 (A) / NMB-003 (A)

RoHS

This product is RoHS compliant.

About this Manual

This user manual is provided to help you get the most from your CL5708I / CL5716I system. It covers all aspects of installation, configuration and operation. An overview of the information found in the manual is provided below.

Chapter 1, Introduction, introduces you to the CL5708I / CL5716I system. Its purpose, features and benefits are presented, and its front and back panel components are described.

Chapter 2, Hardware Setup, describes how to set up your installation. The necessary steps from a basic single stage hookup to a complete 32-switch daisy chained operation are provided.

Chapter 3, Basic Operation, explains the fundamental concepts involved in operating the CL5708I / CL5716I.

Chapter 4, OSD Operation, provides a complete description of the CL5708I / CL5716I's on-screen display (OSD), and how to work with it.

Chapter 5, Keyboard Port Operation, details all of the concepts and procedures involved in the hotkey operation of your CL5708I / CL5716I installation.

Chapter 6, Logging In, describes how to log in to the KVM over IP switch with each of the available access methods: from a local console; an Internet browser; a stand-alone Windows application (AP) program; and a stand-alone Java application (AP) program.

Chapter 7, The User Interface, describes the layout and explains the components of the KVM over IP switch user interface.

Chapter 8, Port Access, describes the Port Access page and how to configure the options it provides regarding port and power outlet manipulation.

Chapter 9, User Management, shows super administrators and administrators how to create, modify, and delete users and assign attributes to them.

Chapter 10, Device Management, shows super administrators how to configure and control overall KVM over IP switch operations.

Chapter 11, Log, explains how to view, clear and export event log information, and how to set event notification settings for the KVM over IP switch.

Chapter 12, Maintenance, explains how to upgrade the KVM over IP switch firmware, as well as the firmware of the KVM Adapter Cables used to connect its ports to the installed devices.

Chapter 13, Download, describes how to download stand-alone AP versions of the Win Client, the Java Client, and the Log Server programs.

Chapter 14, Port Operation, provides detailed information on accessing and operating the devices connected to the KVM over IP switch's ports.

Chapter 15, The Log Server, explains how to install and configure the Log Server.

Chapter 16, Keyboard Emulation, provides tables that list the PC to Mac and PC to Sun keyboard emulation mappings.

Chapter 17, The Firmware Upgrade Utility, explains how to use this utility to upgrade the CL5708I / CL5716I's firmware with the latest available versions.

An Appendix, provides specifications and other technical information regarding the CL5708I / CL5716I.

Conventions

This manual uses the following conventions:

- | | |
|---|--|
| Monospaced | Indicates text that you should key in. |
| [] | Indicates keys you should press. For example, [Enter] means to press the Enter key. If keys need to be chorded, they appear together in the same bracket with a plus sign between them: [Ctrl+Alt]. |
| 1. | Numbered lists represent procedures with sequential steps. |
| ◆ | Bullet lists provide information, but do not involve sequential steps. |
| > | Indicates selecting the option (on a menu or dialog box, for example), that comes next. For example, Start > Run means to open the <i>Start</i> menu, and then select <i>Run</i> . |
|  | Indicates critical information. |

Package Contents

Basic Package

The basic CL5708I / CL5716I package consists of:

- ◆ 1 CL5708I / CL5716I LCD KVM over IP Switch with standard Rack Mounting Kit
- ◆ 2 custom KVM cable sets
- ◆ 1 5-in-1 USB / PS/2 console cable
- ◆ 1 firmware upgrade cable
- ◆ 1 power cord
- ◆ 1 user instructions*

Check to make sure that all the components are present and that nothing got damaged in shipping. If you encounter a problem, contact your dealer.

Read this manual thoroughly and follow the installation and operation procedures carefully to prevent any damage to the unit, and/or any of the devices connected to it.

* Features may have been added to the CL5708I / CL5716I since this manual was published. Please visit our website to download the most up-to-date version of the manual.

Product Information

For information about all ATEN products and how they can help you connect without limits, visit ATEN on the Web or contact an ATEN Authorized Reseller. Visit ATEN on the Web for a list of locations and telephone numbers:

International	http://www.aten.com
North America	http://www.aten-usa.com

User Information

Online Registration

Be sure to register your product at our online support center:

International	http://eservice.aten.com
---------------	---

Telephone Support

For telephone support, call this number:

International	886-2-8692-6959
China	86-400-810-0-810
Japan	81-3-5615-5811
Korea	82-2-467-6789
North America	1-888-999-ATEN ext 4988 1-949-428-1111

User Notice

All information, documentation, and specifications contained in this manual are subject to change without prior notification by the manufacturer. The manufacturer makes no representations or warranties, either expressed or implied, with respect to the contents hereof and specifically disclaims any warranties as to merchantability or fitness for any particular purpose. Any of the manufacturer's software described in this manual is sold or licensed *as is*. Should the programs prove defective following their purchase, the buyer (and not the manufacturer, its distributor, or its dealer), assumes the entire cost of all necessary servicing, repair and any incidental or consequential damages resulting from any defect in the software.

The manufacturer of this system is not responsible for any radio and/or TV interference caused by unauthorized modifications to this device. It is the responsibility of the user to correct such interference.

The manufacturer is not responsible for any damage incurred in the operation of this system if the correct operational voltage setting was not selected prior to operation. PLEASE VERIFY THAT THE VOLTAGE SETTING IS CORRECT BEFORE USE.

Terminology

Throughout the manual we make reference to the terms *Local* and *Remote* in regard to the operators and equipment deployed in a KVM over IP switch installation. Depending on the point of view, users and servers can be considered *Local* under some circumstances, and *Remote* under others:

- ◆ Switch's Point of View
 - ◆ Remote users – We refer to a user as a *Remote* user when we think of him as someone who logs into the switch over the net from a location that is *remote from the switch*.
 - ◆ Local Console – The keyboard, mouse and monitor connected directly to the switch.
 - ◆ Servers – The servers attached to the switch via KVM Adapter Cables.
- ◆ User's Point of View
 - ◆ Local client users – We refer to a user as a *Local client user* when we think of him as sitting at his computer performing operations on the servers connected to the switch that is *remote from him*.
 - ◆ Remote servers – We refer to the servers as *Remote servers* when we think of them from the Local Client User's point of view – since, although they are locally attached to the switch, they are *remote from him*.

When we describe the overall system architecture, we are usually speaking from the switch's point of view – in which case the users are considered remote. When we speak about operations users perform via the browser, viewers, and AP programs over the net, we are usually speaking from the user's point of view – in which case the switch and the servers connected to it are considered remote.

Contents

Compliance Statements	ii
About this Manual	iv
Conventions	v
Package Contents	vi
Basic Package	vi
Product Information	vii
User Information	vii
Online Registration	vii
Telephone Support	vii
User Notice	viii
Terminology	ix
Contents	x

Chapter 1.

Introduction

Overview	1
Features	3
Requirements	6
Remote User Computers	6
External Console	6
Server	6
Cables	7
Operating Systems	7
Components	9
Front View	9
Rear View	11

Chapter 2.

Hardware Setup

Overview	13
Before you Begin	13
Standard Rack Mounting	14
Optional Rack Mount Kits	16
Grounding	16
Single Level Installation	17
Cabling Diagrams	19
Daisy Chain Installations	20

Chapter 3.

Basic Operation

Opening the Console	23
Closing the Console	24
Operating Precautions	25
Powering Off and Restarting	26
LCD OSD Configuration	27

The LCD Buttons	27
LCD Adjustment Settings	28
Hot Plugging	29
Changing Station Positions	29
Hot Plugging KVM Ports	29
Hot Plugging External Console Ports	29
Port Selection	30
Manual Port Switching	30
Port ID Numbering	30
USB Peripheral Devices	31

Chapter 4.

OSD Operation

OSD Overview	33
Manufacturing Number	33
OSD Login	33
OSD Hotkey	33
OSD Main Screen	34
OSD Main Screen Headings	35
OSD Navigation	35
OSD Functions	36
F1: GOTO	36
F2: LIST	37
F3: SET	38
F4: ADM	40
F5: SKP	43
F6: BRC	44
F7: SCAN	45
F8: LOUT	45

Chapter 5.

Keyboard Port Operation

Hotkey Port Control	47
Invoke Hotkey Mode	48
Local Console	48
Number Lock and Minus Keys	48
Control and F12 Keys	48
Remote Sessions	49
Scroll Lock	49
Control	49
Select the Active Port	50
Auto Scan Mode	51
Invoking Auto Scan:	51
Skip Mode	52
Computer Keyboard / Mouse Reset	53
Hotkey Beeper Control	53
Quick Hotkey Control	54

OSD Hotkey Control	54
Port OS Control	55
Set USB Speed.	55
Restore Default Values	56
Hotkey Summary Table	57

Chapter 6.

Logging In

Overview	59
Browser Login	60
Windows Client AP Login	61
The Windows Client AP Connection Screen	62
Connecting – Windows Client AP	63
The File Menu	64
Java Client AP Login	65
The Java Client AP Connection Screen	66
Connecting – Java Client AP	67

Chapter 7.

The User Interface

The Web Browser Main Page	69
Page Components	70
The Tab Bar	71
The AP GUI Main Page	72
The Control Panel	74
WinClient Control Panel	74
WinClient Control Panel Functions	76
Macros	79
Hotkeys	79
Video Settings	85
Network Bandwidth Information for KVM Sessions	90
The Message Board	90
Button Bar	90
Message Display Panel	91
Compose Panel	91
User List Panel	91
Zoom	93
The On-Screen Keyboard	94
Changing Languages	94
Expanded Keyboard	95
Mouse Pointer Type	96
Mouse DynaSync Mode	97
Automatic Mouse Synchronization (DynaSync)	97
Manual Mouse Synchronization	98
Control Panel Configuration	99
The Java Control Panel	101

Chapter 8.**Port Access**

Overview	103
Browser GUI	103
AP GUI	103
The Sidebar	105
The Sidebar Tree Structure	105
Scan	106
Array	106
Filter	107
Sidebar Utilities	108
Port/Outlet Naming	109
KVM Devices and Ports – Connections Page	111
Device Level	111
Port Level	112
Status	112
Associated Links	112
Favorites	113
Adding a Favorite	113
Modifying a Favorite	115
User Preferences	116
Sessions	118
Access	119
Port Level Browser GUI Interface	119
Port Level AP GUI Interface	121
Saving Changes	122
Port Configuration	123
Device Level	123
Port Level	124
Port Properties	124

Chapter 9.**User Management**

Overview	127
Browser GUI	127
AP GUI	127
Users	129
Adding Users	129
Modifying User Accounts	133
Deleting User Accounts	133
Device Assignment	134
Assigning Device Permissions From the User's Notebook	134
Filters	136

Chapter 10.**Device Management**

KVM Devices	137
Device Information	137
Operating Mode	138
Network	139
Service Ports	140
Network Transfer Rate	142
Finishing Up	142
ANMS	143
Event Destination	143
CC Management Settings	146
Security	147
Login Failures	147
Date/Time	158
Time Zone	158
Network Time	159

Chapter 11.

Log

Overview	161
Browser GUI	161
AP GUI	161
Log Information	162
Filter	162

Chapter 12.

Maintenance

Overview	165
Browser GUI	165
AP GUI	165
Firmware Upgrade	166
Backup/Restore	167
Backup	167
Restore	168
Ping Host	169
System Operation	170
Clear Port Names:	170
Restore Default Values:	170
Reset on exit:	170

Chapter 13.

Download

Overview	171
----------	-----

Chapter 14.

Port Operation

Overview	173
Connecting to a Port	175

The Port Toolbar	176
The Toolbar Icons	177
Toolbar Hotkey Port Switching	178
Auto Scanning	178
Skip Mode	179
Recalling the Port Access Page	180
GUI Hotkey Summary Table	180
Panel Array Mode	181
Panel Array Toolbar	182
Chapter 15.	
The Log Server	
Installation	183
Starting Up	184
The Menu Bar	185
Configure	185
Events	186
Search:	186
Maintenance:	188
Options	189
Help	189
The Log Server Main Screen	190
Overview	190
The List Panel	191
The Event Panel	191
Chapter 16.	
Keyboard Emulation	
Mac Keyboard	193
Sun Keyboard	194
Chapter 17.	
The Firmware Upgrade Utility	
Introduction	195
Downloading the Firmware Upgrade Package	195
Preparation	196
Starting the Upgrade	197
Upgrade Succeeded	199
Upgrade Failed	200
Appendix	
Safety Instructions	201
General	201
Rack Mounting	203
Consignes de sécurité	204
Général	204
Montage sur bâti	207

Technical Support	208
International	208
North America	208
Specifications	209
Connection Tables	212
CL5708I to Compatible 8-Port Switches	212
CL5708I to Compatible 16-Port Switches	212
CL5716I to Compatible 8-Port Switches	213
CL5716I to Compatible 16-Port Switches	213
Supported KVM Switches	214
Troubleshooting	215
General Operation	215
Mouse Problems	217
Web Browser	218
The WinClient ActiveX Viewer and the WinClient AP	219
The Java Applet and Java Client AP	220
Sun Systems	221
Mac Systems	221
The Log Server	222
Panel Array Mode	222
IP Address Determination	225
IP Installer	225
Browser	226
IPv6	227
Link Local IPv6 Address	227
IPv6 Stateless Autoconfiguration	228
Port Forwarding	229
Additional Mouse Synchronization Procedures	230
Windows:	230
Sun / Linux	231
Additional Video Resolution Procedures	232
Trusted Certificates	233
Overview	233
Installing the Certificate	234
Certificate Trusted	235
Self-Signed Private Certificates	237
Examples	237
Importing the Files	237
Clear Login Information	238
OSD Factory Default Settings	239
Troubleshooting	240
Overview	240
Keyboard Invocation Keys	241
About SPHD Connectors	241
Limited Warranty	242

Chapter 1

Introduction

Overview

The CL5708I / CL5716I Slideaway™ LCD KVM over IP Switch is an integrated LCD console and keyboard, video, and mouse (KVM) switch that offers secure access to 8 or 16 attached computers and mounts in only 1U of rack space. It features an independently retractable 17" or 19" LED-backlit LCD monitor and keyboard with built-in touchpad. An extra console port is provided on the rear panel to manage the LCD KVM switch from an external console (monitor, keyboard, and mouse) up to 20 meters away. For added convenience it also supports an external USB mouse.

The CL5708I / CL5716I supports both PS/2 and USB keyboards and mice for the connected computers, and the CL5708I / CL5716I supports USB peripheral devices to be used with the attached computers. A single CL5708I / CL5716I can control up to 8 or 16 computers. As many as 15 additional compatible KVM switches can be daisy chained to the CL5708I / CL5716I, so that up to 128 or 256 computers can all be controlled from a single keyboard, monitor, and mouse console (see the Appendix for a list of compatible ATEN switches).

The CL5708I / CL5716I is built on a modular design. The KVM section can be detached from the switch section for convenient maintenance and repair.

There are four models in the series as outlined in the following table:

Model	LCD Panel	KVM Ports
CL5708IM	17"	8
CL5716IM	17"	16
CL5708IN	19"	8
CL5716IN	19"	16

Your CL5708I / CL5716I investment is protected by an included firmware upgrade utility. You can stay current with the latest functionality improvements by downloading firmware update files from our website as they become available, and using the utility to quickly and conveniently perform the upgrade.

Setup is fast and easy: plugging cables into their appropriate ports is all that is entailed. Because the CL5708I / CL5716I intercepts keyboard input directly, there is no software to configure, no need to get involved in complex installation routines, nor any need to be concerned with incompatibility problems. Access to any computer connected to the installation is easily accomplished either by entering hotkey combinations from the keyboard, front panel pushbuttons, or by means of a powerful, keyboard & mouse-driven OSD (on-screen display) menu system. A convenient *Auto Scan* feature also permits automatic scanning and monitoring of the activities of all computers running on the installation one by one.

There is no better way to save time and money than with a CL5708I / CL5716I installation. By using the CL5708I / CL5716I with its sliding LCD console to manage your installation, you: eliminate the expense of having to purchase a separate keyboard, monitor, and mouse for each computer; save all the space those extra components would take up; save the space that a keyboard, monitor, and mouse would take with a standard KVM switch; save on energy costs; and eliminate the inconvenience and wasted effort involved in constantly moving from one computer to another.

Features

- ◆ Exclusive LED illumination light - designed by ATEN to illuminate the keyboard and touchpad to allow visibility in low-light conditions
- ◆ Integrated KVM console with 17” or 19” LED-backlit LCD in a Slideaway™ housing
- ◆ Space saving technology – up to two consoles (one bus) control up to 8 or 16 computers
- ◆ One bus for remote KVM over IP access
- ◆ Daisy chain up to 15 additional units – control up to 128 (CL5708I) or 256 (CL5716I) computers from a single console¹
- ◆ Easy computer selection via pushbuttons, Hotkey Mode, OSD (On Screen Display), and Browser-based GUI
- ◆ Dual Interface – supports computers with PS/2 or USB keyboards and mice
- ◆ USB port allows each computer to access USB peripherals²
- ◆ Multiplatform support – Windows, Linux, Mac, and Sun
- ◆ Multi-browser support (IE, Firefox, Safari, Opera, Netscape)
- ◆ Supports multimedia USB keyboards for Windows, Mac and Sun
- ◆ Auto PS/2 and USB interface detection
- ◆ Keyboard and mouse emulation (PS/2 and USB) for smooth switching and simultaneous booting of multiple computers even when the console focus is elsewhere
- ◆ Superior video quality – supports resolutions up to 1280 x 1024 @ 75 Hz; DDC2B for the local console; up to 1920 x 1200 @ 60 Hz / 24 bit color depth for remote sessions
- ◆ No software required – convenient computer selection via keyboard & mouse-driven, intuitive OSD (on-screen display) menus, front panel pushbuttons, and hotkeys
- ◆ Auto-senses station’s position on daisy chained installations; no need for manual dip switch setting; front panel LED indicates station's position
- ◆ Two level password security – authorized users view and control computers

-
1. The CL5708I / CL5716I must be the first switch in a daisy chain and only other compatible KVM switches can be daisy chained below it.
 2. The USB peripheral function only works with USB cable set connections. It will not work with PS/2 cable set connections.
-

- ◆ External (Remote) authentication support: RADIUS, LDAP, LDAPS, MS Active Directory
- ◆ IPv6 capable
- ◆ Support for IP/MAC Filter
- ◆ Local and remote access logged and authenticated
- ◆ Secure keyboard/mouse/video transmission via RC4 128 bit encryption
- ◆ Supports TLS 1.2 data encryption and RSA 2048 bit certificates for secure user logins from a browser
- ◆ Auto Scan mode enables continuous monitoring of user-selected computers
- ◆ Up to 32 concurrent logins
- ◆ Multilanguage web UI support featuring a tree-structured local and remote OSD
- ◆ Backup and restore configuration and user account settings
- ◆ Broadcast support – commands from the keyboard can be broadcast to all available computers on the installation
- ◆ Hot pluggable – add or remove computers without having to power down the switch
- ◆ Beeper on/off via hotkey and OSD
- ◆ Firmware upgrades to all chained KVM switches (CS1708A / CS1716A) at the same time via the daisy chain cable
- ◆ Extra console port – manage computers from an external console (monitor, USB or PS/2 keyboard and mouse)
- ◆ Supports external USB mouse
- ◆ Conveniently located station and port selectors, each with two 7-segment LED displays to quickly switch to target computers
- ◆ Dedicated *Hotkey* mode and *OSD Invocation Keys* reduce the number of keystrokes and provide quick access to these functions
- ◆ OSD tree structure makes finding and managing computers easy
- ◆ Console lock – enables the console drawer to remain securely locked away when not in use
- ◆ OSD port list automatically expands when new stations are added
- ◆ Security – Administrator/User password authorization for enhanced security protection; Administrator access rights synchronized between first and chained stations
- ◆ OSD screen automatically adjusts to resolution changes

- ◆ Two types of logout: manual and timed
- ◆ Slideaway™ housing is slightly less than 1U with top and bottom clearance for smooth operation in 1U of rack space
- ◆ Optional rack mount kits available including easy installation options
- ◆ DDC emulation – video settings of each computer are automatically adjusted for optimal output to the monitor
- ◆ Standard 105-key keyboard
- ◆ Keyboard status restored when switching computers
- ◆ Keyboard language supports English (US), English (UK), French, German, German (Swiss), Greek, Hungarian, Italian, Japanese, Korean, Russian, Spanish, Swedish and Traditional Chinese

Requirements

Remote User Computers

Remote user computers (also referred to as client computers) are the ones the users log into the switch with from remote locations over the Internet (see *Terminology*, page ix). The following equipment must be installed on these computers:

- ◆ For best results we recommend computers with at least a P III 1 GHz processor, with their screen resolution set to 1024 x 768.
- ◆ IE8 or above web browser
- ◆ Browsers must support TLS 1.2 encryption.
- ◆ For best results, a network transfer speed of at least 512kbps is recommended.
- ◆ For the browser-based WinClient ActiveX Viewer, DirectX 8 must be present, and at least 150MB of memory must be available after installation.
- ◆ For the browser-based Java Client Viewer the latest version of the Java Runtime Environment (JRE) must be installed, and at least 205MB of memory must be available after installation.
- ◆ For the Windows Client AP, DirectX 8 must be present, and at least 90MB of memory must be available after installation.
- ◆ For the Java Client AP, the latest version of the Java Runtime Environment (JRE) must be installed, and at least 145MB of memory must be available after installation.
- ◆ For the *Log Server*, you must have the Microsoft Jet OLEDB 4.0 or higher driver installed.

External Console

The following hardware components are required for the external console:

- ◆ A VGA, SVGA, or multisync monitor capable of displaying the highest resolution provided by any computer in the installation.
- ◆ A USB or PS/2 keyboard and mouse

Server

The following equipment must be installed on each server:

- ◆ A VGA, SVGA, or multisync video graphics card with an HDB-15 port.

Note: The integrated LCD monitor's maximum resolution is 1280 x 1024 @ 75 Hz. Make sure that none of the computer resolution settings exceed the LCD monitor's maximum resolution.

- ◆ PS/2 mouse and keyboard ports (6-pin Mini-DIN), or at least one USB port.
- ◆ Direct support Sun USB systems; or, for Sun legacy systems, an ATEN CV130A Sun Console Converter.

Cables

Substandard cables may damage the connected devices or degrade overall performance. For optimum signal integrity and to simplify the layout, we strongly recommend that you use the high quality CS Custom Cable sets described below:

Function		Length	Part Number
KVM switch to KVM switch (Daisy chaining)		0.6 m	2L-1700
		1.8 m	2L-1701
		3 m	2L-1703
		5 m	2L-1705
		15 m	2L-1715
KVM switch to computer	PS/2	1.2 m	2L-5201P
		1.8 m	2L-5202P
		3.0 m	2L-5203P
		6.0 m	2L-5206P
		1.8 m	2L-5702P
	USB	1.2 m	2L-5201U
		1.8 m	2L-5202U
		3.0 m	2L-5203U
		5.0 m	2L-5205U

Operating Systems

Supported operating systems are shown in the table below:

OS		Version
Windows		2000 or later
Linux	RedHat	7.1 or later
	SuSE	9.0 or later
	Mandriva (Mandrake)	9.0 or later

OS		Version
UNIX	AIX	4.3 or later
	FreeBSD	4.2 or later
	Sun	Solaris 8 or later
Novell	Netware	5.0 or later
Mac		OS 9 or later
DOS		6.22

Components

Front View

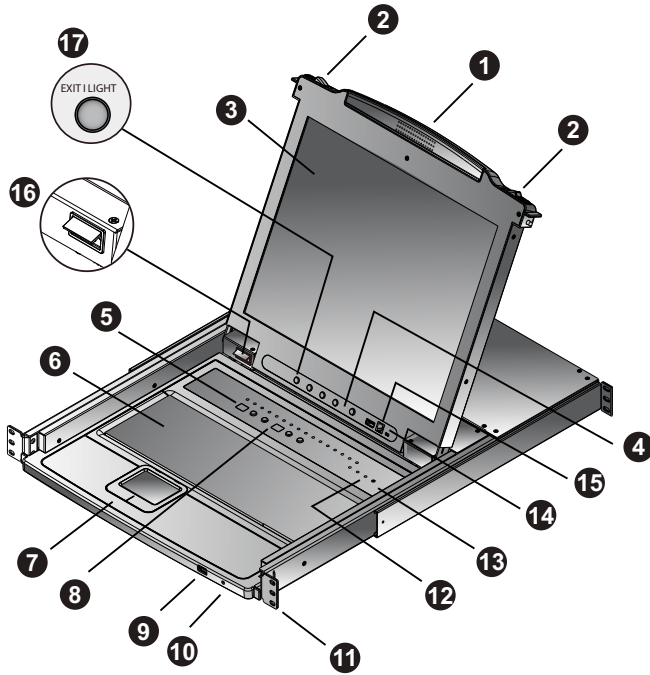

Note: The CL5716i is pictured in the diagrams of this chapter. However, the CL5708i is the same as the CL5716i, except that it has 8 KVM ports.

No.	Component	Description
1	handle	Pull to slide the KVM module out; push to slide the module in (see item 2 in this table).
2	slide release	In order to slide the console out, you must first release it by sliding these tabs to the inside. See page 23 for details on sliding the console in and out.
3	LCD display	After sliding the KVM module out, flip up the cover to access the LCD monitor.
4	LCD controls	The LCD On / Off switch is located here, as well as buttons to control the position and picture settings of the LCD display. See page 27 for details.
5	port LEDs	An ON LINE LED lights to indicate that the computer attached to its corresponding port is up and running.
6	keyboard	Standard 105-key keyboard
7	touchpad	Standard mouse touchpad
8	station / port switches	Press the UP or DOWN buttons for the port ID and station ID to bring the KVM focus to the computer attached to the corresponding port. See <i>Manual Port Switching</i> , page 30.
9	external mouse port	A USB mouse port is provided for users who prefer to use an external mouse.
10	power LED	Lights to indicate that the unit is receiving power.
11	rack mount brackets	The rack mount brackets located at each corner of the unit secure the chassis to a system rack.
12	lock LEDs	Num Lock, Caps Lock, Scroll Lock LEDs are located here.
13	reset button	Located to the right of the Lock LEDs. Press this button in with a small object to perform a system reset.
14	firmware upgrade section	<ul style="list-style-type: none"> ◆ Firmware upgrade port: The firmware upgrade cable that transfers the firmware upgrade data from the administrator's computer to the CL57081 / CL57161 plugs into this RJ-11 connector. ◆ Firmware upgrade switch: During normal operation this switch should be in the NORMAL position. (See <i>The Firmware Upgrade Utility</i>, page 195 for firmware upgrading details.)
15	USB port	The USB port is available to connect a USB 1.1 peripheral device (flash drive, CD-ROM drive, etc.) to the switch.
16	LED illumination light	Illuminates the keyboard and touchpad to allow visibility in low-light conditions.
17	Exit / Light pushbutton	<p>Press the Exit / Light pushbutton for two seconds to turn the LED Illumination Light on or off. (Default: On)</p> <p>During the LCD OSD mode, this pushbutton has more functions, refer to <i>The LCD Buttons</i> on page 27 for more details.</p>

Rear View

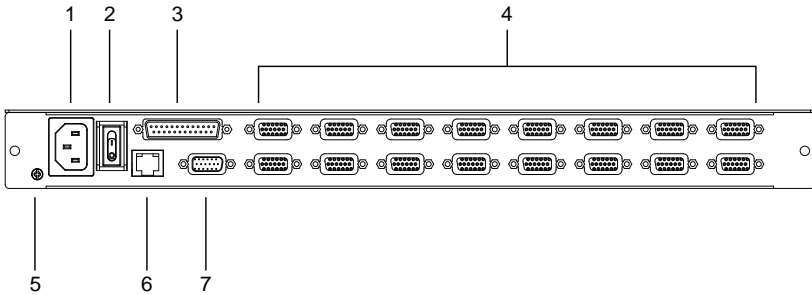

No.	Component	Description
1	power socket	This is a standard 3-prong AC power socket. The power cord from an AC source plugs in here.
2	power switch	This standard rocker switch powers the unit on and off.
3	daisy chain port	When daisy chaining units, the cable plugs in here.
4	KVM port section	The cables that link to the computers plug in here. Note: The shape of these SPHD connectors has been specifically modified so that only KVM cables designed to work with this switch can plug in (see the <i>Cables</i> section on page 7, for details). Do NOT attempt to use ordinary 15 pin VGA connector cables to link these ports to the computers.
5	grounding terminal	The grounding wire used to ground the switch attaches here.
6	LAN port	The cable that connects the unit to the network (10/100 Mbps) plugs in here.
7	external console port	For flexibility and convenience, the CL5708I / CL5716I supports an independent, external, KVM console. The external console keyboard, monitor, and mouse cables plug in here.

This Page Intentionally Left Blank

Chapter 2

Hardware Setup

Overview

For convenience and flexibility that allows mixing PS/2 and USB interfaces, the CL5708I / CL5716I design utilizes custom KVM cables that serve as intermediaries between the KVM switch and the connected computers.

A separate custom KVM cable is required for each computer connection. The custom KVM cables are listed in the *Cables*, page 7 section. Consult your dealer to find out which custom KVM cables best fit your needs.

Before you Begin



1. Important safety information regarding the placement of this device is provided on page 201. Please review it before proceeding.
2. Make sure that the power to all devices connected to the installation are turned off. You must unplug the power cords of any computers that have the Keyboard Power On function.

Note:

- ◆ It takes two people to mount the console.
- ◆ The standard rack mount kit does not include screws or cage nuts. If you need additional screws or cage nuts, contact your rack dealer.

Standard Rack Mounting

A standard rack mount kit is provided with your CL5708I / CL5716I. The kit enables the switch to be mounted in rack with a depth of 42.0–77.0 cm.

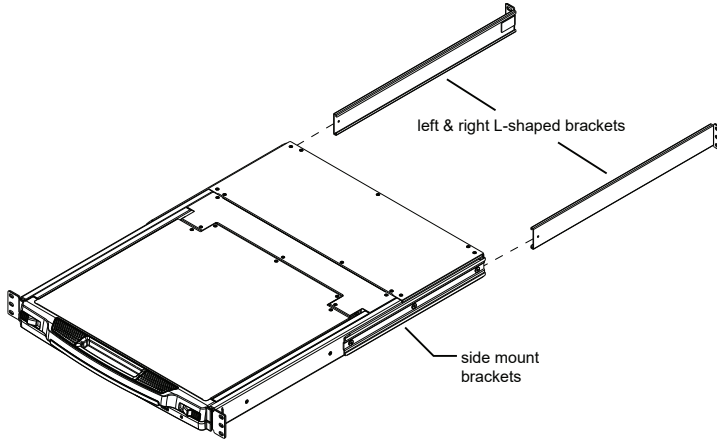

To rack mount the switch, do the following:

1. Have one person position the unit in the rack and hold it steady. Have the second person screw the front brackets to the rack.

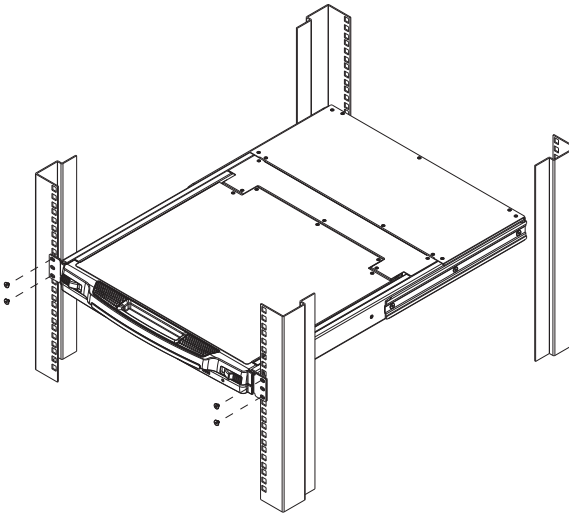

2. While the first person still holds the unit in place, the second person slides the left & right L-shaped brackets into the unit's side mounting brackets from the rear, installing four screws in the tabs to secure them in place.

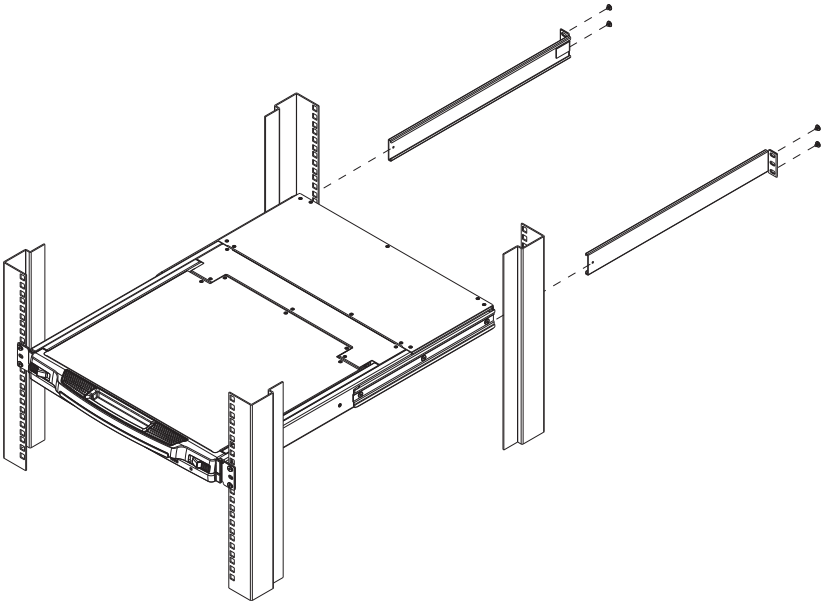

3. After the L-shaped brackets are secured, tighten all the screws.
Allow at least 5.1 cm on each side for proper ventilation, and at least 12.7 cm at the back for the power cord and cable clearance.

Optional Rack Mount Kits

For convenience and flexibility, optional rack mount kits are available and are listed in the table below:

Mounting Kit	Description
Standard Long Rack Mount Kit	This kit is the long-railed version of your standard rack mount kit that lets you fit your device to racks with greater depth.
Easy Installation Rack Mount Kit	This kit is designed to be easy to install and can be installed by one person

- Note:**
- ♦ For more information, visit the product webpage and refer to the *Compatible Accessories*.
 - ♦ For detailed installation steps, visit the product webpage and refer to the *Optional Rack Mount Kits Installation Guide*.

Grounding

To prevent damage to your installation it is important that all devices are properly grounded.

Use a grounding wire to ground the CL5708I / CL5716I by connecting one end of the wire to the grounding terminal, and the other end of the wire to a suitable grounded object.

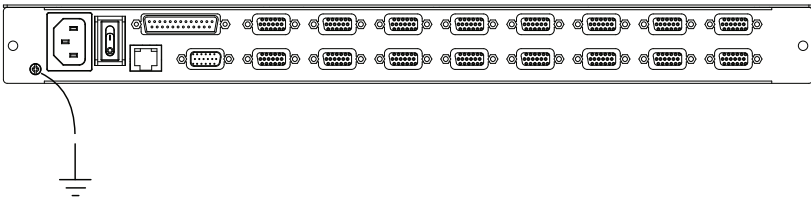

Single Level Installation

In a single level installation, there are no additional switches daisy chained from the first unit. To set up a single level installation, refer to the installation instructions and diagrams on the following pages (the numbers in the diagrams correspond to the numbers of the installation steps).

1. Use the grounding wire to connect the switch's grounding terminal to a suitable grounded object.
2. Plug an Ethernet cable from the network into the LAN port.
3. (Optional) Use the console cable provided with the package to connect a keyboard, monitor, and mouse to the console port. See *Cabling Diagrams*, page 19.

Note: The maximum distance between the switch and a computer is 10 m.

4. For each of the computers you are installing, use a KVM cable set to connect a KVM port to the computer's keyboard, video and mouse ports. See *KVM Cable Installation Diagrams*, page 19.

Note: The maximum distance between the switch and a computer is 10 m.

5. Plug the power cord into the CL5708I / CL5716I power socket and into a AC power source.
6. Power on the CL5708I / CL5716I.
7. After the CL5708I / CL5716I is powered on, power on the computers. See *Powering Off and Restarting*, page 26 for details.

Installation Diagram

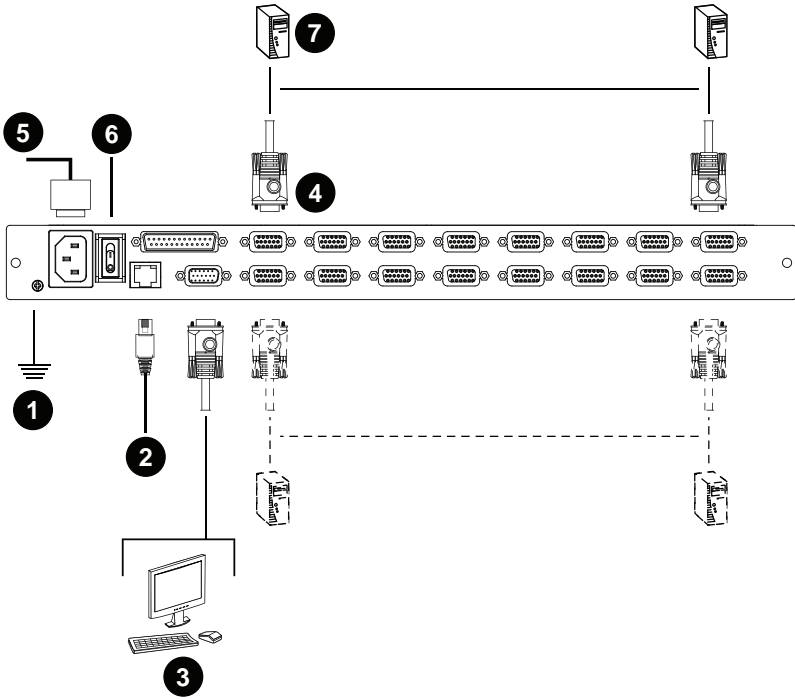

Cabling Diagrams

Use the following diagrams as a guide for attaching cables to an external console and/or computers you will be connecting to the CL5708I / CL5716I.

Console Cable Installation Diagram

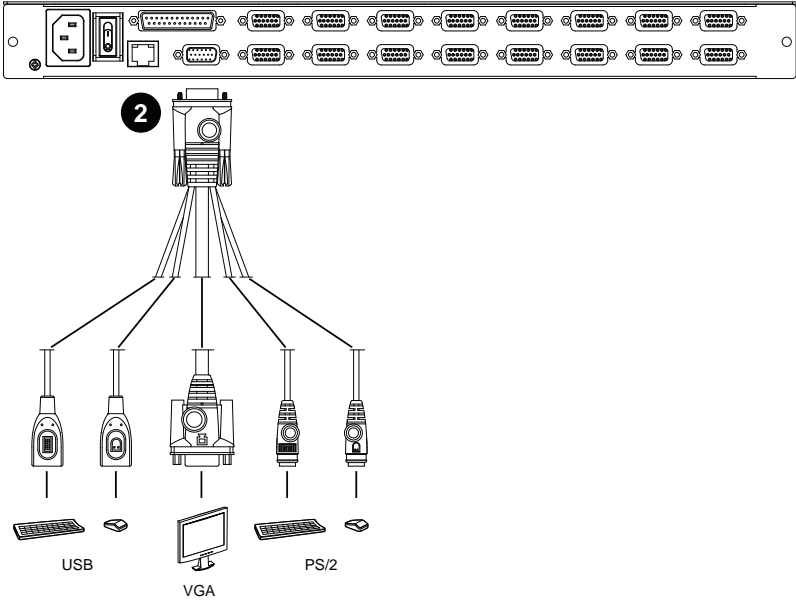

KVM Cable Installation Diagrams

USB KVM Cable Connection

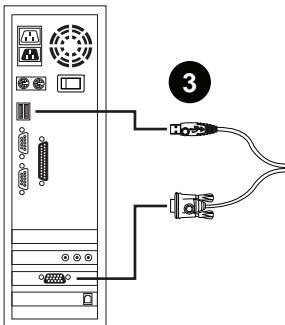

PS/2 KVM Cable Connection

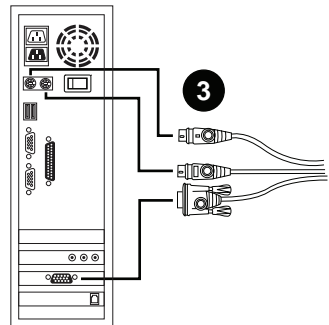

Daisy Chain Installations

To control even more computers, up to 15 compatible KVM switches can be daisy chained down from the CL5708I / CL5716I (see see *Supported KVM Switches*, page 214 for a list of compatible ATEN switches). In a complete installation, as many as 128 or 256 computers can be controlled from the CL5708I / CL5716I. Tables showing the relation between the number of computers and the number of units needed to control them are provided on page 212 in the Appendix.

To set up a daisy chain installation, first make sure that power to all the devices you will be connecting have been turned off. Refer to the daisy chain installation diagram on page 21, as you do the following:

1. For having the LCD KVM switch CL5708I / CL5716I as the first station, connect the *chain out* port of CL5708I / CL5716I to the *chain in* port of the next station using a daisy chain cable set (described in the *Cables* section, page 7).

For the rest of the daisy chain, connect the *chain out* port of the chained station to the *chain in* port of the consecutive station using a daisy chain cable set. Make sure the KVM switches (stations) have their *chain in* port connected to a previous station.

2. Connect the keyboard, video and mouse ports of the computers you are installing to any available KVM port on the switches using compatible KVM cable sets. See *KVM Cable Installation Diagrams*, page 19.

Note: The maximum distance between the switch and a computer is 10 m.

3. Power up the installation according to the following procedure:
 - a) Power on the CL5708I / CL5716I.
 - b) Power on each station on the installation in turn (second station, then third station, etc.).

In each case, wait for the station ID to be ascertained and displayed on the current station before powering on the next one.
 - c) After all the stations are turned on, power on the computers.

Note: 1. The maximum distance between any two stations is 15 m.

2. The total maximum distance from the first station to the last station is 100 m, regardless of the number of stations in the chain.

Daisy Chain Installation Diagram

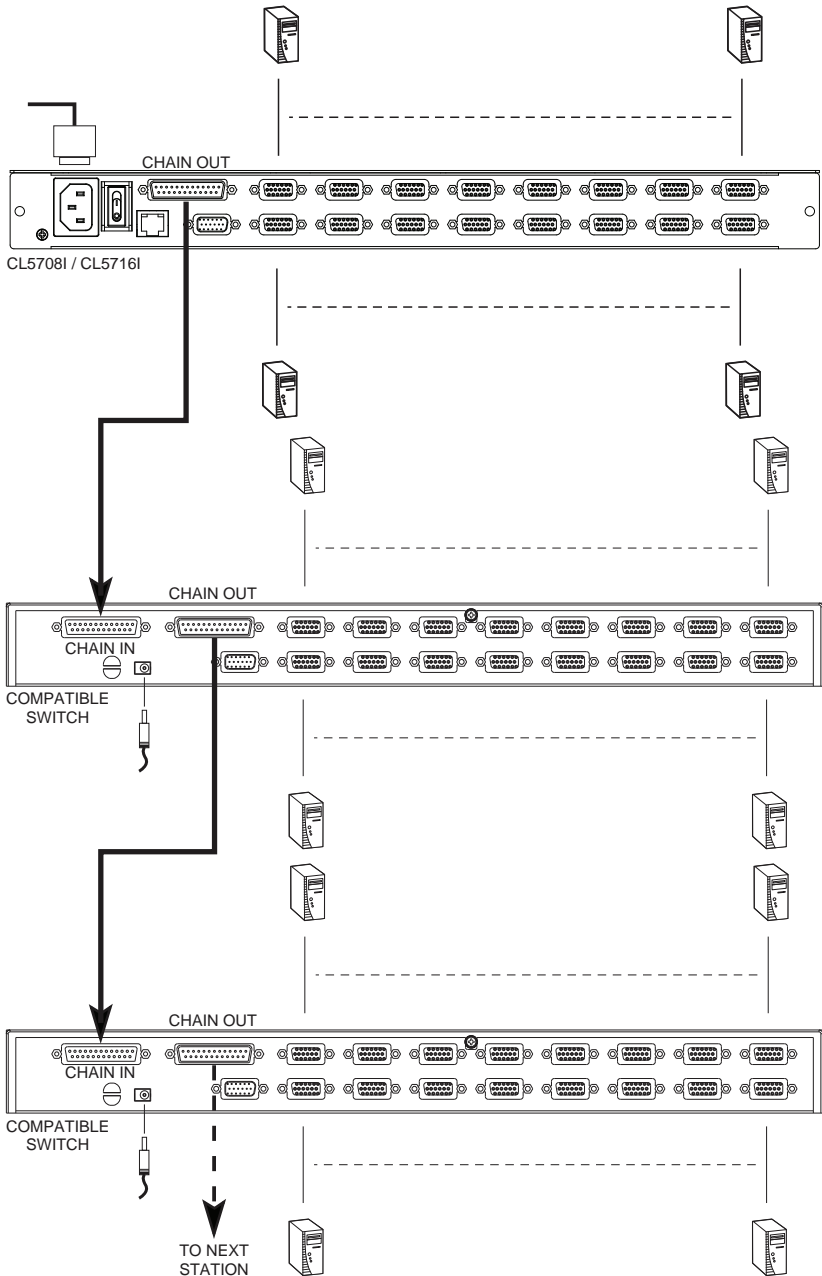

This Page Intentionally Left Blank

Chapter 3

Basic Operation

Opening the Console

The CL5708I / CL5716I's console is located under the top cover. To access the console, slide the console module out and raise the cover.

Note: As a safety precaution, to keep the console from accidentally sliding out, the console is locked into the *In* position. Before you can pull the console module out, you must release it by pushing the catches on the unit's front panel toward the center of the switch.

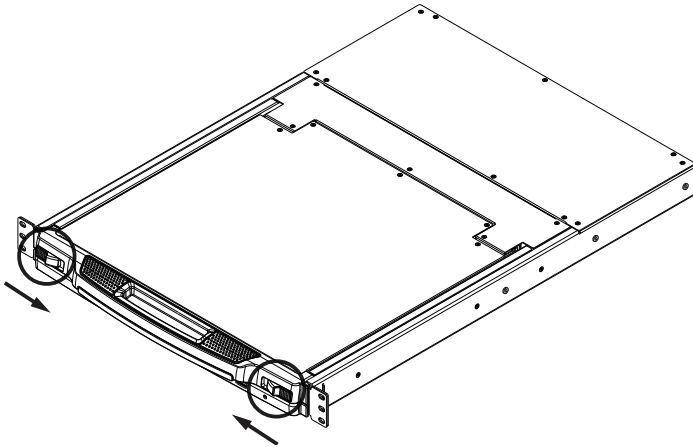

Closing the Console

To slide the console module back in, close the cover and do the following:

1. Pull the safety catches on the unit's side rails toward you and push the module in until it stops.
2. Release the catches; pull the module slightly toward you; then push it all the way in.

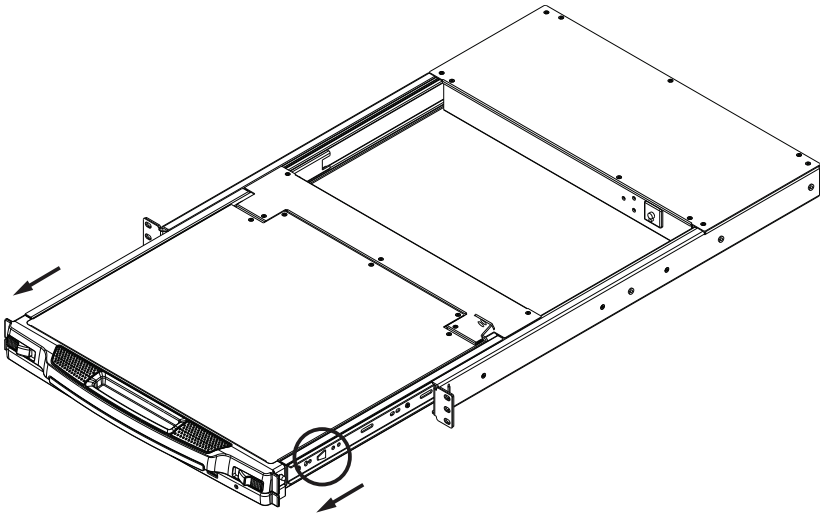

Note: The reason for the two step procedure is to minimize the chances of you pinching your fingers when sliding the module in.

Operating Precautions

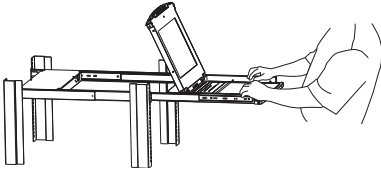
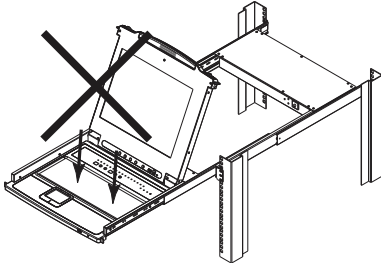

The maximum load bearing capacity of the keyboard module is 30kg. Failure to heed the information below can result in damage to the keyboard module.

	<p>Right!</p> <p>Rest your hands and arms lightly on the keyboard module as you work.</p>
	<p>Wrong!</p> <ul style="list-style-type: none">◆ DO NOT lean your body weight on the keyboard module.◆ DO NOT place heavy objects on the keyboard module.

Powering Off and Restarting

If it becomes necessary to power off the CL5708I / CL5716I, do the following before restarting it:

1. Shut down all the computers that are attached to the CL5708I / CL5716I.

Note: Unplug the power cords of any computers that have the *Keyboard Power On* function. Otherwise, the CL5708I / CL5716I will still receive power from the computers.



2. Unplug the CL5708I / CL5716I from its power source.
3. Wait 10 seconds, then plug the CL5708I / CL5716I back in.
4. After the CL5708I / CL5716I has started and ascertained its station ID, power on the computers.

Note: If you have shut down more than one station, power up the highest station first and work your way down to the lowest one.

LCD OSD Configuration

The LCD Buttons

The LCD OSD allows you to set up and configure the LCD display. Four buttons are used to perform the configuration, as described in the table, below:

Button	Function
MENU	<ul style="list-style-type: none"> ◆ When you have not entered the LCD OSD Menu function, pressing this button invokes the Menu function, and brings up the Main Menu. ◆ When you have entered the LCD OSD Menu function, and have reached a setting choice with the navigation buttons, pressing this button brings up its adjustment screen.
	When navigating through the menus, this button moves you Right or Up. When making an adjustment, it increases the value.
	When navigating through the menus, this button moves you Left or Down. When making an adjustment, it decreases the value.
EXIT	<ul style="list-style-type: none"> ◆ When you have not entered the LCD OSD Menu function, pressing this button performs an auto adjustment. An auto adjustment automatically configures all the settings for the LCD panel to what the OSD considers their optimum values to be. ◆ When you have entered the LCD OSD Menu function, pressing this button exits the current menu and returns you to the previous menu. Use it to leave an adjustment menu when you are satisfied with the adjustment you made. ◆ When you are at the Main Menu, pressing this button exits the LCD OSD. ◆ Pressing the Exit/Light pushbutton for two seconds turns the keyboard illumination light ON or Off. (Default: On)

LCD Adjustment Settings

An explanation of the LCD OSD adjustment settings is given in the table below:

Setting	Explanation
Brightness	Adjusts the background black level of the screen image.
Contrast	Adjusts the foreground white level of the screen image.
Phase	If pixel jitter or horizontal line noise is visible on the display, your LCD may have the wrong phase setting. Adjust the phase setting to eliminate these problems.
Clock	If vertical banding is visible on the display, your LCD may have the wrong clock setting. Adjust the clock setting to eliminate vertical banding.
H-Position	Positions the display area on the LCD panel horizontally (moves the display area left or right).
V-Position	Positions the display area on the LCD panel vertically (moves the display area up or down).
Color Temperature	Adjusts the color quality of the display. You can adjust the warmth value, color balance, etc. The <i>Adjust Color</i> selection has a further submenu that lets you fine tune the RGB values.
Language	Selects the language that the OSD displays its menus in.
OSD Duration	Lets you set the amount of time the OSD displays on the screen. If there is no input for the amount of time you choose, the OSD display turns off.
Reset	Resets the adjustments on all menus and submenus to their factory default settings.

Note: As an alternative to manually adjusting the LCD settings, you can have the LCD auto-adjusted for optimum display by pressing the Exit button. See *EXIT*, page 27

Hot Plugging

The CL5708I / CL5716I supports *hot plugging* - components can be removed and added back into the installation by unplugging their cables from the ports without the need to shut the unit down. In order for hot plugging to work properly, however, the procedures described below must be followed:

Changing Station Positions

You can change a station's position by simply disconnecting it from the previous station it is connected to and reconnecting it to another switch in the chain. In order for the OSD menus to correspond to the change, the station IDs must be reset in the OSD. See *RESET STATION IDS*, page 41, for details.

Hot Plugging KVM Ports

You can add or remove computers by plugging/unplugging them into/from a switch's KVM ports. In order for the OSD menus to correspond to the change, however, you must manually reconfigure the OSD to reflect the new Port information. See *F3: SET*, page 38, and *F4: ADM*, page 40, for details.

Note: If the computer's Operating System does not support hot plugging, this function may not work properly.

Hot Plugging External Console Ports

The external keyboard, monitor, mouse and front panel mouse connections can all be hot plugged. When hot plugging a mouse:

- ◆ You may unplug and replug the mouse (to reset the mouse, for example), as long as you use the same mouse.
- ◆ If you plug in a different mouse, all the stations and all the computers on the installation must be shut down for 10 seconds, then restarted following the power up sequence described under Step 5 on page 20.

Port Selection

The CL5708I / CL5716I provides three port selection methods to access the computers on the installation: Manual, an OSD (on-screen display) menu system, and Hotkeys. Manual port switching is discussed below. See Chapter 4, *OSD Operation* and Chapter 5, *Keyboard Port Operation* for more information.

Manual Port Switching

Use the **UP** and **DOWN** Port ID / Station ID selection buttons located on the keyboard module (page 10) to switch KVM focus to any port on the installation. Continually pressing any button cycles through the list of available ports/stations.

Port ID Numbering

Each KVM port on the installation is assigned a unique Port ID. The Port ID is made up of two parts: a *Station Number*, and a *Port Number*:

- ◆ The *Station Number* is a two digit number of the switch's position in the daisy chain sequence. This number is displayed on the front panel station ID LED.
- ◆ The *Port Number* is a two digit number of the port on the CL5708I / CL5716I station that a computer is connected to. This number is displayed on the front panel port ID LED.
- ◆ When keying in a Port ID number, the station number precedes the port number.
- ◆ Station and port numbers from 1–9 are padded with a preceding zero, so they become 01–09.

For example, a computer attached to **Port 6** of **Station 12** would have a Port ID of: **12-06**.

USB Peripheral Devices

The front panel USB port is available to connect a USB peripheral device (flash drive, CD-ROM drive, printer, etc.) to the CL5708I / CL5716I. Any computer connected to the CL5708I / CL5716I can access the USB peripheral on a one-at-a-time basis. The peripheral device is available to computers connected to the CL5708I / CL5716I on the same level only, and is not available to computers connected to daisy chained switches.

The USB peripheral device is automatically detected on target computers when switching ports on the CL5708I / CL5716I. For example, when switching from a computer connected to port 1 to a computer connected to port 2, the peripheral device automatically disconnects from the computer on port 1 and connects to the computer on port 2.

This Page Intentionally Left Blank

Chapter 4

OSD Operation

OSD Overview

The OSD (on-screen display) is a mouse and keyboard enabled, menu driven method to handle computer control and switching operations. All procedures start from the OSD main screen.

Manufacturing Number

The “MFG Number” (Manufacturing Number) is an internal serial number used by ATEN’s factory and technical support staff to identify products. This number does not affect products’ warranty. If your product requires after-sales services, you may provide the MFG Number to ATEN’s sales or technical support staff to identify the product and model number.

OSD Login

The OSD incorporates a two level (administrator / user) password system. Before the OSD main screen displays, a login screen appears requiring a password. If this is the first time that the OSD is used, or if the password function has not been set, please use default username and password:

Administrator / Password to login. The OSD main screen displays in administrator mode. In this mode, you have administrator privileges, with access to all administrator and user functions, and can set up operations as you like. However, if the password function has been set, you must provide an appropriate administrator/user password in order to access the OSD.

OSD Hotkey

You can display the OSD on the LCD or an external console monitor while also viewing the display of any port on the CL5708I / CL5716I by pressing the **[Scroll Lock]** key twice.

Note: You can optionally change the OSD hotkey to the Ctrl key, in which case you would press **[Ctrl]** twice (see *OSD Hotkey*, page 38). With this method, you must press the same **[Ctrl]** key.

OSD Main Screen

When you invoke the OSD, a screen similar to the one below appears:

```

F1:GOTO F3:SET F5:SKP F7:SCAN
F2:LIST F4:ADM F6:BRC F8:LOUT
ADMINISTRATOR
LIST:ALL
SN--PN QV NAME
001
01 01 ASUS P4P800
02 02 APPLE G5
03 03 SUN BLADE150
04 04 MSI NEO2
05 05 IBM SERVER
06 06 HP G4
07 07 DELL GX620

```

- Note:**
1. The diagram depicts the administrator's main screen. The user main screen does not show the **F4** and **F6** functions, since these are reserved for the administrator and can't be accessed by users.
 2. The OSD always starts in list view, with the highlight bar at the same position it was in the last time it was closed.
 3. Only the ports that have been set accessible by the administrator for the current logged in user are visible (see *Access*, page 119, for details).
 4. If the port list is collapsed, click on a switch number, or move the highlight bar to it then press the right arrow key to expand the list. Similarly, to collapse a switch's port list, click on the switch number, or move the highlight bar to it then press the left arrow key to collapse the list.

OSD Main Screen Headings

The table below describes the OSD Main Screen headings.

Heading	Description
SN--PN	This column lists the port ID numbers (station number - port number) for all the KVM ports on the installation. The simplest method to access a particular computer is move the highlight bar to it, then press [Enter] .
QV	If a port has selected for quick view scanning (see <i>Set Quick View Ports</i> , page 41), an arrowhead displays in this column.
	The computers that are powered on and are online have a sun symbol in this column.
NAME	If a port has been given a name (see <i>Edit Port Names</i> , page 40), its name appears in this column.

OSD Navigation

- ◆ To dismiss the menu, and deactivate OSD, click the **X** at the upper right corner of the OSD window; or press **[Esc]**.
- ◆ To log out, click **F8** at the top of the main screen, or press **[F8]**.
- ◆ To move up or down through the list one line at a time, click the up and down triangle symbols (**▲▼**) or use the up and down arrow keys. If there are more list entries than what can appear on the main screen, the screen will scroll.
- ◆ To move up or down through the list one screen at a time, click the up and down arrow symbols (**↑↓**), or use the **[Pg Up]** and **[Pg Dn]** keys. If there are more list entries than what can appear on the main screen, the screen will scroll.
- ◆ To activate a port, double-click it, or move the highlight bar to it, then press **[Enter]**.
- ◆ After executing any action, you automatically go back to the menu one level above.

OSD Functions

OSD functions are used to configure and control the OSD. For example, you can rapidly switch to any port, scan selected ports, limit the list you wish to view, designate a port as a quick view port, create or edit a port name, or make OSD setting adjustments.

To access an OSD function:

1. Either click a function key field at the top of the main screen, or press a function key on the keyboard.
2. In the submenus that appear make your choice either by double-clicking it, or moving the highlight bar to it, then pressing **[Enter]**.
3. Press **[Esc]** to return to the previous menu level.

F1: GOTO

Clicking the **F1** field or pressing **[F1]** activates the GOTO function. GOTO allows you to switch directly to a port either by keying in the port's *Name*, or its *Port ID*.

- ♦ To use the name method, key in **1**; key in the port's *Name*; then press **[Enter]**.
- ♦ To use the port ID method, key in **2**; key in the *Port ID*; then press **[Enter]**.

Note: You can key in a partial name or port ID. In that case, the screen will show all the computers that the user has *View* rights to (see *Access*, page 119, for details), that match the name or port ID pattern, regardless of the current list settings (see *F2 LIST*, page 37, for details).

To return to the OSD main screen without making a choice, press **[Esc]**.

F2: LIST

This function lets you broaden or narrow the scope of which ports the OSD displays on the main screen. The submenu choices and their meanings are given in the table below.

Choice	Meaning
ALL	Lists all of the ports on the installation that have been set accessible by the administrator for the current logged in user.
QUICK VIEW	Lists only the ports that have been selected as quick view ports (see <i>SET QUICK VIEW PORTS</i> , page 41).
POWERED ON	Lists only the ports that have their attached computers powered on.
QUICK VIEW + POWERED ON	Lists only the ports that have been selected as quick view ports (see <i>SET QUICK VIEW PORTS</i> , page 41), and that have their attached computers powered on.

Move the highlight bar to the choice you want, then press **[Enter]**. An icon appears before the choice to indicate that it is the currently selected one.

F3: SET

This function allows the administrator and each user to set up his own working environment. A separate profile for each is stored by the OSD and is activated according to the username that was provided during login.

To change a setting:

1. Double-click it; or move the highlight bar to it, then press **[Enter]**.
2. After you select an item, a submenu with further choices appears. To make a selection, either double-click it; or move the highlight bar to it, then press **[Enter]**. An icon appears before the selected choice to indicate which one it is. The settings are explained in the following table:

Setting	Function
OSD HOTKEY	Selects which hotkey activates the OSD function: [Scroll Lock] [Scroll Lock] or [Ctrl] [Ctrl] . Since the [Ctrl] key combination may conflict with programs running on the computers, the default is the [Scroll Lock] combination.
PORT ID DISPLAY POSITION	Allows each user to customize the position where the port ID appears on the screen. The default is the upper left corner, but users can choose to have it appear anywhere on the screen. Use the mouse or the arrow keys plus Pg Up, Pg Dn, Home, End, and 5 (on the numeric keypad with Num Lock off), to position the port ID display, then double-click or press [Enter] to lock the position and return to the Set submenu.
PORT ID DISPLAY DURATION	Determines how long a port ID displays on the monitor after a port change has taken place. The choices are: 3 Seconds (default) and ALWAYS OFF .
PORT ID DISPLAY MODE	Selects how the port ID is displayed: the port number plus the port name (PORT NUMBER + PORT NAME) (default); the port number alone (PORT NUMBER); or the port name alone (PORT NAME).
SCAN DURATION;Scan	Determines how long the focus dwells on each port as it cycles through the selected ports in Auto Scan mode (see <i>F7 SCAN</i> , page 45). Key in a value from 1–255 seconds, then press [Enter] . Default is 5 seconds; a setting of 0 disables the SCAN function.

(Continues on next page.)

(Continued from previous page.)

Setting	Function
SCAN-SKIP MODE	<p>Selects which computers will be accessed under skip mode (see <i>F5 SKP</i>, page 43), and Auto Scan mode (see <i>F7 SCAN</i>, page 45). Choices are:</p> <p>ALL - All the ports which have been set accessible (see <i>Access</i>, page 119, for details);</p> <p>QUICK VIEW - Only those ports which have been set accessible and have been selected as quick view ports (see <i>SET QUICK VIEW PORTS</i>, page 41);</p> <p>POWERED ON - Only those ports which have been set accessible and are powered on;</p> <p>QUICK VIEW + POWERED ON - Only those ports which have been set accessible and have been selected as quick view ports and are powered on. The default is ALL.</p> <p>Note: The quick view choices only show up on the administrator's screen, since only he has <i>Quick View</i> setting rights (see <i>SET QUICK VIEW PORTS</i>, page 41, for details).</p>
SCREEN BLANKER	<p>If there is no input from the console for the amount of time set with this function, the screen is blanked. Key in a value from 1–30 minutes, then press [Enter]. The default setting of 0 disables this function.</p>
HOTKEY COMMAND MODE	<p>Enables / disables the hotkey command function in case a conflict occurs with programs running on the computers.</p>
HOTKEY	<p>Sets the keyboard shortcut for invoking <i>Hotkey Mode</i> (see page 47). Choices are: [NUM LOCK] + [-] (minus) (default), and [CTRL] + [F12].</p>
OSD LANGUAGE	<p>Sets the language used in the OSD. Choices are: English, German, Japanese, Simplified Chinese and Traditional Chinese.</p>
TOUCHPAD	<p>Enables / disables the touchpad.</p>

F4: ADM

F4 is an administrator only function. It allows the administrator to configure and control the overall operation of the OSD. To change a setting double-click it, or use the up and down arrow keys to move the highlight bar to it then press **[Enter]**.

After you select an item, a submenu with further choices to select from appears. Double-click an item, or move the highlight bar to it then press **[Enter]**. An icon appears before the selected item so that you know which one it is. The settings are explained in the following table:

Setting	Function
SET IP ADDRESS	<p>Use this selection to set the IP address of the CL57081 / CL57161.</p> <ul style="list-style-type: none"> ◆ Enable DHCP to assign the IP address automatically. ◆ Disable DHCP to assign a fixed IP address and specify the IP, Mask, and Gateway in the appropriate fields. <p>Note: The default setting for DHCP is disabled.</p>
SET LOGOUT TIMEOUT	<p>If there is no input from the console for the amount of time set with this function, the user is automatically logged out. A login is necessary before the console can be used again.</p> <p>This enables other users to gain access to the computers when the original user is no longer accessing them, but has forgotten to log out. To set the timeout value, key in a number from 1–180 minutes, then press [Enter]. The default setting of 0 disables this function.</p>
EDIT PORT NAMES	<p>To help remember which computer is attached to a particular port, every port can be given a name. This function allows the administrator to create, modify, or delete port names. To edit a port name:</p> <ol style="list-style-type: none"> 1. Click the port, or use the navigation keys to move the highlight bar to it, then press [Enter]. 2. Key in the new port name, or modify/delete the old one. The maximum number of characters allowed for the port name is 12. Legal characters include: <ul style="list-style-type: none"> ◆ All alpha characters: A–Z ◆ All numeric characters: 0–9 ◆ * () + : - , ? . / and Space <p>Case does not matter; OSD displays the port name in all capitals no matter how they were keyed in.</p> 3. When you have finished editing, press [Enter] to have the change take effect. To abort the change, press [Esc].

Setting	Function
RESTORE DEFAULT VALUES	This function is used to undo all changes and return the setup to the original factory default settings (see <i>OSD FACTORY DEFAULT SETTINGS</i> , page 239) except for the port name list, username and password information, which are saved.
CLEAR THE NAME LIST	This function clears the port name list.
ACTIVATE BEEPER	Choices are Y (on), or N (off). When activated, the beeper sounds whenever a port is changed; when activating the Auto Scan function (see <i>F7 SCAN</i> , page 45); or an invalid entry is made on an OSD menu. The default is Y .
SET QUICK VIEW PORTS	<p>This function lets the administrator select which ports to include as quick view ports.</p> <ul style="list-style-type: none"> ◆ To select/deselect a port as a quick view port, double-click the port, or use the navigation keys to move the highlight bar to it, then press [Spacebar]. ◆ When a port has been selected as a quick view port, an icon displays in the QV column of the LIST on the main screen. ◆ If one of the quick view options is chosen for the LIST view (see <i>F2 LIST</i>, page 37), only a port that has been selected here will display on the list. ◆ If one of the quick view options is chosen for auto-scanning (see <i>SCAN/SKIP MODE</i>, page 39), only a port that has been selected here will be auto-scanned. <p>The default has no ports selected for quick view.</p>
RESET STATION IDS	<p>If you change the position of one of the stations in the daisy chain, the OSD settings will no longer correspond to the new location. This function directs the OSD to rescan the station positions of the entire installation and updates the OSD so that the OSD station information corresponds to the new physical layout.</p> <p>Note: Only the station numbers get updated. Except for the port names, all administrator settings (such as SET ACCESSIBLE PORTS, SET QUICK VIEW PORTS, etc.) must be input again for all of the computers affected by the change.</p>
SET OPERATING SYSTEM	<p>This function allows the administrator to define the operating system for the computer connected to each KVM port. The default is WIN (PC compatible).</p> <p>To set the port operating system:</p> <ol style="list-style-type: none"> 1. From the list, select the port for which you wish to set the computer's operating system. 2. Set the operating system by pressing [Spacebar] to cycle through WIN, MAC, SUN, or OTHER . 3. Press [Esc] to exit. The operating system you selected is assigned to the KVM port.

Setting	Function
FIRMWARE UPGRADE	<p>In order to upgrade the CL57081 / CL57161 firmware (see page 195), you must first enable Firmware Upgrade mode with this setting.</p> <p>When you bring up this menu, the current firmware version levels are displayed. Select Y to enable Firmware Upgrade mode, or N to leave this menu without enabling it.</p>
SET KEYBOARD LANGUAGE	<p>Sets the language for the computer keyboard attached to the KVM port. To select a keyboard language, double-click it, or use the navigation keys to move the highlight bar to it, then press [Enter].</p> <p>Choices are: AUTO (default), ENGLISH (US), ENGLISH (UK), FRENCH, GERMAN (GER.), GERMAN (SWISS), GREEK, HUNGARIAN, ITALIAN, JAPANESE, KOREAN, RUSSIAN, SPANISH, SWEDISH and TRADITIONAL CHINESE.</p>
SET CONSOLE MODE	<p>This setting selects which consoles (internal/external) are enabled:</p> <ul style="list-style-type: none">0 – Both consoles enabled1 – LCD console only2 – External console only <p>Use the spacebar to cycle to the choice you want. The default is 0.</p>

F5: SKP

Clicking the **F5** field or pressing [**F5**] invokes Skip mode. This function enables you to easily skip backward or forward – switching the console focus from the currently active computer port to the previous or next available one.

- ◆ The selection of computers to be available for skip mode switching is made with the *Scan-Skip* mode setting under the **F3: SET** function (see page 38).
- ◆ When you are in skip mode:
 - press [←] to switch to the previous computer in the list
 - press [→] to switch to the next computer in the list
 - press [↑] to switch to the last computer on the previous station in the list
 - press [↓] to switch to the first computer on the next station in the list.

Note: When you skip, you only skip to the previous or next available computer that is in the *Scan-Skip* mode selection (page 39).

- ◆ If a port has been selected for *Scan-Skip* mode, when the focus switches to that port a left/right triangle symbol appears before its port ID display.
- ◆ While skip mode is in effect, the console will not function normally. You must exit skip mode in order to regain control of the console.
- ◆ To exit skip mode, press [**Spacebar**] or [**Esc**].

F6: BRC

F6 is an administrator only function. Clicking the **F6** field, or pressing **[F6]**, invokes *Broadcast* (BRC) mode. When this function is in effect, commands sent from the console are broadcast to all available computers on the installation.

This function is particularly useful for operations that need to be performed on multiple computers, such as performing a system wide shutdown, installing or upgrading software, etc.

- ◆ While BRC mode is in effect, a speaker symbol appears before the port ID display of the port that currently has the console focus.
- ◆ While BRC mode is in effect, the mouse will not function normally. You must exit BRC mode in order to regain control of the mouse.
- ◆ To exit BRC mode, invoke the OSD (with the OSD hotkey), then click the **F6** field, or press **[F6]**, to turn BRC mode off.

F7: SCAN

Clicking the **F7** field or pressing **[F7]** invokes *Auto Scan* mode. This function allows you to automatically switch among the available computers at regular intervals so that you can monitor their activity without having to take the trouble of switching yourself.

- ◆ The selection of computers to be included for auto-scanning is made with the *Scan-Skip* mode setting under the **F3: SET** function (see page 39).
- ◆ The amount of time that each port displays for is set with the *Scan Duration* setting under the **F3: SET** function (see page 38). When you want to stop at a particular location, press the **[Spacebar]** to stop scanning.
- ◆ If the scanning stops on an empty port, or one where the computer is attached but is powered Off, the monitor screen will be blank, and the mouse and keyboard will have no effect. After the *Scan Duration* time is up, the scan function will move on to the next port.
- ◆ As each computer is accessed, an **S** appears in front of the port ID display to indicate that it is being accessed under *Auto Scan* mode.
- ◆ While *Auto Scan* mode is in effect, the console will not function normally. You must exit *Auto Scan* mode in order to regain control of the console.
- ◆ While you are in *Auto Scan* mode, you can pause the scanning in order to keep the focus on a particular computer either by pressing **[P]**, or with a left-click of the mouse. See *Invoking Auto Scan*, page 51, for details.
- ◆ To exit *Auto Scan* mode, press the **[Spacebar]** or **[Esc]**.

F8: LOUT

Clicking the **F8** field, or pressing **[F8]** logs you out of OSD control of the computers, and blanks the console screen. This is different from simply pressing **[Esc]** when you are at the main screen to deactivate the OSD. With this function you must log in all over again to regain access to the OSD, whereas with **[Esc]**, all you have to do to reenter the OSD is tap the OSD hotkey.

-
- Note:**
1. When you reenter the OSD after logging out, the screen stays blank except for the OSD main screen. You must input your username and password before you can continue.
 2. If you reenter the OSD after logging out, and immediately use **[Esc]** to deactivate the OSD without having selected a port from the OSD menu, a null port message displays on the screen. The OSD hotkey will bring up the main OSD screen.
-

This Page Intentionally Left Blank

Chapter 5

Keyboard Port Operation

Hotkey Port Control

Hotkey port control allows you to provide KVM focus to a particular computer directly from the keyboard. The CL5708I / CL5716I provides the following hotkey port control features:

- ◆ Selecting the Active Port
- ◆ Auto Scan Mode Switching
- ◆ Skip Mode Switching
- ◆ Computer Keyboard / Mouse Reset

The following settings can also be controlled in *Hotkey* mode:

- ◆ Setting the Beeper
- ◆ Setting the Quick Hotkey
- ◆ Setting the OSD Hotkey
- ◆ Setting the Port Operating System
- ◆ Restoring the OSD Default Values

Invoke Hotkey Mode

All hotkey operations begin by invoking *Hotkey* mode.¹ There are two possible keystroke sequences to invoke *Hotkey* mode from the local console, and two alternate keystrokes to invoke *Hokey* mode from remote (WinClient/Java Client) sessions, though only one from each can be operational at any given time:

Local Console

The following operations are used to invoke *Hotkey* mode from the local console while accessing a port:

Number Lock and Minus Keys

1. Hold down the **Num Lock** key;
2. Press and release the **minus** key;
3. Release the **Num Lock** key:

[Num Lock] + [-]

Control and F12 Keys

1. Hold down the **Ctrl** key;
2. Press and release the **F12** key;
3. Release the **Ctrl** key:

[Ctrl] + [F12]

When *Hotkey* mode is active:

- ♦ A command line appears on the monitor screen. The command line prompt is the word *Hotkey:* in white text on a blue background, and displays the subsequent hotkey information that you key in.
- ♦ Ordinary keyboard and mouse functions are suspended – only hotkey compliant keystrokes (described in the sections that follow), can be input.

Pressing [Esc] exits *Hotkey* mode.

1. Make sure that the *Hotkey Command Mode* function is enabled and that you key in the appropriate *Hotkey*. See page 39 for details.

Remote Sessions

The following operations are used to invoke *Hotkey* mode from remote WinClient/Java Client sessions while accessing a port:

Scroll Lock

1. Press **[Scroll Lock] [Scroll Lock]**.

[Scroll Lock] and then [Scroll Lock]

Control

1. Press **[Ctrl] [Ctrl]**.

[Ctrl] and then [Ctrl]

When *Hotkey* mode is active:

- ♦ The toolbar appears at the upper left corner of the screen (see *The Port Toolbar*, page 176).
- ♦ Ordinary keyboard and mouse functions are suspended – only hotkey compliant keystrokes (described in the sections that follow), can be input.

Pressing **[Esc]** exits *Hotkey* mode.

Select the Active Port

Each KVM port is assigned a port ID (see *Port ID Numbering*, page 29). You can directly access any computer on the installation with a hotkey combination that specifies the port ID of the KVM port that a computer is connected to. To access a computer using hotkeys:

1. Invoke hotkey mode with the **[Num Lock] + [-]** or **[Ctrl] + [F12]** combination.

2. Key in the port ID.

The port ID numbers display on the command line as you key them in. If you make a mistake, use **[Backspace]** to erase the wrong number.

3. Press **[Enter]**.

After you press **[Enter]**, the KVM focus switches to the designated computer and you automatically exit hotkey mode.

Note: In hotkey mode, KVM focus will not switch to a port if an invalid switch or port number is entered. The hotkey command line will continue to display on the screen until you enter a valid switch and port number combination, or exit hotkey mode.

Auto Scan Mode

Auto Scan automatically switches, at regular intervals, among all the KVM ports that have been set as accessible under *Scan-Skip Mode*, so that their activity can be monitored automatically. See *Scan-Skip Mode* on page 39 for more information.

Invoking Auto Scan:

To start *Auto Scan*, key in the following Hotkey combination:

1. Invoke hotkey mode with the [**Num Lock**] + [-] or [**Ctrl**] + [**F12**] combination.
2. Press [**A**]. After you press **A**, then [**Enter**], you automatically exit hotkey mode, and enter *Auto Scan* mode.

- ♦ While you are in *Auto Scan* mode, you can pause the scanning in order to keep the focus on a particular computer either by pressing **P** or with a left click of the mouse. During the time that auto-scanning is paused, the command line displays: **Auto Scan: Paused**.

Pausing when you want to keep the focus on a particular computer is more convenient than exiting *Auto Scan* mode because when you resume scanning, you start from where you left off. If, on the other hand, you exited and restarted, scanning would start over from the very first computer on the installation.

To resume Auto Scanning, press any key or left-click. Scanning continues from where it left off.

- ♦ While *Auto Scan* mode is in effect, ordinary keyboard and mouse functions are suspended – only *Auto Scan* mode compliant keystrokes and mouse clicks can be input. You must exit *Auto Scan* mode in order to regain normal control of the console.
3. To exit *Auto Scan* mode press [**Esc**] or [**Spacebar**]. Auto-scanning stops when you exit *Auto Scan* mode.

Skip Mode

This feature allows you to switch between computers in order to monitor them manually. You can dwell on a particular port for as long as you like – as opposed to auto-scanning, which automatically switches after a fixed interval. To invoke *Skip* mode, key in the following hotkey combination:

1. Invoke hotkey mode with the **[Num Lock] + [-]** or **[Ctrl] + [F12]** combination.
2. Key in **[Arrow]**
 - ◆ Where **[Arrow]** refers to one of the arrow keys. After you press an arrow, you automatically exit hotkey mode and enter *Skip* mode where you can switch ports as follows:

←	Skips to the first accessible port. (See <i>Scan/Skip Mode</i> , page 39, for information regarding accessible ports.)
→	Skips to the next accessible port.
↑	Skips to the last accessible port of the previous station.
↓	Skips to the first accessible port of the next station.

- ◆ Once you are in *Skip* mode, you can keep on skipping by pressing the arrow keys. You don't have to use the **[Num Lock] + [-]** combination again.
 - ◆ While *Skip* mode is in effect, ordinary keyboard and mouse functions are suspended – only *Skip* mode compliant keystrokes can be input. You must exit *Skip* mode in order to regain normal control of the console.
3. To exit *Skip* mode, press **[Esc]** or **[Spacebar]**.

Computer Keyboard / Mouse Reset

If the keyboard or mouse cease to function on the computer connected to the currently selected port, you can perform a keyboard / mouse reset on the computer. This function is essentially the same as unplugging and replugging the keyboard and mouse on the target computer. To perform a computer keyboard / mouse reset, key in the following hotkey combination:

1. Invoke hotkey mode with the **[Num Lock] + [-]** or **[Ctrl] + [F12]** combination.
2. Press **[F5]**.

After you press [F5] you automatically exit *Hotkey* mode and regain keyboard and mouse control on the computer connected to the KVM port. If you fail to regain keyboard / mouse control on the computer after pressing [F5], perform a system reset. For more information see *reset button*, page 10.

Hotkey Beeper Control

The beeper (see *Activate Beeper*, page 41) can be hotkey toggled on and off. To toggle the beeper, key in the following hotkey combination:

1. Invoke hotkey mode with the **[Num Lock] + [-]** or **[Ctrl] + [F12]** combination.
2. Press **[B]**.

After you press [B], the beeper toggles on or off. The command line displays *Beeper On* or *Beeper Off* for one second; then the message disappears and you automatically exit hotkey mode.

Quick Hotkey Control

The *Quick Hotkey* (see *HOTKEY*, page 39) can be toggled between [Num Lock] + [-], and [Ctrl] + [F12]. To toggle the *Quick Hotkey*:

1. Invoke hotkey mode with the [Num Lock] + [-] or [Ctrl] + [F12] combination.
2. Press [H].

After you press [H], the command line displays *HOTKEY HAS BEEN CHANGED* for one second; then the message disappears and you automatically exit *Hotkey* mode.

OSD Hotkey Control

The *OSD Hotkey* (see *OSD HOTKEY*, page 38) can be toggled between [Scroll Lock], [Scroll Lock] and [Ctrl], [Ctrl]. To toggle the *OSD Hotkey*, key in the following hotkey combination:

1. Invoke hotkey mode with the [Num Lock] + [-] or [Ctrl] + [F12] combination.
2. Press [T].

After you press [T], the command line displays *HOTKEY HAS BEEN CHANGED* for one second; then the message disappears and you automatically exit *Hotkey* mode.

Port OS Control

A port's operating system can be changed to match that of the computer attached to the port. To change a port's operating system, key in the following hotkey combination:

1. Invoke hotkey mode with the **[Num Lock] + [-]** or **[Ctrl] + [F12]** combination.
2. Key in **[Function]**, where [Function] refers to one of the function keys in the following table:

Key	Description
F1	Sets the Port OS to Windows
F2	Sets the Port OS to Mac
F3	Sets the Port OS to Sun

After pressing a function key you automatically exit *Hotkey* mode.

Set USB Speed

Users can use hotkeys to set the USB speed of the selected KVM port to low/full speed to comply with the connected computers.

1. Invoke Hotkey mode (see *Invoke Hotkey Mode* on page 48).
2. Press **[F11]**
3. Key in **[Function]**, where [Function] refers to one of the function keys in the following table:

Key	Description
L	Set the KVM port to low speed USB
F	Set the KVM port to full speed USB

4. Press **[Enter]**.

To set all KVM ports of the selected KVM station, add an [A] after the function key: Under Hotkey mode, press **[F11][L][A][Enter]** or **[F11][F][A][Enter]**.

Restore Default Values

This administrator only hotkey restores the CL5708I / CL5716I default values. See *RESTORE DEFAULT VALUES*, page 41. To restore the default values, key in the following hotkey combination:

1. Invoke hotkey mode with the [**Num Lock**] + [-] or [**Ctrl**] + [**F12**] combination.
2. Press [**R**].
3. Press [**Enter**].

After you press [Enter], the command line displays *RESET TO DEFAULT SETTING* for three seconds; then the message disappears and you automatically exit *Hotkey* mode.

Hotkey Summary Table

[Num Lock] + [-]	[A] [Enter]	Invokes <i>Auto Scan</i> mode.
	or [Q] [Enter]	When <i>Auto Scan</i> mode is in effect, [P] or left-click pauses auto-scanning. When auto-scanning is paused, pressing any key or another left-click resumes auto-scanning.
or [Ctrl] + [F12]	[B]	Toggles the beeper on or off.
	[Esc] or [Spacebar]	Exits hotkey mode.
	[F1]	Set Operating System to Windows
	[F2]	Set Operating System to Mac
	[F3]	Set Operating System to Sun
	[F5]	Performs a keyboard / mouse reset on the target computer.
	[H]	Toggles the <i>Quick Hotkey</i> invocation keys between [Ctrl] + [F12] and [Num Lock] + [-].
	[R] [Enter]	This administrator only hotkey restores the switch's default values. See <i>RESTORE DEFAULT VALUES</i> , page 41.
	[SN]-[PN] [Enter]	Switches access to the computer that corresponds to that port ID. SN= Switch Number; PN= Port Number Example: 01-04 [Enter] (on switch 01 change to port 04) You must key in "-" between SN and PN. Note: See <i>Port ID Numbering</i> , page 30 for details.
	[F11] [F] [Enter]	Set the selected KVM port to full speed USB
	[F11] [L] [Enter]	Set the selected KVM port to low speed USB
	[F11] [F] [A] [Enter]	Set the selected KVM station to full speed USB
	[F11] [L] [A] [Enter]	Set the selected KVM station to low speed USB
	[T]	Toggles the <i>OSD Hotkey</i> between [Ctrl] [Ctrl] and [Scroll Lock] [Scroll Lock].
	[←]	Invokes <i>Skip</i> mode and skips from the current port to the first accessible port previous to it.
	[→]	Invokes <i>Skip</i> mode and skips from the current port to the next accessible port.
	[↑]	Invokes <i>Skip</i> mode and skips from the current port to the last accessible port of the previous station.
	[↓]	Invokes <i>Skip</i> mode and skips from the current port to the first accessible port of the next station.

This Page Intentionally Left Blank

Chapter 6

Logging In

Overview

KVM over IP switches can be accessed from an Internet browser; a Windows application (AP) program; and a Java application (AP) program.

No matter which access method you choose, the KVM over IP switch's authentication procedure requires you to submit a valid username and password. If you supply invalid login information, the authentication routine will return an *Invalid Username or Password*, or *Login Failed* message. If you see this type of message, log in again with a correct username and password.

Note: If the number of invalid login attempts exceeds a specified amount, a timeout period is invoked. You must wait until the timeout period expires before you can attempt to log in again. See *Login Failures*, page 147 for further details.

Browser Login

KVM over IP switches can be accessed via an Internet browser running on any platform. To access the switch, do the following:

1. Open the browser and specify the IP address of the switch you want to access in the browser's location bar.

Note: For security purposes, a login string may have been set by the administrator (see page 151 for details). If so, you must include a forward slash and the login string along with the IP address when you log in. For example:

192.168.0.100/c15708i

If you don't know the IP address and login string, ask your Administrator.

2. When a Security *Alert* dialog box appears, accept the certificate – it can be trusted. (See *Trusted Certificates*, page 233, for details.) If a second certificate appears, accept it as well.

Once you accept the certificate(s), the login page appears:

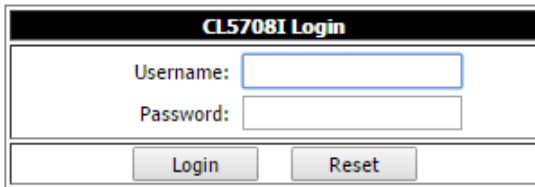

The screenshot shows a web browser window displaying the login page for a CL5708I switch. The page has a black header with the text "CL5708I Login" in white. Below the header, there are two input fields: "Username:" and "Password:". At the bottom of the page, there are two buttons: "Login" and "Reset".

3. Provide your username and password (set by the administrator), then click **Login** to bring up the Web Main Page. For a discussion of the Web Main Page, see page 69.

Note: If you are the administrator and are logging in for the first time, use the default username (*administrator*) and the default password (*password*). For security purposes, the system will prompt you to change the login password. The password must be different from your login password.

Windows Client AP Login

In some cases, the Administrator may not want the KVM over IP switch to be available via browser access. The Windows AP Client allows direct remote access to Windows systems users, without having to go through a browser (although you initially download the Windows AP Client program from the browser page – see Chapter 13, *Download*).

To connect to the KVM over IP switch, go to the location on your hard disk that you downloaded the Windows AP Client program to, and double-click its icon (*WinClient.exe*) to bring up the Windows Client Connection Screen:

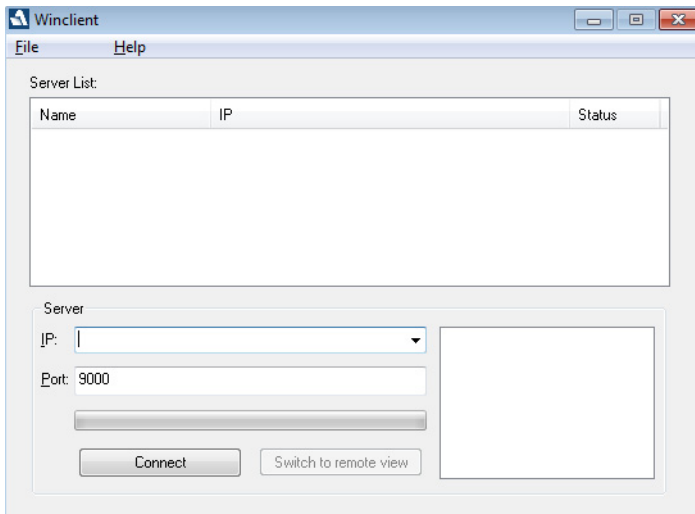

The Windows Client AP Connection Screen

A description of the Connection Screen is given in the following table:

Item	Description
Menu Bar	<p>The Menu Bar contains two items: File and Help.</p> <ul style="list-style-type: none"> ◆ The <i>File Menu</i> allows the operator to Create, Save, and Open user created Work files (see <i>The File Menu</i>, page 64). ◆ The <i>Help Menu</i> displays the WinClient AP version.
Server List	<p>Each time the WinClient.exe file is run, it searches the user's local LAN segment for KVM over IP switches, and lists whichever ones it finds in this box. If you want to connect to one of these units, double-click it. (See <i>Connecting – Windows Client AP</i>, page 63 for details.)</p> <p>Note:</p> <ol style="list-style-type: none"> 1. The switch will not appear in the list unless its <i>Enable Device List</i> configuration parameter has been enabled. See <i>Operating Mode</i>, page 138 for details. 2. Only units whose Access Port settings for <i>Program</i> (see <i>Service Ports</i>, page 140) match the number specified for <i>Port</i> in the Server area of this dialog box appear in the Server List window.
Server	<p>This area is used when you want to connect to a KVM over IP switch at a remote location. You can drop down the IP list box and select an address from the list. If the address you want isn't listed, you can key in the target IP address in the IP field, and its port number in the Port field. (If you don't know the port number, contact your Administrator.)</p> <ul style="list-style-type: none"> ◆ When the IP address and Port number have been specified, click Connect. (See <i>Connecting – Windows Client AP</i>, page 63 for details.) ◆ When you have finished with your session and come back to this dialog box, click Disconnect to end the connection.
Message Panel	<p>Located just to the right of the Server panel, the Message panel lists status messages regarding the connection to the KVM over IP switch.</p>
Switch to Remote View	<p>Once you have been authenticated (see <i>Connecting – Windows Client AP</i>, page 63 for details), this button becomes active. Click it to switch to the GUI Main Page. The GUI Main Page is described on page 72.</p>

Connecting – Windows Client AP

To connect to a KVM over IP switch do the following:

1. From the *Server List* box, **double-click** the device that you wish to connect to.
– Or –
Specify its IP address and port number in the *Server IP* and *Port* input boxes.

2. Click **Connect**.

The *Login* dialog box appears:

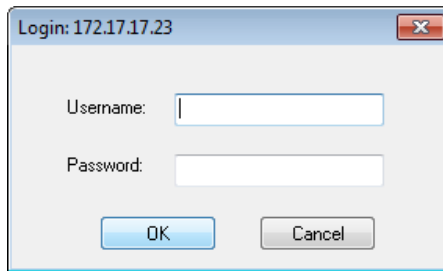

3. Key in a valid Username and Password, and then click **OK**.
4. Once you have been authenticated, the *Switch to Remote View* button becomes active. Click it to connect to the switch and bring up its GUI Main Page. For a description of the GUI Main Page, see page 48.

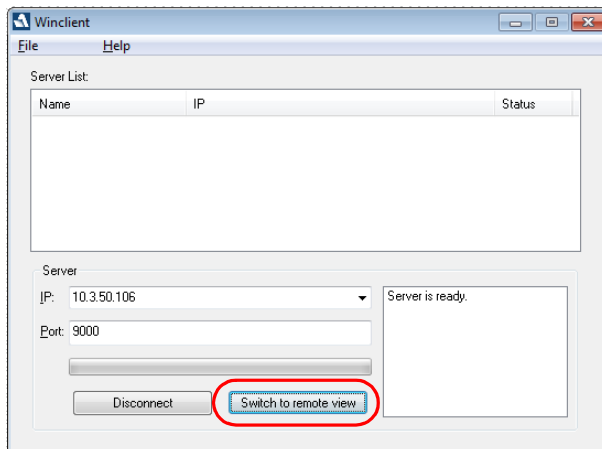

The File Menu

The *File Menu* allows the operator to Create, Save, and Open user created Work files. A Work File consists of all the information specified in a Client session. This includes the Server List and Server IP list items, as well as the Hotkey settings.

Whenever a user runs the Client program, it opens with the values contained in the *current work file*. The current work file consists of the values that were in effect the last time the program was closed.

The File menu consists of the following items:

New	Allows the user to create a named work file so its values will not be lost, and it will be available for future recall.
Open	Allows the user to open a previously saved work file and use the values contained in it.
Save	Allows the user to save the values presently in effect as the <i>current work file</i> .
Exit	Exits the WinClient.

Java Client AP Login

In those cases in which the Administrator does not want the KVM over IP switch to be available via browser access, but the local client users aren't running Windows, the Java AP Client provides direct remote access to non-Windows systems users (although you initially download the Java AP Client program from the browser page – see Chapter 13, *Download*).

To connect to the KVM over IP switch, go to the location on your hard disk that you downloaded the Java AP Client program to, and double-click its icon (*JavaClient.jar*) to bring up the Java Client Connection Screen:

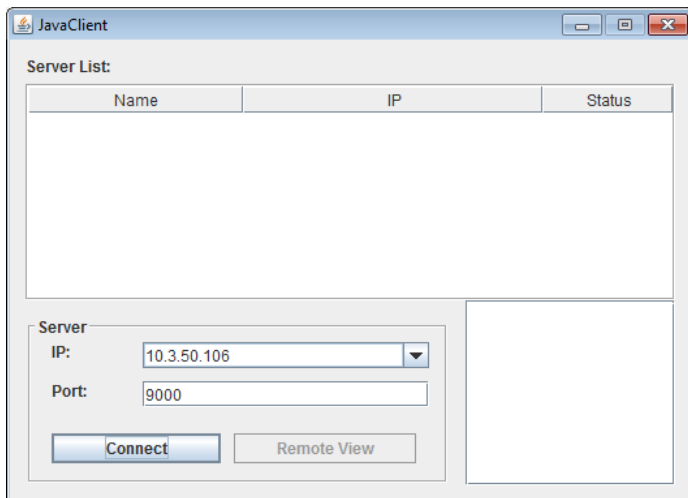

The Java Client AP Connection Screen

A description of the Connection Screen is given in the following table:

Item	Description
Server List	<p>Each time the JavaClient.jar file is run, it searches the User's local LAN segment for KVM over IP switches, and lists whichever ones it finds in this box. If you want to connect to one of these units, double-click it. (See <i>Connecting – Windows Client AP</i>, page 63 for details.)</p> <p>Note:</p> <ol style="list-style-type: none"> 1. The switch will not appear in the list unless its <i>Enable Device List</i> configuration parameter has been enabled. See <i>Operating Mode</i>, page 138 for details. 2. Only units whose Access Port settings for <i>Program</i> (see <i>Service Ports</i>, page 140) match the number specified for <i>Port</i> in the Server area of this dialog box appear in the Server List window.
Server	<p>This area is used when you want to connect to a KVM over IP switch at a remote location. You can drop down the IP list box and select an address from the list. If the address you want isn't listed, you can key in the target IP address in the IP field, and its port number in the Port field. (If you don't know the port number, contact your Administrator.)</p> <ul style="list-style-type: none"> ◆ When the IP address and Port number have been specified, click Connect. (See <i>Connecting – Windows Client AP</i>, page 63 for details.) ◆ When you have finished with your session and come back to this dialog box, click Disconnect to end the connection.
Message Panel	<p>Located just to the right of the Server panel, the Message panel lists status messages regarding the connection to the KVM over IP switch.</p>
Switch to Remote View	<p>Once you have been authenticated (see <i>Connecting – Windows Client AP</i>, page 63 for details), this button becomes active. Click it to switch to the GUI Main Page. The GUI Main Page is described on page 72.</p>

Connecting – Java Client AP

To connect to a KVM over IP switch do the following::

1. From the *Server List* box, **double-click** the device that you wish to connect to.
– Or –
Specify its IP address and port number in the *Server IP* and *Port* input boxes.

2. Click **Login**

The *Login* dialog box appears:

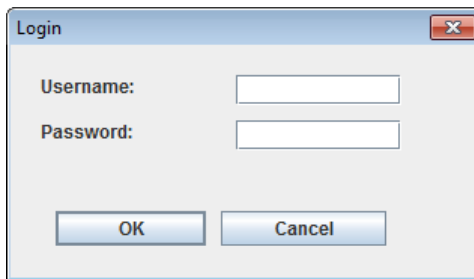

A screenshot of a 'Login' dialog box. It has a title bar with the text 'Login' and a close button. The dialog contains two input fields: 'Username:' and 'Password:'. Below the input fields are two buttons: 'OK' and 'Cancel'.

3. Key in a valid Username and Password, and then click **OK**.
4. Once you have been authenticated, the *Remote View* button becomes active. Click it to connect to the switch and bring up its GUI Main Page.
For a description of the GUI Main Page, see page 48.

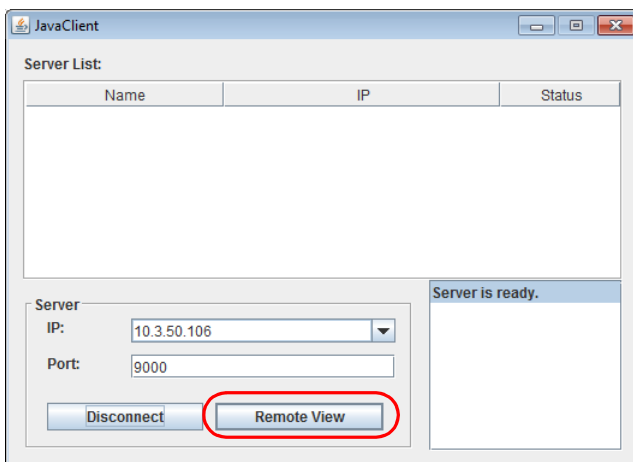

A screenshot of the 'JavaClient' application window. The window title is 'JavaClient'. It features a 'Server List' table with columns for 'Name', 'IP', and 'Status'. Below the table, there is a 'Server' section with 'IP:' and 'Port:' labels and corresponding input fields. The 'IP' field contains '10.3.50.106' and the 'Port' field contains '9000'. There are two buttons: 'Disconnect' and 'Remote View'. The 'Remote View' button is circled in red. On the right side of the window, there is a status area that says 'Server is ready.'

This Page Intentionally Left Blank

Chapter 7

The User Interface

Overview

Once you have successfully logged in, the KVM over IP switch's user interface Main Page appears. The look of the page varies slightly, depending on which method you used to log in. Each of the interfaces is described in the sections that follow.

The Web Browser Main Page

To ensure multi-platform interoperability, access to the KVM over IP switches can be accomplished with most standard web browsers. Once users log in and are authenticated (see page 59), the *Web Browser Main Page* comes up, with the Port Access page displayed:

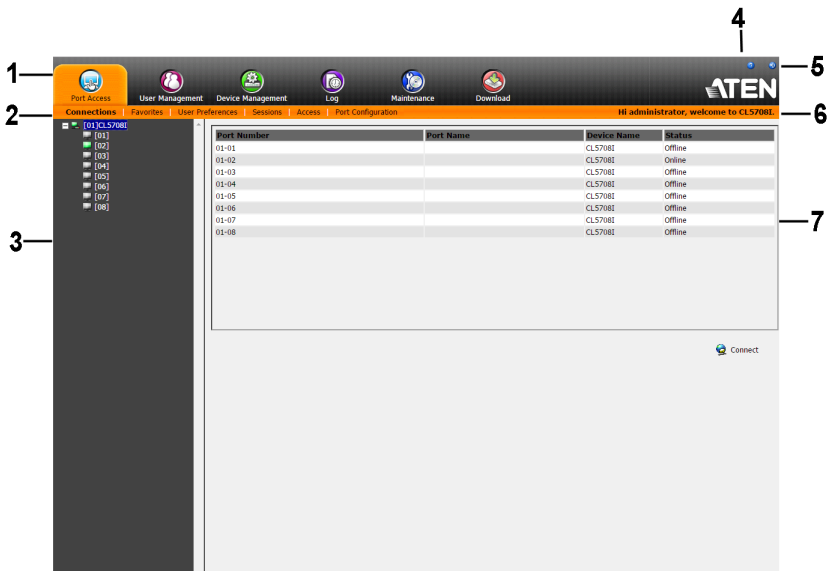

Note: The screen depicts a Super Administrator's page. Depending on a user's type and permissions, not all of these elements appear.







Page Components

The web page screen components are described in the table, below:



No.	Item	Description
1	Tab Bar	The tab bar contains the KVM over IP switch's main operation categories. The items that appear in the tab bar are determined by the user's type, and the authorization options that were selected when the user's account was created.
2	Menu Bar	The menu bar contains operational sub-categories that pertain to the item selected in the tab bar. The items that appear in the menu bar are determined by the user's type, and the authorization options that were selected when the user's account was created.
3	Sidebar	<p>The Sidebar provides a tree view listing of ports that relate to the various tab bar and menu bar selections. Clicking a node in the Sidebar brings up a page with the details that are relevant to it.</p> <p>There is a <i>Filter</i> button at the bottom of the Sidebar that lets you expand or narrow the scope of the ports that appear in the tree. The Filter function is discussed in detail on page 107</p>
4	About	About provides information regarding the switch's current firmware version.
5	Logout	Click this button to log out of your KVM over IP switch session.
6	Welcome Message	If this function is enabled (see <i>Welcome Message*</i> , page 117), a welcome message displays here.
7	Interactive Display Panel	This is your main work area. The screens that appear reflect your menu choices and Sidebar node selection.

The Tab Bar

The number and type of icons that appear on the Tab Bar at the top of the page are determined by the user's type (Super Administrator, Administrator, User) and the permissions assigned when the user's account was created. The functions associated with each of the icons are explained in the table below:

Icon	Function
	Port Access: The Port Access page is used to access and control the devices on the KVM over IP switch installation. This page is available to all users.
	User Management: The User Management page is used to create and manage Users and Groups. It can also be used to assign devices to them. User Management is discussed on page 127. This tab is available to the Super Administrator, as well as administrators and users who have been given User Management permission.
	Device Management: The Device Management page is used to configure and control the overall operation of the KVM over IP switch. This page is available to the Super Administrator, as well as administrators and users who have been given Device Management permission.
	Log: The Log page displays the contents of the log file. The Log page is discussed on page 161.
	Maintenance: The Maintenance page is used to install new firmware; backup and restore configuration and account information; ping network devices; and restore default values. The Maintenance page is discussed on page 165. This page is available to the Super Administrator (and Administrators and Users with <i>Maintenance</i> permission).
	Download: Users can click this icon to download AP versions of the Windows Client; the Java Client; and the Log Server. This page is available to all users. The programs that can be downloaded depend on the user's permissions.

There are two small icons at the extreme right of the page. Their functions are described in the table, below:

Icon	Function
	Click this icon to bring up a panel with information about the KVM over IP switch firmware version.
	Click this icon to log out and end your KVM over IP switch session.

The AP GUI Main Page

With WinClient AP, and Java Client AP access, once users log in (see *Logging In*, page 59), the *GUI Main Page* comes up:

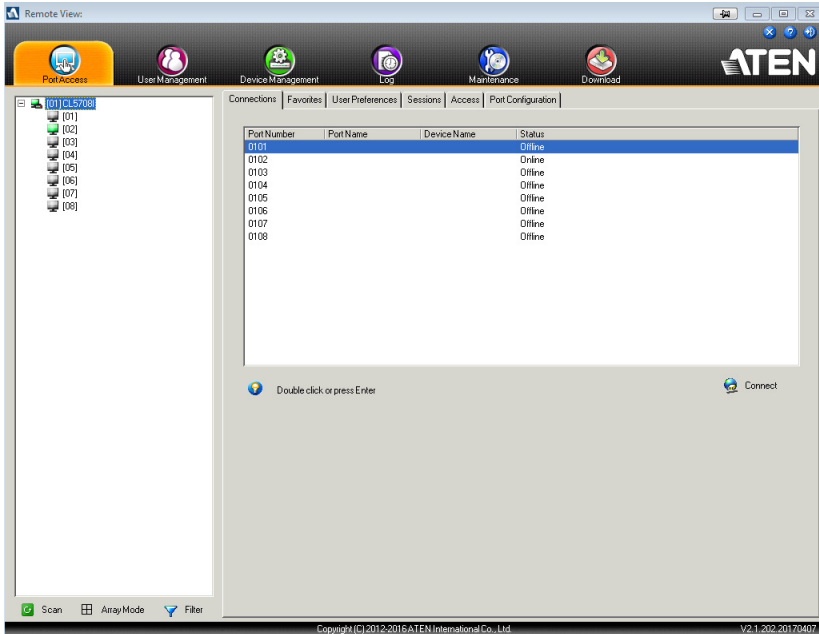

The GUI Main Page is similar to that of the Web Browser. The differences between them are as follows:

1. The AP GUI version doesn't have a menu bar below the tab bar; it has a series of tabs like a notebook, instead. Like the Web Browser interface, however, the makeup of the tabbed notebook changes depending on the items selected on the main Tab Bar and in the Sidebar.
2. In addition to *Filter*, there are also buttons for *Scan* and *Array Mode* at the bottom of the Sidebar. These functions are discussed in Chapter 8, *Port Access*.
3. There is a hidden *Control Panel* at the upper or lower center of the screen that becomes visible when you mouse over it. The default is at the upper center of the screen.

4. There is an additional icon at the extreme right of the page: . Click this icon to close the GUI Main Page and go to the display of the last selected port.
5. The GUI can be navigated via the keyboard as shown in the table, below:

Keys	Action
Ctrl + P	Opens the Port Access page.
Ctrl + U	Opens the User Management page.
Ctrl + C	Opens the Device Management page.
Ctrl + L	Opens the Log page.
Ctrl + M	Opens the Maintenance page.
Ctrl + D	Opens the Download page.
F1	To see <i>About</i> information.
F2	To edit the port name of the selected port.
F4	Selects the Sidebar (left) panel.
F5	Selects the main (right) panel.
F7	Closes the GUI.
F8	To log out.

The Control Panel

WinClient Control Panel

Since the WinClient Control Panel (for the ActiveX Web Viewer and WinClient AP) contains the most complete functionality, this section describes the WinClient Control Panel. Although the Java Control Panel (for the Web Viewer and Java Client AP) does not enable all of the features that this one does, the functions that they do share are the same, and you can refer to the information described here when using it.

The Control Panel is hidden at the upper or lower center of the screen (the default is at the upper center), and becomes visible when you mouse over it. The panel consists of three rows: an icon row at the top, and two text rows below it:

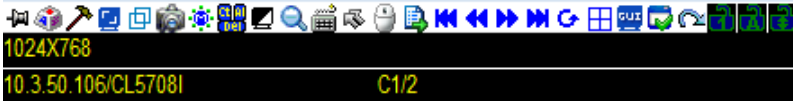

Note: The above image shows the complete Control Panel. The icons that appear can be user selected. See *Control Panel Configuration*, page 99, for details.

- ♦ By default, the upper text row shows the video resolution of the remote display. As the mouse pointer moves over the icons in the icon bar, however, the information in the upper text row changes to describe the icon's function. In addition, if a message from another user is entered in the message board, and you have not opened the message board in your session, the message will appear in the upper row.
- ♦ The lower row shows the IP address of the device you are accessing at the left of the row.
- ♦ The bus and user information in the center of the lower row only displays if it has been enabled (See *Bus Info*, page 100 for details). In the image above C1/2 means that bus number 1 has 2 users connected.



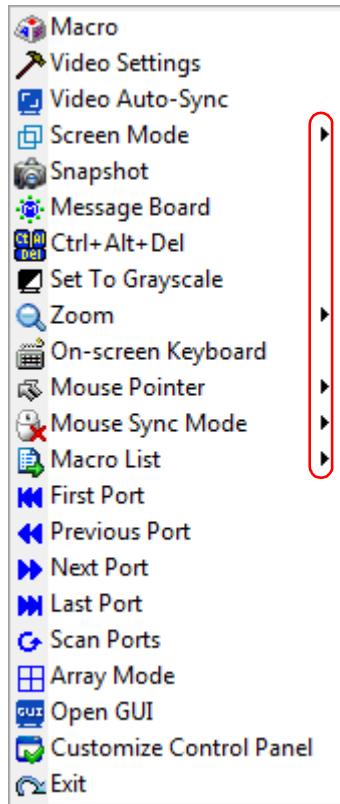









- ◆ Right clicking in the text row area brings up a menu-style version of the toolbar. In addition, it allows you to select options for the *Screen Mode*, *Zoom*, *Mouse Pointer*, *Mouse Sync Mode* and *Marco List* (Macro List appears after a user macro is created). These functions are discussed in the sections that follow.













- ◆ To move the Control Panel to a different location on the screen, place the mouse pointer over the text row area, then click and drag.

WinClient Control Panel Functions

The Control Panel functions are described in the table below.

Icon	Function
	This is a toggle. Click to make the Control Panel persistent – i.e., it always displays on top of other screen elements. Click again to have it display normally.
	Click to bring up the Macros dialog box (see page 79 for details).
	Click to bring up the Video Options dialog box. Right-click to perform a quick Auto Sync (see <i>Video Settings</i> , page 85, for details).
	Click to perform a video and mouse autosync operation. It is the same as clicking the Auto Sync button in the <i>Video Options</i> dialog box (see <i>Video Settings</i> , page 85).
	Toggles the display between <i>Full Screen Mode</i> and <i>Windowed Mode</i> .
	Click to take a snapshot (screen capture) of the remote display. See <i>Snapshot</i> , page 100, for details on configuring the Snapshot parameters.
	Click to bring up the Message Board (see <i>The Message Board</i> , page 90).
	Click to send a Ctrl+Alt+Del signal to the remote system.
	Click to toggle the remote display between color and grayscale views.
	Click to zoom the remote display window. Note: This feature is only available in windowed mode (Full Screen Mode is off). See <i>Zoom</i> , page 93 for details.
	Click to bring up the on-screen keyboard (see <i>The On-Screen Keyboard</i> , page 94).
	Click to select the mouse pointer type. Note: This icon changes depending on which mouse pointer type is selected (see <i>Mouse Pointer Type</i> , page 96).

	<p>Click to toggle Automatic or Manual mouse sync.</p> <ul style="list-style-type: none"> ◆ When the selection is <i>Automatic</i>, a green √ appears on the icon. ◆ When the selection is <i>Manual</i>, a red X appears on the icon. <p>See <i>Mouse DynaSync Mode</i>, page 97 for a complete explanation of this feature.</p>
	<p>Click to display a dropdown list of <i>User</i> macros in order to access and run macros more conveniently than using the Macros dialog box (see the <i>Macros</i> icon in the table above, and the <i>Macros</i> section on page 79).</p>
	<p>Under an accessed port, click to skip to the first port accessible to the user on the entire installation without having to recall the Port Access page.</p>
	<p>Under an accessed port, click to skip to the first port accessible to the user that is previous to the current one without having to recall the Port Access page.</p>
	<p>Under an accessed port, click to skip to the first port accessible to the user that is after the current one without having to recall the Port Access page.</p>
	<p>Under an accessed port, click to skip to the last port accessible to the user on the entire installation without having to recall the Port Access page.</p>
	<p>Under an accessed port, click to begin Auto Scan Mode. The KVM over IP switch automatically switches among the ports that were selected for Auto Scanning with the <i>Filter</i> function (see <i>Filter</i>, page 107). This allows you to monitor their activity without having to switch among them manually.</p>
	<p>Under an accessed port, click to invoke Panel Array Mode (see <i>Panel Array Mode</i>, page 181).</p>
	<p>Under an accessed port, click to recall the GUI.</p>
	<p>Click to bring up the Control Panel Configuration dialog box. See <i>Control Panel Configuration</i>, page 99, for details on configuring the Control Panel.</p>
	<p>Click to exit the viewer.</p> <ul style="list-style-type: none"> ◆ Exiting from a Browser Viewer session brings you back to the web browser Main Page. ◆ Exiting from a WinClient AP session brings you back to the login dialog box (see page 61). ◆ Exiting from a Java Client AP session brings you back to the login dialog box (see page 65).



These icons show the Num Lock, Caps Lock, and Scroll Lock status of the remote computer.

- ◆ When the lock state is *On*, the LED is bright green and the lock hasp is closed.
- ◆ When the lock state is *Off*, the LED is dull green and the lock hasp is open.

Click on the icon to toggle the status.

Note: These icons and your local keyboard icons are in sync. Clicking an icon causes the corresponding LED on your keyboard to change accordingly. Likewise, pressing a Lock key on your keyboard causes the icon's color to change accordingly.



Macros

The Macros icon provides access to two functions found in the Macros dialog box: Hotkeys and User Macros. Each of these functions is described in the following sections.

Hotkeys

Various actions related to manipulating the remote server can be accomplished with hotkeys. The *Hotkey Setup* utility (accessed by clicking this icon), lets you configure which hotkeys perform the actions.

The hotkeys that invoke an action are shown to the right of its name. Use the checkbox to the left of an action's name to enable or disable its hotkey.

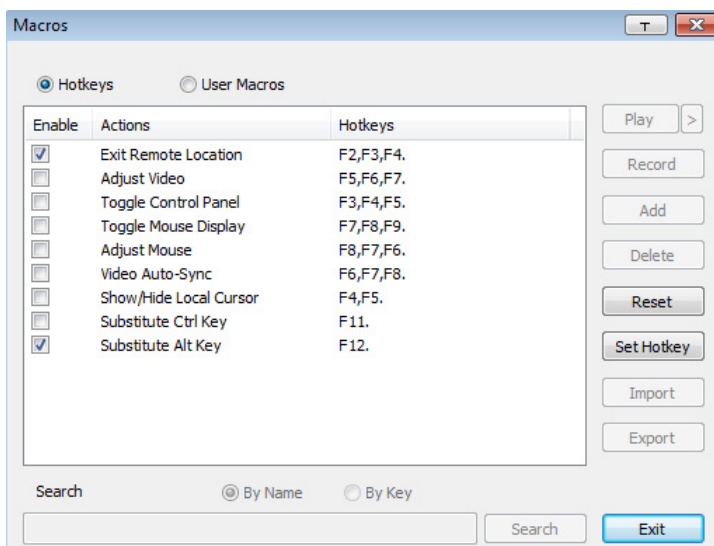

To change the hotkey for an action, do the following:

1. Highlight the *Name*, then click **Set Hotkey**.
2. Press your selected Function keys (one at a time). The key names appear in the *Hotkeys* field as you press them.
 - ◆ You can use the same function keys for more than one action, as long as the key sequence is not the same.
 - ◆ To cancel setting a hotkey value, click **Cancel**; to clear an action's Hotkeys field, click **Clear**.
3. When you have finished keying in your sequence, click **Save**.

To reset all the hotkeys to their default values, click **Reset**.

An explanation of the Hotkey actions is given in the table below:

Action	Explanation
Exit Remote Location	Breaks the connection to the KVM over IP switch and returns you to local client computer operation. This is equivalent to clicking the <i>Exit</i> icon on the Control Panel. The default keys are F2, F3, F4.
Adjust Video	Brings up the <i>Video Settings</i> dialog box. This is equivalent to clicking the <i>Video Settings</i> icon on the Control Panel. The default keys are F5, F6, F7.
Toggle Control Panel	Toggles the Control Panel Off and On. The default keys are F3, F4, F5.
Toggle Mouse Display	If you find the display of the two mouse pointers (local and remote) to be confusing or annoying, you can use this function to shrink the non-functioning pointer down to a barely noticeable tiny circle, which can be ignored. Since this function is a toggle, use the hotkeys again to bring the mouse display back to its original configuration. This is equivalent to selecting the <i>Dot</i> pointer type from the <i>Mouse Pointer</i> icon on the Control Panel. The default keys are F7, F8, F9. Note: The Java Control Panel does not have this feature.
Adjust Mouse	This synchronizes the local and remote mouse movements. The default keys are F8,F7,F6.
Video Auto Sync	This combination performs an auto-sync operation. It is equivalent to clicking the <i>Video Auto Sync</i> icon on the Control Panel. The default keys are F6,F7,F8.
Show/Hide Local Cursor	Toggles off and on: hides local cursor and locks the mouse pointer and keyboard use within the Windows/Java Client AP window, plus hides the control panel. This is equivalent to selecting the <i>Single</i> pointer type from the <i>Mouse Pointer</i> icon on the Control Panel. The default keys are F4,F5.
Substitute Ctrl Key	If your local client computer captures Ctrl key combinations, preventing them from being sent to the remote server, you can implement their effects on the remote server by specifying a function key to substitute for the Ctrl key. If you substitute the F11 key, for example, pressing [F11 + 5] would appear to the remote server as [Ctrl + 5]. The default key is F11.
Substitute Alt Key	Although all other keyboard input is captured and sent to the KVM over IP switch, [Alt + Tab] and [Ctrl + Alt + Del] work on your local client computer. In order to implement their effects on the remote server, another key may be substituted for the Alt key. If you substitute the F12 key, for example, you would use [F12 + Tab] and [Ctrl + F12 + Del]. The default key is F12.

User Macros

User Macros are created to perform specific actions on the remote server. To create the macro, do the following:

1. Select *User Macros*, then click **Add**.

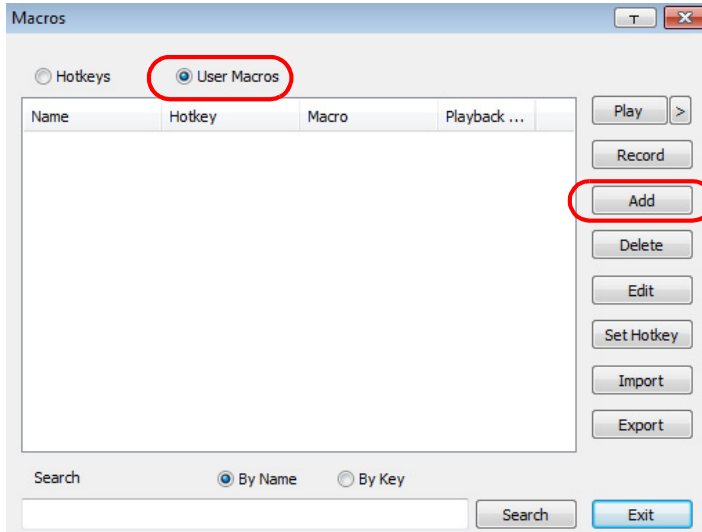

2. In the dialog box that comes up, replace the “New Macro” text with a name of your choice for the macro:

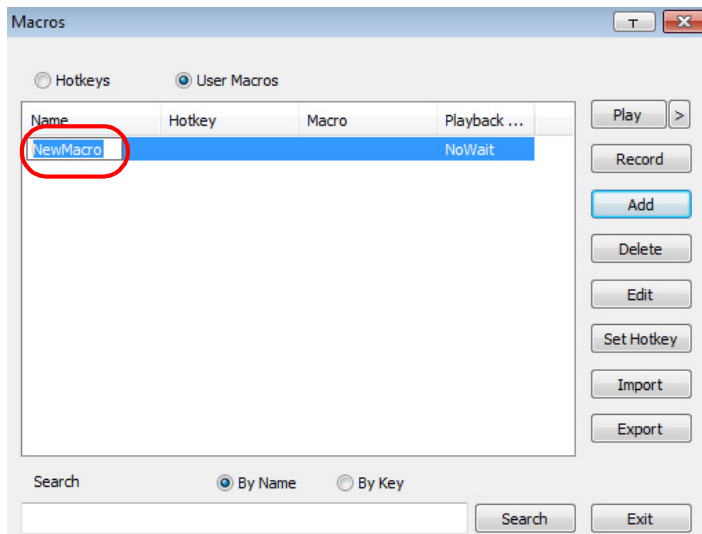

3. Click **Record**.

The dialog box disappears, and a small panel appears at the top left of the screen:



4. Press the keys for the macro.

- ◆ To pause macro recording, click **Pause**. To resume, click **Pause** again.
- ◆ Clicking **Show** brings up a dialog box that lists each keystroke that you make, together with the amount of time each one takes:

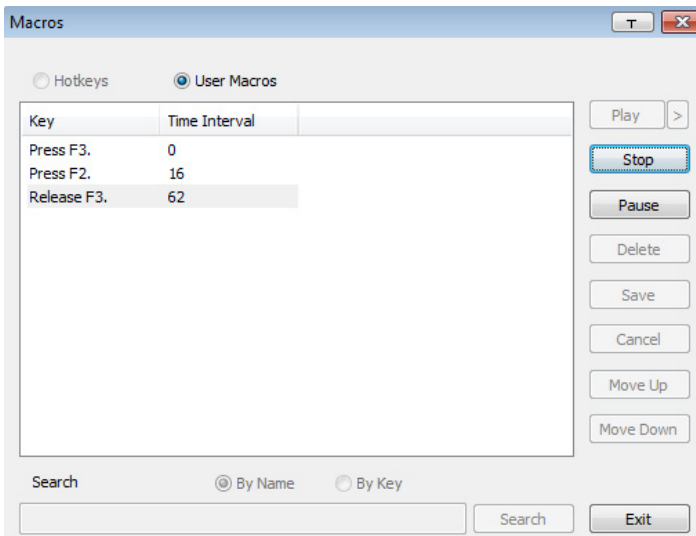

- ◆ Clicking **Cancel** cancels all keystrokes.
- ◆ When you have finished, click **Record**. (This is the equivalent of clicking *Done* in Step 5.)
- ◆ When recording the macro the focus must be on the remote screen. It cannot be in the macro dialog box.

Note: 1. Case is not considered – typing **A** or **a** has the same effect.

2. Only the default keyboard characters may be used. Alternate characters cannot be used. For example, if the keyboard is Traditional Chinese and default character is **A** the alternate Chinese character obtained via keyboard switching is not recorded.
-

- If you haven't brought up the Show dialog, click **Done** when you have finished recording your macro. You return to the Macros dialog box with your system macro key presses displayed in the Macro column:

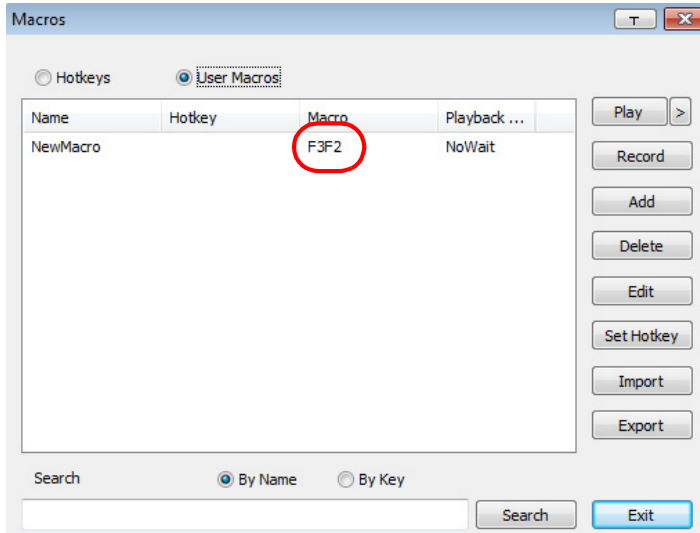

- If you want to change any of the keystrokes, select the macro and click **Edit**. This brings up a dialog box similar to the one for Show. You can change the content of your keystrokes, change their order, etc.
- Repeat the procedure for any other macros you wish to create.

After creating your macros, you can run them in any of three ways:

- By using the hotkey (if one was assigned).
- By opening the Macro List on the Control Panel and clicking the one you want (see page 77).
- By opening this (Macros) dialog box and clicking **Play**.

If you run the macro from this dialog box, you have the option of specifying how the macro runs.



- If you choose *Play Without Wait*, the macro runs the key presses one after another with no time delay between them.

- ◆ If you choose *Play With Time Control*, the macro waits for the amount of time between key presses that you took when you created it. Click on the arrow next to *Play* to make your choice.
- ◆ If you click *Play* without opening the list, the macro runs with the default choice (*NoWait* or *TimeCtrl*), which is shown in the *Playback* column.

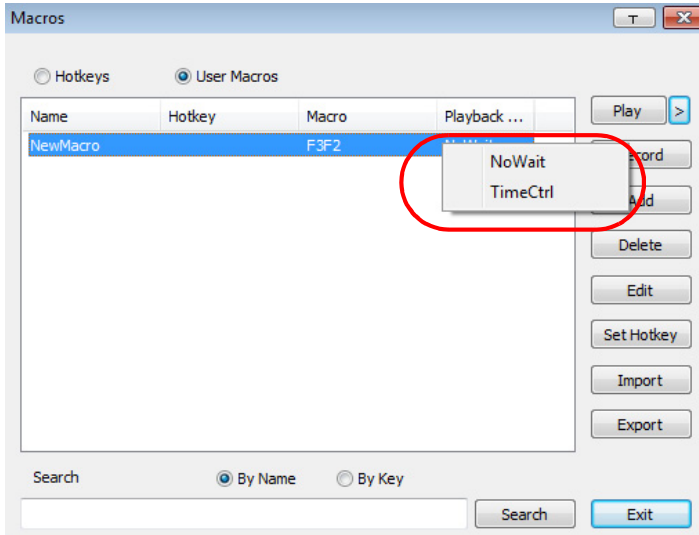

You can change the default choice by clicking on the current choice (*NoWait* in the screenshot above), and selecting the alternate choice.

Note: 1. Information about the Search function is provided below.

2. User Macros are stored on the Local Client computer of each user. Therefore, there is no limitation on the of number of macros, the size of the macro names, or makeup of the hotkey combinations that invoke them.
-

■ Search

Search, at the bottom of the dialog box, lets you filter the list of macros that appear in the large upper panel for you to play or edit. Click a radio button to choose whether you want to search by name or by key; key in a string for the search; then click **Search**. All instances that match your search string appear in the upper panel.



Video Settings

Clicking the *Hammer* icon on the Control Panel brings up the *Basic Video Settings* dialog box with basic settings. The options in the basic dialog box allow you to adjust the Screen Position, set Auto Sync, and slide the Performance bar setting. Selecting the *Advanced* button opens the *Advanced Video Settings* dialog box, providing more detailed options including RGB, Gamma, Video Quality, Enable Refresh, Transparency and Color Depth Control, as shown below:

Basic Video Settings

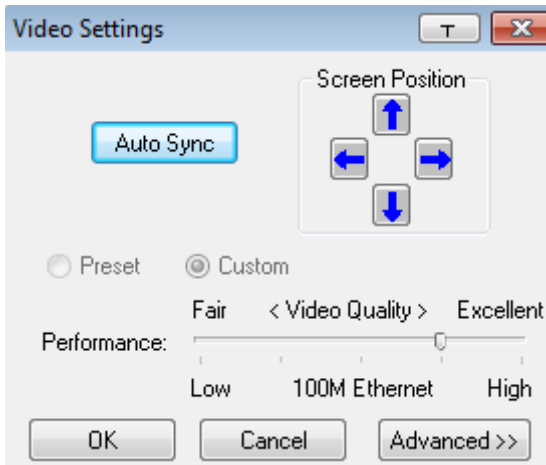

Advanced Video Settings

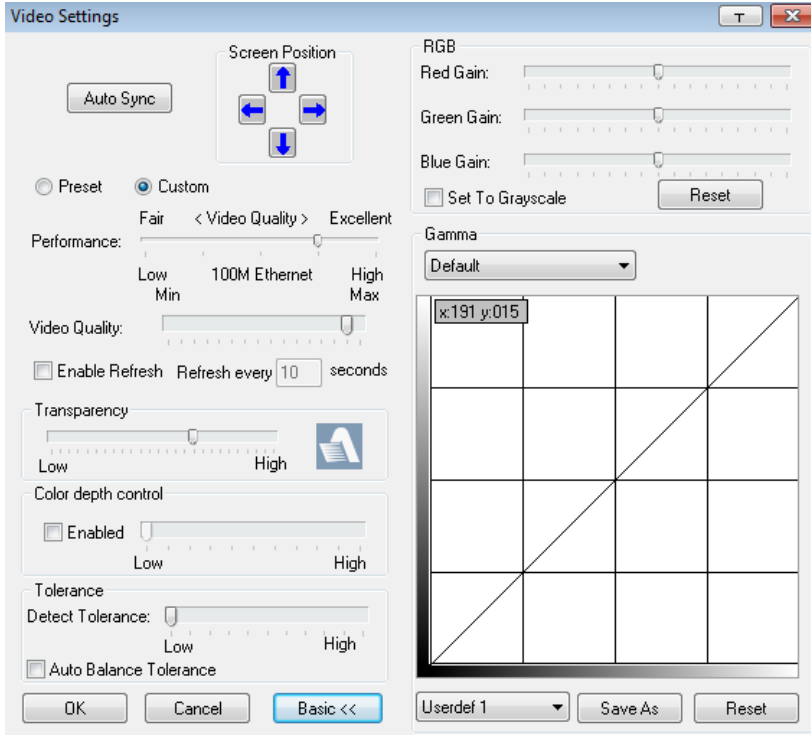

The meanings of the video adjustment options are given in the table below:

Options	Usage
Screen Position	Adjust the horizontal and vertical position of the remote server window by Clicking the Arrow buttons.
Auto Sync	<p>Click Auto Sync to have the vertical and horizontal offset values of the remote screen detected and automatically synchronized with the local screen.</p> <p>Note:</p> <ol style="list-style-type: none"> 1. If the local and remote mouse pointers are out of sync, in most cases, performing this function will bring them back into sync. 2. This function works best with a bright screen. 3. If you are not satisfied with the results, use the Screen Position arrows to position the remote display manually.

Options	Usage
RGB	<p>Drag the slider bars to adjust the RGB (Red, Green, Blue) values. When a RGB value is increased, the RGB component of the image is correspondingly increased.</p> <p>If you enable <i>Set to Grayscale</i>, the remote video display is changed to grayscale.</p> <p>Clicking the <i>Reset</i> button brings the RGB settings back their default values.</p>
Gamma	<p>This section allows you to adjust the video display's gamma level. This function is discussed in detail in the next section, <i>Gamma Adjustment</i>.</p>
Performance	<p>Use the slide bar to select the type of Internet connection that the local client computer uses. The switch will use that selection to automatically adjust the <i>Video Quality</i> settings to optimize the quality of the video display.</p> <p>Since network conditions vary, if none of the preset choices seem to work well, you can select <i>Advanced</i> and use the Video Quality slide bar to adjust the settings to suit your conditions.</p>
Video Quality	<p>Drag the slider bar to adjust the overall Video Quality. The larger the value, the clearer the picture and the more video data goes through the network. Depending on the network bandwidth, a high value may adversely effect response time.</p>
Enable Refresh	<p>The KVM over IP switch can redraw the screen every 1 to 99 seconds, eliminating unwanted artifacts from the screen. Select Enable Refresh and enter a number from 1 through 99. The KVM over IP switch will redraw the screen at the interval you specify. This feature is disabled by default. Click to put a check mark in the box next to <i>Enable Refresh</i> to enable this feature.</p> <p>Note:</p> <ol style="list-style-type: none"> 1. The switch starts counting the time interval when mouse movement stops. 2. Enabling this feature increases the volume of video data transmitted over the network. The lower the number specified, the more often the video data is transmitted. Setting too low a value may adversely affect overall operating responsiveness.
Transparency	<p>Adjusts the transparency of the toolbar that comes up when the GUI hotkey ([Scroll Lock][Scroll Lock], for example), is invoked. Slide the bar until the display in the example window is to your liking.</p>
Color Depth Control	<p>This setting determines the richness of the video display by adjusting the amount of color information.</p>

Options	Usage
Detect Tolerance	<p>This setting also relates to video quality. It governs detecting or ignoring pixel changes. A high setting can result in a lower quality display due to less data transfer. A lower setting will result in better video quality, but setting the threshold too low may allow too much data to be transferred, negatively impacting network performance.</p> <p>Selecting the <i>Auto Balance Tolerance</i> check box allows the switch to automatically detect and adjust the tolerance settings according to pixel changes as they occur.</p>
Preset / Custom	<p>Using the Preset and Custom buttons allow you to set and save custom video settings, and revert back to default video settings.</p>

Gamma Adjustment

If it is necessary to correct the gamma level for the remote video display, use the *Gamma* function of the Video Settings dialog box.

- ◆ Under *Advanced* configuration, there are ten preset and four user-defined levels to choose from. Drop down the list box and choose the most suitable one.
- ◆ For greater control, clicking the *Advanced* button brings up the following dialog box:

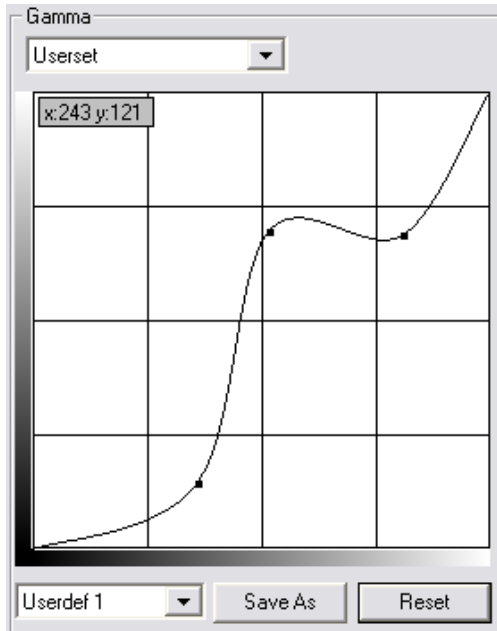

- ◆ Click and drag the diagonal line at as many points as you wish to achieve the display output you desire.
- ◆ Click **Save As** to save up to four user-defined configurations derived from this method. Saved configurations can be recalled from the list box at a future time.
- ◆ Click **Reset** to abandon any changes and return the gamma line to its original diagonal position.
- ◆ Click **OK** to save your changes and close the dialog box.
- ◆ Click **Cancel** to abandon your changes and close the dialog box.

Note: For best results, change the gamma while viewing a remote server.

Network Bandwidth Information for KVM Sessions

For network bandwidth management, under ideal circumstances, a KVM session of a full-screen video display at 1920x1080 @60Hz will take up approximately 64Mbps.

However, since the network environment of each station/session varies, the aforementioned information proposes what is ideal but does not warrant the smoothness/quality for each session.



The Message Board

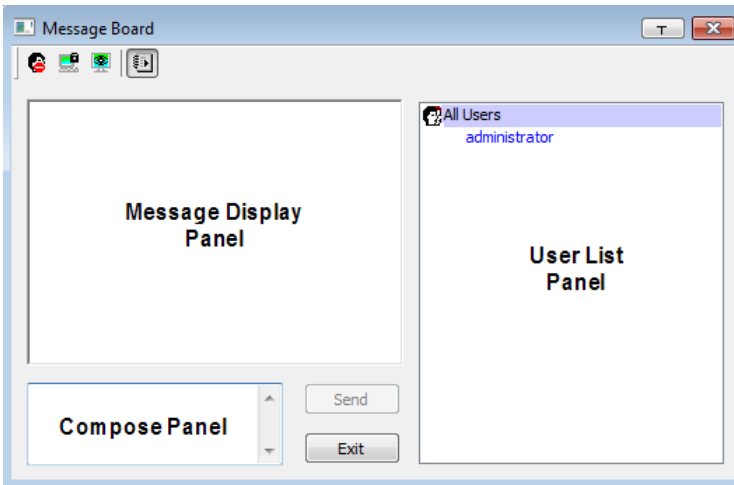

The KVM over IP switch supports multiple user logins, which may cause access conflicts. To alleviate the problem, a message board has been provided, which allows users to communicate with each other:



Button Bar

The buttons on the Button Bar are toggles. Their actions are described in the table below:

Button	Action
	Enable/Disable Chat. When disabled, messages posted to the board are not displayed. The button is shadowed when Chat is disabled. The icon displays next to the user's name in the User List panel when the user has disabled Chat.

	Occupy/Release Keyboard/Video/Mouse. When you Occupy the KVM, other users cannot see the video, and cannot input keyboard or mouse data. The button is shadowed when the KVM is occupied. The icon displays next to the user's name in the User List panel when the user has occupied the KVM.
	Occupy/Release Keyboard/Mouse. When you Occupy the KM, other users can see the video, but cannot input keyboard or mouse data. The button is shadowed when the KM is occupied. The icon displays next to the user's name in the User List panel when the user has occupied the KM.
	Show/Hide User List. When you Hide the User List, the User List panel closes. The button is shadowed when the User List is open.

Message Display Panel

Messages that users post to the board - as well as system messages - display in this panel. If you disable Chat, however, messages that get posted to the board won't appear.

Compose Panel

Key in the messages that you want to post to the board in this panel. Click **Send**, or press [**Enter**] to post the message to the board.

User List Panel

The names of all the logged in users are listed in this panel.

- ◆ Your name appears in blue; other users' names appear in black.
- ◆ By default, messages are posted to all users. To post a message to one individual user, select the user's name before sending your message.
- ◆ If a user's name is selected, and you want to post a message to all users, select All Users before sending your message.
- ◆ If a user has disabled Chat, its icon displays before the user's name to indicate so.
- ◆ If a user has occupied the KVM or the KM, its icon displays before the user's name to indicate so.

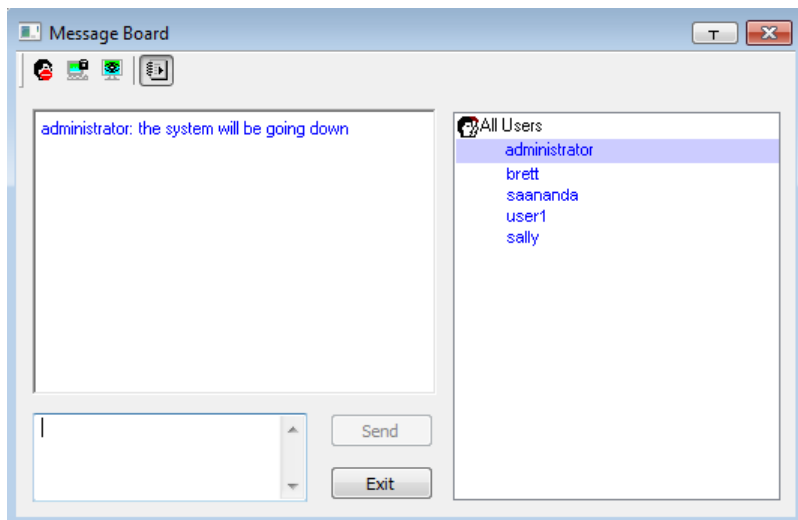



Zoom

The Zoom icon controls the zoom factor for the remote view window. Settings are as follows:

Setting	Description
100%	Sizes and displays the remote view window at 100%.
75%	Sizes and displays the remote view window at 75%.
50%	Sizes and displays the remote view window at 50%.
25%	Sizes and displays the remote view window at 25%.
1:1	Sizes and displays the remote view window at 100%. The difference between this setting and the 100% setting is that when the remote view window is resized its contents don't resize – they remain at the size they were. To see any objects that are outside of the viewing area, move the mouse to the window edge, to have the screen scroll.



The On-Screen Keyboard

The KVM over IP switch supports an on-screen keyboard, available in multiple languages, with all the standard keys for each supported language. Click this icon to pop up the on-screen keyboard:

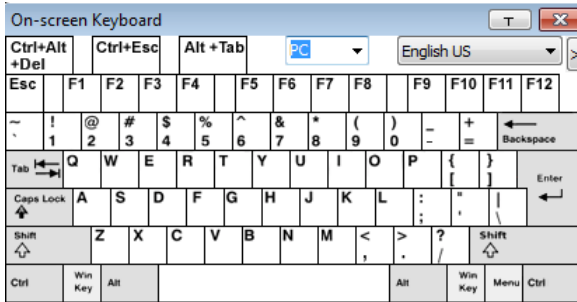

One of the major advantages of the on-screen keyboard is that if the keyboard languages of the remote and local systems aren't the same, you don't have to change the configuration settings for either system. Just bring up the on-screen keyboard; select the language used by the server you are accessing; and use the on-screen keyboard to communicate with it.

Note: You must use your mouse to click on the keys. You cannot use your actual keyboard.

Changing Languages

To change languages, do the following:

1. Click the down arrow next to the currently selected language, to drop down the language list.

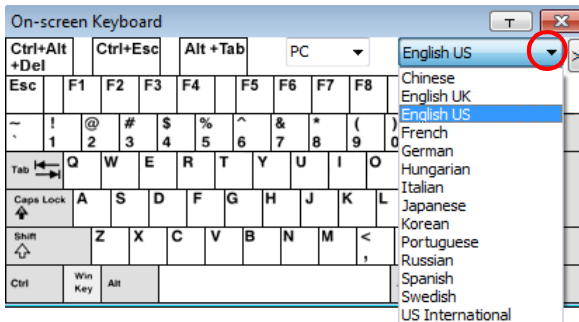

2. Select the new language from the list.

Selecting Platforms

The On-screen Keyboard supports the Sun platform as well as the PC. To select the platform, do the following:

1. Click the down arrow next to the currently selected platform, to drop down the platform list.



2. Select the new platform from the list.

Expanded Keyboard

To display/hide the expanded keyboard keys, click the arrow to the right of the language list arrow.

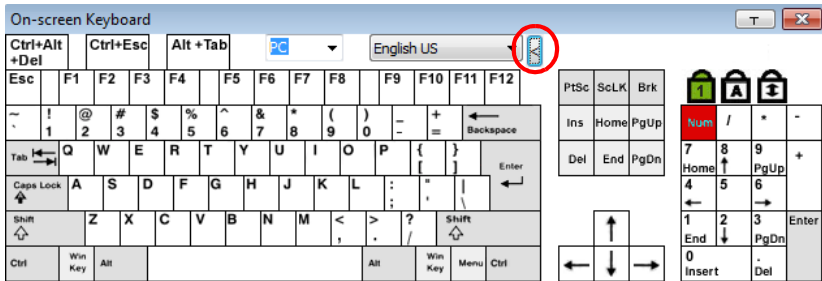



Mouse Pointer Type

KVM over IP switches offer a number of mouse pointer options when working in the remote display. Click this icon to select from the available choices:

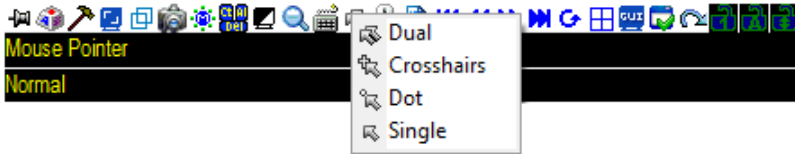

-
- Note:**
1. Before accessing a port, only Dual and Crosshairs are available for the Windows Viewers. Once the port is accessed, three pointers are available.
 2. The Dot pointer is not available with the Java Client Viewer or the Java Client AP.
 3. Selecting the Single pointer has the same effect as the *Toggle mouse display* hotkey function (see *Toggle Mouse Display*, page 80 for details).
 4. The icon on the Control Panel changes to match your choice.
-



Mouse DynaSync Mode

Synchronization of the local and remote mouse pointers is accomplished either automatically or manually.



Automatic Mouse Synchronization (DynaSync)

Mouse DynaSync provides automatic locked-in syncing of the remote and local mouse pointers – eliminating the need to constantly resync the two movements.

Note: This feature is only available for Windows and Mac systems (G4 or later) whose adapter attribute OS setting is configured for Win or Mac (see *Port Properties*, page 124).

All other configurations must use manual mouse synchronization (described in the next section).

The icon on the Control Panel indicates the synchronization mode status as follows:

Icon	Function
	This icon displays in gray to indicate that Mouse DynaSync is not available – you must use manual syncing procedures. This is the default setting for all KVM Adapter Cables.
	The green check mark on this icon indicates that Mouse DynaSync is available and is enabled . This is the default setting when Mouse DynaSync is available (See Note above).
	The red X on this icon indicates that Mouse DynaSync is available but is not enabled .

When *Mouse DynaSync* is available, clicking the icon toggles its status between enabled and disabled. If you choose to disable Mouse DynaSync mode, you must use the manual syncing procedures described under *Manual Mouse Synchronization*, page 98.

Mac Considerations

- For Mac OS versions 10.4.11 or later, there is a second DynaSync setting to choose from. If the default Mouse DynaSync result is not satisfactory, try the **Mac 2** setting. To select Mac 2, right click in the text area of the Control Panel and select *Mouse Sync Mode* → *Automatic for Mac 2*:

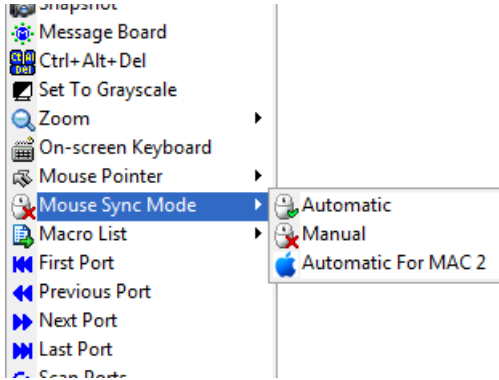

Manual Mouse Synchronization

If the local mouse pointer goes out of sync with the remote system's mouse pointer there are a number of methods to bring them back into sync:

1. Perform a video and mouse auto sync by clicking the *Video Settings* icon on the Control Panel (see page 85).
2. Perform an *Auto Sync* with the Video Adjustment function (see *Video Settings*, page 85, for details).
3. Invoke the *Adjust Mouse* function with the *Adjust Mouse* hotkeys (see *Adjust Mouse*, page 80, for details).
4. Move the pointer into all 4 corners of the screen (in any order).
5. Drag the Control Panel to a different position on the screen.
6. Set the mouse speed and acceleration for each problematic server attached to the switch. See *Additional Mouse Synchronization Procedures*, page 230, for instructions.

Control Panel Configuration

Clicking the *Control Panel* icon brings up a dialog box that allows you to configure the items that appear on the Control Panel, as well as its graphical settings:

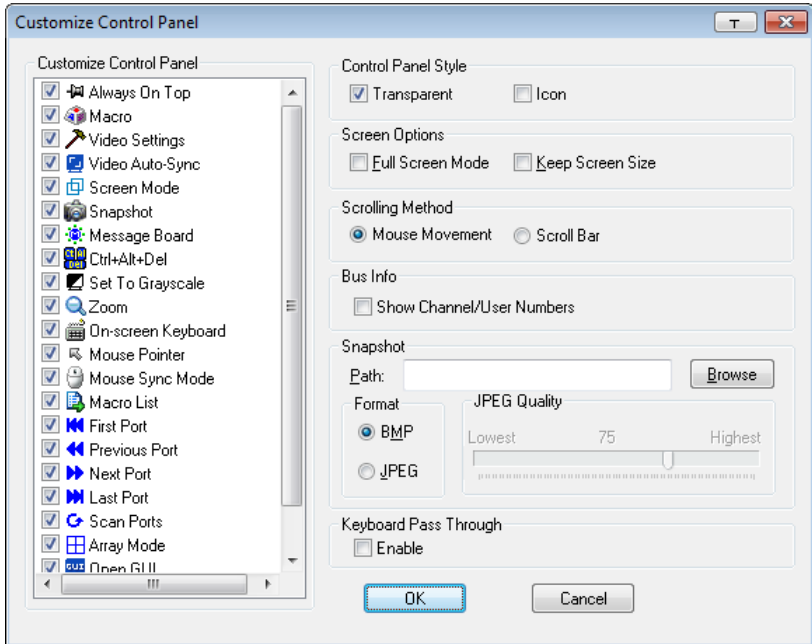

The organization of the dialog box is described in the table, below:

Item	Description
Customize Control Panel	Allows you to select which icons display in the Control Panel. Check the ones you want to see, uncheck the ones you don't want.
Control Panel Style	<ul style="list-style-type: none"> Enabling <i>Transparent</i> makes the Control Panel semi-transparent, so that you can see through it to the display underneath. Enabling <i>Icon</i> causes the Control Panel to display as an icon until you mouse over it. When you mouse over the icon, the full panel comes up.

Item	Description
Screen Options	<ul style="list-style-type: none"> ◆ If <i>Full Screen Mode</i> is enabled, the remote display fills the entire screen. ◆ If <i>Full Screen Mode</i> is not enabled, the remote display appears as a window on the local desktop. If the remote screen is larger than what is able to fit in the window, move the mouse pointer to the screen border that is closest to the area you want to view and the screen will scroll. ◆ If <i>Keep Screen Size</i> is enabled, the remote screen is not resized. <ul style="list-style-type: none"> ◆ If the remote resolution is smaller than that of the local monitor, its display appears like a window centered on the screen. ◆ If the remote resolution is larger than that of the local monitor, its display is centered on the screen. To access the areas that are off screen, move the mouse to the corner of the screen that is closest to the area you want to view and the screen will scroll. ◆ If <i>Keep Screen Size</i> is not enabled, the remote screen is resized to fit the local monitor's resolution.
Scrolling Method	<p>In cases where the remote screen display is larger than your monitor, you can choose how to scroll to the areas that are off-screen.</p> <ul style="list-style-type: none"> ◆ If you select <i>Mouse Movement</i>, the screen will scroll when you move the mouse pointer to your screen border. ◆ If you select <i>Scroll Bars</i>, scroll bars appear around the screen borders that you can use to scroll to the off-screen areas.
Bus Info	<p>If <i>Bus Info</i> is enabled, the bus you are on, as well as the total number of users on the bus, displays on the bottom row center of the Control Panel as follows: Bus No./Total Users. (See the Control Panel diagram on page 74 for an example.)</p> <p>Example: C1/3 = bus number 1 has 3 users connected.</p>
Snapshot	<p>These settings let the user configure the KVM over IP switch's screen capture parameters (see the <i>Snapshot</i> description under <i>The Control Panel</i>, page 74):</p> <ul style="list-style-type: none"> ◆ Path lets you select a directory that the captured screens automatically get saved to. Click Browse; navigate to the directory of your choice; then click OK. If you don't specify a directory here, the snapshot is saved to your desktop. ◆ Click a radio button to choose whether you want the captured screen to be saved as a BMP or a JPEG (JPG) file. ◆ If you choose JPEG, you can select the quality of the captured file with the slider bar. The higher the quality, the better looking the image, but the larger the file size.
Keyboard Pass Through	<p>When this is enabled, the Alt-Tab key press is passed to the remote server and affects that server. If it is not enabled, Alt-Tab acts on your local client computer.</p>

The Java Control Panel

The Java Client Viewer and Java Client AP Control Panel is similar to the one used by the WinClient:

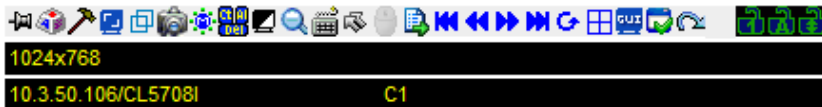

The major differences between them are:

- ◆ In the Macros dialog box, *Toggle Mouse Display* is not available.
- ◆ The *Dot* mouse pointer type is not available.
- ◆ In the Message Board, there is no *Show/Hide* button to show or hide the user list. This function is achieved by clicking the arrows at the top of the bar that separates the User List panel from the Main panel.
- ◆ The Control Panel *Lock LED* icons are not in sync with your keyboard. When you first connect, the LED display may not be accurate. To be sure, click on the LED icons to set them.
- ◆ In *Control Panel Configuration*, the BMP Snapshot format has been replaced by PNG.

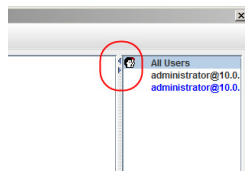

This Page Intentionally Left Blank

Chapter 8

Port Access

Overview

When you log in to the switch, the *Port Access* page comes up with the KVM over IP switch's KVM *Connections* page displayed.

Browser GUI

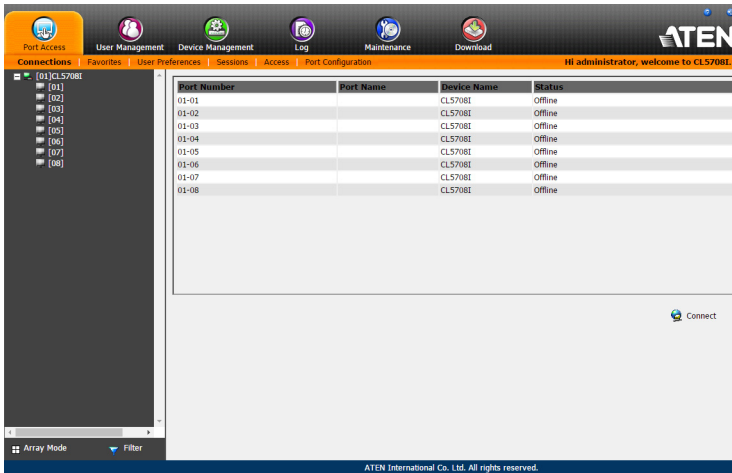

AP GUI

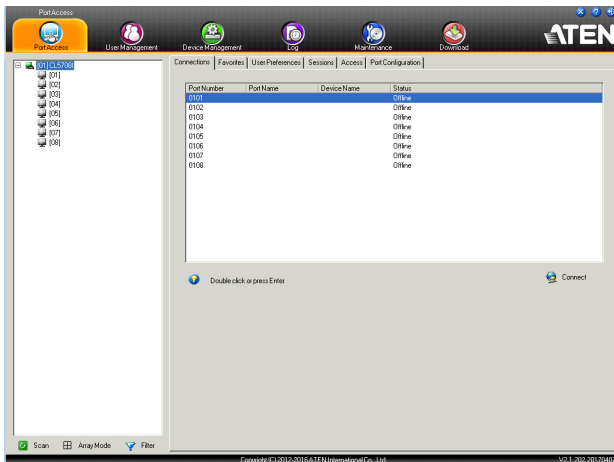

The Connections page is organized into several main areas. All the ports that a user is permitted to access are listed in the Sidebar at the left of the page.

After selecting a port in the Sidebar, clicking entries on the menu bar (Browser GUI) or tab bar (AP GUI) opens information and configuration pages related to the item selected in the Sidebar.

The Sidebar

All KVM switches and their ports – are listed in a tree structure in the Sidebar at the left of the screen:

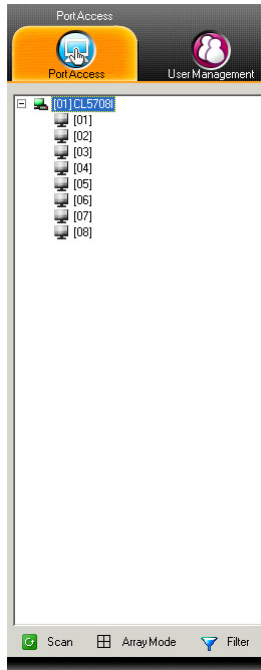

The Sidebar Tree Structure

The characteristics of the Sidebar tree structure are the following:

- ◆ Users are only allowed to see the devices and ports/outlets that they have access permission for.
- ◆ Ports and child devices can be nested under their parent devices.
Click the + in front of a device to expand the tree and see the ports/outlets nested underneath it. Click the - to collapse the tree and hide the nested ports/outlets.
- ◆ A port's ID number is displayed in brackets next to its icon. The ports but can also be named (see *Port/Outlet Naming*, page 109, for details).
- ◆ Switches and ports that are on line have their monitor screen icons in Green; the monitor screens are Gray for devices and ports that are offline.
- ◆

- ◆ To access and operate a port, double-click its icon. Port operation details are discussed in Chapter 14, *Port Operation*.



Scan

Scan is found at the bottom of the AP GUI Sidebar. It automatically switches among all the ports that are visible in the Sidebar (see Filter, below), at regular intervals, so that their activity can be monitored automatically. See *Auto Scanning*, page 178, for details.

Note: This item doesn't appear at the bottom of the Sidebar in the Browser version. In that version, you must invoke it from the port's *Toolbar*. See *The Port Toolbar*, page 176 for details



Array

Array is found at the bottom of the AP GUI Sidebar. It represents another way of monitoring port activity. Under this function your screen is divided into a grid of panels, with each panel showing the video display of a particular port. Only ports that are visible in the Sidebar (see Filter, below), and that are on line are displayed – all other ports are blank. See *Panel Array Mode*, page 181 for details

Note: This item doesn't appear at the bottom of the Sidebar in the Browser version. In that version, you must invoke it from the port's *Toolbar*. See *The Port Toolbar*, page 176 for details



Filter

Filter allows you to control the number and type of ports that display in the Sidebar, as well as which ports get scanned when Auto Scan and Array Modes are invoked (see *Scan* and *Array*, above). When you click *Filter*, the bottom of the panel changes to look similar to the image, below:

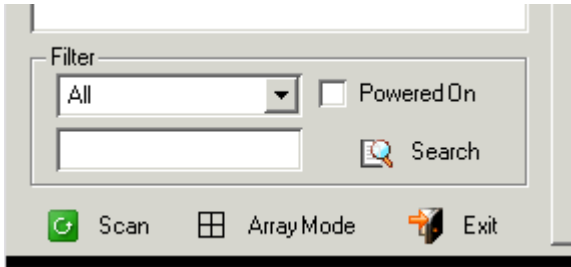

The meanings of the choices are explained in the following table:

Choices	Explanation
All	<p>This is the default view. With no other filter options selected, all of the ports that are accessible to the user are listed in the Sidebar.</p> <p>If any <i>Favorites</i> have been specified (see page 113), you can drop down the list box and select Favorites instead of All. If you select Favorites, only the items you have selected as Favorites display in the tree.</p>
Powered On	<p>If you enable <i>Powered On</i> (by putting a check in the checkbox) only the ports that have their attached devices powered on display in the tree.</p>
Search	<p>If you key in a search string and click Search, only port names that match the search string display in the tree. Wildcards (? for single characters; * for multiple characters) and the keyword or are supported, so that more than one port can show up in the list.</p> <p>For example:</p> <ol style="list-style-type: none"> 1. If you key in Web*, both Web Server 1 and Web Server 2 show up in the list. 2. If you key in W*1 or M*2, both Web Server 1 and Mail Server 2 show up in the list.
Exit	<p>Clicking Exit closes the filter dialog.</p>

Sidebar Utilities

The AP GUI version Port Access *Connections* page provides a convenient method to work with the Sidebar tree. When you right-click an item, a list with various options pops up:



Note: The screenshot shows an example of just one of the pop-ups that can appear. The items that appear in the pop-up depend on whether you are logged in remotely or from a Local Console; what your user type is; and whether you selected a switch or a port.

The following table lists and explains all of the possible items that may appear:

Item	User Type	Explanation
Expand/ Collapse	Administrators Users	<ul style="list-style-type: none"> ◆ If the device's ports are nested (not displayed), the dialog box entry is <i>Expand</i>. Click Expand to display the nested ports. ◆ If the device's ports are displayed, the dialog box entry is <i>Collapse</i>. Click Collapse to nest the ports. <p>Note: 1. This item only appears for switches, or for ports that have child devices connected to them.</p> <p>2. This has the same effect as clicking the + or - in the tree structure.</p>
Copy	Administrators Users	This item is only available for ports. After selecting Copy, you can Paste the port into the Favorites page. See <i>Adding a Favorite</i> , page 113 for details

Port/Outlet Naming

For convenience – especially in large installations with many devices – administrators and users with port configuration permission, can give each port a name. To assign, modify or delete a name, do the following:

1. Click once on the item you want to edit; wait a second; then click again.

Note: 1. This is not a double-click. It involves two separate clicks. A double-click will switch you to the device attached to the port.

2. In the AP GUI version you can right-click on the port you want to edit, then select **Rename** in the popup box that appears, or you can highlight the port and press **F2**.
-

After a second or two, the field changes to provide a text input box:

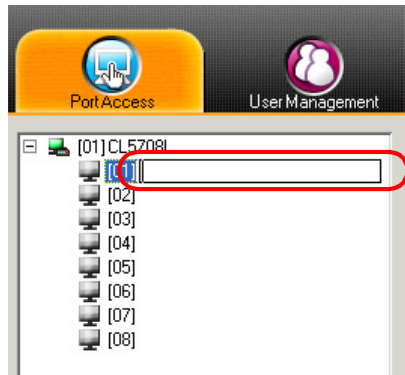

2. Key in a name for the item (or change/delete a previous one).
 - ◆ You can use any combination of letters, numbers, and symbols on the keys of keyboards with a PC US English layout. In this case, the maximum number of characters allowed is 20.
 - ◆ You can also activate your local IME to input non-English characters. For languages that use 2 bit encoding, the maximum number of characters allowed is 9.

- When you have finished editing the name, press **[Enter]** or click anywhere outside of the input box to complete the operation.

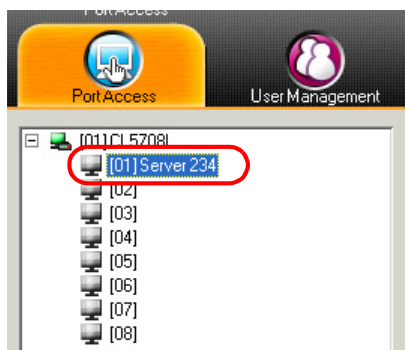

KVM Devices and Ports – Connections Page

For KVM over IP switches, the *Connections* page displays port status information at the device level, and port connection configuration options at the port level.

Device Level

When a KVM over IP switch is selected in the Sidebar, the Connections page displays a list of ports for the device that the user is authorized to access or view.

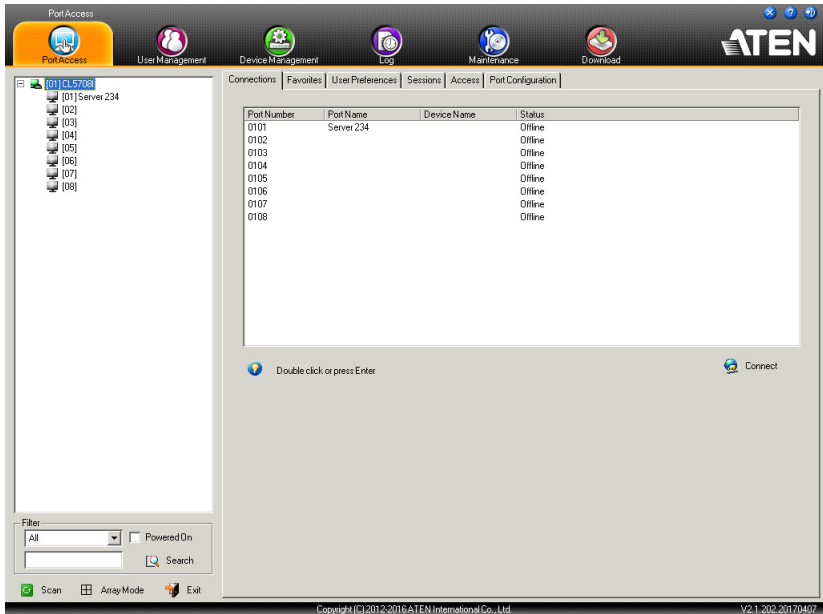

The following attributes are listed for each device:

- ◆ Port Number – the port’s number on the switch.
- ◆ Port Name – if a name has been assigned to a port it displays here.
- ◆ Device Name – if a name has been assigned to the switch it displays here.
- ◆ Status – the current status of the port – online, or offline.

Note: The sort order of the information displayed can be changed by clicking the column headings.

You can access a port from the main panel either by double-clicking anywhere on its line entry, or selecting it anywhere on its line entry and clicking **Connect** at the bottom right of the page.

Port Level

When a port is selected in the Sidebar, the *Connections* page changes to display the port connection and configuration options:

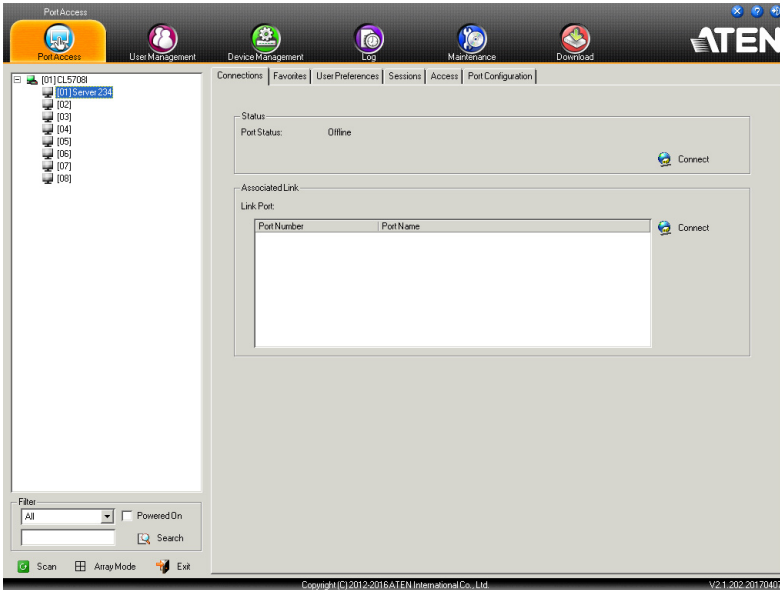

The screen is divided into three major panels, as described in the sections that follow.

Status

The Status Panel displays the port's current status information, including whether the port is online or offline.

Click the **Connect** button to view the port display via the switch's built-in Win Viewer (when using Windows Internet Explorer), or Java Viewer (when using other web browsers).

Associated Links

The Associated Links panel displays ports that have been associated with the currently selected port. Associations are configured on the *Port Access* → *Port Configuration* → *Associated Links* page (see page 126 for details).

Favorites

The *Favorites* page is similar to a bookmarks feature. Ports that you frequently access can be saved in a list here. Simply open this page and select the port – rather than hunting for it in the Sidebar. This feature is especially handy on large, crowded installations:

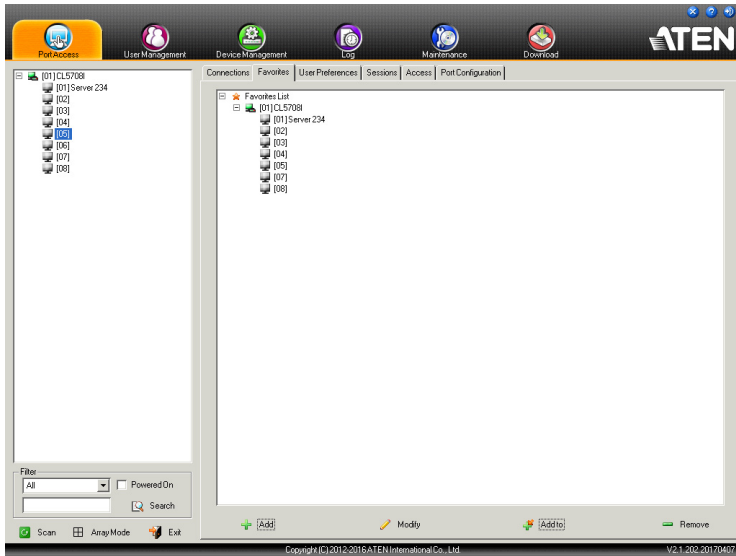

Adding a Favorite

To add a port to the favorites, do the following:

1. Right click in the main panel; click **Add Favorite**.

– or –

Click **Add** at the bottom left of the main panel.

An *Untitled Favorite* entry appears:

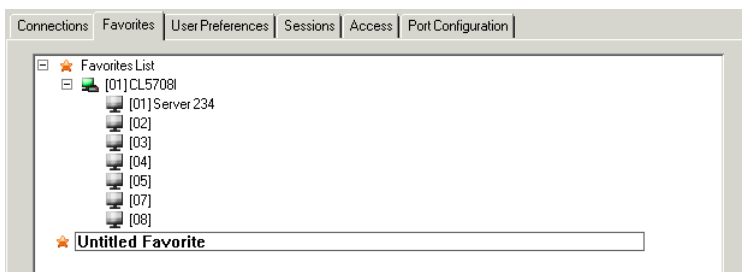

2. This will be a container to hold your port entries. Click inside the text entry box to erase *Untitled Favorite* and key in an appropriate name, then click on any empty space in the main panel.

3. To add a port:

Drag it from the Sidebar and drop it onto the container

– or –

Right-click on it in the Sidebar; select **Copy**. Right-click on the container; select **Paste**.

– or –

Select the container in the main panel; select the port in the Sidebar; then click **Add to** at the bottom of the main panel.

The switch that the port belongs to is added to the container; the selected port is appended under the switch.

Note: To add multiple ports at the same time, hold the Shift or Ctrl key down while you make your Sidebar selections then drag or copy the entire group to the Favorites panel.

4. Repeat step 3 for any other *Favorite* categories you wish to create

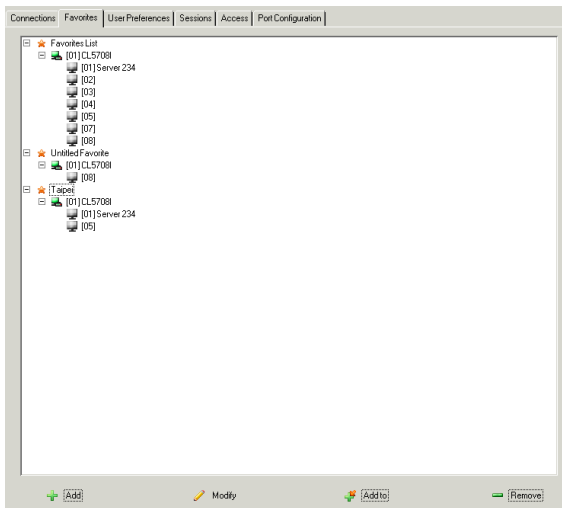

Note: Favorites can be selected for filtering in the Sidebar. See *Filter*, page 107 for details

Modifying a Favorite

- ◆ To modify a Favorite, or one of the items contained in it, right-click on it, then select a choice from the popup menu that appears.
- ◆ To edit a Favorite's name:

Click on it once, wait a second, then click again. You can edit the name after the display changes to provide a text input box, This is the same procedure as the one described for port naming (see *Port/Outlet Naming*, page 109).

– or –

Select the Favorite in the main panel, then click **Modify** at the bottom of the main panel.

User Preferences

The *User Preferences* page allows users to set up their own, individual, working environments. The switch stores a separate configuration record for each user profile, and sets up the working configuration according to the *Username* that was keyed into the Login dialog box:

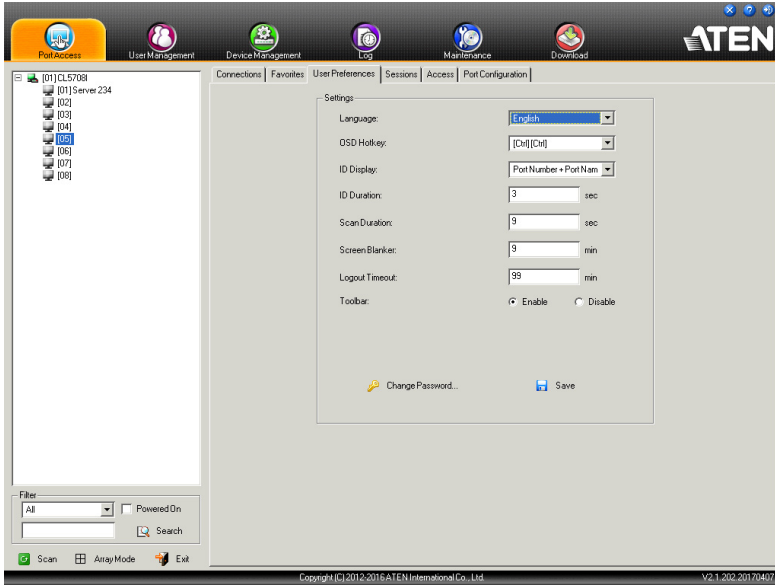

The page settings are explained in the following table:

Setting	Function
Language	Selects the language that the interface displays in.
OSD Hotkey	Selects which Hotkey controls the GUI function: [Scroll Lock] [Scroll Lock] is the default. To select a different combination, click the arrow at the right of the box to drop down the list of choices.
ID Display	Selects how the Port ID is displayed: the Port Number alone (PORT NUMBER); the Port Name alone (PORT NAME); or the Port Number plus the Port Name (PORT NUMBER + PORT NAME). The default is PORT NUMBER + PORT NAME.
ID Duration	Determines how long a Port ID displays on the monitor after a port change has taken place. You can choose an amount from 1—255 seconds. The default is 3 Seconds. A setting of 0 (zero) means the Port ID is always on.

Setting	Function
Scan Duration	Determines how long the focus dwells on each port as it cycles through the selected ports in Auto Scan Mode (see <i>Auto Scanning</i> , page 178). Key in a value from 1—255 seconds. The default is 5 seconds; a setting of 0 disables the Scan function.
Screen Blanker	If there is no input from the console for the amount of time set with this function, the screen is blanked. Key in a value from 1—30 minutes. A setting of 0 disables this function. The default is 0 (disabled). Note: Although this function can be set from either the local console or a remote login, it only affects the local console monitor.
Logout Timeout	If there is no user input for the amount of time set with this function, the user is automatically logged out. A login is necessary before the KVM over IP switch can be accessed again.
Toolbar	Selects whether or not the Port Toolbar is enabled when a port is accessed (see <i>The Port Toolbar</i> , page 176 for details). Since the Toolbar functions are also available from the GUI Control Panel (see <i>The Control Panel</i> , page 74), you may prefer to disable it here.
Viewer*	You can choose which viewer is used when accessing a server: <ul style="list-style-type: none"> ◆ Auto Detect will select the appropriate viewer based on the web browser used; WinClient for Windows Internet Explorer, Java Client for other web browsers (ex. Firefox). ◆ Java Client will open the Java based viewer regardless of the web browser being used.
Welcome Message*	You can choose to hide or show the welcome message displayed in the submenu bar. The default is disabled.
Save	Click Save to save any changes made to the User Preferences settings.
Changing a Password	<ul style="list-style-type: none"> ◆ In the Browser GUI, to change a user's password, key in the old password and new password into their input boxes; key the new password into the <i>Confirm</i> input box, then click Change Password to apply the change. ◆ In the AP GUI version, click Change Password; key in the old password and new password into their input boxes; key the new password into the <i>Confirm</i> input box, then click Save.

* This item is only available with the Browser version.

Sessions

The *Session* page lets the administrator and users with User Management permissions see at a glance which users are currently logged into the KVM over IP switch, and provides information about each of their sessions.

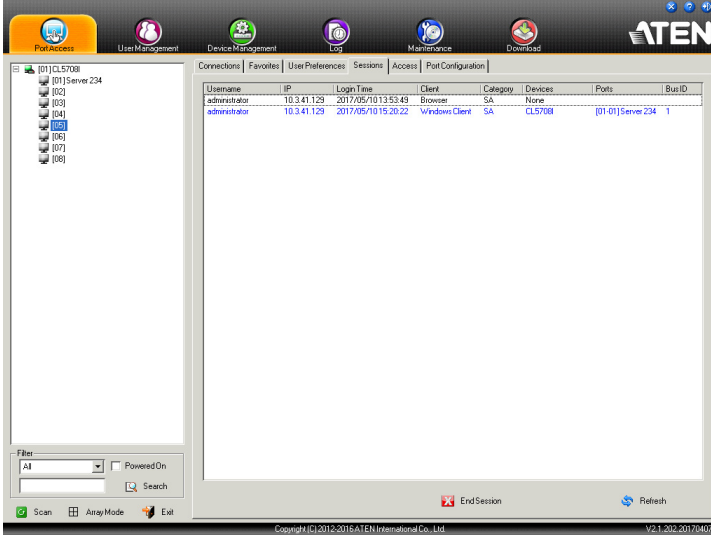

- Note:**
1. The Session page isn't available for ordinary users.
 2. Users with User Management permissions can only see the sessions of ordinary users.
 3. The *Category* heading lists the type of user who has logged in: SA (Super Administrator); Admin (Administrator); Normal user (User).

The meanings of the headings at the top of the page are fairly straightforward. The *IP* heading refers to the IP address that the user has logged in from; the *Device* and *Port* headings show which device and port the user is currently accessing. The *Bus ID* refers to the bus that the user is currently on (Bus 0 refers to the Local Console's bus).

- Note:**
1. The sort order of the information displayed can be changed by clicking the column headings.
 2. The Bus ID also displays on the control panel (see page 74).

This page also gives the administrator the option of forcing a user logout by selecting the user and clicking **End Session** at the bottom of the main panel.

Access

Administrators use the *Access* page to set user access and configuration rights for ports. The Access page only appears for those users with User Management permissions. It isn't available for other users.

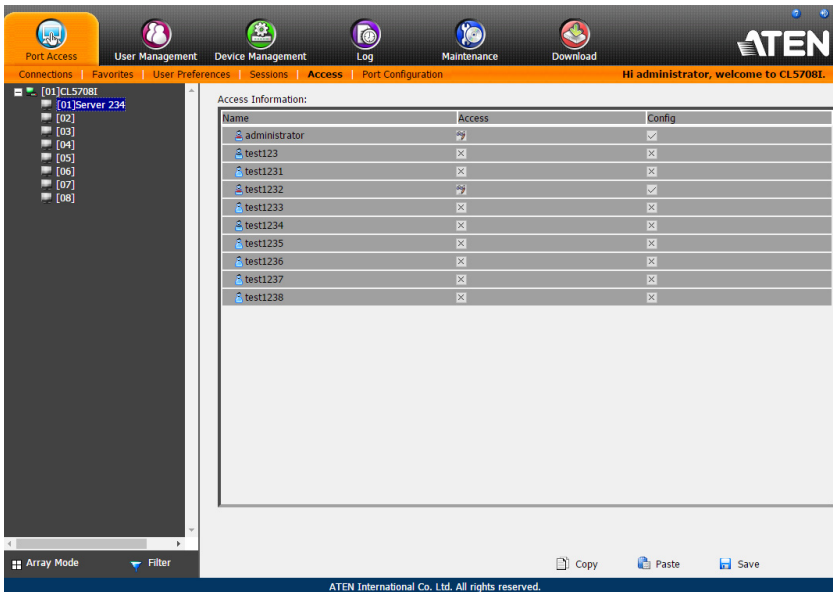

Port Level Browser GUI Interface

If a port is chosen in the Sidebar, the Main panel looks similar to the one shown below:



The port access settings are explained in the following table:

Name	Each port accessible to the user is listed under the <i>Names</i> column.
------	---

Access	<p>The Access column is where device access rights are set. To cycle through the choices, click the icon in the row that corresponds to the user you want to configure. The meanings of the icons are as follows</p>		
		Full Access	The user can view the remote screen and can perform operations on the remote server from his keyboard and monitor.
		View Only	The user can only view the remote screen; he cannot perform any operations on it.
		No Access	No access rights - the Port will not show up on the User's list on the Main Screen.
Config	<p>Sets or denies permission for the user to make changes to a port's configuration settings. A check mark (✓) indicates that the user has permission; an X means that the user does not have permission.</p>		

Port Level AP GUI Interface

If a port is chosen in the Sidebar, the Main panel looks similar to the one below:

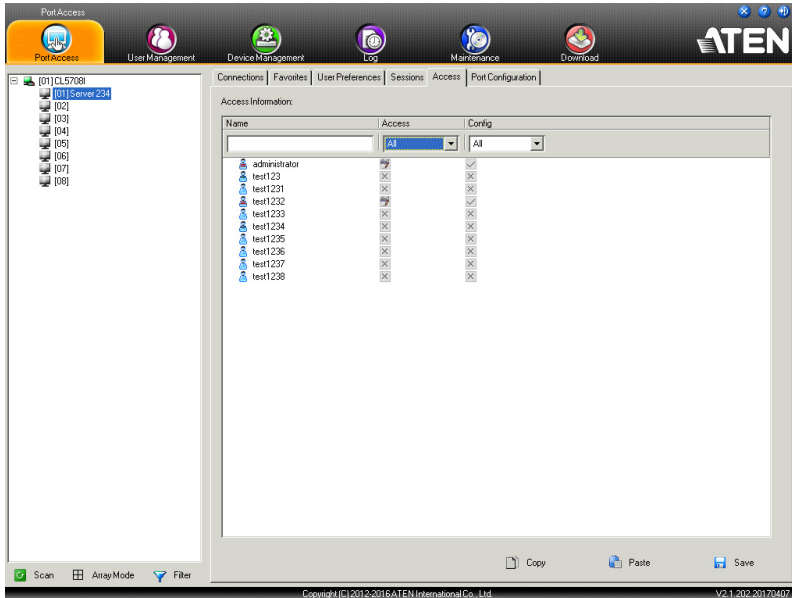

The page is essentially the same as the one for the Browser GUI (see page 119), with the exception that there are filters at the top of the columns. The filters allow you to expand or limit the scope of the users and groups that are displayed, as described in the following table:

Filter	Description	
Name	To filter on the User or Group name, key in the name, partial name, or partial name and wild card (*) then press Enter . Only the Users and Groups whose names correspond to what you have keyed in appear in the list.	
Access	All	All Users and Groups appear in the list.
	Full Access	Only Users and Groups with Full Access permissions appear in the list.
	View Only	Only Users and Groups with View Only permissions appear in the list.
	No Access	Only Users and Groups with No Access permissions appear in the list.
Config	All	All Users and Groups appear in the list.
	Permitted	Only Users and Groups with Permitted Config permissions appear in the list.
	Restricted	Only Users and Groups with Restricted Config permissions appear in the list.

Saving Changes

Click the **Save** button at the lower right corner of the page to save any changes made on the Access page.

Port Configuration

Device Level

When a device is selected in the Sidebar, there is one item available under Port Configuration on the Port Properties page: *Occupy Timeout*.

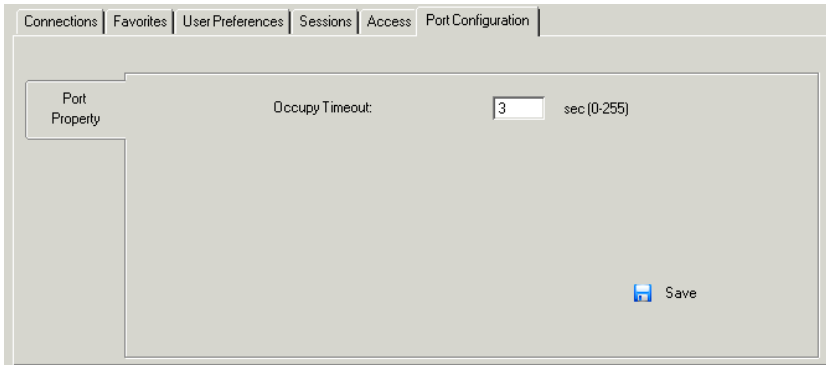

The Occupy Timeout field sets a time threshold for users on ports whose Access Mode has been set to Occupy (see *Access Mode*, page 125). If there is no activity from the user occupying the port for the amount of time set here, the user is timed out and the port is released. The first user to send keyboard or mouse input after the port has been released gets to occupy the port.

Input a value from 0 to 255 seconds. The default is 3 seconds. A setting of 0 causes the port to be released the instant there is no input.

Port Level

Port Properties

When a port is selected in the Sidebar, the Port Properties page looks similar to the one below:

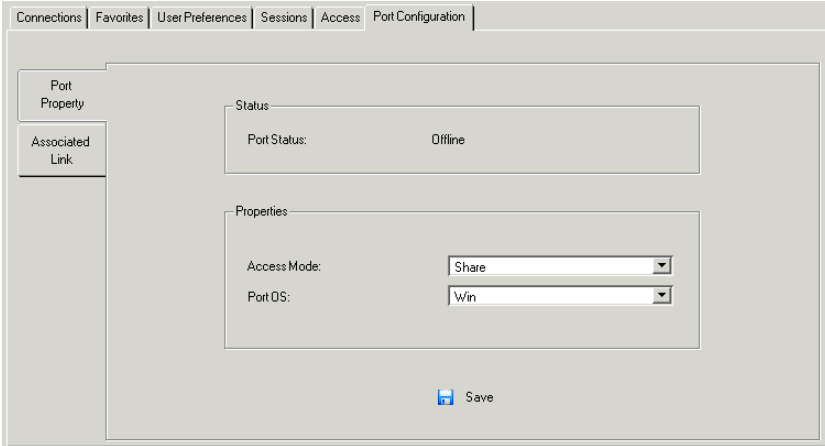

- ◆ The *Status* panel provides information as to whether or not the port is online or offline; the Adapter cable used to connect the server (or other device) to the port; and the Adapter's firmware level.
- ◆ The *Properties* panel allows you to make configuration settings for the selected port. An explanation of the Port Properties configuration fields is given on the next page, please refer to the table on page 125 for further details.

An explanation of the configuration fields is given in the table, below:

Field	Explanation
Access Mode	<p>Defines how the port is to be accessed when multiple users have logged on, as follows:</p> <p>Exclusive: The first user to switch to the port has exclusive control over the port. No other users can view the port. The <i>Timeout</i> function does not apply to ports which have this setting.</p> <p>Occupy: The first user to switch to the port has control over the port. However, additional users may view the port's video display. If the user who controls the port is inactive for longer than the time set in the <i>Timeout</i> box, port control is transferred to the other user to move the mouse or strike the keyboard.</p> <p>Share: Users simultaneously share control over the port. Input from the users is placed in a queue and executed chronologically. Under these circumstances, users can take advantage of the <i>Message Board</i>, which allows users to communicate with each other regarding control of the keyboard and mouse or keyboard, mouse, and video of a Share port (see <i>The Message Board</i>, page 90).</p>
Port OS	<p>Specifies the operating system that the server on the connected port is using. Choices are Win, Mac1, Sun, and Mac2. The default is Win.</p>

When you have finished making your configuration changes, click **Save**.

Associated Links

The Associated Links page provides a method of associating other ports on the same switch to the selected port.

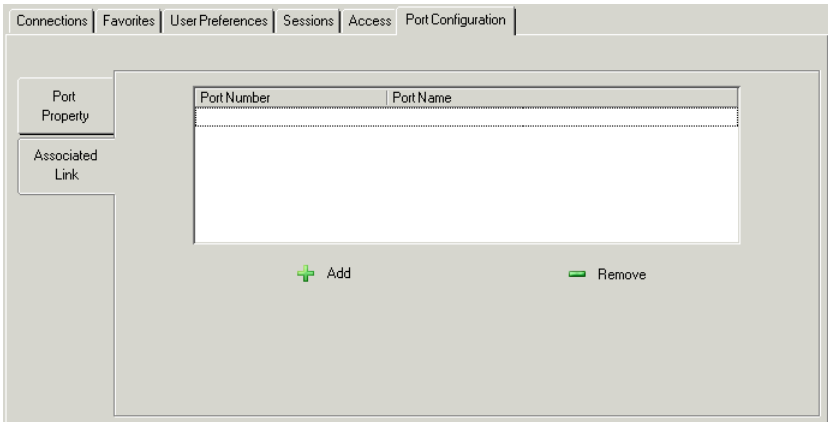

- ◆ To associate a port with the currently selected one, click **Add**. In the dialog box that appears, key in the port's number, then click **OK**. The port's number and name appear in the main panel.
- ◆ To remove an unwanted associated port, select it in the main panel, then click **Remove**.

Chapter 9

User Management

Overview

When you select the *User Management* tab the screen comes up with the *Users* page displayed:

Browser GUI

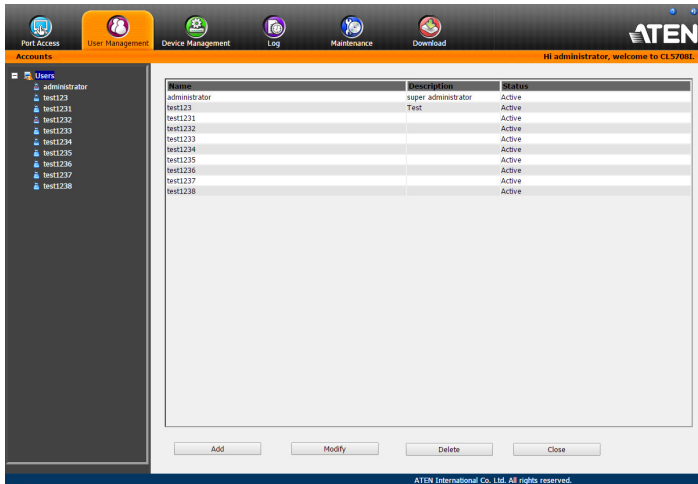

AP GUI

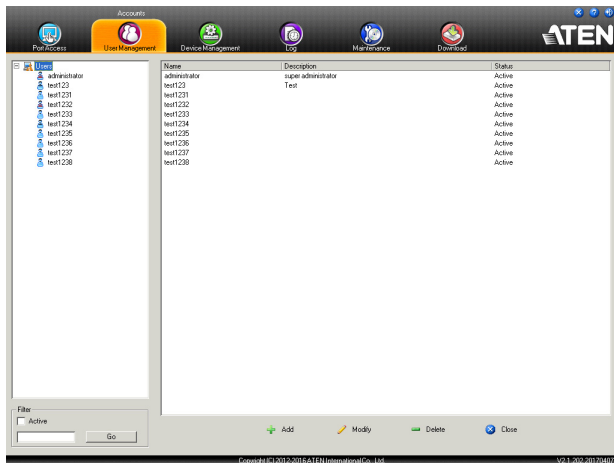

The page is organized into two main areas: the Sidebar at the left, and the large main panel at the right.

- ◆ Users appear in the panel at the left of the page. The large panel at the right provides more detailed information at-a-glance for each.
- ◆ In the Browser GUI, the sort order of the information displayed can be changed by clicking the main panel column headings.
- ◆ In the AP GUI, the section below the Sidebar list provides a filter that allows you to manage the list:

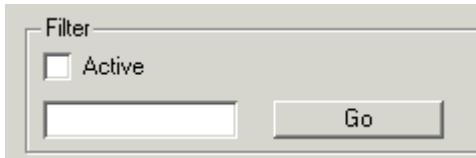

- ◆ Click to put a check in the *Active* checkbox to filter out any users whose accounts are not active.
- ◆ To only select Users that match a particular string, key it into the text box in front of the *Go* button, then click **Go**. Only Users that match the string will appear in the list.
Wildcards (? for single characters; * for multiple characters) and the keyword **or** are supported. E.g., h*ds would return hands and hoods; h?nd would return hand and hind, but not hard; h*ds or h*ks would return hands and hooks.
- ◆ The buttons below the main panel are used to manage users, as shown in the sections that follow.

Users

The KVM over IP switch supports three types of user, as shown in the table, below:

User Type	Role
Super Administrator	Access and manage ports and devices. Manage Users. Configure the overall installation. Configure personal working environment.
Administrator	Access and manage authorized ports and devices. Manage Users. Configure personal working environment.
User	Access authorized ports and devices. Manage authorized ports and devices; configure personal working environment. Note: Users who have been given permission to do so, may also manage other users.

Adding Users

To add a user, and assign user permissions, do the following:

1. Select *Accounts* on the menu bar (Browser GUI)

– or –

Select *Users* in the Sidebar (AP GUI).

2. Click **Add** at the bottom of the main panel. The User notebook opens, with the *User* tab selected:

The screenshot shows the 'User' tab in a GUI. It contains the following sections:

- User Information:**
 - Username: [Text Input]
 - Password: [Text Input]
 - Confirm Password: [Text Input]
 - Description: [Text Input]
- Role:**
 - Super Administrator
 - Administrator
 - User
- Permissions:**
 - Device Management
 - Port Configuration
 - User Management
 - Maintenance
 - System Log
 - View only
 - Windows Client
 - Java Client
 - Force to Grayscale
- Status:**
 - Disable account
 - Account never expires
 - Account expires on [Text Input]
 - User must change password at next logon
 - User cannot change password
 - Password never expires
 - Password expires after [Text Input] days

A 'Save' button is located at the bottom right of the form.

3. Enter the required information in the appropriate fields. A description of each of the fields is given in the table below:

Field	Description
Username	From 1 to16 characters are allowed depending on the Account Policy settings. See <i>Account Policy</i> , page 152.
Password	From 0 to16 characters are allowed depending on the Account Policy settings. See <i>Account Policy</i> , page 152.
Confirm Password	To be sure there is no mistake in the password, you are asked to enter it again. The two entries must match.
Description	Additional information about the user that you may wish to include.
Role	<p>There are three categories: Super Administrator, Administrator and User. There is no limitation on the number of accounts that can be created in each category.</p> <ul style="list-style-type: none">◆ The Super Administrator is responsible for the overall installation configuration and maintenance; user management; and device and port assignments. The Super Administrator's permissions (see page 131) are automatically assigned by the system and cannot be altered.◆ The default permissions for Administrators include everything except <i>View only</i> and <i>Force to Grayscale</i>, but the permissions can be altered for each Administrator by checking or unchecking any of the permissions checkboxes.◆ The default permissions for Users include the Win and Java clients, but the permissions can be altered for each User by checking or unchecking any of the permissions checkboxes.

Field	Description
<p>Permissions</p> <p>Note: For ordinary users, in addition to enabling <i>Device Management</i>, <i>Port Configuration</i>, and <i>Maintenance</i> permissions, the user must also be given those rights for each device and port that he will be allowed to manage. See <i>Device Assignment</i>, page 134 for details.</p>	<ul style="list-style-type: none"> ◆ Enabling <i>Device Management</i> allows a user to configure and control the settings for overall KVM over IP switch operations (see <i>Device Management</i>, page 137). ◆ Enabling <i>Port Configuration</i> allows a user to configure and control the settings for individual ports (see <i>Port Configuration</i>, page 123). ◆ Enabling <i>User Management</i> allows a user to create, modify, and delete user accounts. ◆ Enabling <i>Maintenance</i> allows a user to perform all the Maintenance operations available under the Maintenance tab (see <i>Maintenance</i>, page 165). ◆ Enabling <i>System Log</i> allows a user to access the system log (see <i>Log</i>, page 161). ◆ Enabling <i>View Only</i> limits users to only being able to view the display of connected devices. They cannot control port access, nor can they input any keyboard or mouse signals to the devices they view. ◆ Enabling <i>Windows Client</i> allows a user to download the Windows Client AP software, and access the KVM over IP switch with it, in addition to (or instead of) the browser access method. ◆ Enabling <i>Java Client</i> allows a user to download the Java Client AP software, and access the KVM over IP switch with it, in addition to (or instead of) the browser access method. ◆ <i>Force to Grayscale</i> forces the user's view of the remote display to be in grayscale. This can speed up I/O transfer in low bandwidth situations.

Field	Description
Status	<p>Status allows you to control the user's account and access to the installation, as follows:</p> <ul style="list-style-type: none"> ◆ <i>Disable Account</i> lets you suspend a user's account without actually deleting it, so that it can be easily reinstated in the future. ◆ If you don't want to limit the time scope of the account, select <i>Account never expires</i>; if you do want to limit the amount of time that the account remains in effect, select <i>Account expires on</i>, and key in the expiration date. ◆ To require a user to change his password at the next logon, select <i>User must change password at next logon</i>. This can be used by the administrator to give the user a temporary password to log in for the first time, and then let the user set the password of his choice for future logins. ◆ To make a password permanent, so that the user cannot change it to something else, select <i>User cannot change password</i>. ◆ For security purposes, administrators may want users to change their passwords from time to time. <ul style="list-style-type: none"> ◆ If not, select <i>Password never expires</i>. This allows users to keep their current passwords for as long as they like. ◆ If so, select <i>Password expires after</i>, and key in the number of days allowed before the password expires. Once the time is up, a new password must be set.

4. At this point you can assign the new user's port access rights by selecting the *Devices* tab – the *Devices* page is discussed on page 134.

Note: Optionally, you can skip this step now to add more users and come back to it later.

5. When your selections have been made click **Save**.
6. When the *Operation Succeeded* message appears, click **OK**.

7. Click **Users** in the Sidebar to return to the main screen. The new user appears in the Sidebar list and in the main panel, as well.
 - ♦ The Sidebar *Users* list can expand and collapse. If the list is expanded, click the minus symbol (–) next to the *Users* icon to collapse it; if it is collapsed there is a plus symbol (+) next to the icon. Click the plus symbol to expand it.
 - ♦ The icon for super administrators has two red bands; the icon for administrators has one black band.
 - ♦ The large main panel shows the user’s name; the description that was given when the account was created; and whether the account is currently active or has been disabled.

Modifying User Accounts

To modify a user account, do the following:

1. In the Sidebar *User* list, click the user’s name
– or –
In the main panel, select the user’s name
2. Click **Modify**.
3. In the *User* page that comes up, make your changes, then click **Save**.

Note: The *User* page is discussed on page 129; the *Devices* page is discussed on page 134.

Deleting User Accounts

To delete a user account do the following:

1. In the main panel, select the user’s name.
2. Click **Delete**.
3. Click **OK**.

Device Assignment

When a user logs in to the KVM over IP switch, the interface comes up with the Port Access page displayed. All the ports that the user is permitted to access are listed in the Sidebar at the left of the page. Access permissions for those ports and the devices connected to them are assigned on a port-by-port basis from the *User* list on the Sidebar of the User Management page.

Assigning Device Permissions From the User's Notebook

To assign a device permissions to a user from the *User's* notebook, do the following:

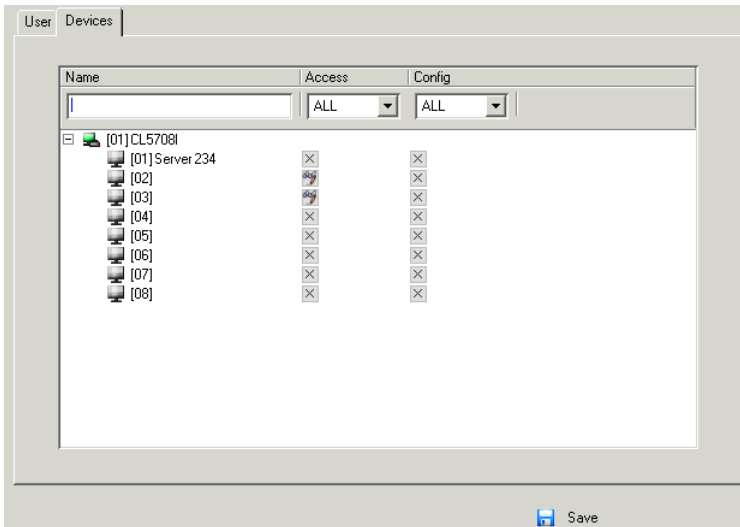

1. In the Sidebar *User* list, click the user's name
– or –
In the main panel, select the user's name.
2. Click **Modify**.
3. In the *User* notebook that comes up, select the *Devices* tab. A screen, similar to the one below, appears:



4. Make your permission settings for each port according to the information provided below:

Name: Each port accessible to the user is listed under the *Names* column.

Access: The *Access* column is where device access rights are set. Click the icon in the row that corresponds to the port you want to configure to cycle through the choices. The meanings of the icons are described in the table, below:

	Full Access	The user can view the remote screen and can perform operations on the remote server from his keyboard and monitor.
	View Only	The user can only view the remote screen; he cannot perform any operations on it.
	No Access	No access rights - the Port will not show up on the User's list on the Main Screen.

Config: The *Config* column is where a user's permission to make changes to a port's configuration settings are permitted/restricted. Click the icon in the row that corresponds to the port you want to configure to cycle through the choices.

A check mark (✓) indicates that the user has permission to make changes to the port's configuration settings; an X means that the user is denied permission to make configuration changes.

5. When you have finished making your choices, click **Save**.
6. In the confirmation popup that appears, click **OK**.

Note: In any of the columns, you can use Shift-Click or Ctrl-Click to select a group of ports to configure. Clicking to cycle through the choices on any one of the selected ports causes all of them to cycle in unison.

Filters

There are five filters at the top of the columns that allow you to expand or limit the scope of the ports that are displayed in the *Name* column, as described in the following table:

Filter	Description	
Name	<p>To filter on the port name, key in the name then press Enter. Only the ports whose names correspond to what you have keyed in appear in the list.</p> <p>Wildcards (? for single characters; * for multiple characters) and the keyword or are supported. E.g., h*ds would return hands and hoods; h?nd would return hand and hind, but not hard; h*ds or h*ks would return hands and hooks.</p>	
Access	All	All ports appear in the list.
	Full Access	Only ports configured as Full Access ports appear in the list.
	View Only	Only ports configured as View Only ports appear in the list.
	No Access	Only ports configured as No Access ports appear in the list.
Config	All	All ports appear in the list.
	Permitted	Only ports configured as Permitted appear in the list.
	Restricted	Only ports configured as Restricted appear in the list.

Chapter 10 Device Management

KVM Devices

Device Information

The Device Management page opens with the top level KVM over IP switch selected in the Sidebar and the *Device Information* item selected on the menu bar:

Browser GUI

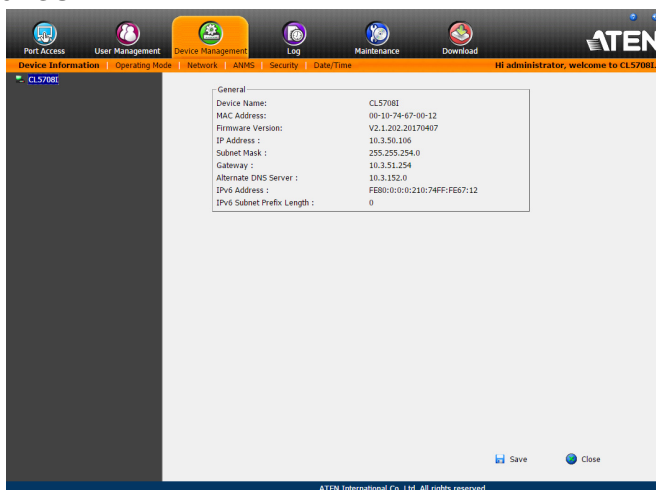

AP GUI

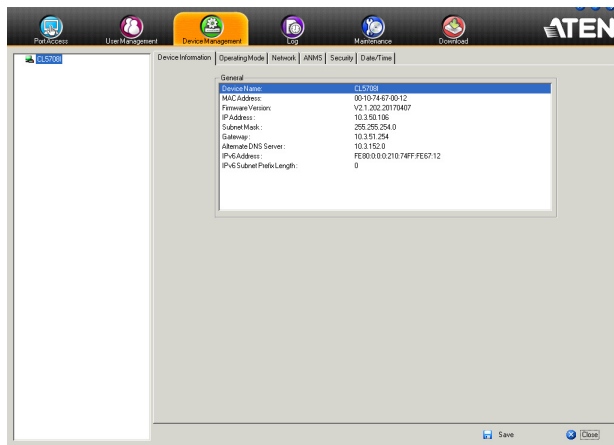

General

The *General* section of the Device Information page displays the name of the selected device, its firmware version and information about its network configuration.

Note: The AP GUI version presents the same information as the Browser version. Scroll through the list to see the additional entries.

Operating Mode

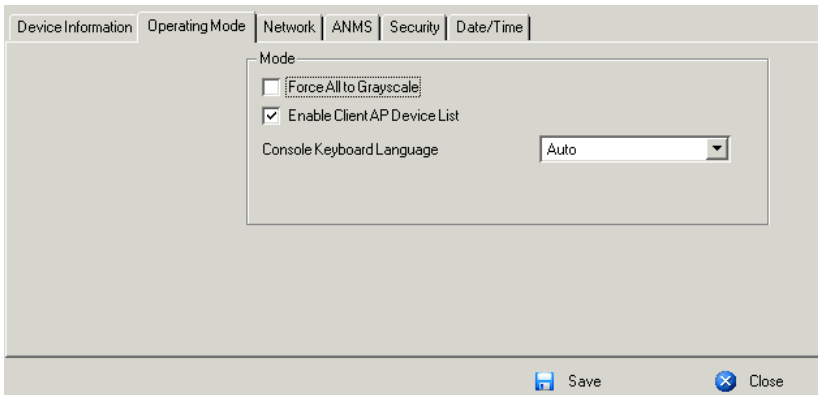

The Operating Mode page is used to set working parameters, as described below:

- If *Force all to grayscale* is enabled, the remote displays of all devices connected to the KVM over IP switch are changed to grayscale. This can speed up I/O transfer in low bandwidth situations.
- If *Enable Client AP Device List* is enabled, the switch appears in the Server List when using the WinClient or Java Client AP (see *Windows Client AP Login*, page 61, and *Java Client AP Login*, page 65). If this option is not enabled, the switch can still be connected to, but its name will not appear in the Server List.
- The *Console Keyboard Language* setting lets you specify which keyboard mapping is being used by the Local Console keyboard. Drop down the list to make your choice.

Network

The Network page is used to specify the network environment.

IP Installer
 Enabled View Only Disabled

Service Ports

Program:	<input type="text" value="9000"/>
HTTP:	<input type="text" value="80"/>
HTTPS:	<input type="text" value="443"/>

IPv4 Settings
IP Address:
 Obtain IP address automatically [DHCP]
 Set IP address manually [Fixed IP]

IP Address:	<input type="text" value="10.3.41.119"/>
Subnet Mask:	<input type="text" value="255.255.255.0"/>
Default Gateway:	<input type="text" value="10.3.41.254"/>

DNS Server:
 Obtain DNS server address automatically
 Set DNS server address manually

Preferred DNS server:	<input type="text" value="0.0.0.0"/>
Alternate DNS server:	<input type="text" value="10.3.152.0"/>

IPv6 Settings
IP Address:
 Obtain IPv6 address automatically [DHCP]
 Set IPv6 address manually [Fixed IP]

IPv6 Address:	<input type="text"/>
Subnet Prefix Length:	<input type="text" value="64"/>
Default Gateway:	<input type="text"/>

DNS Server:
 Obtain DNS server address automatically
 Set DNS server address manually

Preferred DNS server:	<input type="text"/>
Alternate DNS server:	<input type="text"/>

Network Transfer Rate:	<input type="text" value="99999"/>	KBps
------------------------	------------------------------------	------

Each of the elements on this page is described in the sections that follow.

IP Installer

The IP Installer is an external Windows-based utility for assigning IP addresses to the KVM over IP switch.

Click one of the radio buttons to select *Enable*, *View Only*, or *Disable* for the IP Installer utility. See *IP Installer*, page 225, for IP Installer details.

-
- Note:** 1. If you select *View Only*, you will be able to see the KVM over IP switch in the IP Installer's Device List, but you will not be able to change the IP address.
2. For security, we strongly recommend that you set this to *View Only* or *Disable* after each use.
-

Service Ports

As a security measure, if a firewall is being used, the Administrator can specify the port numbers that the firewall will allow. If a port other than the default is used, users must specify the port number as part of the IP address when they log in. If an invalid port number (or no port number) is specified, the KVM over IP switch will not be found. An explanation of the fields is given in the table below:

Field	Explanation
Program	This is the port number for connecting with the WinClient ActiveX Viewer, WinClient AP, Java Client Viewer, or Java Client AP. The default is 9000.
HTTP	The port number for a browser login. The default is 80.
HTTPS	The port number for a secure browser login. The default is 443.

-
- Note:** 1. Valid entries for all of the Service Ports are from 1–65535.
2. Service ports cannot have the same value. You must set a different value for each one.
3. If there is no firewall (on an Intranet, for example), it doesn't matter what these numbers are set to, since they have no effect.
-

- ◆ IPv4 Settings

- ◆ IP Address:

IPv4 is the traditional method of specifying IP addresses. The KVM over IP switch can either have its IP address assigned dynamically (DHCP), or it can be given a fixed IP address.

- ◆ For dynamic IP address assignment, select the *Obtain IP address automatically [DHCP]* radio button. (This is the default setting.)
 - ◆ To specify a fixed IP address, select the *Set IP address manually [Fixed IP]* radio button and fill in the fields with values appropriate for your network.

Note: 1. If you choose *Obtain IP address automatically [DHCP]*, when the switch starts up it waits to get its IP address from the DHCP server. If it hasn't obtained the address after one minute, it automatically reverts to its factory default IP address (192.168.0.60.)

2. If the switch is on a network that uses DHCP to assign network addresses, and you need to ascertain its IP address, see *IP Address Determination*, page 225, for information./

- ◆ DNS Server

- ◆ For automatic DNS Server address assignment, select the *Obtain DNS Server address automatically* radio button.
 - ◆ To specify the DNS Server address manually, select the *Set DNS server address manually* radio button, and fill in the addresses for the Preferred and Alternate DNS servers with values appropriate for your network.

Note: Specifying the Alternate DNS Server address is optional.

- ◆ IPv6 Settings

- ◆ IP Address:

IPv6 is the new (128-bit) format for specifying IP addresses. (See *IPv6*, page 227 for further information.) The KVM over IP switch can either have its IPv6 address assigned dynamically (DHCP), or it can be given a fixed IP address.

- ◆ For dynamic IP address assignment, select the *Obtain IP address automatically [DHCP]* radio button. (This is the default setting.)
 - ◆ To specify a fixed IP address, select the *Set IP address manually [Fixed IP]* radio button and fill in the fields with values appropriate for your network.
 - ◆ DNS Server
 - ◆ For automatic DNS Server address assignment, select the *Obtain DNS Server address automatically* radio button.
 - ◆ To specify the DNS Server address manually, select the *Set DNS server address manually* radio button, and fill in the addresses for the Preferred and Alternate DNS servers with values appropriate for your network.

Note: Specifying the Alternate DNS Server address is optional.

Network Transfer Rate

This setting allows you to tailor the size of the data transfer stream to match network traffic conditions by setting the rate at which the KVM over IP switch transfers data between itself and the client computers. The range is from 4–99999 Kilobytes per second (KBps).

Finishing Up

After making any network changes, be sure *Reset on exit* on the *Maintenance* → *System Operation* page (see *Reset on exit.*, page 170) has been enabled (there is a check in the checkbox), before logging out. This allows network changes to take effect without having to power the switch off and on.

ANMS

The ANMS (Advanced Network Management Settings) page is used to set up login authentication and authorization management from external sources. It is organized as a notebook with two tabs – each with a series of related panels, as described, below:

Event Destination

- ◆ Log Server

Important transactions that occur on the KVM over IP switch, such as logins and internal status messages, are kept in an automatically generated log file.

- ◆ Specify the MAC address of the computer that the Log Server runs on in the *MAC address* field.
- ◆ Specify the port used by the computer that the Log Server runs on to listen for log details in the *Port* field. The valid port range is 1–65535. The default port number is 9001.

Note: The port number must differ than the one used for the *Program* port (see *Program*, page 140).

See Chapter 15, *The Log Server*, for details on setting up the log server. The Log File is discussed on page 162.

Authentication

The screenshot shows the 'Authentication' configuration page. It is divided into three main sections:

- RADIUS Settings:**
 - Enable
 - Preferred RADIUS Server IP: [Text Field]
 - Preferred RADIUS Service Port: [0] [Spin Box]
 - Alternate RADIUS Server IP: [Text Field]
 - Alternate RADIUS Service Port: [0] [Spin Box]
 - Timeout: [0] [Spin Box] sec
 - Retries: [0] [Spin Box]
 - Shared Secret (at least 6 characters): [Text Field]
- AD/LDAP Settings:**
 - Enable
 - Type: LDAP LDAPS
 - LDAP Server: [Text Field] Port: [0] [Spin Box]
 - Admin DN: [Text Field] Timeout: [0] [Spin Box] sec
 - Admin Name: [Text Field]
 - Password: [Text Field]
 - Search DN: [Text Field]
- CC Management:**
 - Enable
 - CC Server IP: [Text Field] CC Service Port: [Text Field]

At the bottom right, there are 'Save' and 'Close' buttons.

◆ RADIUS Settings

To allow authentication and authorization for the KVM over IP switch through a RADIUS server, do the following:

1. Check **Enable**.
2. Fill in the IP addresses and service port numbers for the Preferred and Alternate RADIUS servers. You can use the IPv4 address, the IPv6 address or the domain name in the IP fields.
3. In the *Timeout* field, set the time in seconds that the KVM over IP switch waits for a RADIUS server reply before it times out.
4. In the *Retries* field, set the number of allowed RADIUS retries.
5. In the *Shared Secret* field, key in the character string that you want to use for authentication between the KVM over IP switch and the RADIUS Server. A minimum of 6 characters is required.
6. On the RADIUS server, Users can be authenticated with any of the following methods:
 - ◆ Set the entry for the user as **su/xxxx**

Where *xxxx* represents the Username given to the user when the account was created on the KVM over IP switch.

- ◆ Use the same Username on both the RADIUS server and the KVM over IP switch.
- ◆ Use the same Group name on both the RADIUS server and the KVM over IP switch.
- ◆ Use the same Username/Group name on both the RADIUS server and the KVM over IP switch.

In each case, the user's access rights are the ones assigned that were assigned when the User of Group was created on the KVM over IP switch. (See *Adding Users*, page 129.)

◆ LDAP / LDAPS Authentication and Authorization Settings

To allow authentication and authorization for the KVM over IP switch via LDAP / LDAPS, refer to the information in the table, below:

Item	Action
Enable	Put a check in the <i>Enable</i> checkbox to allow LDAP / LDAPS authentication and authorization.
Type	Click a radio button to specify whether to use LDAP or LDAPS.
LDAP Server IP and Port	Fill in the IP address and port number for the LDAP or LDAPS server. <ul style="list-style-type: none"> ◆ You can use the IPv4 address, the IPv6 address or the domain name in the <i>LDAP Server</i> field. ◆ For LDAP, the default port number is 389; for LDAPS, the default port number is 636.
Admin DN	Consult the LDAP / LDAPS administrator to ascertain the appropriate entry for this field. For example, the entry might look like this: <code>ou=kn8132,dc=aten,dc=com</code>
Admin Name	Key in the LDAP administrator's username.
Password	Key in the LDAP administrator's password.
Search DN	Set the distinguished name of the search base. This is the domain name where the search starts for user names.
Timeout	Set the time in seconds that the KVM over IP switch waits for an LDAP or LDAPS server reply before it times out.

On the LDAP / LDAPS server, Users can be authenticated with any of the following methods:

- ◆ With MS Active Directory schema.
- ◆ Without schema – Only the Usernames used on the KVM over IP switch are matched to the names on the LDAP / LDAPS server. User privileges are the same as the ones configured on the switch.
- ◆ Without schema – Only Groups in AD are matched. User privileges are the ones configured for the groups he belongs to on the switch.
- ◆ Without schema – Usernames and Groups in AD are matched. User privileges are the ones configured for the User and the Groups he belongs to on the switch.

Note: For more information on configuring LDAP, you can download the full LDAP instructional manual from our website.

CC Management Settings

To allow authorization for the KVM over IP switch through a CC (Control Center) server, check *Enable* and fill in the CC Server's IP address and Service port in the appropriate fields. You can use the IPv4 address, the IPv6 address or the domain name in the *CC Server IP* field.

Security

The Security page is divided into 7 main panels, as described in the sections that follow.

Login Failures

For increased security, the Login Failures section allows administrators to set policies governing what happens when a user fails to log in successfully.

The screenshot shows a configuration window titled "Login Failures". It contains the following elements:

- An "Enable" checkbox, which is currently unchecked.
- An "Allowed:" label followed by a text input field containing the number "5".
- A "Timeout:" label followed by a text input field containing the number "3" and a "min" label to its right.
- A "Lock Client PC" checkbox, which is currently unchecked.
- A "Lock Account" checkbox, which is currently unchecked.

To set the Login Failures policy, check the *Enable* checkbox (the default is for Login Failures to be enabled). The meanings of the entries are explained in the table below:

Entry	Explanation
Allowed	Sets the number of consecutive failed login attempts that are permitted from a remote computer. The default is 5 times.
Timeout	Sets the amount of time a remote computer must wait before attempting to login again after it has exceeded the number of allowed failures. The default is 3 minutes.
Lock Client PC	If this is enabled, after the allowed number of failures have been exceeded, the computer attempting to log in is automatically locked out. No logins from that computer will be accepted. The default is enabled. Note: This function relates to the client computer's IP. If the IP is changed, the computer will no longer be locked out.
Lock Account	If this is enabled, after the allowed number of failures have been exceeded, the user attempting to log in is automatically locked out. No logins from the username and password that have failed will be accepted. The default is enabled.

Note: If Login Failures is not enabled, users can attempt to log in an unlimited number of times with no restrictions. For security purposes, we recommend that you enable this function and enable the lockout policies.

Filter

The screenshot shows a window titled "Filter" with the following elements:

- Enable IP Filter
- Include
- Exclude
- A list box for IP filters.
- Buttons: Add, Modify, Delete.
- Login String:
- Enable MAC Filter
- Include
- Exclude
- A list box for MAC filters.
- Buttons: Add, Modify, Delete.

◆ IP and MAC Filtering

IP and MAC Filters control access to the KVM over IP switch based on the IP and/or MAC addresses of the client computers attempting to connect. A maximum of 100 IP filters and 100 MAC filters are allowed. If any filters have been configured, they appear in the IP Filter and/or MAC Filter list boxes.

To enable IP and/or MAC filtering, **Click** to put a check mark in the *IP Filter Enable* and/or *MAC Filter Enable* checkbox.

- ◆ If the include button is checked, all the addresses within the filter range are allowed access; all other addresses are denied access.
- ◆ If the exclude button is checked, all the addresses within the filter range are denied access; all other addresses are allowed access.

- ◆ Adding Filters

To add an IP filter, do the following:

1. Click **Add**. A dialog box similar to the one below appears:

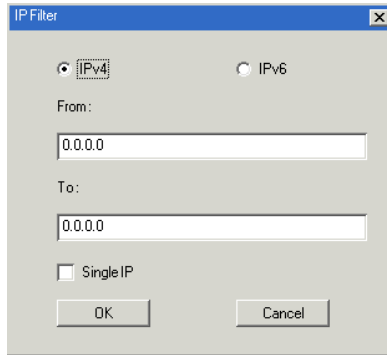

2. Specify whether you are filtering an IPv4 or IPv6 address.
3. Key the address you want to filter in the *From:* field.
 - ◆ To filter a single IP address, click to put a check in the *Single IP* checkbox.
 - ◆ To filter a continuous range of addresses, key in the end number of the range in the *To:* field.

Note: This description is for the AP GUI. The Browser GUI differs as follows:

1. It doesn't offer an IPv4 or IPv6 choice. It only has *From* and *To* fields for IPv4 filtering.
2. It doesn't have a checkbox to specify a single IP address. To filter a single IPv4 address, key the same address in both the *From* and *To* fields.

-
4. After filling in the address, click **OK**.
 5. Repeat these steps for any additional IP addresses you want to filter.

To add a MAC filter, do the following:

1. Click **Add**. A dialog box similar to the one below appears:

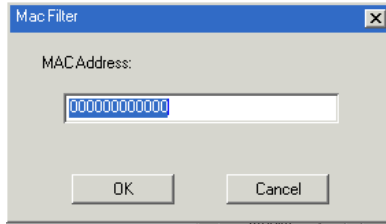

2. Specify the MAC address in the dialog box, then click **OK**.
3. Repeat these steps for any additional MAC addresses you want to filter.

- ◆ **IP Filter / MAC Filter Conflict**

If there is a conflict between an IP filter and a MAC filter – in other words, if a computer’s address is allowed by one filter but blocked by the other – then the blocking filter takes precedence (the computer’s access is blocked).

- ◆ **Modifying Filters**

To modify a filter, select it in the IP Filter or MAC Filter list boxes and click **Modify**. The Modify dialog box is similar to the Add dialog box. When it comes up, simply delete the old address(es) and replace it with the new one(s).

- ◆ **Deleting Filters**

To delete a filter, select it in the IP Filter or MAC Filter list box and click **Delete**.

Login String

The *Login String* entry field lets the super administrator specify a login string (in addition to the IP address) that users must add to the IP address when they access the KVM over IP switch with a browser.

For example, if *192.168.0.126* were the IP address, and *abcdefg* were the login string, then the user would have to key in:

```
192.168.0.126/abcdefg
```

Note: 1. Users must place a forward slash between the IP address and the string.

2. If no login string is specified here, anyone will be able to access the KVM over IP switch login page using the IP address alone. This makes your installation less secure.
-

The following characters are allowed in the string:

```
0-9 a-z A-Z ~ ! @ $ & * ( ) _ - = + [ ] .
```

The following characters are not allowed:

```
% ^ " : / ? # \ ' { } ; ' < > [Space]  
Compound characters (É Ç ñ ... etc.)
```

The following examples are not allowed:

```
192.168.0.126/.
```

```
192.168.0.126/..
```

```
192.168.0.126/...
```

For security purposes, we recommend that you change this string occasionally.

Account Policy

In the Account Policy section, system administrators can set policies governing usernames and passwords.

Account Policy

Minimum Username Length:

Minimum Password Length:

Password Must Contain At Least

One Upper Case

One Lower Case

One Number

Enforce Password History

The meanings of the Account Policy entries are explained in the table below:

Entry	Explanation
Minimum Username Length	Sets the minimum number of characters required for a username. Acceptable values are from 1–16. The default is 6.
Minimum Password Length	Sets the minimum number of characters required for a password. Acceptable values are from 0–16. A setting of 0 means that no password is required. Users can login with only a Username. The default is 6.
Password Must Contain At Least	<p>Checking any of these items requires users to include at least one uppercase letter, one lowercase letter or one number in their password.</p> <p>Note: This policy only affects user accounts created after this policy has been enabled, and password changes to existing user accounts. Users accounts created before this policy was enabled, and there is no change to the existing passwords, are not affected.</p>
Enforce Password History	Check this box to prevent users from using old passwords for the number of times entered in the box. A user will not be able to use the same password again until the number of password changes has been exceeded the number entered here.

Encryption

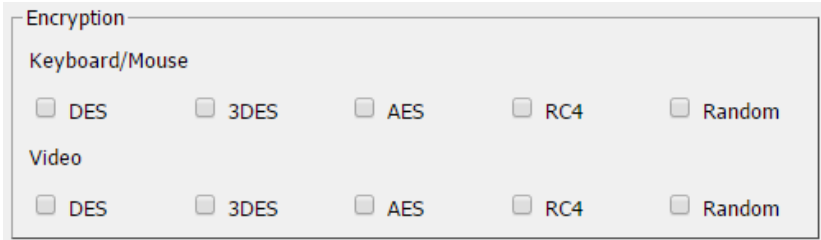

The screenshot shows a window titled "Encryption" with two sections: "Keyboard/Mouse" and "Video". Each section contains five checkboxes for encryption methods: DES, 3DES, AES, RC4, and Random. All checkboxes are currently unchecked.

Section	DES	3DES	AES	RC4	Random
Keyboard/Mouse	<input type="checkbox"/>	<input type="checkbox"/>	<input type="checkbox"/>	<input type="checkbox"/>	<input type="checkbox"/>
Video	<input type="checkbox"/>	<input type="checkbox"/>	<input type="checkbox"/>	<input type="checkbox"/>	<input type="checkbox"/>

These flexible encryption alternatives for keyboard/mouse and video data let you choose any combination of DES; 3DES; AES; RC4; or a Random cycle of any or all of them.

Enabling encryption affects system performance – no encryption offers the best performance; the greater the encryption the greater the adverse effect. If you enable encryption, the performance considerations are as follows:

- ◆ RC4 offers the least impact on performance; DES is next; then 3DES or AES
- ◆ The RC4 + DES combination offers the least impact of any combination

Mode

Mode

Enable ICMP

Enable Multiuser Operation

Browser Service : Disable Browser ▼

An explanation of the Mode items is given in the table, below:

Item	Explanation
Enable ICMP	If <i>ICMP</i> is enabled , the KVM over IP switch can be pinged. If it is not enabled, the device cannot be pinged. The default is Enabled.
Enable Multiuser Operation	Enabling <i>Multiuser operation</i> permits up to 32 users to log in at the same time to share the remote bus. If not enabled, only one user can log in at a time. The default is Enabled.
Browser Service	Enabling Browser Service allows the administrator to restrict browser access to the KVM over IP switch. After checking <i>Browser Service</i> , drop down the listbox to select the degree of restriction: Disable Browser: means no browser access is permitted. Disable HTTP: means browser access is permitted, but users must access the switch with an HTTPS URL. Disable HTTPS: means browser access is permitted, but users must access the switch with an HTTP URL.

Private Certificate

When logging in over a secure (SSL) connection, a signed certificate is used to verify that the user is logging in to the intended site. For enhanced security, the *Private Certificate* section allows you to use your own private encryption key and signed certificate, rather than the default ATEN certificate.

There are two methods for establishing your private certificate: generating a self-signed certificate; and importing a third-party certificate authority (CA) signed certificate.

- ◆ **Generating a Self-Signed Certificate**

If you wish to create your own self-signed certificate, a free utility – openssl.exe – is available for download over the web. See *Self-Signed Private Certificates*, page 237 for details about using OpenSSL to generate your own private key and SSL certificate.

- ◆ **Obtaining a CA Signed SSL Server Certificate**

For the greatest security, we recommend using a third party certificate authority (CA) signed certificate. To obtain a third party signed certificate, go to a CA (Certificate Authority) website to apply for an SSL certificate. After the CA sends you the certificate and private encryption key, save them to a convenient location on your computer.

- ◆ **Importing the Private Certificate**

To import the private certificate, do the following:

1. Click **Browse** to the right of *Private Key*; browse to where your private encryption key file is located; and select it.
2. Click **Browse** to the right of *Certificate*; browse to where your certificate file is located; and select it.
3. Click **Upload** to complete the procedure.

Note: 1. Clicking **Restore Default** returns the device to using the default ATEN certificate.

2. Both the private encryption key and the signed certificate must be imported at the same time.
-

Certificate Signing Request

The Certificate Signing Request (CSR) section provides an automated way of obtaining and installing a CA signed SSL server certificate.

To perform this operation do the following:

1. Click **Create CSR**. The following dialog box appears:

2. Fill in the form – with entries that are valid for your site – according to the example information in the following table:

Information	Example
Country (2 letter code)	TW
State or Province	Taiwan
Locality	Taipei
Organization	Your Company, Ltd.
Unit	Techdoc Department
Common Name	mycompany.com Note: This must be the exact domain name of the site that you want the certificate to be valid for. If the site's domain name is <i>www.mycompany.com</i> , and you only specify <i>mycompany.com</i> , the certificate will not be valid.
Email Address	administrator@yourcompany.com

3. After filling in the form (all fields are required), click **Create**.
A self-signed certificate based on the information you just provided is now stored on the KVM over IP switch.
4. Click **Get CSR**, and save the certificate file (*csr.cer*) to a convenient location on your computer
This is the file that you give to the third party CA to apply for their signed SSL certificate.
5. After the CA sends you the certificate, save it to a convenient location on your computer. Click **Browse** to locate the file; then click **Upload** to store it on the KVM over IP switch.

Note: When you upload the file, the KVM over IP switch checks the file to make sure the specified information still matches. If it does, the file is accepted; if not, it is rejected.

If you want to remove the certificate (to replace it with a new one because of a domain name change, for example), simply click **Remove CSR**.

Date/Time

The Date/Time dialog page sets the KVM over IP switch time parameters:

Time Zone

(GMT-12:00) Eniwetok Kwajalein ▾

Daylight Savings Time

Date

May ▾ < 2017 >

May 2017

Su	Mo	Tu	We	Th	Fr	Sa
	1	2	3	4	5	6
7	8	9	10	11	12	13
14	15	16	17	18	19	20
21	22	23	24	25	26	27
28	29	30	31			

Time

13 : 53 : 43 Set

Network Time

Enable auto adjustment

Preferred time server

AU | ntp1.cs.mu.OZ.AU ▾

Preferred custom server IP

Alternate time server

AU | ntp1.cs.mu.OZ.AU ▾

Alternate custom server IP

Adjust time every days Adjust Time Now

Set the parameters according to the information below.

Time Zone

- ◆ To establish the time zone that the KVM over IP switch is located in, drop down the *Time Zone* list and choose the city that most closely corresponds to where it is at.
- ◆ If your country or region employs Daylight Saving Time (Summer Time), check the corresponding checkbox.

Date

- ◆ Select the month from the drop down listbox.
- ◆ Click < or > to move backward or forward by one year increments.
- ◆ In the calendar, click on the day.
- ◆ To set the time, use the 24 hour HH:MM:SS format.
- ◆ Click **Set** to save your settings.

Network Time

To have the time automatically synchronized to a network time server, do the following:

1. Check the *Enable auto adjustment* checkbox.
2. Drop down the time server list to select your preferred time server
– or –

Check the *Preferred custom server IP* checkbox, and key in either the IPv4 address, IPv6 address, or domain name of the time server of your choice.

3. If you want to configure an alternate time server, check the *Alternate time server* checkbox, and repeat step 2 for the alternate time server entries.
4. Key in your choice for the number of days between synchronization procedures.
5. If you want to synchronize immediately, click **Adjust Time Now**.

This Page Intentionally Left Blank

Chapter 11 Log

Overview

The KVM over IP switch logs all the events that take place on it. To view the contents of the log, click the *Log* tab. The device's Log Information page, similar to the one below, appears:

Browser GUI

Time	Severity	User	Log Information
2017/05/11 09:47:31	Host	System	OP: User administrator from 10.3.41.129 (00-0B-E3-FF-FC-04) attempting to login via browse
2017/05/11 10:02:34	Host	System	OP: Session of user administrator has expired.
2017/05/11 10:11:11	Host	administrator	OP: User administrator from 10.3.41.129 logged out. Online time : 00:04:29:00.
2017/05/11 10:12:12	Host	System	OP: User administrator from 10.3.41.129 (00-0B-E3-FF-FC-04) attempting to login via browse.
2017/05/11 10:54:00	Host	System	OP: Session of user administrator has expired.
2017/05/11 13:38:12	Host	administrator	OP: User administrator logged in.
2017/05/11 13:38:12	Host	System	OP: User administrator from 10.3.41.129 attempting to login.
2017/05/11 13:38:12	Host	System	SVS: Access via windows client 10.3.41.129.
2017/05/11 13:38:12	Host	System	SVS: Connected to 10.3.41.129 (00-0B-E3-FF-FC-04).
2017/05/11 13:38:57	Host	System	OP: User administrator from 10.3.41.129 (00-0B-E3-FF-FC-04) attempting to login via browse.
2017/05/11 13:31:18	Host	System	OP: Session of user administrator has expired.
2017/05/11 13:20:18	Host	administrator	OP: User administrator from 10.3.41.129 logged out. Online time : 00:00:26:25.
2017/05/11 11:15:53	Host	administrator	OP: User administrator logged in.
2017/05/11 11:25:53	Host	System	OP: User administrator from 10.3.41.129 attempting to login.
2017/05/11 11:15:53	Host	System	SVS: Access via windows client 10.3.41.129.
2017/05/11 11:25:53	Host	System	SVS: Connected to 10.3.41.129 (00-0B-E3-FF-FC-04).
2017/05/11 11:23:05	Host	System	OP: User administrator from 10.3.41.129 (00-0B-E3-FF-FC-04) attempting to login via browse.
2017/05/10 22:48:04	Host	System	OP: Session of user administrator has expired.
2017/05/10 21:17:59	Least	administrator	UM: User administrator create account for user test228
2017/05/10 21:17:59	Least	administrator	UM: User administrator create account for user test227
2017/05/10 21:17:59	Least	administrator	UM: User administrator create account for user test226
2017/05/10 21:17:59	Least	administrator	UM: User administrator create account for user test225
2017/05/10 21:15:31	Least	administrator	UM: User administrator create account for user test224
2017/05/10 21:15:31	Least	administrator	UM: User administrator create account for user test223
2017/05/10 21:15:31	Least	administrator	UM: User administrator create account for user test222
2017/05/10 21:14:48	Least	administrator	UM: User administrator create account for user test221
2017/05/10 17:56:57	Host	System	OP: Session of user administrator has expired.
2017/05/10 17:56:57	Host	System	OP: User administrator from 10.3.41.129 attempting to login via browse.
2017/05/10 17:56:57	Host	System	OP: User administrator from 10.3.41.129 logged out. Online time : 00:03:34:00.
2017/05/10 17:56:57	Host	System	OP: User administrator from 10.3.41.129 (00-0B-E3-FF-FC-04) attempting to login via browse.
2017/05/10 17:28:08	Host	System	OP: Session of user administrator has expired.
2017/05/10 17:25:08	Host	System	OP: User administrator from 10.3.41.129 (00-0B-E3-FF-FC-04) attempting to login via browse.
2017/05/10 17:25:08	Host	System	OP: User administrator from 10.3.41.129 (00-0B-E3-FF-FC-04) logged out via browser.
2017/05/10 15:51:03	Least	administrator	OP: User administrator changes to 01-011.
2017/05/10 15:50:59	Least	administrator	OP: User administrator changes to 01-011.
2017/05/10 15:47:28	Least	administrator	OP: User administrator changes to 01-011.

AP GUI

Time	Severity	User	Log Information
2017/05/11 09:47:31	Host	System	OP: User administrator from 10.3.41.129 (00-0B-E3-FF-FC-04) attempting to login via browse.
2017/05/11 10:02:34	Host	System	OP: Session of user administrator has expired.
2017/05/11 10:11:11	Host	administrator	OP: User administrator from 10.3.41.129 logged out. Online time : 00:04:29:00.
2017/05/11 10:12:12	Host	System	OP: User administrator from 10.3.41.129 (00-0B-E3-FF-FC-04) attempting to login via browse.
2017/05/11 10:54:00	Host	System	OP: Session of user administrator has expired.
2017/05/11 13:38:12	Host	administrator	OP: User administrator logged in.
2017/05/11 13:38:12	Host	System	OP: User administrator from 10.3.41.129 attempting to login.
2017/05/11 13:38:12	Host	System	SVS: Access via windows client 10.3.41.129.
2017/05/11 13:38:12	Host	System	SVS: Connected to 10.3.41.129 (00-0B-E3-FF-FC-04).
2017/05/11 13:38:57	Host	System	OP: User administrator from 10.3.41.129 (00-0B-E3-FF-FC-04) attempting to login via browse.
2017/05/11 13:31:18	Host	System	OP: Session of user administrator has expired.
2017/05/11 13:20:18	Host	administrator	OP: User administrator from 10.3.41.129 logged out. Online time : 00:00:26:25.
2017/05/11 11:15:53	Host	administrator	OP: User administrator logged in.
2017/05/11 11:25:53	Host	System	OP: User administrator from 10.3.41.129 attempting to login.
2017/05/11 11:15:53	Host	System	SVS: Access via windows client 10.3.41.129.
2017/05/11 11:25:53	Host	System	SVS: Connected to 10.3.41.129 (00-0B-E3-FF-FC-04).
2017/05/11 11:23:05	Host	System	OP: User administrator from 10.3.41.129 (00-0B-E3-FF-FC-04) attempting to login via browse.
2017/05/10 22:48:04	Least	administrator	UM: User administrator create account for user test228
2017/05/10 21:17:59	Least	administrator	UM: User administrator create account for user test227
2017/05/10 21:17:59	Least	administrator	UM: User administrator create account for user test226
2017/05/10 21:17:59	Least	administrator	UM: User administrator create account for user test225
2017/05/10 21:15:31	Least	administrator	UM: User administrator create account for user test224
2017/05/10 21:15:31	Least	administrator	UM: User administrator create account for user test223
2017/05/10 21:15:31	Least	administrator	UM: User administrator create account for user test222
2017/05/10 21:14:48	Least	administrator	UM: User administrator create account for user test221
2017/05/10 17:56:57	Host	System	OP: Session of user administrator has expired.
2017/05/10 17:56:57	Host	System	OP: User administrator from 10.3.41.129 attempting to login via browse.
2017/05/10 17:56:57	Host	System	OP: User administrator from 10.3.41.129 logged out. Online time : 00:03:34:00.
2017/05/10 17:28:08	Host	System	OP: Session of user administrator has expired.
2017/05/10 17:25:08	Host	System	OP: User administrator from 10.3.41.129 (00-0B-E3-FF-FC-04) attempting to login via browse.
2017/05/10 17:25:08	Host	System	OP: User administrator from 10.3.41.129 (00-0B-E3-FF-FC-04) logged out via browser.
2017/05/10 15:51:03	Least	administrator	OP: User administrator changes to 01-011.
2017/05/10 15:50:59	Least	administrator	OP: User administrator changes to 01-011.
2017/05/10 15:47:28	Least	administrator	OP: User administrator changes to 01-011.

Log Information

The Log Information page displays events that take place on the KVM over IP switch, and provides a breakdown of the time, the severity, the user, and a description of each one. You can change the sort order of the display by clicking on the column headings.

The log file tracks a maximum of 512 events. When the limit is reached, the oldest events get discarded as new events come in. To record more than 512 events, see *The Log Server*, page 183. The purpose of the buttons at the bottom of the page are described in the following table:

Button	Explanation
Pause	Clicking <i>Pause</i> stops the display of new events. When the display is paused the button changes to <i>Resume</i> . Click Resume to start displaying events again.
Clear Log	Clicking <i>Clear Log</i> clears the log file.
Export Log	Clicking <i>Export Log</i> lets you save the contents of the log to a file on your computer.
Filter	Clicking <i>Filter</i> allows you to search for particular events by date or by specific words or strings, as described in the next section.

Filter

Filter lets you narrow the log event display to ones that occurred at specific times; ones containing specific words or strings; or ones involving specific users. When you access this function, the log filter dialog box appears at the bottom of the page:

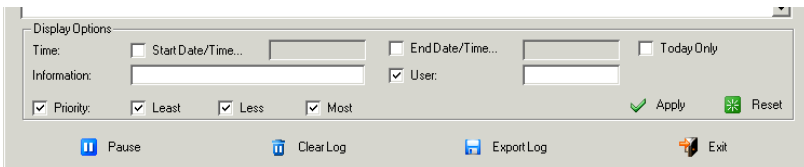

A description of the filter items is given in the table, below:

Item	Description
Time	<p>This feature lets you filter for events that occurred at specific times, as follows:</p> <p>Today Only: Only the events for the current day are displayed.</p> <p>Start Date/Time: Filters for events from a specific date and time to the present. Put a check in the checkbox to bring up a calendar. Set the date and time that you want the filtering to start from. All events from the Start date/time to the present are displayed.</p> <p>For the Web Browser interface, after checking Start Date/Time, you have to click inside the text box in order to bring up the calendar. When you have made your calendar choices, click the A icon at the lower right of the calendar panel.</p> <p>End Date/Time: Filters for events from a specific date and time to a specific date and time. First select the Start Date/Time (described above); check End Date/Time to set the ending date and time.</p> <p>For the Web Browser interface, after checking End Date/Time, you have to click inside the text box in order to bring up the calendar. When you have made your calendar choices, click the A icon at the lower right of the calendar panel.</p>
Information	<p>Filters for a particular word or string. Key the word or string into the <i>Information</i> text box. Only events containing that word or string are displayed. Wildcards (? for single characters; * for multiple characters) and the keyword or are supported. E.g., h*ds would return hands and hoods; h?nd would return hand and hind, but not hard; h*ds or h*ks would return hands and hooks.</p>
User	<p>Filters for specific users. First put a check in the <i>User</i> checkbox; then key in the user's Username; then click Apply. Only events containing that Username are displayed.</p> <p>Note: If the <i>User</i> checkbox is not checked here in the Filter panel, the entire User column does not appear in the main panel.</p>
Severity	<p>Filters based on the severity rating of the event. Least events appear in black; Less events appear in blue; Most events appear in red.</p> <p>First put a check in the <i>Severity</i> checkbox; then check the severity options you want to filter for (you can check more than one item). Only events that match the severity ratings you specified appear in the display.</p> <p>Note: If the <i>Severity</i> checkbox is not checked here in the Filter panel, the entire Severity column does not appear in the main panel.</p>
Apply	Click to apply the filter choices.
Reset	Click this button to clear the entries in the dialog box and start with a clean slate.
Exit	Click this button to exit the log filter function.

This Page Intentionally Left Blank

Chapter 12 Maintenance

Overview

The *Maintenance* function is used to upgrade firmware; backup and restore configuration and account information; send terminal commands, ping network devices; and restore default values.

Browser GUI

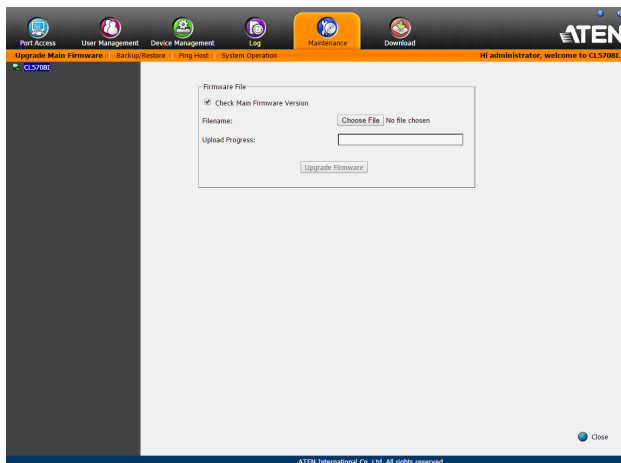

AP GUI

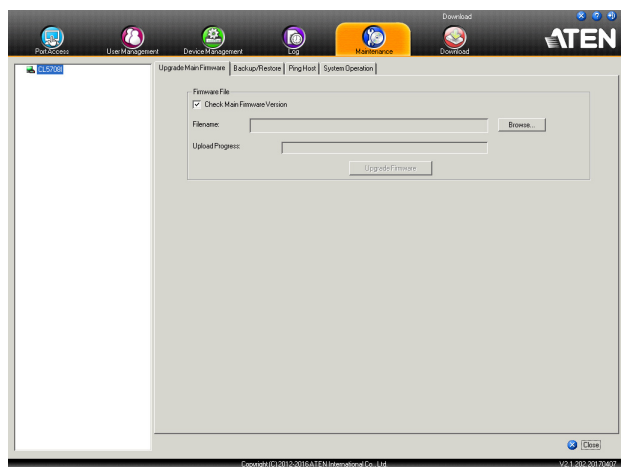

Firmware Upgrade

As new versions of the **iCard Firmware** become available, they can be downloaded from our website and installed using this page. Check the website regularly to find the latest information and packages to update your KVM switch. Our website provides firmware upgrade packages that are specific for each device. The **Mainboard Firmware** can only be upgraded via the Firmware Upgrade Port (see *The Firmware Upgrade Utility*, page 195 for details).

To upgrade the main firmware, do the following:

1. Download the new iCard firmware file to your computer.
2. Log in to the KVM over IP switch; and click the *Maintenance* tab. The Maintenance tab opens to the *Upgrade Main Firmware** page:

3. Click **Browse**; navigate to the directory that the new iCard firmware file is in and select the file.
4. Click **Upgrade Firmware** to start the upgrade procedure.
 - ◆ If you enabled *Check Main Firmware Version** the current firmware level is compared with that of the upgrade file. If the current version is equal to or higher than the upgrade version, a popup message appears, to inform you of the situation and stops the upgrade procedure.
 - ◆ If you didn't enable *Check Main Firmware Version**, the upgrade file is installed without checking what its level is.
 - ◆ As the upgrade proceeds, progress information is shown in the *Progress* bar.
 - ◆ Once the upgrade completes successfully, the switch resets itself.
5. Log in again, and check the firmware version to be sure it is the new one.

Note: The term “*Main Firmware*” in this section refers to the CL5708I / CL5716I’s iCard firmware and not the Mainboard firmware.

Backup/Restore

Selecting the Backup/Restore menu item gives you the ability to back up the switch's configuration and user profile information:

The screenshot shows a web interface for Backup/Restore. It is divided into two main sections: Backup and Restore. The Backup section contains a Password field and a Backup button. The Restore section contains a Filename field with a Choose File button and No file chosen text, a Password field, and three radio buttons: Select All (selected), User Account, and User Select. Below the radio buttons is an Options section with a table of checkboxes: Account, ANMS, Date/Time, Network, Security, and Operating Mode. A Restore button is located at the bottom of the Restore section.

Backup

To backup the device's settings do the following:

1. In the *Password* field, key in a password for the file.

Note: 1. Setting a password is optional. If you do not set one, the file can be restored without specifying a password.

2. If you do set a password, make a note of it, since you will need it to be able to restore the file.
-

2. Click **Backup**.
3. When the browser asks what you want to do with the file, select *Save to disk*; then save it in a convenient location.

Restore

To restore a previous backup, do the following:

1. Click **Browse**; navigate to the file and select it.

Note: If you renamed the file, you can leave the new name. There is no need to return it to its original name.

2. If you set a password when you created the file, key it in the *Password* field.
3. Select as many of the options that are presented as you wish to restore.
4. Click **Restore**.

After the file is restored, a message appears to inform you that the procedure succeeded.

Ping Host

The Ping Host page allows you to ping a device to check its connection status on the network. Enter an *IP address* or *Host Name* in the text box and then click **Ping** to ping a device.

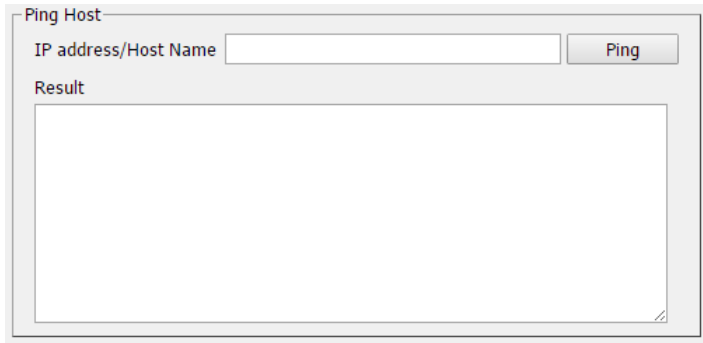

The image shows a dialog box titled "Ping Host". It contains a text input field labeled "IP address/Host Name" and a "Ping" button. Below the input field is a section labeled "Result" with a large empty rectangular area for displaying the ping results.

System Operation

The System Operation page lets you restore certain configuration changes that were made to the KVM over IP switch back to their original factory default values.

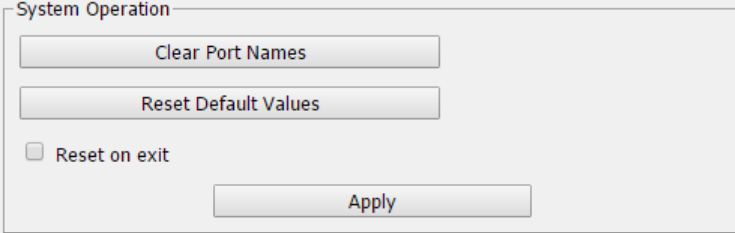

The screenshot shows a window titled "System Operation" with a light gray background. Inside the window, there are four main elements: a button labeled "Clear Port Names" at the top, a button labeled "Reset Default Values" below it, a checkbox labeled "Reset on exit" to the left of the text "Reset on exit", and a button labeled "Apply" at the bottom center.

The functions performed on this page are as follows:

Clear Port Names:

Clicking this button removes names that have been assigned to the ports

Restore Default Values:

Clicking this button undoes all Customization page changes that have been made to the KVM over IP switch (except for the Port Names), as well as the Network Transfer Rate (on the Network page), and returns the parameters to the original factory default settings.

Reset on exit:

Place a check here and click **Apply** to have the KVM over IP switch reset itself and implement all the new settings when you log out. (Following the reset, wait approximately 30 to 60 seconds before logging back in.)

If you change the switch's IP Address (see *Network*, page 139), the checkbox is automatically checked and the KVM switch will reset when you log out. If you clear the check mark before logging out, the changed IP settings will be ignored and the original IP address settings will remain in effect.

Note: Even though the changed IP settings are ignored, they still remain in the network settings fields. Which means that the next time you open this page the *Reset on exit* checkbox will automatically be enabled, and when the switch resets, the new IP settings that you thought you discarded will become the ones used by the switch. To avoid this problem, you should go back to the network settings page and be sure that the IP settings that appear in the fields are the ones you want to use.

Chapter 13

Download

Overview

Download is used to download stand-alone AP versions of the Windows Client, the Java Client, and the Log Server:

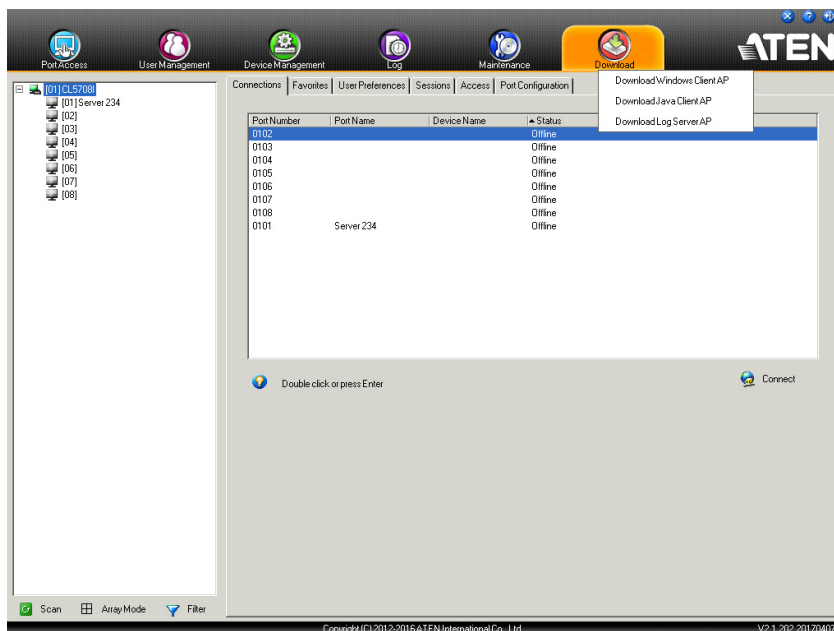

Click the program you want to download; save it to a convenient location on your hard disk, and run it from there.

This Page Intentionally Left Blank

Chapter 14

Port Operation

Overview

After you have successfully logged in (see *Logging In*, page 59), the KVM over IP switch opens to the Port Access tab's Connections page:

Browser GUI

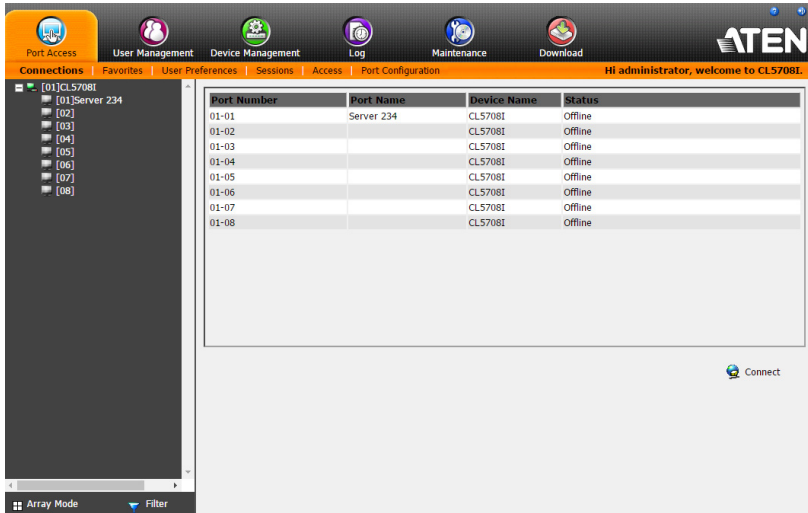

AP GUI

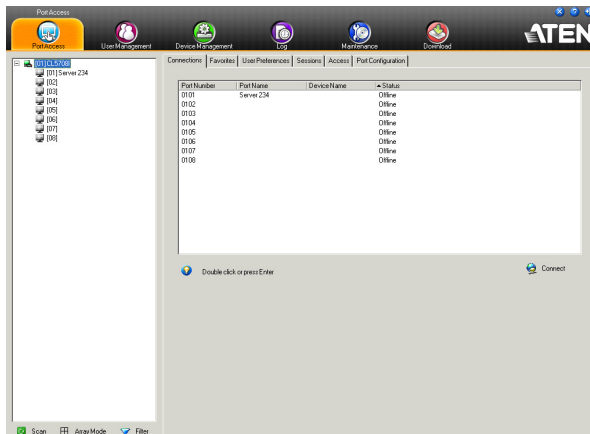

-
- Note:** 1. The WinClient and Java Client AP programs have a hidden Control Panel at the upper center of the screen that becomes visible when you mouse over it. The Browser version's Control Panel only appears after you switch to a port. The Control Panel is discussed on page 74.
2. See *KVM Devices and Ports – Connections Page*, page 111 for details about the Port Access *Connections* page.
-

Connecting to a Port

All the devices, ports, and outlets that a user is permitted to access are listed in the Sidebar at the left of the page.

- ◆ To connect to a port when a device is selected in the Sidebar, double click its icon in the Sidebar; or double click anywhere on its line entry in the main central panel; or select it in the main panel and click **Connect** at the bottom right of the page.
- ◆ To connect to a port when the port is selected in the Sidebar, click **Connect** at the right of the *Status* panel (see *Status*, page 112).

Once you switch to a port, its screen displays on your monitor, and your keyboard and mouse input affects the remote server:



The Port Toolbar

The KVM over IP switch's interface provides a toolbar to help you with port switching operations from within the captured port. To bring up the toolbar, tap the GUI Hotkey (Scroll Lock or Ctrl), twice. The toolbar appears at the upper left corner of the screen:

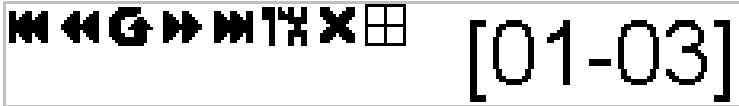

Depending on the settings that were selected for ID Display (see page 116), the Port Number and/or the Port Name display at the right of the toolbar. The meanings of the toolbar icons are given in a table on page 177.









When the toolbar displays mouse and keyboard input has no effect on the server connected to the port. To carry out operations on the server, close the toolbar by clicking its X icon.

To return to the Port Access *Connections* page, either click the appropriate icon (see *The Toolbar Icons*, page 177), or tap the GUI hotkey again.

-
- Note:** 1. You can adjust the toolbar transparency (see *Video Settings*, page 85).
2. The toolbar functions and icons are also incorporated in the Control Panel. If you choose to enable them in the Control Panel (see *Control Panel Configuration*, page 99), you can disable the Toolbar (see *User Preferences*, page 116 for details). To recall the Port Access *Connections* page when there is no Toolbar, simply tap the GUI hotkey twice.
-

The Toolbar Icons

The meanings of the toolbar icons are explained in the table below.

Icon	Purpose
	Click to skip to the first accessible port on the entire installation, without having to recall the Port Access page.
	Click to skip to the first accessible port previous to the current one, without having to recall the Port Access page.
	Click to begin Auto Scan Mode. The KVM over IP switch automatically switches among the ports that were selected for Auto Scanning with the <i>Filter</i> function (see <i>Filter</i> , page 107). This allows you to monitor their activity without having to switch among them manually.
	Click to skip from the current port to the next accessible one, without having to recall the Port Access page.
	Click to skip from the current port to the last accessible port on the entire installation, without having to recall the Port Access page.
	Click to return to the OSD.
	Click to close the toolbar.
	Click to invoke Panel Array Mode (see <i>Panel Array Mode</i> , page 181).

Toolbar Hotkey Port Switching

When the toolbar displays, you can use hotkeys to provide KVM focus to a port directly from the keyboard. The KVM over IP switch provides the following hotkey features:

- ◆ Going directly to a port by keying in its port number and clicking **Enter**.
- ◆ Auto Scanning
- ◆ Skip Mode Switching

The hotkeys are: **A** and **P** for Auto Scanning; and the **Arrow Keys** for Skip Mode.

-
- Note:** 1. In order for hotkey operations to take place, the toolbar must be visible (see *The Port Toolbar*, page 176).
2. To use the keys designated as hotkeys (i.e. A, P, etc.) for normal, non-hotkey purposes, you must first close the toolbar.
 3. For issues affecting multiple user operation in Auto Scan Mode, see *Panel Array Mode*, page 222.
-

Auto Scanning

The Scan function automatically switches among all the ports that are accessible to the currently logged on user at regular intervals, so that the user can monitor their activity automatically. Users can also limit the number of ports scanned with the Filter function of the Sidebar. See *KVM Devices and Ports – Connections Page*, page 111, and *Filter*, page 107, for further details.

- ◆ Setting the Scan Interval:

The amount of time Auto Scan dwells on each port is set with the *Scan Duration* setting (see *Scan Duration*, page 117).

- ◆ Invoking Auto Scan

To start Auto Scanning, with the toolbar showing, tap the **A** key. The Auto Scan function cycles through the ports in order – starting from the first port on the installation. An **S** appears in front of the Port ID Display to indicate that the port is being accessed under Auto Scan Mode.

- ◆ Pausing Auto Scan

While you are in Auto Scan Mode, you can pause the scanning in order to keep the focus on a particular server by pressing **P**. During the time that Auto Scanning is paused, the **S** in front of the Port ID blinks On and Off.

Pausing when you want to keep the focus on a particular server can be more convenient than exiting Auto Scan Mode because when you *Resume* scanning, you start from where you left off. If, on the other hand, you were to exit and then restart Auto Scan Mode, the scanning would start over from the very first server on the installation.

To *Resume* Auto Scanning after a pause, press any key except [Esc] or the [Spacebar]. Scanning continues from where it left off.

- ◆ Exiting Auto Scan

While Auto Scan Mode is in effect, ordinary keyboard functions are suspended. You must exit Auto Scan Mode in order to regain normal control of the keyboard. To exit Auto Scan Mode press [Esc] or the [Spacebar]. Auto Scanning stops when you exit Auto Scan Mode.

Skip Mode

Skip Mode allows you to switch ports in order to monitor the servers manually. You can dwell on a particular port for as long or as little as you like - as opposed to Auto Scanning, which automatically switches after a fixed interval. The Skip Mode hotkeys are the four Arrow keys. Their operation is explained in the table below:

Arrow	Action
←	Skips from the current port to the first accessible port previous to it.
→	Skips from the current port to the first accessible port that comes after it.
↑	Skips from the current port to the very first accessible port on the installation.
↓	Skips from the current port to the very last accessible port on the installation.

Recalling the Port Access Page

To dismiss the toolbar and bring back the Port Access page, do one of the following:

- ◆ Tap the GUI Hotkey once.
- ◆ From the toolbar, click the icon that recalls the Port Access page (see *The Toolbar Icons*, page 177).

The toolbar closes, and the Port Access Page appears.

GUI Hotkey Summary Table

The following table presents a summary of the GUI Hotkey actions after you have accessed a port. See *User Preferences*, page 116 to set the GUI Hotkey.

To...		Do This...
Open the Toolbar		Click the GUI Hotkey twice
Open the Port Access Page	The Toolbar is open	Click the GUI Hotkey once
	The Toolbar is not open	Click the GUI Hotkey three times

Panel Array Mode







Clicking the toolbar's *Panel* icon invokes Panel Array Mode. Under this mode, the screen divides into a grid of up to 42 panels:



- ◆ Each panel represents one of the switch's ports beginning with Port 1 at the upper left, and going from left to right; top to bottom.
- ◆ The number of panels in the array can be selected by clicking the **Show More Ports**, and **Show Fewer Ports** symbols on the panel array toolbar (see the following page for an explanation of the panel array toolbar).
- ◆ When the Array is first invoked, it scans through each of the ports that were selected for Auto Scanning with the *Filter* function (see *Filter*, page 107). As it scans, the border of the panel that has the focus becomes highlighted.
- ◆ Only ports that are accessible to the user are displayed. For ports that are not accessible, the panel is blank.
- ◆ If the server connected to a port is on line, its screen displays in its panel, otherwise the panel is blank.
- ◆ Mousing over a panel displays information about the port (port name, online status, port access status, and resolution).
- ◆ You can access a server connected to a port by moving the mouse pointer over its panel and clicking. You switch to the server exactly as if you had selected it from the Port Access page.

Panel Array Toolbar

The panel array toolbar provides shortcut navigation and control of the panel array. The toolbar can be dragged anywhere on the screen. Mousing over an icon brings up a “tooltip” that provides a short description of the icon’s function. The icon functions are described in the table below:

	Click and drag to move the toolbar. Note: This icon is only available with the Windows Clients. To move the Java Client toolbars, click on any empty space and drag.
	Pause panel scanning, leaving the focus on the panel that currently has it.
	Show More Ports: Increase the number of panels in the array.
	Show Fewer Ports: Decrease the number of panels in the array.
	Toggle 4/3 aspect ratio.
	Exit Panel Array mode.

Note: For issues affecting multiple user operation in Panel Array Mode, see *Panel Array Mode*, page 222.

Chapter 15

The Log Server

The Windows-based Log Server is an administrative utility that records all the events that take place on selected KVM over IP switches and writes them to a searchable database. This chapter describes how to install and configure the Log Server.

Installation

1. Log into the KVM over IP switch (see page 59).
2. Click the *Download* tab and download the Log Server AP program.
3. Go to the location on your hard disk that you downloaded the Log Server program to, and double click its icon (*LogSetup.exe*) to bring up the **Setup** screen.

Note: If the browser cannot run the file, save it to disk, instead, and run the file from your disk.

The Log Server installation screen appears:

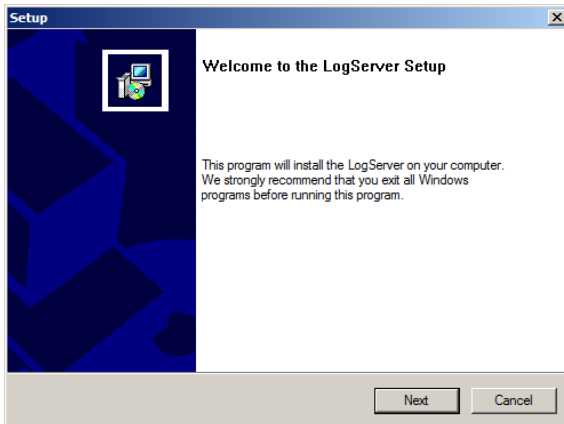

4. Click **Next**. Then follow the on-screen instructions to complete the installation and have the Log Server program icon placed on your desktop.

Starting Up

To start the Log Server, either double click the program icon, or key in the full path to the program on the command line. The first time you run it, a screen similar to the one below appears:

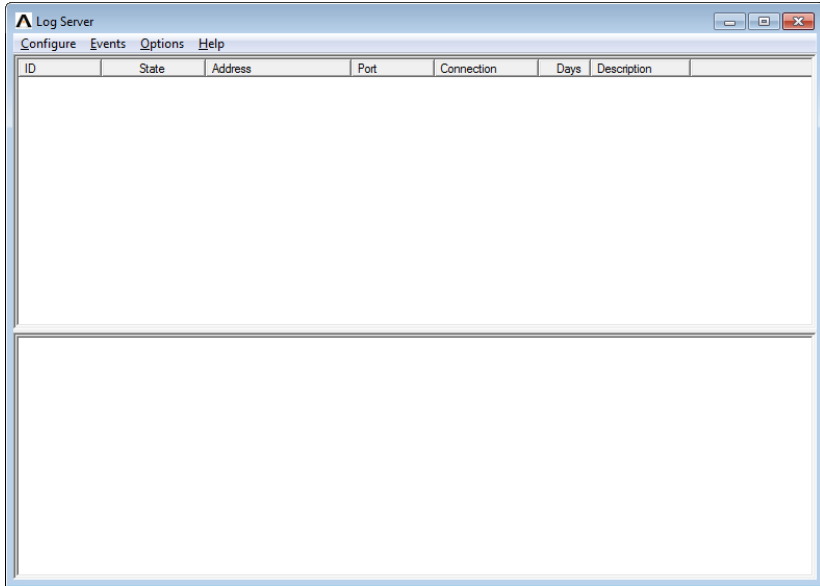

-
- Note:**
1. The MAC address of the Log Server computer must be specified in the *ANMS* settings – see *Log Server*, page 143.
 2. The Log Server requires the Microsoft Jet OLEDB 4.0 driver. See *The Log Server program does not run.*, page 222 if the program doesn't start.
-

The screen is divided into three components:

- ◆ A *Menu Bar* at the top
- ◆ A panel that will contain a list of KVM over IP switches in the middle (see *The Log Server Main Screen*, page 190).
- ◆ A panel that will contain an *Events List* at the bottom

Each of the components is explained in the sections that follow.

The Menu Bar

The Menu bar consists of four items:

- ◆ Configure
- ◆ Events
- ◆ Options
- ◆ Help

These are discussed in the sections that follow.

Note: If the Menu Bar appears to be disabled, click in the List window to enable it.

Configure

The Configure menu contains three items: Add; Edit; and Delete. They are used to add new units to the List; edit the information for units already on the list; or delete units from the list.

- ◆ To add a unit to the list, click **Add**.
- ◆ To edit or delete a listed unit, first select the target in the List window, then open this menu and click **Edit** or **Delete**.

When you choose *Add* or *Edit*, a dialog box, similar to the one below, appears:

The screenshot shows a dialog box titled "Add a Server". It contains the following fields and controls:

- Address:** A text box containing "Server Address".
- Port:** A text box containing "9001".
- Description:** A text box containing "Server Description".
- Limit:** A text box containing "100" followed by the label "Days".
- Enable automatic export for every:** A checkbox that is currently unchecked, followed by a text box containing "1" and the label "Days".
- Save to:** A text box that is empty, followed by a "Browse..." button.
- Buttons:** "OK" and "Cancel" buttons at the bottom.

A description of the fields is given in the table, below:

Field	Explanation
Address	This can either be the IP address of the computer the Log Server is running on, or its DNS name.
Port	The port number that was assigned to the Log Server under <i>Device Management</i> (see <i>Log Server</i> , page 143).
Description	This field is provided so that you can put in a descriptive reference for the unit to help identify it.
Limit	This specifies the number of days that an event should be kept in the Log Server's database. Events that exceed the amount of time specified here can be removed with the Maintenance function (see <i>Maintenance.</i> , page 188).
Enable Automatic Export for every / Save to	Check the box and enter the number of days to pass before the system auto exports a log file. Click Browse to select the directory location where the log file will export to.

Fill in or modify the fields, then click **OK** to finish.

Events

The Events Menu has two items: *Search* and *Maintenance*.

Search:

Search allows you to search for events containing specific words or strings. When you access this function, a screen, similar to the one below, appears:

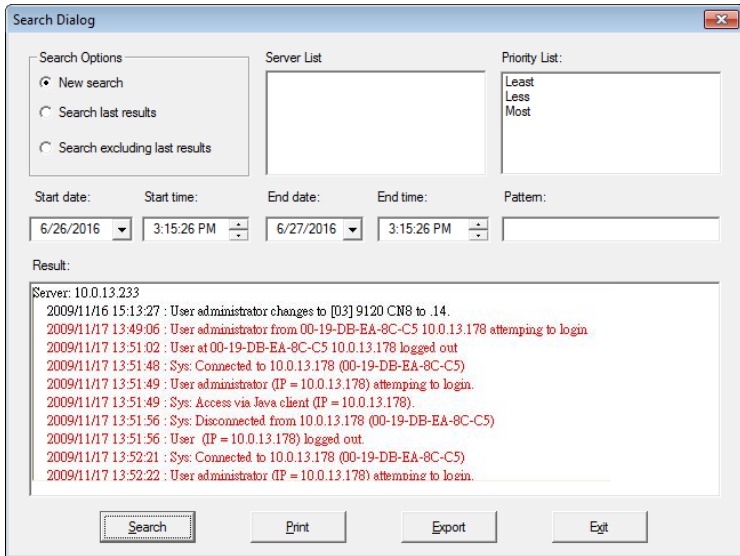

A description of the items is given in the table, below:

Item	Description
New search	This is one of three radio buttons that define the scope of the search. If it is selected, the search is performed on all the events in the database for the selected unit.
Search last results	This is a secondary search performed on the events that resulted from the previous search.
Search excluding last results	This is a secondary search performed on all the events in the database for the selected unit excluding the events that resulted from the previous search.
Server List	KVM over IP switches are listed according to their IP address. Select the unit that you want to perform the search on from this list. You can select more than one unit for the search. If no units are selected, the search is performed on all of them.
Priority	Sets the level for how detailed the search results display should be. <i>Least</i> is the most general; <i>Most</i> is the most specific. Least results appear in black; Less results appear in blue; Most results appear in red.
Start Date	Select the date that you want the search to start from. The format follows the YYYY/MM/DD convention, as follows: 2009/11/04
Start Time	Select the time that you want the search to start from. The format follows the HH:MM:SS convention.
End Date	Select the date that you want the search to end at.

Item	Description
End Time	Select the time that you want the search to end at.
Pattern	Key in the pattern that you are searching for here. The multiple character wildcard (%) is supported. E.g., h%ds would match hands and hoods.
Results	Lists the events that contained matches for the search.
Search	Click this button to start the search.
Print	Click this button to print the search results.
Export	Click this button to save the search results to file.
Exit	Click this button to exit the Log Server.

Maintenance:

This function allows the administrator to perform manual maintenance of the database, such as erasing specified records before their expiration time is up.

Options

Network Retry allows you to set the number of seconds that the Log Server should wait before attempting to connect if its previous attempt to connect failed. When you click this item, a dialog box, similar to the one below, appears:

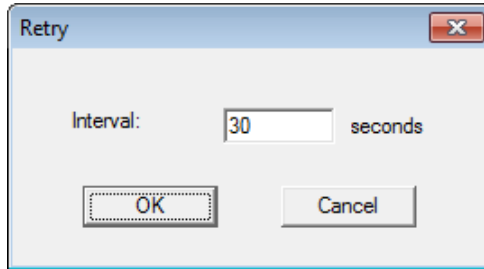

Key in the number of seconds, then click **OK** to finish.

Help

From the Help menu, click Contents to access the online Windows Help file. The help file contains instructions about how to setup, operation and troubleshoot the Log Server.

The Log Server Main Screen

Overview

The Log Server Main Screen is divided into two main panels.

- The upper (List) panel lists all of the units that have been selected for the Log Server to track (see *Configure*, page 185).
- The lower (Event) panel displays the tick information for the currently selected unit. (If there are more than one unit, the selected unit is the one that is highlighted).
- To select a unit in the list, simply click on it.

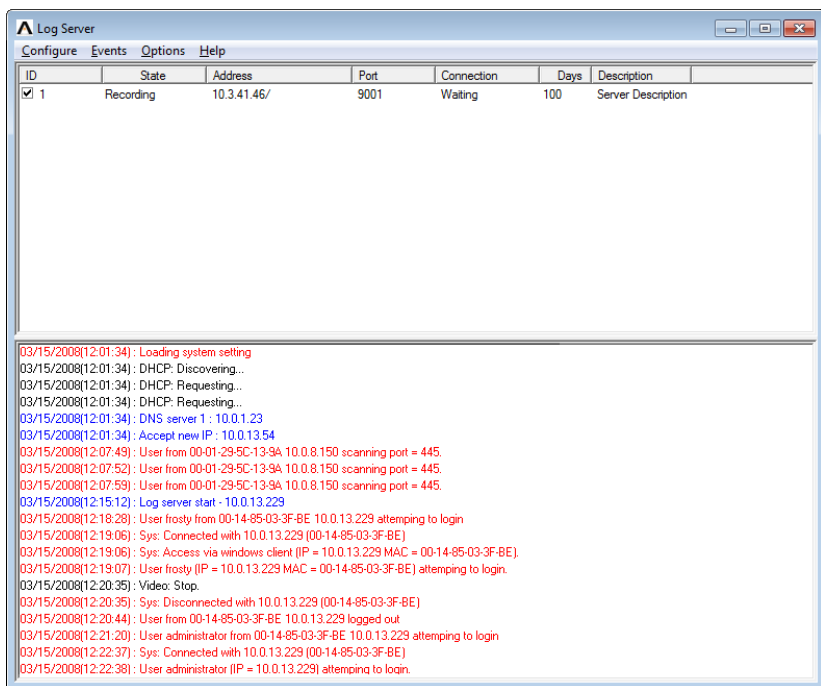

The List Panel

The List panel contains six fields:

Field	Explanation
ID / State	Shows the ID number of the device and determines whether the Log Server records the ticks for this unit, or not. If the ID checkbox is checked, the State field displays <i>Recording</i> , and the ticks are recorded. If the ID checkbox is not checked, the State field displays <i>Paused</i> , and the ticks are not recorded. Note: Even though a unit is not the currently selected one, if its Recording checkbox is checked, the Log Server will still record its ticks.
Address	This is the IP Address or DNS name that was given to the unit when it was added to the Log Server (see <i>Configure</i> , page 185).
Port	This is the Access Port number assigned to the unit (see <i>Configure</i> , page 185).
Connection	<ul style="list-style-type: none"> ◆ If the Log Server is connected to the unit, this field displays <i>Connected</i>. ◆ If the Log Server is not connected, this field displays <i>Waiting</i>. This means that the Log Server's MAC address has not been set properly. It needs to be set on the <i>Device Management Date/Time</i> page (see page 158).
Days	This field displays the number of days that the unit's log events are to be kept in the Log Server's database before expiration (see <i>Configure</i> , page 185).
Description	This field displays the descriptive information given for the unit when it was added to the Log Server (see <i>Configure</i> , page 185).

The Event Panel

The lower panel displays log events for the currently selected unit. Note that if there are more than one units, even though they aren't currently selected, if their *Recording* checkbox is checked, the Log Server records their log events and keeps them in its database.









This Page Intentionally Left Blank

Chapter 16

Keyboard Emulation

Mac Keyboard







The PC compatible (101/104 key) keyboard can emulate the functions of the Mac keyboard. The emulation mappings are listed in the table below.

PC Keyboard	Mac Keyboard
[Shift]	Shift
[Ctrl]	Ctrl
	
[Ctrl] [1]	
[Ctrl] [2]	
[Ctrl] [3]	
[Ctrl] [4]	
[Alt]	Alt
[Print Screen]	F13
[Scroll Lock]	F14
	=
[Enter]	Return
[Backspace]	Delete
[Insert]	Help
[Ctrl] 	F15

Note: When using key combinations, press and release the first key (Ctrl), then press and release the activation key.

Sun Keyboard

The PC compatible (101/104 key) keyboard can emulate the functions of the Sun keyboard when the Control key [Ctrl] is used in conjunction with other keys. The corresponding functions are shown in the table below.

PC Keyboard	Sun Keyboard
[Ctrl] [T]	Stop
[Ctrl] [F2]	Again
[Ctrl] [F3]	Props
[Ctrl] [F4]	Undo
[Ctrl] [F5]	Front
[Ctrl] [F6]	Copy
[Ctrl] [F7]	Open
[Ctrl] [F8]	Paste
[Ctrl] [F9]	Find
[Ctrl] [F10]	Cut
[Ctrl] [1]	
[Ctrl] [2]	
[Ctrl] [3]	
[Ctrl] [4]	
[Ctrl] [H]	Help
	Compose
	

Note: When using key combinations, press and release the first key (Ctrl), then press and release the activation key.

Chapter 17

The Firmware Upgrade Utility

Introduction

The purpose of the Windows-based firmware upgrade utility is to provide an automated process for upgrading the CL5708I / CL5716I's **Mainboard Firmware** and compatible adapter cable firmware. The program comes as part of a firmware upgrade package that is specific for each device.

The CL5708I / CL5716I's **iCard Firmware** can only be upgraded via the Browser or AP GUI (see *Firmware Upgrade*, page 166 for details).

As new firmware versions become available, new firmware upgrade packages are posted on our website. Check the website regularly to find the latest information and packages.

Downloading the Firmware Upgrade Package

To download the firmware upgrade package:

1. From a computer that is not part of your KVM installation go to our website and choose the model name that relates to your device. A list of available firmware upgrade packages appears.
2. Choose the firmware upgrade package that you wish to install (usually the most recent) and download it to your computer.

Preparation

To prepare for the firmware upgrade, do the following:

1. Use the *firmware upgrade cable* (provided with this unit), to connect a COM port on your computer to the *firmware upgrade port* of your switch.

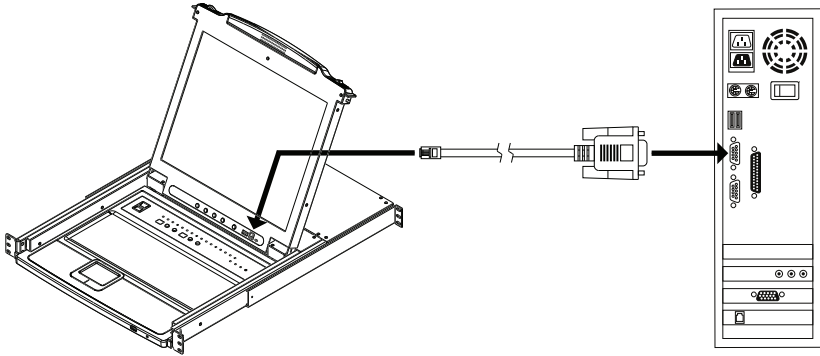

Note: On a daisy chained installation, the chained stations will automatically receive the upgrade via the daisy chain cables.

2. Shut down all the computers, but not the stations, on the KVM installation.
3. From your KVM switch console, login to the OSD as the administrator (see page 33) and select the **F4 ADM** function.
4. Scroll down to FIRMWARE UPGRADE. Press **[Enter]**, then press **[Y]** to invoke *Firmware Upgrade Mode* (see page 42.).

Note: During *Firmware Upgrade Mode*, the port LEDs will flash on and off.

Starting the Upgrade

To upgrade the firmware:

1. Run the downloaded firmware upgrade package file either by double-clicking the file icon, or by opening a command line and entering the full path to it.

The *Firmware Upgrade Utility* welcome screen appears:

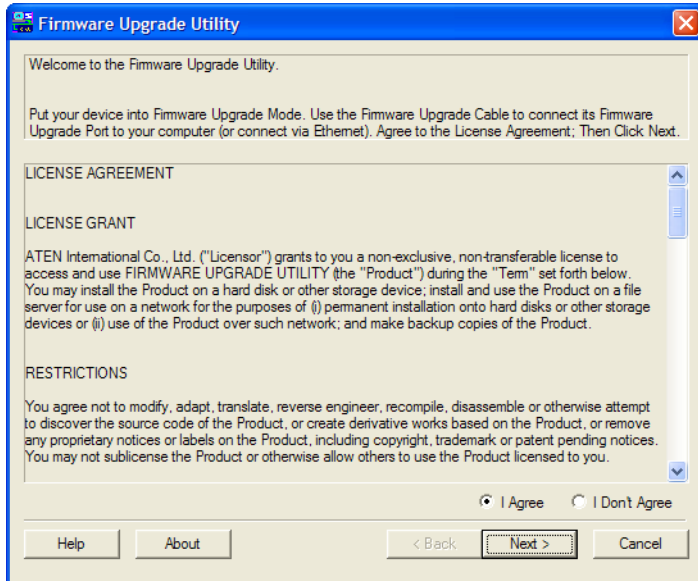

Note: The screens shown in this section are for reference only. The wording and layout of the actual screens put up by the *Firmware Upgrade Utility* may vary slightly from these examples.

2. Read and *Agree* to the License Agreement (enable the I Agree radio button).
3. Click **Next** to continue.

The *Firmware Upgrade Utility* main screen appears. The devices capable of being upgraded are listed in the *Device List* panel:

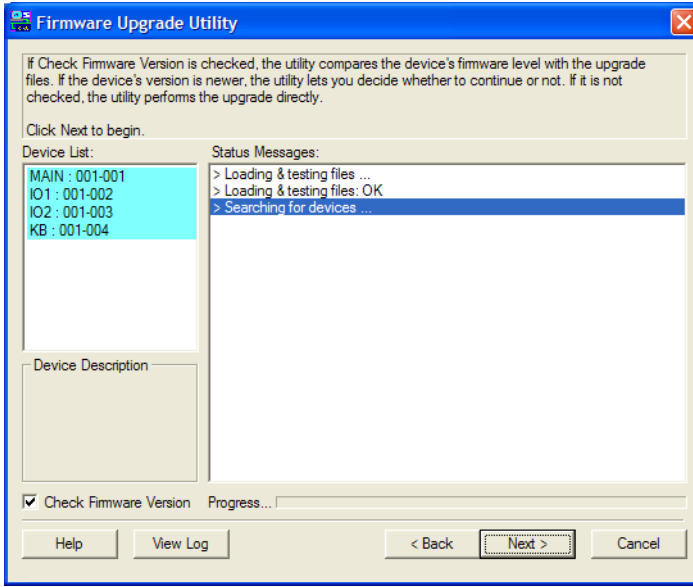

4. Click **Next** to perform the upgrade.

If you enabled *Check Firmware Version*, the utility compares the device's firmware level with that of the upgrade files. If it finds that the device's version is higher than the upgrade version, it brings up a dialog box informing you of the situation and gives you the option to continue or cancel.

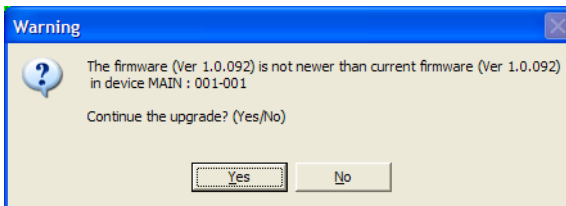

If you didn't enable *Check Firmware Version*, the utility installs the upgrade files without checking whether they are a higher level, or not.

As the upgrade proceeds, status messages appear in the *Status Messages* panel, and the progress toward completion is shown on the *Progress* bar.

Upgrade Succeeded

After the upgrade has completed, a screen appears to inform you that the procedure was successful:

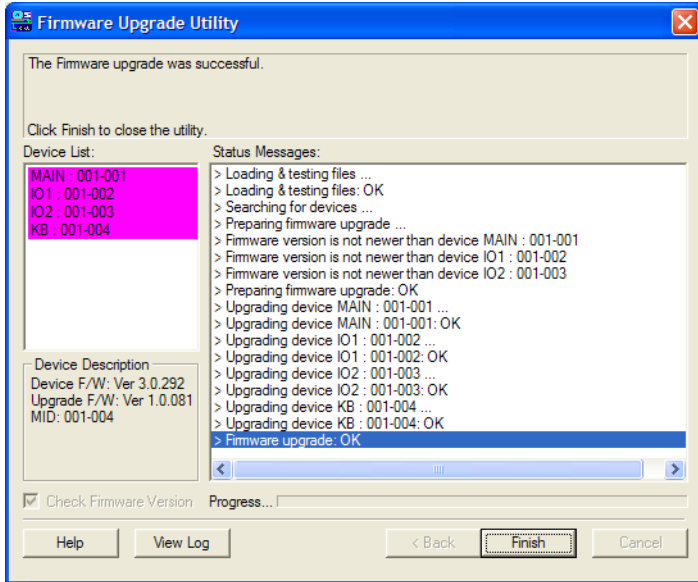

Click **Finish** to close the firmware upgrade utility.

Upgrade Failed

If the firmware upgrade fails (*Upgrade Succeeded* screen does not appear), you can recover the situation.

Possible reasons for firmware upgrade failure are:

- ◆ When a firmware upgrade was manually aborted.
- ◆ When the unit's firmware becomes corrupted for some reason and you are unable to operate it.
- ◆ When a firmware upgrade procedure is interrupted.
- ◆ When a firmware upgrade procedure fails.

To recover a failed firmware upgrade, do the following:

1. Click **Cancel** to close the Firmware Upgrade Utility.
2. Power off the unit.
3. Connect the *firmware upgrade cable* to its *firmware upgrade port*.
4. Slide the *firmware upgrade switch* to the **Recover** position.
5. Power the unit back on and repeat the upgrade procedure (see *Starting the Upgrade* on page 197).
6. After the unit has been successfully upgraded, power it off, and slide the *firmware upgrade switch* back to the **Normal** position.
7. Power the unit back on again.

Safety Instructions

General

- ◆ This product is for indoor use only.
- ◆ Read all of these instructions. Save them for future reference.
- ◆ Follow all warnings and instructions marked on the device.
- ◆ Do not place the device on any unstable surface (cart, stand, table, etc.). If the device falls, serious damage will result.
- ◆ Do not use the device near water.
- ◆ Do not place the device near, or over, radiators or heat registers.
- ◆ The device cabinet is provided with slots and openings to allow for adequate ventilation. To ensure reliable operation, and to protect against overheating, these openings must never be blocked or covered.
- ◆ The device should never be placed on a soft surface (bed, sofa, rug, etc.) as this will block its ventilation openings. Likewise, the device should not be placed in a built in enclosure unless adequate ventilation has been provided.
- ◆ Never spill liquid of any kind on the device.
- ◆ Unplug the device from the wall outlet before cleaning. Do not use liquid or aerosol cleaners. Use a damp cloth for cleaning.
- ◆ Avoid circuit overloads. Before connecting equipment to a circuit, know the power supply's limit and never exceed it. Always review the electrical specifications of a circuit to ensure that you are not creating a dangerous condition or that one doesn't already exist. Circuit overloads can cause a fire and destroy equipment.
- ◆ The device should be operated from the type of power source indicated on the marking label. If you are not sure of the type of power available, consult your dealer or local power company.
- ◆ The device is designed for IT power distribution systems with 230V phase-to-phase voltage.
- ◆ To prevent damage to your installation it is important that all devices are properly grounded.
- ◆ The device is equipped with a 3-wire grounding type plug. This is a safety feature. If you are unable to insert the plug into the outlet, contact your

electrician to replace your obsolete outlet. Do not attempt to defeat the purpose of the grounding-type plug. Always follow your local/national wiring codes.

- ◆ Do not allow anything to rest on the power cord or cables. Route the power cord and cables so that they cannot be stepped on or tripped over.
- ◆ If an extension cord is used with this device make sure that the total of the ampere ratings of all products used on this cord does not exceed the extension cord ampere rating. Make sure that the total of all products plugged into the wall outlet does not exceed 15 amperes.
- ◆ To help protect your system from sudden, transient increases and decreases in electrical power, use a surge suppressor, line conditioner, or un-interruptible power supply (UPS).
- ◆ Position system cables and power cables carefully; Be sure that nothing rests on any cables.
- ◆ Never push objects of any kind into or through cabinet slots. They may touch dangerous voltage points or short out parts resulting in a risk of fire or electrical shock.
- ◆ Do not attempt to service the device yourself. Refer all servicing to qualified service personnel.
- ◆ If the following conditions occur, unplug the device from the wall outlet and bring it to qualified service personnel for repair.
 - ◆ The power cord or plug has become damaged or frayed.
 - ◆ Liquid has been spilled into the device.
 - ◆ The device has been exposed to rain or water.
 - ◆ The device has been dropped, or the cabinet has been damaged.
 - ◆ The device exhibits a distinct change in performance, indicating a need for service.
 - ◆ The device does not operate normally when the operating instructions are followed.
- ◆ Only adjust those controls that are covered in the operating instructions. Improper adjustment of other controls may result in damage that will require extensive work by a qualified technician to repair.
- ◆ Do not connect the RJ-11 connector marked “UPGRADE” to a public telecommunication network.

Rack Mounting

- ◆ Before working on the rack, make sure that the stabilizers are secured to the rack, extended to the floor, and that the full weight of the rack rests on the floor. Install front and side stabilizers on a single rack or front stabilizers for joined multiple racks before working on the rack.
- ◆ Always load the rack from the bottom up, and load the heaviest item in the rack first.
- ◆ Make sure that the rack is level and stable before extending a device from the rack.
- ◆ Use caution when pressing the device rail release latches and sliding a device into or out of a rack; the slide rails can pinch your fingers.
- ◆ After a device is inserted into the rack, carefully extend the rail into a locking position, and then slide the device into the rack.
- ◆ Do not overload the AC supply branch circuit that provides power to the rack. The total rack load should not exceed 80 percent of the branch circuit rating.
- ◆ Make sure that all equipment used on the rack – including power strips and other electrical connectors – is properly grounded.
- ◆ Ensure that proper airflow is provided to devices in the rack.
- ◆ Ensure that the operating ambient temperature of the rack environment does not exceed the maximum ambient temperature specified for the equipment by the manufacturer
- ◆ Do not step on or stand on any device when servicing other devices in a rack.
- ◆ **Caution:** Slide/rail (LCD KVM) mounted equipment is not to be used as a shelf or a work space.



Consignes de sécurité

Général

- ♦ Ce produit est destiné exclusivement à une utilisation à l'intérieur.
- ♦ Veuillez lire la totalité de ces instructions. Conservez-les afin de pouvoir vous y référer ultérieurement.
- ♦ Respectez l'ensemble des avertissements et instructions inscrits sur l'appareil.
- ♦ Ne placez jamais l'unité sur une surface instable (chariot, pied, table, etc.). Si l'unité venait à tomber, elle serait gravement endommagée.
- ♦ N'utilisez pas l'unité à proximité de l'eau.
- ♦ Ne placez pas l'unité à proximité de ou sur des radiateurs ou bouches de chaleur.
- ♦ Le boîtier de l'unité est doté de fentes et d'ouvertures destinées à assurer une ventilation adéquate. Pour garantir un fonctionnement fiable et protéger l'unité contre les surchauffes, ces ouvertures ne doivent jamais être bloquées ou couvertes.
- ♦ L'unité ne doit jamais être placée sur une surface molle (lit, canapé, tapis, etc.) car ses ouvertures de ventilation se trouveraient bloquées. De même, l'unité ne doit pas être placée dans un meuble fermé à moins qu'une ventilation adaptée ne soit assurée.
- ♦ Ne renversez jamais de liquides de quelque sorte que ce soit sur l'unité.
- ♦ Débranchez l'unité de la prise murale avant de la nettoyer. N'utilisez pas de produits de nettoyage liquide ou sous forme d'aérosol. Utilisez un chiffon humide pour le nettoyage de l'unité.
- ♦ Évitez toute surcharge du circuit. Avant de connecter l'équipement à un circuit, vérifiez la limite de l'alimentation et ne la dépassez pas. Contrôlez toujours les caractéristiques électriques d'un circuit pour vous assurer de ne pas créer de situation dangereuse ou qu'il n'y en a pas déjà. Les surcharges du circuit peuvent provoquer un incendie et détruire l'équipement.
- ♦ L'appareil doit être alimenté par le type de source indiqué sur l'étiquette. Si vous n'êtes pas sûr du type d'alimentation disponible, consultez votre revendeur ou le fournisseur local d'électricité.
- ♦ Afin de ne pas endommager votre installation, vérifiez que tous les périphériques sont correctement mis à la terre.

-
- ◆ L'unité est équipée d'une fiche de terre à trois fils. Il s'agit d'une fonction de sécurité. Si vous ne parvenez pas à insérer la fiche dans la prise murale, contactez votre électricité afin qu'il remplace cette dernière qui doit être obsolète. N'essayez pas d'aller à l'encontre de l'objectif de la fiche de terre. Respectez toujours les codes de câblage en vigueur dans votre région/pays.
 - ◆ L'équipement doit être installé à proximité de la prise murale et le dispositif de déconnexion (prise de courant femelle) doit être facile d'accès.
 - ◆ La prise murale doit être installée à proximité de l'équipement et doit être facile d'accès.
 - ◆ Veillez à ce que rien ne repose sur le cordon d'alimentation ou les câbles. Acheminez le cordon d'alimentation et les câbles de sorte que personne ne puisse marcher ou trébucher dessus.
 - ◆ En cas d'utilisation d'une rallonge avec cette unité, assurez-vous que le total des ampérages de tous les produits utilisés sur cette rallonge ne dépasse pas l'ampérage nominal de cette dernière. Assurez-vous que le total des ampérages de tous les produits branchés sur la prise murale ne dépasse pas 15 ampères.
 - ◆ Pour contribuer à protéger votre système contre les augmentations et diminutions soudaines et transitoires de puissance électrique, utilisez un parasurtenseur, un filtre de ligne ou un système d'alimentation sans coupure (UPS).
 - ◆ Placez les câbles du système et les câbles d'alimentation avec précaution ; veillez à ce que rien ne repose sur aucun des câbles.
 - ◆ Lors du branchement ou du débranchement à des blocs d'alimentation permettant la connexion à chaud, veuillez respecter les lignes directrices suivantes:
 - ◆ Installez le bloc d'alimentation avant de brancher le câble d'alimentation à celui-ci.
 - ◆ Débranchez le câble d'alimentation avant de retirer le bloc d'alimentation.
 - ◆ Si le système présente plusieurs sources d'alimentation, déconnectez le système de l'alimentation en débranchant tous les câbles d'alimentation des blocs d'alimentation.
 - ◆ N'insérez jamais d'objets de quelque sorte que ce soit dans ou à travers les fentes du boîtier. Ils pourraient entrer en contact avec des points de tension dangereuse ou court-circuiter des pièces, entraînant ainsi un risque d'incendie ou de choc électrique.
-

- ◆ N'essayez pas de réparer l'unité vous-même. Confiez toute opération de réparation à du personnel qualifié.
- ◆ Si les conditions suivantes se produisent, débranchez l'unité de la prise murale et amenez-la à un technicien qualifié pour la faire réparer:
 - ◆ Le cordon d'alimentation ou la fiche ont été endommagés ou éraillés.
 - ◆ Du liquide a été renversé dans l'unité.
 - ◆ L'unité a été exposée à la pluie ou à l'eau.
 - ◆ L'unité est tombée ou le boîtier a été endommagé.
 - ◆ Les performances de l'unité sont visiblement altérées, ce qui indique la nécessité d'une réparation.
 - ◆ L'unité ne fonctionne pas normalement bien que les instructions d'utilisation soient respectées.
- ◆ N'utilisez que les commandes qui sont abordées dans le mode d'emploi. Le réglage incorrect d'autres commandes peut être à l'origine de dommages qui nécessiteront beaucoup de travail pour qu'un technicien qualifié puisse réparer l'unité.
- ◆ Ne connectez pas le connecteur RJ-11 portant la marque « Sensor » (Capteur) à un réseau de télécommunication public.

Montage sur bâti

- ◆ Avant de travailler sur le bâti, assurez-vous que les stabilisateurs sont bien fixés sur le bâti, qu'ils sont étendus au sol et que tout le poids du bâti repose sur le sol. Installez les stabilisateurs avant et latéraux sur un même bâti ou bien les stabilisateurs avant si plusieurs bâtis sont réunis, avant de travailler sur le bâti.
- ◆ Chargez toujours le bâti de bas en haut et chargez l'élément le plus lourd en premier.
- ◆ Assurez-vous que le bâti est à niveau et qu'il est stable avant de sortir une unité du bâti.
- ◆ Agissez avec précaution lorsque vous appuyez sur les loquets de libération du rail d'unité et lorsque vous faites coulisser une unité dans et hors d'un bâti ; vous pourriez vous pincer les doigts dans les rails.
- ◆ Une fois qu'une unité a été insérée dans le bâti, étendez avec précaution le rail dans une position de verrouillage puis faites glisser l'unité dans le bâti.
- ◆ Ne surchargez pas le circuit de l'alimentation CA qui alimente le bâti. La charge totale du bâti ne doit pas dépasser 80 % de la capacité du circuit.
- ◆ Assurez-vous que tous les équipements utilisés sur le bâti, y-compris les multiprises et autres connecteurs électriques, sont correctement mis à la terre.
- ◆ Assurez-vous que les unités présentes dans le bâti bénéficie d'une circulation d'air suffisante.
- ◆ Assurez-vous que la température ambiante de fonctionnement de l'environnement du bâti ne dépasse pas la température ambiante maximale spécifiée pour l'équipement par le fabricant.
- ◆ Ne marchez sur aucun appareil lors de la maintenance d'autres appareils d'un bâti.
- ◆ **Attention:** Glisser / rail (LCD KVM) monté l'équipement ne doit pas être utilisé comme une étagère ou un espace de travail.



Technical Support

International

- ◆ For online technical support – including troubleshooting, documentation, and software updates: **<http://eservice.aten.com>**
- ◆ For telephone support, see *Telephone Support*, page vii:

North America

Email Support		support@aten-usa.com
Online Technical Support	Troubleshooting Documentation Software Updates	http://support.aten.com
Telephone Support		1-888-999-ATEN ext 4988 1-949-428-1111

When you contact us, please have the following information ready beforehand:

- ◆ Product model number, serial number, and date of purchase.
- ◆ Your computer configuration, including operating system, revision level, expansion cards, and software.
- ◆ Any error messages displayed at the time the error occurred.
- ◆ The sequence of operations that led up to the error.
- ◆ Any other information you feel may be of help.

Specifications

Function		CL5708I	
LCD	CL5708IM	17"	
	CL5708IN	19"	
Computer Connections	Direct	8	
	Max	128 (via Daisy-Chain)	
Port Selection		OSD, Hotkeys, Pushbuttons	
Connectors	External Console Port	1 x SPHD Male (Yellow)	
	External Mouse Port	1 x USB Type-A Female (Front)	
	KVM Ports	8 x SPHD Female(Yellow)	
	Daisy Chain	1 x DB-25 Male	
	FW Upgrade	1 x RJ-11 Female	
	Power	1 x IEC 60320/C14	
	LAN	1 x RJ45 Female	
	USB 1.1 Hub	1 x USB Type-A Female	
Switches	Reset	1 x Semi-recessed Pushbutton	
	Power	1 x Rocker Switch	
	Firmware Upgrade	1 x Switch	
	LCD Adjust	4 x Pushbutton	
	LCD On/Off	1 x LED Pushbutton (Orange)	
	Port Selection	2 x Pushbutton	
	Station Selection	2 x Pushbutton	
LEDs	Online	8 (Orange)	
	10/100 Mbps	1 (Orange/Green)	
	Port ID	2 x 7-segment LED Display (Yellow)	
	Station ID	2 x 7-segment LED Display (Yellow)	
	Power	1 (Dark Green)	
	Lock	Num	1 (Green)
		Caps	1 (Green)
Scroll		1 (Green)	
Emulation	Keyboard / Mouse	PS/2, USB	
Video	Local	1280 x 1024 @ 75 Hz; DDC2B	
	Remote	1920 x 1200 @ 60 Hz	
Scan Interval (OSD Select)		1–255 sec.	
I/P Rating		100–240 VAC, 50/60 Hz, 1 A	

Function		CL57081
Power Consumption		17": 120V, 15.2W / 230V, 16W 19": 120V, 24W / 230V, 25W
Environment	Operating Temp.	0–50° C
	Storage Temp.	-20–60° C
	Humidity	0–80% RH, Noncondensing
Physical Properties	Housing	Metal + Plastic
	Weight	17": 13.49 kg 19": 13.41 kg
	Dimensions (L x W x H)	17": 48.00 x 64.27 x 4.40 cm 19": 48.00 x 68.92 x 4.40 cm

Function		CL57161
LCD	CL57161M	17"
	CL57161N	19"
Computer Connections	Direct	16
	Max	256 (via Daisy-Chain)
Port Selection		OSD, Hotkeys, Pushbuttons
Connectors	External Console Port	1 x SPHD Male (Yellow)
	External Mouse Port	1 x USB Type-A Female (Front)
	KVM Ports	16 x SPHD Female (Yellow)
	Daisy Chain	1 x DB-25 Male
	FW Upgrade	1 x RJ-11 Female
	Power	1 x IEC 60320/C14
	LAN	1 x RJ45 Female
	USB 1.1 Hub	1 x USB Type-A Female
Switches	Reset	1 x Semi-recessed Pushbutton
	Power	1 x Rocker Switch
	Firmware Upgrade	1 x Switch
	LCD Adjust	4 x Pushbutton
	LCD On/Off	1 x LED Pushbutton (Orange)
	Port Selection	2 x Pushbutton
	Station Selection	2 x Pushbutton

Function		CL5716I	
LEDs	Online	16 (Orange)	
	10/100 Mbps	1 (Orange/Green)	
	Port ID	2 x 7-segment LED Display (Yellow)	
	Station ID	2 x 7-segment LED Display (Yellow)	
	Power	1 (Dark Green)	
	Lock	Num	1 (Green)
		Caps	1 (Green)
Scroll		1 (Green)	
Emulation	Keyboard / Mouse	PS/2, USB	
Video	Local	1280 x 1024 @ 75 Hz; DDC2B	
	Remote	1920 x 1200 @ 60 Hz	
Scan Interval (OSD Select)		1–255 sec.	
I/P Rating		100–240 VAC, 50/60 Hz, 1 A	
Power Consumption		17": 120V, 17W / 230V, 18W 19": 120V, 26W / 230V, 26.8W	
Environment	Operating Temp.	0–50° C	
	Storage Temp.	-20–60° C	
	Humidity	0–80% RH, Noncondensing	
Physical Properties	Housing	Metal + Plastic	
	Weight	17": 13.61 kg 19": 13.67 kg	
	Dimensions (L x W x H)	17": 48.00 x 64.27 x 4.40 cm 19": 48.00 x 68.92 x 4.40 cm	

Connection Tables

The following tables indicate the relationship between the number of units and the number of computers that they control on a daisy chained installation.

CL5708I to Compatible 8-Port Switches

No.	Computers	No.	Computers
1	1–8	9	65–72
2	9–16	10	73–80
3	17–24	11	81–88
4	25–32	12	89–96
5	33–40	13	97–104
6	41–48	14	105–112
7	49–56	15	113–120
8	57–64	16	121–128

CL5708I to Compatible 16-Port Switches

No.	Computers	No.	Computers
1	1–8	9	121–136
2	9–24	10	137–152
3	25–40	11	152–168
4	41–56	12	169–184
5	57–72	13	185–200
6	73–88	14	201–216
7	89–104	15	217–232
8	105–120	16	233–248

CL5716I to Compatible 8-Port Switches

No.	Computers	No.	Computers
1	1–16	9	73–80
2	17–24	10	81–88
3	25–32	11	89–96
4	33–40	12	97–104
5	41–48	13	105–112
6	49–56	14	113–120
7	57–64	15	121–128
8	65–72	16	129–136

CL5716I to Compatible 16-Port Switches

No.	Computers	No.	Computers
1	1–16	9	129–144
2	17–32	10	145–160
3	33–48	11	161–176
4	49–64	12	177–192
5	65–80	13	193–208
6	81–96	14	209–224
7	97–112	15	225–240
8	113–128	16	241–256

Supported KVM Switches

The table below lists KVM switches that are compatible with the CL5708I / CL5716I and the type of expansion that they use. (KVM switches listed below are sold separately. Contact your dealer for details.)

Expansion Type	Brand	Model	Name
Daisy Chain	ATEN	ACS1208A	8 Port PS/2 KVM Switch
		ACS1216A	16 Port PS/2 KVM Switch
		CS1708A	8 Port USB / PS/2 KVM Switch
		CS1716A	16 Port USB / PS/2 KVM Switch

Please keep in mind the following limitations when installing more than one KVM switch:

- ◆ The maximum distance between the CL5708I / CL5716I and the last switch in the daisy chain cannot exceed 100 meters, regardless of the number of switches in the daisy chain.
- ◆ The maximum distance between any two KVM switches in the daisy chain cannot exceed 15 meters.

Troubleshooting

General Operation

Problem	Resolution
I am confused about which equipment the terms <i>Local</i> and <i>Remote</i> refer to.	See <i>Terminology</i> , page ix for details.
Erratic Operation	<p>The KVM over IP switch needs to be started before any cascaded switches.</p> <ol style="list-style-type: none"> 1. Make sure to power it on before powering on the switch. 2. If the cascaded switch was started before the KVM over IP switch, reset or restart the cascaded switch. <p>Press and release the <i>Reset</i> switch (see <i>reset button</i>, page 10).</p>
I have been given an account but I am unable to log in.	<ol style="list-style-type: none"> 1. Make sure that you have correctly specified your Username and Password. 2. Make sure that the administrator has given you the necessary permission to access the switch. 3. Ask your administrator to see if the switch is under CC management. If it is, he will have to resolve the situation either by disabling CC management on the switch (see page 143), or by deselecting it on the CC server (see the CC User Manual for details).
I can't access the switch, even though I have specified the IP address and port number correctly.	If the switch is behind a router, the router's <i>Port Forwarding</i> (also referred to as <i>Virtual Server</i>) feature must be configured. See <i>Port Forwarding</i> , page 229, for details.
When logging in from a browser, the following message appears: <i>404 Object Not Found</i> .	If a login string has been set, make sure to include the forward slash and correct login string when you specify the KVM over IP switch's IP address. (See <i>Login String</i> , page 151.)
Sudden loss of network connection.	Close your connection to the KVM over IP switch. Wait approximately 30 seconds, and log in again.
No remote server video display on the client computer.	Set the remote server resolution to 1280 x 1024 or less.
No remote server video display on the client computer, but mouse movements appear on the local console and mouse clicks have no effect	Press and release the left Alt key, then press and release the right Alt key.

Problem	Resolution
<p>The display on the client computer is distorted and performing an Autosync doesn't resolve the problem.</p>	<p>Switch ports to a port with a different resolution, then switch back.</p> <p>If the above didn't resolve the problem, change the resolution and refresh rate for the system running on the port. Afterward, you can either run at the new resolution, or switch back to the original resolution.</p>
<p>The Lock Key LEDs on the Control Panel don't accurately reflect the actual locked status of my keyboard input.</p>	<p>When you first connect, the LED display may not accurately reflect the LEDs on your keyboard. To resolve the problem, click the LEDs on the Control Panel until they match your keyboard. Afterward, when you change them from the keyboard they will change on the Control Panel.</p>
<p>When I log in, the browser generates a <i>CA Root certificate is not trusted</i>, or a <i>Certificate Error</i> response.</p>	<p>The certificate's name is not found on Microsoft's list of Trusted Authorities. The certificate can be trusted. See <i>Trusted Certificates</i>, page 233, for details.</p>
<p>In multiuser operation I had exclusive (or occupy) rights on the port I was viewing. After I recalled the Port Access page and then came back to the port I was occupying, it had been taken over by another user. Why did this happen?</p>	<p>If you try to return to the port by selecting again in the tree, the switch acts as if you are accessing the port for the first time. If another user was waiting on the port, he takes precedence and gets the port. The correct way to return to the port is to click the <i>Close</i> icon at the top right of the Port Access page.</p>
<p>My ATEN over IP unit is not listed in the Device List of IP Installer.</p>	<ul style="list-style-type: none"> ◆ Make sure the Broadcast function is enabled from your switch or router in order for the auto-discover to work properly. ◆ Make sure to turn off your firewall and/or antivirus software temporarily in order for the auto-discover to work properly. ◆ Make sure the ATEN over IP unit and the PC are under the same network segment.

Mouse Problems

Problem	Resolution
Mouse and/or Keyboard not responding.	Unplug the cable(s) from the console port(s), then plug it/ them back in.
Mouse movement extremely slow	There is too much data being transferred for your connection to keep up with. Lower the video quality (see <i>Video Settings</i> , page 85) so that less video data is transmitted.
There are two mouse pointers after the remote server is accessed.	You can select another pointer type. See <i>Mouse Pointer Type</i> , page 96 for details.
When the mouse pointer is in Single Pointer mode, I can't access the Control Panel.	Recall the Control Panel and immediately change the pointer to Dual mode.
Why is there a Dual Pointer mode?	When you are not in Mouse DynaSync Mode, you need the two pointers so that you know the remote server pointer is actually at the location you think it is at. Otherwise, you might perform a mouse operation and because of net lag the remote server pointer may not be at the location that your client computer pointer is at.
Mouse pointer confusion	If you find the display of two mouse pointers (local and remote) to be confusing or annoying, you can use the <i>Toggle Mouse Display</i> function to shrink the non-functioning pointer. See <i>Toggle Mouse Display</i> , page 80, and <i>Mouse Pointer Type</i> , page 96.
When I log in with my Windows system, the local and remote mouse pointers do not sync.	<ol style="list-style-type: none"> <li data-bbox="437 885 966 1013">1. Check the status of the <i>Mouse Sync Mode</i> setting (see <i>Mouse DynaSync Mode</i>, page 97). If it is set to <i>Automatic</i>, change the setting to <i>Manual</i> and refer to the information for <i>Manual Mouse Synchronization</i>, page 98. <li data-bbox="437 1026 966 1098">2. If you are in Manual mode, use the <i>AutoSync</i> feature (see <i>Video Settings</i>, page 85), to sync the local and remote monitors. <li data-bbox="437 1110 966 1182">3. If that doesn't resolve the problem, use the <i>Adjust Mouse</i> feature (see <i>Adjust Mouse</i>, page 80) to bring the pointers back in step. <li data-bbox="437 1195 966 1278">4. If the above fails to resolve the problem, refer to <i>Additional Mouse Synchronization Procedures</i>, page 230, for further steps to take.
When I log in with my Mac system, the local and remote mouse pointers do not sync.	There are two automatic Mouse DynaSync settings: the default, and Mac2. If mouse synchronization is not satisfactory with the default, try the Mac 2 setting. See the Note on page 98 for details.

Problem	Resolution
When I log in with my Sun system, the local and remote mouse pointers do not sync	Automatic Mouse DynaSync sync only supports USB mice on Windows and Mac (G4 or higher) systems. You must sync the pointers manually. See <i>Mouse DynaSync Mode</i> , page 97, and <i>Manual Mouse Synchronization</i> , page 98, for further details. After doing the above, refer to <i>Sun / Linux</i> , page 231, under <i>Additional Mouse Synchronization Procedures</i> , page 230 for further steps to take.
When I log in with my Linux system, the local and remote mouse pointers do not sync.	Automatic Mouse DynaSync sync only supports USB mice on Windows and Mac (G4 or higher) systems. You must sync the pointers manually. See <i>Mouse DynaSync Mode</i> , page 97, and <i>Manual Mouse Synchronization</i> , page 98, for further details. After doing the above, refer to <i>Sun / Linux</i> , page 231, (under <i>Additional Mouse Synchronization Procedures</i> , page 230), for further steps to take.

Web Browser

Problem	Resolution
After upgrading the firmware, after logging in with my web browser, the switch appears to still be using the old firmware version.	The switch is using the new firmware version but the browser is displaying a page that is stored in its cache. Simply log out and clear your browser's cache. ♦ IE: Tools → Internet Options → Temporary Internet Files → Delete Files ♦ Firefox: Tools → Clear Private Data
Firefox only opens the Java Client Viewer. It doesn't open the WinClient ActiveX Viewer.	The WinClient ActiveX Viewer requires ActiveX. Since Firefox doesn't support ActiveX only the Java Client Viewer is available.

The WinClient ActiveX Viewer and the WinClient AP

Problem	Resolution
My CL57081 / CL57161 units don't show up in the <i>Server List</i> window when I start the WinClient AP program.	Only units whose Access Port settings for <i>Program</i> (see page 139) match the number specified for <i>Port</i> in the Server area of this dialog box appear in the Server List window. Make sure that your entry for Port matches the entry you have specified for Program on the Device Management <i>Network</i> page.
The WinClient ActiveX Viewer and the WinClient AP won't connect to the KVM over IP switch.	DirectX 8.0 or higher must be installed on your client computer.
After upgrading the firmware, the WinClient ActiveX Viewer or WinClient AP do not run.	<p>The old version of your .ocx file was not deleted. You must delete the old file. There are two methods to delete the file.</p> <ol style="list-style-type: none"> 1. For the ActiveX Viewer: Open IE → Tools → Manage Add-ons. Delete or disable all occurrences of WinClient. 2. For the WinClient AP: Open Explorer and search for WinClient.ocx. Delete all occurrences.
Part of the remote window is off my monitor.	<ol style="list-style-type: none"> 1. Perform an Auto Sync (see <i>WinClient Control Panel Functions</i>, page 76 for details). 2. If <i>Keep Screen Size</i> is not enabled (see <i>Screen Options</i>, page 100), use the <i>AutoSync</i> feature (see <i>Video Settings</i>, page 85), to sync the local and remote monitors. 3. If <i>Keep Screen Size</i> is enabled, you can scroll to the areas that are off screen.
The remote screen is rotated 90 degrees.	Enable <i>Keep Screen Size</i> (see <i>Control Panel Configuration</i> , page 99).
I cannot run <i>Net Meeting</i> when the WinClient is running.	Enable <i>Keep Screen Size</i> (see <i>Control Panel Configuration</i> , page 99).
After logging in I can't open the WinClient ActiveX viewer.	<ol style="list-style-type: none"> 1. You don't have the authority to install the <i>WinClient Control</i> add-on on your client computer. Have the person with administrator privileges on your client computer run the program the first time to get it installed. It will open for you after that. 2. Under Vista, you must also add the switch's URL address to the list of trusted sites: Tools → Internet Options → Security → Trusted Sites → Sites.

The Java Applet and Java Client AP

Problem	Resolution
I can't connect to the KVM over IP switch.	<ol style="list-style-type: none"> 1. The latest Java version must be installed on your client computer. 2. Check if you need to specify the Program port along with the IP address. See <i>Java Client AP Login</i>, page 65 for details 3. Close Java reopen it, and try again.
I have installed the latest Java JRE, but I am having performance and stability problems.	There may be issues with the latest version because it is so new. Try using a Java version that is one or two versions earlier than the latest one.
After upgrading the firmware, after logging in with the Java Client Viewer or the Java Client AP, the switch appears to still be using the old firmware version.	<p>Log out. Delete your Java temporary internet files as follows:</p> <ol style="list-style-type: none"> 1. Open Control Panel → Java. 2. In the <i>Temporary Internet Files</i> section, click Settings. 3. In the <i>Disk Space</i> section, click Delete Files. 4. In the dialog box that comes up, click OK.
The national language characters that I input do not appear.	<p>Change the keyboard language of your client computer to English-UK.</p> <p>Use the KVM over IP switch's <i>On-Screen Keyboard</i> and set the on-screen keyboard to the same language that the other system is using. (See <i>The On-Screen Keyboard</i>, page 94.)</p>
Java performance deteriorates.	Exit the program and start again.
Pressing the Windows Menu key has no effect.	Java doesn't support the Windows Menu key.

Sun Systems

Problem	Resolution
Video display problems with HDB15 interface systems (e.g. Sun Blade 1000 servers).*	<p>The display resolution should be set to 1024 x 768 @ 60Hz:</p> <p>Under Text Mode:</p> <p>Go to OK mode and issue the following commands:</p> <pre>setenv output-device screen:r1024x768x60 reset-all</pre> <p>Under XWindow:</p> <ol style="list-style-type: none"> 1. Open a console and issue the following command: <pre>m64config -res 1024x768x60</pre> 2. Log out 3. Log in
Video display problems with 13W3 interface systems (e.g. Sun Ultra servers).*	<p>The display resolution should be set to 1024 x 768 @ 60Hz:</p> <p>Under Text Mode:</p> <p>Go to OK mode and issue the following commands:</p> <pre>setenv output-device screen:r1024x768x60 reset-all</pre> <p>Under XWindow:</p> <ol style="list-style-type: none"> 1. Open a console and issue the following command: <pre>fbconfig -res 1024x768x60</pre> 2. Log out 3. Log in

* These solutions work for most common Sun VGA cards. If using them fails to resolve the problem, consult the Sun VGA card's manual.

Mac Systems

Problem	Resolution
When I log in to the KVM over IP switch with my Safari browser, it hangs when I use the Snapshot feature.	<p>Force close Safari, then reopen it. Don't use the Snapshot feature in the future.</p> <p>To use the Snapshot feature with Safari, upgrade to Mac OS 10.4.11 and Safari 3.0.4.</p>

The Log Server

Problem	Resolution
The Log Server program does not run.	<p>The Log Server requires the Microsoft Jet OLEDB 4.0 driver in order to access the database.</p> <p>This driver is automatically installed with Windows ME, 2000 and XP.</p> <p>For Windows 98 or NT, you will have to go to the Microsoft download site: http://www.microsoft.com and do a search for <i>MDAC</i> to retrieve the driver file:</p> <p style="padding-left: 40px;">MDAC 2.7 RTM Refresh (2.70.9001.0)</p> <p>Since this driver is used in Windows Office Suite, an alternate method of obtaining it is to install Windows Office Suite. Once the driver file or Suite has been installed, the Log Server will run.</p>

Panel Array Mode

Problem	Resolution
Low resolution video – the screens don't display clearly.	This sometimes occurs due to the screens being scaled to fit in the panels. Decrease the number of panels that are displayed.
When multiple remote users are logged in, some of them only receive a partial image.	The first user to invoke Panel Array Mode should set it to display at least four panels.

Q1: When I open a viewer, the web page does not display or work correctly, and I receive an error message that is similar one of the following:

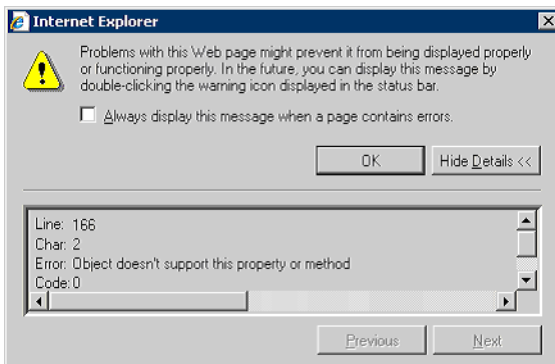

1. Reset the Internet Explorer security settings to enable Active Scripting, ActiveX controls, and Java applets

By default, Internet Explorer 6 and some versions of Internet Explorer 5.x use the High security level for the Restricted sites zone and Microsoft Windows Server 2003 uses the High security level for both the Restricted sites zone and the Internet zone. To enable Active Scripting, ActiveX controls, and Java applets, follow these steps:

- a) Start Internet Explorer.
 - b) On the Tools menu, click Internet Options.
 - c) In the Internet Options dialog box, click Security.
 - d) Click Default Level.
 - e) Click OK.
2. Verify that Active Scripting, ActiveX, and Java are not blocked
If some client computers work but others do not, verify that Internet Explorer or another program on your client computer such as an anti-virus program or a firewall are not configured to block scripts, ActiveX controls, or Java applets.
 3. Verify that your anti-virus program is not set to scan the Temporary Internet Files or Downloaded Program Files folders

4. Delete all the temporary Internet-related files

To remove all the temporary Internet related files from your client computer, follow these steps:

- a) Start Internet Explorer.
- b) On the Tools menu, click **Internet Options**.
- c) Click the *General* tab.
- d) Under Temporary Internet files, click **Settings**.
- e) Click **Delete Files**.
- f) Click **OK**.
- g) Click **Delete Cookies**.
- h) Click **OK**.
- i) Under History, click **Clear History**, and then click **Yes**.
- j) Click **OK**.

5. Make sure that you have the latest version of Microsoft DirectX installed

For information about how to install the latest version of Microsoft DirectX, visit the following Microsoft Web site:

<http://www.microsoft.com/windows/directx/default.aspx?url=/windows/directx/downloads/default.htm>

6. Make sure that you have the latest version of the Java JRE installed.

For information about how to install the latest version of the JRE visit the Java Web site: www.java.com.

IP Address Determination

If you are an administrator logging in for the first time, you need to access the KVM over IP switch in order to give it an IP address that users can connect to. There are three methods to choose from. In each case, your client computer must be on the same network segment as the KVM over IP switch. After you have connected and logged in you can give the KVM over IP switch its fixed network address. (See *Network*, page 139.)

IP Installer

For client computers running Windows, an IP address can be assigned with the *IP Installer* utility. The utility can be obtained from the *Download* area of our website. Look under *Driver/SW*, and the model of your switch. After downloading the utility to your client computer, do the following:

1. Unzip the contents of *IPInstaller.zip* to a directory on your hard drive.
2. Go to the directory that you unzipped the IPInstaller program to and run *IPInstaller.exe*. A dialog box similar to the one below appears:

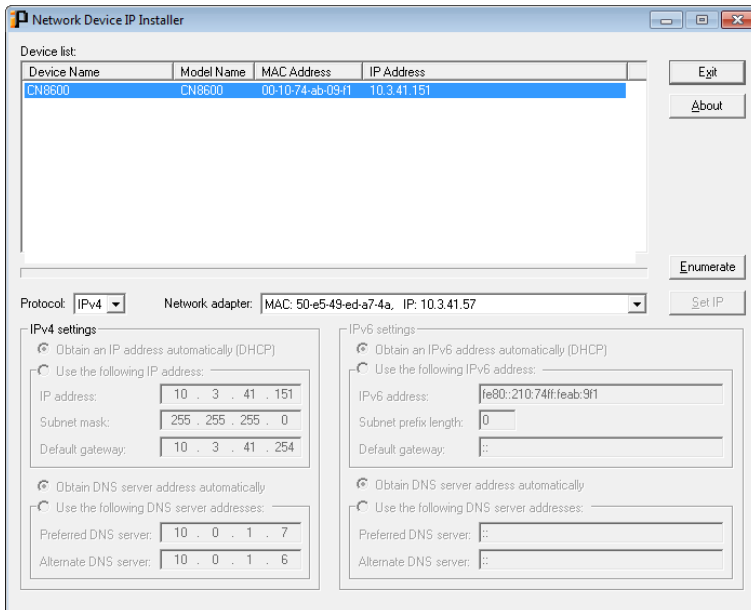

3. Select the KVM over IP switch in the *Device List*.

Note: 1. If the list is empty, or your device doesn't appear, click **Enumerate** to refresh the Device List.

2. If there is more than one device in the list, use the MAC address to pick the one you want. The KVM over IP switch's MAC address is located on its bottom panel.
-

4. Use the drop-down menu to select the **Protocol** (IPv4 or IPv6) and then configure the IP settings below.
5. Select either *Obtain an IP address automatically (DHCP)*, or *Use the following IP address*. If you chose the latter, fill the IP Address, Subnet Mask, and Default Gateway fields with the information appropriate to your network.
6. Select either *Obtain DNS server address automatically*, or *Use the following DNS server addresses*. If you chose the latter, fill the Preferred DNS Server and Alternate DNS server with the IP addresses appropriate to your network.
7. Click **Set IP**.
8. After the IP address shows up in the Device List, click **Exit**. See *IP Installer*, page 140 for more information.

Browser

1. Set your client computer's IP address to 192.168.0.XXX
Where XXX represents any number or numbers except 60. (192.168.0.60 is the default address of the KVM over IP switch.)
2. Specify the switch's default IP address (192.168.0.60) in your browser, and you will be able to connect.
3. Assign a fixed IP address for the KVM over IP switch that is suitable for the network segment that it resides on.
4. After you log out, reset your client computer's IP address to its original value.

IPv6

At present, the KVM over IP switch supports three IPv6 address protocols: *Link Local IPv6 Address*, *IPv6 Stateless Autoconfiguration*, and *Stateful Autoconfiguration (DHCPv6)*.

Link Local IPv6 Address

At power on, the KVM over IP switch is automatically configured with a Link Local IPv6 Address (for example, fe80::210:74ff:fe61:1ef). To find out what the Link Local IPv6 Address is, log in with the KVM over IP switch's IPv4 address and open the *Device Management* → *Device Information* page. The address is displayed in the *General* list box (see page 138).

Once you have determined what the IPv6 address is, you can use it when logging in from a browser or the Win and Java Client AP programs.

For example:

If you are logging in from a browser, you would key in

```
http://[fe80::2001:74ff:fe6e:59%5]
```

for the URL bar.

If you are logging in with the AP program, you would key:

```
fe80::2001:74ff:fe6e:59%5
```

for the *IP* field of the *Server* panel (see *Windows Client AP Login*, page 61).

-
- Note:**
1. To log in with the Link Local IPv6 Address, the client computer must be on the same local network segment as the KVM over IP switch
 2. The %5 is the %interface used by the client computer. To see your client computer's IPv6 address: from the command line issue the following command: `ipconfig /all`. The % value appears at the end of the IPv6 address.
-

IPv6 Stateless Autoconfiguration

If the KVM over IP switch's network environment contains a device (such as a router) that supports the IPv6 Stateless Autoconfiguration function, the KVM over IP switch can obtain its prefix information from that device in order to generate its IPv6 address. For example, 2001::74ff:fe6e:59.

As above, the address is displayed in the *General* list box of the *Device Management* → *Device Information* page (see page 137).

Once you have determined what the IPv6 address is, you can use it when logging in from a browser or the Win and Java Client AP programs.

For example:

If you are logging in from a browser, you would key in

```
http://[2001::74ff:fe6e:59]
```

for the URL bar.

If you are logging in with the AP program, you would key:

```
2001::74ff:fe6e:59
```

for the *IP* field of the *Server* panel (see *Windows Client AP Login*, page 61).

Port Forwarding

For devices located behind a router, port forwarding allows the router to pass data coming in over a specific port to a specific device. By setting the port forwarding parameters, you tell the router which device to send the data that comes in over a particular port to.

For example, if the KVM over IP switch connected to a particular router has an IP address of 192.168.1.180, you would log into your router's setup program and access the Port Forwarding (sometimes referred to as *Virtual Server*) configuration page. You would then specify 192.168.1.180 for the IP address and the port number you want opened for it (9000 for Internet access, for example).

Since configuration setup can vary somewhat for each brand of router, refer to the router's User Manual for specific information on configuring port forwarding for it.

Additional Mouse Synchronization Procedures

If you use Manual Mouse Synchronization, you should perform the following operations on the servers that connect to the switch.

- Note:** 1. These procedures are to be performed on the servers attached to the switch's ports - not on the client computer you are using to access the KVM over IP switch.
2. In order for the local and remote mice to synchronize, you must use the generic mouse driver supplied with the Windows operating system. If you have a third party driver installed - such as one supplied by the mouse manufacturer - you must remove it.

Windows:

1. Windows 2000:
 - a) Open the Mouse Properties dialog box (Control Panel → Mouse → Mouse Properties)
 - b) Click the *Motion* tab
 - c) Set the mouse speed to the middle position (6 units in from the left)
 - d) Set the mouse acceleration to *None*

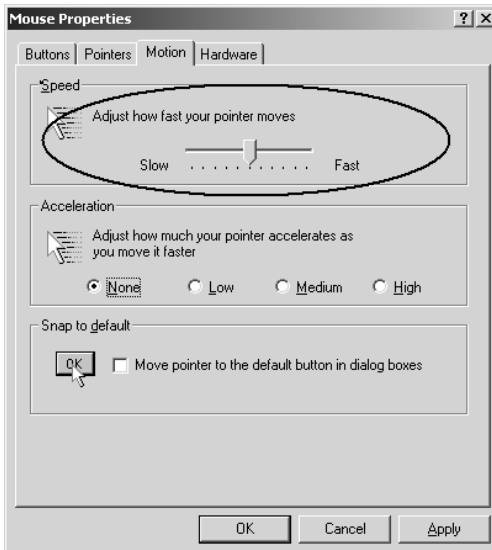

2. Windows XP / Windows Server 2003:
 - a) Open the Mouse Properties dialog box (Control Panel → Mouse)
 - b) Click the *Pointer Options* tab
 - c) Set the mouse speed to the middle position (6 units in from the left)
 - d) Disable *Enhance Pointer Precision*

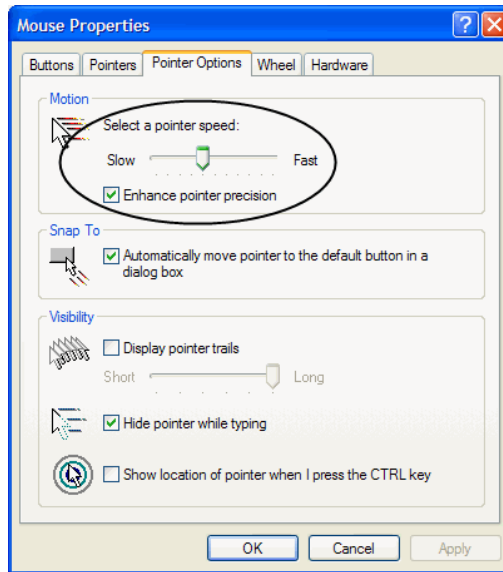

3. Windows ME:
Set the mouse speed to the middle position; disable mouse acceleration (click **Advanced** to get the dialog box for this).
4. Windows NT / Windows 98 / Windows 95:
Set the mouse speed to the slowest position.

Sun / Linux

Open a terminal session and issue the following command:

```
Sun: xset m 1
```

```
Linux: xset m 0
```

```
or
```

```
xset m 1
```

(If one doesn't help, try the other.)

```
Linux using the Redhat AS3.0 mouse mode: xset m 1
```

Additional Video Resolution Procedures

If you are running Windows, and wish to use new refresh rates, do the following:

1. Open Control Panel → Display → Settings → Advanced → Monitor.
2. In the dialog box that comes up, make sure that the *Hide modes that this monitor cannot display* checkbox is unchecked.

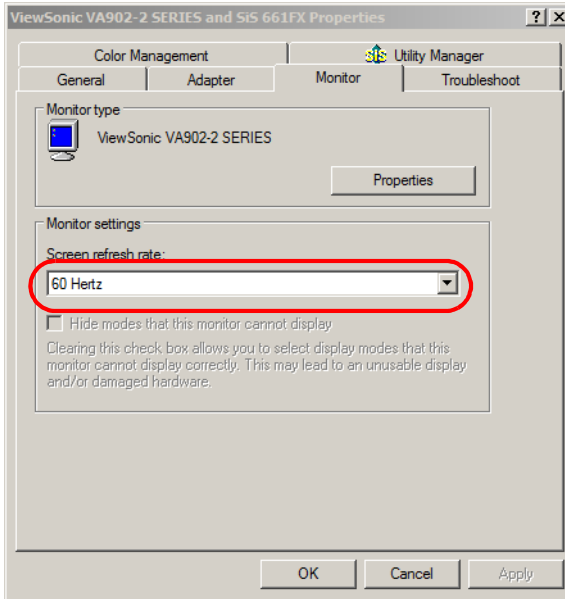

3. Click the arrow at the right of the *Screen refresh rate* listbox, and select the refresh rate you want from the list that appears.

Note: Make sure that your monitor supports the refresh rate you choose – if not, you may seriously damage your monitor.

Trusted Certificates

Overview

When you try to log in to the device from your browser, a Security Alert message appears to inform you that the device's certificate is not trusted, and asks if you want to proceed.



The certificate can be trusted, but the alert is triggered because the certificate's name is not found on Microsoft list of Trusted Authorities. You have two options: 1) you can ignore the warning and click **Yes** to go on; or 2) you can install the certificate and have it be recognized as trusted.

- ◆ If you are working on a client computer at another location, accept the certificate for just this session by clicking **Yes**.
- ◆ If you are working at your own client computer, install the certificate on your client computer (see below for details). After the certificate is installed, it will be recognized as trusted.

Installing the Certificate

To install the certificate, do the following:

1. In the *Security Alert* dialog box, click **View Certificate**. The *Certificate Information* dialog box appears:



Note: There is a red and white X logo over the certificate to indicate that it is not trusted.

2. Click **Install Certificate**.
3. Follow the Installation Wizard to complete the installation. Unless you have a specific reason to choose otherwise, accept the default options.
4. When the Wizard presents a caution screen, click **Yes**.

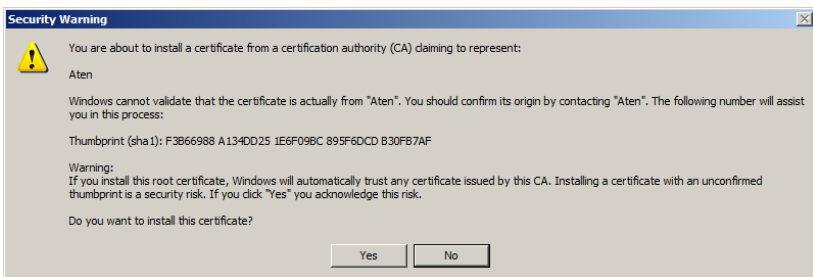

5. Click **Finish** to complete the installation; then click **OK** to close the dialog box.

Certificate Trusted

The certificate is now trusted:

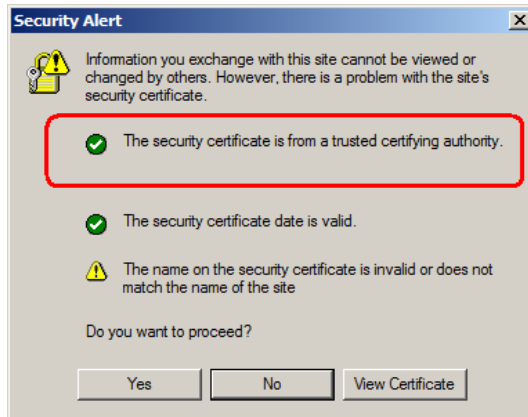

When you click *View Certificate*, you can see that the red and white X logo is no longer present – further indication that the certificate is trusted:

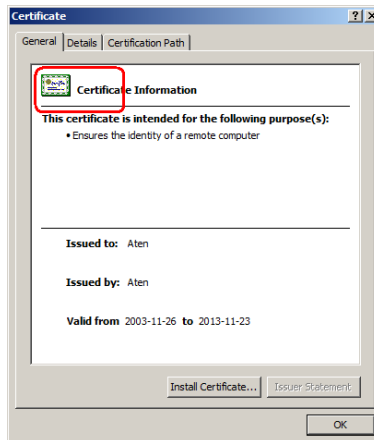

Mismatch Considerations

If the site name or IP address used for generating the certificate no longer matches the current address of the switch a mismatch warning occurs:

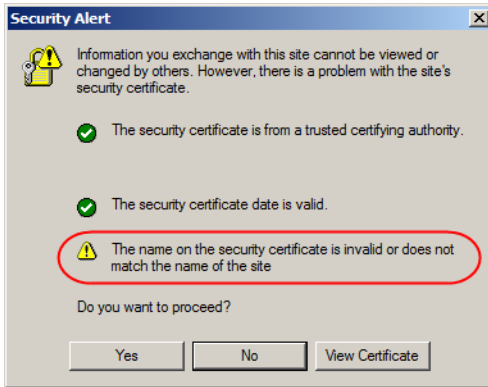

You can click **Yes** to go on, or you can disable mismatch checking.

To disable mismatch checking, do the following:

1. After the page you are logging in to comes up open the browser's Tools menu; Select *Internet Options* → *Advanced*.
2. Scroll to the bottom of the list and uncheck *Warn about trusted certificates*:

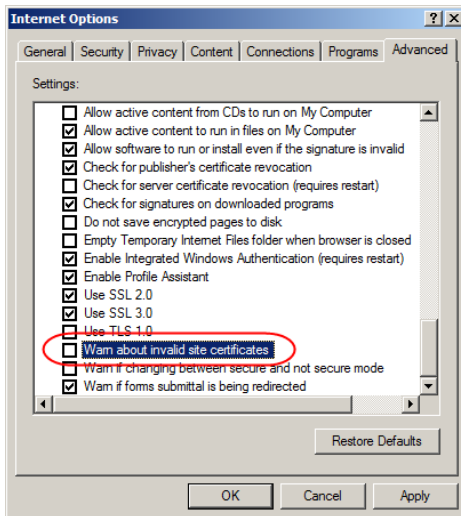

3. Click **OK**. The next time you run the browser the change will be in effect.

Self-Signed Private Certificates

If you wish to create your own self-signed encryption key and certificate, a free utility – `openssl.exe` – is available for download over the web at www.openssl.org. To create your private key and certificate do the following:

1. Go to the directory where you downloaded and extracted `openssl.exe` to.
2. Run `openssl.exe` with the following parameters:

```
openssl req -new -newkey rsa:1024 -days 3653 -nodes -x509
-keyout CA.key -out CA.cer -config openssl.cnf
```

Note: 1. The command should be entered all on one line (i.e., do not press [Enter] until all the parameters have been keyed in).

2. If there are spaces in the input, surround the entry in quotes (e.g., “ATEN International”).
-

To avoid having to input information during key generation the following additional parameters can be used:

```
/C /ST /L /O /OU /CN /emailAddress.
```

Examples

```
openssl req -new -newkey rsa:1024 -days 3653 -nodes -x509
-keyout CA.key -out CA.cer -config openssl.cnf -subj
/C=yourcountry/ST=yourstateorprovince/L=yourlocationor
city/O=yourorganization/OU=yourorganizationalunit/
CN=yourcommonname/emailAddress=name@yourcompany.com
```

```
openssl req -new -newkey rsa:1024 -days 3653 -nodes -x509
-keyout CA.key -out CA.cer -config openssl.cnf -subj
/C=CA/ST=BC/L=Richmond/O="ATEN International"/OU=ATEN
/CN=ATEN/emailAddress=eservice@aten.com.tw
```

Importing the Files

After the `openssl.exe` program completes, two files – `CA.key` (the private key) and `CA.cer` (the self-signed SSL certificate) – are created in the directory that you ran the program from. These are the files that you upload in the *Private Certificate* panel of the Security page (see *Security*, page 147, and *Private Certificate*, page 155).

Clear Login Information

If you are unable to perform an Administrator login (because the Username and Password information has become corrupted, or you have forgotten it), you can clear the login information with the following procedure.

1. Power off the switch and remove the top cover from the unit chassis.
2. Short the jumper labeled *Default Password* on the switch's main board

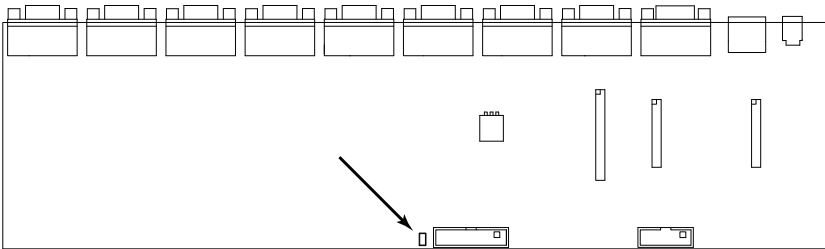

3. Power on the switch.

When you power the switch on, the following message appears on the LCD display:

```
USERNAME AND PASSWORD INFORMATION HAS BEEN CLEARED.  
PLEASE POWER OFF THE SWITCH, REMOVE THE JUMPER, CLOSE  
THE CASE, THEN RESTART.
```

4. After you start back up, the OSD login function acts exactly the way it did the first time the switch was run (see *OSD Overview*, page 33) and you can reset passwords for the Administrators and Users.

OSD Factory Default Settings

The factory default settings are as follows:

Setting	Default
OSD Hotkey	[Num Lock] + [-]
Remote Hotkey	[Scroll Lock] [Scroll Lock]
Port ID Display Position	Upper Left Corner
Port ID Display Duration	3 Seconds
Port ID Display Mode	Port Number plus the Port Name
Scan Duration	5 Seconds
Scan/Skip Mode	All
Screen Blanker	0 (Disabled)
Logout Timeout	0 (Disabled)
Beeper	Y (Activated)
Accessible Ports	F (Full) for all users on all ports

Troubleshooting

Overview

Operation problems can be due to a variety of causes. The first step in solving them is to make sure that all cables are securely attached and seated completely in their sockets.

In addition, updating the product's firmware may solve problems that have been discovered and resolved since the prior version was released. If your product is not running the latest firmware version, we strongly recommend that you upgrade. See *The Firmware Upgrade Utility*, page 195, for upgrade details.

Problem	Solution
There are ghost images on the external monitor.	The distance between the external console and the CL5708I / CL5716I is too great. The maximum VGA cable distance should not exceed 20m and, in some cases, may need to be shorter. Replace the VGA cable with one of an appropriately short length.

Keyboard Invocation Keys

Two dedicated keys are provided on the keyboard module to make it easy to invoke Hotkey mode and the OSD, as shown in the diagram, below



Note: These keys are toggles. Press them once to invoke the feature, press them again to exit.

About SPHD Connectors



This product uses SPHD connectors for its KVM and/or Console ports. We have specifically modified the shape of these connectors so that only KVM cables that we have designed to work with this product can be connected.

Limited Warranty

ATEN warrants its hardware in the country of purchase against flaws in materials and workmanship for a Warranty Period of two [2] years (warranty period may vary in certain regions/countries) commencing on the date of original purchase. This warranty period includes the [LCD panel of ATEN LCD KVM switches](#). Select products are warranted for an additional year (see [A+ Warranty](#) for further details). Cables and accessories are not covered by the Standard Warranty.

What is covered by the Limited Hardware Warranty

ATEN will provide a repair service, without charge, during the Warranty Period. If a product is defective, ATEN will, at its discretion, have the option to (1) repair said product with new or repaired components, or (2) replace the entire product with an identical product or with a similar product which fulfills the same function as the defective product. Replaced products assume the warranty of the original product for the remaining period or a period of 90 days, whichever is longer. When the products or components are replaced, the replacing articles shall become customer property and the replaced articles shall become the property of ATEN.

To learn more about our warranty policies, please visit our website:
<http://www.aten.com/global/en/legal/policies/warranty-policy/>

© Copyright 2021 ATEN® International Co., Ltd.
Released: 2021-05-12

ATEN and the ATEN logo are registered trademarks of ATEN International Co., Ltd. All rights reserved. All other brand names and trademarks are the registered property of their respective owners.