

# CX-20

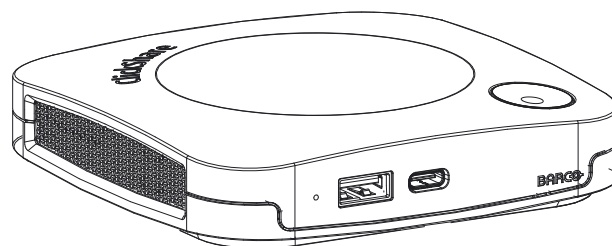

## Installation manual

**Barco NV**

Beneluxpark 21, 8500 Kortrijk, Belgium  
[www.barco.com/en/support](http://www.barco.com/en/support)  
[www.barco.com](http://www.barco.com)

**Registered office: Barco NV**

President Kennedypark 35, 8500 Kortrijk, Belgium  
[www.barco.com/en/support](http://www.barco.com/en/support)  
[www.barco.com](http://www.barco.com)

## Copyright ©

All rights reserved. No part of this document may be copied, reproduced or translated. It shall not otherwise be recorded, transmitted or stored in a retrieval system without the prior written consent of Barco.

## Trademarks

Brand and product names mentioned in this manual may be trademarks, registered trademarks or copyrights of their respective holders. All brand and product names mentioned in this manual serve as comments or examples and are not to be understood as advertising for the products or their manufacturers.

## Trademarks

USB Type-C™ and USB-C™ are trademarks of USB Implementers Forum.

## HDMI Trademark Notice



The terms HDMI, HDMI High Definition Multimedia Interface, and the HDMI Logo are trademarks or registered trademarks of HDMI Licensing Administrator, Inc.

## Product Security Incident Response

As a global technology leader, Barco is committed to deliver secure solutions and services to our customers, while protecting Barco's intellectual property. When product security concerns are received, the product security incident response process will be triggered immediately. To address specific security concerns or to report security issues with Barco products, please inform us via contact details mentioned on <https://www.barco.com/psirt>. To protect our customers, Barco does not publically disclose or confirm security vulnerabilities until Barco has conducted an analysis of the product and issued fixes and/or mitigations.

## Patent protection

Please refer to [www.barco.com/about-barco/legal/patents](http://www.barco.com/about-barco/legal/patents)

## Guarantee and Compensation

Barco provides a guarantee relating to perfect manufacturing as part of the legally stipulated terms of guarantee. On receipt, the purchaser must immediately inspect all delivered goods for damage incurred during transport, as well as for material and manufacturing faults Barco must be informed immediately in writing of any complaints.

The period of guarantee begins on the date of transfer of risks, in the case of special systems and software on the date of commissioning, at latest 30 days after the transfer of risks. In the event of justified notice of complaint, Barco can repair the fault or provide a replacement at its own discretion within an appropriate period. If this measure proves to be impossible or unsuccessful, the purchaser can demand a reduction in the purchase price or cancellation of the contract. All other claims, in particular those relating to compensation for direct or indirect damage, and also damage attributed to the operation of software as well as to other services provided by Barco, being a component of the system or independent service, will be deemed invalid provided the damage is not proven to be attributed to the absence of properties guaranteed in writing or due to the intent or gross negligence or part of Barco.

If the purchaser or a third party carries out modifications or repairs on goods delivered by Barco, or if the goods are handled incorrectly, in particular if the systems are operated incorrectly or if, after the transfer of risks, the goods are subject to influences not agreed upon in the contract, all guarantee claims of the purchaser will be rendered invalid. Not included in the guarantee coverage are system failures which are attributed to programs or special electronic circuitry provided by the purchaser, e.g. interfaces. Normal wear as well as normal maintenance are not subject to the guarantee provided by Barco either.

The environmental conditions as well as the servicing and maintenance regulations specified in this manual must be complied with by the customer.

## Barco ClickShare Product Specific End User License Agreement<sup>1</sup>

THIS PRODUCT SPECIFIC USER LICENSE AGREEMENT (EULA) TOGETHER WITH THE BARCO GENERAL EULA ATTACHED HERETO SET OUT THE TERMS OF USE OF THE SOFTWARE.

---

<sup>1</sup>: In the event of any differences or inconsistencies between translations of the EULA and the English text of the EULA, the English text will prevail.

PLEASE READ THIS DOCUMENT CAREFULLY BEFORE OPENING OR DOWNLOADING AND USING THE SOFTWARE.

DO NOT ACCEPT THE LICENSE, AND DO NOT INSTALL, DOWNLOAD, ACCESS, OR OTHERWISE COPY OR USE ALL OR ANY PORTION OF THE SOFTWARE UNLESS YOU CAN AGREE WITH ITS TERMS AS SET OUT IN THIS LICENSE AGREEMENT.

## 1. Entitlement

Barco ClickShare (the "Software") offered as a wireless presentation solution that includes the respective software components as further detailed in the applicable Documentation.

The Software can be used upon purchase from, and subject to payment of the relating purchase price to, a Barco authorized distributor or reseller of the ClickShare base unit and button or download of the authorized ClickShare applications (each a "Barco ClickShare Product").

- **Term**

The Software can be used under the terms of this EULA from the date of first use of the Barco ClickShare Product, for as long as you operate such Barco ClickShare Product.

- **Deployment and Use**

The Software shall be used solely in association with a Barco ClickShare Product in accordance with the Documentation issued by Barco for such Product.

## 2. Support

The Software is subject to the warranty conditions outlined in the Barco warranty rider. Maintenance, including the provision of upgrades and updates to the Software, and helpdesk support are available at your option on the terms of Barco's then current warranty rider.

Higher maintenance and support levels can be obtained at the moment of product sale or during the Barco ClickShare Product and/or Software warranty term.

Higher maintenance and support levels may be included in the initial transaction if ordered and paid for additionally. It is strongly suggested to maintain the maintenance and support agreement without interruption. Barco reserves the right not to restart maintenance following an interruption by the customer.

## 3. Terms of Use

The Software can be used as set out in the Barco EULA attached hereto.

The provisions of this Product Specific EULA override the Barco generic EULA in case of conflicts or inconsistencies.

In case of (inadvertent or other) non-compliance (e.g. where the actual use overshoots the use authorized hereunder), Barco shall have the option to suspend access to the Software until the non-compliance is remedied, failing of which Barco may terminate the License Agreement as set out herein.

## 4. Privacy

You are controller for personal data which are being processed via the Software. Therefore, you remain solely responsible for complying with all applicable data protection laws and for implementing and maintaining privacy protection and security measures (especially for components that you provide or control). Barco disclaims any liability in this regard.

Barco created a specific privacy policy for the ClickShare software application for mobile devices, which describes the processing of personal data via this application (<http://www.barco.com/en/about-barco/legal/privacy-policy/clickshare-app>).

## 5. Other Terms

- **Open Source components**

The Software contains software components released under an Open Source license.

A list of the third party components used is available in the Software's README files, through the "My Barco" section of the Barco website or through other (online) means. The applicable license terms, copyright notices and, as relevant, source code access conditions apply as set out in the Barco EULA attached hereto.

- **Retention of data**

Barco right to use and retain Functional Information (section 10.2 of the EULA) shall survive the term of this EULA.

## Barco ClickShare Product Specific Privacy policy

You are controller for personal data which are being processed via the Software. Therefore, you remain solely responsible for complying with all applicable data protection laws and for implementing and maintaining privacy protection and security measures (especially for components that you provide or control). Barco disclaims any liability in this regard. Barco created a specific privacy policy for the ClickShare software application for mobile devices, which describes the processing of personal data via this application (<http://www.barco.com/en/about-barco/legal/privacy-policy/clickshare-app>).

Via the Software, Barco may gather technical information about (i) the functioning and the functionality of the products which are connected through the Software, and/or (ii) as provided by you or generated by your use of the Software ("Functional Information"). Barco may make use of such Functional Information for purposes of analytics, for developing and improving products and services, offering products and services to your organization and/or allowing third parties to access such Functional Information; based on the legitimate interest of Barco of evaluating the market, assessing and improving its products and conducting research and development. All knowhow, inventions and works derived by Barco from the Functional Information will be exclusively owned by Barco.

## Open Source Software provisions

This product contains software components released under an Open Source license. A copy of the source code is available on request by contacting your Barco customer support representative.

EACH SEPARATE OPEN SOURCE SOFTWARE COMPONENT AND ANY RELATED DOCUMENTATION ARE PROVIDED "AS IS" WITHOUT EXPRESS OR IMPLIED WARRANTY INCLUDING, BUT NOT LIMITED TO, THE IMPLIED WARRANTIES OF MERCHANTABILITY AND FITNESS FOR A PARTICULAR PURPOSE. IN NO EVENT SHALL THE COPYRIGHTHOLDER OR ANY OTHER CONTRIBUTOR BE LIABLE FOR DIRECT, INCIDENTAL, SPECIAL, EXEMPLARY OR CONSEQUENTIAL DAMAGES, EVEN IF ADVISED OF THE POSSIBILITY OF SUCH DAMAGES, HOWEVER CAUSED AND ON ANY THEORY OF LIABILITY, WHETHER IN CONTRACT, STRICT LIABILITY, OR TORT (INCLUDING NEGLIGENCE OR OTHERWISE) ARISING IN ANY WAY OUT OF THE USE OF THIS OPEN SOURCE SOFTWARE. MORE INFORMATION/ DETAILS IS TO BE FOUND IN EACH SPECIFIC OPEN SOURCE LICENSE.

Copyright on each Open Source Software component belongs to the respective initial copyright holder, each additional contributor and/or their respective assignee (s), as may be identified in the respective documentation, source code, README file, or otherwise. You shall not remove or obscure or otherwise alter the respective copyrights.

You acknowledge living up to the conditions of each separate Open Source Software license.

In the development of the Software, the following Open Source Software components have been used:

<b>PACKAGE</b>	<b>VERSION</b>	<b>SOURCE</b>
alsa-lib	1.1.7	<a href="ftp://ftp.alsa-project.org/pub/lib">ftp://ftp.alsa-project.org/pub/lib</a>
alsa-utils	1.1.7	<a href="ftp://ftp.alsa-project.org/pub/utils">ftp://ftp.alsa-project.org/pub/utils</a>
libsamplerate	0.1.9	<a href="http://www.mega-nerd.com/SRC">http://www.mega-nerd.com/SRC</a>
libsndfile	1.0.28	<a href="http://www.mega-nerd.com/libsndfile/files">http://www.mega-nerd.com/libsndfile/files</a>
ncurses	6,1	<a href="http://ftpmirror.gnu.org/ncurses">http://ftpmirror.gnu.org/ncurses</a>
avahi	0,7	<a href="https://github.com/lathiat/avahi/releases/download/v0.7">https://github.com/lathiat/avahi/releases/download/v0.7</a>
dbus	1.12.16	<a href="https://dbus.freedesktop.org/releases/dbus">https://dbus.freedesktop.org/releases/dbus</a>
expat	2.2.7	<a href="http://downloads.sourceforge.net/project/expat/expat/2.2.7">http://downloads.sourceforge.net/project/expat/expat/2.2.7</a>
libselenium	2,8	<a href="https://raw.githubusercontent.com/wiki/SELinuxProject/selinux/files/releases/20180524">https://raw.githubusercontent.com/wiki/SELinuxProject/selinux/files/releases/20180524</a>
libsepol	2,8	<a href="https://raw.githubusercontent.com/wiki/SELinuxProject/selinux/files/releases/20180524">https://raw.githubusercontent.com/wiki/SELinuxProject/selinux/files/releases/20180524</a>
pcre	8,42	<a href="https://ftp.pcre.org/pub/pcre">https://ftp.pcre.org/pub/pcre</a>
python3	3.7.4	<a href="https://python.org/ftp/python/3.7.4">https://python.org/ftp/python/3.7.4</a>

<b>PACKAGE</b>	<b>VERSION</b>	<b>SOURCE</b>
libffi	v3.3-rc0	<a href="https://github.com/libffi/libffi/archive/v3.3-rc0">https://github.com/libffi/libffi/archive/v3.3-rc0</a>
libzlib	1.2.11	<a href="http://www.zlib.net">http://www.zlib.net</a>
libdaemon	0,14	<a href="http://0pointer.de/lennart/projects/libdaemon">http://0pointer.de/lennart/projects/libdaemon</a>
libglib2	2.56.4	<a href="http://ftp.gnome.org/pub/gnome/sources/glib/2.56">http://ftp.gnome.org/pub/gnome/sources/glib/2.56</a>
elfutils(tool)	0,176	<a href="https://sourceware.org/elfutils/ftp/0.176">https://sourceware.org/elfutils/ftp/0.176</a>
elfutils(library)	0,176	<a href="https://sourceware.org/elfutils/ftp/0.176">https://sourceware.org/elfutils/ftp/0.176</a>
bzip2	1.0.8	<a href="http://www.bzip.org/1.0.8">http://www.bzip.org/1.0.8</a>
util-linux	2,33	<a href="https://cdn.kernel.org/pub/linux/utils/util-linux/v2.33">https://cdn.kernel.org/pub/linux/utils/util-linux/v2.33</a>
linux-pam	1.3.1	<a href="https://github.com/linux-pam/linux-pam/releases/download/v1.3.1">https://github.com/linux-pam/linux-pam/releases/download/v1.3.1</a>
flex	2.6.4	<a href="https://github.com/westes/flex/files/981163">https://github.com/westes/flex/files/981163</a>
readline	8	<a href="http://ftpmirror.gnu.org/readline">http://ftpmirror.gnu.org/readline</a>
bc	1.06.95	<a href="http://alpha.gnu.org/gnu/bc">http://alpha.gnu.org/gnu/bc</a>
bellagio	0.9.3	<a href="http://downloads.sourceforge.net/project/omxil/omxil/Bellagio%200.9.3">http://downloads.sourceforge.net/project/omxil/omxil/Bellagio%200.9.3</a>
bitstream	1,4	<a href="https://get.videolan.org/bitstream/1.4">https://get.videolan.org/bitstream/1.4</a>
bluez5_utils	5,5	<a href="https://cdn.kernel.org/pub/linux/bluetooth">https://cdn.kernel.org/pub/linux/bluetooth</a>
libical	1.0.1	<a href="https://github.com/libical/libical/releases/download/v1.0.1">https://github.com/libical/libical/releases/download/v1.0.1</a>
eudev	3.2.7	<a href="http://dev.gentoo.org/~blueness/eudev">http://dev.gentoo.org/~blueness/eudev</a>
kmod	25	<a href="https://cdn.kernel.org/pub/linux/utils/kernel/kmod">https://cdn.kernel.org/pub/linux/utils/kernel/kmod</a>
bridge-utils	1,6	<a href="https://cdn.kernel.org/pub/linux/utils/net/bridge-utils">https://cdn.kernel.org/pub/linux/utils/net/bridge-utils</a>
busybox	1.29.3	<a href="http://www.busybox.net/downloads">http://www.busybox.net/downloads</a>
dosfstools	4,1	<a href="https://github.com/dosfstools/dosfstools/releases/download/v4.1">https://github.com/dosfstools/dosfstools/releases/download/v4.1</a>
e2fsprogs (libss and libet)	1.44.5	<a href="https://cdn.kernel.org/pub/linux/kernel/people/tytso/e2fsprogs/v1.44.5">https://cdn.kernel.org/pub/linux/kernel/people/tytso/e2fsprogs/v1.44.5</a>
iproute2	4.19.0	<a href="https://cdn.kernel.org/pub/linux/utils/net/iproute2">https://cdn.kernel.org/pub/linux/utils/net/iproute2</a>
iptables	1.8.2	<a href="http://ftp.netfilter.org/pub/iptables">http://ftp.netfilter.org/pub/iptables</a>
netcat	0.7.1	<a href="http://downloads.sourceforge.net/project/netcat/netcat/0.7.1">http://downloads.sourceforge.net/project/netcat/netcat/0.7.1</a>
ntp	4.2.8p13	<a href="https://www.eecis.udel.edu/~ntp/ntp_spool/ntp4/ntp-4.2">https://www.eecis.udel.edu/~ntp/ntp_spool/ntp4/ntp-4.2</a>
libedit	20180525-3.1	<a href="http://www.thrysoee.dk/editline">http://www.thrysoee.dk/editline</a>
libbsd	0.10.0	<a href="https://archive.hadrons.org/software/libbsd">https://archive.hadrons.org/software/libbsd</a>
libevent	2.1.8-stable	<a href="https://github.com/libevent/libevent/releases/download/release-2.1.8-stable">https://github.com/libevent/libevent/releases/download/release-2.1.8-stable</a>
libopenssl	1.1.1c	<a href="http://www.openssl.org/source">http://www.openssl.org/source</a>
pciutils	3.5.5	<a href="https://cdn.kernel.org/pub/software/utils/pciutils">https://cdn.kernel.org/pub/software/utils/pciutils</a>
unzip	60	<a href="ftp://ftp.info-zip.org/pub/infozip/src">ftp://ftp.info-zip.org/pub/infozip/src</a>

<b>PACKAGE</b>	<b>VERSION</b>	<b>SOURCE</b>
usbutils	10	<a href="https://cdn.kernel.org/pub/linux/utils/usb/usbutils">https://cdn.kernel.org/pub/linux/utils/usb/usbutils</a>
libusb	1.0.22	<a href="https://github.com/libusb/libusb/releases/download/v1.0.22">https://github.com/libusb/libusb/releases/download/v1.0.22</a>
c-ares	1.15.0	<a href="http://c-ares.haxx.se/download">http://c-ares.haxx.se/download</a>
ca-certificates	20190110	<a href="http://snapshot.debian.org/archive/debian/20190513T145054Z/pool/main/c/ca-certificates">http://snapshot.debian.org/archive/debian/20190513T145054Z/pool/main/c/ca-certificates</a>
collectd	5.7.2	<a href="http://collectd.org/files">http://collectd.org/files</a>
libgcrypt	1.8.4	<a href="https://gnupg.org/ftp/gcrypt/libgcrypt">https://gnupg.org/ftp/gcrypt/libgcrypt</a>
libpgp-error	1,33	<a href="ftp://ftp.gnupg.org/gcrypt/libpgp-error">ftp://ftp.gnupg.org/gcrypt/libpgp-error</a>
lm-sensors (libsensors)	3.5.0	<a href="https://github.com/lm-sensors/lm-sensors/archive/V3-5-0">https://github.com/lm-sensors/lm-sensors/archive/V3-5-0</a>
lm-sensors (programs)	3.5.0	<a href="https://github.com/lm-sensors/lm-sensors/archive/V3-5-0">https://github.com/lm-sensors/lm-sensors/archive/V3-5-0</a>
crda	4,14	<a href="https://git.kernel.org/pub/scm/linux/kernel/git/mcgrof/crda.git/snapshot">https://git.kernel.org/pub/scm/linux/kernel/git/mcgrof/crda.git/snapshot</a>
libnl	3.4.0	<a href="https://github.com/thom311/libnl/releases/download/libnl3_4_0">https://github.com/thom311/libnl/releases/download/libnl3_4_0</a>
cryptsetup	2.0.6	<a href="https://cdn.kernel.org/pub/linux/utils/cryptsetup/v2.0">https://cdn.kernel.org/pub/linux/utils/cryptsetup/v2.0</a>
json-c	0.13.1	<a href="https://s3.amazonaws.com/json-c_releases/releases">https://s3.amazonaws.com/json-c_releases/releases</a>
lvml2	2.02.183	<a href="ftp://sources.redhat.com/pub/lvml2/releases">ftp://sources.redhat.com/pub/lvml2/releases</a>
libaio	0.3.111	<a href="https://releases.pagure.org/libaio">https://releases.pagure.org/libaio</a>
popt	1,16	<a href="http://rpm5.org/files/popt">http://rpm5.org/files/popt</a>
dhcp	4.3.6	<a href="http://ftp.isc.org/isc/dhcp/4.3.6">http://ftp.isc.org/isc/dhcp/4.3.6</a>
dnsmasq	2,79	<a href="http://thekelleys.org.uk/dnsmasq">http://thekelleys.org.uk/dnsmasq</a>
dropbear	2018,76	<a href="https://matt.ucc.asn.au/dropbear/releases">https://matt.ucc.asn.au/dropbear/releases</a>
dvblast	3,4	<a href="https://get.videolan.org/dvblast/3.4">https://get.videolan.org/dvblast/3.4</a>
libev	4,24	<a href="http://dist.schmorp.de/libev/Attic">http://dist.schmorp.de/libev/Attic</a>
faad2	2.8.8	<a href="http://downloads.sourceforge.net/project/faac/faad2-src/faad2-2.8.0">http://downloads.sourceforge.net/project/faac/faad2-src/faad2-2.8.0</a>
fbv	1.0b	<a href="http://s-tech.elsat.net.pl/fbv">http://s-tech.elsat.net.pl/fbv</a>
giflib	5.1.4	<a href="http://downloads.sourceforge.net/project/giflib">http://downloads.sourceforge.net/project/giflib</a>
jpeg-turbo	2.0.1	<a href="https://downloads.sourceforge.net/project/libjpeg-turbo/2.0.1">https://downloads.sourceforge.net/project/libjpeg-turbo/2.0.1</a>
libpng	1.6.37	<a href="http://downloads.sourceforge.net/project/libpng/libpng16/1.6.37">http://downloads.sourceforge.net/project/libpng/libpng16/1.6.37</a>
ffmpeg	4.1.3	<a href="http://ffmpeg.org/releases">http://ffmpeg.org/releases</a>
fontconfig	2.13.1	<a href="http://fontconfig.org/release">http://fontconfig.org/release</a>
freetype	2.9.1	<a href="http://download.savannah.gnu.org/releases/freetype">http://download.savannah.gnu.org/releases/freetype</a>
libva	2.4.0	<a href="https://github.com/01org/libva/releases/download/2.4.0">https://github.com/01org/libva/releases/download/2.4.0</a>
libdrm	2.4.97	<a href="https://dri.freedesktop.org/libdrm">https://dri.freedesktop.org/libdrm</a>
libpthread- stubs	0,4	<a href="http://xcb.freedesktop.org/dist">http://xcb.freedesktop.org/dist</a>

<b>PACKAGE</b>	<b>VERSION</b>	<b>SOURCE</b>
libvorbis	1.3.6	<a href="http://downloads.xiph.org/releases/vorbis">http://downloads.xiph.org/releases/vorbis</a>
libogg	1.3.3	<a href="http://downloads.xiph.org/releases/ogg">http://downloads.xiph.org/releases/ogg</a>
libvpx	1.7.0	<a href="http://storage.googleapis.com/downloads.webmproject.org/releases/webm">http://storage.googleapis.com/downloads.webmproject.org/releases/webm</a>
opus	1.3.1	<a href="https://downloads.xiph.org/releases/opus">https://downloads.xiph.org/releases/opus</a>
speex	1.2.0	<a href="http://downloads.us.xiph.org/releases/speex">http://downloads.us.xiph.org/releases/speex</a>
speexdsp	20e-d3452074664a-d07e380-e51321b148a-cebdf20	<a href="https://git.xiph.org/speexdsp.git">https://git.xiph.org/speexdsp.git</a>
file	5,36	<a href="ftp://ftp.astron.com/pub/file">ftp://ftp.astron.com/pub/file</a>
gdb	8.1.1	<a href="http://ftpmirror.gnu.org/gdb">http://ftpmirror.gnu.org/gdb</a>
gnupg2	2.2.17	<a href="https://gnupg.org/ftp/gcrypt/gnupg">https://gnupg.org/ftp/gcrypt/gnupg</a>
libassuan	2.5.2	<a href="ftp://ftp.gnupg.org/gcrypt/libassuan">ftp://ftp.gnupg.org/gcrypt/libassuan</a>
libksba	1.3.5	<a href="ftp://ftp.gnupg.org/gcrypt/libksba">ftp://ftp.gnupg.org/gcrypt/libksba</a>
libnpth	1,6	<a href="https://www.gnupg.org/ftp/gcrypt/npth">https://www.gnupg.org/ftp/gcrypt/npth</a>
sqlite	3280000	<a href="https://www.sqlite.org/2019">https://www.sqlite.org/2019</a>
gssdp	1.0.2	<a href="http://ftp.gnome.org/pub/gnome/sources/gssdp/1.0">http://ftp.gnome.org/pub/gnome/sources/gssdp/1.0</a>
libsoup	2.62.3	<a href="http://ftp.gnome.org/pub/gnome/sources/libsoup/2.62">http://ftp.gnome.org/pub/gnome/sources/libsoup/2.62</a>
gst1-libav	1.14.4	<a href="https://gstreamer.freedesktop.org/src/gst-libav">https://gstreamer.freedesktop.org/src/gst-libav</a>
gst1-plugins-base	1.14.4	<a href="https://gstreamer.freedesktop.org/src/gst-plugins-base">https://gstreamer.freedesktop.org/src/gst-plugins-base</a>
gstreamer1	1.14.4	<a href="https://gstreamer.freedesktop.org/src/gstreamer">https://gstreamer.freedesktop.org/src/gstreamer</a>
gst1-plugins-bad	1.14.4	<a href="https://gstreamer.freedesktop.org/src/gst-plugins-bad">https://gstreamer.freedesktop.org/src/gst-plugins-bad</a>
gst1-plugins-good	1.14.4	<a href="https://gstreamer.freedesktop.org/src/gst-plugins-good">https://gstreamer.freedesktop.org/src/gst-plugins-good</a>
libv4l	1.16.3	<a href="https://linuxtv.org/downloads/v4l-utils">https://linuxtv.org/downloads/v4l-utils</a>
icu	60,2	<a href="http://download.icu-project.org/files/icu4c/60.2">http://download.icu-project.org/files/icu4c/60.2</a>
pcre2	10,32	<a href="https://ftp.pcre.org/pub/pcre">https://ftp.pcre.org/pub/pcre</a>
gst1-vaapi	1.14.4	<a href="https://gstreamer.freedesktop.org/src/gstreamer-vaapi">https://gstreamer.freedesktop.org/src/gstreamer-vaapi</a>
htop	2.2.0	<a href="http://hisham.hm/htop/releases/2.2.0">http://hisham.hm/htop/releases/2.2.0</a>
input-event-daemon	v0.1.3	<a href="https://github.com/gandro/input-event-daemon/archive/v0.1.3">https://github.com/gandro/input-event-daemon/archive/v0.1.3</a>
iperf3	3,6	<a href="https://downloads.es.net/pub/iperf">https://downloads.es.net/pub/iperf</a>
iw	4,14	<a href="https://cdn.kernel.org/pub/software/network/iw">https://cdn.kernel.org/pub/software/network/iw</a>
jansson	2,12	<a href="http://www.digip.org/jansson/releases">http://www.digip.org/jansson/releases</a>
jose	10	<a href="https://github.com/latchset/jose/releases/download/v10">https://github.com/latchset/jose/releases/download/v10</a>



<b>PACKAGE</b>	<b>VERSION</b>	<b>SOURCE</b>
jsoncpp	1.8.4	<a href="https://github.com/open-source-parsers/jsoncpp/archive/1.8.4">https://github.com/open-source-parsers/jsoncpp/archive/1.8.4</a>
libarchive	3.3.3	<a href="http://www.libarchive.org/downloads">http://www.libarchive.org/downloads</a>
libxml2	2.9.9	<a href="ftp://xmlsoft.org/libxml2">ftp://xmlsoft.org/libxml2</a>
libconfig	1.7.2	<a href="http://www.hyperrealm.com/libconfig">http://www.hyperrealm.com/libconfig</a>
libcurl	7.65.3	<a href="https://curl.haxx.se/download">https://curl.haxx.se/download</a>
libestr	0.1.10	<a href="http://libestr.adiscon.com/files/download">http://libestr.adiscon.com/files/download</a>
libfastjson	v0.99.8	<a href="https://github.com/rsyslog/libfastjson/archive/v0.99.8">https://github.com/rsyslog/libfastjson/archive/v0.99.8</a>
libhttpparser	v2.9.0	<a href="https://github.com/nodejs/http-parser/archive/v2.9.0">https://github.com/nodejs/http-parser/archive/v2.9.0</a>
liblogging	1.0.6	<a href="http://download.rsyslog.com/liblogging">http://download.rsyslog.com/liblogging</a>
libnspr	4,2	<a href="https://ftp.mozilla.org/pub/mozilla.org/nspr/releases/v4.20/src">https://ftp.mozilla.org/pub/mozilla.org/nspr/releases/v4.20/src</a>
libnss	3.42.1	<a href="https://ftp.mozilla.org/pub/mozilla.org/security/nss/releases/NSS_3_42_1_RTM/src">https://ftp.mozilla.org/pub/mozilla.org/security/nss/releases/NSS_3_42_1_RTM/src</a>
libopusenc	0.2.1	<a href="https://downloads.xiph.org/releases/opus">https://downloads.xiph.org/releases/opus</a>
libpcap	1.9.0	<a href="http://www.tcpdump.org/release">http://www.tcpdump.org/release</a>
libqrencode	4.0.0	<a href="http://fukuchi.org/works/qrencode">http://fukuchi.org/works/qrencode</a>
libsha1	0,3	<a href="https://github.com/dottedmag/libsha1/archive/0.3">https://github.com/dottedmag/libsha1/archive/0.3</a>
libtool	2.4.6	<a href="http://ftpmirror.gnu.org/libtool">http://ftpmirror.gnu.org/libtool</a>
libuv	v1.25.0	<a href="https://github.com/libuv/libuv/archive/v1.25.0">https://github.com/libuv/libuv/archive/v1.25.0</a>
libyaml	0.2.1	<a href="http://pyyaml.org/download/libyaml">http://pyyaml.org/download/libyaml</a>
libzip	1.5.1	<a href="http://www.nih.at/libzip">http://www.nih.at/libzip</a>
lighttpd	1.4.53	<a href="http://download.lighttpd.net/lighttpd/releases-1.4.x">http://download.lighttpd.net/lighttpd/releases-1.4.x</a>
logrotate	3.13.0	<a href="https://github.com/logrotate/logrotate/archive/3.13.0">https://github.com/logrotate/logrotate/archive/3.13.0</a>
memtester	4.3.0	<a href="http://pyropus.ca/software/memtester/old-versions">http://pyropus.ca/software/memtester/old-versions</a>
monit	5.25.3	<a href="http://mmonit.com/monit/dist">http://mmonit.com/monit/dist</a>
net-snmp	5,8	<a href="https://downloads.sourceforge.net/project/net-snmp/net-snmp/5.8">https://downloads.sourceforge.net/project/net-snmp/net-snmp/5.8</a>
nodejs	8.15.1	<a href="http://nodejs.org/dist/v8.15.1">http://nodejs.org/dist/v8.15.1</a>
opkg	0.3.6	<a href="http://git.yoctoproject.org/git/opkg">http://git.yoctoproject.org/git/opkg</a>
opus-tools	0,2	<a href="https://downloads.xiph.org/releases/opus">https://downloads.xiph.org/releases/opus</a>
opusfile	0,11	<a href="https://downloads.xiph.org/releases/opus">https://downloads.xiph.org/releases/opus</a>
php	7.3.9	<a href="https://ftp.pcre.org/pub/pcre">https://ftp.pcre.org/pub/pcre</a>
portaudio	v190600_20161030	<a href="http://www.portaudio.com/archives">http://www.portaudio.com/archives</a>
powertop	2,9	<a href="https://01.org/sites/default/files/downloads/powertop">https://01.org/sites/default/files/downloads/powertop</a>
protobuf	2.6.1	<a href="https://github.com/google/protobuf/archive/v2.6.1">https://github.com/google/protobuf/archive/v2.6.1</a>

<b>PACKAGE</b>	<b>VERSION</b>	<b>SOURCE</b>
python-pyyaml	4.2b4	<a href="https://files.pythonhosted.org/packages/a8/c6/a8d1555e795dbd0375c3c93b576ca13bbf139db51ea604a-fa19a2c35fc03">https://files.pythonhosted.org/packages/a8/c6/a8d1555e795dbd0375c3c93b576ca13bbf139db51ea604a-fa19a2c35fc03</a>
python-serial	3,4	<a href="https://files.pythonhosted.org/packages/cc/74/11b04703ec416717b247d789103277269d567db575d2fd88f25d9767f-e3d">https://files.pythonhosted.org/packages/cc/74/11b04703ec416717b247d789103277269d567db575d2fd88f25d9767f-e3d</a>
qt5base	5.12.4	<a href="https://download.qt.io/archive/qt/5.12/5.12.4/submodules">https://download.qt.io/archive/qt/5.12/5.12.4/submodules</a>
qt5declarative	5.12.4	<a href="https://download.qt.io/archive/qt/5.12/5.12.4/submodules">https://download.qt.io/archive/qt/5.12/5.12.4/submodules</a>
qt5xmlpatterns	5.12.4	<a href="https://download.qt.io/archive/qt/5.12/5.12.4/submodules">https://download.qt.io/archive/qt/5.12/5.12.4/submodules</a>
qt5imageformats	5.12.4	<a href="https://download.qt.io/archive/qt/5.12/5.12.4/submodules">https://download.qt.io/archive/qt/5.12/5.12.4/submodules</a>
qt5multimedia	5.12.4	<a href="https://download.qt.io/archive/qt/5.12/5.12.4/submodules">https://download.qt.io/archive/qt/5.12/5.12.4/submodules</a>
qt5quickcontrols	5.12.4	<a href="https://download.qt.io/archive/qt/5.12/5.12.4/submodules">https://download.qt.io/archive/qt/5.12/5.12.4/submodules</a>
qt5quickcontrols2	5.12.4	<a href="https://download.qt.io/archive/qt/5.12/5.12.4/submodules">https://download.qt.io/archive/qt/5.12/5.12.4/submodules</a>
qt5serialport	5.12.4	<a href="https://download.qt.io/archive/qt/5.12/5.12.4/submodules">https://download.qt.io/archive/qt/5.12/5.12.4/submodules</a>
qt5svg	5.12.4	<a href="https://download.qt.io/archive/qt/5.12/5.12.4/submodules">https://download.qt.io/archive/qt/5.12/5.12.4/submodules</a>
qt5webchannel	5.12.4	<a href="https://download.qt.io/archive/qt/5.12/5.12.4/submodules">https://download.qt.io/archive/qt/5.12/5.12.4/submodules</a>
qt5websockets	5.12.4	<a href="https://download.qt.io/archive/qt/5.12/5.12.4/submodules">https://download.qt.io/archive/qt/5.12/5.12.4/submodules</a>
qt5webengine	5.12.4	<a href="https://download.qt.io/archive/qt/5.12/5.12.4/submodules">https://download.qt.io/archive/qt/5.12/5.12.4/submodules</a>
webp	1.0.1	<a href="http://downloads.webmproject.org/releases/webp">http://downloads.webmproject.org/releases/webp</a>
ramspeed	2.6.0	<a href="http://www.alasir.com/software/ramspeed">http://www.alasir.com/software/ramspeed</a>
rsync	3.1.3	<a href="http://rsync.samba.org/ftp/rsync/src">http://rsync.samba.org/ftp/rsync/src</a>
rsyslog	8.22.0	<a href="http://rsyslog.com/files/download/rsyslog">http://rsyslog.com/files/download/rsyslog</a>
strace	4,26	<a href="http://downloads.sourceforge.net/project/strace/strace/4.20">http://downloads.sourceforge.net/project/strace/strace/4.20</a>
tcpdump	4.9.2	<a href="http://www.tcpdump.org/release">http://www.tcpdump.org/release</a>
trousers	0.3.14	<a href="http://downloads.sourceforge.net/project/trousers/trousers/0.3.14">http://downloads.sourceforge.net/project/trousers/trousers/0.3.14</a>
tpm-tools	1.3.9.1	<a href="http://downloads.sourceforge.net/project/trousers/tpm-tools/1.3.9.1">http://downloads.sourceforge.net/project/trousers/tpm-tools/1.3.9.1</a>
tzdata	2018e	<a href="http://www.iana.org/time-zones/repository/releases">http://www.iana.org/time-zones/repository/releases</a>
wireless-regdb	2019.06.03	<a href="https://cdn.kernel.org/pub/software/network/wireless-regdb">https://cdn.kernel.org/pub/software/network/wireless-regdb</a>
wireless_tools	30.pre9	<a href="https://hewlettpackard.github.io/wireless-tools">https://hewlettpackard.github.io/wireless-tools</a>
zip	30	<a href="ftp://ftp.info-zip.org/pub/infozip/src">ftp://ftp.info-zip.org/pub/infozip/src</a>
splashutils	1.5.4.4	<a href="http://dev.gentoo.org/~spock/projects/gensplash/archive">http://dev.gentoo.org/~spock/projects/gensplash/archive</a>
json	1.8.4-cs2	<a href="http://json.org/">http://json.org/</a>
libresample	0.1.3	<a href="ftp://ftp.ubuntu.com/ubuntu/pool/universe/libr/libresample">ftp://ftp.ubuntu.com/ubuntu/pool/universe/libr/libresample</a>

<b>PACKAGE</b>	<b>VERSION</b>	<b>SOURCE</b>
alsa-plugins	1.1.1	<a href="ftp://ftp.alsa-project.org/pub/plugins">ftp://ftp.alsa-project.org/pub/plugins</a>
arphic-uming-fonts	20080216	<a href="http://archive.ubuntu.com/ubuntu/pool/main/t/ttf-arphic-uming">http://archive.ubuntu.com/ubuntu/pool/main/t/ttf-arphic-uming</a>
dejavu-fonts	2,34	<a href="http://downloads.sourceforge.net/project/dejavu/dejavu/2.34">http://downloads.sourceforge.net/project/dejavu/dejavu/2.34</a>
flexnet	1.0.5	<a href="https://www.flexerasoftware.com/monetize/products/flexnet-licensing.html">https://www.flexerasoftware.com/monetize/products/flexnet-licensing.html</a>
sazanami-fonts	20040629	<a href="http://sourceforge.jp/projects/efont/downloads/10087">http://sourceforge.jp/projects/efont/downloads/10087</a>
unfonts	1	<a href="http://kldp.net/frs/download.php/1425">http://kldp.net/frs/download.php/1425</a>
linux-firmware	65b1c68c63-f974d72610d-b38dfa-e49861117cae2	<a href="http://git.kernel.org/pub/scm/linux/kernel/git/firmware/linux-firmware.git">http://git.kernel.org/pub/scm/linux/kernel/git/firmware/linux-firmware.git</a>
libsrp	2.1.2	<a href="https://github.com/secure-remote-password/stanford-srp/tree/master/libsrp">https://github.com/secure-remote-password/stanford-srp/tree/master/libsrp</a>
libfdk-aac	0.1.4	<a href="https://github.com/mstorsjo/fdk-aac">https://github.com/mstorsjo/fdk-aac</a>
libalac	4	<a href="https://github.com/macOSforge/alac">https://github.com/macOSforge/alac</a>
mDNSResponder	878.30.4	<a href="https://opensource.apple.com/source/mDNSResponder/">https://opensource.apple.com/source/mDNSResponder/</a>
AOP Alliance Class library	1	<a href="https://sourceforge.net/projects/aopalliance/files/aopalliance/1.0/">https://sourceforge.net/projects/aopalliance/files/aopalliance/1.0/</a>
Apache Log4j	1.2.17	<a href="https://archive.apache.org/dist/logging/log4j/1.2.17/">https://archive.apache.org/dist/logging/log4j/1.2.17/</a>
ASM Bytecode Manipulation	5.0.1	<a href="https://gitlab.ow2.org/asm/asm/tags/ASM_5_0_1">https://gitlab.ow2.org/asm/asm/tags/ASM_5_0_1</a>
AspectJ Runtime	1.8.10	<a href="http://www.eclipse.org/downloads/download.php?file=/tools/aspectj/aspectj-1.8.10-src.jar">http://www.eclipse.org/downloads/download.php?file=/tools/aspectj/aspectj-1.8.10-src.jar</a>
Boost	1,59	<a href="http://sourceforge.net/projects/boost/files/boost/1.59.0/boost_1_59_0.tar.bz2">http://sourceforge.net/projects/boost/files/boost/1.59.0/boost_1_59_0.tar.bz2</a>
Commons beanutils	1.8.0	<a href="https://archive.apache.org/dist/commons/beanutils/source/commons-beanutils-1.8.0-src.tar.gz">https://archive.apache.org/dist/commons/beanutils/source/commons-beanutils-1.8.0-src.tar.gz</a>
Commons beanutils	1.9.3	<a href="https://archive.apache.org/dist/commons/beanutils/source/commons-beanutils-1.9.3-src.tar.gz">https://archive.apache.org/dist/commons/beanutils/source/commons-beanutils-1.9.3-src.tar.gz</a>
Commons codec	1.9.0	<a href="https://archive.apache.org/dist/commons/codec/source/commons-codec-1.9-src.tar.gz">https://archive.apache.org/dist/commons/codec/source/commons-codec-1.9-src.tar.gz</a>
Commons codec	1,1	<a href="https://archive.apache.org/dist/commons/codec/source/commons-codec-1.10-src.tar.gz">https://archive.apache.org/dist/commons/codec/source/commons-codec-1.10-src.tar.gz</a>
Commons collections	3,1	<a href="https://archive.apache.org/dist/commons/collections/source/commons-collections-3.1-src.tar.gz">https://archive.apache.org/dist/commons/collections/source/commons-collections-3.1-src.tar.gz</a>
Commons collections	3.2.2	<a href="https://archive.apache.org/dist/commons/collections/source/commons-collections-3.2.2-src.tar.gz">https://archive.apache.org/dist/commons/collections/source/commons-collections-3.2.2-src.tar.gz</a>
Commons digester	2,1	<a href="https://archive.apache.org/dist/commons/digester/source/commons-digester-2.1-src.tar.gz">https://archive.apache.org/dist/commons/digester/source/commons-digester-2.1-src.tar.gz</a>

<b>PACKAGE</b>	<b>VERSION</b>	<b>SOURCE</b>
Commons fileupload	1.3.2	<a href="https://archive.apache.org/dist/commons/fileupload/source/commons-fileupload-1.3.2-src.tar.gz">https://archive.apache.org/dist/commons/fileupload/source/commons-fileupload-1.3.2-src.tar.gz</a>
Commons httpclient	3,1	<a href="https://www.apache.org/dist/httpcomponents/commons-httpclient/source/commons-httpclient-3.1-src.tar.gz">https://www.apache.org/dist/httpcomponents/commons-httpclient/source/commons-httpclient-3.1-src.tar.gz</a>
Commons httpclient	4.5.3	<a href="http://apache.belnet.be/httpcomponents/httpclient/source/httpcomponents-client-4.5.3-src.tar.gz">http://apache.belnet.be/httpcomponents/httpclient/source/httpcomponents-client-4.5.3-src.tar.gz</a>
Commons IO	2,2	<a href="https://archive.apache.org/dist/commons/io/source/commons-io-2.2-src.tar.gz">https://archive.apache.org/dist/commons/io/source/commons-io-2.2-src.tar.gz</a>
Commons IO	2,5	<a href="https://archive.apache.org/dist/commons/io/source/commons-io-2.5-src.tar.gz">https://archive.apache.org/dist/commons/io/source/commons-io-2.5-src.tar.gz</a>
Commons lang	3,1	<a href="https://archive.apache.org/dist/commons/lang/source/commons-lang3-3.1-src.tar.gz">https://archive.apache.org/dist/commons/lang/source/commons-lang3-3.1-src.tar.gz</a>
Commons lang	3,6	<a href="https://archive.apache.org/dist/commons/lang/source/commons-lang3-3.6-src.tar.gz">https://archive.apache.org/dist/commons/lang/source/commons-lang3-3.6-src.tar.gz</a>
Commons logging	1,2	<a href="https://archive.apache.org/dist/commons/logging/source/commons-logging-1.2-src.tar.gz">https://archive.apache.org/dist/commons/logging/source/commons-logging-1.2-src.tar.gz</a>
Commons schema	1.4.5	<a href="https://github.com/apache/webservices-commons-xmlschema/archive/XmlSchema-1.4.5.tar.gz">https://github.com/apache/webservices-commons-xmlschema/archive/XmlSchema-1.4.5.tar.gz</a>
Commons text	1,1	<a href="https://archive.apache.org/dist/commons/text/source/commons-text-1.1-src.tar.gz">https://archive.apache.org/dist/commons/text/source/commons-text-1.1-src.tar.gz</a>
Commons Validator	1,6	<a href="https://archive.apache.org/dist/commons/validator/source/commons-validator-1.6-src.tar.gz">https://archive.apache.org/dist/commons/validator/source/commons-validator-1.6-src.tar.gz</a>
Eclipselink	2.6.4	<a href="http://mirror.switch.ch/eclipse/rt/eclipselink/releases/2.6.4/eclipselink-src-2.6.4.v20160829-44060b6.zip">http://mirror.switch.ch/eclipse/rt/eclipselink/releases/2.6.4/eclipselink-src-2.6.4.v20160829-44060b6.zip</a>
Freemarker	2.3.22	<a href="https://sourceforge.net/projects/freemarker/files/freemarker/2.3.22/">https://sourceforge.net/projects/freemarker/files/freemarker/2.3.22/</a>
Glassfish Components	2.2.4	<a href="https://mvnrepository.com/artifact/org.glassfish.web/javax.el/2.2.4">https://mvnrepository.com/artifact/org.glassfish.web/javax.el/2.2.4</a>
Google Guava Library	23	<a href="https://github.com/google/guava/releases/tag/v23.0">https://github.com/google/guava/releases/tag/v23.0</a>
Graylog Extended Log Format for Java	1.1.15	<a href="https://github.com/t0xa/gelfj/archive/v1.1.15.tar.gz">https://github.com/t0xa/gelfj/archive/v1.1.15.tar.gz</a>
H2 embedded database	1.4.196	<a href="http://repo2.maven.org/maven2/com/h2database/h2/1.4.196/h2-1.4.196-sources.jar">http://repo2.maven.org/maven2/com/h2database/h2/1.4.196/h2-1.4.196-sources.jar</a>
Hibernate Bean Validator	5.3.5.Final	<a href="https://github.com/hibernate/hibernate-validator/releases/tag/5.3.5.Final">https://github.com/hibernate/hibernate-validator/releases/tag/5.3.5.Final</a>
HttpComponents	4.5.3	<a href="https://github.com/apache/httpcomponents-client/archive/4.5.3.tar.gz">https://github.com/apache/httpcomponents-client/archive/4.5.3.tar.gz</a>
Jackson JSON processor	2.2.3	<a href="http://central.maven.org/maven2/com/fasterxml/jackson/core/jackson-core/2.2.3/jackson-core-2.2.3-sources.jar">http://central.maven.org/maven2/com/fasterxml/jackson/core/jackson-core/2.2.3/jackson-core-2.2.3-sources.jar</a>
Jackson JSON Processor	2.8.9	<a href="http://central.maven.org/maven2/com/fasterxml/jackson/core/jackson-core/2.8.9/jackson-core-2.8.9-sources.jar">http://central.maven.org/maven2/com/fasterxml/jackson/core/jackson-core/2.8.9/jackson-core-2.8.9-sources.jar</a>

<b>PACKAGE</b>	<b>VERSION</b>	<b>SOURCE</b>
Jakarta Taglib Standards	1.1.0	<a href="https://archive.apache.org/dist/jakarta/taglibs/standard/source/jakarta-taglibs-standard-1.1.0-src.tar.gz">https://archive.apache.org/dist/jakarta/taglibs/standard/source/jakarta-taglibs-standard-1.1.0-src.tar.gz</a>
JavaBeans Activation Framework	1,1	<a href="https://mvnrepository.com/artifact/javax.activation/activation/1.1">https://mvnrepository.com/artifact/javax.activation/activation/1.1</a>
JAXB XML Processor	0.6.4	<a href="https://mvnrepository.com/artifact/org.jvnet.jaxb2_commons/jaxb2-basics-runtime/0.6.4">https://mvnrepository.com/artifact/org.jvnet.jaxb2_commons/jaxb2-basics-runtime/0.6.4</a>
Jcabi Manifest	1,1	<a href="https://github.com/jcabi/jcabi-manifests/releases/tag/1.1">https://github.com/jcabi/jcabi-manifests/releases/tag/1.1</a>
Jetty embedded server	9.3.14	<a href="https://github.com/eclipse/jetty.project/releases/tag/jetty-9.3.14.v20161028">https://github.com/eclipse/jetty.project/releases/tag/jetty-9.3.14.v20161028</a>
jQuery	1.4.4	<a href="https://github.com/jquery/jquery/releases/tag/1.4.4">https://github.com/jquery/jquery/releases/tag/1.4.4</a>
jQuery-ui	1.8.9	<a href="https://github.com/jquery/jquery-ui/releases/tag/1.8.9">https://github.com/jquery/jquery-ui/releases/tag/1.8.9</a>
JSON in Java (org.json)	20131018	<a href="http://central.maven.org/maven2/org/json/json/20131018/json-20131018-sources.jar">http://central.maven.org/maven2/org/json/json/20131018/json-20131018-sources.jar</a>
JSON processor used by GELFJ	1.1.1	<a href="https://github.com/t0xa/gelfj/archive/v1.1.1.tar.gz">https://github.com/t0xa/gelfj/archive/v1.1.1.tar.gz</a>
JSON Web Token Library	0.7.0	<a href="http://central.maven.org/maven2/io/jsonwebtoken/jjwt/0.7.0/jjwt-0.7.0-sources.jar">http://central.maven.org/maven2/io/jsonwebtoken/jjwt/0.7.0/jjwt-0.7.0-sources.jar</a>
KopiLua Scripting Engine	5.1.5	<a href="https://github.com/NLua/KopiLua">https://github.com/NLua/KopiLua</a>
libCurl	7.48.0	<a href="https://github.com/curl/curl/releases/tag/curl-7_48_0">https://github.com/curl/curl/releases/tag/curl-7_48_0</a>
Liquibase database migration	3.5.3	<a href="https://github.com/liquibase/liquibase/releases/tag/liquibase-parent-3.5.3">https://github.com/liquibase/liquibase/releases/tag/liquibase-parent-3.5.3</a>
Log4j	1.2.16	<a href="https://archive.apache.org/dist/logging/log4j/1.2.16/apache-log4j-1.2.16.tar.gz">https://archive.apache.org/dist/logging/log4j/1.2.16/apache-log4j-1.2.16.tar.gz</a>
Lua Scripting Engine	5.2.2	<a href="https://www.lua.org/ftp/lua-5.2.2.tar.gz">https://www.lua.org/ftp/lua-5.2.2.tar.gz</a>
Luaj	3	<a href="https://sourceforge.net/projects/luaj/files/luaj-3.0/3.0/">https://sourceforge.net/projects/luaj/files/luaj-3.0/3.0/</a>
Mapstruct	1.0.0	<a href="https://github.com/mapstruct/mapstruct/releases/tag/1.0.0.Final">https://github.com/mapstruct/mapstruct/releases/tag/1.0.0.Final</a>
MPI	1.8.6	<a href="https://download.open-mpi.org/release/open-mpi/v1.8/openmpi-1.8.6.tar.bz2">https://download.open-mpi.org/release/open-mpi/v1.8/openmpi-1.8.6.tar.bz2</a>
MVEL	2.2.8.Final	<a href="http://central.maven.org/maven2/org/mvel/mvel/2.2.8.Final/mvel-2.2.8.Final-sources.jar">http://central.maven.org/maven2/org/mvel/mvel/2.2.8.Final/mvel-2.2.8.Final-sources.jar</a>
nanohttpd	?	<a href="https://github.com/NanoHttpd/nanohttpd">https://github.com/NanoHttpd/nanohttpd</a>
Object-Graph Navigation Language (OGNL)	3.0.19	<a href="http://central.maven.org/maven2/ognl/ognl/3.0.19/ognl-3.0.19-sources.jar">http://central.maven.org/maven2/ognl/ognl/3.0.19/ognl-3.0.19-sources.jar</a>
OpenSSL	1.0.2l	<a href="http://www.openssl.org/source/openssl-1.0.2l.tar.gz">http://www.openssl.org/source/openssl-1.0.2l.tar.gz</a>

<b>PACKAGE</b>	<b>VERSION</b>	<b>SOURCE</b>
Passay	1.1.0	<a href="https://github.com/vt-middleware/passay/releases/tag/v1.1.0">https://github.com/vt-middleware/passay/releases/tag/v1.1.0</a>
SHA2 C-library	?	<a href="https://github.com/ouah/sha2">https://github.com/ouah/sha2</a>
Simple Logging Façade for Java	1.7.25	<a href="https://github.com/qos-ch/slf4j/releases/tag/v_1.7.25">https://github.com/qos-ch/slf4j/releases/tag/v_1.7.25</a>
Spring Boot	1.5.6	<a href="https://repo1.maven.org/maven2/org/springframework/boot/spring-boot/1.5.6.RELEASE/spring-boot-1.5.6.RELEASE-sources.jar">https://repo1.maven.org/maven2/org/springframework/boot/spring-boot/1.5.6.RELEASE/spring-boot-1.5.6.RELEASE-sources.jar</a>
Spring framework	4.2.4	<a href="https://github.com/spring-projects/spring-framework/releases/tag/v4.2.4.RELEASE">https://github.com/spring-projects/spring-framework/releases/tag/v4.2.4.RELEASE</a>
Springfox	2.5.0	<a href="https://github.com/springfox/springfox/releases/tag/2.5.0">https://github.com/springfox/springfox/releases/tag/2.5.0</a>
StarkSoft	1.0.130	<a href="https://www.nuget.org/packages/starksoft.aspen/1.0.1">https://www.nuget.org/packages/starksoft.aspen/1.0.1</a>
Struts	2.3.34	<a href="https://archive.apache.org/dist/struts/2.3.34/struts-2.3.34-src.zip">https://archive.apache.org/dist/struts/2.3.34/struts-2.3.34-src.zip</a>
Swagger	1.5.9	<a href="https://github.com/swagger-api/swagger-core/releases/tag/v1.5.9">https://github.com/swagger-api/swagger-core/releases/tag/v1.5.9</a>
Tiles framework	2.0.6	<a href="https://archive.apache.org/dist/tiles/v2.0.6/tiles-2.0.6-src.tar.gz">https://archive.apache.org/dist/tiles/v2.0.6/tiles-2.0.6-src.tar.gz</a>
TinyXML	2.5.3	<a href="https://sourceforge.net/projects/tinyxml/files/tinyxml/2.5.3/">https://sourceforge.net/projects/tinyxml/files/tinyxml/2.5.3/</a>
Tomcat JDBC Connection Pool	8.5.6	<a href="http://central.maven.org/maven2/org/apache/tomcat/tomcat-jdbc/8.5.6/tomcat-jdbc-8.5.6-sources.jar">http://central.maven.org/maven2/org/apache/tomcat/tomcat-jdbc/8.5.6/tomcat-jdbc-8.5.6-sources.jar</a>
T-Rex	1,3	<a href="https://sourceforge.net/projects/tiny-rex/files/t-rex/trex%201.3/">https://sourceforge.net/projects/tiny-rex/files/t-rex/trex%201.3/</a>
YAML	1,17	<a href="https://mvnrepository.com/artifact/org.yaml/snakeyaml/1.17">https://mvnrepository.com/artifact/org.yaml/snakeyaml/1.17</a>
wpa_suppl	a5ffe45908-cae43925bb5c-b13d98251-c802b4717	<a href="http://w1.fi/hostap.git">http://w1.fi/hostap.git</a>
wpa_passphrase	a5ffe45908-cae43925bb5c-b13d98251-c802b4717	<a href="http://w1.fi/hostap.git">http://w1.fi/hostap.git</a>
wpa_cli	a5ffe45908-cae43925bb5c-b13d98251-c802b4717	<a href="http://w1.fi/hostap.git">http://w1.fi/hostap.git</a>
hostapd	a5ffe45908-cae43925bb5c-b13d98251-c802b4717	<a href="http://w1.fi/hostap.git">http://w1.fi/hostap.git</a>
hostapd_cli	a5ffe45908-cae43925bb5c-b13d98251-c802b4717	<a href="http://w1.fi/hostap.git">http://w1.fi/hostap.git</a>
qca6174a-30	4.5.25.38	<a href="https://source.codeaurora.org/external/wlan/qcaclid-2.0/">https://source.codeaurora.org/external/wlan/qcaclid-2.0/</a>
gsl	master	<a href="https://github.com/microsoft/GSL">https://github.com/microsoft/GSL</a>

PACKAGE	VERSION	SOURCE
nlohmann::json	3.7.3	<a href="https://github.com/nlohmann/json">https://github.com/nlohmann/json</a>
mongo-java-driver	3.4.1	<a href="https://mongodb.github.io/mongo-java-driver/3.4/">https://mongodb.github.io/mongo-java-driver/3.4/</a>
org.mongodb.morphia	1.3.1	<a href="https://mongodb.github.io/morphia/1.3/">https://mongodb.github.io/morphia/1.3/</a>
spark-core	2.5.3	<a href="https://github.com/perwendel/spark/releases/tag/2.5.3">https://github.com/perwendel/spark/releases/tag/2.5.3</a>
gson	2.8.0	<a href="https://github.com/google/gson">https://github.com/google/gson</a>
slf4j-api	1.7.22	<a href="https://www.slf4j.org">https://www.slf4j.org</a>
AspectJ Weaver & Runtime	1.8.7	<a href="https://www.eclipse.org/aspectj/">https://www.eclipse.org/aspectj/</a>
oval	1,87	<a href="http://oval.sourceforge.net/">http://oval.sourceforge.net/</a>
Commons Lang	3,5	<a href="https://commons.apache.org/proper/commons-lang/">https://commons.apache.org/proper/commons-lang/</a>
Apache Commons Logging	1,2	<a href="https://commons.apache.org/proper/commons-logging/">https://commons.apache.org/proper/commons-logging/</a>
swagger-annotations	1.5.4	<a href="https://github.com/swagger-api/swagger-core/wiki/Annotations">https://github.com/swagger-api/swagger-core/wiki/Annotations</a>
swagger-models	1.5.4	<a href="https://github.com/swagger-api/swagger-core/wiki/overriding-models">https://github.com/swagger-api/swagger-core/wiki/overriding-models</a>
swagger-jaxrs	1.5.4	<a href="https://github.com/swagger-api/swagger-core/wiki/Swagger-Core-JAX-RS-Project-Setup-1.5.X">https://github.com/swagger-api/swagger-core/wiki/Swagger-Core-JAX-RS-Project-Setup-1.5.X</a>
javax.ws.rs-api	2.0.1	<a href="https://jersey.github.io/download.html">https://jersey.github.io/download.html</a>
Commons IO	2,5	<a href="https://commons.apache.org/proper/commons-io/">https://commons.apache.org/proper/commons-io/</a>
spring-web	4.3.11	<a href="https://projects.spring.io/spring-framework/">https://projects.spring.io/spring-framework/</a>
jackson-core	2.9.1	<a href="https://github.com/FasterXML/jackson-core">https://github.com/FasterXML/jackson-core</a>
jose4j	0.6.0	<a href="https://bitbucket.org/b_c/jose4j/wiki/Home">https://bitbucket.org/b_c/jose4j/wiki/Home</a>
uboot	f44ca27357563-e9ed43f1ff76d3-bd8dd14f4747e	<a href="https://github.com/rockchip-linux/u-boot">https://github.com/rockchip-linux/u-boot</a>
linux	805e544f539-b96d-e96388960173-bb673dab5a9dd	<a href="https://github.com/rockchip-linux/kernel">https://github.com/rockchip-linux/kernel</a>
avb-vbmeta	21e95266704-e572ced1c633-bbc4aea9f42a-fa0a5	<a href="https://android.googlesource.com/platform/external/avb/+21e95266704e572ced1c633bbc4aea9f42afa0a5/avbtool">https://android.googlesource.com/platform/external/avb/+21e95266704e572ced1c633bbc4aea9f42afa0a5/avbtool</a>
bootcontrol	b18c9afdb7-d02e1249cee5-cb430dc9f15a3-ccc27	<a href="https://github.com/rockchip-linux/avb/tree/master/boot_control">https://github.com/rockchip-linux/avb/tree/master/boot_control</a>

PACKAGE	VERSION	SOURCE
libavb	7617e69a524a-cc1a50a8a98-b257d1374ea6fe4a4	<a href="https://github.com/rockchip-linux/avb/tree/master/libavb">https://github.com/rockchip-linux/avb/tree/master/libavb</a>
libavb-ab	7617e69a524a-cc1a50a8a98-b257d1374ea6fe4a4	<a href="https://github.com/rockchip-linux/avb/tree/master/libavb_ab">https://github.com/rockchip-linux/avb/tree/master/libavb_ab</a>
libavb-user	7617e69a524a-cc1a50a8a98-b257d1374ea6fe4a4	<a href="https://github.com/rockchip-linux/avb/tree/master/libavb_user">https://github.com/rockchip-linux/avb/tree/master/libavb_user</a>
rockchip-linux-bin	d6676eb02-c8a1b4966df7-d8c4bb203e-a25fc98b2	<a href="https://github.com/rockchip-linux/bin">https://github.com/rockchip-linux/bin</a>
rockchip-tee-user	1e3bdb582-c52707d71e5c-be29-ca1064d7c04-b696	<a href="https://github.com/rockchip-linux/rk_tee_user">https://github.com/rockchip-linux/rk_tee_user</a>
rockchip-binary	04e55089bb4b-ba-de7c50d9b54-b5a1c-fa70771cd6	<a href="https://github.com/rockchip-linux/rkbin">https://github.com/rockchip-linux/rkbin</a>
rockchip-gstreamer1	59c3bdd06-a22844957fe20-f47c998bb8255-bedd2	<a href="https://github.com/rockchip-linux/gstreamer-rockchip">https://github.com/rockchip-linux/gstreamer-rockchip</a>
rockchip-mpp	862b0d89363-e18e45e5db5c-c6c316a173-c5ac2e7	<a href="https://github.com/rockchip-linux/mpp">https://github.com/rockchip-linux/mpp</a>
rockchip-libmali	f226-e982386287a4-df669e2832d9d-dd613d4153b	<a href="https://github.com/rockchip-linux/libmali">https://github.com/rockchip-linux/libmali</a>
rockchip-linux-rga	72e7764a9f-e358e6a-d50eb1b21176-cc95802c7fb	<a href="https://github.com/rockchip-linux/linux-rga">https://github.com/rockchip-linux/linux-rga</a>
NXP SDK	2.5.0	<a href="https://www.nxp.com/support/developer-resources/software-development-tools/mcuxpresso-software-and-tools/mcuxpresso-software-development-kit-sdk:MCUXpresso-SDK?tab=Design_Tools_Tab">https://www.nxp.com/support/developer-resources/software-development-tools/mcuxpresso-software-and-tools/mcuxpresso-software-development-kit-sdk:MCUXpresso-SDK?tab=Design_Tools_Tab</a>
unlz4	-	<a href="https://github.com/lz4/lz4/blob/dev/lib/lz4.h">https://github.com/lz4/lz4/blob/dev/lib/lz4.h</a>
ring-buff	-	<a href="https://code.google.com/archive/p/ring-buff/">https://code.google.com/archive/p/ring-buff/</a>
wpa_supplicant	2.6	<a href="http://w1.fi/wpa_supplicant/">http://w1.fi/wpa_supplicant/</a>



## EN55032-CISPR32 Class B ITE (Information Technology Equipment)

This is a class B product. In a domestic environment this product may cause radio interference in which case the user may be required to take adequate measures.

If this equipment does cause interference to radio or television reception, the user may try to correct the interference by one or more of the following measures :

- Re-orientation of the receiving antenna for the radio or television.
- Relocate the equipment with respect to the receiver.
- Plug the equipment into a different outlet so that the equipment and receiver are on different branch circuits.
- Fasten cables connectors to the equipment by mounting screws.

## Federal Communication Commission Interference Statement

You are cautioned that changes or modifications not expressly approved by the part responsible for compliance could void the user's authority to operate the equipment.

This equipment has been tested and found to comply with the limits for a Class B digital device, pursuant to Part 15 of the FCC rules. These limits are designed to provide reasonable protection against harmful interference in a residential installation. This equipment generates, uses and can radiate radio frequency energy and, if not installed and used in accordance with the instructions, may cause harmful interference to radio communications. However, there is no guarantee that interference will not occur in a particular installation.

If this equipment does cause harmful interference to radio or television reception, which can be determined by turning the equipment off and on, the user is encouraged to try to correct the interference by one or more of the following measures:

- Reorient or relocate the receiving antenna.
- Increase the separation between the equipment and receiver.
- Connect the equipment into an outlet on a circuit different from that to which the receiver is connected.
- Consult the dealer or an experienced radio/TV technician for help.

You may also find helpful the following booklet, prepared by the FCC: "How to Identify and Resolve Radio-TV Interference Problems." This booklet is available from the U.S. Government Printing Office, Washington D.C. 20402.

Changes and Modifications not expressly approved by the manufacturer or registrant of this equipment can void your authority to operate this equipment under Federal Communications Commissions rules.

In order to maintain compliance with FCC regulations shielded cables must be used with this equipment. Operation with non-approved equipment or unshielded cables is likely to result in interference to radio & television reception.

**FCC RF Radiation Exposure Statement:** This device is capable of operating in 802.11a mode. For 802.11a devices operating in the frequency range of 5.15 - 5.25 GHz, they are restricted for indoor operations to reduce any potential harmful interference for Mobile Satellite Services (MSS) in the US. WIFI Access Points that are capable of allowing your device to operate in 802.11a mode (5.15 - 5.25 GHz band) are optimized for indoor use only. If your WIFI network is capable of operating in this mode, please restrict your WIFI use indoors to not violate federal regulations to protect Mobile Satellite Services.

1. This Transmitter must not be co-located or operating in conjunction with any other antenna or transmitter.
2. This equipment complies with RF radiation exposure limits set forth for an uncontrolled environment.  
This equipment should be installed and operated with a minimum distance of 20 cm between the radiator and your body.

Base Unit FCC ID: 2AAED-R9861511

Button FCC ID (model R9861600D01C): 2AAED-R9861600D01

ClickShare Button 2AAED-R9861600D01 has been tested and meets the FCC RF exposure guidelines. The maximum SAR value reported is 1.19 W/kg.

ClickShare button 2AAED-R9861600D01 should be installed and operated with a minimum distance of 5 mm between the radiator and your body.

## Canada, Industry Canada (IC) Notices

This device complies with Industry Canada licence-exempt RSS standard (s). Operation is subject to the following two conditions: (1) this device may not cause interference, and (2) this device must accept any interference, including interference that may cause undesired operation of the device.

### Radio Frequency (RF) Exposure Information

The radiated output power of the Barco Wireless Device is below the Industry Canada (IC) radio frequency exposure limits. The Barco Wireless Device should be used in such a manner such that the potential for human contact during normal operation is minimized.

#### Caution: Exposure to Radio Frequency Radiation.

1. To comply with the Canadian RF exposure compliance requirements, this device and its antenna must not be co-located or operating in conjunction with any other antenna or transmitter.
2. To comply with RSS 102 RF exposure compliance requirements, a separation distance of at least 20 cm must be maintained between the antenna of this device and all persons.

Base Unit IC: IC: 21559-R9861511

Button IC (model R9861600D01C): 21559-R9861600D01

### IC Antenna statement

Under Industry Canada regulations, this radio transmitter may only operate using an antenna of a type and maximum (or lesser) gain approved for the transmitter by Industry Canada. To reduce potential radio interference to other users, the antenna type and its gain should be so chosen that the equivalent isotropically radiated power (e.i.r.p.) is not more than that necessary for successful communication.

This radio transmitter 23575-R9861511 has been approved by Industry Canada to operate with the antenna types listed below with the maximum permissible gain and required antenna impedance for each antenna type indicated. Antenna types not included in this list, having a gain greater than the maximum gain indicated for that type, are strictly prohibited for use with this device.

### Indoor use only warning

Operation in the band 5150-5250 MHz is only for indoor use to reduce the potential for harmful interference to co-channel mobile satellite systems.

### Certification information (SAR)

This device is also designed to meet the requirements for exposure to radio waves established by the Industry Canada.

The SAR limit adopted by Canada is 1.6 W/kg averaged over one gram of tissue. The highest SAR value reported to the IC for this device type complies with this limit.

The highest SAR value reported to the IC for this device type when using in portable exposure conditions is 1.15 W/kg.

### Informations concernant l'exposition aux fréquences radio (RF)

La puissance de sortie émise par l'appareil de sans fil Barco est inférieure à la limite d'exposition aux fréquences radio d'Industry Canada (IC). Utilisez l'appareil de sans fil Barco de façon à minimiser les contacts humains lors du fonctionnement normal.

#### Avertissement: L'exposition aux rayonnements fréquences radio

1. Pour se conformer aux exigences de conformité RF canadienne l'exposition, cet appareil et son antenne ne doivent pas être co-localisés ou fonctionnant en conjonction avec une autre antenne ou transmetteur.
2. Pour se conformer aux exigences de conformité CNR 102 RF exposition, une distance de séparation d'au moins 20 cm doit être maintenue entre l'antenne de cet appareil et toutes les personnes.

IC Unité de Base: 23575-R9861511

IC Button (model R9861600D01C): 21559-R9861600D01

## **Déclaration d'antenne d'Industrie Canada (IC)**

Conformément à la réglementation d'Industrie Canada, le présent émetteur radio peut fonctionner avec une antenne d'un type et d'un gain maximal (ou inférieur) approuvé pour l'émetteur par Industrie Canada. Dans le but de réduire les risques de brouillage radioélectrique à l'intention des autres utilisateurs, il faut choisir le type d'antenne et son gain de sorte que la puissance isotrope rayonnée équivalente (p.i.r.e.) ne dépasse pas l'intensité nécessaire à l'établissement d'une communication satisfaisante.

Le présent émetteur radio 23575-R9861511 a été approuvé par Industrie Canada pour fonctionner avec les types d'antenne énumérés ci-dessous et ayant un gain admissible maximal et l'impédance requise pour chaque type d'antenne. Les types d'antenne non inclus dans cette liste, ou dont le gain est supérieur au gain maximal indiqué, sont strictement interdits pour l'exploitation de l'émetteur.

## **Utilisation à l'intérieur seulement**

La bande 5 150-5 250 MHz est réservés uniquement pour une utilisation à l'intérieur afin de réduire les risques de brouillage préjudiciable aux systèmes de satellites mobiles utilisant les mêmes canaux.

## **Informations de certification (DAS)**

Cet appareil est également conçu pour satisfaire aux exigences concernant l'exposition aux ondes radioélectriques établies par Industrie Canada.

Le seuil du DAS adopté par le Canada est de 1.6 W/kg pour 1g de tissu. La plus grande valeur de DAS signalée à IC pour ce type d'appareil ne dépasse pas ce seuil.

La valeur maximale de DAS signalée à IC pour ce type d'appareil lors du test dans des conditions d'exposition portative est de 1.15 W/kg.



# Introduction to the Installation Guide

# 1

1.1	Documentation .....	22
1.2	Symbols and fonts .....	22

## 1.1 Documentation

### About the documentation

This installation guide explains how to install your CX-20 in a meeting room, It explains also how to make everything operational. It provides detailed information on how to configure your CX-20 .

### Available System documentation

Next to the installation manual, a user guide, a safety guide, an API guide and a service manual are available on Barco's website, [www.barco.com/clickshare](http://www.barco.com/clickshare).

A printed copy of the Safety Guide is included in the CX-20 box at purchase.







Depending on the CX-20 version, some graphics might be different to the ones used in this manual. This however does not have any effect on the functionality.

## 1.2 Symbols and fonts

### Symbol overview

The following icons are used in the manual :

	Caution
	Warning
	Info, term definition. General info about the term
	Note: gives extra information about the described subject
	Tip: gives extra advice about the described subject

### Font overview

- Buttons are indicated in bold, e.g. **OK**.
- Menu items are indicated in *italic*.
- Step related notes, tips, warnings or cautions are printed in *italic*.
- Procedure related notes, tips, warnings or cautions are printed in **bold** between 2 lines preceded by the corresponding icon.

# CX-20 Specifications

# 2

## 2.1 About the CX-20

### CX-20 sets

With the Conferencing Button, in seconds, you are automatically connected to cameras, mics, soundbars and any other AV peripherals in the room for a better, more immersive meeting experience. Everything becomes part of your laptop.

This CX-20 not only helps the presenter get the presentation on-screen in a second, but it also allows the other people in the conference to participate more actively. The result is enhanced meeting efficiency and better decision-making.

The set is compatible with any laptop, desktop tablet or smartphone OS. It works with most conferencing platforms and connects instantly with most brands of peripherals (speakers, microphones, webcams, soundbars) when using the Conferencing Button.

At the moment 6 different sets are available on the market. Each set is sold in its specific region and it can only be used in that specific region because of WiFi regulations.

### Components CX-20 set

A standard CX-20 set consists of a Base Unit and 1 Conferencing Button. Depending on the location where you buy the product, the software of the Base Unit is different. If needed, you can buy additional Conferencing Buttons and a tray to store the Buttons.

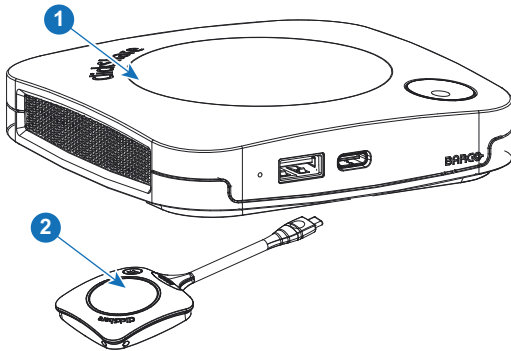

Image 2-1

- |   |                                  |
|---|----------------------------------|
| 1 | Base unit                        |
| 2 | Conferencing Button <sup>2</sup> |

### Accessories included

Depending on the country where you buy the product, the following regionalized accessories are also included in the CX-20 box.

Products	Contains	Accessories included
R9861512xx <sup>3</sup>	<ul style="list-style-type: none"> <li>R9861511</li> <li>1x R9861600D01C<sup>4</sup></li> </ul>	<ul style="list-style-type: none"> <li>DC adapter with AC clips type A, C, G, I<sup>5</sup></li> <li>Wall mount system</li> <li>Printed safety manual</li> </ul>
R9861600D01C <sup>4</sup>	1x R9861600D01C <sup>4</sup>	

Contact your local sales representative for the correct regional variant to be used in your country.

2: Further called Button  
 3: xx=EU, CN, NA, US, ZH, RW,  
 4: For US, R9861600D01CUS  
 5: Included AC clips can be different according to the region



## 2.2 CX-20 Specifications

### Base unit

<b>Dimensions (HxWxD)</b>	34 mm x 135 mm x 135 mm
<b>Power supply</b>	Standard 110/220 V AC plug
<b>Power consumption</b>	Operational: 5-10W, 24W Max
<b>Weight</b>	900 gr
<b>Operating system</b>	Windows 8/8.1/10. macOS 10.13 and higher. Android v9 and higher (ClickShare app). iOS 12 and higher (ClickShare app)
<b>Video outputs</b>	4K UHD (3840*2160) @ 30Hz. HDMI 1.4b
<b>Audio output</b>	USB, HDMI
<b>USB</b>	1 X USB-A, 1 X USB-C
<b>ClickShare Buttons</b>	1
<b>ClickShare App</b>	Desktop & Mobile
<b>Native protocols</b>	Aiplay, Google Cast, Miracast*
<b>Noise Level</b>	Max. 25dBA @ 0-30°C Max. 30dBA @ 30-40°C
<b>Authentication protocol</b>	WPA2-PSK in stand alone mode WPA2-PSK or IEEE 802.1X using the ClickShare Button in network integration mode
<b>Wireless transmission protocol</b>	IEEE 802.11 a/g/n/ac and IEEE 802.15.1
<b>Reach</b>	Adjustable with signal strength modulation; max. 30m (100 ft) between ClickShare Button and ClickShare Base Unit Frequency band 2.4 GHz and 5 GHz (DFS)
<b>Frequency band</b>	2.4 GHz and 5 GHz (DFS channels supported in select number of countries)
<b>Connections</b>	1x Ethernet LAN 1Gbit 1x USB Type-C 2.0 (front); 1x USB Type A 2.0 (front)
<b>Temperature range</b>	Operating: 0°C to +40°C (+32°F to +104°F) Max: 35°C (95°F) at 3000m Storage: -20°C to +60°C (-4°F to +140°F)
<b>Humidity</b>	Storage: 0 to 90% relative humidity, non-condensing Operation: 0 to 85% relative humidity, non-condensing
<b>Anti-theft system</b>	Kensington lock
<b>Certifications</b>	FCC/CE
<b>Touch screen support &amp; Interactivity</b>	/
<b>Room Dock (peripheral support)</b>	Yes

<b>Local view &amp; moderation</b>	Local view of the room display only
<b>Network connection</b>	LAN & WiFi *
<b>Management and reporting</b>	Yes
<b>Warranty</b>	1 year standard. 5 years coverage via SmartCare
*	* depends on configuration, available in future firmware updates

## 2.3 About the Base Unit

### Base Unit functionality

The Base Unit receives the wireless input from the Buttons and controls the content of the meeting room display and the peripherals connected to the Base Unit (speakers, microphones, webcam and soundbar). Furthermore, it will send out the content from the camera and/or the echo-cancelling speakerphone towards the Button.

The Base Unit can be put on the meeting room table or mounted on a wall or ceiling. Check the installation guide for instructions on how to install the Base Unit.

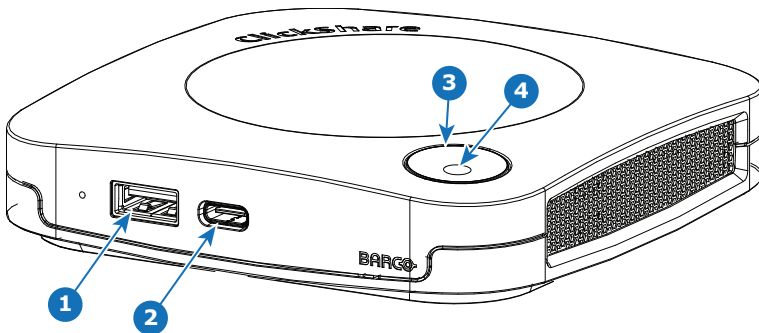

Image 2-2

- |   |                           |
|---|---------------------------|
| 1 | USB Type-A port (USB 2.0) |
| 2 | USB Type-C port (USB 2.0) |
| 3 | Status LED ring           |
| 4 | Standby Button            |

### USB ports

Both USB ports, one USB Type-C™ and one USB Type-A, are used to connect a USB camera or USB echo-cancelling speakerphone to the Base Unit. Additionally these ports are also used to pair the Buttons or update the software when both are not done via XMS.

When plugging in the Button into the Base Unit, the Button is paired to the Base Unit. The Base Unit checks whether the software and firmware of the Button is up to date. If not, the Base Unit updates the software and/or firmware.

The use of a convertor is sometimes necessary to connect to one of these ports.

### Status LED ring

The color of the LED ring around the power button of the Base Unit give information on the status of the system.

LEDs behavior	Explanation
static red	<ul style="list-style-type: none"> <li>receiving content from the Buttons and streaming towards the display.</li> <li>during the first phase of the Base Unit boot process.</li> </ul>
blinking white	<ul style="list-style-type: none"> <li>system is starting up (during the second phase)</li> <li>Button pairing is in progress</li> <li>software update of the Base Unit</li> </ul>
breathing white	<ul style="list-style-type: none"> <li>ECO standby mode</li> </ul>
static white	<ul style="list-style-type: none"> <li>awake and ready (i.e. showing the welcome message on the display)</li> <li>pairing and software update of the Button is done, you can now unplug the Button from the Base Unit..</li> </ul>
red blinking	<ul style="list-style-type: none"> <li>an error occurred</li> </ul>
dark	<ul style="list-style-type: none"> <li>deep standby/off</li> </ul>

## Back layout of the Base unit

The connection panel is situated at the back of the Base unit.

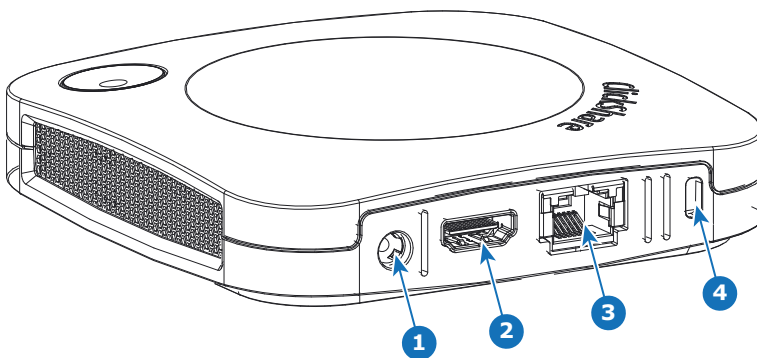

Image 2-3

- |   |                         |
|---|-------------------------|
| 1 | Power connection        |
| 2 | HDMI out                |
| 3 | LAN Ethernet connection |
| 4 | Kensington lock         |

## Mechanical fixture points

The mechanical fixture points are located at the bottom of the Base Unit.

## Antenna

The antenna is built-in in the CX-20 .

## Bottom layout of the Base Unit

The serial number label containing the Barco part number, the revision number, production date (week-year) and the serial number.

The product label with the applicable certification logos.

The product label contains:

- the Barco logo
- the product name
- the Barco part number

## CX-20 Specifications

- the power rating
- markings for applicable standards (CE, CCC, UL, ...)
- markings for waste regulation
- "Made in ..."

# Getting started

# 3

3.1	Environmental Condition Check.....	30
3.2	Basic Workflow.....	30

## 3.1 Environmental Condition Check

### Environment condition check

For installations in environments where the device is subject to excessive dust, then it is highly advisable and desirable to have this dust removed prior to it reaching the device clean air supply. Devices or structures to extract or shield excessive dust well away from the device are a prerequisite; if this is not a feasible solution then measures to relocate the device to a clean air environment should be considered.

It is the customer's responsibility to ensure at all times that the device is protected from the harmful effects of hostile airborne particles in the environment of the device. The manufacturer reserves the right to refuse repair if a device has been subject to negligence, abandon or improper use.

### Ambient temperature conditions

Max. ambient temperature : +40°C or 104°F

Min. ambient temperature: +0°C or 32°F

Storage temperature: -10°C to +60°C (14°F to 140°F)

### Humidity Conditions

Storage: 0 to 90% relative humidity, non-condensing

Operation: 0 to 85% relative humidity, non-condensing

### Environment

Do not install the device in a site near heat sources such as radiators or air ducts, or in a place subject to direct sunlight, excessive dust or humidity. Be aware that room heat rises to the ceiling; check that temperature near the installation site is not excessive.

## 3.2 Basic Workflow

### Before using CX-20

1. Unpack the ClickShare components and accessories from the box.  
For a detailed overview of the content of the CX-20 box, see “*About the CX-20*”, page 24.
2. Install the Base Unit in the meeting room using one of the possible installation methods.  
For more information on the installing procedures, see “*CX-20 Installation*”, page 31
3. Connect the video signal between the Base Unit and the display, see “*Video signal connections to the Base unit*”, page 35.
4. Connect USB camera to Base Unit if any, see “*Camera connection*”, page 36
5. Connect the Base Unit to the mains power.  
For more information see “*Power connection*”, page 38,
6. Connect a network cable between the Base Unit and the local network (make sure the Base Unit is connected to the internet to be able to reach the update server ).
7. Register you device, online or offline.



For more information on using CX-20 , refer to the CX-20 User Guide. This manual can be found on Barco's website [www.barco.com/clickshare](http://www.barco.com/clickshare).

# CX-20 Installation

# 4

4.1	Installation methods for the Base Unit .....	32
4.2	Table mounting .....	32
4.3	Wall or ceiling mounting .....	32
4.4	Out-of-the-box use of the Base Unit .....	34
4.5	Out-of-the-box use of the Base Unit with Ethernet link .....	35
4.6	Video signal connections to the Base unit .....	35
4.7	Camera connection.....	36
4.8	Content Audio connection .....	36
4.9	Echo Canceling Speakerphone audio connection.....	37
4.10	LAN connection .....	37
4.11	Power connection .....	38
4.12	Starting up for the first time.....	38
4.13	First setup of the Base Unit.....	39
4.14	Registration to XMS Cloud .....	40
4.15	Use without registration of the device .....	42
4.16	Basic configuration of the ClickShare device.....	45

## 4.1 Installation methods for the Base Unit



For optimal performance, install the Base unit close to the display and avoid obstacles between the Base unit and the Buttons.



Make sure not to install the Base Unit in a metal enclosure.

### Physical installation

The Base unit can be installed in different ways in a meeting room.

- Table mount
- Wall mount
- Ceiling mount

### Standalone or network integration

The Base Unit can be use as standalone unit or integrated in a corporate network.

- Out-of-the-box use
- Out-of-the-box use with Ethernet link

## 4.2 Table mounting

### Overview

Put the Base Unit directly on the meeting room table.

The total weight of the Base Unit is 530 g.

## 4.3 Wall or ceiling mounting

### About wall or ceiling mounting

A mounting base is used to mount the CX-20 to the wall or ceiling. This base has key-shaped screw holes to allow you to fasten the base to a wall or ceiling or you can use the self-adhesive layer to mount the base. Once you determine the location for your device follow the next procedure to mount the device.

### Mounting with screws

1. Take the mounting base out of the package.
2. Place the mounting base on the wall or ceiling and mark the screw holes (1).



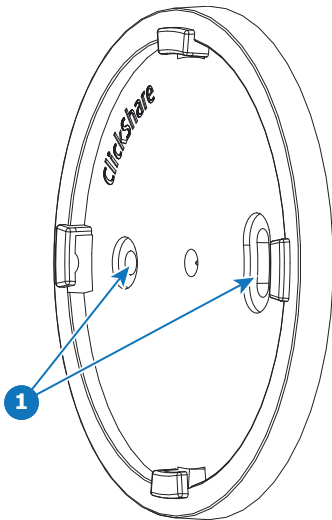

Image 4-1

3. Select a drill bit slightly smaller than the size of the used anchors to ensure a snug fit.
4. Drill the holes where marked.
5. Tap plastic screw anchors into the drill holes with a hammer (if needed, depending on the wall or ceiling type).
6. Place the mounting base on the ceiling or wall, drive in the screws.
7. Place your device on the mounting base and turn it clockwise until it is locked.

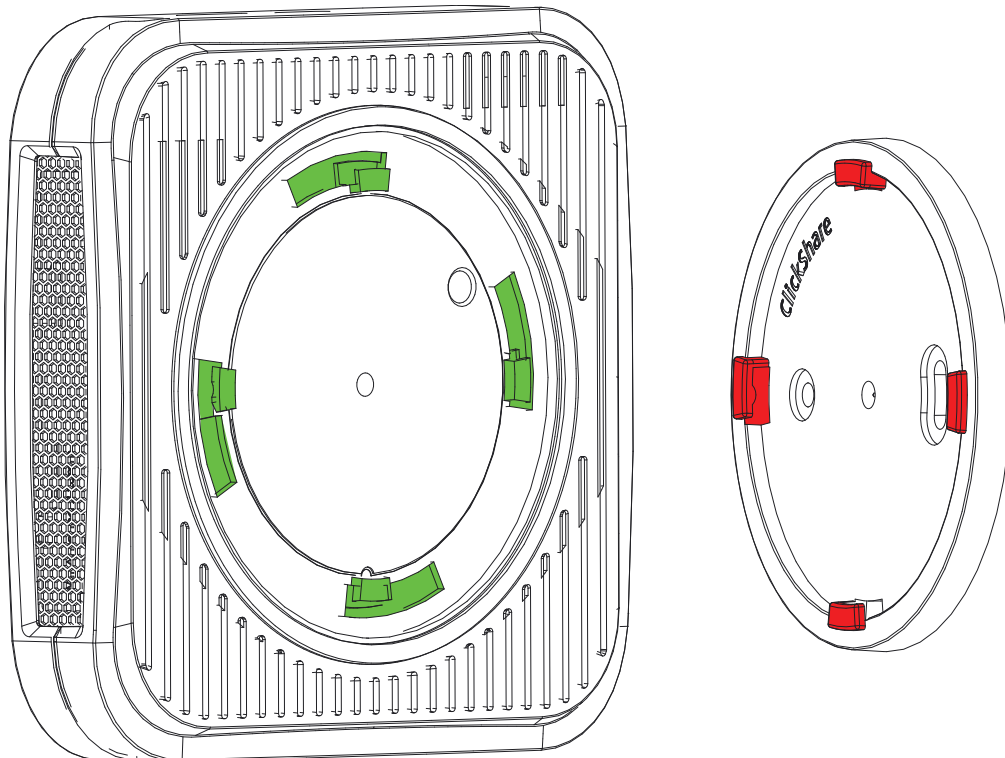

Image 4-2

### Mounting with the self-adhesive layer

1. Peel off the removable protection foil.

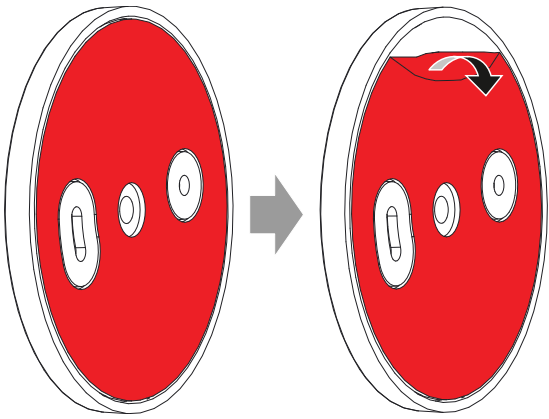

Image 4-3

2. Stick the base on the chosen location.
3. Place your device on the mounting base and turn it clockwise until it is locked (Image 4-2).

## 4.4 Out-of-the-box use of the Base Unit

### Overview

The ClickShare Base Unit and Button (s) operate directly out of the box, without any integration in the Enterprise network. The Base Unit should be connected to the internet at least once to update and to register. Users can connect directly to the Base Unit via the ClickShare Buttons, using the ClickShare App or Miracast or with their mobile devices using Airplay or Google Cast.

Using a ClickShare Button allows you to stay connected to the internet. Using the ClickShare App, Airplay or Google Cast will require connecting to the Base Unit directly and will only be able to access the internet if the device supports to use data (3G/4G) at the same time.

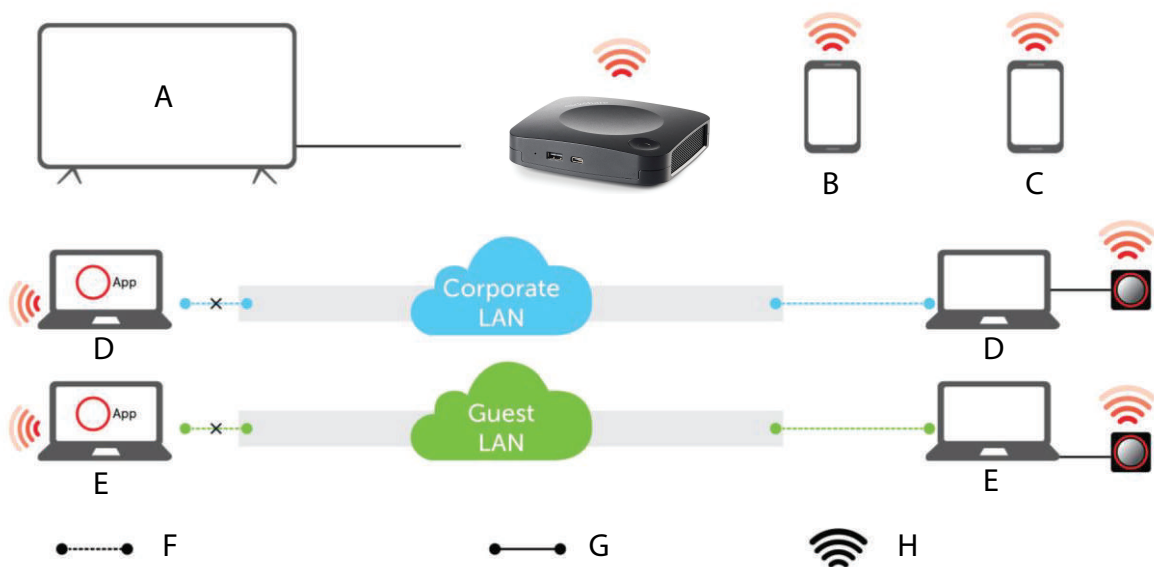

Image 4-4: Out-of-the-Box use

- |                              |  |
|------------------------------|--|
| <b>A</b> Meeting room screen | <b>E</b> Guest laptop                    |
| <b>B</b> Employee mobile     | <b>F</b> Wireless or Ethernet connection |
| <b>C</b> Guest mobile        | <b>G</b> Ethernet connection             |
| <b>D</b> Employee laptop     | <b>H</b> Wireless connection             |

Using the ClickShare Base Unit and Buttons directly out of the box is ideal for temporary setups, visitor centers and small to medium installations without network integration needs or possibilities. This setup

requires the least installation effort and keeps any shared data completely separated from your Enterprise network. Updating and configuring the Base Units will need to be done manually.

## 4.5 Out-of-the-box use of the Base Unit with Ethernet link

### Overview

In this extended out-of-the-box mode, an Ethernet connection is made between the ClickShare Base Unit and the corporate network. The ClickShare Base Unit Wi-Fi is kept enabled, ensuring users can still connect directly to the Base Unit via the ClickShare Buttons, using the ClickShare App, Miracast, Airplay or Google Cast. Employee computers running the ClickShare App and employee mobile devices using Airplay or Google Cast can connect via the corporate LAN.

Using a ClickShare Button allows guests to stay connected to the Guest LAN and thus retain internet connectivity. Guest mobile devices will usually need to connect to the Base Unit directly and will only be able to access the internet if the device supports to use data (3G/4G) at the same time.

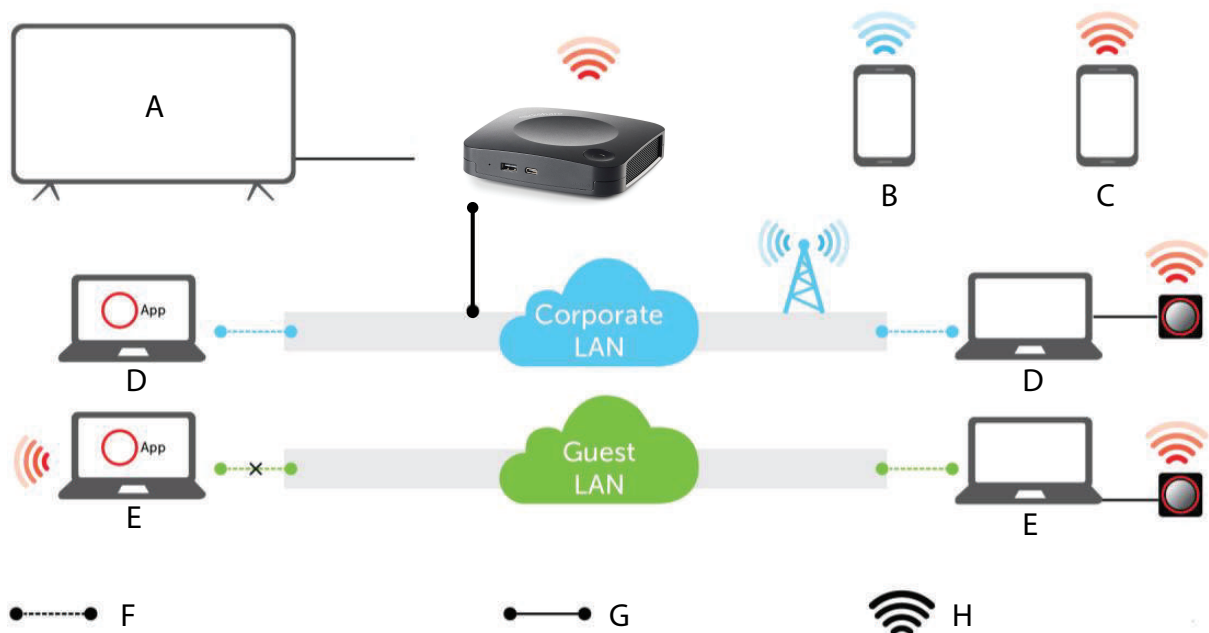

Image 4-5: Out-of-the-Box use with Ethernet link

- |          |                     |          |                                 |
|----------|---------------------|----------|---------------------------------|
| <b>A</b> | Meeting room screen | <b>E</b> | Guest laptop                    |
| <b>B</b> | Employee mobile     | <b>F</b> | Wireless or Ethernet connection |
| <b>C</b> | Guest mobile        | <b>G</b> | Ethernet connection             |
| <b>D</b> | Employee laptop     | <b>H</b> | Wireless connection             |

Using the ClickShare Base Unit and Buttons directly out of the box is ideal for temporary setups, visitors' centers and small to medium installations without network integration needs. The Ethernet connection allows employees to use the ClickShare App without switching their Wi-Fi network.

## 4.6 Video signal connections to the Base unit

### About Video signal connection

A single screen can be connected to the Base unit.

To connect a display, an HDMI connection should be made between the Base Unit and the display.

### To connect

1. Connect the Base unit to the display using a display cable.

 *Note:* No display cables are included in the ClickShare box at purchase.

When setting up a display configuration, connect the HDMI cable to the display. When necessary, use an adapter piece to connect to a display port or a DVI port on the display side.

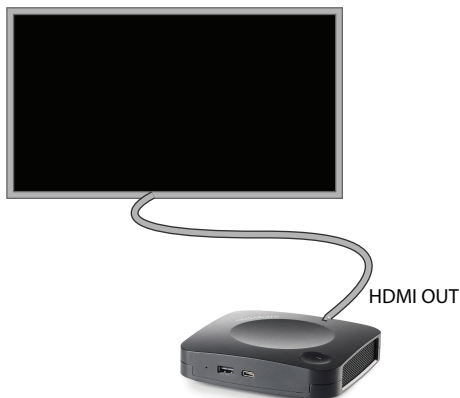

Image 4-6: Display connection

## 4.7 Camera connection

### About USB cameras

Any USB camera can be connected to the Base Unit. A list of supported cameras can be found on Barco's website.

### To connect

1. Connect the camera via USB to the Base Unit.

Camera connected to the Base Unit is accessible when plugging in the button. No drivers required, all camera's will be visible to the user as "ClickShare Camera".

## 4.8 Content Audio connection

### About content audio (no speakerphone connected)

The ClickShare Button captures the audio output of the user's laptop and sends it to the Base Unit together with the video signal. The audio can be output at line levels from the mini jack socket (3.5mm), TOSLINK socket or via the HDMI connector (can be set in the configurator).

It is up to the user to decide whether or not to send the audio signal together with the video signal. The user can decide this by using the same tools as he would to control the laptop's speakers or a headphone: the audio controls of the operating system or the physical buttons on the keyboard of their laptop (mute/unmute, lower volume, higher volume).

There will be synchronization between the audio and video signal when the user is sharing content.

### About content audio (speakerphone connected)

The content audio captured on the user' laptop is transmitted via the sharing Button to the Base Unit and is send to USB port with speakerphone connected.

### Audio via HDMI (no speakerphone connected)

When your display is connected via HDMI and it supports audio, a separate audio connection is not necessary. The audio signal is sent together with the video signal to the display.

When USB speakerphone is attached to the Base Unit, this will output all audio. Even if separate audio system is attached.

## Sound is not sent out

In some Windows environments sound is not sent out. This can be solved as follow (depending on your Windows version):

E.g. for Windows 7:

1. Right click on the sound icon in the system tray and select *Default device*. The *Sound* window opens.
2. Select Speakers ClickShare, select *Set default* and click **Apply**.

E.g. for Windows 10

1. Click on the sound icon in the system tray and click on the arrow up to open possibilities.
2. Select the desired device.

## 4.9 Echo Canceling Speakerphone audio connection

### About echo canceling speakerphone audio

The audio capture by an echo canceling speakerphone connected to the Base Unit is send to the Button and can be used in remote conference. The content audio transmitted from the Button to the Base Unit is send to the speakerphone.

It is a bidirectional audio transmission between the Button and the speakerphone.

### USB speakerphone support

A list of supported speakerphones can be found on Barco's website.

### How to connect an echo-canceling speakerphone

1. Connect your speakerphone device via USB to the Base Unit.

When USB speakerphone is attached to the Base Unit, this will output all audio. Even if separate audio system is attached for the content audio..

### Sound is not sent out

In some Windows environments sound is not sent out. This can be solved as follow:

E.g. for Windows 7

1. Right click on the sound icon in the system tray and select *Default communication device*. The *Sound* window opens.
2. Select Echo Cancelling Speakerphone, select *Set default* and click **Apply**.

E.g. for Windows 10

1. Click on the sound icon in the system tray and click on the arrow up to open possibilities.
2. Select the desired device.

## 4.10 LAN connection

### About LAN connection

The Base Unit can be connected to a local network or directly to a laptop.

Maximum allowed LAN speed: 1000 Mbit

We do strongly advise the LAN connection and the use of XMS cloud for configuration, monitoring and additional functionality. The LAN connection also greatly improves the user experience when using the ClickShare Apps and native sharing protocols such as Airplay and others.

### How to connect

1. Insert a network cable with RJ-45 connector into the LAN port.

2. Connect the other side to a LAN.

## 4.11 Power connection

### About power

An external power adapter is delivered with the product. The output rate is 12 VDC 2A.



**CAUTION:** Once the Base Unit is powered, it starts up. Then the power button can be used to switch on or off.

### How to connect the external power adapter

1. Plug the barrel connector of the power adapter into the power input of the Base unit.
2. Slide a power input adaptor piece (US, AU, IN, CH, EU or UK) on the power adapter of the ClickShare until it clicks. Use the one which is applicable in your country.



Image 4-7: Power adapter

3. Connect the power cable to the wall outlet.

## 4.12 Starting up for the first time

### How to startup

The following steps are necessary before the Base Unit can be used:

1. Connect the screen, all USB devices and the power to the Base Unit.
2. The Base Unit reboots when the update is finished.
3. Base unit needs Internet access to start up for the first time. The Base Unit updates to the latest firmware version.
4. Register and configure your device in XMS cloud.
5. Pair the buttons with the Base Unit.
6. Base Unit is ready to use.

## 4.13 First setup of the Base Unit



After the physical installation is done, start with the first setup procedure to activate and configure your device.

### Preferred workflow

1. Plug in the power supply and HDMI cable.

The Base Unit starts up.



Image 4-8

2. Plug in a network cable.

The system checks for updates.

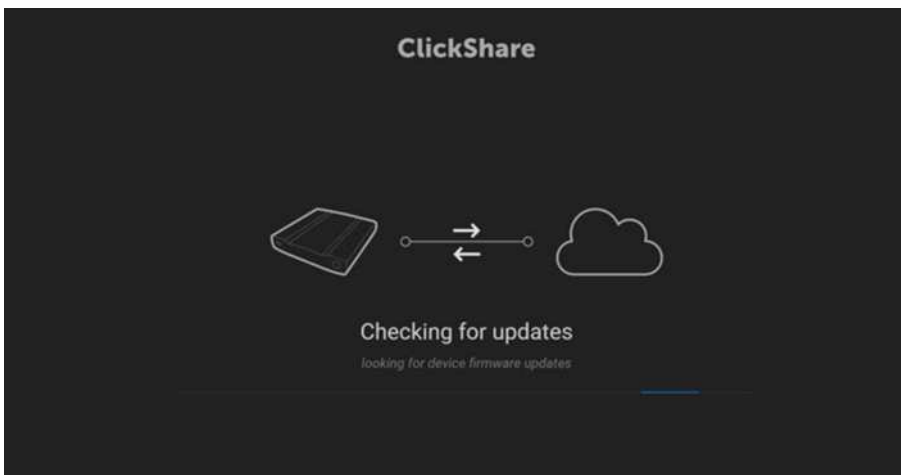

Image 4-9

If an update is available, the base unit will download, update and reboot  
if no update is available, the unit will continue to the next step

3. Start registration to XMS cloud.

## 4.14 Registration to XMS Cloud

### About registration

When your device is connected to the internet and updated you can start to register your device. You have to register your device in order to claim your 5 years SmartCare warranty.

Registration can be done to

- XMS cloud by the end customer (preferred flow) or reseller.

### Online to XMS cloud

1. When software update is finished and reboot is done, the customer will be asked to surf to <https://xms.cloud.barco.com/add>.



Image 4-10

The XMS login page is displayed.

2. Login with your Barco account. When you do not have a Barco account yet, click on **register here** and follow the instructions.

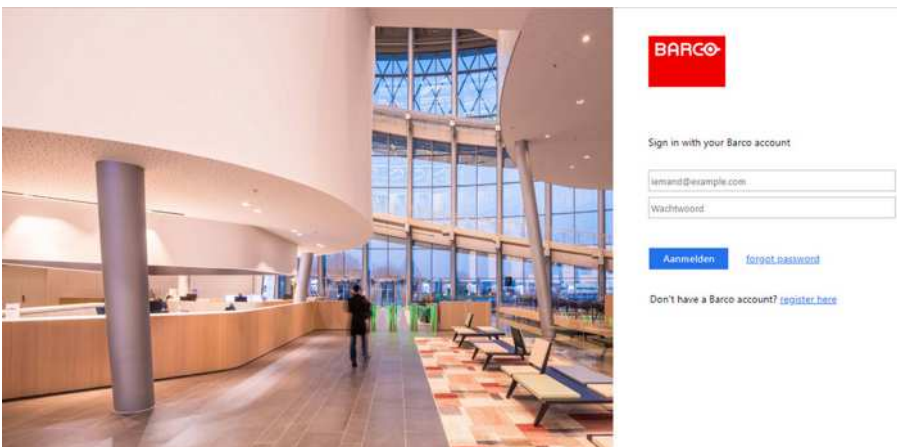

Image 4-11: Sign in page

3. Click **Sign in**.

The XMS cloud welcome page is displayed.



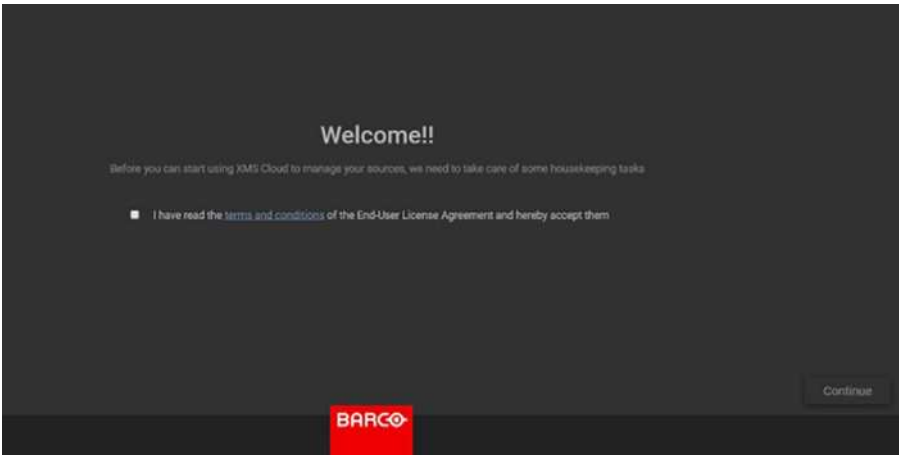

Image 4-12: Welcome page to XMS-cloud

4. Accept the End User License agreement and click **Continue**.
5. Fill out your company information and click **Continue**.

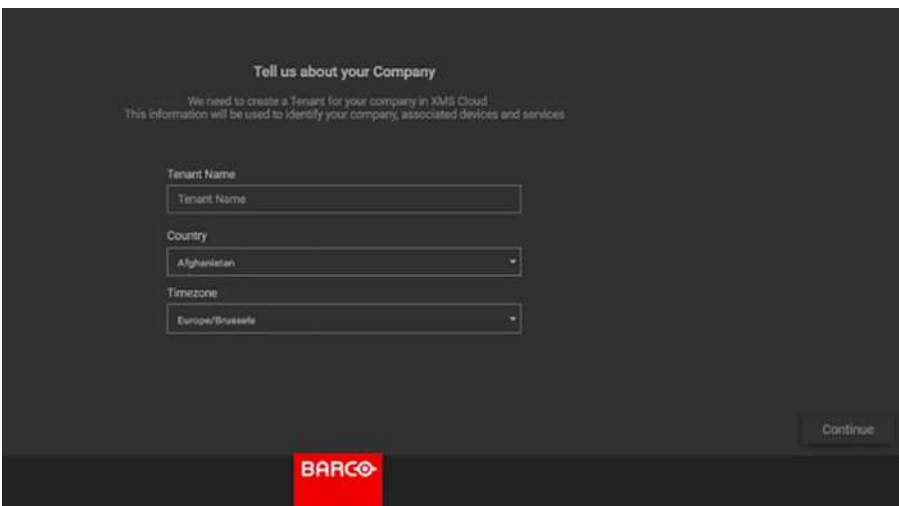

Image 4-13: Company information

6. Enter the device token to setup your device and to receive your 5 years of service coverage. The device token is indicated on the ClickShare screen (see Image 4-10)  
Click **Continue**.

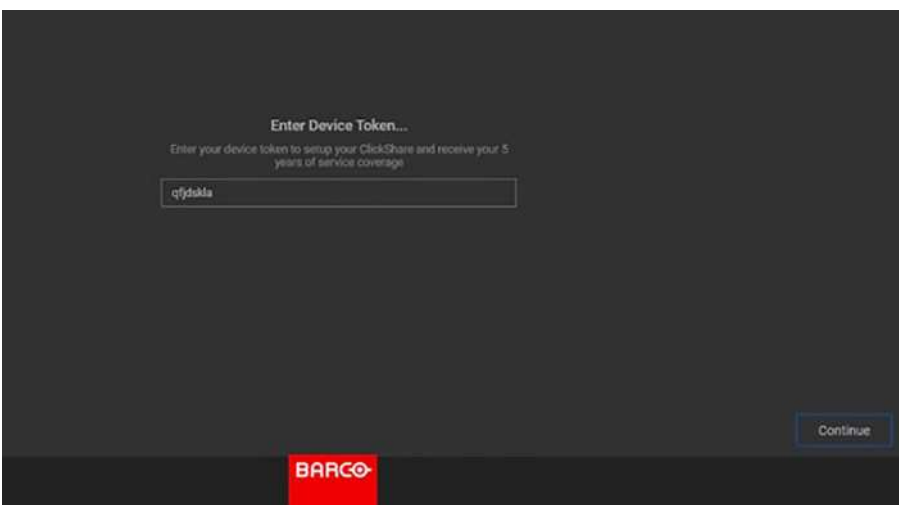

Image 4-14: Enter device token

- Assign a meeting room and click **Continue**.

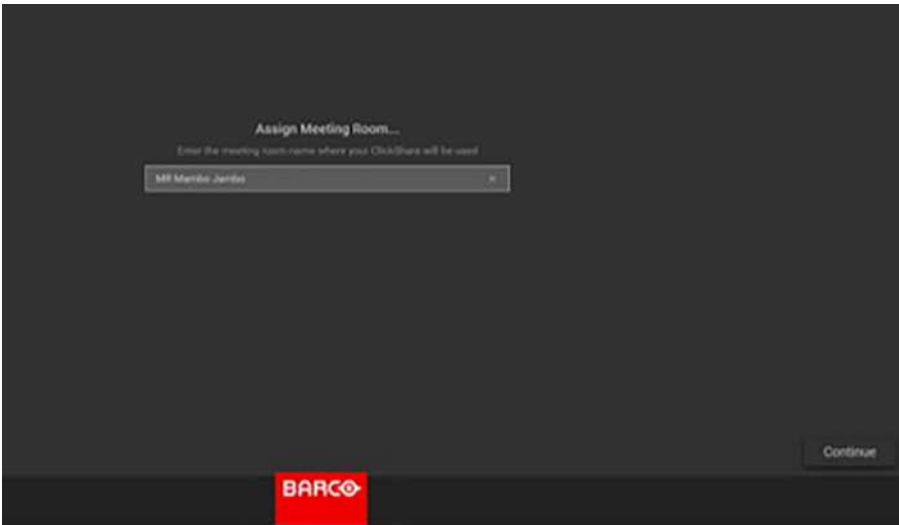

Image 4-15: Assign meeting room

Your device is successfully registered.

- Start pairing your buttons to start using your device.



Image 4-16: Start pairing buttons

The wallpaper page will be displayed.

## 4.15 Use without registration of the device

### Why using offline

Several reasons are possible to use your product without registration:

- When you cannot reach the XMS servers at this moment
- If you cannot accept the XMS eula
- if you do not want the smart care package,.

then you can skip the registration



The end-customer, then has 6 months to still register the unit in XMS cloud to activate the Smart Care package

## How to handle

1. Connect the device's WiFi with the instruction given on the wallpaper.  
The default SSID is ClickShare-<serial number>.  
Password : clickshare
2. Once your WiFi connection is made, continue with the network setting of your device.  
Browse to <http://192.168.2.1>  
The ClickShare Configurator starts up.

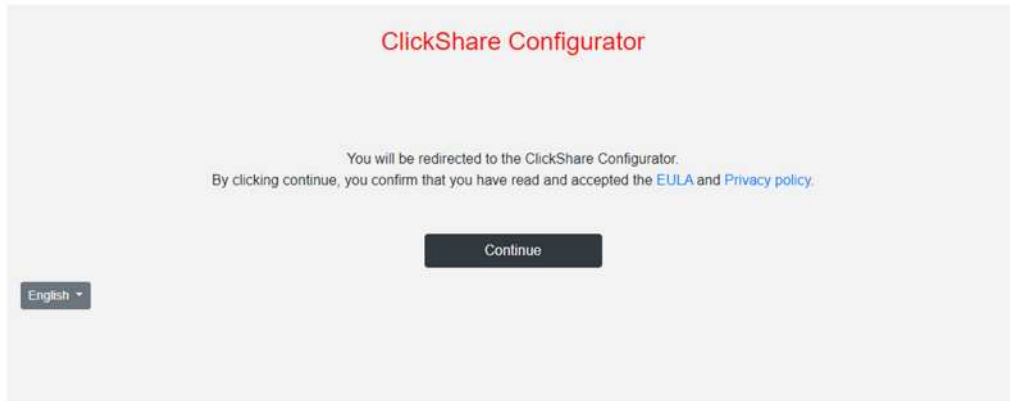

© 2019, Barco. All rights reserved.



Image 4-17: Configurator startup

3. To change the language, click on the drop down box of the current indicated language and select the desired language.

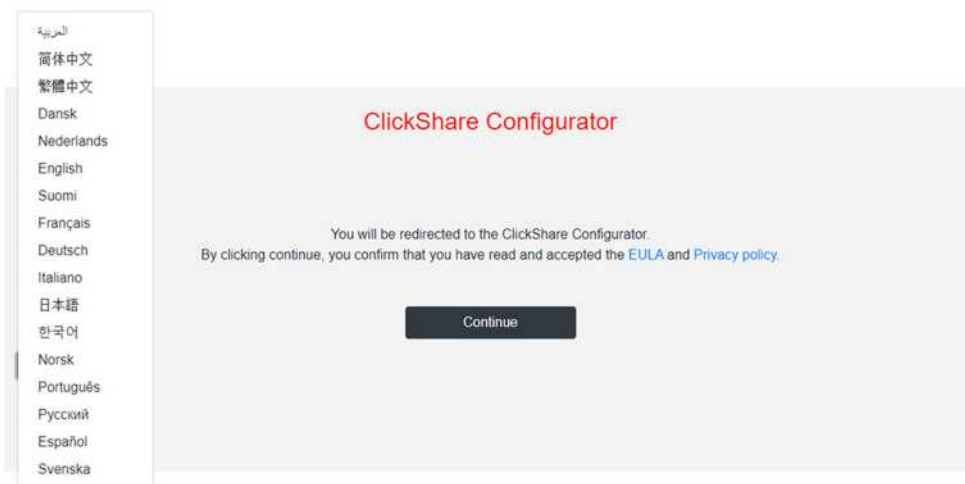

© 2019, Barco. All rights reserved.



Image 4-18: Configurator, language selection

4. Click **Continue** to start.  
A registration message is displayed.

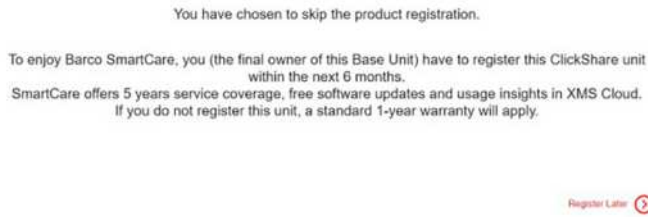



Image 4-19: Registration message

- 5. Click **Register Later**.
- 6. Start pairing your buttons.



Image 4-20: Start pairing

- 7. Start configuring the network settings. For more info, see “*Basic configuration of the ClickShare device*”, page 45

 Your still have to register your device to get your 5 years warranty.

### XMS Cloud note in Configurator

When browsing in the Configurator to *Wi-Fi & Network* → *Services*, you will see a XMS Cloud integration message how to register it and the token to use.



Image 4-21: XMS cloud message

## 4.16 Basic configuration of the ClickShare device



Make sure you are connected via WiFi to the Base Unit.

### How to setup

1. Open an internet browser and browse to <http://192.168.2.1>  
The ClickShare Configurator starts up.

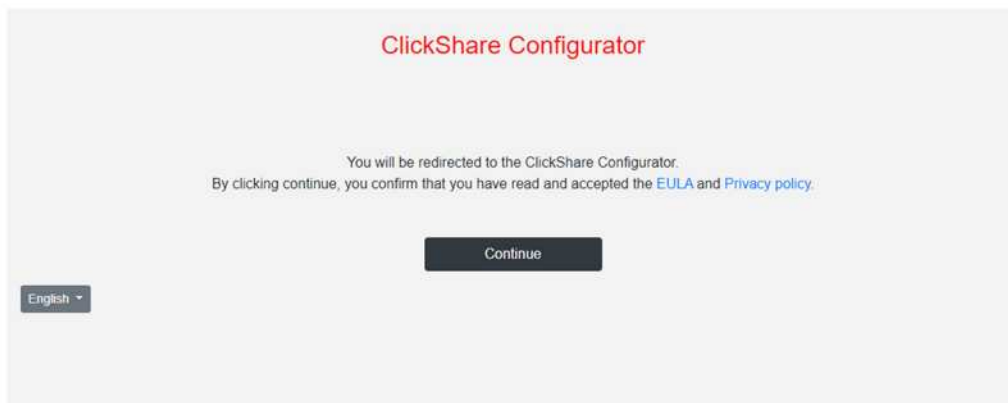

© 2019, Barco. All rights reserved.



Image 4-22: Configurator startup

2. To change the language, click on the drop down box of the current indicated language and select the desired language.

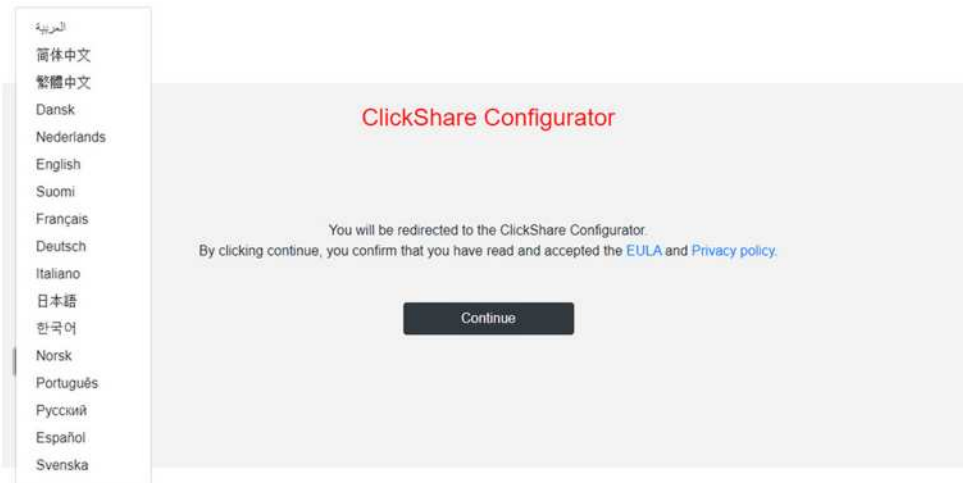

© 2019, Barco. All rights reserved.



Image 4-23: Configurator, language selection

3. Click **Continue** to start.  
A registration message is displayed.
4. Click **Next** to continue.  
The Configurator Login page is displayed.

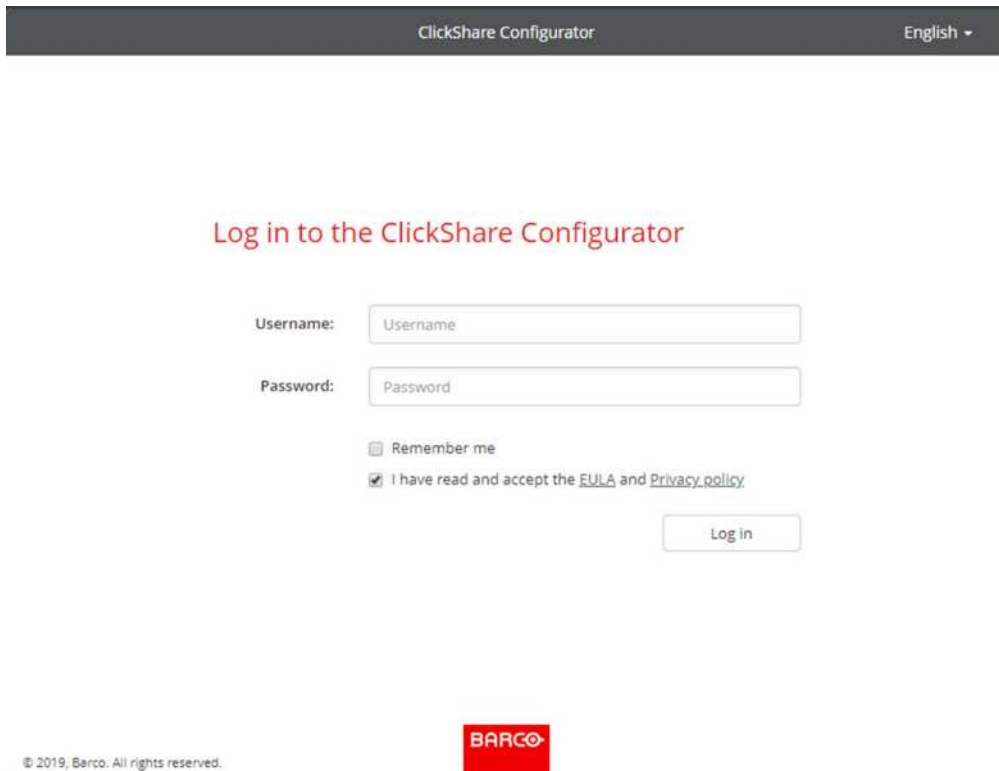

Image 4-24: Configurator, login page

5. Log in with the following default credentials. These credentials can be changed later on.  
*Username:* admin  
*Password:* admin  
A welcome page to the ClickShare Configuration Wizard opens.

6. Click **Start configuration**.

Follow the instructions as given on the different pages.

Click **Next** to continue to the next page and **Back** to return to the previous page.

7. Fill out:

- |                 |  |
|-----------------|--|
| Personalisation | <ul style="list-style-type: none"> <li>• Language for on-screen text</li> <li>• Meeting room name</li> <li>• Location name</li> <li>• Welcome message</li> </ul> |
|-----------------|--|

- 
- |        |   |
|--------|---|
| System | <ul style="list-style-type: none"> <li>• Select your time zone</li> <li>• date and time mode setting, manually or via NTP.</li> </ul> |
|--------|---|

---

Security	select your desired security level
----------	------------------------------------

---

Password	Enter a new password to login to the ClickShare Configurator.
----------	---

- 
- |         |   |
|---------|---|
| Network | Setup the network settings: <ul style="list-style-type: none"> <li>• Select frequency band</li> <li>• Select a channel</li> <li>• Change the SSID if you want. The default value is <i>ClickShare-<br/>&lt;serial number&gt;</i>.</li> <li>• Check or uncheck broadcast SSID</li> <li>• Enter a new WiFi passphrase.</li> </ul> |
|---------|---|

For more detailed information about all these settings,

Your Base Unit can now communicate via LAN.

Start pairing the buttons.





# Preparing the Buttons

# 5

5.1	Pairing .....	50
5.2	ClickShare Extension Pack .....	51
5.3	ClickShare Extension Pack installer .....	51
5.4	ClickShare Windows Certified driver .....	52
5.5	ClickShare Desktop app.....	52

## 5.1 Pairing

### Pairing of the Buttons with the Base Unit

To be able to use a Button it should be assigned to the Base Unit you are using. This process is called pairing. All Buttons will need to be updated and paired before use.

In case you buy additional Buttons or when a Button should be assigned to another Base Unit, the Button needs to be paired (again). The Button software update runs in the background and will not impact users while using the system. When downgrading or updating to an older version of the Base Unit software the Buttons need to be paired manually to update their software.



A Button can only be paired to one Base Unit at a time.  
The Button will always make connection to the Base Unit it was last paired to.

Pairing a Button can be done in two ways:

- by plugging the Button to the Base Unit.
- by using the Button Manager application running on your laptop.

### To pair a Button to the Base unit by plugging in

1. Insert the Button in one of the USB port available on the Base Unit you are using (image is only given as example, all USB connectors can be used).



*Note:* For some ports or Buttons, it can be necessary to use a convertor.

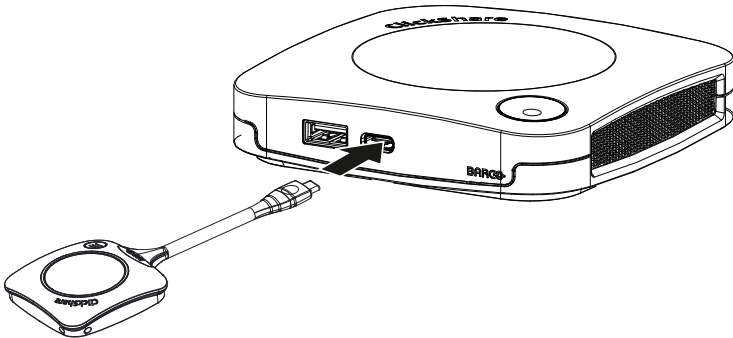

Image 5-1

The Base Unit LED is blinking while the Button LED fills up a circle. This means pairing is in progress.

The Base Unit automatically checks whether the software of the Button is up to date. If not, the Base Unit updates the Button software. This may take more time.

The result of the pairing process can be as follows:

- When the LEDs on the Button become green and on static white on the Base Unit, the Button is paired to the Base Unit. You can unplug the Button from the Base Unit.

2. Unplug the Button from the Base Unit.

The Button is now ready for use. Plug in a button to conference.



Image 5-2

## 5.2 ClickShare Extension Pack

### About

The ClickShare Extension Pack is a collection of tools to upgrade your ClickShare user experience. This Extension Pack contains the ClickShare Launcher service and a driver to enable the Extended Desktop functionality (only on Windows). Both tools will be installed by default. To change the default behavior of the installer, the installer will need to be executed with command line parameters.

The ClickShare Extension Pack can be installed by the end user manually, pre-installed on your company's laptop image or deployed company-wide with SCCM or other tools.

The ClickShare Extension Pack can be used in combination with a Button and/or with the ClickShare desktop app.

The latest extension pack can be downloaded via <http://www.barco.com/en/product/clickshare-extension-pack>

## 5.3 ClickShare Extension Pack installer

### Interactive setup

In this setup, the user runs the installer which will install the ClickShare Extension Pack on his computer after the user accepts the EULA.

After the setup finished, the ClickShare launcher will be started automatically. The Extended desktop driver can only be used after the user reboots his computer.

### Starting the setup

1. Download the ClickShare Extension Pack (download via <http://www.barco.com/en/product/clickshare-extension-pack>).
2. Unzip the downloaded file.
3. Click *ClickShare-Extension-Pack.msi* to start the installation.

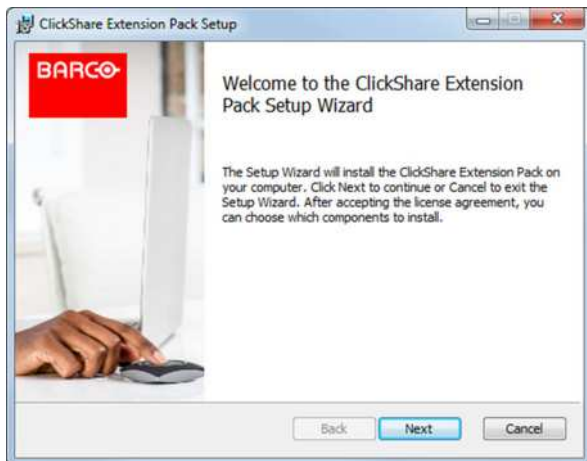

Image 5-3

4. Click **Next**, accept the License Agreement and click **Next** to continue. If necessary, follow the on screen instructions.

### Silent setup

In this setup, a user or an IT admin can install the ClickShare Extension pack using the Windows command prompt. Following is an example of a silent installation (version numbers are only given as example, always check Barco's web for the latest version):

Launcher only install:

```
msiexec. exe /i ClickShare-Extension-Pack-01.00.02.0003. msi ACCEPT_EULA=YES  
INSTALLFOLDER=C:\ LAUNCH_APP=YES /qn
```

Extended desktop only install :

```
msiexec. exe /i ClickShare-Extension-Pack-01.00.02.0003. msi ACCEPT_EULA=YES  
ADDLOCAL=ExtendedDesktopDriverFeature INSTALLFOLDER=C:\ LAUNCH_APP=YES /qn
```

Full install (launcher + extended desktop):

```
msiexec. exe /i ClickShare-Extension-Pack-01.00.02.0003. msi ACCEPT_EULA=YES  
ADDLOCAL=ALL INSTALLFOLDER=C:\ LAUNCH_APP=YES /qn
```



The computer will reboot. This can be suppressed with /norestart. A reboot will be needed afterwards for the extended desktop feature to be working. In case the end-user should decide if they want to reboot, /promptrestart /QB!+ can be used (basic UI, no cancel option, but prompt to reboot)

### Parameter Description

ACCEPT_EULA	This parameter shows that the installer accepts the EULA text as is. This parameters must be set to YES in order to continue to the installation.
INSTALLFOLDER	This parameter specifies the installation directory for ClickShare launcher. If not specified, the default folder will be the Program Files folder.
LAUNCH_APP	The ClickShare launcher application will be started right after the installation finishes if this parameter is set to YES. Otherwise, the launcher application will not be started.
/qn	This parameter indicates that the installation will be done in silent mode, meaning that there will be no visible windows during the installation.
ADDLOCAL	This parameter indicated the type of the installation. No parameter added, installs only the launcher.

### Windows environment variable

The variable to be used is CLICKSHARE\_LAUNCHER\_CLIENT\_PATH. The value should be the path to the client software.

## 5.4 ClickShare Windows Certified driver

### About

The ClickShare Windows Certified driver is auto-installed when plugging in a Button in a Window PC.

This Windows driver automatically launches the executable on the Button.

Note that at least version **1.16.0** is required. In case an older version is installed on your PC, start windows update *check for updates* with a button inserted into your PC.

## 5.5 ClickShare Desktop app

### About the

With the ClickShare desktop app installed on your computer you can enter a meeting room and get on the screen in a few seconds without the need to plug in a Button. The ClickShare app can be used in combination with a Button.

The ClickShare desktop app connects to the meeting room screen in order to share your content. Presence detection technology is used to do so. The ClickShare desktop app uses presence detection technics to determine which meeting room is closest to the user. Just click on your meeting room name. This means you will never have to enter IP addresses or scroll long lists of meeting rooms before being connected to your meeting room.

## Installation

When the ClickShare desktop app is not pre-deployed in your IT environment, you can download and install the software without administrator rights from [www.clickshare.app](http://www.clickshare.app).



# CX-20 Configurator

# 6

6.1	Accessing the Configurator .....	56
6.2	ClickShare Configuration Wizard .....	59
6.3	On-Screen ID information.....	61
6.4	Personalisation, Wallpaper.....	62
6.5	Personalisation, Personalized wallpaper .....	64
6.6	Manage configuration files.....	65
6.7	Display setup, Output.....	66
6.8	Display & Audio setup .....	67
6.9	WiFi settings .....	68
6.10	LAN settings.....	72
6.11	Services, Mobile devices .....	74
6.12	XMS Cloud Integration .....	75
6.13	Services, SNMP .....	76
6.14	Security, security level.....	77
6.15	Security, passwords.....	78
6.16	Status information Base Unit .....	79
6.17	Date & Time setup, manually .....	80
6.18	Date & Time setup, time server .....	81
6.19	Energy savers .....	82
6.20	Buttons .....	83
6.21	Firmware Update .....	84
6.22	Support & Updates, Troubleshoot, log settings.....	85
6.23	Factory defaults.....	86

## About configuration

The configuration of your device can be done in

- XMS cloud
- the local configurator

The configurator in XMS cloud will (in time) more elaborated than the local configurator. Therefore it preferred to configure your devices via XMS cloud. For more info see XMS documentation.

The next topics are describing the local configurator.



Within some menus the *Configurator* is indicated as *WebUI*. E.g. WebUI password, that is the password to enter the Configurator.

## 6.1 Accessing the Configurator

### Getting access to the Configurator

There are three ways to access the Configurator:

- Via the LAN
- Direct Ethernet connection between PC and Base Unit.
- Via the Base Unit's wireless network

When accessing the configurator for the first time, the ClickShare Configuration Wizard starts automatically.

This configuration wizard can be started at any moment to change your configuration instead of using the menus.

### To access the Configurator via the LAN

1. Open a browser.

 *Note:* Supported browsers are Internet Explorer, Firefox, Google Chrome and Safari.

2. Browse to the IP address you can find in the bottom left corner of the startup screen.

 *Note:* The Wired IP address is only visible when the Base Unit is connected to the LAN.

A login screen appears.



Image 6-1: Login screen

3. To change the language of the Configurator, click on the drop down next to the current selected language and select the desired language.





Image 6-2: Configurator languages

The following languages are possible:

- Arabic
- Simplified Chinese
- Traditional Chinese
- Danish
- Dutch
- English
- Finnish
- French
- German
- Italian
- Japanese
- Korean
- Norwegian
- Portuguese
- Russian
- Spanish
- Swedish

The Configurator language changes to the selected language.

4. Enter the user name 'admin' and the password, read and accept the EULA and the Privacy policy and click **OK**.

By default, the password is set to 'admin'.

Warning: It is strongly recommended to change the default password into a strong password on first use, to prevent that anyone else accessing the configurator can change the settings of the ClickShare Base Unit. See section "Security, passwords".

The configurator opens.

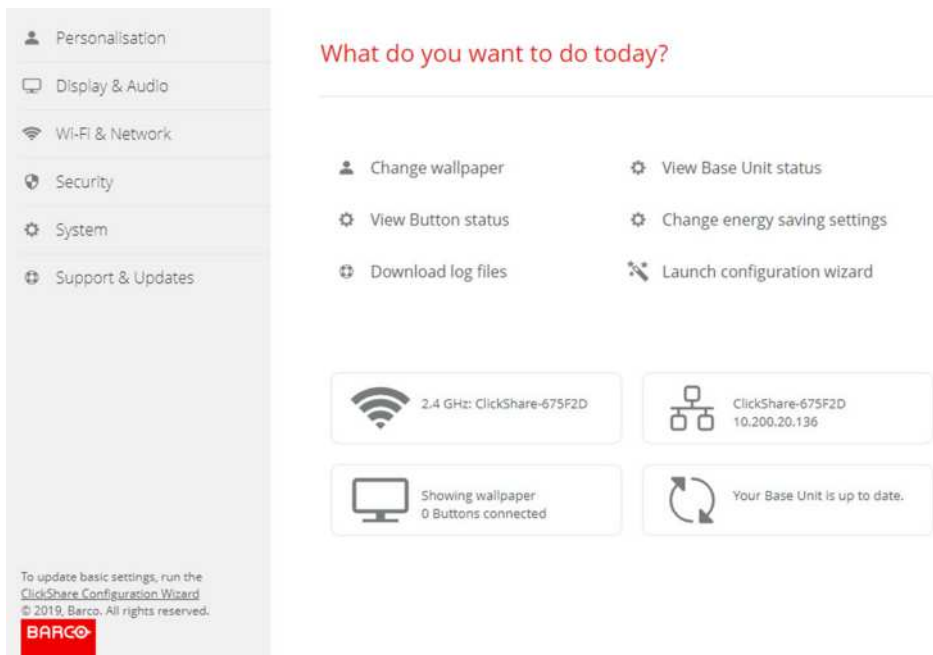

Image 6-3: Start screen

The language of the configurator can be changed on any page in the interface.

The screen is split up in 2 panes. Left pane with the selection buttons and a right pane to configure the selected function.

The startup screen itself shows:

- the wired IP address
- the wireless IP address
- the wireless SSID
- the number of Buttons connected
- the system state



If you cannot find the IP address (e.g. there is no screen available) you should connect to the Base Unit directly with your laptop via an Ethernet crossover cable and access the web interface using the fixed IP address 192.168.1.23. Make sure your own LAN adapter is set in the 192.168.1.x range.

### To access the Configurator via a direct connection.

1. Connect the Base Unit to your laptop using an Ethernet cable.
2. On your laptop, open a browser.
  -  *Note:* Supported browsers are Internet Explorer, Firefox and Safari.
3. Browse to <http://192.168.1.23>.  
A login screen appears.
4. Enter the user name 'admin' and the password, read and accept the EULA and click **OK**.  
By default the password is set to 'admin'.  
The configurator opens.

### To access the Configurator via the Base Unit wireless network

1. On your laptop, connect to the Base Unit wireless network.  
The default SSID and password to connect to the Base Unit are respectively 'ClickShare-<serial base number>' and 'clickshare'.

2. On your laptop, open a browser.
  -  **Note:** Supported browsers are Internet Explorer, Firefox and Safari.
3. Browse to <http://192.168.2.1>.  
A login screen appears.
4. Enter the user name 'admin' and the password, read and accept the EULA and click **OK**.  
By default the password is set to 'admin'.  
The web interface opens.



Older laptops might not support the 5 GHz Frequency Band. If your Base Unit is set to that frequency range, those devices will not be able to connect to the Base Unit via the wireless network.

## 6.2 ClickShare Configuration Wizard

### About the configuration wizard

During the first start up of the Base Unit, the configuration wizard starts up automatically.

All basic settings necessary to configure the Base Unit are covered by the configuration wizard. Once the configuration wizard is finished, the Base Unit is ready to be used.

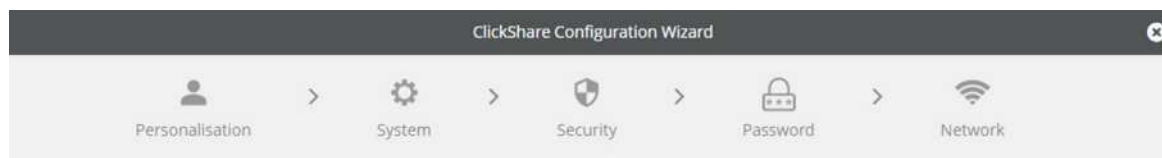

### Welcome to the ClickShare Configuration Wizard

This wizard will guide you through a couple of steps to configure your ClickShare Base Unit. Click "Start configuration" to begin. At any time you can abort the wizard by clicking the close button.



Image 6-4: Configuration wizard

To start the wizard, click on **Start Configuration**.

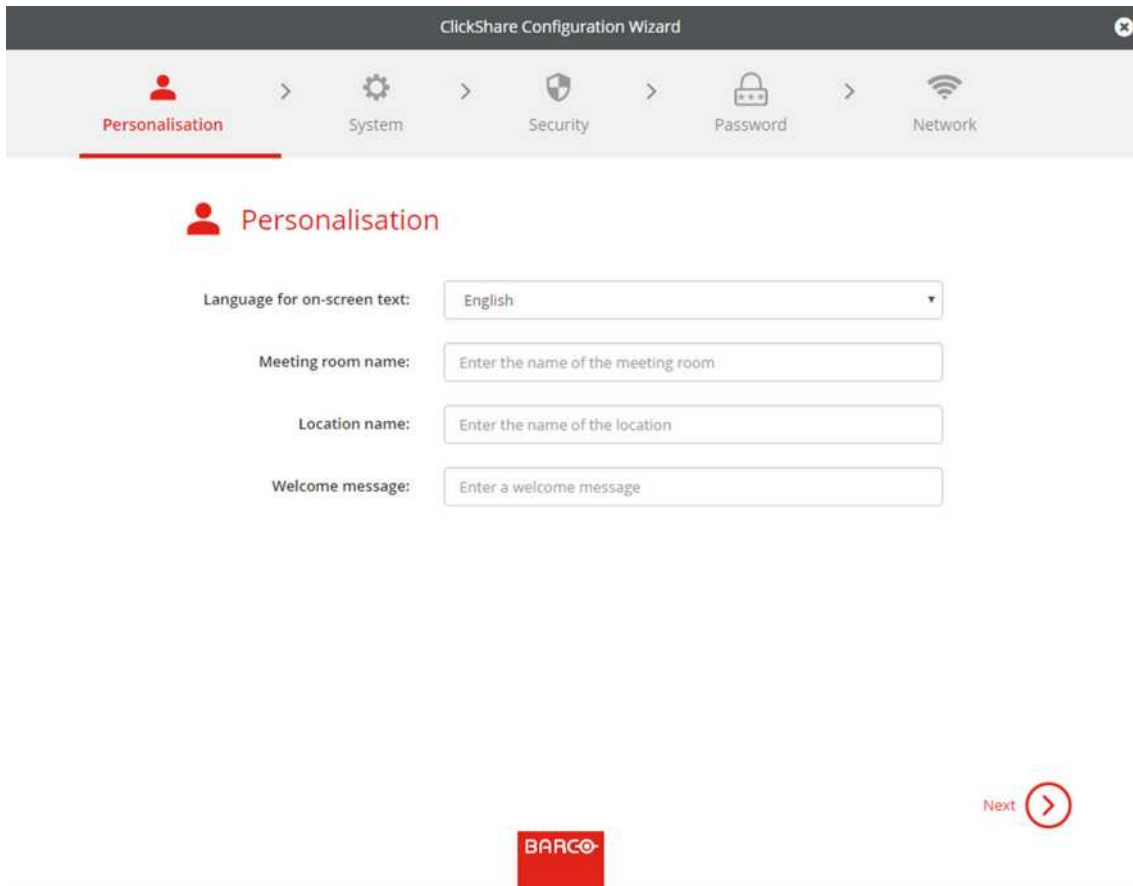

Image 6-5: Configuration wizard, Personalisation

Fill out the necessary field and click **Next** to continue.

To return to the previous step, click on **Back**.

For more information about a specific topic, see one of the following topics.

The ClickShare Configuration Wizard can be started at any time to change the configuration just by clicking on **ClickShare Configuration Wizard** at the left bottom of each screen.

Personalisation	Language on-screen text	See “On-Screen ID information”, page 61.
	Meeting room name, location name and welcome message	See “On-Screen ID information”, page 61.
System	Time zone, manual time setup	See “Date & Time setup, manually”, page 80.
	Use NTP	See “Date & Time setup, time server”, page 81.
Security	Level settings	See “Security, security level”, page 77.
Password	ClickShare Configurator (WebUI) password	See “”, .
Network	Frequency band, channel Wi-Fi passphrase	See “”, .

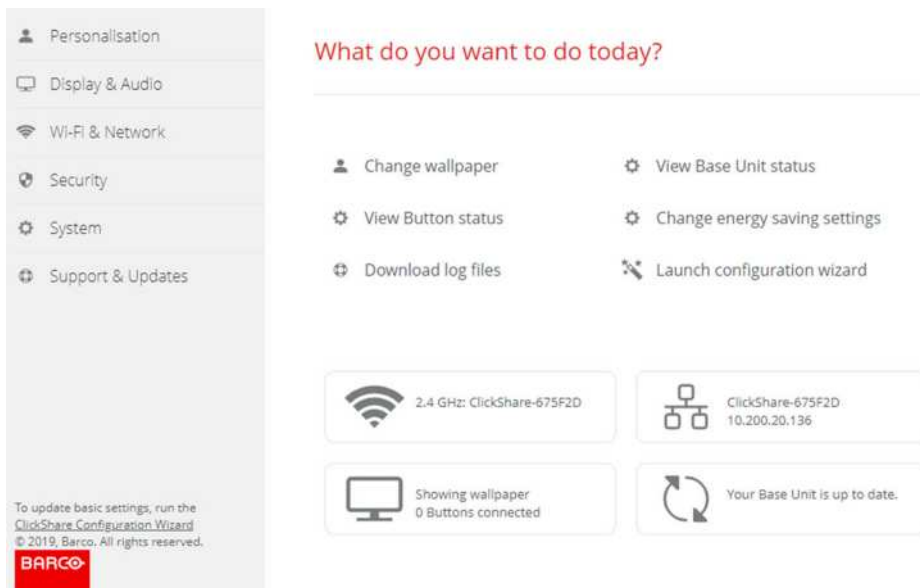

Image 6-6: Configuration Wizard start

## 6.3 On-Screen ID information

### About device identification

The following items can be set:

- On-Screen language. Independent from the Configurator language.
- Meeting room name
- Location of the meeting room
- Welcome message to be displayed in the meeting room
- Show the network information
  - Checked: LAN information such as wired IP address, hostname are displayed. Also the Wi-Fi IP address and SSID are displayed.
  - Not checked: no LAN nor Wi-Fi information is displayed (default setup)

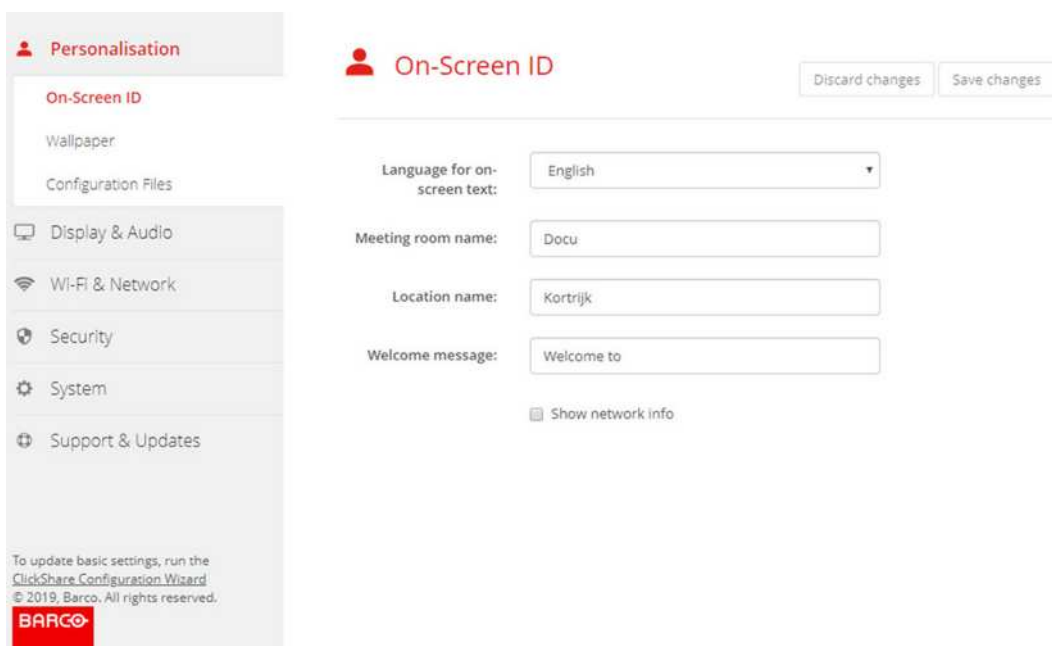

Image 6-7: On-Screen ID

## On Screen language selection

1. Log in to the Configurator.
2. Click *Personalisation* → *On-screen ID*.
3. Select the language of the on-screen text. Click on the drop down box next to *Language for on-screen text* and select the desired language.

The following languages are possible:

- Arabic
- Simplified Chinese
- Traditional Chinese
- Danish
- Dutch
- English
- Finnish
- French
- German
- Italian
- Japanese
- Korean
- Norwegian
- Portuguese
- Russian
- Spanish
- Swedish

## Meeting room name, location and welcome message

1. Log in to the Configurator.
2. Click *Personalisation* → *On-screen ID*.
3. Click in the input field next to *Meeting room name* and enter a name for the meeting room.  
This text is shown on the user's device when the Button is ready to share ("Ready to share on..."), on the central screen connected to the Base Unit and in the list of AirPlay receivers on the user's iOS device.
4. Click in the input field next to *Location name* and enter the location.
5. Click in the input field next to *Welcome message* and enter the desired message.

# 6.4 Personalisation, Wallpaper

## About wallpaper

When CX-20 starts up, a background (wallpaper) is displayed. The display of this background wallpaper can be disabled.

By default two general ClickShare wallpapers are available. The possibility exists to upload personal backgrounds (wallpapers). The default wallpapers cannot be removed from the system.

## Wallpaper selection

1. Log in to the Configurator
2. Click *Personalisation* → *Wallpaper*.

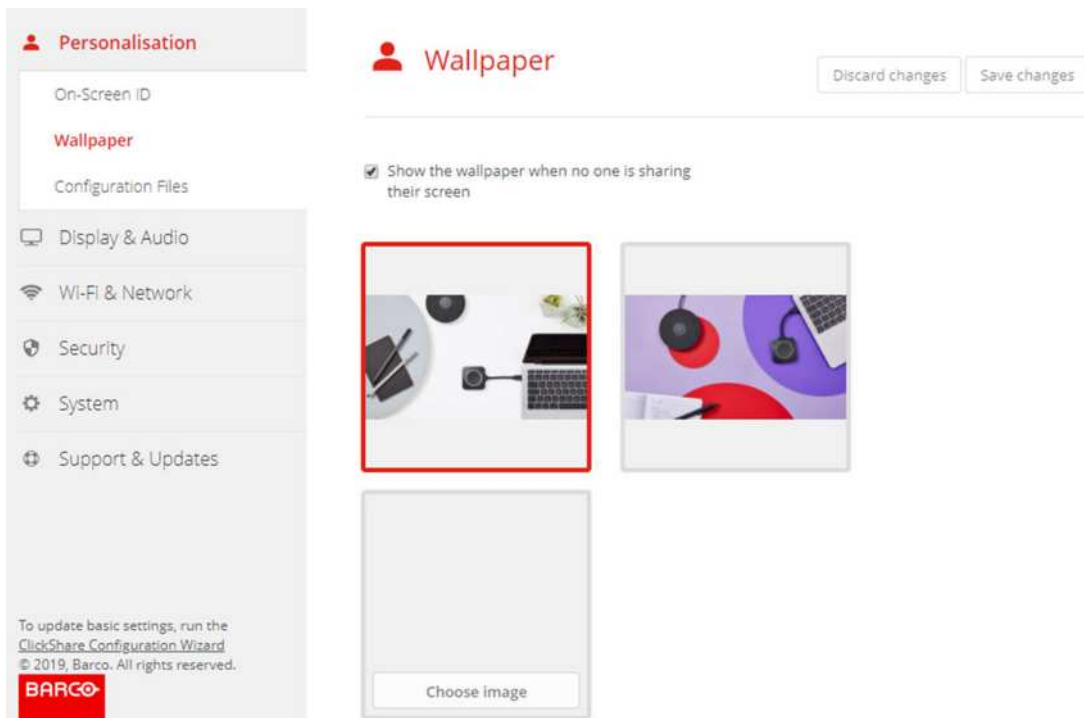

Image 6-8: Wallpaper selection

The *Wallpaper* selection pane is shown. The current selected wallpaper is shown with a red border.

3. Select one of the available wallpapers and click on **Save Changes**.
  - Note:** By default two general Barco wallpapers are available. They are automatically resized to fit the aspect ratio of the screen.

The selected wallpaper is indicated with a red border.

The message **Successfully applied changes** appears on top of the wallpaper selection window.



You can also add a personal wallpaper, e.g. your company logo. For more information on adding a new wallpaper to the list, see "*Personalisation, Personalized wallpaper*", page 64.

## Download wallpaper

1. Hover with your mouse over the wallpaper to download and click on the download symbol on the upper right corner.



Image 6-9: Download wallpaper

The wallpaper is downloaded to your PC.

## Enable - disable Wallpaper

1. Within the Wallpaper pane, check the check box next to *Show the wallpaper when no one is sharing their screen*.

Checked: wallpaper will be displayed when no one is sharing content.

Not checked: no wallpaper will be displayed when no one is sharing content. The video output of the Base Unit is disabled when no content is shared. This feature is especially useful when the Base Unit is integrated in a larger AK system

## 6.5 Personalisation, Personalized wallpaper

### How to upload

1. Log in to the Configurator

2. Click *Personalisation* → *Wallpaper*.

The *Wallpaper* selection pane is shown. The current selected wallpaper is shown with a red border.

3. Hover your mouse over the free place and click on **Choose image**.

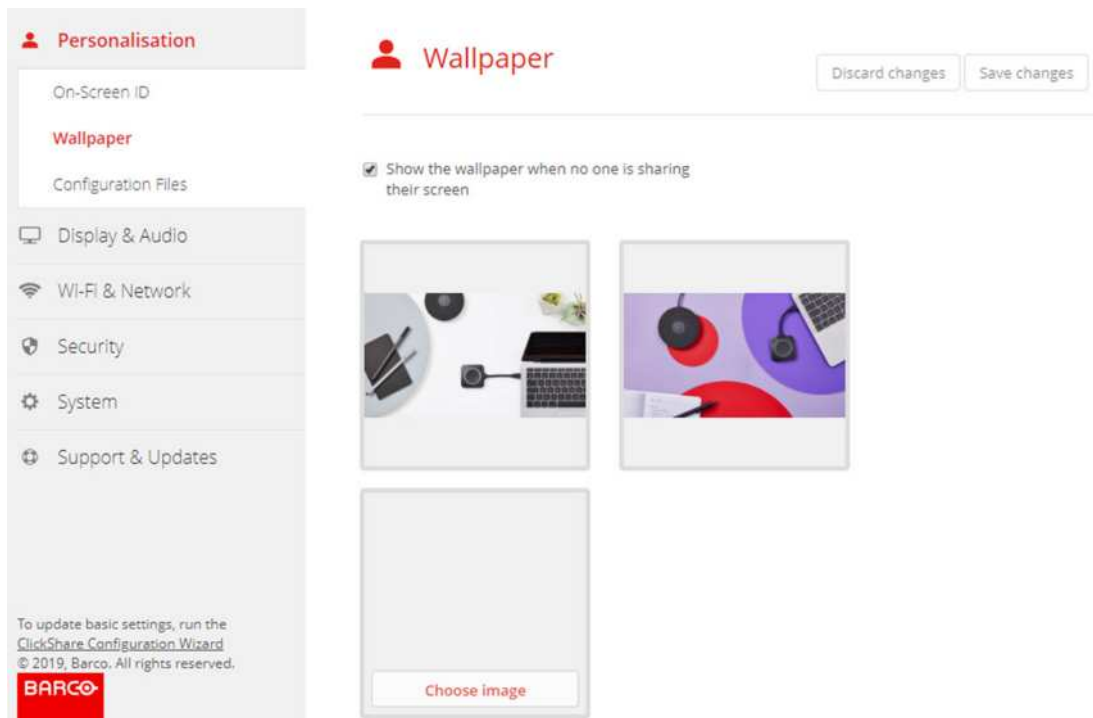

Image 6-10: Personalized wallpaper selection

A browser window opens.

4. Browse for the desired image, click Open to load the image.

The content of the file is checked and when valid (format and size), the file is uploaded. The new wallpaper gets a red border.

5. Click on **Save changes** to apply the personalized wallpaper

The message **Successfully applied changes** is displayed on top of the page.

### Change personalized image

1. Click *Personalisation* → *Wallpaper*.

2. Hover your mouse over the current personalized image and click **Change image**.



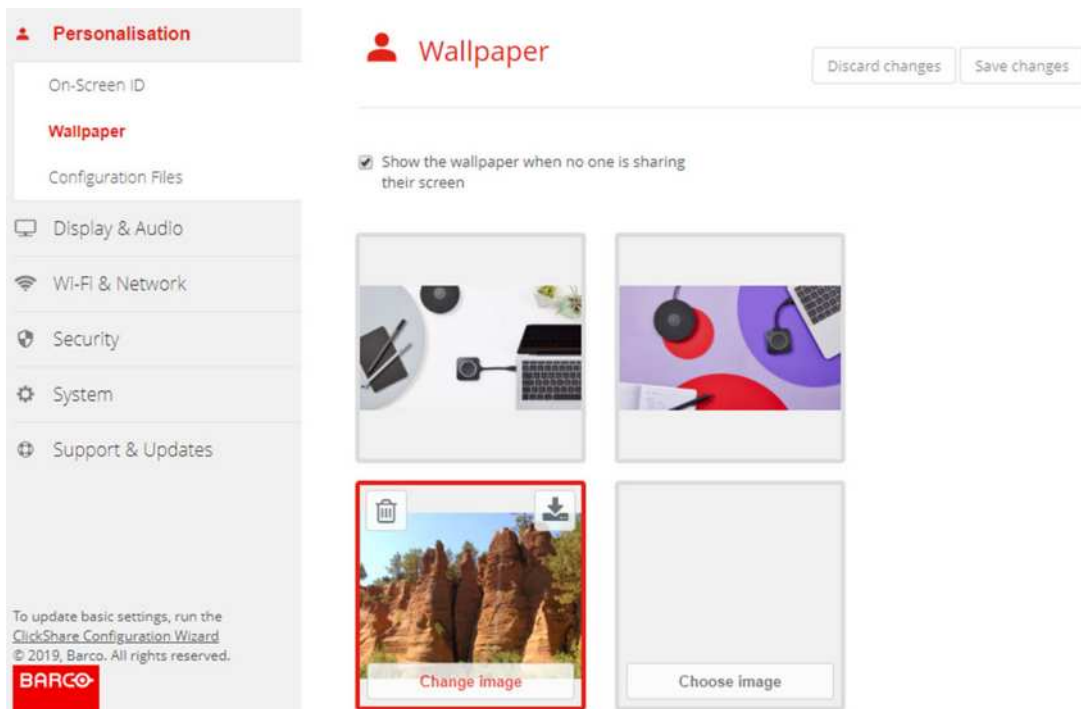

Image 6-11: Change image

- Browse for the desired image, click Open to load the image.  
The content of the file is checked and when valid (format and size), the file is uploaded. The new wallpaper gets a red border.
- Click on **Save changes** to apply the personalized wallpaper and replace the previous file.  
The message **Successfully applied changes** is displayed on top of the page.

### Remove personalized wallpaper

- Hover your mouse over the current image and click on the trash bin to remove the image.



Image 6-12: Remove wallpaper

The personalized wallpaper is removed and the default wall paper is activated.

## 6.6 Manage configuration files

### About Manage configuration files

A full backup can be downloaded but cannot be used to duplicate configuration settings to other Base units. Therefore, it is possible to download a Portable version. This portable version can be uploaded via the upload configuration button on other Base units (same type). Via the same button, the full backup can be uploaded on the original Base Unit.

A portable backup contains:

- Wallpapers
- Wallpapers settings
- Logging settings

- All display settings
- OSD language
- Location
- Welcome message
- WiFi channel
- WiFi frequency

## To manage the configuration files

1. Log in to the *Configurator*.
2. Click *Personalisation* → *Configuration Files*.

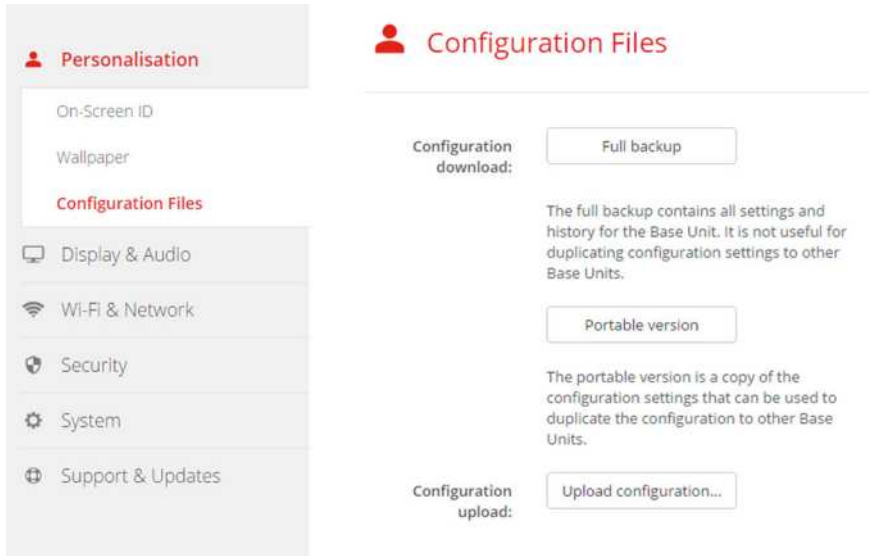

Image 6-13: Configuration files

3. To download a full backup, click on **Full Backup**.

An xml file, containing all information and history will be downloaded. This file can be reused on the same Base Unit only.

4. To download a portable version, click on **Portable Version**.

An xml file, containing portable information to duplicate settings on another Base Unit.

5. To upload a configuration, click on **Upload Configuration**.

A browser window opens. Navigate to the upload file (xml file) and click **Open** to upload.

A full backup can be uploaded on the Base Unit where the backup was created and a portable version can be uploaded on any other Base Unit of the same model.



When uploading a config file, the history of software updates and paired Buttons is lost. Paired buttons will however remain functional if the Base Unit has not changed from SSID or wireless password.

## 6.7 Display setup, Output

### Resolution

The output resolution to the display is set on Auto. That means that the CX-20 output resolution is automatically adapted to the resolution of the display. For HDMI displays, a hot plug detection is available.

### HDMI hot plug display detection

The HDMI hot plug display detection can be enabled by checking the check box before *HDMI Hot-Plug display detection*.

## CEC

Consumer Electronics Control (CEC) is a feature of HDMI designed to allow users to command and control devices connected through HDMI by using only one remote control.

To enable CEC, check the check box before *Enable CEC*.

## Screen saver setup

1. Log in to the *Configurator*.
2. Click *Display & Audio* → *Outputs*.

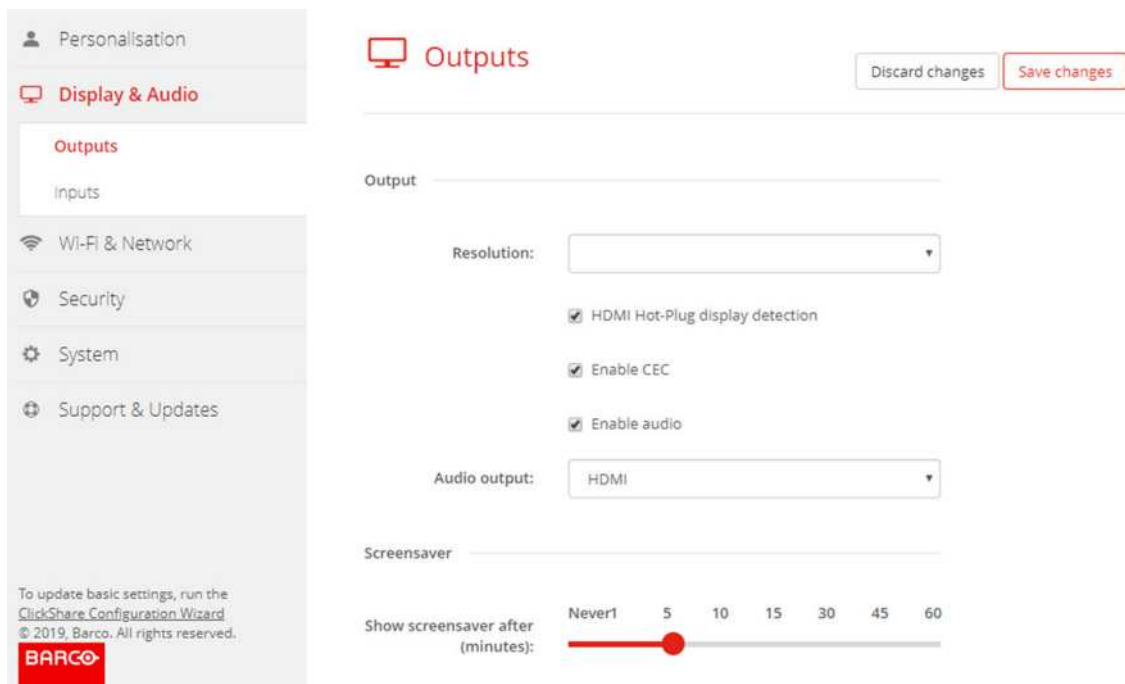

Image 6-14: Display settings

3. To activate the screen saver, drag the slider bar to the left or to the right until the desired delay time is reached. When the slider is set completely to the left, the screen saver will never be activated.

## 6.8 Display & Audio setup

### Resolution

The output resolution to the display is set on Auto. That means that the CX-20 output resolution is automatically adapted to the resolution of the display. For HDMI displays, a hot plug detection is available.

### HDMI hot plug display detection

The HDMI hot plug display detection can be enabled by checking the check box before *HDMI Hot-Plug display detection*.

## CEC

Consumer Electronics Control (CEC) is a feature of HDMI designed to allow users to command and control devices connected through HDMI by using only one remote control.

To enable CEC, check the check box before *Enable CEC*.

## Audio

Enable or disable audio output.

Check the check box in front of *Enable audio* to enable audio output.

## Screen saver setup

1. Log in to the *Configurator*.

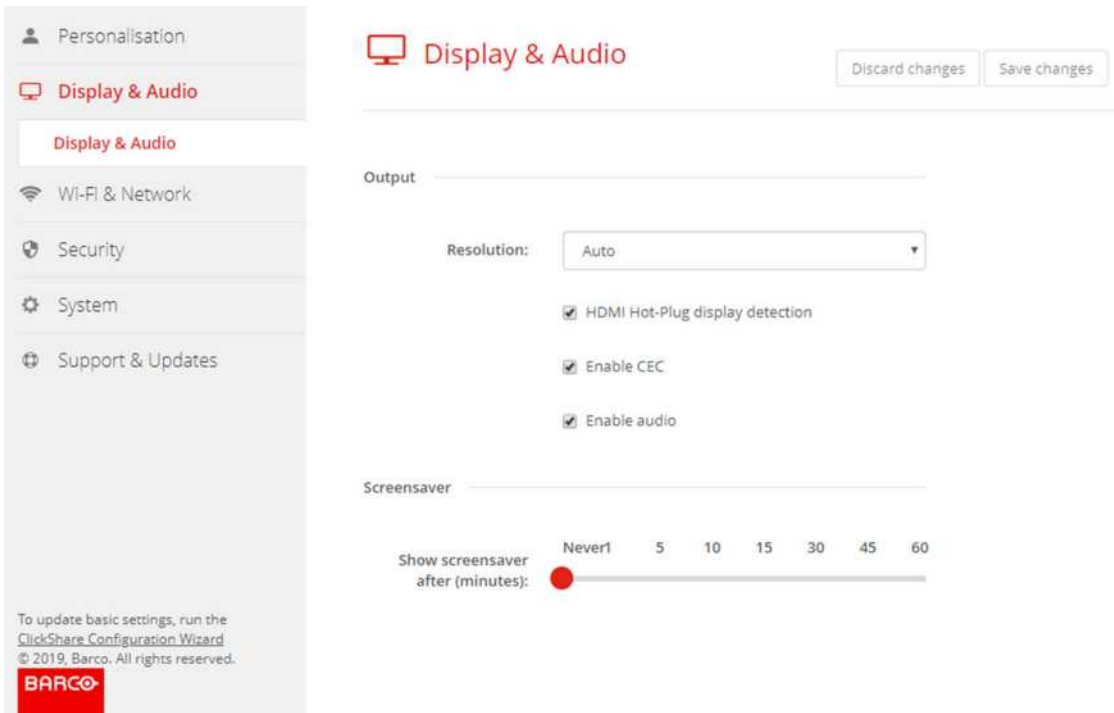

Image 6-15

2. Click *Display & Audio* → *Display & Audio*.
3. To activate the screen saver, drag the slider bar to the left or to the right until the desired delay time is reached. When the slider is set completely to the left, the screen saver will never be activated.
4. Click **Save changes**.

## 6.9 WiFi settings



**WARNING:** It is not allowed to operate the Base Unit outside its intended geographical region.

### About WiFi

A connection with the Base Unit can be made via a wireless connection. A fixed wireless IP address is used to establish the connection.

The transmission power of the wireless signal can be reduced.

An overview of the current settings is given when *Wi-Fi Settings* is selected and operational mode is *Access Point*.

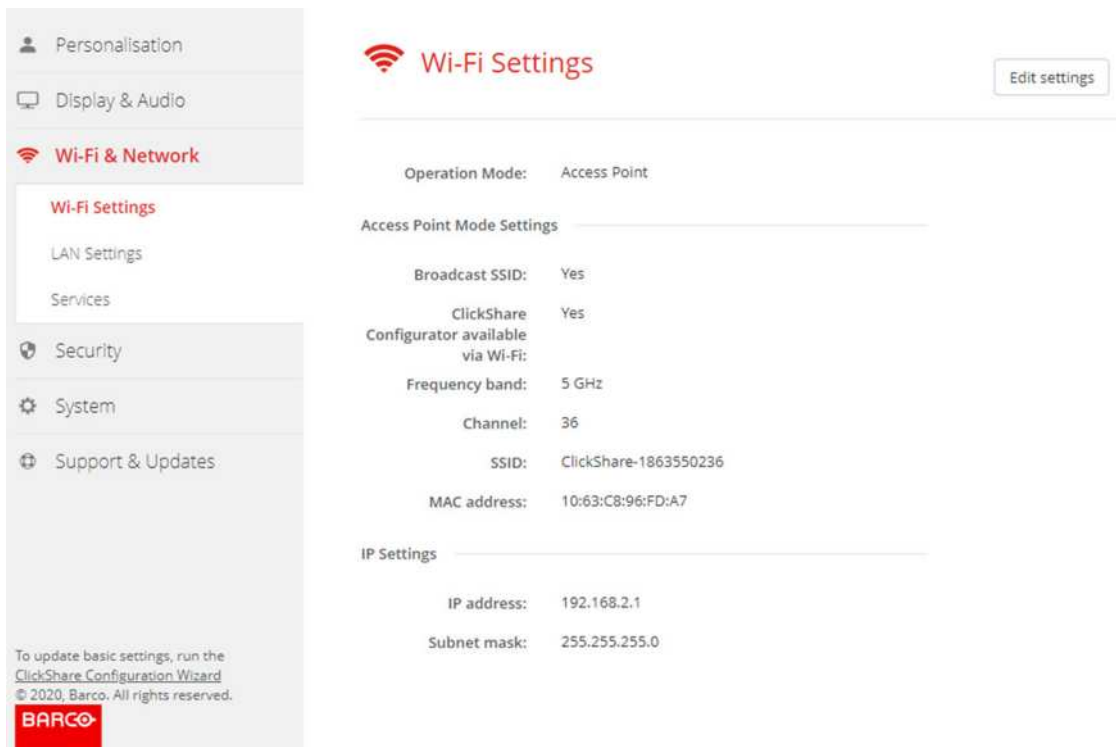

Image 6-16: WiFi settings

When operational mode is set to *Off*. The following info is given: “When disabling the access point, the Buttons will need to be integrated in the corporate network. This is not supported yet.”.

Click on *here* to start the button configuration. For more info, see “*Buttons*”, page 83.

To change any WiFi-setting, click on **Edit settings**. The view depends on the previous selected operational mode. Here given with Access Point selected.

Image 6-17: WiFi settings, edit



Changing the IP address will require a repairing of the Buttons used with this Base Unit.

## Change operational mode

1. Log in to the *Configurator*.
2. Click *Wi-Fi & Network* → *WiFi Settings*.
3. Click **Edit settings**.
4. Click on the drop down box next to *Operational Mode* and select the desired mode.

The following options are possible:

- Access Point: continue with the next blocks in this topic.
- Off

## About frequency band & channel selection

In an ideal setup, overlapping channels should not be used for two ClickShare Base Units within range of each other. As the channels in the 2.4 GHz band overlap with each other, best practice is to use channels 1, 6 and 11 on a single floor. On floors above and below, the channel pattern will be shifted to avoid overlap between floors, e.g. by placing channel 6 at the center of the illustrated pattern.

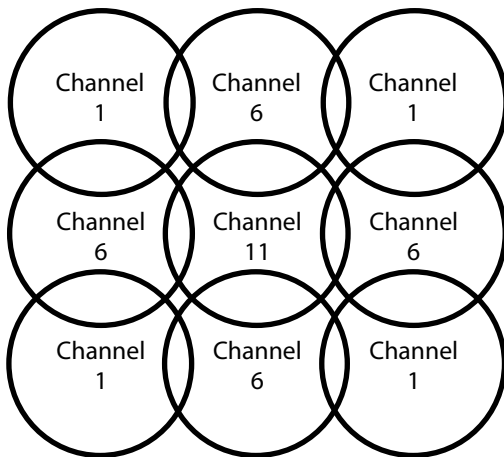

Image 6-18

To limit the effect of overlapping networks, it is highly recommended to reduce the signal strength (standard range of about 30m) of the ClickShare Base Units. Reducing the signal strength to its minimal value will reduce the actual range of the ClickShare to about 10m. By doing so, the size of coverage overlapping area will shrink and the risk for quality degradation will decrease or even disappear.

The 5 GHz channels do not overlap with each other and are less used by non-Wi-Fi devices than the 2.4 GHz channels. Moreover, 5 GHz signals are more rapidly damped than 2.4 GHz signals. Therefore, the use of a 5 GHz channel is recommended. This will limit the impact of a ClickShare system on other installed ClickShare units and on other WLAN users.

## Frequency band & channel selection

1. Select the wireless connection channel by clicking on the drop down box and selecting the desired channel.

The channels available in the list vary according to the regional version of your Base Unit. Re-pairing the Buttons is not required when changing the frequency band or wireless connection channel.

Ideally, the ClickShare channel is selected after conducting a wireless site survey. A site survey maps out the sources of interference and the active RF systems. There are several Wi-Fi survey tools available on the market. Based on the results from a site survey, the least occupied channel can be found and selected for each meeting room.

2. Select the wireless connection frequency band: 2.4 GHz or 5 GHz by clicking on the drop down box and selecting the correct band.

Below the channel selection pane, an indication is given of the available bandwidth of the current channel. To see if sufficient bandwidth is available in a different channel, select the channel in the drop down and save the changes. The page will reload with the new settings and an indication of the channel fit will be given after approximately 1 minute. There is no need to reload the page to see the result.

The channels available in the list vary according to the regional version of your Base Unit. Re-pairing the Buttons is not required when changing the frequency band or wireless connection channel.

When Intense use, change to another Wi-Fi channel is displayed, change to another channel. The page will reload after approximately 1 minute.

## SSID & passphrase

1. Enter a public name (SSID) for the wireless network.  
The default SSID is *ClickShare-<serial number Base Unit>*.
2. If you want to broadcast this SSID, check the checkbox before *Enable SSID broadcast*.
3. Enter a new WiFi passphrase and confirm that passphrase.



**CAUTION:** It is strongly recommended to change the Wi-Fi passphrase on first use to prevent anyone else accessing the Wi-Fi network.

## Signal strength

1. Select the Signal Strength. Click on the slider and reduce the broadcasted power (signal strength) until the desired strength is obtained.
  -  **Note:** Too low power and interference by others might lead to connection issues. If so, increase again the signal strength until the issues are solved.

By default the strength is set to 100%.

Reducing the signal strength limits the effect of overlapping networks in the 2.4 GHz channels. Not necessary for the 5 GHz channels as their is no overlap.

## ClickShare Configurator (WebUI) access via Wi-Fi

1. To allow access to the configurator via Wi-Fi, check the check box in front of *WebUI available via Wi-Fi*.  
Checked: Configurator accessible via Wi-Fi.  
Not checked: access to the configurator via Wi-Fi is blocked.

## IP address & subnet mask

1. Log in to the *Configurator*.
2. Click *Wi-Fi & Network* → *WiFi Settings*.
3. To change the IP address or subnet mask, click in the input field and enter the 4 octets of the new IP address or subnet mask.
  -  **Note:** This must NOT be 0.0.0.0 for static IP-Address assignment.

# 6.10 LAN settings

## About LAN network settings

A network connection can be configured through DHCP or by manually entering a fixed IP address.



### DHCP

Dynamic host configuration protocol. DHCP is a communications protocol that lets network administrators manage centrally and automate the assignment of IP addresses in an organization's network. Using the Internet Protocol, each machine that can connect to the Internet needs a unique IP address. When an organization sets up its computer users with a connection to the Internet, an IP address must be assigned to each machine. Without DHCP, the IP address must be entered manually at each computer and, if computers move to another location in another part of the network, a new IP address must be entered. DHCP lets a network administrator supervise and distribute IP addresses from a central point and automatically sends a new IP address when a computer is plugged into a different place in the network.

## Hostname & method

1. Log in to the *Configurator*.
2. Click *Wi-Fi & Network* → *LAN Settings*.



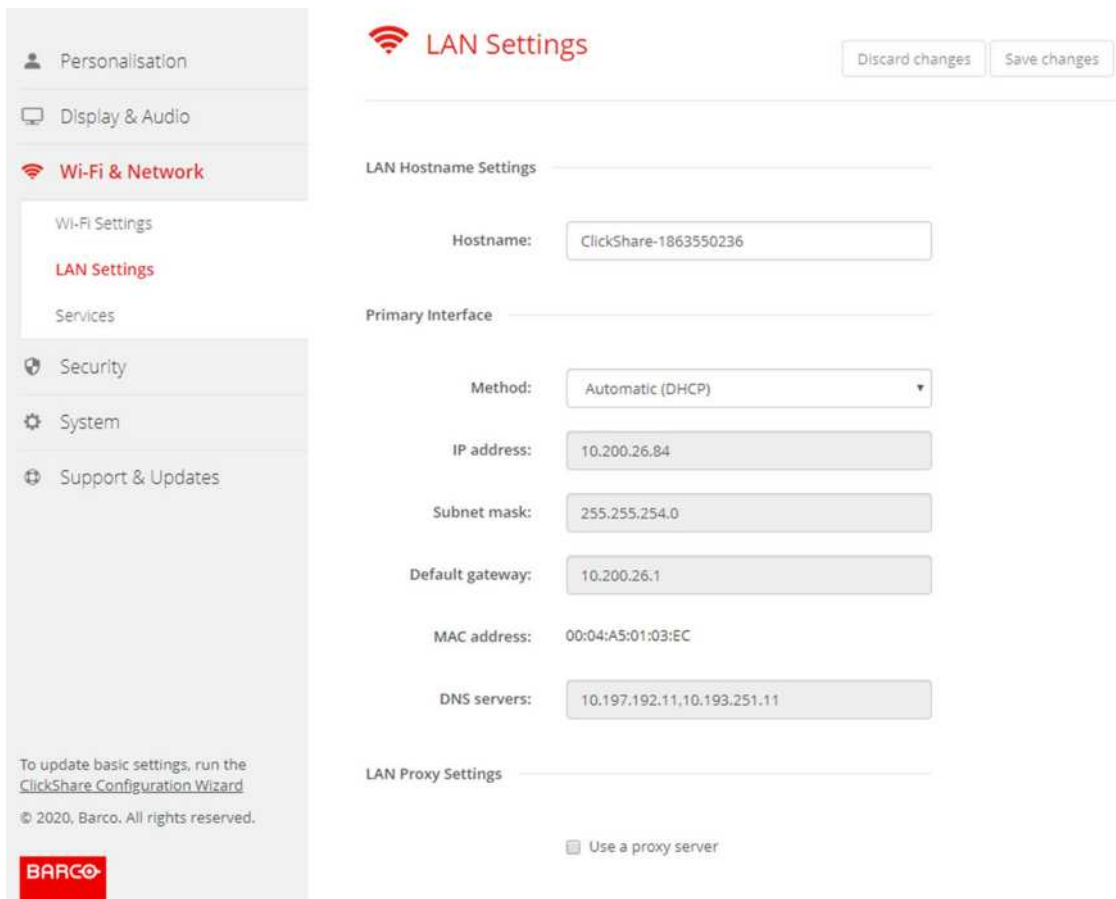



Image 6-19: LAN settings

3. Click in the input field next to *Hostname* and enter a host name for the Base Unit.  
The default host name is *ClickShare- $\langle$ serial number Base Unit $\rangle$* .
4. To select the method, click on the drop down box next to *Method* and select the *Automatic (DHCP)* or *Manual*.  
When *Automatic (DHCP)* is selected, the IP address, subnet mask and default gateway fields are grayed out but the currently used settings are filled out.
5. Click **Save changes** to apply the settings.

### Manual (fixed) IP address

1. Click on the drop down box next to *Method* and select *Manual*.  
The IP address, subnet and gateway input fields are activated.
2. Click in the input field of the *IP address* and fill out the 4 octets.
  -  *Note:* An address contains 4 octets with a maximum value of 255.  
This must NOT be 0.0.0.0 for static IP-Address assignment
3. Click in the *Subnet mask* input fields and fill out the 4 octets as appropriate for the local subnet.
4. Click in the *Default Gateway* input fields and fill out the 4 octets. Set the Default-Gateway to the IP-Address of the router (MUST be on the local subnet!).
  -  *Note:* This must NOT be 0.0.0.0.  
If there is no router on the local subnet then just set this field to any IP-Address on the subnet.
5. Click in the DNS Servers input field and fill out the preferred DNS servers (maximum 5) in a comma separated list.
6. Click **Save changes** to apply the settings.



Do not use IP address 192.168.2.x for a Subnet mask 255.255.255.0 and IP address 192.168.x.x for a Subnet mask 255.255.0.0

## Use a proxy server

This setting is important for the auto-update feature of the Base Unit, which require internet access.

1. Check the check box next to Use a proxy server.

Use a proxy server

Server address:

Server port (optional):

User name (optional):

Password (optional):

Image 6-20: Proxy settings

The proxy settings become available.

2. Enter the proxy server address. Enter the IP address or hostname.  
Some proxy servers need a port number, user name and password, for others is this optional.
3. Optionally, enter the used server port.
4. Optionally, enter the user name.
5. Optionally, enter the password.
6. Click **Save changes** to apply the settings.

## 6.11 Services, Mobile devices

### ClickShare app

The ClickShare app is enabled by default and makes it possible to connect with a mobile device to the Base Unit.

### Passcode type selection

1. Log in to the *Configurator*.
2. Click *WiFi & Network* → *Services*.

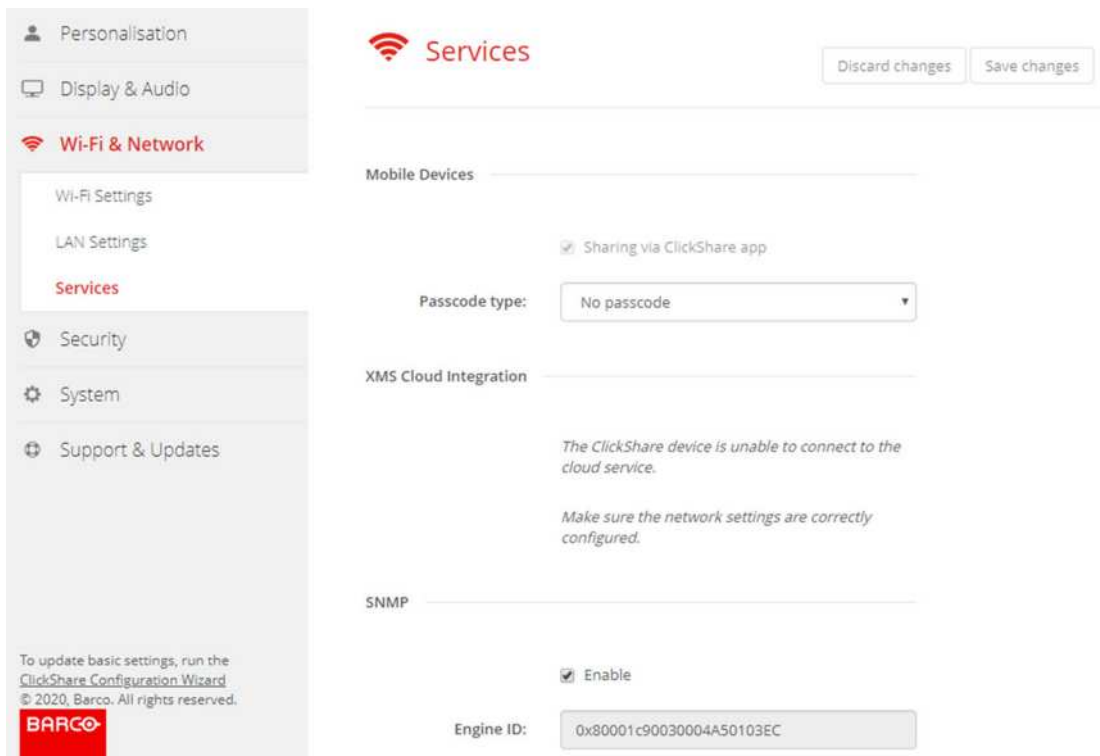

Image 6-21: Services, mobile devices

3. Click on the drop down box and select the desired passcode type.
  - No passcode
  - Numeric passcode

## 6.12 XMS Cloud Integration

### Overview

When your device is not registered and connected to the cloud service, the following message will be displayed: *The ClickShare device is unable to connect to the cloud service. Make sure the network settings are correctly configured.*

When your device is correctly registered, the following message is displayed: *The ClickShare device has been successfully registered;*

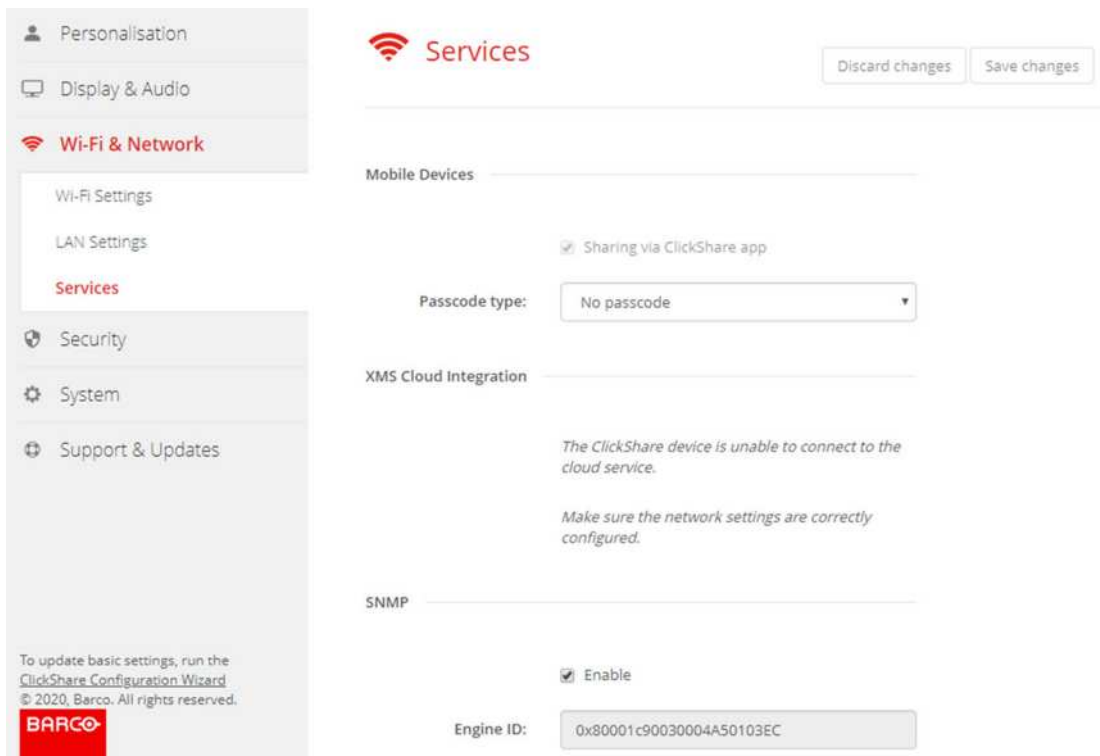

Image 6-22: Services, XMS cloud

## What can be done?

1. Check your network settings or register your device to XMS Cloud.  
Follow procedure as described in “Registration to XMS Cloud”, page 40.

## 6.13 Services, SNMP

### About SNMP

Simple Network Management Protocol (SNMP) is an internet standard protocol for collecting and organizing information about managed devices on IP networks and for modifying that information to change device behaviour. In general a SNMP management suite (running on a server) communicates with an SNMP agent (running on the device). The SNMP agent collects and exposes device information in the form of variables according a MIB (Management Information Base). SNMP management suites will be able to approach ClickShare devices via SNMP protocol for requesting device information.

SNMPv3 is supported.

### How to enable

1. Log in to the *Configurator*.
2. Click *WiFi & Network* → *Services*.
3. Scroll to *SNMP*.

SNMP

Enable

Engine ID:

Use default Engine ID

SNMP Manager:

Username:

New password:

Confirm password:

Image 6-23: Service, SNMP

4. Check the check box in front of *Enable*.  
The configuration fields become available.

## How to configure

1. When using the default *Engine ID*, make sure the check box before *Use default Engine ID* is checked.  
The default engine ID is a combination of the Barco Enterprise Number with the MAC-address (eth0).
2. Fill out the *SNMP Manager* address.  
That is the host address which will receive the TRAP events/messages.  
Possible traps can be:
  - Alarm CPU temperature trap which indicates that CPU temperature exceeds the threshold.
  - Alarm Case Fan Speed trap which indicates the case fan is spinning too slow.
  - Alarm Process Not Running trap which indicates one of the monitored processes is not running.
3. Enter the *Username*.
4. Enter a new password and confirm that password.

## 6.14 Security, security level

### About security levels

For the use of the ClickShare system, a security level can be set. By default, level 1 is activated. A security level is a predefined set of settings which are automatically set when a level is selected.

**Level 1** : offers support for normal day-to-day operations in any organization.

Level 1 contains the standard security options and encryption of audio and video data.

The standard security options are:

- PIN code activation for mobile apps and Buttons,
- ClickShare Configurator (WebUI) access via HTTPS with login management,
- no wireless ClickShare Configurator (WebUI) access,
- SSID of Wi-Fi network is hidden.

**Level 2** : this level offers a higher degree of security, fit for organizations that are more sensitive to security matters.

Level 2 contains the level 1 security and a mandatory PIN code for mobile devices. Alphanumeric PIN codes for mobile apps and Buttons and the Buttons require a certificate for pairing.

**Level 3** : this level is used for organizations that have extremely strict requirements with regards to security.

Level 3 contains the level 2 security extended with blocking of mobile apps, downgrading firmware not possible and no wireless access to the Configurator (WebUI).

When a security level is set, the individual items included in that security level can be changed using the individual item in the Configurator. When changing an individual item the security level indication will be adapted accordingly, but no other settings will be changed automatically.

E.g. when level 3 is set and you change mobile app blocking to allowed, then the security level indication will change to level 2. But all other items initially in level 3 remains in the level 3 state.



To reset your individual changes, select the desired security level and click **Save changes**.



Changing the security level will require a re-pairing of the Buttons.  
Changing the security level from 1 to a higher level will change the compatibility setting for Buttons with certificate (R9861006D01). They cannot re-pair as long as the security setting is higher than level 1.

## How to set the security level

1. Log in to the *Configurator*.
2. Click *Security* → *Security Level*.

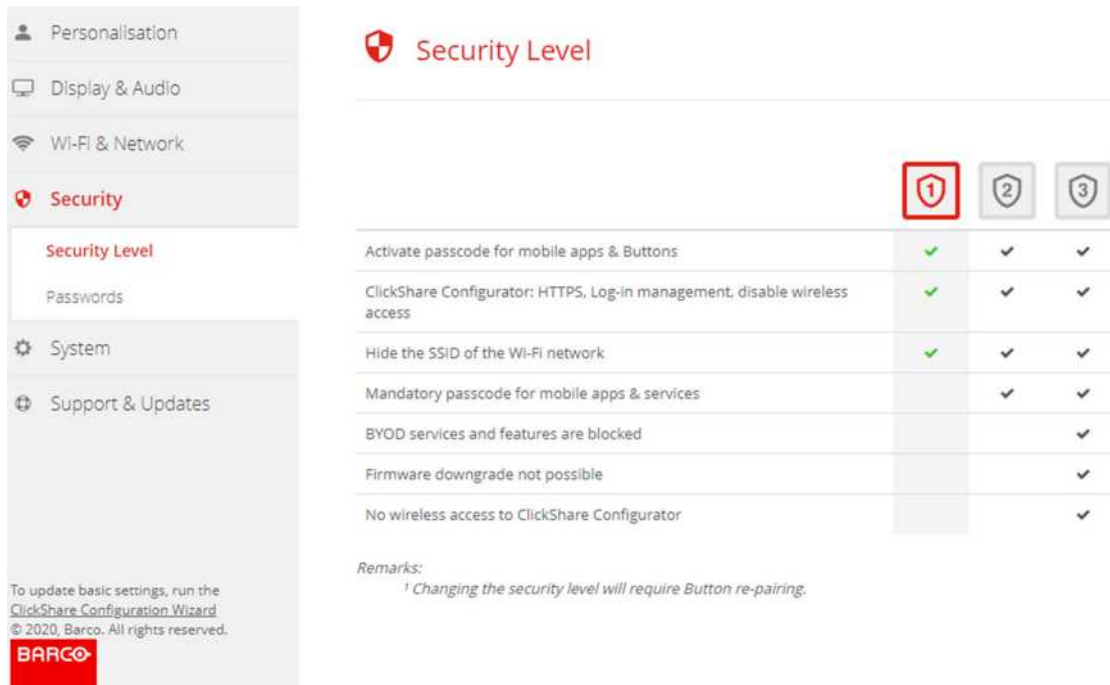

Image 6-24: Security levels

3. Select the desired security level icon.
4. Click **Save changes** to apply the setting.

## 6.15 Security, passwords

### About passwords

To access the ClickShare Configurator a user name and password is needed. That password can be changed at any time to protect the *ClickShare Configuration* settings.

### Changing the ClickShare Configurator password

1. Log in to the *Configurator*.
2. Click *Security* → *Passwords*.

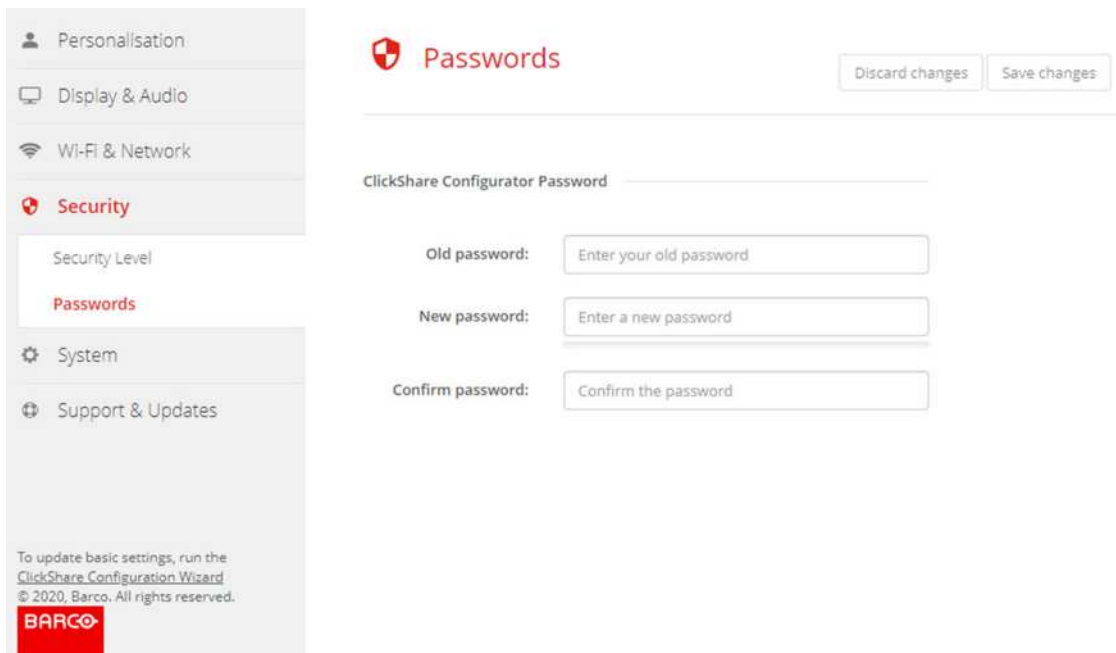

Image 6-25: Passwords

3. Click in the *WebUI Password* (configuration password) pane in the input field next to *Old password* and enter the old password.
4. Click in the input field next to *New password* and enter a new password.
5. Click in the input field next to *Confirm password* and enter the new password again.
6. Click **Save changes** to apply.

## 6.16 Status information Base Unit

### Status information

The following information can be found:

- Model information, name and part number
- Serial number
- Firmware version
- First used
- Last used
- Current uptime: time since last startup
- Lifetime uptime: time used since first startup
- Overall status

### Base Unit restart

1. Log in to the *Configurator*.
2. Click *Support* → *Base Unit Status*.

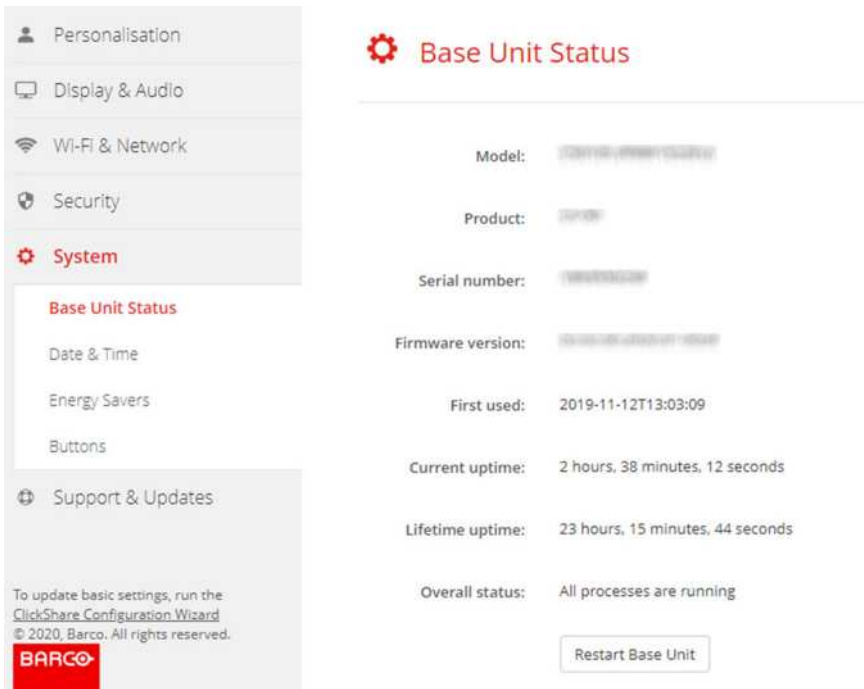

Image 6-26

3. To restart the Base Unit, click on **Restart Base Unit**.  
A ClickShare system reboot message with progress bar is displayed while rebooting takes place. When the reboot is finished, a re-login is necessary.

## 6.17 Date & Time setup, manually

### About Date & Time setup

The date and time can be set manually using the time zone indication or using at least one NTP servers.

### How to setup

1. Log in to the *Configurator*.
2. Click *System* → *Date & Time*.

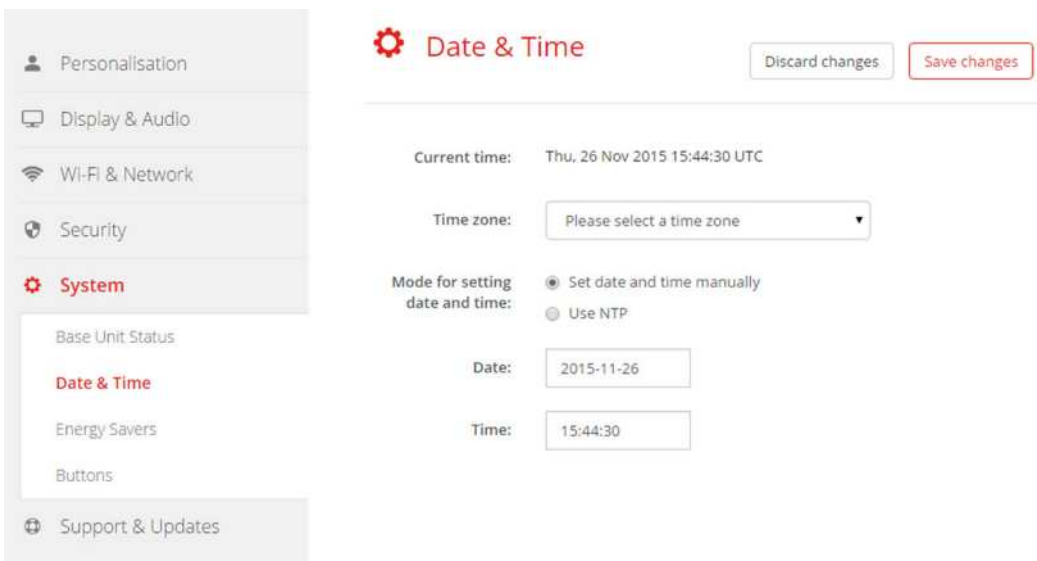

Image 6-27: Manual time & date update



The current time is indicated next to *Current time*.

3. Select your time zone. Click on the drop down box next to *Time zone* and select the corresponding time zone.
4. Check the radio button in front of *Set time and date manually*.
5. To change the date, click in the input field next to *Date*.

A calendar window opens. The current date is indicated with a red background.



Image 6-28: Date selection

6. To change the month, click on the left or right arrows next the month name until the desired month and year are obtained.

Click on a number in the number field to setup the day.

7. To change the time, click in the time field next to *Time*.

A window with 3 scroll counters open.



Image 6-29: Time setup

8. Click on the up down arrow of each scroll counter until the correct hour, minutes and seconds are obtained.
9. Click **Save changes** to apply.

## 6.18 Date & Time setup, time server

### About using NTP server

The clock is continuously synchronized with an external time server and the deviation is in the order of milliseconds. Extra time servers can be added.

As long as there is no synchronization with a time server the status is indicated as disabled.

### How to setup

1. Log in to the *Configurator*.
2. Click *System* → *Date & Time*.

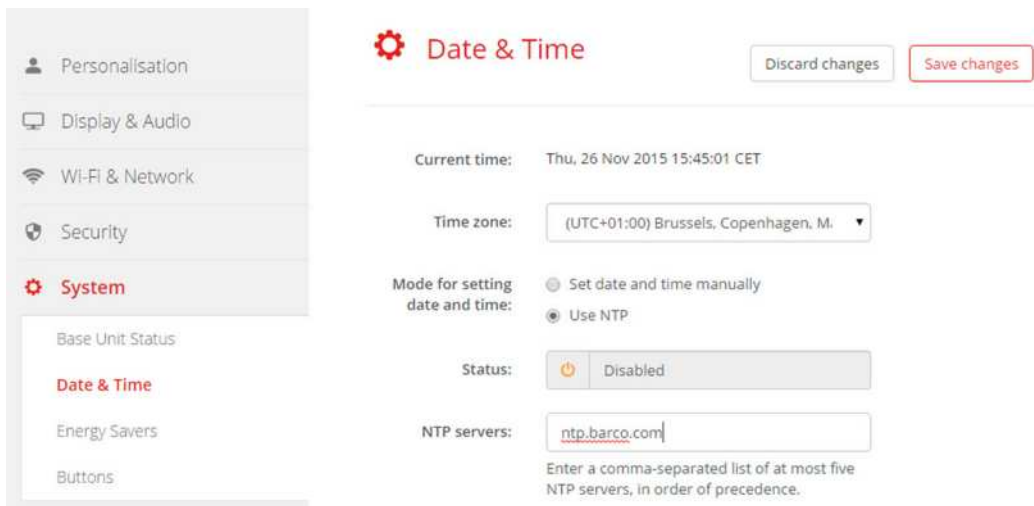



Image 6-30: Time server setup

The current time is indicated next to *Current time*.

3. Check the radio button next *Use NTP*.
4. Enter a NTP server address next to *NTP servers*. Enter the IP address or server name.
  -  *Note:* Multiple servers (maximum 5) can be added, separated by a comma.
5. Click **Save changes** to apply.

A synchronization with the NTP server takes place. The status field indicates the progress.

## 6.19 Energy savers

### About standby

**Standby after (minutes):** If there is no client connection detected during the standby timeout period, the Base Unit will enter the selected standby mode.

Default setting: Time to standby: 10 min, the Base Unit will enter the Eco standby mode.

### Eco mode

When the Base Unit enters ECO standby mode, it will disable the HDMI output signal. The Base Unit's LEDs will be breathing white to indicate the ECO standby mode.

Power consumption in Eco standby: 2.6W

The Base Unit will wake up with one of the following actions:

- Button or app connecting with the Base Unit
- Press the standby button on the Base Unit
- Pairing a Button on the Base Unit's USB port
- Plugging in an HDMI display
- When a CEC event is received

### Standby mode

When the Base Unit goes in Deep standby mode, it will shut down all processes, including the Wi-Fi access point and LAN connection. The Base Unit's LEDs will be dark to indicate this standby mode.

The Base Unit will wake up only when the standby button on the Base Unit is pressed.

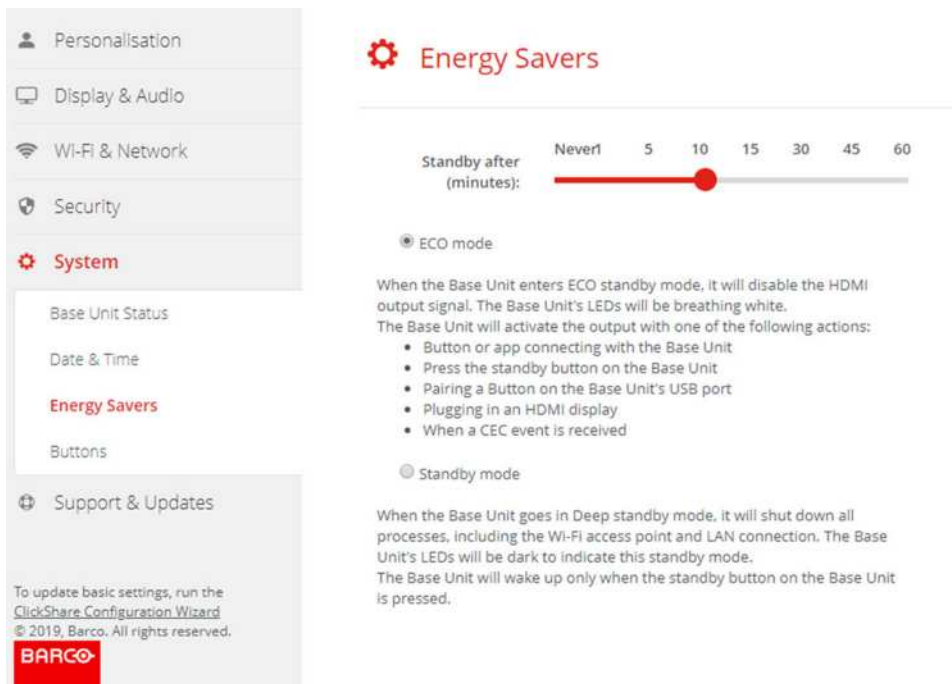

Image 6-31: Energy savers

## How to change the display timeout

1. Log in to the *Configurator*.
2. Click *System* → *Energy Savers*.
3. To set a display time out, move the slider to the left or to the right until the desired standby timeout is reached.

## 6.20 Buttons

### About Buttons

The Button page indicates to which Base Unit the Buttons are connected. It indicates also the current state.

All Buttons used with the Base Unit are indicated in the Buttons List. The list contains the state, the signal strength, the serial number, the firmware version, the number of connections and last connection.

It is possible to update the software of the Buttons over Wi-Fi.

### To edit the settings

1. Log in to the *Configurator*.
2. Click *System* → *Buttons*.

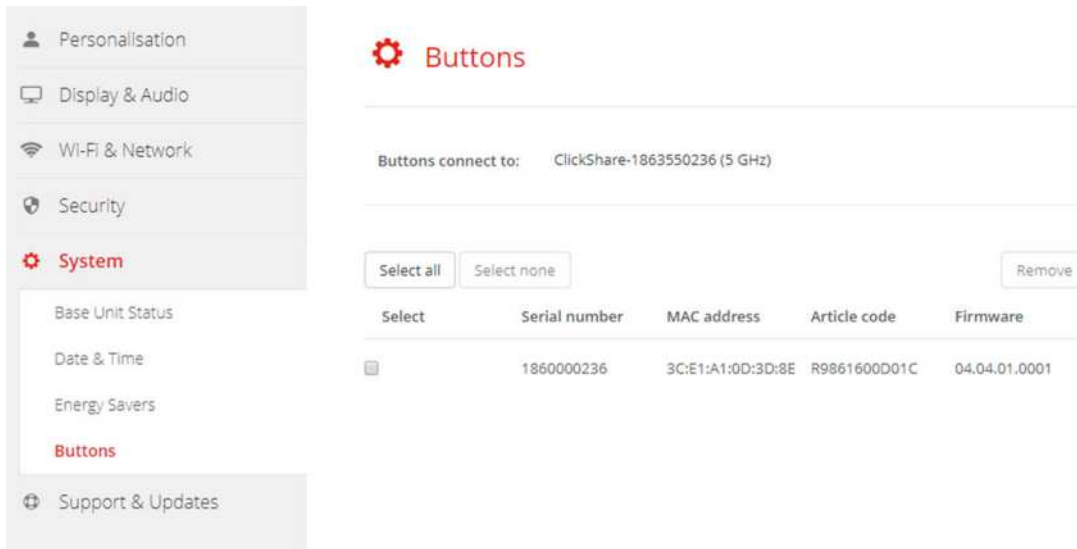

Image 6-32: Buttons overview

The current state is indicated and the list of Buttons is given.

3. Click **Edit settings**.
4. Select to which access point the Buttons are connected. Click on the drop down list next to *Buttons connect to* and select the desired point.

Depending on the selection, internal access point or external access point, settings should be filled out.

For an internal access point, no settings are needed.

## 6.21 Firmware Update

### About Firmware update

The firmware of the Base Unit can be updated via the web interface. The latest version of the firmware is available on Barco's website.

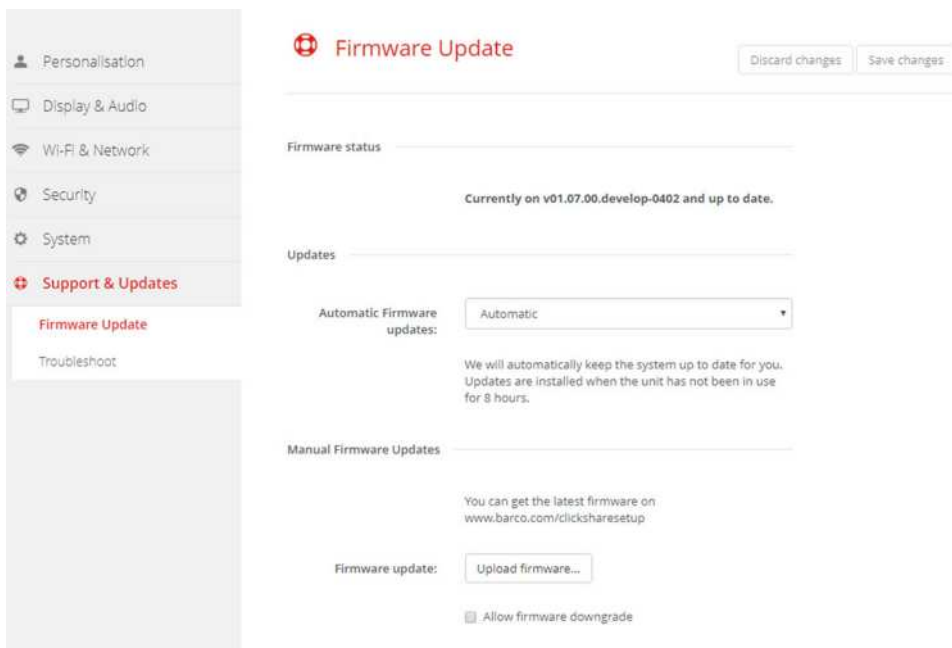

Image 6-33: Firmware update

## About automatic firmware updates

There are 3 ways to configure automatic updates:

- Automatic: The system will automatically detect firmware updates and install them for you when it's not in use.
- Notify: The system will automatically detect firmware updates and notify you on the web interface dashboard and firmware page. The update can then be initiated via the *Support & Updates > Firmware* page
- Off: The system will not detect firmware updates and will not notify you.

## Manual firmware update

1. Download the latest version of the firmware from Barco's website.
2. Log in to the *Configurator*.
3. Click *Support & Updates* → *Firmware*.
4. To upload a firmware version, click on **Upload firmware...**

A browser window opens.

5. Browse to the file with the new firmware and click **Open** to start the upload.



*Note:* This should be an .enc file. You might have to unzip the file downloaded from Barco's website.



*Note:* Updating the software to the Base Unit takes several minutes. Progress can be followed on the meeting room display.

The Base Unit software is updated.



If a firmware downgrade is required on the Base Unit, check the check box in front of *Allow firmware downgrade*.

## Firmware update without using the Configurator

Next to using the configurator to upgrade the firmware, the following ways are also possible:

- When your device is connected to a network and managed via the XMS (Cloud) management platform or the Collaboration Management Suite (CMGS), the firmware can be upgrade via this Management solution. For more information on upgrading firmware in this way, consult Barco's web pages on XMS (<https://www.barco.com/en/page/xms-cloud-management-platform>) or CMGS (<https://www.barco.com/nl/product/collaboration-management-suite>).
- Download the firmware on a USB stick and plug in this USB in your device. For more information, see "Updating the CX-20 firmware", page 90

# 6.22 Support & Updates, Troubleshoot, log settings

## About logging

Both Button and Base Unit log data is saved in log files on the Base Unit. These log files can contain debugging information. They can be downloaded on a local computer and cleared on the Base Unit. Debug logging covers only a few hours before it will be overwritten. Therefore, it is important if you discover a problem with your system to download the logging immediately.

## How to use

1. Log in to the *Configurator*.
2. Click *Support & Updates* → *Troubleshoot*.

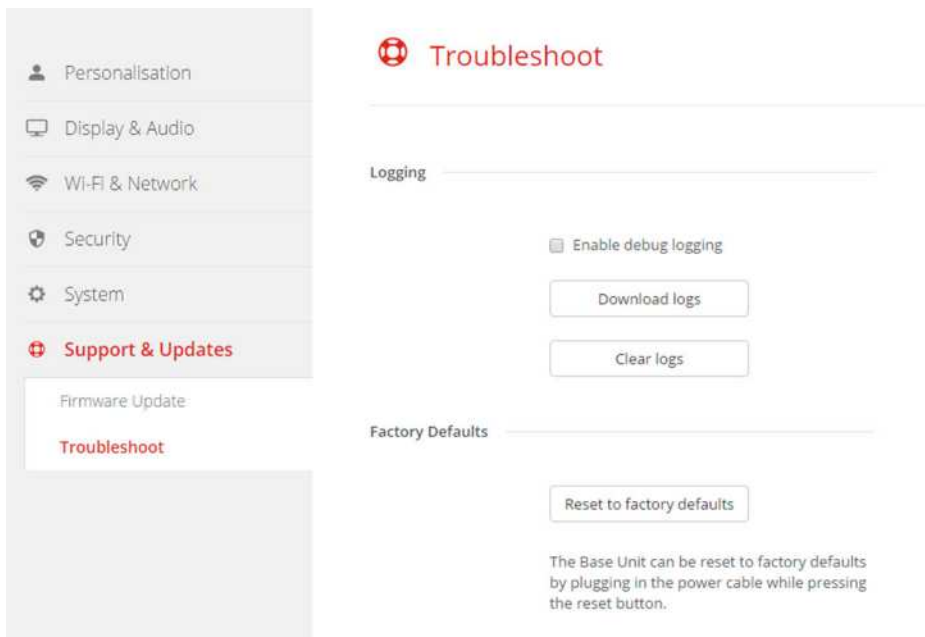

Image 6-34: Troubleshoot, logging

3. To create a debug log, check the check box next to *Enable debug logging*.
4. Reproduce the issue you want to report.
5. To download the current log file, click on **Download logs**.
6. To clear the current log file, click **Clear logs**.

## 6.23 Factory defaults

### About default settings

The ClickShare Base Unit can return to the factory default settings.

The following settings are the defaults:

- Meeting room identification info is cleared.
- Language is set to English.
- Custom wallpapers are removed and the default wallpaper is restored.
- Standby timer is reset to 10 min.
- Hostname and SSID is set to *clickshare-serialnumber*.
- The SSID is broadcasted
- WiFi password is reset to *clickshare*.
- The default WiFi channel is set back to frequency 5 GHz, channel 36.
- The update history is cleared.
- The table with the associated Buttons is cleared.
- The admin password is reset to *admin*.
- Debug logging and remote logging are disabled.



Restoring to factory defaults will require a repairing of the Buttons used with this Base Unit and the setup flow has to be redone..

### How to restore factory defaults

1. Log in to the *Configurator*.
2. Click *Support & Updates* → *Troubleshoot*.

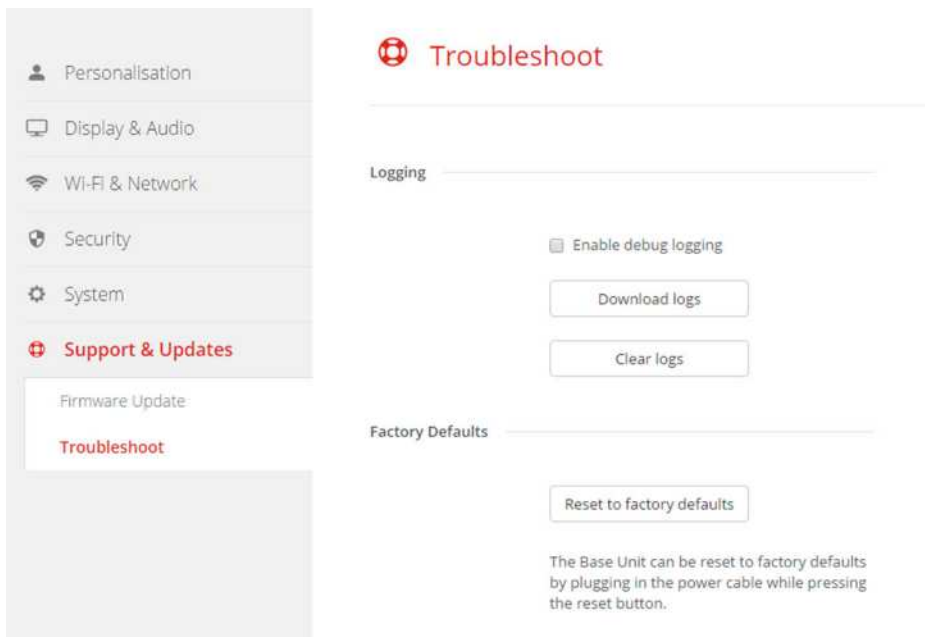

Image 6-35: Troubleshoot, factory defaults

3. Click **Reset to factory defaults**.

The following message is displayed: “This action will remove all settings of the Base Unit and replace them with the default settings. Are you sure you want to continue?”

4. If you want to continue, click **Yes, remove all settings** otherwise click **No, I changed my mind**.

When yes is clicked, the system starts a reboot.



Alternative way: The Base Unit can be reset to factory defaults by plugging in the power cable while pressing the reset button.





# Firmware updates

# 7

## 7.1 Updating the CX-20 firmware



When starting up the device for the first time a software update is necessary. This update can only be done via the network.

### About Firmware updates

There are different ways to update the Base Unit software:

- automatic update when connected with the network or your device is configured in XMS cloud.
- via the Configurator, for more information, see “*Firmware Update*”, page 84.
- by copying the software on a USB stick

### To update the Base Unit software by copying the software on a USB stick

1. Download the latest version of the firmware from Barco's website, [www.barco.com/clickshare](http://www.barco.com/clickshare). Click on **Support** and select the update firmware button of your device type.
2. Unzip the zip file.
3. Copy the ENC file to a USB stick.  
You can have multiple firmwares for multiple device types on the same stick.
4. Insert the USB stick into the USB port at the front of the Base Unit.
5. Follow the instructions on the meeting room screen.
6. When the on-screen message indicates that the process is finished, remove the USB stick.  
The Base Unit reboots.

# Troubleshooting

# 8

## 8.1 Troubleshooting list

### Problem solving

Problem	Cause	Solution
Quality of the image on the meeting room display is not satisfactory	The quality or length of the cable between the Base Unit and the display or the connection between these two.	<ul style="list-style-type: none"> <li>• Replace the cable.</li> <li>• Use another cable.</li> </ul>
	Bad resolution of the display The system can handle the average laptop resolution of 3 Megapixel. However, up or down scaling on the meeting room display can cause visible artefacts.	Change the resolution on the web interface and match it to the native resolution of the meeting room display.
Users have a bad wireless connection. The connection from the Button to the Base Unit keeps falling away.	Wireless congestion	<ul style="list-style-type: none"> <li>• Use a WiFi scanner to find a free wireless channel and select it via the web interface. You can use commercial as well as free online tools such as inSSIDer or Xirrus for this. Refer to “WiFi settings”.</li> </ul>
	Low signal strength	<ul style="list-style-type: none"> <li>• Put the Base Unit closer to the meeting room table.</li> <li>• Change the orientation of the antennas at the back of the Base Unit.</li> <li>• Remove or limit as much as possible all obstructions between the Buttons and the Base Unit.</li> </ul>
Web interface is not accessible	Browser	<ul style="list-style-type: none"> <li>• Use another browser (version).</li> <li>• Check the browser settings.</li> </ul>
	No connection	<ul style="list-style-type: none"> <li>• There are three methods to access the web interface. Refer to the corresponding chapter of the documentation.</li> <li>• Check the proxy settings</li> </ul>
Users do not get a ClickShare drive when inserting the Button in their laptop.	<ul style="list-style-type: none"> <li>• No automatic refresh of drives</li> <li>• Windows tries to assign the ClickShare drive to an already reserved drive letter</li> </ul>	<ul style="list-style-type: none"> <li>• Refresh your view on the laptop.</li> <li>• Use Microsoft Windows Disk Management to assign it to a free drive letter.</li> </ul>
	Bad connection at USB port on the laptop	<ul style="list-style-type: none"> <li>• Reconnect to the USB port.</li> <li>• Try another USB port.</li> <li>• Reboot the laptop.</li> </ul>
	<ul style="list-style-type: none"> <li>• Some types of USB devices might be blocked as a company policy.</li> <li>• USB port settings on the laptop might limit the usage of high power USB devices when on battery power.</li> </ul>	If possible, change the USB port policy on the laptop.

<b>Problem</b>	<b>Cause</b>	<b>Solution</b>
Low video performance	Laptop performance	<ul style="list-style-type: none"> <li>• Lower the screen resolution of the laptop.</li> <li>• Disable the hardware acceleration for video.</li> <li>• Use only a part of the display to show the video.</li> <li>• Right click ClickShare icon in system tray and click on Capture mode to toggle the current setting..</li> </ul>
	Wireless connectivity	See “Users have bad connectivity”
Video is not shown on screen	Player uses overlays	Disable the usage of overlays in the preferences of the video player.
Some programs of Windows are not shown on the display	Use of overlays, 3D or hardware acceleration in the GPU	<ul style="list-style-type: none"> <li>• Disable overlays or hardware acceleration in the GPU.</li> <li>• Disable AeroGlass in Windows 7</li> <li>• Upgrade the Base Unit to the latest software version.</li> </ul>
When using Windows 7 the following message about the Windows Aero color scheme appears: "Windows has detected your computer's performance is slow. This could be because there are not enough resources to run the Windows Aero color scheme. To improve...".	ClickShare uses resources from the GPU. In combination with other programs which do so, Windows 7 sometimes shows this message suggesting to disable Aero to improve the performance of your laptop.	It is safe to ignore this message and choose 'Keep the current color scheme'.
Your screen is not shown on the display when pressing the Button	<p>The number of shared video's on the screen is exceeded. When roomdock is used, only one participant can share his screen.</p> <p>The ClickShare software is not running.</p>	<p>Click and hold the button for 2 seconds to use the Show me full screen function.</p> <p>Go to the ClickShare drive and run the software.</p>
Your content is removed from the display and the LEDs on the button are blinking white	Connection to the Base Unit is lost.	<p>ClickShare tries to restore the connection automatically. If it fails, the LEDs on the Button start blinking red.</p> <p>Unplug the button from your laptop and try a new button.</p>
Nothing is shown on the displays at all.	<p>The displays are switched off.</p> <p>The display cable is not correctly connected</p> <p>The display does not recognize or is not able to display the Base Unit output resolution.</p> <p>The Base Unit is in standby mode</p>	<p>Switch on the displays.</p> <p>Insert the display cable to the display and the Base Unit.</p> <p>Change the corresponding setting via the web interface.</p> <p>Briefly push the standby button on the Base Unit or insert a button and run the ClickShare software.</p>

Problem	Cause	Solution
Bad WiFi connectivity	Congestion of the wireless channel	Use wireless network scan tools to look for free or the least congested channels.
	Metal cabinets, walls, construction elements, ... can cause reflections deteriorating the wireless signal. Obstructions between Buttons and Base Unit cause lowering of the wireless strength and quality.	Move the Base Unit to another place in the room.  Avoid placing it inside cabinets, false ceiling, below the table, behind a wall, in another room, ....  Re-orient the Base Unit antennas  Check out the ClickShare White paper on WiFi See <a href="http://www.barco.com/clickshare">www.barco.com/clickshare</a> .
Web Interface shows error in the processes "WiFi Access Point Daemon" and/or "DHCP Server"	Configuration file is corrupted	Browse to the Configuration tab on the Web Interface and press "Load Default Settings".
ClickShare Base Unit does not start up correctly	Configuration file is corrupted	Browse to the Configuration tab of the Web Interface and press "Load Default Settings".
No LAN connection with the Base Unit	Wrong IP address	IP address is not within your LAN range.
		DHCP is not enabled.
No WiFi connection with Base Unit	SSID not correct	Enter the correct SSID

Locate the problem you are experiencing in the table below and apply the solution.

### Barco knowledge base and YouTube videos

Go to the product page on Barco's website and select in the right column **Support**. You will get access to Barco's *Knowledge base* and *Latest tutorial videos*. For more YouTube videos, consult <https://www.youtube.com/user/barcoTV> and select ClickShare.





R5900102 /00 | 2020-03-12

Barco NV | Beneluxpark 21, 8500 Kortrijk, Belgium  
Registered office: Barco NV | President Kennedypark 35, 8500 Kortrijk, Belgium  
[www.barco.com](http://www.barco.com)