



Simply Better Connections

ES0154 / ES0154P

54-Port Layer 2+ Gigabit Ethernet
Managed Switch / with PoE
User Manual

Compliance Statements

FEDERAL COMMUNICATIONS COMMISSION INTERFERENCE STATEMENT

This equipment has been tested and found to comply with the limits for a Class A digital device, pursuant to Part 15 of the FCC Rules. These limits are designed to provide reasonable protection against harmful interference when the equipment is operated in a commercial environment. This equipment generates, uses, and can radiate radio frequency energy and, if not installed and used in accordance with the instruction manual, may cause harmful interference to radio communications. Operation of this equipment in a residential area is likely to cause harmful interference in which case the user will be required to correct the interference at his own expense.

The device complies with Part 15 of the FCC Rules. Operation is subject to the following two conditions: (1) this device may not cause harmful interference, and (2) this device must accept any interference received, including interference that may cause undesired operation.

FCC Caution

Any changes or modifications not expressly approved by the party responsible for compliance could void the user's authority to operate this equipment.

Warning

Operation of this equipment in a residential environment could cause radio interference.

Achtung

Der Gebrauch dieses Geräts in Wohnumgebung kann Funkstörungen verursachen.



KCC Statement

유선 제품용 / A 급 기기 (업무용 방송 통신 기기)
 이 기기는 업무용 (A 급) 전자파적합기기로서 판매자 또는 사용자는 이
 점을 주의하시기 바라며, 가정 외의 지역에서 사용하는 것을 목적으로
 합니다.

RoHS

This product is RoHS compliant.

User Information

Online Registration

Be sure to register your product at our online support center:

International	http://eservice.aten.com
---------------	---

Telephone Support

For telephone support, call this number:

International	886-2-8692-6959
China	86-400-810-0-810
Japan	81-3-5615-5811
Korea	82-2-467-6789
North America	1-888-999-ATEN ext 4988 1-949-428-1111

User Notice

All information, documentation, and specifications contained in this manual are subject to change without prior notification by the manufacturer. The manufacturer makes no representations or warranties, either expressed or implied, with respect to the contents hereof and specifically disclaims any warranties as to merchantability or fitness for any particular purpose. Any of the manufacturer's software described in this manual is sold or licensed *as is*. Should the programs prove defective following their purchase, the buyer (and not the manufacturer, its distributor, or its dealer), assumes the entire cost of all necessary servicing, repair and any incidental or consequential damages resulting from any defect in the software.

The manufacturer of this system is not responsible for any radio and/or TV interference caused by unauthorized modifications to this device. It is the responsibility of the user to correct such interference.

The manufacturer is not responsible for any damage incurred in the operation of this system if the correct operational voltage setting was not selected prior to operation. PLEASE VERIFY THAT THE VOLTAGE SETTING IS CORRECT BEFORE USE.

Product Information

For information about all ATEN products and how they can help you connect without limits, visit ATEN on the Web or contact an ATEN Authorized Reseller. Visit ATEN on the Web for a list of locations and telephone numbers:

International	http://www.aten.com
---------------	---

Package Contents

Check to make sure that all the components are in working order. If you encounter any problem, please contact your dealer.

ES0154 / ES0154P

- 1 54-Port Layer 2+ Gigabit Ethernet Managed Switch / 54-Port Layer 2+ Gigabit Ethernet Managed Switch with PoE
- 1 power cord
- 1 RJ-45 to DB-9 serial console cable
- 1 grounding wire
- 6 port dust covers
- 1 mounting kit
- 1 user instructions

Content

Compliance Statements	ii
User Information	iii
Online Registration	iii
Telephone Support	iii
User Notice	iii
Product Information	iv
Package Contents	v
ES0154 / ES0154P	v
Content	vi
About This Manual	xxxii
Overview	xxxii
Conventions	xxxiii
Chapter 1.Introduction	
Overview	1
Features	2
Components	3
ES0154 Front View	3
ES0154P Front View	3
ES0154 Rear View	3
ES0154P Rear View	3
System LED	5
Port Status LED	5
Web Interface	7
Initial Configuration and Logging In	7
Chapter 2.Installation	
Mounting	9
Rack Mount	9
Desk Mount	10
Installing SFP+/SFP28 Modules	11
Hardware Installation	12
Chapter 3.Web Management - Introduction	
Overview	13
Key Features	13
Description of Software Features	14
Configuration Backup and Restore	15
Authentication	15
Access Control Lists	15
DHCP Relay	15
Port Configuration	16
Rate Limiting	16
Port Mirroring	16
Port Trunking	16

Storm Control	16
Static MAC Address	17
IP Address Filtering	17
IEEE 802.1D Bridge	17
Store-and-Forward Switching	17
Spanning Tree Algorithm	17
Virtual LANs	18
IEEE 802.1Q Tunneling (QinQ)	19
Traffic Prioritization	19
Quality of Service	19
Ethernet Ring Protection Switching	19
Operation, Administration, and Maintenance	20
Multicast Filtering	20
Link Layer Discovery Protocol	20
System Defaults	21
Web Configuration	24

Chapter 4. Using the Web Interface

Overview	25
Connecting to the Web Interface	25
Navigating the Web Browser Interface	26
Dashboard	26
Configuration Options	27
Panel Display	28
Main Menu	29

Chapter 5. Basic Management Tasks

Overview	53
Displaying System Information	54
Parameters	54
Web Interface	54
Displaying Hardware / Software Versions	55
Parameters	55
Web Interface	55
Configuring Support for Jumbo Frames	56
Usage Guidelines	56
Parameters	56
Web Interface	56
Displaying Bridge Extension Capabilities	57
Parameters	57
Web Interface	58
Managing System Files	59
Copying Files via FTP/FTPS/SFTP/SCP/TFTP/HTTP	59
Command Usage	59
Parameters	59
Web Interface	61
Saving the Running Configuration to a Local File	61

Parameters	62
Web Interface	62
Setting the Start-up File	63
Web Interface	63
Showing System Files	63
Web Interface	64
Automatic Operation Code Upgrade	64
Usage Guidelines	64
Parameters	66
Web Interface	68
Setting the System Clock	69
Setting the Time Manually	69
Parameters	69
Web Interface	69
Setting the SNTP Polling Interval	70
Parameters	70
Web Interface	70
Configuring NTP	71
Parameters	71
Web Interface	71
Configuring Time Servers	72
Specifying SNTP Time Servers	72
Parameters	72
Web Interface	72
Specifying NTP Time Servers	73
Parameters	73
Web Interface	73
Specifying NTP Authentication Keys	74
Parameters	74
Web Interface	74
Setting the Time Zone	75
Parameters	75
Web Interface	76
Configuring Summer Time	76
Parameters	77
Web Interface	78
Configuring the Console Port	79
Parameters	79
Web Interface	80
Configuring Telnet Settings	81
Parameters	81
Web Interface	82
Displaying CPU Utilization	83
Parameters	83
Web Interface	83
Configuring CPU Guard	84

Parameters	84
Web Interface	85
Displaying Memory Utilization	86
Parameters	86
Web Interface	86
Resetting the System	87
Command Usage	87
Parameters	87
Web Interface	88
Restarting the Switch (Immediately)	88
Restarting the Switch (In)	89
Restarting the Switch (At)	89
Restarting the Switch (Regularly)	90

Chapter 6. Interface Configuration

Overview	91
Port Configuration	92
Configuring by Port List	92
Command Usage	92
Parameters	92
Web Interface	93
Configuring by Port Range	94
Parameters	94
Web Interface	94
Displaying Connection Status	94
Parameters	94
Web Interface	95
Displaying Statistics	96
Parameters	96
Web Interface	99
Displaying Statistical History	101
Command Usage	101
Parameters	101
Web Configuration	102
Displaying Transceiver Data	105
Parameters	105
Web Interface	106
Configuring Transceiver Thresholds	107
Parameters	107
Web Interface	109
Cable Test	110
Command Usage	110
Parameters	111
Web Interface	111
Trunk Configuration	112
Command Usage	112

Configuring a Static Trunk	113
Command Usage	113
Parameters	113
Web Interface	113
Configuring a Dynamic Trunk	115
Command Usage	115
Parameters	116
Web Interface	119
Displaying LACP Port Counters	121
Parameters	121
Web Interface	122
Displaying LACP Settings and Status for the Local Side	122
Parameters	122
Web Interface	123
Displaying LACP Settings and Status for the Remote Side	124
Parameters	124
Web Interface	125
Configuring Load Balancing	125
Command Usage	125
Parameters	126
Web Interface	127
Saving Power	128
Command Usage	128
Parameters	128
Web Interface	129
Local Port Mirroring	130
Command Usage	130
Parameters	130
Web Interface	131
Remote Port Mirroring	132
Command Usage	132
Parameters	134
Web Interface	135
Configuring Remote Port Mirroring (Source)	135
Configuring Remote Port Mirroring (Intermediate)	135
Configuring Remote Port Mirroring (Destination)	136
Flow Sampling	137
Configuring sFlow Receiver Settings	137
Parameters	137
Web Interface	138
Web Interface	139
Configuring an sFlow Polling Instance	139
Parameters	139
Web Interface	140
Web Interface	140
Traffic Segmentation	142

Enabling Traffic Segmentation	142
Parameters	142
Web Interface	142
Configuring Uplink and Downlink Ports	143
Command Usage	143
Parameters	144
Web Interface	144
VLAN Trunking	146
Command Usage	146
Parameters	147
Web Interface	147

Chapter 7.VLAN Configuration

Overview	149
IEEE 802.1Q VLANs	150
Configuring VLAN Groups	153
Parameters	153
Web Interface	154
Adding Static Members to VLANs	155
Parameters	155
Web Interface	157
Configuring Dynamic VLAN Registration	159
Parameters	159
Web Interface	160
IEEE 802.1Q Tunneling	163
Enabling QinQ Tunneling on the Switch	167
Parameters	167
Web Interface	168
Creating CVLAN to SPVLAN Mapping Entries	168
Command Usage	168
Parameters	169
Web Interface	169
Adding an Interface to a QinQ Tunnel	170
Command Usage	170
Parameters	170
Web Interface	171
L2PT Tunneling	172
Command Usage	172
Configuring the L2PT Tunnel Address	174
Parameters	174
Web Interface	174
Enabling L2PT for Selected Interfaces	175
Parameters	175
Web Interface	175
Protocol VLANs	176
Command Usage	176

Configuring Protocol VLAN Groups	176
Parameters	176
Web Interface	177
Mapping Protocol Groups to Interfaces.....	178
Command Usage	178
Parameters	178
Web Interface	179
IP Subnet VLANs	180
Command Usage	180
Parameters	181
Web Interface	181
MAC-based VLANs	182
Command Usage	182
Parameters	182
Web Interface	183
VLAN Mirroring	184
Command Usage	184
Parameters	184
Web Interface	184
VLAN Translation	186
Command Usage	186
Parameters	186
Web Interface	187

Chapter 8.Address Table Settings

Overview	189
Dynamic Address Cache	190
Parameters	190
Web Interface	190
Clearing the Dynamic Address Table	191
Parameters	191
Web Interface	191
Address Aging Time	192
Parameters	192
Web Interface	192
MAC Address Learning	193
Command Usage	193
Parameters	193
Web Interface	194
Static MAC Addresses	195
Command Usage	195
Parameters	195
Web Interface	196
MAC Address Mirroring	197
Command Usage	197
Parameters	197

Web Interface	197
MAC Notification Traps	199
Parameters	199
Web Interface	199

Chapter 9.Spanning Tree Algorithm

Overview	201
Loopback Detection	204
Parameters	204
Web Interface	205
Global Settings for STA	206
Command Usage	206
Parameters	207
Web Interface	209
Configuring Global Settings for STA (STP)	210
Configuring Global Settings for STA (RSTP)	210
Configuring Global Settings for STA (MSTP)	211
Displaying Global Settings for STA	211
Parameters	211
Web Interface	212
Interface Settings for STA	213
Parameters	213
Recommended STA Path Cost Range	214
Default STA Path Costs	214
Web Interface	217
Displaying Interface Settings for STA	218
Parameters	218
Web Interface	220
Global Settings for MSTP	221
Command Usage	221
Parameters	221
Web Interface	222
Interface Settings for MSTP	225
Parameters	225
Web Interface	226

Chapter 10.Congestion Control

Overview	227
Rate Limiting	228
Parameters	228
Web Interface	228
Storm Control	229
Command Usage	229
Parameters	229
Web Interface	230
Automatic Traffic Control	231
Command Usage	231

Setting the ATC Timers	232
Command Usage	232
Parameters	233
Web Interface	233
Configuring ATC Threshold and Responses	234
Parameters	234
Web Interface	235

Chapter 11. Class of Service

Overview	237
Layer 2 Queue Settings	238
Setting the Default Priority for Interfaces	238
Command Usage	238
Parameters	238
Web Interface	238
Selecting the Queue Mode	239
Command Usage	239
Parameters	240
Web Interface	240
Setting the Queue Mode (Strict)	241
Setting the Queue Mode (WRR)	241
Setting the Queue Mode (Strict and WRR)	241
Mapping CoS Value to Egress Queues	242
Command Usage	242
Parameters	243
Web Interface	243
Layer 3/4 Priority Settings	245
Setting Priority Processing to IP Precedence/DSCP or CoS	245
Command Usage	245
Parameters	246
Web Interface	246
Mapping Ingress DSCP Values to Internal DSCP Values	247
Command Usage	247
Parameters	247
Web Interface	248
Mapping CoS Priorities to Internal DSCP Values	249
Command Usage	249
Parameters	250
Web Interface	250
Mapping IP Precedence Values to Internal DSCP Values	251
Command Usage	252
Parameters	252
Web Interface	253

Chapter 12. Quality of Service

Overview	255
Class Map	256

Command Usage	256
Parameters	256
Web Interface	257
Policy Map	259
Command Usage	262
Parameters	262
Web Interface	266
Binding to a Port	269
Command Usage	269
Parameters	269
Web Interface	269
Chapter 13.VoIP Traffic Configuration	
Overview	271
Global Settings	272
Command Usage	272
Parameters	272
Web Interface	273
Telephony OUI List	274
Parameters	274
Web Interface	274
Port Settings	276
Command Usage	276
Parameters	276
Web Interface	277
Chapter 14.Security Measures	
Overview	279
AAA	281
Configuring Local/Remote Logon Authentication	282
Command Usage	282
Parameters	282
Web Interface	283
Configuring Remote Logon Authentication Servers	283
Command Usage	284
Parameters	284
Web Interface	286
Configuring AAA Accounting	288
Command Usage	288
Parameters	288
Web Interface	290
Configuring AAA Authorization	293
Command Usage	293
Parameters	294
Web Interface	295
User Accounts	297
Command Usage	297

Parameters	297
Web Interface	298
Web Authentication	300
Configuring Global Settings for Web Authentication	300
Parameters	300
Web Interface	301
Configuring Interface Settings for Web Authentication	301
Parameters	301
Web Interface	302
Network Access (MAC Address Authentication)	303
Command Usage	303
Configuring Global Settings for Network Access	305
Parameters	305
Web Interface	306
Configuring Network Access for Ports	306
Parameters	307
Web Interface	308
Configuring Port Link Detection	309
Parameters	309
Web Interface	309
Configuring a MAC Address Filter	310
Command Usage	310
Parameters	310
Web Interface	310
Displaying Secure MAC Address Information	311
Parameters	311
Web Interface	312
HTTPS	313
Configuring Global Settings for HTTPS	313
Command Usage	313
Parameters	314
Web Interface	314
Replacing the Default Secure-site Certificate	314
Parameters	315
Web Interface	315
SSH	317
Command Usage	317
Configuring the SSH Server	319
Parameters	319
Web Interface	320
Generating the Host Key Pair	320
Parameters	321
Web Interface	321
Importing User Public Keys	322
Parameters	322
Web Interface	322

ACL (Access Control Lists)	324
Command Usage	324
Showing TCAM Utilization	325
Command Usage	325
Parameters	326
Web Interface	326
Setting the ACL Name and Type	327
Parameters	327
Web Interface	327
Configuring a Standard IPv4 ACL	328
Parameters	328
Web Interface	329
Configuring an Extended IPv4 ACL	329
Parameters	329
Web Interface	331
Configuring a Standard IPv6 ACL	332
Parameters	332
Web Interface	332
Configuring an Extended IPv6 ACL	333
Parameters	333
Web Interface	334
Configuring a MAC ACL	335
Parameters	335
Web Interface	336
Configuring an ARP ACL	337
Parameters	337
Web Interface	338
Binding a Port to an Access Control List	339
Parameters	339
Web Interface	339
Showing ACL Hardware Counters	340
Parameters	340
Web Interface	341
IP Filter	342
Command Usage	342
Parameters	342
Web Interface	342
Port Security	344
Command Usage	344
Parameters	345
Web Interface	346
Port Authentication	347
Configuring 802.1X Global Settings	349
Parameters	349
Web Interface	350
Configuring Port Authenticator Settings for 802.1X	350

Command Usage	350
Parameters	351
Web Interface	353
Configuring Port Supplicant Settings for 802.1X	354
Command Usage	354
Parameters	355
Web Interface	355
Displaying 802.1X Statistics	356
Parameters	356
Web Interface	357
DoS Protection	359
Parameters	359
Web Interface	361
DHCP Snooping	362
Command Usage	362
DHCP Snooping Global Configuration	364
Parameters	364
Web Interface	366
DHCP Snooping VLAN Configuration	366
Command Usage	366
Parameters	367
Web Interface	367
Configuring Ports for DHCP Snooping	367
Command Usage	367
Parameters	368
Web Interface	368
Displaying DHCP Snooping Binding Information	369
Parameters	369
Web Interface	370
DHCPv6 Snooping	371
Command Usage	371
DHCPv6 Snooping Global Configuration	373
Parameters	373
Web Interface	374
DHCPv6 Snooping VLAN Configuration	375
Command Usage	375
Parameters	375
Web Interface	375
Configuring Interfaces for DHCPv6 Snooping	376
Command Usage	376
Parameters	377
Web Interface	377
Displaying DHCPv6 Snooping Binding Information	378
Parameters	378
Web Interface	378
Displaying DHCPv6 Snooping Statistics	379

Parameters	379
Web Interface	379
ND Snooping	380
Usage Guidelines	380
ND Snooping Global Configuration	381
Parameters	381
Web Interface	382
ND Snooping VLAN Configuration	382
Parameters	382
Web Interface	383
Configuration Ports for ND Snooping	383
Usage Guidelines	383
Parameters	383
Web Interface	384
Displaying ND Snooping Binding Information	384
Parameters	384
Web Interface	384
Displaying ND Snooping Prefix Information	385
Parameters	385
Web Interface	385
IPv4 Source Guard	386
Configuring Ports for IPv4 Source Guard	386
Command Usage	386
Parameters	387
Web Interface	388
Configuring Static Bindings for IPv4 Source Guard	388
Command Usage	388
Parameters	389
Web Interface	390
Displaying Information for Dynamic IPv4 Source Guard Bindings	391
Parameters	391
Web Interface	391
IPv6 Source Guard	392
Configuring Ports for IPv6 Source Guard	392
Command Usage	392
Parameters	393
Web Interface	394
Configuring Static Bindings for IPv6 Source Guard	394
Command Usage	394
Parameters	395
Web Interface	396
Displaying Information for Dynamic IPv6 Source Guard Bindings	397
Parameters	397
Web Interface	397
ARP Inspection	398
Command Usage	398

Configuring Global Settings for ARP Inspection	399
Command Usage	399
Parameters	400
Web Interface	400
Configuring VLAN Settings for ARP Inspection	401
Command Usage	401
Parameters	401
Web Interface	402
Configuring Interface Settings for ARP Inspection	402
Parameters	402
Web Interface	403
Displaying ARP Inspection Statistics	403
Parameters	404
Web Interface	404
Displaying the ARP Inspection Log	405
Parameters	405
Web Interface	405
Application Filter	406
Command Usage	406
Parameters	406
Web Interface	406

Chapter 15. Basic Administration Protocols

Overview	407
Event Logging	408
System Log Configuration	408
Parameters	408
Web Interface	409
Remote Log Configuration	410
Parameters	410
Web Interface	411
Sending Simple Mail Transfer Protocol Alerts	411
Parameters	412
Web Interface	413
Link Layer Discovery Protocol (LLDP)	414
Setting LLDP Timing Attributes	414
Parameters	414
Web Interface	415
Configuring LLDP Interface Attributes	416
Parameters	416
Web Interface	419
Configuring LLDP Interface Civic-Address	420
Command Usage	420
Parameters	421
Web Interface	421
Displaying LLDP Local Device Information	422

Parameters	422
Web Interface	424
Displaying LLDP Remote Device Information	426
Parameters	426
Web Interface	432
Displaying Device Statistics	434
Parameters	434
Web Interface	435
Power over Ethernet	437
Setting the Switch's Overall PoE Power Budget	437
Parameters	437
Web Interface	438
Setting the Port PoE Power Budget	438
Command Usage	438
Parameters	439
Web Interface	440
Simple Network Management Protocol (SNMP)	441
Command Usage	442
Configuring Global Settings for SNMP	443
Parameters	443
Web Interface	443
Setting Community Access Strings	444
Parameters	444
Web Interface	444
Setting the Local Engine ID	445
Command Usage	445
Parameters	446
Web Interface	446
Specifying a Remote Engine ID	446
Command Usage	446
Parameters	447
Web Interface	447
Setting SNMPv3 Views	448
Parameters	448
Web Interface	448
Configuring SNMPv3 Groups	450
Parameters	450
Web Interface	454
Configuring Local SNMPv3 Users	455
Parameters	456
Web Interface	456
Configuring Remote SNMPv3 Users	458
Command Usage	458
Parameters	458
Web Interface	459
Specifying Trap Managers	460

Command Usage	460
Parameters	461
Web Interface	463
Creating SNMP Notification Logs	465
Command Usage	465
Parameters	465
Web Interface	466
Showing SNMP Statistics	466
Parameters	467
Web Interface	468
Remote Monitoring (RMON)	469
Configuring RMON Alarms	469
Command Usage	469
Parameters	469
Web Interface	470
Configuring RMON Events	472
Command Usage	472
Parameters	472
Web Interface	473
Configuring RMON History Samples	474
Command Usage	474
Parameters	474
Web Interface	475
Configuring RMON Statistical Samples	476
Command Usage	476
Parameters	477
Web Interface	477
Switch Clustering	479
Command Usage	479
Configuring General Settings for Clusters	479
Command Usage	480
Parameters	480
Web Interface	480
Cluster Member Configuration	481
Parameters	481
Web Interface	481
Managing Cluster Members	482
Parameters	482
Web Interface	483
Time Range	484
Command Usage	484
Parameters	484
Web Interface	484
Ethernet Ring Protection Switching (ERPS)	486
ERPS Global Configuration	490
Parameters	490

Web Interface	491
ERPS VLAN Group Configuration	491
Command Usage	491
Parameters	491
Web Interface	492
ERPS Ring Configuration	492
Command Usage	492
Parameters	493
Web Interface	493
ERPS Instance Configuration	494
Command Usage	494
Parameters	494
Web Interface	507
ERPS Forced and Manual Mode Operations	509
Parameters	509
Web Interface	513
MLAG	514
Usage Guidelines	514
MLAG Restrictions	515
MLAG Global Configuration	515
Parameters	515
Web Interface	515
MLAG Domain Configuration	515
Usage Guidelines	516
Parameters	516
Web Interface	516
MLAG Group Configuration	516
Usage Guidelines	516
Parameters	517
Web Interface	518
Operation, Administration and Maintenance (OAM)	519
Enabling OAM on Local Ports	519
Parameters	519
Web Interface	521
Displaying Statistics for OAM Messages	521
Parameters	521
Web Interface	522
Displaying the OAM Event Log	522
Command Usage	522
Web Interface	522
Displaying the Status of Remote Interfaces	523
Parameters	523
Web Interface	524
Configuring a Remote Loopback Test	524
Command Usage	524
Parameters	524

Web Interface	526
Displaying Results of Remote Loopback Testing	526
Parameters	526
Web Interface	527
UniDirectional Link Detection (UDLD)	528
Usage Guidelines	528
Configuring UDLD Protocol Intervals	528
Parameters	528
Web Interface	529
Configuring UDLD Interface Settings	530
Parameters	530
Web Interface	532
Displaying UDLD Neighbor Information	532
Parameters	532
Web Interface	533
Loopback Detection (LBD)	534
Usage Guidelines	534
Configuring Global Settings for LBD	534
Parameters	534
Web Interface	536
Configuring Interface Settings for LBD	536
Parameters	536
Web Interface	537
Smart Pair Configuration	538
Usage Guidelines	538
Configuring the Smart Pair Global Settings	538
Parameters	538
Web Interface	539
Configuring Smart Pair Interface Settings	539
Parameters	539
Web Interface	539
Show the Configured Smart Pair IDs	540
Web Interface	540
Display the Configured Smart Pair Port Members and Restore the Traffic	541
Web Interface	541

Chapter 16. Multicast Filtering

Overview	543
IGMP Snooping	545
Configuring IGMP Snooping and Query Parameters	546
Command Usage	547
Parameters	547
Web Interface	550
Specifying Static Interfaces for a Multicast Router	551
Command Usage	551

Parameters	551
Web Interface	552
Assigning Interfaces to Multicast Services	553
Command Usage	554
Parameters	554
Web Interface	554
Setting IGMP Snooping Status per Interface	555
Command Usage	555
Parameters	557
Web Interface	560
Filtering IGMP Packets on an Interface	561
Parameters	561
Web Interface	562
Displaying Multicast Groups Discovered by IGMP Snooping	562
Command Usage	562
Parameters	562
Web Interface	563
Displaying IGMP Snooping Statistics	563
Statistic Pages	564
Web Interface	565
IGMP Filtering and Throttling	568
Enabling IGMP Filtering and Throttling	568
Parameters	568
Web Interface	568
Configuring IGMP Filter Profiles	569
Command Usage	569
Parameters	569
Web Interface	570
Configuring IGMP Filtering and Throttling for Interfaces	571
Command Usage	571
Parameters	572
Web Interface	572
MLD Snooping	573
Configuring MLD Snooping and Query Parameters	573
Parameters	573
Web Interface	575
Setting Immediate Leave Status for MLD Snooping per Interface	575
Parameters	575
Web Interface	576
Specifying Static Interfaces for an IPv6 Multicast Router	576
Command Usage	576
Parameters	576
Web Interface	577
Assigning Interfaces to IPv6 Multicast Services	578
Command Usage	578
Parameters	578

Web Interface	579
Filtering MLD Query Packets on an Interface	580
Parameters	580
Web Interface	580
Showing MLD Snooping Groups and Source List	581
Parameters	581
Web Interface	582
Displaying MLD Snooping Statistics	582
Parameters	582
Parameters	585
Web Interface	585
MLD Filtering and Throttling	589
Enabling MLD Filtering and Throttling	589
Parameters	589
Web Interface	589
Configuring MLD Filter Profiles	590
Command Usage	590
Parameters	590
Web Interface	591
Configuring MLD Filtering and Throttling for Interfaces	592
Command Usage	592
Parameters	593
Web Interface	593
Filtering MLD Query Packets on an Interface	594
Parameters	594
Web Interface	594
Multicast VLAN Registration for IPv4	595
Command Usage	595
Configuring MVR Global Settings	596
Parameters	596
Web Interface	598
Configuring MVR Domain Settings	598
Parameters	598
Web Interface	599
Configuring MVR Group Address Profiles	599
Command Usage	600
Parameters	600
Web Interface	600
Configuring MVR Interface Status	602
Command Usage	602
Parameters	603
Web Interface	604
Assigning Static MVR Multicast Groups to Interfaces	605
Command Usage	605
Parameters	605
Web Interface	605

Displaying MVR Receiver Groups	606
Parameters	606
Web Interface	607
Displaying MVR Statistics	607
Parameters	608
Web Interface	609

Chapter 17.IP Tools

Overview	613
Ping	614
Parameters	614
Command Usage	614
Web Interface	615
Trace Route	616
Parameters	616
Command Usage	616
Web Interface	617
Address Resolution Protocol	618
Basic ARP Configuration	619
Command Usage	619
Parameters	619
Web Interface	620
Configuring Static ARP Addresses	620
Command Usage	620
Parameters	621
Web Interface	621
Displaying Dynamic or Local ARP Entries	622
Web Interface	622
Displaying ARP Statistics	622
Parameters	623
Web Interface	623

Chapter 18.IP Configuration

Overview	625
IPv4 Configuration	626
Configuring IPv4 Interface Settings	626
Command Usage	626
Parameters	627
Web Interface	628
IPv6 Configuration	630
Command Usage	630
Configuring the IPv6 Default Gateway	630
Parameters	630
Web Interface	631
Configuring IPv6 Interface Settings	631
Command Usage	631
Parameters	632

Web Interface	635
Configuring IPv6 Neighbor Addresses	636
Usage Guidelines	636
Parameters	637
Web Interface	637
Configuring an IPv6 Address	638
Command Usage	638
Parameters	639
Web Interface	641
Configuring IPv6 ND Prefixes	641
Usage Guidelines	641
Parameters	641
Web Interface	642
Showing IPv6 Addresses	643
Parameters	643
Web Interface	644
Showing the IPv6 Neighbor Cache	644
Parameters	644
Web Interface	645
Showing IPv6 Statistics	646
Command Usage	646
Parameters	646
Web Interface	650
Showing the MTU for Responding Destinations	652
Parameters	652
Web Interface	652

Chapter 19. General IP Routing

Overview	653
Initial Configuration	653
IP Routing and Switching	654
Routing Path Management	656
Routing Protocols	656
Static Routes	657
Command Usage	657
Parameters	657
Web Interface	657
Routing Table	659
Command Usage	659
Parameters	659
Web Interface	660

Chapter 20. IP Services

Overview	661
DNS	662
Configuring General DNS Service Parameters	662
Command Usage	662

Parameters	662
Web Interface	662
Configuring a List of Domain Names	663
Command Usage	663
Parameters	663
Web Interface	663
Configuring a List of Name Servers	664
Command Usage	664
Parameters	664
Web Interface	665
Configuring Static DNS Host to Address Entries	665
Command Usage	665
Parameters	666
Web Interface	666
Displaying the DNS Cache	666
Command Usage	667
Parameters	667
Web Interface	667
Multicast DNS	668
Command Usage	668
Parameters	668
Web Interface	669
DHCP	670
Specifying a DHCP Client Identifier	670
Command Usage	670
Parameters	671
Web Interface	671
Configuring DHCP L3 Relay Service	672
Command Usage	672
Parameters	673
Web Interface	673
Configuring DHCP Relay Service with Option 82	673
Command Usage	674
Parameters	676
Web Interface	677
Enabling DHCP Dynamic Provision	677
Command Usage	677
Parameters	678
Web Interface	678
Configuring the DHCP Server	678
Command Usage	679
Enabling the Server	679
Parameters	679
Web Interface	679
Setting Excluded Addresses	680
Parameters	680

Web Interface	680
Configuring Address Pools	681
Command Usage	681
Parameters	682
Web Interface	683
Displaying Address Bindings	685
Parameters	685
Web Interface	685
DHCPv6 Relay	686
Command Usage	686
Parameters	686
Web Interface	687
Enabling DHCPv6 Dynamic Provision	688
Command Usage	688
Parameters	688
Web Interface	689
PPPoE Intermediate Agent	690
Configuring PPPoE IA Global Settings	690
Command Usage	690
Parameters	690
Web Interface	691
Configuring PPPoE IA Interface Settings	691
Parameters	691
Web Interface	693
Showing PPPoE IA Statistics	693
Parameters	693
Web Interface	694

Chapter 21. Appendices

Overview	695
Software Specifications	696
Software Features	696
Management Features	697
Standards	697
Management Information Bases	698
Troubleshooting	700
Problems Accessing the Management Interface	700
Using System Logs	701
License Information	702
The GNU General Public License	702
Preamble	702

Appendix

Safety Instructions	709
General	709
Rack Mounting	711
Consignes de sécurité	713

Général	713
Montage sur bâti	716
Technical Support	717
International	717
North America	717
Troubleshoot	718
Specifications	719
ATEN Standard Warranty Policy	721

About This Manual

This User Manual provides specific information about using the web interface to operate this switch.

Overview

Chapter 1, *Introduction*, introduces you to the 54-Port GbE (PoE) Managed Switch. Its purpose, features and benefits are presented, its front and rear panel components are described.

Chapter 2, *Installation*, provides hardware instructions for setting up the switch.

Chapters 3-21, describes the configurations available via the side menu of the web interface.

Appendix, at the end of the manual provides technical and troubleshooting information.

Note:

- ◆ Read this manual thoroughly and follow the installation and operation procedures carefully to prevent any damage to the unit or any connected devices.
 - ◆ The product may be updated, with features and functions added, improved or removed since the release of this manual. For an up-to-date user manual, visit <http://www.aten.com/global/en>
-

Conventions

This manual uses the following conventions:

- | | |
|---|--|
| Monospaced | Indicates text that you should key in. |
| [] | Indicates keys you should press. For example, [Enter] means to press the Enter key. If keys need to be chorded, they appear together in the same bracket with a plus sign between them: [Ctrl+Alt]. |
| 1. | Numbered lists represent procedures with sequential steps. |
| ◆ | Bullet lists provide information, but do not involve sequential steps. |
| > | Indicates selecting the option (on a menu or dialog box, for example), that comes next. For example, Start > Run means to open the <i>Start</i> menu, and then select <i>Run</i> . |
|  | Indicates critical information. |

This Page Intentionally Left Blank

Chapter 1

Introduction

Overview

The ES0154 / ES0154P 54-Port Layer 2+ Gigabit Ethernet Managed Switch is ideal for installation with ATEN KVM over IP products. It simplifies the process of building OT infrastructure with the ATEN KVM over IP series by eliminating the complexities of setup. It provides a high-performance 54-port configuration, a complete array of L2+ features, and advanced functionalities including Layer 3 static route, DHCP server, IPv6 support, and LLDP, making it a versatile solution for enhancing network performance. Both the ES0154 and the ES0154P offer a combination of SFP28 (fiber) and RJ-45 (copper) ports for servicing a range of network needs.

The ES0154 delivers 6 (1G/10G/25G) SFP28 and 48 (10M/100M/1G) RJ-45 ports, while the ES0154P supports 6 (1G/10G/25G) SFP28, 48 (10M/100M/1G) RJ-45 with PoE+ (Support 802.3at/af) ports, and PoE++ (Support 802.3bt) ports (41-48 ports only). The ES0154P is equipped with Power over Ethernet (PoE) functionality, featuring a substantial 740 Watts power budget distributed across its 48 RJ-45 ports. This eliminates the necessity for external power adapters and leads to a substantial reduction in power configuration expenses.

Deploying the ES0154 / ES0154P is quick and hassle-free. Its plug-and-play design eliminates the need for software installation or device configuration. Just connect the transmitters and receivers to the ES0154 / ES0154P using Cat 5e/6 cables. With a full range of functions to help with optimizing network efficiency, manageability and reliability for their network environment, the ES0154 / ES0154P serves as an ideal network switch solution. It is particularly valuable in applications where connected devices play a critical role in network operation, including OT infrastructure for both SMBs and enterprises.

Note: Please visit www.aten.com for compatible products.

Features

- ◆ Supports plug-and-play with KE, VE89 series devices
- ◆ Supports 48 Gigabit Ethernet ports and 6 SFP28 uplink ports (up to 25Gbps)
- ◆ High-performance Gigabit Ethernet L2+ access switch with 396 Gbps switching capacity – significantly improve the responsiveness of applications and file transfer times
- ◆ 802.3af PoE / 802.3at PoE+ / 802.3bt PoE++ (41-48 ports only) port configuration and scheduling
- ◆ Supports IGMP v1/v2/v3 Snooping and IGMP v1/v2 Querier
- ◆ Supports IGMP Snooping Fast Leave
- ◆ Supports Flow Control
- ◆ Comprehensive QoS – allowing the marking, classification, and scheduling of up to four traffic types across the network
- ◆ Enhanced Security – Port Security limits the total number of devices using a switch port and protects against MAC flooding attacks
- ◆ Supports IEEE 802.1w Rapid Spanning Tree Protocol – ensuring a faster recovery from failed links and enhancing overall network stability and reliability
- ◆ Supports IPv4, IPv6

Components

ES0154 Front View

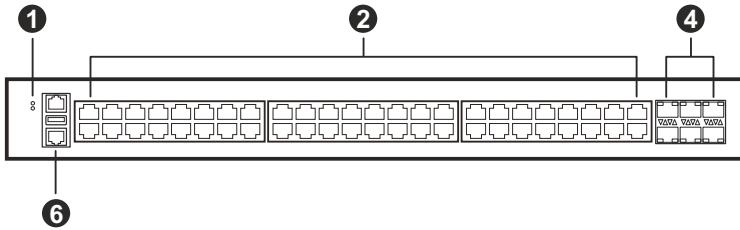

ES0154P Front View

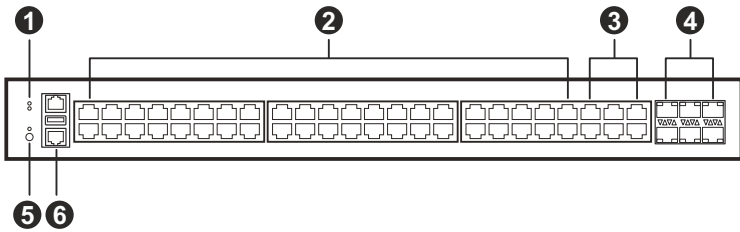

ES0154 Rear View



ES0154P Rear View

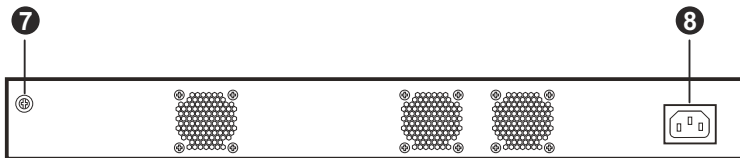

No.	Component	ES0152P
1	system and power LEDs	<ul style="list-style-type: none"> ◆ indicates if the switch is powered up correctly or not, or, indicates if there is a system alarm triggered for troubleshooting. Refer to <i>System LED</i> on page 5 for the behavior of the LED. ◆ When this LED is lit, the port status LEDs are displaying PoE powering status of each port. Refer to <i>Port Status LED</i> on page 5 for the behavior of the LED. Users can press the Mode button to toggle between Link/Activity/Speed mode and PoE mode.
2	10/100/1000M RJ-45 ports (ES0154) / 10/100/1000M RJ-45 PoE+ (IEEE 802.3at) ports (ES0154P)	
3	10/100/1000M RJ-45 PoE++ (IEEE 802.3bt) ports (ES0154P only)	
4	1/10/25G SFP28 ports	
5	PoE LED and mode button (ES0154P only)	<p>When this LED is lit, the port status LEDs are displaying the link status, network activity and speed of each port. Refer to <i>Port Status LED</i> on page 5 for the behavior of the LED.</p> <p>Users can press the Mode button to toggle between Link/Activity/Speed mode and PoE mode.</p> <p>By pressing the Mode/Reset Button for a different period of time, users can reset the switch, restore the switch to factory defaults, or change the display definition of port status LEDs (ES0152P only):</p> <ul style="list-style-type: none"> ◆ Restore to default: Press and hold the button for 7-12 seconds. The system LED will start blinking while all port status LEDs will stay on. ◆ Reset the switch: Press and hold the button for 2-7 seconds. The system LED will start blinking while all port status LEDs will turn off.
6	console ports (2 x RJ-45 / 1 x USB Type-A port)	Connect RJ-45 to DB-9 Serial Console Cable for CLI operation. Refer to the <i>CLI User Manual</i> for the CLI commands.
7	grounding terminal	Connects to a suitable grounding object.
8	power socket	Connect the provided power cord to this socket and an AC wall power socket to power the device.

System LED

Color	State	Description
green	on	The switch is powered ON correctly.
	off	The switch is not receiving power.
red	on	An abnormal state, such as exceeding operating temperature range, has been detected in the switch.

Port Status LED

The port status LED behavior is shown in the following table:

Port	Color	State	Description
RJ45 ports	green	on	The port is enabled and established a link to connected device, and the connection speed is 1000Mbps.
	green	blinking	The port is transmitting/receiving packets, and the connection speed is 1000Mbps.
	amber	on	The port is enabled and established a link to connected device, and the connection speed is 10/100Mbps.
	amber	blinking	The port is transmitting/receiving packets, and the connection speed is 10/100Mbps.
	--	off	The port has no active network cable connected, or it has not established a link to the connected device. Otherwise, the port may have been disabled through the switch user interface.
SFP28 ports	blue	on	The port is enabled and established a link to connected device, and the connection speed is 10Gbps.
	blue	blinking	The port is transmitting/receiving packets, and the connection speed is 10Gbps.
	green	on	The port is enabled and established a link to connected device, and the connection speed is 1Gbps.
	green	blinking	The port is transmitting/receiving packets, and the connection speed is 1Gbps.
	--	off	The port has no active network cable connected, or it has not established a link to the connected device. Otherwise, the port may have been disabled through the switch user interface.

■ When Link/Act/Speed LED is Lit (ES0154P only)

The behavior of the port status LED is the same as the table above.

■ When PoE LED is Lit (ES0154P only)

Port	Color	State	Description
RJ45 ports	green	on	The port is enabled and supplying power to the connected device.
	amber	on	An abnormal state, such as overload status, that has been detected in the switch.
	--	off	The port has no active network cable connected, or it is not connected a PoE PD device. Otherwise, the port may have been disabled through the switch user interface.

Web Interface

The features and functions of the switch can be configured and managed via the web interface, which are laid out in the chapters starting from Chapter 3 *Web Management - Introduction*.

Initial Configuration and Logging In

When powering up the switch for the first time, you can perform the initial switch configuration using the web interface.

To begin with the initial configuration stage, you need to reconfigure your PC's IP address and subnet mask to allow communication between your PC and the switch.

Factory default IP Address of the switch: 192.168.0.1

Factory default Subnet Mask of the switch: 255.255.255.0

Factory default Gateway of the switch: 192.168.0.254

After changing your PC's IP address (for example, 192.168.0.250), you can access the Web interface of the switch using the switch's default IP address (192.168.0.1).

The initial switch configuration procedure example, for a PC running Windows® 7/8.x/10, is as follows:

1. Type “*network and sharing*” into the **Search box** in the **Start Menu**.
2. Select **Network and Sharing Center**.
3. Click on **Change adapter settings** on the left of PC screen.

Note: Users can also skip step 1 to 3, by pressing **WinKey+R** and type “*ncpa.cpl*” command to get to step 4 directly.

4. Right-click on your local adapter and select **Properties**.
5. In the **Local Area Connection Properties** window highlight **Internet Protocol Version 4 (TCP/IPv4)** then click the **Properties** button.

Note: Record all your PC's current IP settings to be able to restore them later.

6. Select the radio button **Use the following IP address** and enter the IP for the PC (e.g. any IP address not in use, and in between *192.168.0.2* and *192.168.0.254*), Subnet mask (e.g. *255.255.255.0*), and Default gateway

that corresponds to your network setup. Then enter your Preferred and Alternate DNS server addresses.

7. Click **OK** to change the PC's IP address.
8. Open a web browser on the PC and enter the factory default IP address to access the switch's web interface.

Note: If you do not see the above login page, please try the following:

1. Refresh the web page.
 2. Check to see if there is an IP conflict issue.
 3. Clean browser cookies and temporary internet files.
 4. Check your PC settings again and repeat step 2.
-
9. Enter the username and password. The default username is administrator and the default password is password.
 10. Click "Login" to log into the switch.

Chapter 2 Installation

Mounting

Rack Mount

Follow the steps below to rack mount the device.

1. Attach the mounting brackets to both sides of the chassis. Insert screws and tighten them with a screwdriver to secure the brackets.

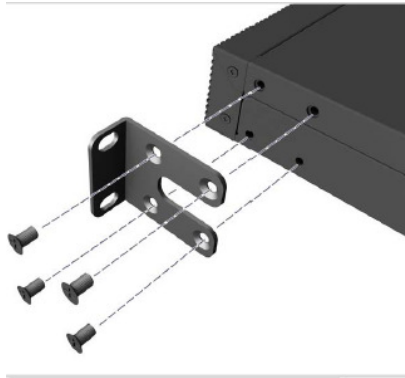

2. Place the switch on a rack shelf in the rack. Push it in until the oval holes in the brackets align with the mounting holes in the rack posts.



3. Attach the brackets to the posts. Insert screws and tighten them.

Desk Mount

1. It is recommended to verify that the desk/bench is sturdy for the device to be mounted on and that it is reliably grounded.
2. Attach the four adhesive rubber feet to the bottom of the switch.

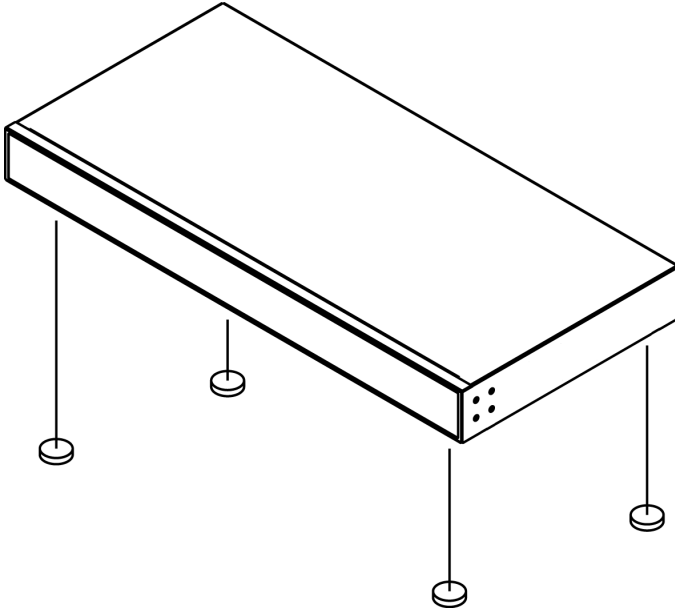

Installing SFP+/SFP28 Modules

As an option accessory for the SFP+/SFP28 ports, you can install a mini-GBIC SFP+ module. Since the connection capability of the SFP+/SFP28 ports is up to 10Gbps for SFP+ and 25Gbps for SFP28, you can choose mini-GBIC SFP+ modules able to support data rates of up to 10Gbps. You can install the module even while the switch is powered.

1. Insert the module into the SFP+/SFP28 port.
2. Press firmly to ensure that the module seats into the connector.

Hardware Installation

1. Use a grounding wire to ground the unit by connecting one end to the grounding terminal and the other end to a suitable grounded object.

Note: Do not omit this step. Proper grounding helps prevent damage to the unit from power surges or static electricity.

2. Connect the power cord to the unit's power socket.
3. Connect a CCKM server to the unit's 10/100/1000M RJ-45 port (ES0154) / 10/100/1000M RJ-45 PoE+ (IEEE 802.3at) port (ES0154P).
4. Connect up to 48 KE series extenders to the unit's 10/100/1000M RJ-45 ports (ES0154) / 10/100/1000M RJ-45 PoE+ (IEEE 802.3at) ports and 10/100/1000M RJ-45 PoE++ (IEEE 802.3bt) ports (ES0154P).

An example is shown:

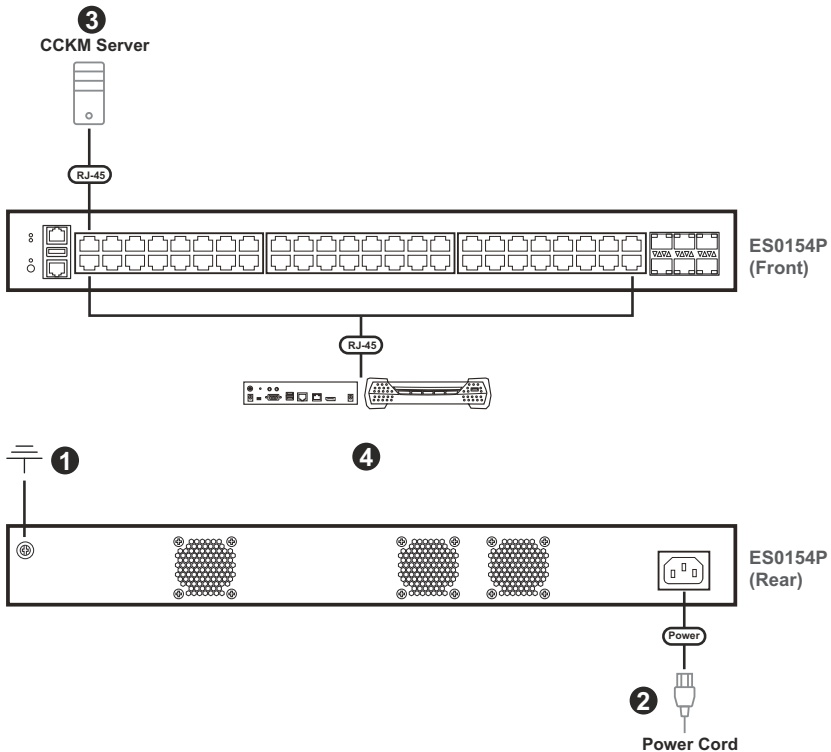

Chapter 3

Web Management - Introduction

Overview

This switch provides a broad range of features for Layer 2 switching. It includes a management agent that allows you to configure the features listed in this manual. The default configuration can be used for most of the features provided by this switch. However, there are many options that you should configure to maximize the switch's performance for your particular network environment.

Key Features

Feature	Description
Configuration Backup and Restore	Using management station or FTP/SFTP/SCP/TFTP server
Authentication	<ul style="list-style-type: none">◆ Console, Telnet, web – user name/password, RADIUS, TACACS+◆ Port – IEEE 802.1X, MAC address filtering◆ SNMP v1/2c - Community strings◆ SNMP version 3 – MD5 or SHA password◆ Telnet – SSH◆ Web – HTTPS
General Security Measures	<ul style="list-style-type: none">◆ AAA◆ ARP inspection◆ DHCP Snooping (with Option 82 relay information)◆ DoS Protection◆ IP Source Guard◆ PPPoE Intermediate Agent◆ Port Authentication – IEEE 802.1X◆ Port Security – MAC address filtering
Access Control Lists	Supports up to 1024 rules (global share), 64 ACLs, and a maximum of 1024 rules for an ACL
DHCP/DHCPv6	Client, Relay Option 82
DNS	Client and Proxy service
Port Configuration	Speed, duplex mode, and flow control
Port Trunking	Supports up to 28 trunks – static or dynamic trunking (LACP)

Feature	Description
Port Mirroring	6 sessions, one or more source ports to one analysis port
Congestion Control	<ul style="list-style-type: none"> ◆ Rate Limiting ◆ Throttling for broadcast, multicast, unknown unicast storms
Address Table	16K MAC addresses in the forwarding table (shared for L2, multicast, Router IPv4/IPv6 host entries), 1K static MAC addresses, 2K L2 multicast groups
IP Version 4 and 6	Supports IPv4 and IPv6 addressing, and management
IEEE 802.1D Bridge	Supports dynamic data switching and addresses learning
Store-and-Forward Switching	Supported to ensure wire-speed switching while eliminating bad frames
Spanning Tree Algorithm	Supports standard STP, Rapid Spanning Tree Protocol (RSTP), and Multiple Spanning Trees (MSTP)
Virtual LANs	Up to 4094 using IEEE 802.1Q, port-based, protocol-based, voice VLANs, and QinQ tunnel
Traffic Prioritization	Default port priority, traffic class map, queue scheduling, IP Precedence, or Differentiated Services Code Point (DSCP)
Quality of Service	Supports Differentiated Services (DiffServ)
Link Layer Discovery Protocol	Used to discover basic information about neighboring devices
Switch Clustering	Supports up to 36 member switches in a cluster
ERPS	Supports Ethernet Ring Protection Switching for increased availability of Ethernet rings (G.8032)
Multicast Filtering	Supports IGMP snooping and query and Multicast VLAN Registration
Remote Device Management	Supports Ethernet OAM functions for attached CPEs (IEEE 802.3ah)

Description of Software Features

The switch provides a wide range of advanced performance enhancing features. Flow control eliminates the loss of packets due to bottlenecks caused by port saturation. Storm suppression prevents broadcast traffic storms from engulfing the network. Untagged (port-based), tagged, and protocol-based VLANs, plus support for automatic GVRP VLAN registration provide traffic security and efficient use of network bandwidth. CoS priority queuing ensures the minimum delay for moving real-time multimedia data across the network. While multicast filtering provides support for real-time network applications.

Some of the management features are briefly described below.

Configuration Backup and Restore

You can save the current configuration settings to a file on the management station (using the web interface) or an FTP/SFTP/SCP/TFTP server (using the web or console interface), and later download this file to restore the switch configuration settings.

Authentication

This switch authenticates management access via the console port, Telnet, or a web browser. User names and passwords can be configured locally or can be verified via a remote authentication server (i.e., RADIUS or TACACS+). Port-based authentication is also supported via the IEEE 802.1X protocol. This protocol uses Extensible Authentication Protocol over LANs (EAPOL) to request user credentials from the 802.1X client, and then uses the EAP between the switch and the authentication server to verify the client's right to access the network via an authentication server (i.e., RADIUS or TACACS+ server).

Other authentication options include HTTPS for secure management access via the web, SSH for secure management access over a Telnet-equivalent connection, SNMP Version 3, IP address filtering for SNMP/Telnet/web management access. MAC address filtering and IP source guard also provide authenticated port access. DHCP snooping is provided to prevent malicious attacks from insecure ports. While PPPoE Intermediate Agent supports authentication of a client for a service provider.

Access Control Lists

ACLs provide packet filtering for IP frames (based on address, protocol, TCP/UDP port number or TCP control code) or any frames (based on MAC address or Ethernet type). ACLs can be used to improve performance by blocking unnecessary network traffic or to implement security controls by restricting access to specific network resources or protocols.

DHCP Relay

DHCP Relay is supported to allow dynamic configuration of local clients from a DHCP server located in a different network. And DHCP Relay Option 82 controls the processing of Option 82 information in DHCP request packets relayed by this device.

Port Configuration

You can manually configure the speed, duplex mode, and flow control used on specific ports, or use auto-negotiation to detect the connection settings used by the attached device. Use full-duplex mode on ports whenever possible to double the throughput of switch connections. Flow control should also be enabled to control network traffic during periods of congestion and prevent the loss of packets when port buffer thresholds are exceeded. The switch supports flow control based on the IEEE 802.3x standard (now incorporated in IEEE 802.3-2002).

Rate Limiting

This feature controls the maximum rate for traffic transmitted or received on an interface. Rate limiting is configured on interfaces at the edge of a network to limit traffic into or out of the network. Packets that exceed the acceptable amount of traffic are dropped.

Port Mirroring

The switch can unobtrusively mirror traffic from any port to a monitor port. You can then attach a protocol analyzer or RMON probe to this port to perform traffic analysis and verify connection integrity.

Port Trunking

Ports can be combined into an aggregate connection. Trunks can be manually set up or dynamically configured using Link Aggregation Control Protocol (LACP – IEEE 802.3-2005). The additional ports dramatically increase the throughput across any connection, and provide redundancy by taking over the load if a port in the trunk should fail. The switch supports up to 28 trunks.

Storm Control

Broadcast, multicast and unknown unicast storm suppression prevents traffic from overwhelming the network. When enabled on a port, the level of traffic passing through the port is restricted. If traffic rises above a pre-defined threshold, it will be throttled until the level falls back beneath the threshold.

Static MAC Address

A static address can be assigned to a specific interface on this switch. Static addresses are bound to the assigned interface and will not be moved. When a static address is seen on another interface, the address will be ignored and will not be written to the address table. Static addresses can be used to provide network security by restricting access for a known host to a specific port.

IP Address Filtering

Access to insecure ports can be controlled using DHCP Snooping which filters ingress traffic based on static IP addresses and addresses stored in the DHCP Snooping table. Traffic can also be restricted to specific source IP addresses or source IP/MAC address pairs based on static entries or entries stored in the DHCP Snooping table.

IEEE 802.1D Bridge

The switch supports IEEE 802.1D transparent bridging. The address table facilitates data switching by learning addresses, and then filtering or forwarding traffic based on this information. The address table supports up to 16K addresses.

Store-and-Forward Switching

The switch copies each frame into its memory before forwarding them to another port. This ensures that all frames are a standard Ethernet size and have been verified for accuracy with the cyclic redundancy check (CRC). This prevents bad frames from entering the network and wasting bandwidth.

To avoid dropping frames on congested ports, the switch provides 4 Mbits for frame buffering. This buffer can queue packets awaiting transmission on congested networks.

Spanning Tree Algorithm

The switch supports these spanning tree protocols:

- ◆ Spanning Tree Protocol (STP, IEEE 802.1D) – This protocol provides loop detection. When there are multiple physical paths between segments, this protocol will choose a single path and disable all others to ensure that only one route exists between any two stations on the network. This prevents the creation of network loops. However, if the chosen path should fail for any reason, an alternate path will be activated to maintain the connection.

- ◆ Rapid Spanning Tree Protocol (RSTP, IEEE 802.1w) – This protocol reduces the convergence time for network topology changes to about 3 to 5 seconds, compared to 30 seconds or more for the older IEEE 802.1D STP standard. It is intended as a complete replacement for STP, but can still interoperate with switches running the older standard by automatically reconfiguring ports to STP-compliant mode if they detect STP protocol messages from attached devices.
- ◆ Multiple Spanning Tree Protocol (MSTP, IEEE 802.1s) – This protocol is a direct extension of RSTP. It can provide an independent spanning tree for different VLANs. It simplifies network management, provides for even faster convergence than RSTP by limiting the size of each region, and prevents VLAN members from being segmented from the rest of the group (as sometimes occurs with IEEE 802.1D STP).

Virtual LANs

The switch supports up to 4094 VLANs. A Virtual LAN is a collection of network nodes that share the same collision domain regardless of their physical location or connection point in the network. The switch supports tagged VLANs based on the IEEE 802.1Q standard. Members of VLAN groups can be dynamically learned via GVRP, or ports can be manually assigned to a specific set of VLANs. This allows the switch to restrict traffic to the VLAN groups to which a user has been assigned. By segmenting your network into VLANs, you can:

- ◆ Eliminate broadcast storms which severely degrade performance in a flat network.
- ◆ Simplify network management for node changes/moves by remotely configuring VLAN membership for any port, rather than having to manually change the network connection.
- ◆ Provide data security by restricting all traffic to the originating VLAN, except where a connection is explicitly defined via the switch's routing service.
- ◆ Use protocol VLANs to restrict traffic to specified interfaces based on protocol type.

IEEE 802.1Q Tunneling (QinQ)

This feature is designed for service providers carrying traffic for multiple customers across their networks. QinQ tunneling is used to maintain customer-specific VLAN and Layer 2 protocol configurations even when different customers use the same internal VLAN IDs. This is accomplished by inserting Service Provider VLAN (SPVLAN) tags into the customer's frames when they enter the service provider's network, and then stripping the tags when the frames leave the network.

Traffic Prioritization

This switch prioritizes each packet based on the required level of service, using eight priority queues with strict priority, Weighted Round Robin (WRR) scheduling, or a combination of strict and weighted queuing. It uses IEEE 802.1p and 802.1Q tags to prioritize incoming traffic based on input from the end-station application. These functions can be used to provide independent priorities for delay-sensitive data and best-effort data.

This switch also supports several common methods of prioritizing layer 3/4 traffic to meet application requirements. Traffic can be prioritized based on the priority bits in the IP frame's Type of Service (ToS) octet using DSCP, or IP Precedence. When these services are enabled, the priorities are mapped to a Class of Service value by the switch, and the traffic then sent to the corresponding output queue.

Quality of Service

Differentiated Services (DiffServ) provides policy-based management mechanisms used for prioritizing network resources to meet the requirements of specific traffic types on a per-hop basis. Each packet is classified upon entry into the network based on access lists, IP Precedence or DSCP values, or VLAN lists. Using access lists allows you select traffic based on Layer 2, Layer 3, or Layer 4 information contained in each packet. Based on network policies, different kinds of traffic can be marked for different kinds of forwarding.

Ethernet Ring Protection Switching

ERPS can be used to increase the availability and robustness of Ethernet rings, such as those used in Metropolitan Area Networks (MAN). ERPS provides Layer 2 loop avoidance and fast reconvergence in Layer 2 ring topologies, supporting up to 255 nodes in the ring structure.

Operation, Administration, and Maintenance

The switch provides OAM remote management tools required to monitor and maintain the links to subscriber CPEs (Customer Premise Equipment). This section describes functions including enabling OAM for selected ports, loopback testing, and displaying remote device information.

Multicast Filtering

Specific multicast traffic can be assigned to its own VLAN to ensure that it does not interfere with normal network traffic and to guarantee real-time delivery by setting the required priority level for the designated VLAN. The switch uses IGMP Snooping and Query for IPv4, and MLD Snooping and Query for IPv6 to manage multicast group registration. It also supports Multicast VLAN Registration (MVR for IPv4) which allows common multicast traffic, such as television channels, to be transmitted across a single network-wide multicast VLAN shared by hosts residing in other standard or private VLAN groups, while preserving security and data isolation for normal traffic.

Link Layer Discovery Protocol

LLDP is used to discover basic information about neighboring devices within the local broadcast domain. LLDP is a Layer 2 protocol that advertises information about the sending device and collects information gathered from neighboring network nodes it discovers.

Advertised information is represented in Type Length Value (TLV) format according to the IEEE 802.1ab standard, and can include details such as device identification, capabilities and configuration settings. Media Endpoint Discovery (LLDP-MED) is an extension of LLDP intended for managing endpoint devices such as Voice over IP phones and network switches. The LLDP-MED TLVs advertise information such as network policy, power, inventory, and device location details. The LLDP and LLDP-MED information can be used by SNMP applications to simplify troubleshooting, enhance network management, and maintain an accurate network topology.

System Defaults

The switch's system defaults are provided in the configuration file "Factory_Default_Config.cfg." To reset the switch defaults, this file should be set as the startup configuration file.

The following table lists some of the basic system defaults.

Function	Parameter	Default
Console Port Connection	Baud Rate	115200 bps
	Data Bits	8
	Stop Bits	1
	Parity	none
	Local Console Timeout	0 (disabled)
Authentication and Security Measures	Privileged Exec Level	Username "administrator" Password "password"
	Normal Exec Level	Username "guest" Password "guest"
	Enable Privileged Exec from Normal Exec Level	Password "super"
	RADIUS Authentication	Disabled
	TACACS+ Authentication	Disabled
	802.1X Port Authentication	Disabled
	Web Authentication	Disabled
	MAC Authentication	Disabled
	PPPoE Intermediate Agent	Disabled
	HTTPS	Enabled
	SSH	Disabled
	Port Security	Disabled
	IP Filtering	Disabled
	DHCP Snooping	Disabled
IP Source Guard	Disabled (all ports)	
Web Management	HTTP Server	Enabled
	HTTP Port Number	80
	HTTP Secure Server	Enabled
	HTTP Secure Server Port	443

Function	Parameter	Default
SNMP	SNMP Agent	Enabled
	Community Strings	"public" (read only) "private" (read/write)
	Traps	Authentication traps: enabled Link-up-down events: enabled
	SNMP V3	View: defaultview Group: public (read only); private (read/write)
Port Configuration	Admin Status	Enabled
	Auto-negotiation	Enabled
	Flow Control	Enabled
Port Trunking	Static Trunks	None
	LACP (all ports)	1-48 Port : Disabled 49-54 Port : Enabled
Congestion Control	Rate Limiting	Disabled
	Storm Control	Broadcast: Enabled (64 kbits/sec) Multicast: Disabled Unknown Unicast: Disabled
	Auto Traffic Control	Disabled
Address Table	Aging Time	300 seconds
Spanning Tree Algorithm	Status	Disabled (Defaults: RSTP standard)
	Edge Ports	Disabled
LLDP	Status	Enabled
ERPS	Status	Disabled
OAM	Status	Disabled
Virtual LANs	Default VLAN	1
	PVID	1
	Acceptable Frame Type	All
	Ingress Filtering	Disabled
	Switch Port Mode (Egress Mode)	Hybrid
	GVRP (global)	Disabled
	GVRP (port interface)	Disabled
QinQ Tunneling	Disabled	

Function	Parameter	Default
Traffic Prioritization	Ingress Port Priority	0
	Queue Mode	WRR
	Queue Weight	Queue: 0 1 2 3 4 5 6 7 Weight: 1 2 4 6 8 10 12 14
	Class of Service	Enabled
	IP Precedence Priority	Disabled
	IP DSCP Priority	Disabled
IP Settings	Management VLAN	VLAN 1
	IP Address	192.168.0.1
	Subnet Mask	255.255.255.0
	Default Gateway	Not configured
	DHCP	Client: Disabled
	DNS	Proxy service: Disabled
	BOOTP	Disabled
Multicast Filtering	IGMP Snooping (Layer 2)	Snooping: Enabled Querier: Enabled
	MLD Snooping (Layer 2 IPv6)	Snooping: Enabled Querier: Enabled
	Multicast VLAN Registration	Enabled
	IGMP Proxy Reporting	Enabled
System Log	Status	Enabled
	Messages Logged to RAM	Levels 0-7 (all)
	Messages Logged to Flash	Levels 0-3
SMTP Email Alerts	Event Handler	Enabled (but no server defined)
SNTP	Clock Synchronization	Disabled

Web Configuration

The following chapters describes the basic switch features, along with a detailed description of how to configure each feature via a web browser.

These Chapters are:

- Chapter 4**, *Using the Web Interface*, see page 25.
- Chapter 5**, *Basic Management Tasks*, see page 53.
- Chapter 6**, *Interface Configuration*, see page 91.
- Chapter 7**, *VLAN Configuration*, see page 149.
- Chapter 8**, *Address Table Settings*, see page 189.
- Chapter 9**, *Spanning Tree Algorithm*, see page 201.
- Chapter 10**, *Congestion Control*, see page 227.
- Chapter 11**, *Class of Service*, see page 237.
- Chapter 12**, *Quality of Service*, see page 255.
- Chapter 13**, *VoIP Traffic Configuration*, see page 271.
- Chapter 14**, *Security Measures*, see page 279.
- Chapter 15**, *Basic Administration Protocols*, see page 407.
- Chapter 16**, *Multicast Filtering*, see page 543.
- Chapter 17**, *IP Tools*, see page 613.
- Chapter 18**, *IP Configuration*, see page 625.
- Chapter 19**, *General IP Routing*, see page 653.
- Chapter 20**, *IP Services*, see page 661.

Chapter 4

Using the Web Interface

Overview

This switch provides an embedded HTTP web agent. Using a web browser you can configure the switch and view statistics to monitor network activity. The web agent can be accessed by any computer on the network using a standard web browser.

Note: You can also use the Command Line Interface (CLI) to manage the switch over a serial connection to the console port or via Telnet. For more information on using the CLI, refer to the *CLI Reference Guide*.

Connecting to the Web Interface

Prior to accessing the switch from a web browser, be sure you have first performed the following tasks:

1. The default IP address and subnet mask for the switch is 192.168.0.1 and 255.255.255.0, with no default gateway. If this is not compatible with the subnet connected to the switch, you can configure it with a valid IP address, subnet mask, and default gateway. To configure this device as the default gateway, use the IP > Routing > Static Routes (Add) page, set the destination address to the required interface, and the next hop to null address 0.0.0.0.
2. After you have logged in for the first time, you will be asked to change the password for security purpose, please follow the on-screen instructions to setup your new password.
3. Set user names and passwords using an out-of-band serial connection. Access to the web agent is controlled by the same user names and passwords as the onboard configuration program.
4. After you enter a user name and password, you will have access to the system configuration program.

Note:

- ◆ You are allowed three attempts to enter the correct password; on the third failed attempt the current connection is terminated.

- If you log into the web interface as guest (Normal Exec level), you can view the configuration settings or change the guest password. If you log in as “administrator” (Privileged Exec level), you can change the settings on any page.
- If the path between your management station and this switch does not pass through any device that uses the Spanning Tree Algorithm, then you can set the switch port attached to your management station to fast forwarding (i.e., enable Admin Edge Port) to improve the switch’s response time to management commands issued through the web interface.
- Users are automatically logged off of the HTTP server or HTTPS server if no input is detected for 600 seconds.
- Connection to the web interface is not supported for HTTPS using an IPv6 link local address.

Navigating the Web Browser Interface

To access the web-browser interface you must first enter a user name and password. The administrator has Read/Write access to all configuration parameters and statistics. The default user name and password for the administrator is “administrator.” The administrator has full access privileges to configure any parameters in the web interface. The default user name and password for guest access is “guest.” The guest only has read access for most configuration parameters.

Dashboard

When your web browser connects with the switch’s web agent, the Dashboard is displayed as shown below. The Dashboard displays the main menu on the left side of the screen and System Information, CPU Utilization, Temperature, and Top 5 Most Active Interfaces on the right side. The main menu links are used to navigate to other menus, and display configuration parameters and statistics.

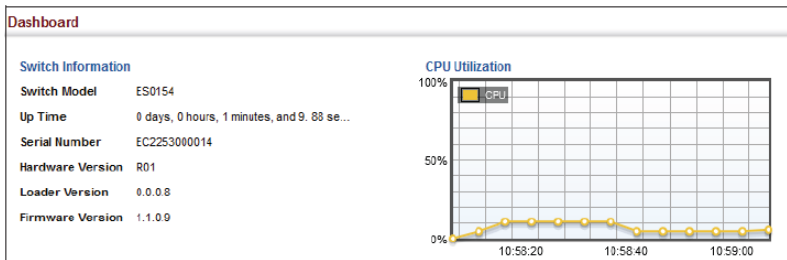









Configuration Options

Configurable parameters have a dialog box or a drop-down list. Once a configuration change has been made on a page, be sure to click on the Apply button to confirm the new setting. The following table summarizes the web page configuration buttons.

Button	Action
Apply	Sets specified values to the system.

Button	Action
Revert	Cancels specified values and restores current values prior to pressing "Apply."
	Saves current settings.
	Displays help for the selected page.
	Refreshes the current page.
	Displays the site map.
	Logs out of the management interface.
	Sends mail to the vendor.
	Links to the vendor's web site.

Panel Display

The web agent displays an image of the switch's ports. The Mode can be set to display different information for the ports, including Active (i.e., up or down), Duplex (i.e., half or full duplex), or Flow Control (i.e., with or without flow control).

Note:

- ◆ This manual covers the ES0154 Gigabit Ethernet switch. Other than the difference in the number of ports and the support for PoE on the ES0154P,

there are no significant differences. Therefore, the screen display examples in this manual might be based on any of the switch models in this series.

- ◆ You can open a connection to the vendor's web site by clicking on the ATEN logo.

Main Menu

Using the onboard web agent, you can define system parameters, manage and control the switch, and all its ports, or monitor network conditions. The following table briefly describes the selections available from this program.

Menu	Sub Menu	Description	Page	
Dashboard		Displays system information, CPU utilization, temperature, and top 5 most active interfaces		
System	General	Provides basic system description, including contact information		
	Switch	Shows the number of ports, hardware version, power status, and firmware version numbers		
	Capability	Enables support for jumbo frames; shows the bridge extension parameters		
	File			
	Copy	Allows the transfer and copying files		
	Automatic Operation Code Upgrade	Automatically upgrades operation code if a newer version is found on the server		
	Set Startup	Sets the startup file		
	Show	Shows the files stored in flash memory; allows deletion of files		
	Time			
	Manual	Manually sets the current time		
	SNTP	Configures SNTP polling interval		
	NTP	Configures NTP authentication parameters		
	Configure Time Server	Configures a list of SNTP servers		

Menu	Sub Menu	Description	Page
	Configure SNTP Server	Sets the IP address for SNTP time servers	
	Add NTP Server	Adds NTP time server and index of authentication key	
	Show NTP Server	Shows list of configured NTP time servers	
	Add NTP Authentication Key	Adds key index and corresponding MD5 key	
	Show NTP Authentication Key	Shows list of configured authentication keys	
	Configure Time Zone	Sets the local time zone for the system clock	
	Configure Summer Time	Configures summer time settings	
Console		Sets console port connection parameters	
Telnet		Sets Telnet connection parameters	
CPU Utilization		Displays information on CPU utilization	
CPU Guard		Sets the CPU utilization watermark and threshold	
Memory Status		Shows memory utilization parameters	
Reset		Restarts the switch immediately, at a specified time, after a specified delay, or at a periodic interval	
Interface			
	Port		
	General		
	Configure by Port List	Configures connection settings per port	
	Configure by Port Range	Configures connection settings for a range of ports	
	Show Information	Displays port connection status	
	Statistics	Shows Interface, Etherlike, and RMON port statistics	
	Chart	Shows Interface, Etherlike, and RMON port statistics	
	History	Shows statistical history for specified interfaces	

Menu	Sub Menu	Description	Page
	Transceiver	Shows identifying information and operational parameters for optical transceivers which support Digital Diagnostic Monitoring (DDM), and configures thresholds for alarm and warning messages for optical transceivers which support DDM	
	Cable Test	Performs cable diagnostics for selected port to diagnose any cable faults (short, open etc.) and report the cable length	
	Trunk		
	Static		
	Configure Trunk		
	Add	Creates a trunk, along with the first port member	
	Show	Shows the configured trunk identifiers	
	Add Member	Specifies ports to group into static trunks	
	Show Member	Shows the port members for the selected trunk	
	Configure General		
	Configure	Configures trunk connection settings	
	Show Information	Displays trunk connection settings	
	Dynamic		
	Configure Aggregator	Configures administration key and timeout for specific LACP groups	
	Configure Aggregation Port		
	Configure		
	General	Allows ports to dynamically join trunks	
	Actor	Configures parameters for link aggregation group members on the local side	
	Partner	Configures parameters for link aggregation group members on the remote side	
	Show Information		
	Counters	Displays statistics for LACP protocol messages	
	Internal	Displays configuration settings and operational state for the local side of a link aggregation	
	Neighbors	Displays configuration settings and operational state for the remote side of a link aggregation	

Menu	Sub Menu	Description	Page
	Configure Trunk		
	Configure	Configures connection settings	
	Show	Displays port connection status	
	Show Member	Shows the active members in a trunk	
	Statistics	Shows Interface, Etherlike, and RMON port statistics	
	Chart	Shows Interface, Etherlike, and RMON port statistics	
	Load Balance	Sets the load-distribution method among ports in aggregated links	
	History	Shows statistical history for specified interfaces	
	Green Ethernet	Adjusts the power provided to ports based on the length of the cable used to connect to other devices	
	Mirror		
	Add	Sets the source and target ports for mirroring	
	Show	Shows the configured mirror sessions	
	RSPAN	Mirrors traffic from remote switches for analysis at a destination port on the local switch	
	sFlow	Configures flow sampling for receiver ports and instances	
	Configure Receiver	Creates an sFlow receiver on the switch	
	Configure Details	Enable an sFlow polling data source that polls periodically based on a specified time interval, or an sFlow data source instance that takes samples periodically based on the number of packets processed	
	Traffic Segmentation		
	Configure Global	Enables traffic segmentation globally	
	Configure Session	Configures the uplink and down-link ports for a segmented group of ports	
	VLAN Trunking	Allows unknown VLAN groups to pass through the specified interface	
VLAN		Virtual LAN	
	Static		
	Add	Creates VLAN groups	
	Show	Displays configured VLAN groups	

Menu	Sub Menu	Description	Page
	Modify	Configures group name and administrative status	
	Edit Member by VLAN	Specifies VLAN attributes per VLAN	
	Edit Member by Interface	Specifies VLAN attributes per interface	
	Edit Member by Interface Range	Specifies VLAN attributes per interface range	
	Dynamic		
	Configure General	Enables GVRP VLAN registration protocol globally	
	Configure Interface	Configures GVRP status and timers per interface	
	Show Dynamic VLAN		
	Show VLAN	Shows the VLANs this switch has joined through GVRP	
	Show VLAN Member	Shows the interfaces assigned to a VLAN through GVRP	
	Tunnel	IEEE 802.1Q (QinQ) Tunneling	
	Configure Global	Sets tunnel mode for the switch	
	Configure Service	Sets a CVLAN to SPVLAN mapping entry	
	Configure Interface	Sets the tunnel mode for any participating interface	
	L2PT	Layer 2 Protocol Tunneling	
	Configure Global	Configures the destination MAC address for L2PT	
	Configure Interface	Enables L2PT on selected interfaces	
	Protocol		
	Configure Protocol		
	Add	Creates a protocol group, specifying supported protocols	
	Show	Shows configured protocol groups	
	Configure Interface		
	Add	Maps a protocol group to a VLAN	

Menu	Sub Menu	Description	Page
	Show	Shows the protocol groups mapped to each VLAN	
	IP Subnet		
	Add	Maps IP subnet traffic to a VLAN	
	Show	Shows IP subnet to VLAN mapping	
	MAC-Based		
	Add	Maps traffic with specified source MAC address to a VLAN	
	Show	Shows source MAC address to VLAN mapping	
	Mirror	Configures VLAN traffic mirroring	
	Translation		
	Add	Maps VLAN IDs between the customer and service provider	
	Show	Displays the configuration settings for VLAN translation	
MAC Address			
	Dynamic		
	Configure Aging	Sets timeout for dynamically learned entries	
	Show Dynamic MAC	Displays dynamic entries in the address table	
	Clear Dynamic MAC	Removes any learned entries from the forwarding database and clears the transmit and receive counts for any static or system configured entries	
	Learning Status	Enables MAC address learning on selected interfaces	
	Static	Configures static MAC addresses	
	Mirror	Configures MAC address mirroring	
	MAC Notification		
	Configure Global	Issues a trap when a dynamic MAC address is added or removed	
	Configure Interface	Enables MAC authentication traps on the current interface	
Spanning Tree			
	Loopback Detection	Configures Loopback Detection parameters	
	STA	Spanning Tree Algorithm	

Menu	Sub Menu	Description	Page
	Configure Global		
	Configure	Configures global bridge settings for STP, RSTP and MSTP	
	Show Information	Displays STA values used for the bridge	
	Configure Interface		
	Configure	Configures interface settings for STA	
	Show Information	Displays interface settings for STA	
	MSTP	Multiple Spanning Tree Algorithm	
	Configure Global		
	Add	Configures initial VLAN and priority for an MST instance	
	Modify	Configures the priority or an MST instance	
	Show	Configures global settings for an MST instance	
	Add Member	Adds VLAN members for an MST instance	
	Show Member	Adds or deletes VLAN members for an MST instance	
	Show Information	Displays MSTP values used for the bridge	
	Configure Interface		
	Configure	Configures interface settings for an MST instance	
	Show Information	Displays interface settings for an MST instance	
Traffic	Rate Limit	Sets the input and output rate limits for a port	
	Storm Control	Sets the broadcast storm threshold for each interface	
	Auto Traffic Control	Sets thresholds for broadcast and multicast storms which can be used to trigger configured rate limits or to shut down a port	
	Configure Global	Sets the time to apply the control response after traffic has exceeded the upper threshold, and the time to release the control response after traffic has fallen beneath the lower threshold	

Menu	Sub Menu	Description	Page
	Configure Interface	Sets the storm control mode (broadcast or multicast), the traffic thresholds, the control response, to automatically release a response of rate limiting, or to send related SNMP trap messages	
	Priority		
	Default Priority	Sets the default priority for each port or trunk	
	Queue	Sets queue mode for the switch; sets the service weight for each queue that will use a weighted or hybrid mode	
	Trust Mode	Selects DSCP or CoS priority processing	
	DSCP to DSCP	Maps DSCP values in incoming packets to per-hop behavior and drop precedence values for internal priority processing	
	Cos to DSCP	Maps CoS/CFI values in incoming packets to per-hop behavior and drop precedence values for priority processing	
	IP Precedence to DSCP	Maps IP Precedence values to DSCP values	
	PHB to Queue	Maps internal per-hop behavior values to hardware queues	
	DiffServ		
	Configure Class		
	Add	Creates a class map for a type of traffic	
	Show	Shows configured class maps	
	Modify	Modifies the name of a class map	
	Add Rule	Configures the criteria used to classify ingress traffic	
	Show Rule	Shows the traffic classification rules for a class map	
	Configure Policy		
	Add	Creates a policy map to apply to multiple interfaces	
	Show	Shows configured policy maps	
	Modify	Modifies the name of a policy map	
	Add Rule	Sets the boundary parameters used for monitoring inbound traffic, and the action to take for conforming and non-conforming traffic	
	Show Rule	Shows the rules used to enforce bandwidth policing for a policy map	

Menu	Sub Menu	Description	Page
	Configure Interface	Applies a policy map to an ingress port	
	VoIP	Voice over IP	
	Configure Global	Configures auto-detection of VoIP traffic, sets the Voice VLAN, and VLAN aging time	
	Configure OUI		
	Add	Maps the OUI in the source MAC address of ingress packets to the VoIP device manufacturer	
	Show	Shows the OUI telephony list	
	Configure Interface	Configures VoIP traffic settings for ports, including the way in which a port is added to the Voice VLAN, filtering of non-VoIP packets, the method of detecting VoIP traffic, and the priority assigned to the voice traffic	
Security			
	AAA	Authentication, Authorization and Accounting	
	System Authentication	Configures authentication sequence – local, RADIUS, and TACACS	
	Server		
	Configure Server	Configures RADIUS and TACACS server message exchange settings	
	Configure Group		
	Add	Specifies a group of authentication servers and sets the priority sequence	
	Show	Shows the authentication server groups and priority sequence	
	Accounting	Enables accounting of requested services for billing or security purposes	
	Configure Global	Specifies the interval at which the local accounting service updates information to the accounting server	
	Configure Method		
	Add	Configures accounting for various service types	
	Show	Shows the accounting settings used for various service types	
	Configure Service	Sets the accounting method applied to specific interfaces for 802.1X, CLI command privilege levels for the console port, and for Telnet	

Menu	Sub Menu	Description	Page
	Show Information		
	Summary	Shows the configured accounting methods, and the methods applied to specific interfaces	
	Statistics	Shows basic accounting information recorded for user sessions	
	Authorization	Enables authorization of requested services	
	Configure Method		
	Add	Configures authorization for various service types	
	Show	Shows the authorization settings used for various service types	
	Configure Service	Sets the authorization method applied used for the console port, and for Telnet	
	Show Information	Shows the configured authorization methods, and the methods applied to specific interfaces	
	User Accounts		
	Add	Configures user names, passwords, and access levels	
	Show	Shows authorized users	
	Modify	Modifies user attributes	
	Web Authentication	Allows authentication and access to the network when 802.1X or Network Access authentication are infeasible or impractical	
	Configure Global	Configures general protocol settings	
	Configure Interface	Enables Web Authentication for individual ports	
	Network Access	MAC address-based network access authentication	
	Configure Global	Enables aging for authenticated MAC addresses, and sets the time period after which a connected MAC address must be reauthenticated	
	Configure Interface		
	General	Enables MAC authentication on a port; sets the maximum number of address that can be authenticated, the guest VLAN, dynamic VLAN and dynamic QoS	
	Configure MAC Filter		

Menu	Sub Menu	Description	Page
	Add	Specifies MAC addresses exempt from authentication	
	Show	Shows the list of exempt MAC addresses	
	Show Information	Shows the authenticated MAC address list	
	HTTPS	Secure HTTP	
	Configure Global	Enables HTTPSs, and specifies the UDP port to use	
	Copy Certificate	Replaces the default secure-site certificate	
	SSH	Secure Shell	
	Configure Global	Configures SSH server settings	
	Configure Host Key		
	Generate	Generates the host key pair (public and private)	
	Show	Displays RSA host keys; deletes host keys	
	Configure User Key		
	Copy	Imports user public keys from a TFTP server	
	Show	Displays RSA user keys; deletes user keys	
	ACL	Access Control Lists	
	Configure ACL		
	Show TCAM	Shows utilization parameters for TCAM	
	Add	Adds an ACL based on IP or MAC address filtering	
	Show	Shows the name and type of configured ACLs	
	Add Rule	Configures packet filtering based on IP or MAC addresses and other packet attributes	
	Show Rule	Shows the rules specified for an ACL	
	Configure Interface	Binds a port to the specified ACL and time range	
	Configure	Binds a port to the specified ACL and time range	
	Show Hardware Counters	Shows statistics for ACL hardware counters	
	IP Filter		
	Add	Sets IP addresses of clients allowed management access via the web, SNMP, and Telnet	

Menu	Sub Menu	Description	Page
	Show	Shows the addresses to be allowed management access	
	Port Security	Configures per port security, including status, response for security breach, and maximum allowed MAC addresses	
	Port Authentication	IEEE 802.1X	
	Configure Global	Enables authentication and EAPOL pass-through	
	Configure Interface	Sets authentication parameters for individual ports	
	Show Statistics	Displays protocol statistics for the selected port	
	DoS Protection	Protects against Denial-of-Service attacks	
	DHCP Snooping		
	Configure Global	Enables DHCP snooping globally, MAC-address verification, information option; and sets the information policy	
	Configure VLAN	Enables DHCP snooping on a VLAN	
	Configure Interface	Sets the trust mode for an interface	
	Show Information	Displays the DHCP Snooping binding information	
	DHCP Snooping6		
	Configure Global	Enables DHCPv6 snooping globally, MAC-address verification, information option; and sets the information policy	
	Configure VLAN	Enables DHCPv6 snooping on a VLAN	
	Configure Interface	Sets the trust mode for an interface	
	Show Information	Displays the DHCPv6 Snooping binding information	
	ND Snooping		
	Configure Global	Enables ND Snooping globally on the switch	
	Configure VLAN	Enables ND Snooping on a VLAN or range of VLANs	
	Configure Interface	Sets the trust mode for an interface	
	Show Information	Displays the ND Snooping binding and prefix information	

Menu	Sub Menu	Description	Page
	IP Source Guard	Filters IP traffic based on static entries in the IP Source Guard table, or dynamic entries in the DHCP Snooping table	
	General	Enables IP source guard and selects filter type per port	
	Static Binding		
	Configure ACL Table		
	Add	Adds static addresses to the source guard ACL binding table	
	Show	Shows static addresses in the source guard ACL binding table	
	Configure MAC Table		
	Add	Adds static addresses to the source guard MAC address binding table	
	Show	Shows static addresses in the source guard MAC address binding table	
	Dynamic Binding	Displays the source-guard binding table for a selected interface	
	IPv6 Source Guard	Filters IPv6 traffic based on static entries in the IP Source Guard table, or dynamic entries in the DHCP Snooping table	
	Port Configuration	Enables IPv6 source guard and selects filter type per port	
	Static Binding		
	Add	Adds a static addresses to the source-guard binding table	
	Show	Shows static addresses in the source-guard binding table	
	Dynamic Binding	Displays the source-guard binding table for a selected interface	
	ARP Inspection	Enables inspection globally, configures validation of additional address components, and sets the log rate for packet inspection	
	Configure General		
	Configure VLAN	Enables ARP inspection on specified VLANs	
	Configure Interface	Sets the trust mode for ports, and sets the rate limit for packet inspection	
	Show Information		

Menu	Sub Menu	Description	Page
	Show Statistics	Displays statistics on the inspection process	
	Show Log	Shows the inspection log list	
	Application Filter	Discards CDP or PVST packets	
Administration	Log		
	System		
	Configure Global	Stores error messages in local memory	
	Show System Logs	Shows logged error messages	
	Remote	Configures the logging of messages to a remote logging process	
	SMTP	Sends an SMTP client message to a participating server	
	LLDP		
	Configure Global	Configures global LLDP timing parameters	
	Configure Interface		
	Configure General	Sets the message transmission mode; enables SNMP notification; and sets the LLDP attributes to advertise	
	Add CA-Type	Specifies the physical location of the device attached to an interface	
	Show Local Device Information		
	General	Displays general information about the local device	
	Port/Trunk	Displays information about each interface	
	Show Remote Device Information		
	Port/Trunk	Displays information about a remote device connected to a port on this switch	
	Port/Trunk Details	Displays detailed information about a remote device connected to this switch	
	Show Device Statistics		

Menu	Sub Menu	Description	Page
	General	Displays statistics for all connected remote devices	
	Port/Trunk	Displays statistics for remote devices on a selected port or trunk	
	PoE*	Power over Ethernet	
	PSE	Displays the PoE power status for the switch	
	SNMP	Simple Network Management Protocol	
	Configure Global	Enables SNMP agent status, and sets related trap functions	
	Configure Engine		
	Set Engine ID	Sets the SNMP v3 engine ID on this switch	
	Add Remote Engine	Sets the SNMP v3 engine ID for a remote device	
	Show Remote Engine	Shows configured engine ID for remote devices	
	Configure View		
	Add View	Adds an SNMP v3 view of the OID MIB	
	Show View	Shows configured SNMP v3 views	
	Add OID Subtree	Specifies a part of the subtree for the selected view	
	Show OID Subtree	Shows the subtrees assigned to each view	
	Configure Group		
	Add	Adds a group with access policies for assigned users	
	Show	Shows configured groups and access policies	
	Configure User		
	Add Community	Configures community strings and access mode	
	Show Community	Shows community strings and access mode	
	Add SNMPv3 Local User	Configures SNMPv3 users on this switch	
	Show SNMPv3 Local User	Shows SNMPv3 users configured on this switch	
	Change SNMPv3 Local User Group	Assign a local user to a new group	

Menu	Sub Menu	Description	Page
	Add SNMPv3 Remote User	Configures SNMPv3 users from a remote device	
	Show SNMPv3 Remote User	Shows SNMPv3 users set from a remote device	
	Configure Trap		
	Add	Configures trap managers to receive messages on key events that occur on this switch	
	Show	Shows configured trap managers	
	Configure Notify Filter		
	Add	Creates an SNMP notification log	
	Show	Shows the configured notification logs	
	Show Statistics	Shows the status of SNMP communications	
	RMON	Remote Monitoring	
	Configure Global		
	Add		
	Alarm	Sets threshold bounds for a monitored variable	
	Event	Creates a response event for an alarm	
	Show		
	Alarm	Shows all configured alarms	
	Event	Shows all configured events	
	Configure Interface		
	Add		
	History	Periodically samples statistics on a physical interface	
	Statistics	Enables collection of statistics on a physical interface	
	Show		
	History	Shows sampling parameters for each entry in the history group	
	Statistics	Shows sampling parameters for each entry in the statistics group	
	Show Details		
	History	Shows sampled data for each entry in the history group	

Menu	Sub Menu	Description	Page
	Statistics	Shows sampled data for each entry in the history group	
	Cluster		
	Configure Global	Globally enables clustering for the switch; sets Commander status	
	Configure Member	Adds switch Members to the cluster	
	Show Member	Shows cluster switch member; managed switch members	
	Time Range	Configures the time to apply an ACL	
	Add	Specifies the name of a time range	
	Show	Shows the name of configured time ranges	
	Add Rule		
	Absolute	Sets exact time or time range	
	Periodic	Sets a recurrent time	
	Show Rule	Shows the time specified by a rule	
	ERPS	Ethernet Ring Protection Switching	
	Configure Global	Activates ERPS globally	
	Configure Domain		
	Add	Creates an ERPS ring	
	Show	Shows list of configured ERPS rings, status, and settings	
	Configure Details	Configures ring parameters	
	Configure Operation	Blocks a ring port using Forced Switch or Manual Switch commands	
	MLAG		
	Configure Global	Enables MLAG globally	
	Configure Domain	Configures MLAG domains and peer links	
	Configure Group	Configures MLAG member interfaces	
	OAM	Operation, Administration, and Maintenance	
	Interface	Enables OAM on specified port, sets the mode to active or passive, and enables the reporting of critical events or errored frame events	

Menu	Sub Menu	Description	Page
	Counters	Displays statistics on OAM PDUs	
	Event Log	Displays the log for recorded link events	
	Remote Interface	Displays information about attached OAM-enabled devices	
	Remote Loopback	Performs a loopback test on the specified port	
	UDLD	UniDirectional Link Detection	
	Configure Global	Configures the message probe interval, detection interval, and recovery interval	
	Configure Interface	Enables UDLD and aggressive mode which reduces the shut-down delay after loss of bidirectional connectivity is detected	
	Show Information	Displays UDLD neighbor information, including neighbor state, expiration time, and protocol intervals	
	LBD	Loopback Detection	
	Configure Global	Enables loopback detection globally, specifies the interval at which to transmit control frames, specifies the interval to wait before releasing an interface from shutdown state, specifies response to detect loopback, and traps to send	
	Configure Interface	Enables loopback detection per interface	
Tools			
	Ping	Sends ICMP echo request packets to another node on the network	
	Trace Route	Shows the route packets take to the specified destination	
	ARP	Shows entries in the Address Resolution Protocol cache	
IP			
	General		
	Routing Interface		
	Add Address	Configures an IP interface for a VLAN	
	Show Address	Shows the IP interfaces assigned to a VLAN	
	Routing		
	Static Routes		
	Add	Configures static routing entries	
	Show	Shows static routing entries	

Menu	Sub Menu	Description	Page
	Routing Table	Shows all routing entries, including local, static and dynamic routes	
	IPv6 Configuration		
	Configure Global	Sets an IPv6 default gateway for traffic with no known next hop	
	Configure Interface	Configures IPv6 interface address using auto-configuration or link-local address, and sets related protocol settings	
	Configure Neighbor	Configures static IPv6 neighbor addresses	
	Add IPv6 Address	Adds an global unicast, EUI-64, or link-local IPv6 address to an interface	
	Configure IPv6 ND Prefix	Configures IPv6 prefixes to include in router advertisements	
	Show IPv6 Address	Show the IPv6 addresses assigned to an interface	
	Show IPv6 Neighbor Cache	Displays information in the IPv6 neighbor discovery cache	
	Show Statistics		
	IPv6	Shows statistics about IPv6 traffic	
	ICMPv6	Shows statistics about ICMPv6 messages	
	UDP	Shows statistics about UDP messages	
	Show MTU	Shows the maximum transmission unit (MTU) cache for destinations that have returned an ICMP packet-too-big message along with an acceptable MTU to this switch	
IP Service			
	DNS	Domain Name Service	
	General		
	Configure Global	Enables DNS lookup; defines the default domain name appended to incomplete host names	
	Add Domain Name	Defines a list of domain names that can be appended to incomplete host names	
	Show Domain Names	Shows the configured domain name list	
	Add Name Server	Specifies IP address of name servers for dynamic lookup	
	Show Name Servers	Shows the name server address list	

Menu	Sub Menu	Description	Page
	Static Host Table	Manually configures static entries in the DNS table	
	Add	Configures static entries for domain name to address mapping	
	Show	Shows the list of static mapping entries	
	Modify	Modifies the static address mapped to the selected host name	
	Cache	Displays cache entries discovered by designated name servers	
	Multicast DNS	Configures multicast DNS lookup on the local network without the need for a dedicated server	
	DHCP	Dynamic Host Configuration Protocol	
	Client	Specifies the DHCP client identifier for an interface	
	L3 Relay	Specifies DHCP relay servers	
	Relay Option 82	Enables and configures DHCP relay with Option 82 information	
	Dynamic Provision	Enables dynamic provisioning via DHCP	
	Server	Configures a DHCP service on the switch	
	DHCPv6	Dynamic Host Configuration Protocol for IPv6	
	Relay	Specifies DHCPv6 relay servers	
	Dynamic Provision	Enables dynamic provisioning via DHCPv6	
	PPPoE Intermediate Agent	Point-to-Point Protocol over Ethernet Intermediate Agent	
Multicast			
	IGMP Snooping		
	General	Enables multicast filtering; configures parameters for multicast snooping	
	Multicast Router		
	Add Static Multicast Router	Assigns ports that are attached to a neighboring multicast router	
	Show Static Multicast Router	Displays ports statically configured as attached to a neighboring multicast router	
	Show Current Multicast Router	Displays ports attached to a neighboring multicast router, either through static or dynamic configuration	
	IGMP Member		

Menu	Sub Menu	Description	Page
	Add Static Member	Statically assigns multicast addresses to the selected VLAN	
	Show Static Member	Shows multicast addresses statically configured on the selected VLAN	
	Interface		
	Configure VLAN	Configures IGMP snooping per VLAN interface	
	Show VLAN Information	Shows IGMP snooping settings per VLAN interface	
	Configure Port	Configures the interface to drop IGMP query packets or all multicast data packets	
	Configure Trunk	Configures the interface to drop IGMP query packets or all multicast data packets	
	Forwarding Entry	Displays the current multicast groups learned through IGMP Snooping	
	Filter		
	Configure General	Enables IGMP filtering for the switch	
	Configure Profile		
	Add	Adds IGMP filter profile; and sets access mode	
	Show	Shows configured IGMP filter profiles	
	Add Multicast Group Range	Assigns multicast groups to selected profile	
	Show Multicast Group Range	Shows multicast groups assigned to a profile	
	Configure Interface	Assigns IGMP filter profiles to port interfaces and sets throttling action	
	Statistics		
	Show Query Statistics	Shows statistics for query-related messages	
	Show VLAN Statistics	Shows statistics for protocol messages, number of active groups	
	Show Port Statistics	Shows statistics for protocol messages, number of active groups	
	Show Trunk Statistics	Shows statistics for protocol messages, number of active groups	
	MLD Snooping		
	General	Enables multicast filtering; configures parameters for IPv6 multicast snooping	
	Interface	Configures Immediate Leave status for a VLAN	

Menu	Sub Menu	Description	Page
	Multicast Router		
	Add Static Multicast Router	Assigns ports that are attached to a neighboring multicast router	
	Show Static Multicast Router	Displays ports statically configured as attached to a neighboring multicast router	
	Show Current Multicast Router	Displays ports attached to a neighboring multicast router, either through static or dynamic configuration	
	MLD Member		
	Add Static Member	Statically assigns multicast addresses to the selected VLAN	
	Show Static Member	Shows multicast addresses statically configured on the selected VLAN	
	Show Current Member	Shows multicast addresses associated with the selected VLAN, either through static or dynamic configuration	
	Filter		
	Configure General	Enables MLD filtering for the switch	
	Configure Profile		
	Add	Adds MLD filter profile; and sets access mode	
	Show	Shows configured MLD filter profiles	
	Add Multicast Group Range	Assigns multicast groups to selected profile	
	Show Multicast Group Range	Shows multicast groups assigned to a profile	
	Query Drop	Configures the interface to drop MLD query packets	
	Group Information	Displays known multicast groups, member ports, the means by which each group was learned, and the corresponding source list	
	Statistics		
	Input	Shows statistics for MLD ingress traffic	
	Output	Shows statistics for MLD egress traffic	
	Query	Shows statistics for query-related messages	
	Summary	Shows summary statistics for querier and report/leave messages	
	Clear	Clears all MLD statics or statistics for specified VLAN/port	

Menu	Sub Menu	Description	Page
	MVR	Multicast VLAN Registration	
	Configure Global	Configures proxy switching and robustness value	
	Configure Domain	Enables MVR for a domain, sets the MVR VLAN, forwarding priority, and upstream source IP	
	Configure Profile		
	Add	Configures multicast stream addresses	
	Show	Shows multicast stream addresses	
	Associate Profile		
	Add	Maps an address profile to a domain	
	Show	Shows addresses profile to domain mapping	
	Configure Interface	Configures MVR interface type and immediate leave mode; also displays MVR operational and active status	
	Configure Static Group Member		
	Add	Statically assigns MVR multicast streams to an interface	
	Show	Shows MVR multicast streams assigned to an interface	
	Show Member	Shows the multicast groups assigned to an MVR VLAN, the source address of the multicast services, and the interfaces with active subscribers	
	Show Statistics		
	Show Query Statistics	Shows statistics for query-related messages	
	Show VLAN Statistics	Shows statistics for protocol messages and number of active groups	
	Show Port Statistics	Shows statistics for protocol messages and number of active groups	
	Show Trunk Statistics	Shows statistics for protocol messages and number of active groups	

This Page Intentionally Left Blank

Chapter 5

Basic Management Tasks

Overview

This chapter describes the following topics:

- ◆ *Displaying System Information* – Provides basic system description, including contact information.
- ◆ *Displaying Hardware / Software Versions* – Shows the hardware version, power status, and firmware versions.
- ◆ *Configuring Support for Jumbo Frames* – Enables support for jumbo frames.
- ◆ *Displaying Bridge Extension Capabilities* – Shows the bridge extension parameters.
- ◆ *Managing System Files* – Describes how to upgrade operating software or configuring files, and set the system start-up files.
- ◆ *Setting the System Clock* – Sets the current time manually or through specified NTP or SNTP servers.
- ◆ *Configuring the Console Port* – Sets console port connection parameters.
- ◆ *Configuring Telnet Settings* – Sets Telnet connection parameters.
- ◆ *Displaying CPU Utilization* – Displays information on CPU utilization.
- ◆ *Configuring CPU Guard* – Sets thresholds in terms of CPU usage time and number of packets processed per second.
- ◆ *Displaying Memory Utilization* – Shows memory utilization parameters.
- ◆ *Resetting the System* – Restarts the switch immediately, at a specified time, after a specified delay, or at a periodic interval.

Displaying System Information

Use the System > General page to identify the system by displaying information such as the device name, location and contact information.

Parameters

These parameters are displayed:

- ◆ **System Description** – Brief description of device type.
- ◆ **System Object ID** – MIB II object ID for switch's network management subsystem.
- ◆ **System Up Time** – Length of time the management agent has been up.
- ◆ **System Name** – Name assigned to the switch system.
- ◆ **System Location** – Specifies the system location.
- ◆ **System Contact** – Administrator responsible for the system.

Web Interface

To configure general system information:

1. Click **System > General**.
2. Specify the system name, location, and contact information for the system administrator.
3. Click **Apply**.

The screenshot shows a web interface for configuring system information. The title is "System > General". The parameters and their values are:

System Description	ES0154
System Object ID	1.3.6.1.4.1.259.10.1.55.102
System Up Time	0 days, 0 hours, 15 minutes, and 36.17 seconds
System Name	<input type="text"/>
System Location	<input type="text"/>
System Contact	<input type="text"/>

At the bottom right, there are two buttons: "Apply" and "Revert".

Displaying Hardware / Software Versions

Use the System > Switch page to display hardware/firmware version numbers for the main board and management software, as well as the power status of the system.

Parameters

The following parameters are displayed:

Main Board Information

- ◆ **Serial Number** – The serial number of the switch.
- ◆ **Number of Ports** – Number of built-in ports.
- ◆ **Hardware Version** – Hardware version of the main board.
- ◆ **Main Power Status** – Displays the status of the internal power supply.

Management Software Information

- ◆ **Role** – Shows that this switch is operating as Master or Slave.
- ◆ **Loader Version** – Version number of loader code.
- ◆ **Linux Kernel Version** – Version number of Linux kernel.
- ◆ **Operation Code Version** – Version number of runtime code.

Temperature List

- ◆ **Thermal Detector** – The number of the detector on the main board.
- ◆ **Temperature** – Temperature at specified thermal detection point.

Web Interface

To view hardware and software version information.

1. Click **System > Switch**.

Configuring Support for Jumbo Frames

Use the **System > Capability** page to configure support for layer 2 jumbo frames. The switch provides more efficient throughput for large sequential data transfers by supporting jumbo frames up to 10240 bytes for Gigabit Ethernet and 10 Gigabit Ethernet ports or trunks. Compared to standard Ethernet frames that run only up to 1.5 KB, using jumbo frames significantly reduces the per-packet overhead required to process protocol encapsulation fields.

Usage Guidelines

To use jumbo frames, both the source and destination end nodes (such as a computer or server) must support this feature. Also, when the connection is operating at full duplex, all switches in the network between the two end nodes must be able to accept the extended frame size. And for half-duplex connections, all devices in the collision domain would need to support jumbo frames.

Parameters

The following parameters are displayed:

- ♦ **Jumbo Frame** – Configures support for jumbo frames. (Default: Disabled)

Web Interface

To configure support for jumbo frames:

1. Click **System > Capability**.
2. Enable or disable support for jumbo frames.
3. Click **Apply**.

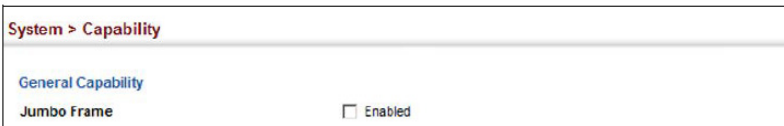

The screenshot shows a web interface with a breadcrumb trail "System > Capability" at the top. Below it, there is a section titled "General Capability" in blue. Underneath, the "Jumbo Frame" setting is displayed with a checkbox that is currently unchecked, followed by the text "Enabled".

Displaying Bridge Extension Capabilities

Use the System > Capability page to display settings based on the Bridge MIB. The Bridge MIB includes extensions for managed devices that support Multicast Filtering, Traffic Classes, and Virtual LANs. You can access these extensions to display default settings for the key variables.

Parameters

The following parameters are displayed:

- ◆ **Extended Multicast Filtering Services** – This switch does not support the filtering of individual multicast addresses based on GMRP (GARP Multicast Registration Protocol).
- ◆ **Traffic Classes** – This switch provides mapping of user priorities to multiple traffic classes.
- ◆ **Static Entry Individual Port** – This switch allows static filtering for unicast and multicast addresses.
- ◆ **VLAN Version Number** – Based on IEEE 802.1Q, “1” indicates Bridges that support only single spanning tree (SST) operation, and “2” indicates Bridges that support multiple spanning tree (MST) operation.
- ◆ **VLAN Learning** – This switch uses Independent VLAN Learning (IVL), where each port maintains its own filtering database.
- ◆ **Local VLAN Capable** – This switch does not support multiple local bridges outside of the scope of 802.1Q defined VLANs.
- ◆ **Configurable PVID Tagging** – This switch allows you to override the default Port VLAN ID (PVID used in frame tags) and egress status (VLAN-Tagged or Untagged) on each port.
- ◆ **Max Supported VLAN Numbers** – The maximum number of VLANs supported on this switch.
- ◆ **Max Supported VLAN ID** – The maximum configurable VLAN identifier supported on this switch.

Web Interface

To view Bridge Extension information:

1. Click **System > Capability**.

System > Capability

General Capability

Jumbo Frame Enabled

Bridge Extension

Extended Multicast Filtering Services	No
Traffic Classes	Enabled
Static Entry Individual Port	Yes
VLAN Version Number	2
VLAN Learning	IVL
Local VLAN Capable	No
Configurable PVID Tagging	Yes
Max Supported VLAN Numbers	4094
Max Supported VLAN ID	4094

Managing System Files

This section describes how to upgrade the switch operating software or configuration files, and set the system start-up files.

Copying Files via FTP/FTPS/SFTP/SCP/TFTP/HTTP

Use the System > File (Copy) page to upload/download firmware or configuration settings using FTP, FTPS, SFTP, SCP, TFTP or HTTP. By backing up a file to a FTP/FTPS/SFTP/SCP/TFTP server or management station, that file can later be downloaded to the switch to restore operation. Specify the method of file transfer, along with the file type and file names as required.

You can also set the switch to use new firmware or configuration settings without overwriting the current version. Just download the file using a different name from the current version, and then set the new file as the startup file.

Command Usage

- ◆ When logging into an FTP/FTPS/SFTP server, the interface prompts for a user name and password configured on the remote server. Note that “Anonymous” is set as the default user name.
- ◆ Secure Shell FTP (SFTP) provides a method of transferring files between two network devices over an SSH2-secured connection. SFTP functions similar to Secure Copy (SCP), using SSH for user authentication and data encryption.

Although the underlying premises of SFTP are similar to SCP, it requires some additional steps to verify the protocol versions and perform security checks. SFTP connection setup includes verification of the DSS signature, creation of session keys, creation of client-server and server-client ciphers, SSH key exchange, and user authentication. An SFTP channel is then opened, the SFTP protocol version compatibility verified, and SFTP finally initialized.

- ◆ The reset command will not be accepted during copy operations to flash memory.

Parameters

The following parameters are displayed:

- ◆ **Copy Type** – The firmware copy operation includes these options:
 - ◆ FTP Upload – Copies a file from an FTP server to the switch.

- ◆ FTP Download – Copies a file from the switch to an FTP server.
- ◆ FTPS Upload – Copies a file from an FTPS server to the switch.
- ◆ FTPS Download – Copies a file from the switch to an FTPS server.
- ◆ HTTP Upload – Copies a file from a management station to the switch.
- ◆ HTTP Download – Copies a file from the switch to a management station.
- ◆ SFTP Upload – Copies a file from an SFTP server to the switch.
- ◆ SFTP Download – Copies a file from the switch to an SFTP server.
- ◆ SCP Upload – Copies a file from an SCP server to the switch.
- ◆ SCP Download – Copies a file from the switch to an SCP server.
- ◆ TFTP Upload – Copies a file from a TFTP server to the switch.
- ◆ TFTP Download – Copies a file from the switch to a TFTP server.
- ◆ **FTP/FTPS/SFTP/SCP/TFTP Server IP Address** – The IP address of an FTP/FTPS/SFTP/SCP/TFTP server.
- ◆ **User Name** – The user name for SFTP/SCP/FTP/FTPS server access.
- ◆ **Password** – The password for SFTP/SCP/FTP/FTPS server access.
- ◆ **File Type** – Specify Operation Code to copy firmware.
- ◆ **File Name** – The file name should not contain slashes (\ or /), the leading letter of the file name should not be a period (.), and the maximum length for file names is 32 characters for files on the switch or 127 characters for files on the server. (Valid characters: A-Z, a-z, 0-9, “.”, “-”, “_”)

Note:

- ◆ Up to two copies of the system software (i.e., the runtime firmware) can be stored in the file directory on the switch.
 - ◆ The maximum number of user-defined configuration files is limited only by available flash memory space.
 - ◆ The file “Factory_Default_Config.cfg” can be copied to a file server or management station, but cannot be used as the destination file name on the switch.
-

Web Interface

To copy firmware files:

1. Click **System > File**.
2. Select Copy from the Action list.
3. Select FTP Upload, HTTP Upload, FTPS, SFTP, SCP, or TFTP Uploads as the file transfer method.
4. If FTP, FTPS, SFTP, SCP, or TFTP Upload is used, enter the IP address of the file server.
5. If FTP/FTPS/SCP/SFTP Upload is used, enter the user name and password for your account on the FTP/FTPS/SCP/SFTP server.
6. Set the file type to Operation Code.
7. Enter the name of the file to download.
8. Select a file on the switch to overwrite or specify a new file name.
9. Then click **Apply**.

The screenshot shows the 'System > File' web interface. The 'Action' dropdown is set to 'Copy'. Below it, the 'Copy Type' is set to 'FTP Upload'. The 'FTP Server IP Address' is '192.168.1.123', 'User Name' is 'Edge01', and 'Password' is masked with asterisks. The 'File Type' is 'Operation Code'. The 'Source File Name' is 'runtime-new.bix'. The 'Destination File Name' has a radio button selected for 'runtime.bix' and an empty input field below it. At the bottom right, there are 'Apply' and 'Revert' buttons.

If you replaced a file currently used for startup and want to start using the new file, reboot the system via the System > Reset menu.

Saving the Running Configuration to a Local File

Use the System > File (Copy) page to save the current configuration settings to a local file on the switch. The configuration settings are not automatically saved by the system for subsequent use when the switch is rebooted. You must save these settings to the current startup file, or to another file which can be subsequently set as the startup file.

Parameters

The following parameters are displayed:

- ◆ **Copy Type** – The copy operation includes this option:
 - ◆ Running-Config – Copies the current configuration settings to a local file on the switch.
- ◆ **Destination File Name** – Copy to the currently designated startup file, or to a new file. The file name should not contain slashes (\ or /), the leading letter of the file name should not be a period (.), and the maximum length for file names is 32 characters. (Valid characters: A-Z, a-z, 0-9, “.”, “-”, “_”)

Note: The maximum number of user-defined configuration files is limited only by available flash memory space.

Web Interface

To save the running configuration file:

1. Click **System > File**.
2. Select Copy from the Action list.
3. Select Running-Config from the Copy Type list.
4. Select the current startup file on the switch to overwrite or specify a new file name.
5. Then click **Apply**.

The screenshot shows a web interface window titled "System > File". At the top, there is a dropdown menu for "Action:" with "Copy" selected. Below this, there are two rows of configuration options. The first row is labeled "Copy Type" and has a dropdown menu with "Running-Config" selected. The second row is labeled "Destination File Name" and has a dropdown menu with "startup1.cfg" selected. Below the "Destination File Name" dropdown, there is an empty text input field. At the bottom right of the window, there are two buttons: "Apply" and "Revert".

If you replaced a file currently used for startup and want to start using the new file, reboot the system via the System > Reset menu.

Setting the Start-up File

Use the System > File (Set Start-Up) page to specify the firmware or configuration file to use for system initialization.

Web Interface

To set a file to use for system initialization:

1. Click **System > File**.
2. Select Set Start-Up from the Action list.
3. Mark the operation code or configuration file to be used at startup
4. Then click **Apply**.

System > File

Action: Set Start-Up

File List Total: 3

	File Name	File Type	Start-Up	Modify Time	Size (bytes)
<input checked="" type="radio"/>	runtime_v1.1.0.9.bxc	Operation Code	Y	2023-02-07 14:40:05	51893948
<input type="radio"/>	Factory_Default_Config.cfg	Config File	N	2023-01-17 01:09:16	455
<input checked="" type="radio"/>	startup1.cfg	Config File	Y	2023-02-17 07:39:01	1673

Apply Revert

To start using the new firmware or configuration settings, reboot the system via the System > Reset menu.

Showing System Files

Use the System > File (Show) page to show the files in the system directory, or to delete a file.

Note: Files designated for start-up, and the Factory_Default_Config.cfg file, cannot be deleted.

Web Interface

To show the system files:

1. Click **System > File**.
2. Select Show from the Action list.
3. To delete a file, mark it in the File List and click **Delete**.

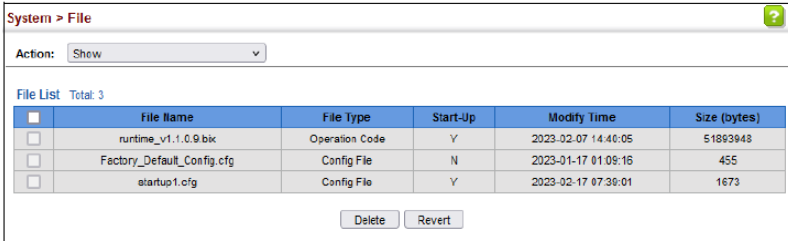

Automatic Operation Code Upgrade

Use the System > File (Automatic Operation Code Upgrade) page to automatically download an operation code file when a file newer than the currently installed one is discovered on the file server. After the file is transferred from the server and successfully written to the file system, it is automatically set as the startup file, and the switch is rebooted.

Usage Guidelines

- ◆ If this feature is enabled, the switch searches the defined URL once during the bootup sequence.
- ◆ FTP (port 21) and TFTP (port 69) are both supported. Note that the TCP/UDP port bindings cannot be modified to support servers listening on non-standard ports.
- ◆ The host portion of the upgrade file location URL must be a valid IPv4 IP address. DNS host names are not recognized. Valid IP addresses consist of four numbers, 0 to 255, separated by periods.
- ◆ The path to the directory must also be defined. If the file is stored in the root directory for the FTP/TFTP service, then use the “/” to indicate this (e.g., ftp:// 192.168.0.1/).
- ◆ The file name must not be included in the upgrade file location URL. The file name of the code stored on the remote server must be *ES0154/ES0154P.bix* (using upper case and lower case letters exactly as indicated).

here). Enter the file name for other switches described in this manual exactly as shown on the web interface.

- ◆ The FTP connection is made with PASV mode enabled. PASV mode is needed to traverse some fire walls, even if FTP traffic is not blocked. PASV mode cannot be disabled.
- ◆ The switch-based search function is case-insensitive in that it will accept a file name in upper or lower case (i.e., the switch will accept *EC0154/ES0154P.BIX* from the server even though *EC0154/ES0154P.bix* was requested). However, keep in mind that the file systems of many operating systems such as Unix and most Unix-like systems (FreeBSD, NetBSD, OpenBSD, and most Linux distributions, etc.) are case-sensitive, meaning that two files in the same directory, *es0154/es0154p.bix* and *ES0154/ES0154P.bix* are considered to be unique files. Thus, if the upgrade file is stored as *ES0154/ES0154P.bix* (or even *ES0154/ES0154P.BIX*) on a case-sensitive server, then the switch (requesting *es0154/es0154p.bix*) will not be upgraded because the server does not recognize the requested file name and the stored file name as being equal. A notable exception in the list of case-sensitive Unix-like operating systems is Mac OS X, which by default is case-insensitive. Please check the documentation for your server's operating system if you are unsure of its file system's behavior.
- ◆ Note that the switch itself does not distinguish between upper and lower-case file names, and only checks to see if the file stored on the server is more recent than the current runtime image.
- ◆ If two operation code image files are already stored on the switch's file system, then the non-startup image is deleted before the upgrade image is transferred.
- ◆ The automatic upgrade process will take place in the background without impeding normal operations (data switching, etc.) of the switch.
- ◆ During the automatic search and transfer process, the administrator cannot transfer or update another operation code image, configuration file, public key, or HTTPS certificate (i.e., no other concurrent file management operations are possible).
- ◆ The upgrade operation code image is set as the startup image after it has been successfully written to the file system.
- ◆ The switch will send an SNMP trap and make a log entry upon all upgrade successes and failures.
- ◆ The switch will immediately restart after the upgrade file is successfully written to the file system and set as the startup image.

Parameters

The following parameters are displayed:

- ◆ **Automatic Opcode Upgrade** – Enables the switch to search for an upgraded operation code file during the switch bootup process. (Default: Disabled)
- ◆ **Automatic Upgrade Location URL** – Defines where the switch should search for the operation code upgrade file. The last character of this URL must be a forward slash (“/”). The *ES0154/ES0154P.bix* filename must not be included since it is automatically appended by the switch. (Options: ftp, sftp, tftp)
- ◆ **Automatic Opcode Upgrade Reload** – Restarts the switch automatically after an opcode upgrade is completed.

The following syntax must be observed:

tftp://host[/filedir]/

- ◆ **tftp://** – Defines TFTP protocol for the server connection.
- ◆ *host* – Defines the IP address of the TFTP server. Valid IP addresses consist of four numbers, 0 to 255, separated by periods. DNS host names are not recognized.
- ◆ *filedir* – Defines the directory, relative to the TFTP server root, where the upgrade file can be found. Nested directory structures are accepted. The directory name must be separated from the host, and in nested directory structures, from the parent directory, with a prepended forward slash “/”.
- ◆ / – The forward slash must be the last character of the URL.

ftp://[username[:password@]]host[/filedir]/

- ◆ **ftp://** – Defines FTP protocol for the server connection.
- ◆ *username* – Defines the user name for the FTP connection. If the user name is omitted, then “anonymous” is the assumed user name for the connection.
- ◆ *password* – Defines the password for the FTP connection. To differentiate the password from the user name and host portions of the URL, a colon (:) must precede the password, and an “at” symbol (@), must follow the password. If the password is omitted, then “” (an empty string) is the assumed password for the connection.
- ◆ *host* – Defines the IP address of the FTP server. Valid IP addresses consist of four numbers, 0 to 255, separated by periods. DNS host names are not recognized.

- ◆ *filedir* – Defines the directory, relative to the FTP server root, where the upgrade file can be found. Nested directory structures are accepted. The directory name must be separated from the host, and in nested directory structures, from the parent directory, with a prepended forward slash “/”.
- ◆ / – The forward slash must be the last character of the URL.

Examples

The following examples demonstrate the URL syntax for a TFTP server at IP address 192.168.0.1 with the operation code image stored in various locations:

- ◆ `tftp://192.168.0.1/`
The image file is in the TFTP root directory.
- ◆ `tftp://192.168.0.1/switch-opcode/`
The image file is in the “switch-opcode” directory, relative to the TFTP root.
- ◆ `tftp://192.168.0.1/switches/opcode/`
The image file is in the “opcode” directory, which is within the “switches” parent directory, relative to the TFTP root.

The following examples demonstrate the URL syntax for an FTP server at IP address 192.168.0.1 with various user name, password and file location options presented:

- ◆ `ftp://192.168.0.1/`
The user name and password are empty, so “anonymous” will be the user name and the password will be blank. The image file is in the FTP root directory.
- ◆ `ftp://switches:upgrade@192.168.0.1/`
The user name is “switches” and the password is “upgrade”. The image file is in the FTP root.
- ◆ `ftp://switches:upgrade@192.168.0.1/switches/opcode/`
The user name is “switches” and the password is “upgrade”. The image file is in the “opcode” directory, which is within the “switches” parent directory, relative to the FTP root.

Web Interface

To configure automatic code upgrade:

1. Click **System** > **File**.
2. Select Automatic Operation Code Upgrade from the Action list.
3. Mark the check box to enable Automatic Opcode Upgrade.
4. Enter the URL of the FTP or TFTP server, and the path and directory containing the operation code.
5. Click **Apply**.

The screenshot shows a web interface window titled "System > File". At the top, there is a dropdown menu labeled "Action:" with "Automatic Operation Code Upgrade" selected. Below this, there are three configuration options:

- "Automatic Opcode Upgrade" with an unchecked checkbox and the label "Enabled".
- "Automatic Upgrade Location URL" with an empty text input field.
- "Automatic Opcode Upgrade Reload" with an unchecked checkbox and the label "Enabled".

Below these options is a blue note: "Note: For automatic upgrades, the operation code file name must be set as ES0154.bx." At the bottom of the form are two buttons: "Apply" and "Revert".

If a new image is found at the specified location, the following type of messages will be displayed during bootup.

```
.  
. .  
Automatic Upgrade is looking for a new image  
New image detected: current version 1.2.3.4; new version 1.2.3.5  
Image upgrade in progress  
The switch will restart after upgrade succeeds  
Downloading new image  
  
Flash programming started  
Flash programming completed  
The switch will now restart  
. .  
.
```

Setting the System Clock

Simple Network Time Protocol (SNTP) allows the switch to set its internal clock based on periodic updates from a time server (SNTP or NTP).

Maintaining an accurate time on the switch enables the system log to record meaningful dates and times for event entries. You can also manually set the clock. If the clock is not set manually or via SNTP, the switch will only record the time from the factory default set at the last bootup.

When the SNTP client is enabled, the switch periodically sends a request for a time update to a configured time server. You can configure up to three time server IP addresses. The switch will attempt to poll each server in the configured sequence.

Setting the Time Manually

Use the System > Time (Configure General - Manual) page to set the system time on the switch manually without using SNTP.

Parameters

The following parameters are displayed:

- ◆ **Current Time** – Shows the current time set on the switch.
- ◆ **Hours** – Sets the hour. (Range: 0-23)
- ◆ **Minutes** – Sets the minute value. (Range: 0-59)
- ◆ **Seconds** – Sets the second value. (Range: 0-59)
- ◆ **Month** – Sets the month. (Range: 1-12)
- ◆ **Day** – Sets the day of the month. (Range: 1-31)
- ◆ **Year** – Sets the year. (Range: 1970-2037)

Web Interface

To manually set the system clock:

1. Click **System > Time**.
2. Select Configure General from the Step list.
3. Select Manual from the Maintain Type list.
4. Enter the time and date in the appropriate fields.
5. Click **Apply**.

System > Time

Step: 1. Configure General ▼

Current Time 2018-1-4 19:26:8

Maintain Type Manual ▼

19 Hours
 26 Minutes
 8 Seconds

1 Month
 4 Day
 2018 Year

Apply
 Revert

Setting the SNTP Polling Interval

Use the System > Time (Configure General - SNTP) page to set the polling interval at which the switch will query the specified time servers.

Parameters

The following parameters are displayed:

- ♦ **Current Time** – Shows the current time set on the switch.
- ♦ **SNTP Polling Interval** – Sets the interval between sending requests for a time update from a time server. (Range: 16-16384 seconds; Default: 16 seconds)

Web Interface

To set the polling interval for SNTP:

1. Click **System > Time**.
2. Select Configure General from the Step list.
3. Select SNTP from the Maintain Type list.
4. Modify the polling interval if required.
5. Click **Apply**.

System > Time

Step: 1. Configure General ▼

Current Time 2014-5-30 9:59:20

Maintain Type SNTP ▼

[SNTP Configuration](#)

SNTP Polling Interval (16-16384) 16 sec

Apply
 Revert

Configuring NTP

Use the System > Time (Configure General - NTP) page to configure NTP authentication and show the polling interval at which the switch will query the specified time servers.

Parameters

The following parameters are displayed:

- ◆ **Current Time** – Shows the current time set on the switch.
- ◆ **Authentication Status** – Enables authentication for time requests and updates between the switch and NTP servers. (Default: Disabled)
You can enable NTP authentication to ensure that reliable updates are received from only authorized NTP servers. The authentication keys and their associated key number must be centrally managed and manually distributed to NTP servers and clients. The key numbers and key values must match on both the server and client.

Web Interface

To set the clock maintenance type to NTP:

1. Click **System > Time**.
2. Select Configure General from the Step list.
3. Select NTP from the Maintain Type list.
4. Enable authentication if required.
5. Click **Apply**.

System > Time

Step: 1. Configure General ▼

Current Time 2018-1-4 19:26:8

Maintain Type NTP ▼

NTP Configuration

Authentication Status Enabled

Configuring Time Servers

Use the System > Time (Configure Time Server) pages to specify the IP address for NTP/SNTP time servers, or to set the authentication key for NTP time servers.

Specifying SNTP Time Servers

Use the System > Time (Configure Time Server – Configure SNTP Server) page to specify the IP address for up to three SNTP time servers.

Parameters

The following parameters are displayed:

- ◆ **SNTP Server IP Address / Host Name** – Sets the IPv4 address for up to three time servers. The switch attempts to update the time from the first server, if this fails it attempts an update from the next server in the sequence.

Web Interface

To set the SNTP time servers:

1. Click **System > Time**.
2. Select Configure Time Server from the Step list.
3. Select Configure SNTP Server from the Action list.
4. Enter the IP address of up to three time servers.
5. Click **Apply**.

The screenshot shows a web interface for configuring time servers. At the top, it says "System > Time". Below that, there are two dropdown menus: "Step: 2. Configure Time Server" and "Action: Configure SNTP Server". The main area contains three rows of input fields, each labeled "SNTP Server IP Address / Host Name" followed by a number (1, 2, or 3). The first row has the value "10.1.0.18", the second row has "137.62.140.80", and the third row has "126.250.36.2". At the bottom right of the form, there are two buttons: "Apply" and "Revert".

Specifying NTP Time Servers

Use the System > Time (Configure Time Server – Add NTP Server) page to add the IP address for up to 50 NTP time servers.

Parameters

The following parameters are displayed:

- ♦ **NTP Server IP Address** – Sets the IPv4 address for up to three time servers. The switch will poll the specified time servers for updates when the clock maintenance type is set to NTP on the System > Time (Configure General) page. It issues time synchronization requests at a fixed interval of 1024 seconds. The switch will poll all the time servers configured, the responses received are filtered and compared to determine the most reliable and accurate time update for the switch.
- ♦ **Version** – Specifies the NTP version supported by the server. (Fixed: Version 4)
- ♦ **Authentication Key** – Specifies the number of the key in the NTP Authentication Key List to use for authentication with the configured server. NTP authentication is optional. If enabled on the System > Time (Configure General) page, you must also configure at least one key on the System > Time (Add NTP Authentication Key) page. (Range: 1-65533)

Web Interface

To add an NTP time server to the server list:

1. Click **System > Time**.
2. Select Configure Time Server from the Step list.
3. Select Add NTP Server from the Action list.
4. Enter the IP address of an NTP time server, and specify the index of the authentication key if authentication is required.
5. Click **Apply**.

The screenshot shows the 'System > Time' configuration page. At the top, there is a breadcrumb 'System > Time'. Below it, there are two dropdown menus: 'Step: 2. Configure Time Server' and 'Action: Add NTP Server'. The main form area contains three input fields: 'NTP Server IP Address/Host Name' (empty), 'Version' (set to 4), and 'Authentication Key (1-65533)' (empty) with '(optional)' text to its right. At the bottom right of the form are two buttons: 'Apply' and 'Revert'.

To show the list of configured NTP time servers:

1. Click **System > Time**.
2. Select Configure Time Server from the Step list.
3. Select Show NTP Server from the Action list.

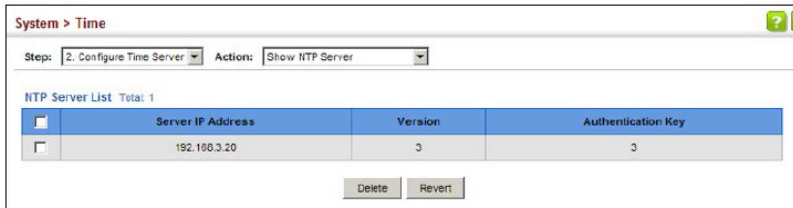

Specifying NTP Authentication Keys

Use the System > Time (Configure Time Server – Add NTP Authentication Key) page to add an entry to the authentication key list.

Parameters

The following parameters are displayed:

- ◆ **Authentication Key** – Specifies the number of the key in the NTP Authentication Key List to use for authentication with a configured server. NTP authentication is optional. When enabled on the System > Time (Configure General) page, you must also configure at least one key on this page. Up to 255 keys can be configured on the switch. (Range: 1-65533)
- ◆ **Key Context** – An MD5 authentication key string. The key string can be up to 32 case-sensitive printable ASCII characters (no spaces). NTP authentication key numbers and values must match on both the server and client.

Web Interface

To add an entry to NTP authentication list:

1. Click **System > Time**.
2. Select Configure Time Server from the Step list.
3. Select Add NTP Authentication Key from the Action list.
4. Enter the index number and MD5 authentication key string.
5. Click **Apply**.

System > Time

Step: 2. Configure Time Server Action: Add NTP Authentication Key

Authentication Key (1-65535)

Key Context (1-32)

Apply Revert

To show the list of configured NTP authentication keys:

1. Click **System > Time**.
2. Select Configure Time Server from the Step list.
3. Select Show NTP Authentication Key from the Action list.

System > Time

Step: 2. Configure Time Server Action: Show NTP Authentication Key

NTP Authentication Key List Total: 1

<input type="checkbox"/>	Authentication Key	Key Context
<input type="checkbox"/>	3	8J8774Q6695747010867F125505J62770084708278G1357878N8475052113089137L8

Delete Revert

Setting the Time Zone

Use the System > Time (Configure Time Zone) page to set the time zone. SNTP uses Coordinated Universal Time (or UTC, formerly Greenwich Mean Time, or GMT) based on the time at the Earth's prime meridian, zero degrees longitude, which passes through Greenwich, England. To display a time corresponding to your local time, you must indicate the number of hours and minutes your time zone is east (before) or west (after) of UTC. You can choose one of the 80 predefined time zone definitions, or you can manually configure the parameters for your local time zone.

Parameters

The following parameters are displayed:

- ◆ **Predefined Configuration** – A drop-down box provides access to the 80 predefined time zone configurations. Each choice indicates its offset from UTC and lists at least one major city or location covered by the time zone.
- ◆ **User-defined Configuration** – Allows the user to define all parameters of the local time zone.

- ◆ **Direction** – Configures the time zone to be before (east of) or after (west of) UTC.
- ◆ **Name** – Assigns a name to the time zone. (Range: 1-30 characters)
- ◆ **Hours (0-13)** – The number of hours before or after UTC. The maximum value before UTC is 12. The maximum value after UTC is 13.
- ◆ **Minutes (0-59)** – The number of minutes before/after UTC.

Web Interface

To set your local time zone:

1. Click **System > Time**.
2. Select Configure Time Zone from the Step list.
3. Set the offset for your time zone relative to the UTC in hours and minutes.
4. Click **Apply**.

The screenshot shows the 'System > Time' configuration page. At the top, there is a breadcrumb 'System > Time' and a 'Step:' dropdown menu set to '3. Configure Time Zone'. Below this, there are two radio buttons: 'Predefined Configuration' (unselected) and 'User Defined Configuration' (selected). Under 'User Defined Configuration', there are four fields: 'Direction' (a dropdown menu set to 'After UTC'), 'Name' (a text input field containing 'UTC'), 'Hours (0-13)' (a text input field containing '0'), and 'Minutes (0-59)' (a text input field containing '0'). Below these fields, there is a note: 'Note: The maximum value before UTC is 12:00. The maximum value after UTC is 13:00.' At the bottom right, there are two buttons: 'Apply' and 'Revert'.

Configuring Summer Time

Use the Summer Time page to set the system clock forward during the summer months (also known as daylight savings time).

In some countries or regions, clocks are adjusted through the summer months so that afternoons have more daylight and mornings have less. This is known as Summer Time, or Daylight Savings Time (DST). Typically, clocks are adjusted forward one hour at the start of spring and then adjusted backward in autumn.

Parameters

The following parameters are displayed in the web interface:

General Configuration

- ◆ **Summer Time in Effect** – Shows if the system time has been adjusted.
- ◆ **Status** – Shows if summer time is set to take effect during the specified period.
- ◆ **Name** – Name of the time zone while summer time is in effect, usually an acronym. (Range: 1-30 characters)
- ◆ **Mode** – Selects one of the following configuration modes. (The Mode option can only be managed when the Summer Time Status option has been set to enabled for the switch.)

Predefined Mode – Configures the summer time status and settings for the switch using predefined configurations for several major regions of the world. To specify the time corresponding to your local time when summer time is in effect, select the predefined summer-time zone appropriate for your location.

Region	Start Time, Day, Week, & Month	End Time, Day, Week, & Month	Rel. Offset
Australia	00:00:00, Sunday, Week 5 of October	23:59:59, Sunday, Week 5 of March	60 min
Europe	00:00:00, Sunday, Week 5 of March	23:59:59, Sunday, Week 5 of October	60 min
New Zealand	00:00:00, Sunday, Week 1 of October	23:59:59, Sunday, Week 3 of March	60 min
USA	02:00:00, Sunday, Week 2 of March	02:00:00, Sunday, Week 1 of November	60 min

Date Mode – Sets the start, end, and offset times of summer time for the switch on a one-time basis. This mode sets the summer-time zone relative to the currently configured time zone. To specify a time corresponding to your local time when summer time is in effect, you must indicate the number of minutes your summer-time zone deviates from your regular time zone.

- ◆ **Offset** – Summer-time offset from the regular time zone, in minutes. (Range: 1-120 minutes)
- ◆ **From** – Start time for summer-time offset.
- ◆ **To** – End time for summer-time offset.

Recurring Mode – Sets the start, end, and offset times of summer time for the switch on a recurring basis. This mode sets the summer-time zone relative to the currently configured time zone. To specify a time corresponding to your local time when summer time is in effect, you must indicate the number of minutes your summer-time zone deviates from your regular time zone.

- ◆ **Offset** – Summer-time offset from the regular time zone, in minutes. (Range: 1-120 minutes)
- ◆ **From** – Start time for summer-time offset.
- ◆ **To** – End time for summer-time offset.

Web Interface

To specify summer time settings:

1. Click **SNTP > Summer Time**.
2. Select one of the configuration modes, configure the relevant attributes, enable summer time status.
3. Click **Apply**.

The screenshot shows a web interface for configuring Summer Time. The breadcrumb is "System > Time". The current step is "4. Configure Summer Time". The "Summer Time in Effect" is set to "No". The "Status" is "Enabled" with a checked checkbox. The "Name" field is empty. The "Mode" is set to "Predefined". Under "Predefined Mode Configuration", the "Daylight Savings" is set to "Australia". There are "Apply" and "Revert" buttons at the bottom right.

System > Time	
Step: 4. Configure Summer Time	
Summer Time in Effect	No
Status	<input checked="" type="checkbox"/> Enabled
Name	<input type="text"/>
Mode	Predefined
Predefined Mode Configuration	
Daylight Savings	Australia
<input type="button" value="Apply"/> <input type="button" value="Revert"/>	

Configuring the Console Port

Use the System > Console menu to configure connection parameters for the switch's console port. You can access the onboard configuration program by attaching a VT100 compatible device to the switch's serial console port. Management access through the console port is controlled by various parameters, including a password (only configurable through the CLI), time outs, and basic communication settings. Note that these parameters can be configured via the web or CLI interface.

Parameters

The following parameters are displayed:

- ◆ **Login Timeout** – Sets the interval that the system waits for a user to log into the CLI. If a login attempt is not detected within the timeout interval, the connection is terminated for the session. (Range: 10-300 seconds; Default: 300 seconds)
- ◆ **Exec Timeout** – Sets the interval that the system waits until user input is detected. If user input is not detected within the timeout interval, the current session is terminated. (Range: 60-65535 seconds; Default: 600 seconds)
- ◆ **Password Threshold** – Sets the password intrusion threshold, which limits the number of failed logon attempts. When the logon attempt threshold is reached, the system interface becomes silent for a specified amount of time (set by the Silent Time parameter) before allowing the next logon attempt. (Range: 1-120; Default: 3 attempts)
- ◆ **Silent Time** – Sets the amount of time the management console is inaccessible after the number of unsuccessful logon attempts has been exceeded. (Range: 1-65535 seconds; Default: Disabled)
- ◆ **Data Bits** – Sets the number of data bits per character that are interpreted and generated by the console port. If parity is being generated, specify 7 data bits per character. If no parity is required, specify 8 data bits per character. (Default: 8 bits)
- ◆ **Stop Bits** – Sets the number of the stop bits transmitted per byte. (Range: 1-2; Default: 1 stop bit)
- ◆ **Parity** – Defines the generation of a parity bit. Communication protocols provided by some terminals can require a specific parity bit setting. Specify Even, Odd, or None. (Default: None)
- ◆ **Speed** – Sets the terminal line's baud rate for transmit (to terminal) and receive (from terminal). Set the speed to match the baud rate of the device

connected to the serial port. (Range: 9600, 19200, 38400, 57600, or 115200 baud; Default: 115200 baud)

Note:

- ◆ The password for the console connection can only be configured through the CLI (see the “password” command in the *CLI Reference Guide*).
 - ◆ Password checking can be enabled or disabled for logging in to the console connection (see the “login” command in the *CLI Reference Guide*). You can select authentication by a single global password as configured for the password command, or by passwords set up for specific user-name accounts. The default is for local passwords configured on the switch.
-

Web Interface

To configure parameters for the console port:

1. Click **System > Console**.
2. Specify the connection parameters as required.
3. Click **Apply**.

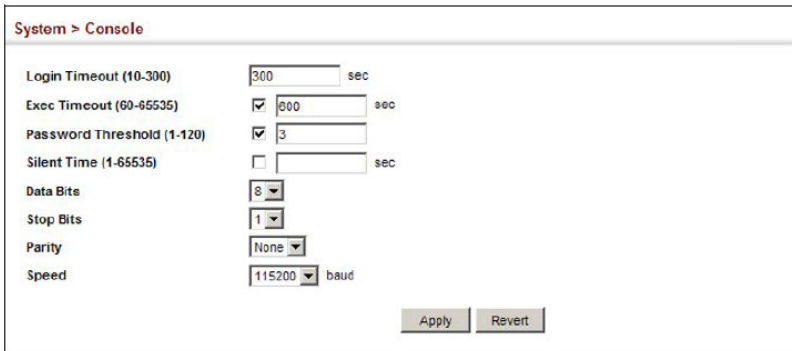

System > Console

Login Timeout (10-300)	<input type="text" value="300"/> sec
Exec Timeout (60-65535)	<input checked="" type="checkbox"/> <input type="text" value="600"/> sec
Password Threshold (1-120)	<input checked="" type="checkbox"/> <input type="text" value="3"/>
Silent Time (1-65535)	<input type="checkbox"/> <input type="text"/> sec
Data Bits	<input type="text" value="8"/>
Stop Bits	<input type="text" value="1"/>
Parity	<input type="text" value="None"/>
Speed	<input type="text" value="115200"/> baud

Configuring Telnet Settings

Use the System > Telnet menu to configure parameters for accessing the CLI over a Telnet connection. You can access the onboard configuration program over the network using Telnet (i.e., a virtual terminal). Management access via Telnet can be enabled/disabled and other parameters set, including the TCP port number, time outs, and a password. Note that the password is only configurable through the CLI.) These parameters can be configured via the web or CLI interface.

Parameters

The following parameters are displayed:

- ◆ **Telnet Status** – Enables or disables Telnet access to the switch. (Default: Enabled)
- ◆ **TCP Port** – Sets the TCP port number for Telnet on the switch. (Range: 1-65535; Default: 23)
- ◆ **Max Sessions** – Sets the maximum number of Telnet sessions that can simultaneously connect to this system. (Range: 0-8; Default: 8)
A maximum of eight sessions can be concurrently opened for Telnet and Secure Shell (i.e., both Telnet and SSH share a maximum number of eight sessions).
- ◆ **Login Timeout** – Sets the interval that the system waits for a user to log into the CLI. If a login attempt is not detected within the timeout interval, the connection is terminated for the session. (Range: 10-300 seconds; Default: 300 seconds)
- ◆ **Exec Timeout** – Sets the interval that the system waits until user input is detected. If user input is not detected within the timeout interval, the current session is terminated. (Range: 60-65535 seconds; Default: 600 seconds)
- ◆ **Password Threshold** – Sets the password intrusion threshold, which limits the number of failed logon attempts. When the logon attempt threshold is reached, the system interface becomes silent for a specified amount of time (set by the Silent Time parameter) before allowing the next logon attempt. (Range: 1-120; Default: 3 attempts)
- ◆ **Silent Time** – Sets the amount of time the management interface is inaccessible after the number of unsuccessful logon attempts has been exceeded. (Range: 1-65535 seconds; Default: Disabled)

Note:

- ♦ The password for the Telnet connection can only be configured through the CLI (see the “password” command in the *CLI Reference Guide*).
 - ♦ Password checking can be enabled or disabled for login to the console connection (see the “login” command in the *CLI Reference Guide*). You can select authentication by a single global password as configured for the password command, or by passwords set up for specific user-name accounts. The default is for local passwords configured on the switch.
-

Web Interface

To configure parameters for the console port:

1. Click **System > Telnet**.
2. Specify the connection parameters as required.
3. Click **Apply**.

System > Telnet

Telnet Status	<input checked="" type="checkbox"/> Enabled
TCP Port (1-65535)	<input type="text" value="23"/>
Max Sessions (0-0)	<input type="text" value="0"/>
Login Timeout (10-300)	<input type="text" value="300"/> sec
Exec Timeout (60-65535)	<input type="text" value="600"/> sec
Password Threshold (1-120)	<input checked="" type="checkbox"/> <input type="text" value="3"/>
Silent Time (1-65535)	<input type="checkbox"/> <input type="text"/> sec

Displaying CPU Utilization

Use the System > CPU Utilization page to display information on CPU utilization.

Parameters

The following parameters are displayed:

- ◆ **Time Interval** – The interval at which to update the displayed utilization rate. (Options: 1, 5, 10, 30, 60 seconds; Default: 1 second)
- ◆ **CPU Utilization** – CPU utilization over specified interval.

Web Interface

To display CPU utilization:

1. Click **System > CPU Utilization**.
2. Change the update interval if required. Note that the interval is changed as soon as a new setting is selected.

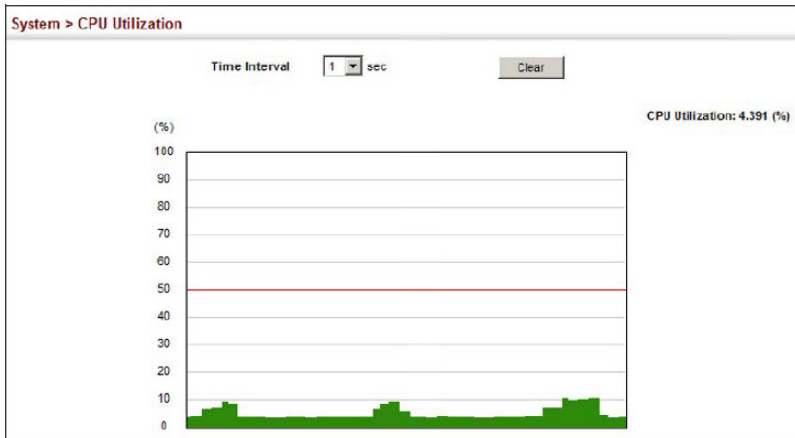

Configuring CPU Guard

Use the System > CPU Guard page to set the CPU utilization high and low watermarks in percentage of CPU time utilized and the CPU high and low thresholds in the number of packets being processed per second.

Parameters

The following parameters are displayed:

- ◆ **CPU Guard Status** – Enables CPU Guard. (Default: Disabled)
- ◆ **High Watermark** – If the percentage of CPU usage time is higher than the high-watermark, the switch stops packet flow to the CPU (allowing it to catch up with packets already in the buffer) until usage time falls below the low watermark. (Range: 40-100 %; Default: 90 %)
- ◆ **Low Watermark** – If packet flow has been stopped after exceeding the high watermark, normal flow will be restored after usage falls beneath the low watermark. (Range: 40-100 %; Default: 70 %)
- ◆ **Maximum Threshold** – If the number of packets being processed by the CPU is higher than the maximum threshold, the switch stops packet flow to the CPU (allowing it to catch up with packets already in the buffer) until the number of packets being processed falls below the minimum threshold. (Range: 50-300 pps; Default: 300 pps)
- ◆ **Minimum Threshold** – If packet flow has been stopped after exceeding the maximum threshold, normal flow will be restored after usage falls beneath the minimum threshold. (Range: 50-300 pps; Default: 50 pps)
- ◆ **Trap Status** – If enabled, an alarm message will be generated when utilization exceeds the high watermark or exceeds the maximum threshold. (Default: Disabled)

Once the high watermark is exceeded, utilization must drop beneath the low watermark before the alarm is terminated, and then exceed the high watermark again before another alarm is triggered.

Once the maximum threshold is exceeded, utilization must drop beneath the minimum threshold before the alarm is terminated, and then exceed the maximum threshold again before another alarm is triggered.

- ◆ **Current Threshold** – Shows the configured threshold in packets per second.

Web Interface

To configure CPU Guard:

1. Click **System > CPU Guard**.
2. Set CPU guard status, configure the watermarks or threshold parameter, enable traps if required.
3. Click **Apply**.

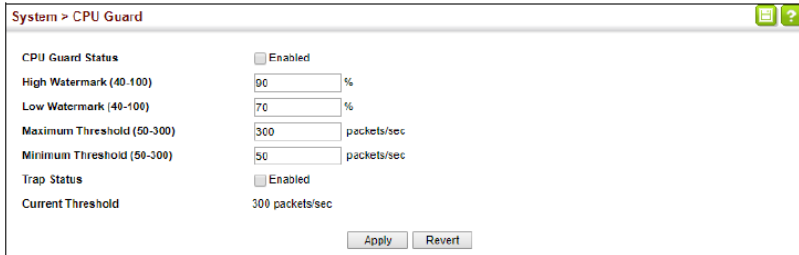

The screenshot shows a web interface window titled "System > CPU Guard". The window contains the following configuration options:

CPU Guard Status	<input type="checkbox"/> Enabled
High Watermark (40-100)	<input type="text" value="00"/> %
Low Watermark (40-100)	<input type="text" value="70"/> %
Maximum Threshold (50-300)	<input type="text" value="300"/> packets/sec
Minimum Threshold (50-300)	<input type="text" value="50"/> packets/sec
Trap Status	<input type="checkbox"/> Enabled
Current Threshold	300 packets/sec

At the bottom right of the window, there are two buttons: "Apply" and "Revert".

Displaying Memory Utilization

Use the System > Memory Status page to display memory utilization parameters.

Parameters

The following parameters are displayed:

- ♦ **Free Size** – The amount of memory currently free for use.
- ♦ **Used Size** – The amount of memory allocated to active processes.
- ♦ **Total** – The total amount of system memory.

Web Interface

To display memory utilization:

1. Click **System > Memory Status**.

System > Memory Status		
Memory Status		
Free Size	590,151,680 bytes	54%
Used Size	483,590,144 bytes	46%
Total	1,073,741,824 bytes	

Resetting the System

Use the System > Reset menu to restart the switch immediately, at a specified time, after a specified delay, or at a periodic interval.

Command Usage

- ◆ This command resets the entire system.
- ◆ When the system is restarted, it will always run the Power-On Self-Test. It will also retain all configuration information stored in non-volatile memory.

Parameters

The following parameters are displayed:

System Reload Information

- ◆ **Reload Settings** – Displays information on the next scheduled reload and selected reload mode as shown in the following example:
“The switch will be rebooted at March 9 12:00:00 2012. Remaining Time: 0 days, 2 hours, 46 minutes, 5 seconds. Reloading switch regularly time: 12:00 everyday.”
- ◆ **Refresh** – Refreshes reload information. Changes made through the console or to system time may need to be refreshed to display the current settings.
- ◆ **Cancel** – Cancels the current settings shown in this field.

System Reload Configuration

- ◆ **Reset Mode** – Restarts the switch immediately or at the specified time(s).
 - ◆ **Immediately** – Restarts the system immediately.
 - ◆ **In** – Specifies an interval after which to reload the switch. (The specified time must be equal to or less than 24 days.)
 - ◆ *hours* – The number of hours, combined with the minutes, before the switch resets. (Range: 0-576)
 - ◆ *minutes* – The number of minutes, combined with the hours, before the switch resets. (Range: 0-34560)
 - ◆ **At** – Specifies a time at which to reload the switch.
 - ◆ **DD** - The day of the month at which to reload. (Range: 01-31)
 - ◆ **MM** - The month at which to reload. (Range: 01-12)
 - ◆ **YYYY** - The year at which to reload. (Range: 1970-2037)
 - ◆ **HH** - The hour at which to reload. (Range: 00-23)

- ♦ MM - The minute at which to reload. (Range: 00-59)
- ♦ **Regularly** – Specifies a periodic interval at which to reload the switch.

Time

- ♦ HH - The hour at which to reload. (Range: 00-23)
- ♦ MM - The minute at which to reload. (Range: 00-59)

Period

- ♦ Daily - Every day.
- ♦ Weekly - Day of the week at which to reload. (Range: Sunday ... Saturday)
- ♦ Monthly - Day of the month at which to reload. (Range: 1-31)

Web Interface

To restart the switch:

1. Click **System > Reset**.
2. Select the required reset mode.
3. For any option other than to reset immediately, fill in the required parameters
4. Click **Apply**.
5. When prompted, confirm that you want reset the switch.

Restarting the Switch (Immediately)

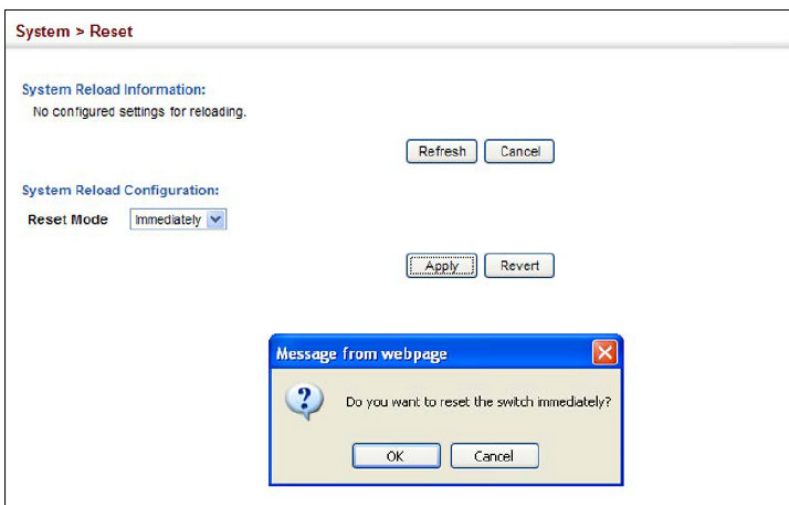

Restarting the Switch (In)

System > Reset

System Reload Information:
 The switch will be rebooted at Jan 1 02:54:25 2001. Remaining Time: 0 days, 1 hours, 10 minutes, 0 seconds.
 Reloading switch in time: 5 hours 26 minutes.
 Reloading switch regularity time: 11:20 everyday.

System Reload Configuration:
 Reset Mode

Reload switch in hours minutes.

Note: The specified time must be equal to or less than 24 days.

Restarting the Switch (At)

System > Reset

System Reload Information:
 The switch will be rebooted at Jan 1 02:54:25 2001. Remaining Time: 0 days, 1 hours, 10 minutes, 0 seconds.
 Reloading switch in time: 5 hours 26 minutes.
 Reloading switch regularity time: 11:20 everyday.

System Reload Configuration:
 Reset Mode

Reload switch at (DD/MM/YYYY) (HH:MM)

Warning: You have to setup system time first. Otherwise this function won't work.

Restarting the Switch (Regularly)

System > Reset

System Reload Information:
No configured settings for reloading.

System Reload Configuration:

Reset Mode ▼

Time (HH:MM)

Period

Daily

Weekly ▼

Monthly ▼

Warning: You have to setup system time first. Otherwise this function won't work.

Chapter 6

Interface Configuration

Overview

This chapter describes the following topics:

- ◆ *Port Configuration* – Configures connection settings, including auto-negotiation, or manual setting of speed, duplex mode, and flow control.
- ◆ *Displaying Statistics* – Shows Interface, Etherlike, and RMON port statistics in table or chart form.
- ◆ *Displaying Statistical History* – Displays statistical history for the specified interfaces.
- ◆ *Displaying Transceiver Data* – Displays identifying information, and operational parameters for optical transceivers which support DDM.
- ◆ *Configuring Transceiver Thresholds* – Configures thresholds for alarm and warning messages for optical transceivers which support DDM.
- ◆ *Cable Test* – Performs cable diagnostics on the specified port.
- ◆ *Trunk Configuration* – Configures static or dynamic trunks.
- ◆ *Saving Power* – Adjusts the power provided to ports based on the length of the cable used to connect to other devices.
- ◆ *Local Port Mirroring* – Sets the source and target ports for mirroring on the local switch.
- ◆ *Remote Port Mirroring* – Configures mirroring of traffic from remote switches for analysis at a destination port on the local switch.
- ◆ *Flow Sampling* – Configures periodic sampling of traffic flows.
- ◆ *Traffic Segmentation* – Configures the uplinks and down links to a segmented group of ports.
- ◆ *VLAN Trunking* – Configures a tunnel across one or more intermediate switches which pass traffic for VLAN groups to which they do not belong.

Port Configuration

This section describes how to configure port connections, mirror traffic from one port to another, and run cable diagnostics.

Configuring by Port List

Use the Interface > Port > General (Configure by Port List) page to enable/disable an interface, set auto-negotiation and the interface capabilities to advertise, or manually fix the speed, duplex mode, and flow control.

Command Usage

The Speed/Duplex mode is fixed at 1000full for Gigabit transceivers, and 10Gfull for 10 Gigabit transceivers.

Note: Auto-negotiation is not supported for SFP/SFP+/SFP28 transceivers.

Parameters

These parameters are displayed:

- ◆ **Port** – Port identifier. (Range: 1-28/54)
- ◆ **Type** – Indicates the port type. (1000BASE-T, 10GBASE SFP+, or 25GBASE SFP+/SFP28)
- ◆ **Name** – Allows you to label an interface. (Range: 1-64 characters)
- ◆ **Admin** – Allows you to manually disable an interface. You can disable an interface due to abnormal behavior (e.g., excessive collisions), and then re-enable it after the problem has been resolved. You may also disable an interface for security reasons. (Default: Enabled)
- ◆ **Media Type** – Configures the forced transceiver mode for SFP/SFP+/SFP28 ports.
 - ◆ **None** - Forced transceiver mode is not used for SFP/SFP+/SFP28 ports.
 - ◆ **SFP-Forced 1000SFP** - Always uses the SFP/SFP+/SFP28 port at 1000 Mbps, Full Duplex.
 - ◆ **SFP-Forced 10GSFP** - Always uses the SFP+/SFP28 port at 10 Gbps, Full Duplex.
- ◆ **Autonegotiation** (Port Capabilities) – Allows auto-negotiation to be enabled/ disabled. When auto-negotiation is enabled, you need to specify the capabilities to be advertised. When auto-negotiation is disabled, you

can force the settings for speed, mode, and flow control. The following capabilities are supported.

- ◆ **10f** - Supports 10 Mbps full-duplex operation.
- ◆ **100f** - Supports 100 Mbps full-duplex operation.
- ◆ **1000f** - Supports 1000 Mbps full-duplex operation.
- ◆ **FC** - Flow control can eliminate frame loss by “blocking” traffic from end stations or segments connected directly to the switch when its buffers fill. When enabled, back pressure is used for half-duplex operation and IEEE 802.3-2005 (formally IEEE 802.3x) for full-duplex operation.

Default: Autonegotiation enabled;

Advertised capabilities for

1000BASE-T – 10full, 100full, 1000full

1000BASE (SFP) – 1000full

10GBASE (SFP+) – 10Gfull

- ◆ **Speed/Duplex** – Displays the port speed and duplex mode. (100full, 10full)
- ◆ **Flow Control** – Enables flow control on the port. (Default: Disabled)

Web Interface

To configure port connection parameters:

1. Click **Interface > Port > General**.
2. Select Configure by Port List from the Action List.
3. Modify the required interface settings.
4. Click **Apply**.

Interface > Port > General

Action: Configure by Port List

Port List Total: 54

Port	Type	Name	Admin	Media Type	Autonegotiation	Speed Duplex	Flow Control
1	1000BASE-T	<input type="text"/>	<input checked="" type="checkbox"/> Enabled	None	<input checked="" type="checkbox"/> Enabled <input checked="" type="checkbox"/> 10f <input checked="" type="checkbox"/> 100f <input checked="" type="checkbox"/> 1000f <input type="checkbox"/> Sym <input type="checkbox"/> FC	100full	<input type="checkbox"/> Enabled
2	1000BASE-T	<input type="text"/>	<input checked="" type="checkbox"/> Enabled	None	<input checked="" type="checkbox"/> Enabled <input checked="" type="checkbox"/> 10f <input checked="" type="checkbox"/> 100f <input checked="" type="checkbox"/> 1000f <input type="checkbox"/> Sym <input type="checkbox"/> FC	100full	<input type="checkbox"/> Enabled
3	1000BASE-T	<input type="text"/>	<input checked="" type="checkbox"/> Enabled	None	<input checked="" type="checkbox"/> Enabled <input checked="" type="checkbox"/> 10f <input checked="" type="checkbox"/> 100f <input checked="" type="checkbox"/> 1000f <input type="checkbox"/> Sym <input type="checkbox"/> FC	100full	<input type="checkbox"/> Enabled

Configuring by Port Range

Use the Interface > Port > General (Configure by Port Range) page to enable/disable an interface or manually fix the speed, duplex mode, and flow control.

Parameters

Except for the trap command, refer to Configuring by Port List for more information on command usage and a description of the parameters.

Web Interface

1. Click **Interface > Port > General**.
2. Select Configure by Port Range from the Action List.
3. Enter a range of ports to which your configuration changes apply.
4. Modify the required interface settings.
5. Click **Apply**.

The screenshot shows the 'Interface > Port > General' configuration page. At the top, the 'Action' is set to 'Configure by Port Range'. Below this, there are several configuration options:

- Port Range (1-54):** Two empty input boxes separated by a hyphen.
- Admin:** A checkbox labeled 'Enabled'.
- Autonegotiation:** A checkbox labeled 'Enabled'.
- Speed Duplex:** A dropdown menu currently showing '10full'.
- Flow Control:** A checkbox labeled 'Enabled'.

At the bottom right of the form, there are two buttons: 'Apply' and 'Revert'.

Displaying Connection Status

Use the Interface > Port > General (Show Information) page to display the current connection status, including link state, speed/duplex mode, flow control, and auto-negotiation.

Parameters

These parameters are displayed:

- ♦ **Port** – Port identifier.
- ♦ **Type** – Indicates the port type. (1000BASE-T, 10GBASE SFP+, or 25GBASE SFP+/SFP28)

- ◆ **Name** – Interface label.
- ◆ **Admin** – Shows if the port is enabled or disabled.
- ◆ **Oper Status** – Indicates if the link is Up or Down.
- ◆ **Shutdown Reason** – Shows the reason this interface has been shut down if applicable. Some of the reasons for shutting down an interface include being administratively disabled, or exceeding traffic boundary limits set by auto traffic control.
- ◆ **Media Type** – Shows the forced transceiver mode for SFP/SFP+/SFP28 ports.
- ◆ **Autonegotiation** – Shows if auto-negotiation is enabled or disabled.
- ◆ **Oper Speed Duplex** – Shows the current speed and duplex mode.
- ◆ **Oper Flow Control** – Shows the flow control type used.

Web Interface

To display port connection parameters:

1. Click **Interface > Port > General**.
2. Select Show Information from the Action List.

Interface > Port > General ?

Action: v

Port List Total: 28 1 2 3

Port	Type	Name	Admin	Oper Status	Shutdown Reason	Media Type	Autonegotiation	Oper Speed Duplex	Oper Flow Control
1	100BASE-T		Enabled	Up		None	Enabled	1000full	None
2	100BASE-T		Enabled	Down	License	None	Enabled	1000full	None
3	100BASE-T		Enabled	Down	License	None	Enabled	1000full	None
4	100BASE-T		Enabled	Down	License	None	Enabled	1000full	None
5	100BASE-T		Enabled	Down	License	None	Enabled	1000full	None
6	100BASE-T		Enabled	Down	License	None	Enabled	1000full	None

Displaying Statistics

Use the Interface > Port/Trunk > Statistics or Chart page to display standard statistics on network traffic from the Interfaces Group and Ethernet-like MIBs, as well as a detailed breakdown of traffic based on the RMON MIB. Interfaces and Ethernet-like statistics display errors on the traffic passing through each port. This information can be used to identify potential problems with the switch (such as a faulty port or unusually heavy loading). RMON statistics provide access to a broad range of statistics, including a total count of different frame types and sizes passing through each port. All values displayed have been accumulated since the last system reboot, and are shown as counts per second. Statistics are refreshed every 60 seconds by default.

Note: RMON groups 2, 3 and 9 can only be accessed using SNMP management software.

Parameters

These parameters are displayed:

Parameter	Description
<i>Interface Statistics</i>	
Received Octets	The total number of octets received on the interface, including framing characters.
Transmitted Octets	The total number of octets transmitted out of the interface, including framing characters.
Received Errors	The number of inbound packets that contained errors preventing them from being deliverable to a higher-layer protocol.
Received Unicast Packets	The number of subnetwork-unicast packets delivered to a higher-layer protocol.
Received Multicast Packets	The number of packets, delivered by this sub-layer to a higher (sub-)layer, which were addressed to a multicast address at this sub-layer.
Received Broadcast Packets	The number of packets, delivered by this sub-layer to a higher (sub-)layer, which were addressed to a broadcast address at this sub-layer.
Transmitted Octets	The total number of octets transmitted out of the interface, including framing characters.
Transmitted Errors	The number of outbound packets that could not be transmitted because of errors.

Parameter	Description
Transmitted Unicast Packets	The total number of packets that higher-level protocols requested be transmitted to a subnetwork-unicast address, including those that were discarded or not sent.
Transmitted Discarded Packets	The number of outbound packets which were chosen to be discarded even though no errors had been detected to prevent their being transmitted. One possible reason for discarding such a packet could be to free up buffer space.
Received Discarded Packets	The number of inbound packets which were chosen to be discarded even though no errors had been detected to prevent their being deliverable to a higher-layer protocol. One possible reason for discarding such a packet could be to free up buffer space.
Transmitted Multicast Packets	The total number of packets that higher-level protocols requested be transmitted, and which were addressed to a multicast address at this sub-layer, including those that were discarded or not sent.
Transmitted Broadcast Packets	The total number of packets that higher-level protocols requested be transmitted, and which were addressed to a broadcast address at this sub-layer, including those that were discarded or not sent.
<i>Etherlike Statistics</i>	
Single Collision Frames	The number of successfully transmitted frames for which transmission is inhibited by exactly one collision.
Multiple Collision Frames	A count of successfully transmitted frames for which transmission is inhibited by more than one collision.
Late Collisions	The number of times that a collision is detected later than 512 bit-times into the transmission of a packet.
Excessive Collisions	A count of frames for which transmission on a particular interface fails due to excessive collisions. This counter does not increment when the interface is operating in full-duplex mode.
Deferred Transmissions	A count of frames for which the first transmission attempt on a particular interface is delayed because the medium was busy.
Frames Too Long	A count of frames received on a particular interface that exceed the maximum permitted frame size.
FCS Errors	A count of frames received on a particular interface that are an integral number of octets in length but do not pass the FCS check. This count does not include frames received with frame-too-long or frame-too-short error.
Internal MAC Transmit Errors	A count of frames for which transmission on a particular interface fails due to an internal MAC sublayer transmit error.
Pause Frames Input	If the counter is incrementing this means that the port is receiving pause frames.
Pause Frames Output	Pause outputs occur when the receiving port is getting overloaded and the device sends a pause request to the device connected to the port.

Parameter	Description
Symbol Errors	The number of times there was an invalid data symbol when a valid carrier was present.
<i>RMON Statistics</i>	
Drop Events	The total number of events in which packets were dropped due to lack of resources.
Jabbers	The total number of frames received that were longer than 1518 octets (excluding framing bits, but including FCS octets), and had either an FCS or alignment error.
Fragments	The total number of frames received that were less than 64 octets in length (excluding framing bits, but including FCS octets) and had either an FCS or alignment error.
Collisions	The best estimate of the total number of collisions on this Ethernet segment.
Received Octets	Total number of octets of data received on the network. This statistic can be used as a reasonable indication of Ethernet utilization.
Received Packets	The total number of packets (bad, broadcast and multicast) received.
Broadcast Packets	The total number of good packets received that were directed to the broadcast address. Note that this does not include multicast packets.
Multicast Packets	The total number of good packets received that were directed to this multicast address.
Undersize Packets	The total number of packets received that were less than 64 octets long (excluding framing bits, but including FCS octets) and were otherwise well formed.
Oversize Packets	The total number of packets received that were longer than 1518 octets (excluding framing bits, but including FCS octets) and were otherwise well formed.
64 Bytes Packets	The total number of packets (including bad packets) received and transmitted that were 64 octets in length (excluding framing bits but including FCS octets).
65-127 Byte Packets 128-255 Byte Packets 256-511 Byte Packets 512-1023 Byte Packets 1024-1518 Byte Packets 1519-1536 Byte Packets	The total number of packets (including bad packets) received and transmitted where the number of octets fall within the specified range (excluding framing bits but including FCS octets).
CRC Align Errors	Alignment errors are the count of the number of frames received that do not end with an even number of octets and have a bad Cyclic Redundancy Check (CRC)
<i>Utilization Statistics</i>	
Input Octets in kbits per second	Number of octets entering this interface in kbits/second.

Parameter	Description
Input Packets per second	Number of packets entering this interface per second.
Input Utilization	The input utilization rate for this interface.
Output Octets in kbits per second	Number of octets leaving this interface in kbits/second.
Output Packets per second	Number of packets leaving this interface per second.
Output Utilization	The output utilization rate for this interface.

Web Interface

To show a list of port statistics:

1. Click **Interface > Port > Statistics**.
2. Select the statistics mode to display (Interface, Etherlike, RMON or Utilization).
3. Select a port from the drop-down list.
4. Use the Refresh button to update the screen.

Interface > Port > Statistics

Mode: Interface Etherlike RMON Utilization

Port: 1

Auto-refresh

Interface Statistics

Received Octets	3528337
Received Errors	0
Received Unicast Packets	45910
Received Discarded Packets	0
Received Multicast Packets	33
Received Broadcast Packets	154
Transmitted Octets	62300537
Transmitted Errors	0
Transmitted Unicast Packets	46224
Transmitted Multicast Packets	212
Transmitted Broadcast Packets	6

Clear Refresh

To show a chart of port statistics:

1. Click **Interface > Port > Chart**.
2. Select the statistics mode to display (Interface, Etherlike, RMON or All).

3. If Interface, Etherlike, RMON statistics mode is chosen, select a port from the drop-down list. If All (ports) statistics mode is chosen, select the statistics type to display.

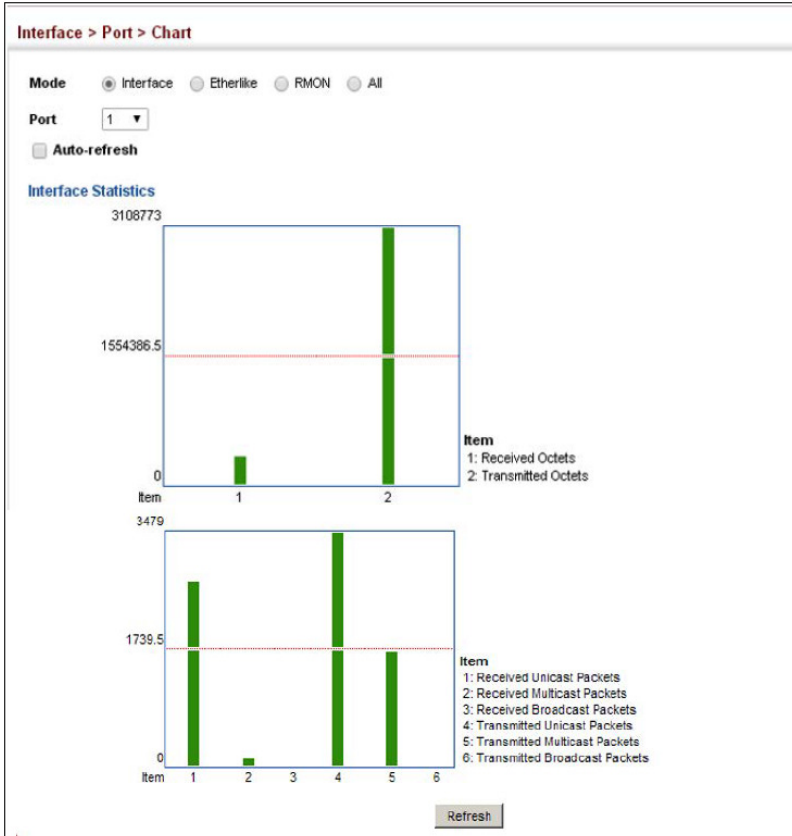

Displaying Statistical History

Use the Interface > Port > History or Interface > Trunk > History page to display statistical history for the specified interfaces.

Command Usage

- ◆ For a description of the statistics displayed on these pages, see Showing Port or Trunk Statistics.
- ◆ To configure statistical history sampling, use the Displaying Statistical History.

Parameters

These parameters are displayed:

Add

- ◆ **Port** – Port number. (Range: 1-28/54)
- ◆ **History Name** – Name of sample interval. (Range: 1-31 characters)
- ◆ **Interval** - The interval for sampling statistics. (Range: 1-86400 minutes)
- ◆ **Requested Buckets** - The number of samples to take. (Range: 1-96)

Show

- ◆ **Port** – Port number. (Range: 1-28/54)
- ◆ **History Name** – Name of sample interval. (Default settings: 15min, 1day)
- ◆ **Interval** - The interval for sampling statistics.
- ◆ **Requested Buckets** - The number of samples to take.

Show Details

- ◆ **Mode**
 - ◆ **Status** – Shows the sample parameters.
 - ◆ **Current Entry** – Shows current statistics for the specified port and named sample.
 - ◆ **Input Previous Entries** – Shows statistical history for ingress traffic.
 - ◆ **Output Previous Entries** – Shows statistical history for egress traffic.
- ◆ **Port** – Port number. (Range: 1-28/54)
- ◆ **Name** – Name of sample interval.

Web Configuration

To configure a periodic sample of statistics:

1. Click **Interface > Port > Statistics**, or **Interface, Trunk, Statistics**.
2. Select Add from the Action menu.
3. Select an interface from the Port or Trunk list.
4. Enter the sample name, the interval, and the number of buckets requested.
5. Click **Apply**.

The screenshot shows the 'Interface > Port > History' configuration page. At the top, the breadcrumb 'Interface > Port > History' is displayed. Below it, the 'Action:' dropdown is set to 'Add'. There are three input fields: 'Port' with a dropdown menu showing '1', 'History Name' with an empty text box, 'Interval (1-86400)' with a text box and 'seconds' label, and 'Requested Buckets (1-96)' with a text box. At the bottom right, there are 'Apply' and 'Revert' buttons.

To show the configured entries for a history sample:

1. Click **Interface > Port > Statistics**, or **Interface, Trunk, Statistics**.
2. Select Show from the Action menu.
3. Select an interface from the Port or Trunk list.

The screenshot shows the 'Interface > Port > History' configuration page. At the top, the breadcrumb 'Interface > Port > History' is displayed. Below it, the 'Action:' dropdown is set to 'Show'. There is a 'Port' dropdown menu showing '1'. Below that, the text 'History Name List Total: 3' is shown. A table with 4 columns is displayed: 'History Name', 'Interval', and 'Requested Buckets'. Each row has a checkbox in the first column. At the bottom right, there are 'Delete' and 'Revert' buttons.

<input type="checkbox"/>	History Name	Interval	Requested Buckets
<input type="checkbox"/>	15min	900	96
<input type="checkbox"/>	1day	86400	7
<input type="checkbox"/>	rd#1	60	50

To show the configured parameters for a sampling entry:

1. Click **Interface > Port > Statistics**, or **Interface, Trunk, Statistics**.
2. Select Show Details from the Action menu.
3. Select Status from the options for Mode.
4. Select an interface from the Port or Trunk list.

5. Select an sampling entry from the Name list.

The screenshot shows the 'Interface > Port > History' page. At the top, there is an 'Action:' dropdown menu set to 'Show Details'. Below this are four radio buttons for 'Mode': 'Status' (selected), 'Current Entry', 'Input Previous Entries', and 'Output Previous Entries'. There are also dropdown menus for 'Port' (set to '1') and 'Name' (set to '15min'). The main content area is titled 'History Status' and contains the following information:

Name	15min
Interval	900 second(s)
Requested Buckets	96
Granted Buckets	19
Status	Active

At the bottom of the section is a 'Refresh' button.

To show statistics for the current interval of a sample entry:

1. Click **Interface > Port > Statistics**, or **Interface, Trunk, Statistics**.
2. Select Show Details from the Action menu.
3. Select Current Entry from the options for Mode.
4. Select an interface from the Port or Trunk list.
5. Select an sampling entry from the Name list.

The screenshot shows the 'Interface > Port > History' page with the 'Current Entry' mode selected. The 'Action:' dropdown is still 'Show Details'. The 'Mode' radio buttons are now: 'Status', 'Current Entry' (selected), 'Input Previous Entries', and 'Output Previous Entries'. The 'Port' and 'Name' dropdowns remain '1' and '15min' respectively. The main content area is titled 'Current Entry' and shows the following statistics:



Start Time	00d 01:00:00		
%	0.00	%	0.00
Received Octets	47207	Transmitted Octets	338235
Received Errors	0	Transmitted Errors	0
Received Unicast Packets	195	Transmitted Unicast Packets	299
Received Discarded Packets	0	Transmitted Discarded Packets	0
Received Multicast Packets	10	Transmitted Multicast Packets	3
Received Broadcast Packets	71	Transmitted Broadcast Packets	0
Received Unknown Packets	0		

At the bottom of the section is a 'Refresh' button.

To show ingress or egress traffic statistics for a sample entry:

1. Click **Interface > Port > Statistics**, or **Interface, Trunk, Statistics**.
2. Select Show Details from the Action menu.

3. Select Input Previous Entry or Output Previous Entry from the options for Mode.
4. Select an interface from the Port or Trunk list.
5. Select an sampling entry from the Name list.

Interface > Port > History  

Action:

Mode: Status Current Entry Input Previous Entries Output Previous Entries

Port:

Name:

Input Previous Entry List Total: 10

Start Time	%	Octets	Unicast	Multicast	Broadcast	Errors
00d 00:00:02	0.00	523806	3774	537	90	0
00d 00:15:03	0.00	466715	3147	503	1	0
00d 00:30:03	0.00	465432	3135	510	3	0
00d 00:45:03	0.00	464422	3135	502	0	0
00d 01:00:03	0.00	426164	2908	513	0	0
00d 01:15:03	0.00	355595	2427	515	4	0
00d 01:30:03	0.00	354092	2475	508	1	0
00d 01:45:03	0.00	353187	2179	503	0	0
00d 02:00:03	0.00	367193	2590	507	0	0
00d 02:15:03	0.00	374615	2645	507	0	0

Displaying Transceiver Data

Use the Interface > Port > Transceiver page to display identifying information, and operational for optical transceivers which support Digital Diagnostic Monitoring (DDM).

Parameters

These parameters are displayed:

- ◆ **Port** – Port number. (Range: 1-28/54)
- ◆ **General** – Information on connector type and vendor-related parameters.
- ◆ **DDM Information** – Information on temperature, supply voltage, laser bias current, laser power, and received optical power.

The switch can display diagnostic information for SFP modules which support the SFF-8472 Specification for Diagnostic Monitoring Interface for Optical Transceivers. This information allows administrators to remotely diagnose problems with optical devices. This feature, referred to as Digital Diagnostic Monitoring (DDM) provides information on transceiver parameters.

Web Interface

To display identifying information and functional parameters for optical transceivers:

1. Click **Interface > Port > Transceiver**.
2. Select a port from the scroll-down list.

Interface > Port > Transceiver

Port

General

Connector Type	LC
Fiber Type	Multimode 50um (M5), Multimode 62.5um (M6)
Eth Compliance Codes	1000BASE-SX
Baud Rate	2100 MBd
Vendor OUI	00-90-65
Vendor Name	FINISAR CORP.
Vendor PN	FTL_F8519P3BTL
Vendor Rev	A
Vendor S/N	PKM1XUJ
Date Code	11-05-25

DDM Information

Temperature	33.85 °C
Vcc	3.20 V
Bias Current	5.50 mA
TX Power	-5.50 dBm
RX Power	-35.23 dBm

Configuring Transceiver Thresholds

Use the Interface > Port > Transceiver page to configure thresholds for alarm and warning messages for optical transceivers which support Digital Diagnostic Monitoring (DDM). This page also displays identifying information for supported transceiver types, and operational parameters for transceivers which support DDM.

Parameters

These parameters are displayed:

- ◆ **Port** – Port number. (Range: 1-28/54)
- ◆ **General** – Information on connector type and vendor-related parameters.
- ◆ **DDM Information** – Information on temperature, supply voltage, laser bias current, laser power, and received optical power.

The switch can display diagnostic information for SFP modules which support the SFF-8472 Specification for Diagnostic Monitoring Interface for Optical Transceivers. This information allows administrators to remotely diagnose problems with optical devices. This feature, referred to as Digital Diagnostic Monitoring (DDM) provides information on transceiver parameters.

- ◆ **Trap** – Sends a trap when any of the transceiver's operation values falls outside of specified thresholds. (Default: Disabled)
- ◆ **Auto Mode** – Uses default threshold settings obtained from the transceiver to determine when an alarm or trap message should be sent. (Default: Enabled)
- ◆ **DDM Thresholds** – Information on alarm and warning thresholds. The switch can be configured to send a trap when the measured parameter falls outside of the specified thresholds.

The following alarm and warning parameters are supported:

- ◆ **High Alarm** – Sends an alarm message when the high threshold is crossed.
- ◆ **High Warning** – Sends a warning message when the high threshold is crossed.
- ◆ **Low Warning** – Sends a warning message when the low threshold is crossed.
- ◆ **Low Alarm** – Sends an alarm message when the low threshold is crossed.

The configurable ranges are:

- ◆ **Temperature:** -128.00-128.00 °C
- ◆ **Voltage:** 0.00-6.55 Volts
- ◆ **Current:** 0.00-131.00 mA
- ◆ **Power:** -40.00-8.20 dBm

The threshold value for Rx and Tx power is calculated as the power ratio in decibels (dB) of the measured power referenced to one milliwatt (mW).

Threshold values for alarm and warning messages can be configured as described below.

- ◆ A high-threshold alarm or warning message is sent if the current value is greater than or equal to the threshold, and the last sample value was less than the threshold. After a rising event has been generated, another such event will not be generated until the sampled value has fallen below the high threshold and reaches the low threshold.
- ◆ A low-threshold alarm or warning message is sent if the current value is less than or equal to the threshold, and the last sample value was greater than the threshold. After a falling event has been generated, another such event will not be generated until the sampled value has risen above the low threshold and reaches the high threshold.
- ◆ Threshold events are triggered as described above to avoid a hysteresis effect which would continuously trigger event messages if the power level were to fluctuate just above and below either the high threshold or the low threshold.
- ◆ Trap messages configured by this command are sent to any management station configured as an SNMP trap manager using the Administration > SNMP (Configure Trap) page.

Web Interface

To configure threshold values for optical transceivers:

1. Click **Interface > Port > Transceiver**.
2. Select a port from the scroll-down list.
3. Set the switch to send a trap based on default or manual settings.
4. Set alarm and warning thresholds if manual configuration is used.
5. Click **Apply**.

DDM Thresholds

Trap

Auto Mode

	High Alarm	High Warning	Low Warning	Low Alarm
Temperature(°C)	<input type="text" value="75.00"/>	<input type="text" value="70.00"/>	<input type="text" value="0.00"/>	<input type="text" value="-123.00"/>
Voltage(Volts)	<input type="text" value="3.50"/>	<input type="text" value="3.45"/>	<input type="text" value="3.15"/>	<input type="text" value="3.10"/>
Current(mA)	<input type="text" value="100.00"/>	<input type="text" value="90.00"/>	<input type="text" value="7.00"/>	<input type="text" value="6.00"/>
Tx Power(dBm)	<input type="text" value="-9.00"/>	<input type="text" value="-9.50"/>	<input type="text" value="-11.50"/>	<input type="text" value="-12.00"/>
Rx Power(dBm)	<input type="text" value="-3.00"/>	<input type="text" value="-3.50"/>	<input type="text" value="-21.00"/>	<input type="text" value="-21.50"/>

[Click this button to restore default DDM thresholds values.](#)

Cable Test

Use the Interface > Port > Cable Test page to test the cable attached to a port. The cable test will check for any cable faults (short, open, etc.). If a fault is found, the switch reports the length to the fault. Otherwise, it reports the cable length. It can be used to determine the quality of the cable, connectors, and terminations. Problems such as opens, shorts, and cable impedance mismatch can be diagnosed with this test.

Command Usage

- ◆ Cable diagnostics are performed using Time Domain Reflectometry (TDR). TDR detects a cable fault by sending a signal through the cable and reading the signal that is reflected back. TDR can only determine if a link is valid or faulty.
- ◆ Cable diagnostics can only be performed on twisted-pair media.
- ◆ This cable test is only accurate for Gigabit Ethernet cables 7 - 100 meters long.
- ◆ The test takes approximately 5 seconds. The switch displays the results of the test immediately upon completion, including common cable failures, as well as the status and approximate length to a fault.
- ◆ Potential conditions which may be listed by the diagnostics include those listed below. Note that TDR testing can only show Test failed or OK.
 - ◆ Test failed
 - ◆ OK: Correctly terminated pair
 - ◆ Open: Open pair, no link partner
 - ◆ Short: Shorted pair
 - ◆ Impedance mismatch: Terminating impedance is not in the reference range.
 - ◆ No cable
 - ◆ Not tested
 - ◆ Not Supported: This message is displayed for any Gigabit Ethernet ports linked up at a speed lower than 1000 Mbps, or for any 10G Ethernet ports.
 - ◆ Unknown – Unknown error
- ◆ Ports are linked down while running cable diagnostics.

Parameters

These parameters are displayed:

- ◆ **Port** – Switch port identifier.
- ◆ **Type** – Displays media type. (GE – Gigabit Ethernet, Other – SFP)
- ◆ **Link Status** – Shows if the port link is up or down.
- ◆ **Test Result** – The results include common cable failures, as well as the status and approximate distance to a fault, or the approximate cable length if no fault is found.

To ensure more accurate measurement of the length to a fault, first disable power-saving mode on the link partner before running cable diagnostics.

For link-down ports, the reported distance to a fault is accurate to within +/- 2 meters. For link-up ports, the accuracy is +/- 10 meters.

- ◆ **Last Updated** – Shows the last time this port was tested.
- ◆ **Test** – Initiates cable test.

Web Interface

To test the cable attached to a port:

1. Click **Interface > Port > Cable Test**.
2. Click **Test** for any port to start the cable test.

Interface > Port > Cable Test

Cable Test Port List Total: 28

Port	Type	Link Status	Test Result (Cable/Fault Distance in Meters)				Last Updated	Action
			Pair A (meters)	Pair B (meters)	Pair C (meters)	Pair D (meters)		
1	GE	Up	Not Tested	Not Tested	Not Tested	Not Tested		Test
2	GE	Down	Not Tested	Not Tested	Not Tested	Not Tested		Test
3	GE	Down	Not Tested	Not Tested	Not Tested	Not Tested		Test
4	GE	Down	Not Tested	Not Tested	Not Tested	Not Tested		Test
5	GE	Down	Not Tested	Not Tested	Not Tested	Not Tested		Test
6	GE	Down	Not Tested	Not Tested	Not Tested	Not Tested		Test
7	GE	Down	Not Tested	Not Tested	Not Tested	Not Tested		Test
8	GE	Down	Not Tested	Not Tested	Not Tested	Not Tested		Test
9	GE	Down	Not Tested	Not Tested	Not Tested	Not Tested		Test
10	GE	Down	Not Tested	Not Tested	Not Tested	Not Tested		Test

Note: After every test action, wait several seconds and click the refresh button to display test results.

Refresh

Trunk Configuration

This section describes how to configure static and dynamic trunks.

You can create multiple links between devices that work as one virtual, aggregate link. A port trunk offers a dramatic increase in bandwidth for network segments where bottlenecks exist, as well as providing a fault-tolerant link between two devices. You can create up to 28 trunks at a time on the switch.

The switch supports both static trunking and dynamic Link Aggregation Control Protocol (LACP). Static trunks have to be manually configured at both ends of the link, and the switches must comply with the Cisco EtherChannel standard. On the other hand, LACP configured ports can automatically negotiate a trunked link with LACP-configured ports on another device. You can configure any number of ports on the switch as LACP, as long as they are not already configured as part of a static trunk. If ports on another device are also configured as LACP, the switch and the other device will negotiate a trunk link between them. If an LACP trunk consists of more than eight ports, all other ports will be placed in standby mode. Should one link in the trunk fail, one of the standby ports will automatically be activated to replace it.

Command Usage

Besides balancing the load across each port in the trunk, the other ports provide redundancy by taking over the load if a port in the trunk fails. However, before making any physical connections between devices, use the web interface or CLI to specify the trunk on the devices at both ends. When using a trunk, take note of the following points:

- ◆ Finish configuring trunks before you connect the corresponding network cables between switches to avoid creating a loop.
- ◆ You can create up to 28 trunks on a switch, with up to eight ports per trunk.
- ◆ The ports at both ends of a connection must be configured as trunk ports.
- ◆ When configuring static trunks on switches of different types, they must be compatible with the Cisco EtherChannel standard.
- ◆ The ports at both ends of a trunk must be configured in an identical manner, including communication mode (i.e., speed, duplex mode and flow control), VLAN assignments, and CoS settings.
- ◆ Any of the Gigabit ports on the front panel can be trunked together, including ports of different media types.
- ◆ All the ports in a trunk have to be treated as a whole when moved from/to, added or deleted from a VLAN.

- ◆ STP, VLAN, and IGMP settings can only be made for the entire trunk.

Configuring a Static Trunk

Use the Interface > Trunk > Static page to create a trunk, assign member ports, and configure the connection parameters.

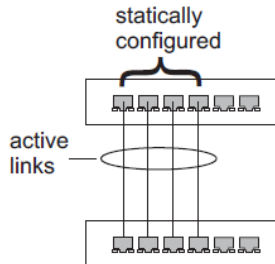

Command Usage

- ◆ Note that the static trunks on this switch are Cisco EtherChannel compatible.
- ◆ To avoid creating a loop in the network, be sure you add a static trunk via the configuration interface before connecting the ports, and also disconnect the ports before removing a static trunk via the configuration interface.

Parameters

These parameters are displayed:

- ◆ **Trunk ID** – Trunk identifier. (Range: 1-28)
- ◆ **Member** – The initial trunk member. Use the Add Member page to configure additional members.
 - ◆ **Unit** – Unit identifier. (Range: 1)
 - ◆ **Port** – Port identifier. (Range: 1-28/54)

Web Interface

To create a static trunk:

1. Click **Interface > Trunk > Static**.
2. Select Configure Trunk from the Step list.
3. Select Add from the Action list.

4. Enter a trunk identifier.
5. Set the unit and port for the initial trunk member.
6. Click **Apply**.

Interface > Trunk > Static

Step: 1. Configure Trunk Action: Add

Trunk ID (1-28)

Member Unit 1 Port 1

Apply Revert

To add member ports to a static trunk:

1. Click **Interface > Trunk > Static**.
2. Select Configure Trunk from the Step list.
3. Select Add Member from the Action list.
4. Select a trunk identifier.
5. Set the unit and port for an additional trunk member.
6. Click **Apply**.

Interface > Trunk > Static

Step: 1. Configure Trunk Action: Add Member

Trunk 1

Member Unit 1 Port 2

Apply Revert

To configure connection parameters for a static trunk:

1. Click **Interface > Trunk > Static**.
2. Select Configure General from the Step list.
3. Select Configure from the Action list.
4. Modify the required interface settings. (Refer to Configuring by Port List for a description of the parameters.)
5. Click **Apply**.

Interface > Trunk > Static ?

Step: 2. Configure General Action: Configure

Static Trunk List Total: 1

Trunk	Type	Name	Admin	Autonegotiation	Speed Duplex	Flow Control
1	1000BASE-T		<input checked="" type="checkbox"/> Enabled	<input checked="" type="checkbox"/> Enabled <input checked="" type="checkbox"/> 10h <input checked="" type="checkbox"/> 10f <input checked="" type="checkbox"/> 100f <input type="checkbox"/> FC	1000full	<input type="checkbox"/> Enabled

Apply Revert

To display trunk connection parameters:

1. Click **Interface > Trunk > Static**.
2. Select Configure General from the Step list.
3. Select Show Information from the Action list.

Interface > Trunk > Static ?

Step: 2. Configure General Action: Show Information

Static Trunk List Total: 1

Trunk	Type	Name	Admin	Oper Status	Shutdown Reason	Autonegotiation	Oper Speed Duplex	Oper Flow Control
1	1000BASE-T		Enabled	Down		Enabled	1000full	None

Configuring a Dynamic Trunk

Use the Interface > Trunk > Dynamic pages to set the administrative key for an aggregation group, enable LACP on a port, configure protocol parameters for local and partner ports, or to set Ethernet connection parameters.

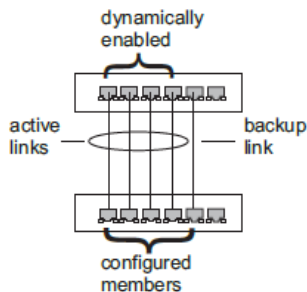

Command Usage

- ◆ To avoid creating a loop in the network, be sure you enable LACP before connecting the ports, and also disconnect the ports before disabling LACP.

- ♦ If the target switch has also enabled LACP on the connected ports, the trunk will be activated automatically.
- ♦ A trunk formed with another switch using LACP will automatically be assigned the next available trunk ID.
- ♦ If more than eight ports attached to the same target switch have LACP enabled, the additional ports will be placed in standby mode, and will only be enabled if one of the active links fails.
- ♦ All ports on both ends of an LACP trunk must be configured for full duplex.
- ♦ Ports are only allowed to join the same Link Aggregation Group (LAG) if (1) the LACP port system priority matches, (2) the LACP port admin key matches, and (3) the LAG admin key matches (if configured). However, if the LAG admin key is set, then the port admin key must be set to the same value for a port to be allowed to join that group.

Note: If the LACP admin key is not set when a channel group is formed (i.e., it has a null value of 0), the operational key is set to the same value as the operational key of the first member port (see the “show lacp internal” command in the *CLI Reference Guide*).

Parameters

These parameters are displayed:

Configure Aggregator

- ♦ **Admin Key** – LACP administration key is used to identify a specific link aggregation group (LAG) during local LACP setup on the switch. (Range: 0-65535)

If the port channel admin key is not set when a channel group is formed (i.e., it has the null value of 0), the port channel operational key is set to the same value as the first member port operational key (see *Configure Aggregation Port - Actor/Partner*). Note that when the LAG is no longer used, the port channel operational key is reset to 0.

- ♦ **Timeout Mode** – The timeout to wait for the next LACP data unit (LACPDU):
 - ♦ **Long Timeout** – Specifies a slow timeout of 90 seconds. (This is the default setting.)
 - ♦ **Short Timeout** – Specifies a fast timeout of 3 seconds.

The timeout is set in the LACP timeout bit of the Actor State field in transmitted LACPDU. When the partner switch receives an LACPDU set

with a short timeout from the actor switch, the partner adjusts the transmit LACPDU interval to 1 second. When it receives an LACPDU set with a long timeout from the actor, it adjusts the transmit LACPDU interval to 30 seconds.

If the actor does not receive an LACPDU from its partner before the configured timeout expires, the partner port information will be deleted from the LACP group.

When a dynamic port-channel member leaves a port-channel, the default timeout value will be restored on that port.

When a dynamic port-channel is torn down, the configured timeout value will be retained. When the dynamic port-channel is constructed again, that timeout value will be used.

- ♦ **System Priority** – LACP system priority is used to determine link aggregation group (LAG) membership, and to identify this device to other switches during LAG negotiations.
- ♦ **System MAC Address** – The device MAC address assigned to each trunk.

Configure Aggregation Port - General

- ♦ **Port** – Port identifier. (Range: 1-28/54)
- ♦ **LACP Status** – Enables or disables LACP on a port.

Configure Aggregation Port - Actor/Partner

- ♦ **Port** – Port number. (Range: 1-28/54)
- ♦ **Mode** – Specifies the port's LACP activity mode.
 - ♦ **Active** – Specifies the port's activity mode to initiate and transmit LACP negotiation packets.
 - ♦ **Passive** – Specifies the port's activity mode to only respond to LACP negotiation packets.
- ♦ **Admin Key** – The LACP administration key must be set to the same value for ports that belong to the same LAG. (Range: 0-65535; Default – Actor: 1, Partner: 0)

Once the remote side of a link has been established, LACP operational settings are already in use on that side. Configuring LACP settings for the partner only applies to its administrative state, not its operational state.

Note: Configuring the partner admin-key does not affect remote or local switch operation. The local switch just records the partner admin-key for user reference.

If the admin key is not set, the actor's operational key is determined by the port's link speed (10G - 5, 1000f - 4, 100f - 3, 10f - 2).

- ◆ **System Priority** – LACP system priority is used to determine link aggregation group (LAG) membership, and to identify this device to other switches during LAG negotiations. (Range: 0-65535; Default: 32768)
System priority is combined with the switch's MAC address to form the LAG identifier. This identifier is used to indicate a specific LAG during LACP negotiations with other systems.
- ◆ **Port Priority** – If a link goes down, LACP port priority is used to select a backup link. (Range: 0-65535; Default: 32768)
 - ◆ Setting a lower value indicates a higher effective priority.
 - ◆ If an active port link goes down, the backup port with the highest priority is selected to replace the downed link. However, if two or more ports have the same LACP port priority, the port with the lowest physical port number will be selected as the backup port.
 - ◆ If an LAG already exists with the maximum number of allowed port members, and LACP is subsequently enabled on another port using a higher priority than an existing member, the newly configured port will replace an existing port member that has a lower priority.

Note:

- ◆ Configuring LACP settings for a port only applies to its administrative state, not its operational state, and will only take effect the next time an aggregate link is established with that port.
 - ◆ Configuring the port partner sets the remote side of an aggregate link; i.e., the ports on the attached device. The command attributes have the same meaning as those used for the port actor.
-

Web Interface

To configure the admin key for a dynamic trunk:

1. Click **Interface > Trunk > Dynamic**.
2. Select Configure Aggregator from the Step list.
3. Set the Admin Key and timeout mode for the required LACP group.
4. Click **Apply**.

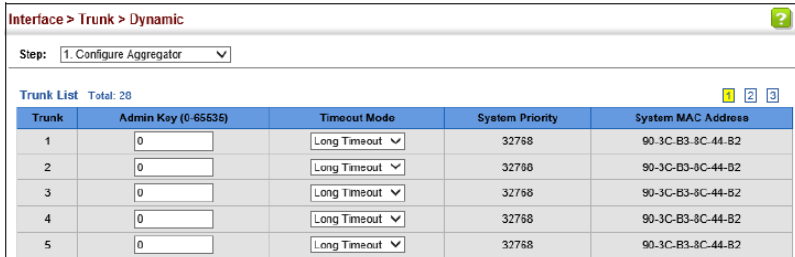

Interface > Trunk > Dynamic

Step: 1. Configure Aggregator

Trunk List Total: 20

Trunk	Admin Key (0-65535)	Timeout Mode	System Priority	System MAC Address
1	0	Long Timeout	32768	90-3C-B3-8C-44-B2
2	0	Long Timeout	32768	90-3C-B3-8C-44-B2
3	0	Long Timeout	32768	90-3C-B3-8C-44-B2
4	0	Long Timeout	32768	90-3C-B3-8C-44-B2
5	0	Long Timeout	32768	90-3C-B3-8C-44-B2

To enable LACP for a port:

1. Click **Interface > Trunk > Dynamic**.
2. Select Configure Aggregation Port from the Step list.
3. Select Configure from the Action list.
4. Click **General**.
5. Enable LACP on the required ports.
6. Click **Apply**.

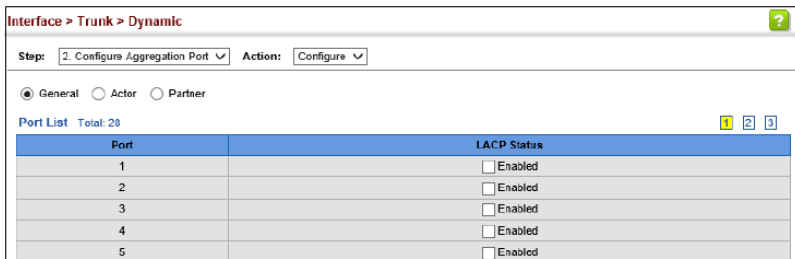

Interface > Trunk > Dynamic

Step: 2. Configure Aggregation Port Action: Configure

General Actor Partner

Port List Total: 20

Port	LACP Status
1	<input type="checkbox"/> Enabled
2	<input type="checkbox"/> Enabled
3	<input type="checkbox"/> Enabled
4	<input type="checkbox"/> Enabled
5	<input type="checkbox"/> Enabled

To configure LACP parameters for group members:

1. Click **Interface > Trunk > Dynamic**.
2. Select Configure Aggregation Port from the Step list.
3. Select Configure from the Action list.

4. Click **Actor** or **Partner**.
5. Configure the required settings.
6. Click **Apply**.

Interface > Trunk > Dynamic

Step: 2. Configure Aggregation Port Action: Configure

General Actor Partner

Port List Total: 28

Port	Mode	Admin Key (0-65535)	System Priority (0-65535)	Port Priority (0-65535)
1	Active	4	32768	32768
2	Active	4	32768	32768
3	Active	4	32768	32768
4	Active	4	32768	32768
5	Active	4	32768	32768

To show the active members of a dynamic trunk:

1. Click **Interface > Trunk > Dynamic**.
2. Select Configure Trunk from the Step list.
3. Select Show Member from the Action list.
4. Select a Trunk.

Interface > Trunk > Dynamic

Step: 3. Configure Trunk Action: Show Member

Trunk: 1

Member List Total: 2

Member (Unit/Port)
1/1
1/2

To configure connection parameters for a dynamic trunk:

1. Click **Interface > Trunk > Dynamic**.
2. Select Configure Trunk from the Step list.
3. Select Configure from the Action list.
4. Modify the required interface settings. (See Configuring by Port List for a description of the interface settings.)
5. Click **Apply**.

Interface > Trunk > Dynamic

Step: 3. Configure Trunk Action: Configure

Dynamic Trunk List Total: 1

Trunk	Type	Name	Admin	Autonegotiation	Speed Duplex	Flow Control
1	1000BASE-T		Enabled	<input checked="" type="checkbox"/> Enabled <input checked="" type="checkbox"/> 10h <input checked="" type="checkbox"/> 100h <input checked="" type="checkbox"/> 10f <input checked="" type="checkbox"/> 100f <input type="checkbox"/> FC	100Full	Enabled

Apply Revert

To show connection parameters for a dynamic trunk:

1. Click **Interface > Trunk > Dynamic**.
2. Select Configure Trunk from the Step list.
3. Select Show from the Action list.

Interface > Trunk > Dynamic

Step: 3. Configure Trunk Action: Show

Dynamic Trunk List Total: 1

Trunk	Type	Name	Admin	Oper Status	Shutdown Reason	Autonegotiation	Oper Speed Duplex	Oper Flow Control	Link Up Down Trap
3	1000BASE SFP		Enabled	Up		Enabled	10G0/Full	None	Enabled

Displaying LACP Port Counters

Use the Interface > Trunk > Dynamic (Configure Aggregation Port - Show Information - Counters) page to display statistics for LACP protocol messages.

Parameters

These parameters are displayed:

Parameter	Description
LACPDUs Sent	Number of valid LACPDUs transmitted from this channel group.
LACPDUs Received	Number of valid LACPDUs received on this channel group.
Marker Sent	Number of valid Marker PDUs transmitted from this channel group.
Marker Received	Number of valid Marker PDUs received by this channel group.
Marker Unknown Pkts	Number of frames received that either (1) Carry the Slow Protocols Ethernet Type value, but contain an unknown PDU, or (2) are addressed to the Slow Protocols group MAC Address, but do not carry the Slow Protocols Ethernet Type.

Parameter	Description
Marker Illegal Pkts	Number of frames that carry the Slow Protocols Ethernet Type value, but contain a badly formed PDU or an illegal value of Protocol Subtype.

Web Interface

To display LACP port counters:

1. Click **Interface > Trunk > Dynamic**.
2. Select Configure Aggregation Port from the Step list.
3. Select Show Information from the Action list.
4. Click **Counters**.
5. Select a group member from the Port list.

The screenshot shows the web interface for configuring a dynamic trunk. The breadcrumb navigation is "Interface > Trunk > Dynamic". The "Step" dropdown is set to "2 Configure Aggregation Port" and the "Action" dropdown is set to "Show Information". There are three radio buttons: "Counters" (selected), "Internal", and "Neighbors". The "Port" dropdown is set to "1" and the "Trunk ID" is "2". Below this, there is a section titled "Port Counters Information" with a table of statistics:

Port Counters Information			
LACPDUs Sent	29	LACPDUs Received	25
Marker Sent	0	Marker Receive	0
Marker Unknown Pkts	0	Marker Illegal Pkts	0

A "Refresh" button is located at the bottom right of the statistics table.

Displaying LACP Settings and Status for the Local Side

Use the Interface > Trunk > Dynamic (Configure Aggregation Port - Show Information - Internal) page to display the configuration settings and operational state for the local side of a link aggregation.

Parameters

These parameters are displayed:

Parameter	Description
LACP System Priority	LACP system priority assigned to this port channel.
LACP Port Priority	LACP port priority assigned to this interface within the channel group.

Parameter	Description
Admin Key	Current administrative value of the key for the aggregation port.
Oper Key	Current operational value of the key for the aggregation port.
LACPDU's Interval	The number of seconds between periodic LACPDU transmissions.
Admin State, Oper State	Administrative or operational values of the actor's state parameters: <ul style="list-style-type: none"> ◆ Expired – The actor's receive machine is in the expired state; ◆ Defaulted – The actor's receive machine is using defaulted operational partner information, administratively configured for the partner. ◆ Distributing – If false, distribution of outgoing frames on this link is disabled; i.e., distribution is currently disabled and is not expected to be enabled in the absence of administrative changes or changes in received protocol information. ◆ Collecting – Collection of incoming frames on this link is enabled; i.e., collection is currently enabled and is not expected to be disabled in the absence of administrative changes or changes in received protocol information. ◆ Synchronization – The System considers this link to be IN_SYNC; i.e., it has been allocated to the correct Link Aggregation Group, the group has been associated with a compatible Aggregator, and the identity of the Link Aggregation Group is consistent with the System ID and operational Key information transmitted. ◆ Aggregation – The system considers this link to be aggregatable; i.e., a potential candidate for aggregation. ◆ Long timeout – Periodic transmission of LACPDU's uses a slow transmission rate. ◆ LACP-Activity – Activity control value with regard to this link. (0: Passive; 1: Active)

Web Interface

To display LACP settings and status for the local side:

1. Click **Interface** > **Trunk** > **Dynamic**.
2. Select Configure Aggregation Port from the Step list.
3. Select Show Information from the Action list.
4. Click **Internal**.
5. Select a group member from the Port list.

Interface > Trunk > Dynamic

Step: 2. Configure Aggregation Port Action: Show Information

Counters Internal Neighbors

Port 1

Trunk ID 2

Port Internal Information

LACP System Priority	32768
LACP Port Priority	32768
Admin Key	3
Oper Key	3
LACPDUs Interval	30 sec
Admin State	Defaulted, Aggregation, Long timeout, LACP-activity
Oper State	Distributing, Collecting, Synchronization, Aggregation, Long timeout, LACP-activity

Displaying LACP Settings and Status for the Remote Side

Use the Interface > Trunk > Dynamic (Configure Aggregation Port - Show Information - Neighbors) page to display the configuration settings and operational state for the remote side of a link aggregation.

Parameters

These parameters are displayed:

Parameter	Description
Partner Admin System ID	LAG partner's system ID assigned by the user.
Partner Oper System ID	LAG partner's system ID assigned by the LACP protocol.
Partner Admin Port Number	Current administrative value of the port number for the protocol Partner.
Partner Oper Port Number	Operational port number assigned to this aggregation port by the port's protocol partner.
Port Admin Priority	Current administrative value of the port priority for the protocol partner.
Port Oper Priority	Priority value assigned to this aggregation port by the partner.
Admin Key	Current administrative value of the Key for the protocol partner.
Oper Key	Current operational value of the Key for the protocol partner.
Admin State	Administrative values of the partner's state parameters. (See preceding table.)

Parameter	Description
Oper State	Operational values of the partner's state parameters. (See preceding table.)

Web Interface

To display LACP settings and status for the remote side:

1. Click **Interface > Trunk > Dynamic**.
2. Select Configure Aggregation Port from the Step list.
3. Select Show Information from the Action list.
4. Click **Neighbors**.
5. Select a group member from the Port list.

Interface > Trunk > Dynamic

Step: 2. Configure Aggregation Port Action: Show Information

Counters Internal Neighbors

Port 3

Trunk ID 2

Port Neighbors Information

Partner Admin System ID	32768, 00-00-00-00-00-00
Partner Oper System ID	32768, 00-12-CF-61-24-2F
Partner Admin Port Number	3
Partner Oper Port Number	3
Port Admin Priority	32768
Port Oper Priority	32768
Admin Key	0
Oper Key	3
Admin State	Defaulted, Distributing, Collecting, Synchronization, Long timeout
Oper State	Distributing, Collecting, Synchronization, Aggregation, Long timeout, LACP-activity

Configuring Load Balancing

Use the Interface > Trunk > Load Balance page to set the load-distribution method used among ports in aggregated links.

Command Usage

- ◆ This command applies to all static and dynamic trunks on the switch.
- ◆ To ensure that the switch traffic load is distributed evenly across all links in a trunk, select the source and destination addresses used in the load-balance calculation to provide the best result for trunk connections:

- ◆ **Destination IP Address:** All traffic with the same destination IP address is output on the same link in a trunk. This mode works best for switch-to-router trunk links where traffic through the switch is destined for many different hosts. Do not use this mode for switch-to-server trunk links where the destination IP address is the same for all traffic.
- ◆ **Destination MAC Address:** All traffic with the same destination MAC address is output on the same link in a trunk. This mode works best for switch-to-switch trunk links where traffic through the switch is destined for many different hosts. Do not use this mode for switch-to-router trunk links where the destination MAC address is the same for all traffic.
- ◆ **Source and Destination IP Address:** All traffic with the same source and destination IP address is output on the same link in a trunk. This mode works best for switch-to-router trunk links where traffic through the switch is received from and destined for many different hosts.
- ◆ **Source and Destination MAC Address:** All traffic with the same source and destination MAC address is output on the same link in a trunk. This mode works best for switch-to-switch trunk links where traffic through the switch is received from and destined for many different hosts.
- ◆ **Source IP Address:** All traffic with the same source IP address is output on the same link in a trunk. This mode works best for switch-to-router or switch-to-server trunk links where traffic through the switch is received from many different hosts.
- ◆ **Source MAC Address:** All traffic with the same source MAC address is output on the same link in a trunk. This mode works best for switch-to-switch trunk links where traffic through the switch is received from many different hosts.

Parameters

These parameters are displayed for the load balance mode:

- ◆ **Destination IP Address** - Load balancing based on destination IP address.
- ◆ **Destination MAC Address** - Load balancing based on destination MAC address.
- ◆ **Source and Destination IP Address** - Load balancing based on source and destination IP address.
- ◆ **Source and Destination MAC Address** - Load balancing based on source and destination MAC address.
- ◆ **Source IP Address** - Load balancing based on source IP address.

- ◆ **Source MAC Address** - Load balancing based on source MAC address.

Web Interface

To display the load-distribution method used by ports in aggregated links:

1. Click **Interface > Trunk > Load Balance**.
2. Select the required method from the Load Balance Mode list.
3. Click **Apply**.

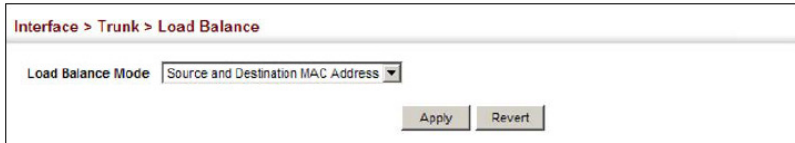

The screenshot shows a web interface for configuring load balancing. At the top, the breadcrumb navigation is "Interface > Trunk > Load Balance". Below this, there is a label "Load Balance Mode" followed by a dropdown menu. The dropdown menu is currently set to "Source and Destination MAC Address". At the bottom right of the configuration area, there are two buttons: "Apply" and "Revert".

Saving Power

Use the Interface > Green Ethernet page to enable power savings mode on the selected port.

Command Usage

- ◆ The power-saving methods provided by this switch include:
 - ◆ Power saving when there is no link partner:

Under normal operation, the switch continuously auto-negotiates to find a link partner, keeping the MAC interface powered up even if no link connection exists. When using power-savings mode, the switch checks for energy on the circuit to determine if there is a link partner. If none is detected, the switch automatically turns off the transmitter, and most of the receive circuitry (entering Sleep Mode). In this mode, the low-power energy-detection circuit continuously checks for energy on the cable. If none is detected, the MAC interface is also powered down to save additional energy. If energy is detected, the switch immediately turns on both the transmitter and receiver functions, and powers up the MAC interface.
 - ◆ Power saving when there is a link partner:

Traditional Ethernet connections typically operate with enough power to support at least 100 meters of cable even though average network cable length is shorter. When cable length is shorter, power consumption can be reduced since signal attenuation is proportional to cable length. When power-savings mode is enabled, the switch analyzes cable length to determine whether or not it can reduce the signal amplitude used on a particular link.

Note: Power savings can only be implemented on Gigabit Ethernet ports when using twisted-pair cabling. Power-savings mode on a active link only works when connection speed is 1 Gbps, and line length is less than 60 meters.

Parameters

These parameters are displayed:

- ◆ **Port** – Power saving mode only applies to the Gigabit Ethernet ports using copper media.
- ◆ **Power Saving Status** – Adjusts the power provided to ports based on the length of the cable used to connect to other devices. Only sufficient power

is used to maintain connection requirements. (Default: Enabled on Gigabit Ethernet RJ-45 ports)

Web Interface

To enable power saving:

1. Click **Interface** > **Green Ethernet**.
2. Mark the Enabled check box for a port.
3. Click **Apply**.

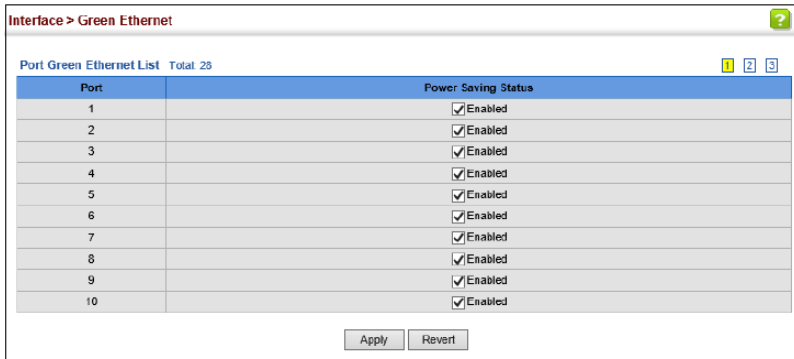

Interface > Green Ethernet

Port Green Ethernet List Total: 25

Port	Power Saving Status
1	<input checked="" type="checkbox"/> Enabled
2	<input checked="" type="checkbox"/> Enabled
3	<input checked="" type="checkbox"/> Enabled
4	<input checked="" type="checkbox"/> Enabled
5	<input checked="" type="checkbox"/> Enabled
6	<input checked="" type="checkbox"/> Enabled
7	<input checked="" type="checkbox"/> Enabled
8	<input checked="" type="checkbox"/> Enabled
9	<input checked="" type="checkbox"/> Enabled
10	<input checked="" type="checkbox"/> Enabled

Apply Revert

Local Port Mirroring

Use the Interface > Mirror page to mirror traffic from any source port to a target port for real-time analysis. You can then attach a logic analyzer or RMON probe to the target port and study the traffic crossing the source port in a completely unobtrusive manner.

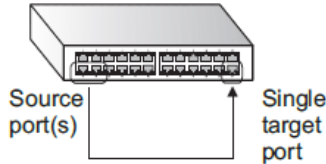

Command Usage

- ◆ The switch supports up to 6 port mirror sessions.
- ◆ Traffic can be mirrored from one or more source ports to a destination port on the same switch (local port mirroring as described in this section), or from one or more source ports on remote switches to a destination port on this switch (remote port mirroring as described in Configuring Remote Port Mirroring).
- ◆ Monitor port speed should match or exceed source port speed, otherwise traffic may be dropped from the monitor port.
- ◆ When traffic matches the rules for both port mirroring, and for mirroring of VLAN traffic or packets based on a MAC address, the matching packets will not be sent to target port specified for port mirroring.
- ◆ The destination port cannot be a trunk or trunk member port.
- ◆ Note that Spanning Tree BPDU packets are not mirrored to the target port.

Parameters

These parameters are displayed:

- ◆ **Source Port** – The port whose traffic will be monitored.
- ◆ **Target Port** – The port that will mirror the traffic on the source port.
- ◆ **Type** – Allows you to select which traffic to mirror to the target port, Rx (receive), Tx (transmit), or Both. (Default: Both)

Web Interface

To configure a local mirror session:

1. Click **Interface > Mirror**.
2. Select Add from the Action List.
3. Specify the source port.
4. Specify the monitor port.
5. Specify the traffic type to be mirrored.
6. Click **Apply**.

Interface > Mirror

Action: Add ▼

Source Port Unit 1 ▼ Port 1 ▼

Target Port Unit 1 ▼ Port 1 ▼

Type Both ▼

Apply Revert

To display the configured mirror sessions:

1. Click **Interface > Mirror**.
2. Select Show from the Action List.

Interface > Mirror

Action: Show ▼

Mirror Session List Total: 2

	Source (Unit/Port)	Target (Unit/Port)	Type
<input type="checkbox"/>	1 / 7	1 / 8	Both
<input type="checkbox"/>	1 / 9	1 / 10	Rx

Delete Revert

Remote Port Mirroring

Use the Interface > RSPAN page to mirror traffic from remote switches for analysis at a destination port on the local switch. This feature, also called Remote Switched Port Analyzer (RSPAN), carries traffic generated on the specified source ports for each session over a user-specified VLAN dedicated to that RSPAN session in all participating switches. Monitored traffic from one or more sources is copied onto the RSPAN VLAN through IEEE 802.1Q trunk or hybrid ports that carry it to any RSPAN destination port monitoring the RSPAN VLAN as shown in the figure below.

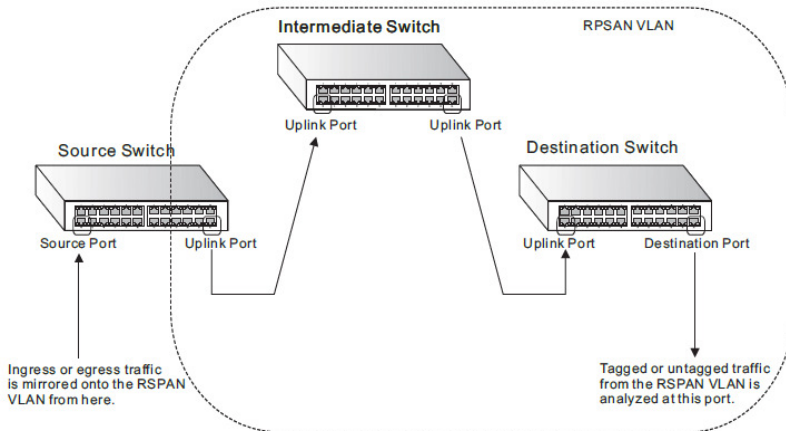

Command Usage

- ◆ Traffic can be mirrored from one or more source ports to a destination port on the same switch (local port mirroring as described in Configuring Local Port Mirroring), or from one or more source ports on remote switches to a destination port on this switch (remote port mirroring as described in this section).

- ◆ **Configuration Guidelines**

Take the following step to configure an RSPAN session:

1. Use the VLAN Static List (see Configuring VLAN Groups) to reserve a VLAN for use by RSPAN (marking the “Remote VLAN” field on this page. (Default VLAN 1 is prohibited.)
2. Set up the source switch on the RSPAN configuration page by specifying the mirror session, the switch’s role (Source), the RSPAN VLAN, and the uplink port¹. Then specify the source port(s), and the traffic type to monitor (Rx, Tx or Both).

3. Set up all intermediate switches on the RSPAN configuration page, entering the mirror session, the switch's role (Intermediate), the RSPAN VLAN, and the uplink port(s).
4. Set up the destination switch on the RSPAN configuration page by specifying the mirror session, the switch's role (Destination), the destination port¹, whether or not the traffic exiting this port will be tagged or untagged, and the RSPAN VLAN. Then specify each uplink port where the mirrored traffic is being received.

◆ **RSPAN Limitations**

The following limitations apply to the use of RSPAN on this switch:

- ◆ *RSPAN Ports* – Only ports can be configured as an RSPAN source, destination, or uplink; static and dynamic trunks are not allowed. A port can only be configured as one type of RSPAN interface – source, destination, or uplink. Also, note that the source port and destination port cannot be configured on the same switch.
- ◆ *Local/Remote Mirror* – The destination of a local mirror session (created on the Interface > Port > Mirror page) cannot be used as the destination for RSPAN traffic.
- ◆ *Spanning Tree* – If the spanning tree is disabled, BPDUs will not be flooded onto the RSPAN VLAN.

Note: 1. Only 802.1Q trunk or hybrid (i.e., general use) ports can be configured as an RSPAN uplink or destination ports – access ports are not allowed (see Adding Static Members to VLANs).

- ◆ *MAC address learning* is not supported on RSPAN uplink ports when RSPAN is enabled on the switch. Therefore, even if spanning tree is enabled after RSPAN has been configured, MAC address learning will still not be re-started on the RSPAN uplink ports.
- ◆ *IEEE 802.1X* – RSPAN and 802.1X are mutually exclusive functions. When 802.1X is enabled globally, RSPAN uplink ports cannot be configured, even though RSPAN source and destination ports can still be configured. When RSPAN uplink ports are enabled on the switch, 802.1X cannot be enabled globally.
- ◆ *Port Security* – If port security is enabled on any port, that port cannot be set as an RSPAN uplink port, even though it can still be configured as an RSPAN source or destination port. Also, when a port is configured as an RSPAN uplink port, port security cannot be enabled on that port.

Parameters

These parameters are displayed:

- ◆ **Session** – A number identifying this RSPAN session. (Range: 1) Only one active session is allowed.
- ◆ **Operation Status** – Indicates whether or not RSPAN is currently functioning.
- ◆ **Switch Role** – Specifies the role this switch performs in mirroring traffic.
 - ◆ **None** – This switch will not participate in RSPAN.
 - ◆ **Source** - Specifies this device as the source of remotely mirrored traffic.
 - ◆ **Intermediate** - Specifies this device as an intermediate switch, transparently passing mirrored traffic from one or more sources to one or more destinations.
 - ◆ **Destination** - Specifies this device as a switch configured with a destination port which is to receive mirrored traffic for this session.
- ◆ **Remote VLAN** – The VLAN to which traffic mirrored from the source port will be flooded. The VLAN specified in this field must first be reserved for the RSPAN application using the VLAN > Static page.
- ◆ **Uplink Port** – A port on any switch participating in RSPAN through which mirrored traffic is passed on to or received from the RSPAN VLAN. Only one uplink port can be configured on a source switch, but there is no limitation on the number of uplink ports configured on an intermediate or destination switch.

Only destination and uplink ports will be assigned by the switch as members of the RSPAN VLAN. Ports cannot be manually assigned to an RSPAN VLAN through the VLAN > Static page. Nor can GVRP dynamically add port members to an RSPAN VLAN. Also, note that the VLAN > Static (Show) page will not display any members for an RSPAN VLAN, but will only show configured RSPAN VLAN identifiers.

- ◆ **Type** – Specifies the traffic type to be mirrored remotely. (Options: Rx, Tx, Both)
- ◆ **Destination Port** – Specifies the destination port1 to monitor the traffic mirrored from the source ports. Only one destination port can be configured on the same switch per session, but a destination port can be configured on more than one switch for the same session. Also note that a destination port can still send and receive switched traffic, and participate in any Layer 2 protocols to which it has been assigned.

- ♦ **Tag** – Specifies whether or not the traffic exiting the destination port to the monitoring device carries the RSPAN VLAN tag.

Web Interface

To configure a remote mirror session:

1. Click **Interface** > **RSPAN**.
2. Set the Switch Role to None, Source, Intermediate, or Destination.
3. Configure the required settings for each switch participating in the RSPAN VLAN.
4. Click **Apply**.

Configuring Remote Port Mirroring (Source)

Interface > RSPAN

Session: 1

Operation Status: Down

Switch Role: Source

Remote VLAN: 9

Uplink Port: 1

Source Port Configuration List Total: 26

Source Port	Type
1	None
2	None
3	None
6	None

Configuring Remote Port Mirroring (Intermediate)

Interface > RSPAN

Session: 1

Operation Status: Down

Switch Role: Intermediate

Remote VLAN: 9

Uplink Port List Total: 26

Port	Uplink
1	<input type="checkbox"/>
2	<input type="checkbox"/>
3	<input type="checkbox"/>
6	<input type="checkbox"/>

Configuring Remote Port Mirroring (Destination)

Interface > RSPAN 

Session:



Operation Status: Down

Switch Role:

Destination Port:

Tag:

Remote VLAN:

Uplink Port List Total: 25   

Port	Uplink
1	<input type="checkbox"/>
2	<input type="checkbox"/>
3	<input type="checkbox"/>
6	<input type="checkbox"/>

Flow Sampling

The flow sampling (sFlow) feature embedded on this switch, together with a remote sFlow Collector, can provide network administrators with an accurate, detailed and real-time overview of the types and levels of traffic present on their network. The sFlow Agent samples 1 out of n packets from all data traversing the switch, re-encapsulates the samples as sFlow datagrams and transmits them to the sFlow Collector. This sampling occurs at the internal hardware level where all traffic is seen, whereas traditional probes will only have a partial view of traffic as it is sampled at the monitored interface. Moreover, the processor and memory load imposed by the sFlow agent is minimal since local analysis does not take place. The wire-speed transmission characteristic of the switch is thus preserved even at high traffic levels.

Note: The terms “collector”, “receiver” and “owner”, in the context of this chapter, all refer to a remote server capable of receiving the sFlow datagrams generated by the sFlow agent of the switch.

As the Collector receives streams from the various sFlow agents (other switches or routers) throughout the network, a timely, network-wide picture of utilization and traffic flows is created. Analysis of the sFlow stream(s) can reveal trends and information that can be leveraged in the following ways:

- ◆ Detecting, diagnosing, and fixing network problems
- ◆ Real-time congestion management
- ◆ Understanding application mix (P2P, Web, DNS, etc.) and changes
- ◆ Identification and tracing of unauthorized network activity
- ◆ Usage accounting
- ◆ Trending and capacity planning

Configuring sFlow Receiver Settings

Use the Interface > sFlow (Configure Receiver – Add) page to create an sFlow receiver on the switch.

Parameters

These parameters are displayed:

- ◆ **Receiver Owner Name²** – The name of the receiver. (Range: 1-256 characters; Default: None)

- ◆ **Receiver Timeout** – The time that the sFlow process will continuously send samples to the Collector before resetting all sFlow port parameters. (Range: 30-10000000 seconds, where 0 indicates no time out)
The sFlow parameters affected by this command include the sampling interval, the receiver's name, address and UDP port, the time out, maximum header size, and maximum datagram size.
- ◆ **Receiver Destination²** – IP address of the sFlow Collector.
 - ◆ *ipv4-address* - IPv4 address of the sFlow collector. Valid IPv4 addresses consist of four decimal numbers, 0 to 255, separated by periods.
 - ◆ *ipv6-address* - IPv6 address of the sFlow collector. A full IPv6 address including the network prefix and host address bits. An IPv6 address consists of 8 colon-separated 16-bit hexadecimal values. One double colon may be used to indicate the appropriate number of zeros required to fill the undefined fields.
- ◆ **Receiver Socket Port²** – The UDP port on which the sFlow Collector is listening for sFlow streams. (Range: 1-65535)
- ◆ **Maximum Datagram Size** – Maximum size of the sFlow datagram payload. (Range: 200-1500 bytes)

Note: 2. Sampling must be disabled by setting the time out to 0 before these fields can be configured.

- ◆ **Datagram Version** – Sends either v4 or v5 sFlow datagrams to the receiver.

Web Interface

To configure an sFlow receiver:

1. Click **Interface > sFLOW**.
2. Select Configure Receiver from the Step list.
3. Select Add from the Action list.
4. Fill in the parameters for the sFlow receiver and monitored traffic.
5. Click **Apply**.

Interface > sFlow

Step: 1. Configure Receiver Action: Add

Receiver Owner Name: stat_server1

Receiver Timeout (30 - 10000000): 100 sec

Receiver Destination: 192.168.220.225

Receiver Socket Port (1 - 65535): 22500

Maximum Datagram Size (200 - 1500): 512 bytes

Datagram Version: v5

Apply Revert

Web Interface

To show configured receivers:

1. Click **Interface > sFLOW**.
2. Select Configure Receiver from the Step list.
3. Select Show from the Action list.

Interface > sFlow

Step: 1. Configure Receiver Action: Show

Receiver List Total: 1

	Owner Name	Timeout	Destination	Socket Port	Maximum Datagram Size	Datagram Version
<input type="checkbox"/>	stat_server1	97	192.168.220.225	22500	512	5

Delete Revert

Configuring an sFlow Polling Instance

Use the Interface > sFlow (Configure Details – Add) page to enable an sFlow polling data source that polls periodically based on a specified time interval, or an sFlow data source instance that takes samples periodically based on the number of packets processed.

Parameters

These parameters are displayed in the web interface:

- ◆ **Receiver Owner Name** – The name of the receiver. (Range: 1-256 characters; Default: None)
- ◆ **Type** – Specifies the polling type as an sFlow polling data source for a specified interface that polls periodically based on a specified time

interval, or an sFlow data source instance for a specific interface that takes samples periodically based on the number of packets processed.

- ◆ **Data Source** – The source from which the samples will be taken and sent to a collector.
- ◆ **Instance ID** – An instance ID used to identify the sampling source. (Range: 1)
- ◆ **Sampling Rate** – The number of packets out of which one sample will be taken. (Range: 256-16777215 packets; Default: Disabled)
- ◆ **Maximum Header Size** – Maximum size of the sFlow datagram header. (Range: 64-256 bytes)

Web Interface

To configure an sFlow sampling or polling instance:

1. Click **Interface > sFLOW**.
2. Select Configure Details from the Step list.
3. Select Add from the Action list.
4. Fill in the parameters for the sFlow instance, including sampling rate and maximum header size.
5. Click **Apply**.

Interface > sFlow

Step: 2. Configure Details Action: Add

Receiver Owner Name: tpa

Type: Sampling Polling

Data Source: Unit 1 Port 1

Instance ID (1-1): 1

Sampling Rate (256-16777215): 256

Maximum Header Size (64-256): 256 bytes

Apply Revert

Web Interface

To show configured instance:

1. Click **Interface > sFLOW**.
2. Select Configure Details from the Step list.
3. Select Show from the Action list.

4. Select the owner name from the scroll-down list.
5. Select sFlow type as Sampling or Polling.

Interface > sFlow

Step: 2. Configure Details Action: Show

Receiver Owner Name: stat_server1

Type: Sampling Polling

Sampling List Total: 1

	Data Source (Unit/Port)	Instance ID	Rate	Maximum Header Size (bytes)
<input type="checkbox"/>	1/3	1	256	200

Delete Revert

Traffic Segmentation

If tighter security is required for passing traffic from different clients through downlink ports on the local network and over uplink ports to the service provider, port-based traffic segmentation can be used to isolate traffic for individual clients. Data traffic on downlink ports is only forwarded to, and from, uplink ports.

Traffic belonging to each client is isolated to the allocated downlink ports. But the switch can be configured to either isolate traffic passing across a client's allocated uplink ports from the uplink ports assigned to other clients, or to forward traffic through the uplink ports used by other clients, allowing different clients to share access to their uplink ports where security is less likely to be compromised.

Enabling Traffic Segmentation

Use the **Interface > Traffic Segmentation (Configure Global)** page to enable traffic segmentation.

Parameters

These parameters are displayed:

- ◆ **Status** – Enables port-based traffic segmentation. (Default: Disabled)
- ◆ **Uplink-to-Uplink Mode** – Specifies whether or not traffic can be forwarded between uplink ports assigned to different client sessions.
 - ◆ **Blocking** – Blocks traffic between uplink ports assigned to different sessions.
 - ◆ **Forwarding** – Forwards traffic between uplink ports assigned to different sessions.

Web Interface

To enable traffic segmentation:

1. Click **Interface > Traffic Segmentation**.
2. Select **Configure Global** from the Step list.
3. Mark the **Status** check box, and set the required uplink-to-uplink mode.
4. Click **Apply**.

Configuring Uplink and Downlink Ports

Use the Interface > Traffic Segmentation (Configure Session) page to assign the downlink and uplink ports to use in the segmented group. Ports designated as downlink ports can not communicate with any other ports on the switch except for the uplink ports. Uplink ports can communicate with any other ports on the switch and with any designated downlink ports.

Command Usage

- ◆ When traffic segmentation is enabled, the forwarding state for the uplink and downlink ports assigned to different client sessions is shown below.

Destination Source	Session #1 Downlinks	Session #1 Uplinks	Session #2 Downlinks	Session #2 Uplinks	Normal Ports
Session #1 Downlink Ports	Blocking	Forwarding	Blocking	Blocking	Blocking
Session #1 Uplink Ports	Forwarding	Forwarding	Blocking	Block/Forwarding*	Forwarding
Session #2 Downlink Ports	Blocking	Blocking	Blocking	Forwarding	Blocking
Session #2 Uplink Ports	Blocking	Block/Forwarding*	Forwarding	Forwarding	Forwarding
Normal Ports	Forwarding	Forwarding	Forwarding	Forwarding	Forwarding

Note: * The forwarding state for uplink-to-uplink ports is configured on the Configure Global page.

- ◆ When traffic segmentation is disabled, all ports operate in normal forwarding mode based on the settings specified by other functions such as VLANs and spanning tree protocol.
- ◆ A port cannot be configured in both an uplink and downlink list.
- ◆ A port can only be assigned to one traffic-segmentation session.

- ◆ A downlink port can only communicate with an uplink port in the same session. Therefore, if an uplink port is not configured for a session, the assigned downlink ports will not be able to communicate with any other ports.
- ◆ If a downlink port is not configured for the session, the assigned uplink ports will operate as normal ports.

Parameters

These parameters are displayed:

- ◆ **Session ID** – Traffic segmentation session. (Range: 1-4)
- ◆ **Direction** – Adds an interface to the segmented group by setting the direction to uplink or downlink. (Default: Uplink)
- ◆ **Interface** – Displays a list of ports or trunks.
- ◆ **Port** – Port Identifier. (Range: 1-28/54)
- ◆ **Trunk** – Trunk Identifier. (Range: 1-28)

Web Interface

To configure the members of the traffic segmentation group:

1. Click **Interface > Traffic Segmentation**.
2. Select Configure Session from the Step list.
3. Select Add from the Action list.
4. Enter the session ID, set the direction to uplink or downlink, and select the interface to add.
5. Click **Apply**.

The screenshot shows a web interface titled "Interface > Traffic Segmentation". At the top, there are two dropdown menus: "Step: 2. Configure Session" and "Action: Add". Below this, there are three main configuration sections: "Session ID (1-4)" with a text input field; "Direction" with a dropdown menu set to "Uplink"; and "Interface" with two radio button options. The "Port (1-28)" option is selected, and it includes two adjacent text input fields for port numbers. The "Trunk (1-28)" option also includes two adjacent text input fields. At the bottom right of the form, there are two buttons: "Apply" and "Revert".

To show the members of the traffic segmentation group:

1. Click **Interface > Traffic Segmentation**.
2. Select Configure Session from the Step list.
3. Select Show from the Action list.

Interface > Traffic Segmentation

Step: 2. Configure Session Action: Show

Session List Total 2

<input type="checkbox"/>	Session ID	Direction	Interface
<input type="checkbox"/>	1	Uplink	Unit 1 / Part 1
<input type="checkbox"/>	1	Downlink	Unit 1 / Part 2

Delete Revert

VLAN Trunking

Use the Interface > VLAN Trunking page to allow unknown VLAN groups to pass through the specified interface.

Command Usage

- Use this feature to configure a tunnel across one or more intermediate switches which pass traffic for VLAN groups to which they do not belong. The following figure shows VLANs 1 and 2 configured on switches A and B, with VLAN trunking being used to pass traffic for these VLAN groups across switches C, D and E.

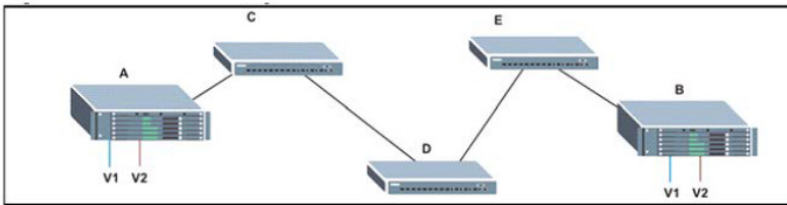

Without VLAN trunking, you would have to configure VLANs 1 and 2 on all intermediate switches – C, D and E; otherwise these switches would drop any frames with unknown VLAN group tags. However, by enabling VLAN trunking on the intermediate switch ports along the path connecting VLANs 1 and 2, you only need to create these VLAN groups in switches A and B. Switches C, D and E automatically allow frames with VLAN group tags 1 and 2 (groups that are unknown to those switches) to pass through their VLAN trunking ports.

- VLAN trunking is mutually exclusive with the “access” switchport mode (see Adding Static Members to VLANs). If VLAN trunking is enabled on an interface, then that interface cannot be set to access mode, and vice versa.
- To prevent loops from forming in the spanning tree, all unknown VLANs will be bound to a single instance (either STP/RSTP or an MSTP instance, depending on the selected STA mode).
- If both VLAN trunking and ingress filtering are disabled on an interface, packets with unknown VLAN tags will still be allowed to enter this interface and will be flooded to all other ports where VLAN trunking is enabled. (In other words, VLAN trunking will still be effectively enabled for the unknown VLAN).

Parameters

These parameters are displayed:

- ◆ **Interface** – Displays a list of ports or trunks.
- ◆ **Port** – Port Identifier. (Range: 1-28/54)
- ◆ **Trunk** – Trunk Identifier. (Range: 1-28)
- ◆ **VLAN Trunking Status** – Enables VLAN trunking on the selected interface.

Web Interface

To enable VLAN trunking on a port or trunk:

1. Click **Interface > VLAN Trunking**.
2. Click Port or Trunk to specify the interface type.
3. Enable VLAN trunking on any of the ports or on a trunk.
4. Click **Apply**.

Interface > VLAN Trunking

Interface Port Trunk

Port VLAN Trunking List Total: 26

Port	VLAN Trunking Status
1	<input type="checkbox"/> Enabled
2	<input type="checkbox"/> Enabled
3	<input type="checkbox"/> Enabled
6	<input type="checkbox"/> Enabled
7	<input type="checkbox"/> Enabled
8	<input type="checkbox"/> Enabled
9	<input type="checkbox"/> Enabled
10	<input type="checkbox"/> Enabled
11	<input type="checkbox"/> Enabled
12	<input type="checkbox"/> Enabled

Apply Revert

This Page Intentionally Left Blank

Chapter 7

VLAN Configuration

Overview

This chapter describes the following topics:

- ◆ *IEEE 802.1Q VLANs* – Configures static and dynamic VLANs.
- ◆ *IEEE 802.1Q Tunneling* – Configures QinQ tunneling to maintain customer-specific VLAN and Layer 2 protocol configurations across a service provider network, even when different customers use the same internal VLAN IDs.
- ◆ *L2PT Tunneling* – Configures Layer 2 Protocol Tunneling for the specified protocol.
- ◆ *Protocol VLANs³* – Configures VLAN groups based on specified protocols.
- ◆ *IP Subnet VLANs³* – Maps untagged ingress frames to a specified VLAN if the source address is found in the IP subnet-to-VLAN mapping table.
- ◆ *MAC-based VLANs³* – Maps untagged ingress frames to a specified VLAN if the source MAC address is found in the IP MAC address-to-VLAN mapping table.
- ◆ *VLAN Mirroring* – Mirrors traffic from one or more source VLANs to a target port.
- ◆ *VLAN Translation* – Maps VLAN IDs between the customer and the service provider.

Note: If a packet matches the rules defined by more than one of these functions, only one of them is applied, with the precedence being MAC-based, IP subnet-based, protocol-based, and then native port-based.

IEEE 802.1Q VLANs

In large networks, routers are used to isolate broadcast traffic for each subnet into separate domains. This switch provides a similar service at Layer 2 by using VLANs to organize any group of network nodes into separate broadcast domains. VLANs confine broadcast traffic to the originating group, and can eliminate broadcast storms in large networks. This also provides a more secure and cleaner network environment.

An IEEE 802.1Q VLAN is a group of ports that can be located anywhere in the network, but communicate as though they belong to the same physical segment.

VLANs help to simplify network management by allowing you to move devices to a new VLAN without having to change any physical connections. VLANs can be easily organized to reflect departmental groups (such as Marketing or R&D), usage groups (such as e-mail), or multicast groups (used for multimedia applications such as video conferencing).

VLANs provide greater network efficiency by reducing broadcast traffic, and allow you to make network changes without having to update IP addresses or IP subnets. VLANs inherently provide a high level of network security since traffic must pass through a configured Layer 3 link to reach a different VLAN.

This switch supports the following VLAN features:

- ◆ Up to 4094 VLANs based on the IEEE 802.1Q standard
- ◆ Distributed VLAN learning across multiple switches using explicit or implicit tagging and GVRP protocol
- ◆ Port overlapping, allowing a port to participate in multiple VLANs
- ◆ End stations can belong to multiple VLANs
- ◆ Passing traffic between VLAN-aware and VLAN-unaware devices
- ◆ Priority tagging

Assigning Ports to VLANs

Before enabling VLANs for the switch, you must first assign each port to the VLAN group(s) in which it will participate. By default all ports are assigned to VLAN 1 as untagged ports. Add a port as a tagged port if you want it to carry traffic for one or more VLANs, and any intermediate network devices or the host at the other end of the connection supports VLANs. Then assign ports on the other VLAN-aware network devices along the path that will carry this traffic to the same VLAN(s), either manually or dynamically using GVRP. However, if you want a port on this switch to participate in one or more

VLANs, but none of the intermediate network devices nor the host at the other end of the connection supports VLANs, then you should add this port to the VLAN as an untagged port.

Note: VLAN-tagged frames can pass through VLAN-aware or VLAN-unaware network interconnection devices, but the VLAN tags should be stripped off before passing it on to any end-node host that does not support VLAN tagging.

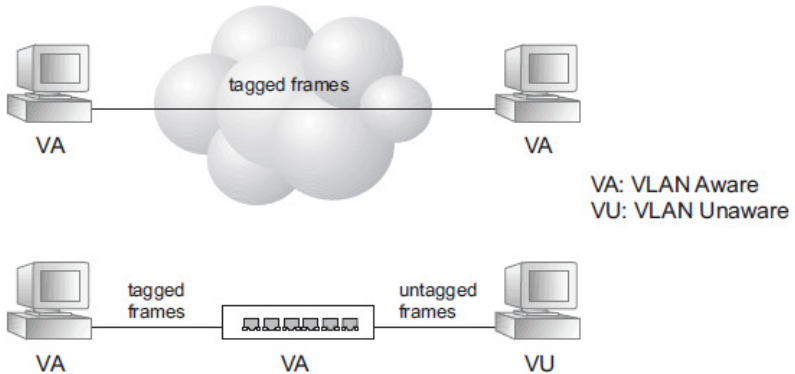

VLAN Classification – When the switch receives a frame, it classifies the frame in one of two ways. If the frame is untagged, the switch assigns the frame to an associated VLAN (based on the default VLAN ID of the receiving port). But if the frame is tagged, the switch uses the tagged VLAN ID to identify the port broadcast domain of the frame.

Port Overlapping – Port overlapping can be used to allow access to commonly shared network resources among different VLAN groups, such as file servers or printers. Note that if you implement VLANs which do not overlap, but still need to communicate, you can connect them by enabled routing on this switch.

Untagged VLANs – Untagged VLANs are typically used to reduce broadcast traffic and to increase security. A group of network users assigned to a VLAN form a broadcast domain that is separate from other VLANs configured on the switch. Packets are forwarded only between ports that are designated for the same VLAN. Untagged VLANs can be used to manually isolate user groups or subnets. However, you should use IEEE 802.3 tagged VLANs with GVRP whenever possible to fully automate VLAN registration.

Automatic VLAN Registration – GVRP (GARP VLAN Registration Protocol) defines a system whereby the switch can automatically learn the

VLANs to which each end station should be assigned. If an end station (or its network adapter) supports the IEEE 802.1Q VLAN protocol, it can be configured to broadcast a message to your network indicating the VLAN groups it wants to join. When this switch receives these messages, it will automatically place the receiving port in the specified VLANs, and then forward the message to all other ports. When the message arrives at another switch that supports GVRP, it will also place the receiving port in the specified VLANs, and pass the message on to all other ports. VLAN requirements are propagated in this way throughout the network. This allows GVRP-compliant devices to be automatically configured for VLAN groups based solely on end station requests.

To implement GVRP in a network, first add the host devices to the required VLANs (using the operating system or other application software), so that these VLANs can be propagated onto the network. For both the edge switches attached directly to these hosts, and core switches in the network, enable GVRP on the links between these devices. You should also determine security boundaries in the network and disable GVRP on the boundary ports to prevent advertisements from being propagated, or forbid those ports from joining restricted VLANs.

Note: If you have host devices that do not support GVRP, you should configure static or untagged VLANs for the switch ports connected to these devices (as described in Adding Static Members to VLANs). But you can still enable GVRP on these edge switches, as well as on the core switches in the network.

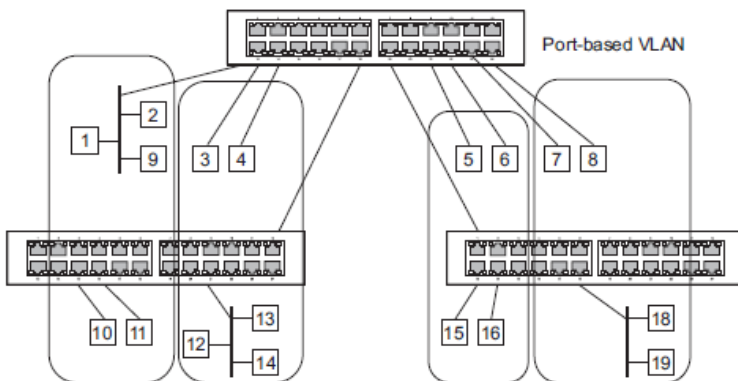

Forwarding Tagged/Untagged Frames

If you want to create a small port-based VLAN for devices attached directly to a single switch, you can assign ports to the same untagged VLAN. However, to participate in a VLAN group that crosses several switches, you should create a VLAN for that group and enable tagging on all ports.

Ports can be assigned to multiple tagged or untagged VLANs. Each port on the switch is therefore capable of passing tagged or untagged frames. When forwarding a frame from this switch along a path that contains any VLAN-aware devices, the switch should include VLAN tags. When forwarding a frame from this switch along a path that does not contain any VLAN-aware devices (including the destination host), the switch must first strip off the VLAN tag before forwarding the frame. When the switch receives a tagged frame, it will pass this frame onto the VLAN(s) indicated by the frame tag. However, when this switch receives an untagged frame from a VLAN-unaware device, it first decides where to forward the frame, and then inserts a VLAN tag reflecting the ingress port's default VID.

Configuring VLAN Groups

Use the `VLAN > Static (Add)` page to create or remove VLAN groups, set administrative status, or specify Remote VLAN type (see `Configuring Remote Port Mirroring`). To propagate information about VLAN groups used on this switch to external network devices, you must specify a VLAN ID for each of these groups.

Parameters

These parameters are displayed:

Add

- ◆ **VLAN ID** – ID of VLAN or range of VLANs (1-4094). VLAN 1 is the default untagged VLAN.
- ◆ **Status** – Enables or disables the specified VLAN.
- ◆ **Remote VLAN** – Reserves this VLAN for RSPAN (see `Configuring Remote Port Mirroring`).

Modify

- ◆ **VLAN ID** – ID of configured VLAN (1-4094).
- ◆ **VLAN Name** – Name of the VLAN (1 to 32 characters).
- ◆ **Status** – Enables or disables the specified VLAN.

- ♦ **L3 Interface** – Sets the interface to support Layer 3 configuration, and reserves memory space required to maintain additional information about this interface type. This parameter must be enabled before you can assign an IP address to a VLAN (see Setting the Switch's IP Address (IP Version 4)).

Show

- ♦ **VLAN ID** – ID of configured VLAN.
- ♦ **VLAN Name** – Name of the VLAN.
- ♦ **Status** – Operational status of configured VLAN.
- ♦ **Remote VLAN** – Shows if RSPAN is enabled on this VLAN (see Configuring Remote Port Mirroring).
- ♦ **L3 Interface** – Shows if the interface supports Layer 3 configuration.

Web Interface

To create VLAN groups:

1. Click **VLAN> Static**.
2. Select Add from the Action list.
3. Enter a VLAN ID or range of IDs.
4. Check Status to configure the VLAN as operational.
5. Specify whether the VLANs are to be used for remote port mirroring.
6. Click **Apply**.

VLAN > Static

Action: Add

VLAN ID (1-4094): 2 -

Status: Enabled

Remote VLAN: Enabled

Apply Revert

To modify the configuration settings for VLAN groups:

1. Click **VLAN> Static**.
2. Select Modify from the Action list.
3. Select the identifier of a configured VLAN.
4. Modify the VLAN name or operational status as required.

5. Enable the L3 Interface field to specify that a VLAN will be used as a Layer 3 interface.
6. Click **Apply**.

VLAN > Static

Action:

VLAN ID (1-4094):

VLAN Name:

Status: Enabled

L3 Interface: Enabled

To show the configuration settings for VLAN groups:

1. Click **VLAN > Static**.
2. Select Show from the Action list.

VLAN > Static

Action:

Static VLAN List Total: 2

	VLAN ID	VLAN Name	Status	Remote VLAN	L3 Interface
<input type="checkbox"/>	1	Default/Vlan	Enabled	Disabled	Enabled
<input type="checkbox"/>	2	R&D	Enabled	Disabled	Enabled

Adding Static Members to VLANs

Use the VLAN > Static (Edit Member by VLAN, Edit Member by Interface, or Edit Member by Interface Range) pages to configure port members for the selected VLAN index, interface, or a range of interfaces. Use the menus for editing port members to configure the VLAN behavior for specific interfaces, including the mode of operation (Hybrid or IQ Trunk), the default VLAN identifier (PVID), accepted frame types, and ingress filtering. Assign ports as tagged if they are connected to 802.1Q VLAN compliant devices, or untagged if they are not connected to any VLAN-aware devices. Or configure a port as forbidden to prevent the switch from automatically adding it to a VLAN via the GVRP protocol.

Parameters

These parameters are displayed:

Edit Member by VLAN

- ◆ **VLAN** – ID of configured VLAN (1-4094).
- ◆ **Interface** – Displays a list of ports or trunks.
- ◆ **Port** – Port Identifier. (Range: 1-28/54)
- ◆ **Trunk** – Trunk Identifier. (Range: 1-28)
- ◆ **Mode** – Indicates VLAN membership mode for an interface. (Default: Hybrid)
 - ◆ **Access** - Sets the port to operate as an untagged interface. The port transmits and receives untagged frames on a single VLAN only.
 - ◆ **Hybrid** – Specifies a hybrid VLAN interface. The port may transmit tagged or untagged frames.
 - ◆ **1Q Trunk** – Specifies a port as an end-point for a VLAN trunk. A trunk is a direct link between two switches, so the port transmits tagged frames that identify the source VLAN. Note that frames belonging to the port's default VLAN (i.e., associated with the PVID) are also transmitted as tagged frames.
- ◆ **PVID** – VLAN ID assigned to untagged frames received on the interface. (Default: 1)

When using Access mode, and an interface is assigned to a new VLAN, its PVID is automatically set to the identifier for that VLAN.
- ◆ **Acceptable Frame Type** – Sets the interface to accept all frame types, including tagged or untagged frames, or only tagged frames. When set to receive all frame types, any received frames that are untagged are assigned to the port default VLAN if not matched to a configured MAC VLAN, IP-subnet VLAN, or protocol VLAN. (Options: All, Tagged; Default: All)
- ◆ **Ingress Filtering** – Determines how to process frames tagged for VLANs for which the ingress port is not a member. (Default: Enabled)
 - ◆ If ingress filtering is disabled and a port receives frames classified to VLANs for which it is not a member, these frames will be flooded to all other ports that are members of the VLANs.
 - ◆ If ingress filtering is enabled and a port receives frames tagged for VLANs for which it is not a member, these frames will be discarded.
 - ◆ Ingress filtering does not affect VLAN independent BPDU frames, such as GVRP or STP. However, they do affect VLAN dependent BPDU frames, such as GMRP.
- ◆ **Membership Type** – Select VLAN membership for each interface by marking the appropriate radio button for a port or trunk:
 - ◆ **Tagged**: Interface is a member of the VLAN. All packets transmitted by the port will be tagged, that is, carry a tag and therefore carry VLAN or CoS information.

- ♦ **Untagged:** Interface is a member of the VLAN. All packets transmitted by the port will be untagged, that is, not carry a tag and therefore not carry VLAN or CoS information. Note that an interface must be assigned to at least one group as an untagged port.
- ♦ **Forbidden:** Interface cannot be included as a member of the VLAN via GVRP. For more information, see Configuring Dynamic VLAN Registration.

This attribute cannot be configured if the specified VLAN does not exist on the switch.

- ♦ **None:** Interface is not a member of the VLAN. Packets associated with this VLAN will not be transmitted by the interface.

Note: VLAN 1 is the default untagged VLAN containing all ports on the switch using Hybrid mode.

Edit Member by Interface

All parameters are the same as those described under the preceding section for Edit Member by VLAN.

Edit Member by Interface Range

All parameters are the same as those described under the earlier section for Edit Member by VLAN, except for the items shown below.

- ♦ **Port Range** – Displays a list of ports. (Range: 1-28/54)
- ♦ **Trunk Range** – Displays a list of ports. (Range: 1-28)

Note: The PVID, acceptable frame type, and ingress filtering parameters for each interface within the specified range must be configured on either the Edit Member by VLAN or Edit Member by Interface page.

Web Interface

To configure static members by the VLAN index:

1. Click **VLAN> Static**.
2. Select Edit Member by VLAN from the Action list.
3. Select a VLAN from the scroll-down list.
4. Set the Interface type to display as Port or Trunk.
5. Modify the settings for any interface as required.
6. Click **Apply**.

VLAN > Static

Action:

VLAN:

Interface: Port Trunk

Static VLAN Port Member List Total: 26

Port	Mode	PVID (1-4094)	Acceptable Frame Type	Ingress Filtering	Membership Type			
					Tagged	Untagged	Forbidden	None
1	Hybrid	1	All	<input checked="" type="checkbox"/> Enabled	<input type="radio"/>	<input checked="" type="radio"/>	<input type="radio"/>	<input type="radio"/>
2	Hybrid	1	All	<input checked="" type="checkbox"/> Enabled	<input type="radio"/>	<input checked="" type="radio"/>	<input type="radio"/>	<input type="radio"/>
3	Hybrid	1	All	<input checked="" type="checkbox"/> Enabled	<input type="radio"/>	<input checked="" type="radio"/>	<input type="radio"/>	<input type="radio"/>
6	Hybrid	1	All	<input checked="" type="checkbox"/> Enabled	<input type="radio"/>	<input checked="" type="radio"/>	<input type="radio"/>	<input type="radio"/>

To configure static members by interface:

1. Click **VLAN > Static**.
2. Select Edit Member by Interface from the Action list.
3. Select a port or trunk configure.
4. Modify the settings for any interface as required.
5. Click **Apply**.

VLAN > Static

Action:

Interface: Port Trunk

Mode:

PVID:

Acceptable Frame Type:

Ingress Filtering: Enabled

Static VLAN Membership List Total: 2

VLAN	Membership Type			
	Tagged	Untagged	Forbidden	None
1	<input type="radio"/>	<input checked="" type="radio"/>	<input type="radio"/>	<input type="radio"/>
9	<input type="radio"/>	<input type="radio"/>	<input type="radio"/>	<input checked="" type="radio"/>

To configure static members by interface range:

1. Click **VLAN > Static**.
2. Select Edit Member by Interface Range from the Action list.
3. Set the Interface type to display as Port or Trunk.
4. Enter an interface range.
5. Modify the VLAN parameters as required. Remember that the PVID, acceptable frame type, and ingress filtering parameters for each interface

within the specified range must be configured on either the Edit Member by VLAN or Edit Member by Interface page..

6. Click **Apply**.

Configuring Dynamic VLAN Registration

Use the VLAN > Dynamic page to enable GVRP globally on the switch, or to enable GVRP and adjust the protocol timers per interface.

Parameters

These parameters are displayed:

Configure General

- ◆ **GVRP Status** – GVRP defines a way for switches to exchange VLAN information in order to register VLAN members on ports across the network. VLANs are dynamically configured based on join messages issued by host devices and propagated throughout the network. GVRP must be enabled to permit automatic VLAN registration, and to support VLANs which extend beyond the local switch. (Default: Disabled)

Configure Interface

- ◆ **Interface** – Displays a list of ports or trunks.
- ◆ **Port** – Port Identifier. (Range: 1-28/54)
- ◆ **Trunk** – Trunk Identifier. (Range: 1-28)
- ◆ **GVRP Status** – Enables/disables GVRP for the interface. GVRP must be globally enabled for the switch before this setting can take effect (using the Configure General page). When disabled, any GVRP packets received on this port will be discarded and no GVRP registrations will be propagated from other ports. (Default: Disabled)

GVRP cannot be enabled for ports set to Access mode (see Adding Static Members to VLANs).

- ♦ **GVRP Timers** – Timer settings must follow this rule: 2 x (join timer) < leave timer < leaveAll timer
 - ♦ **Join** – The interval between transmitting requests/queries to participate in a VLAN group. (Range: 20-1000 centiseconds; Default: 20 centiseconds)
 - ♦ **Leave** – The interval a port waits before leaving a VLAN group. This time should be set to more than twice the join time. This ensures that after a Leave or LeaveAll message has been issued, the applicants can rejoin before the port actually leaves the group. (Range: 60-3000 centiseconds; Default: 60 centiseconds)
 - ♦ **LeaveAll** – The interval between sending out a LeaveAll query message for VLAN group participants and the port leaving the group. This interval should be considerably larger than the Leave Time to minimize the amount of traffic generated by nodes rejoining the group. (Range: 500-18000 centiseconds; Default: 1000 centiseconds)

Show Dynamic VLA - Show VLAN

- ♦ **VLAN ID** – Identifier of a VLAN this switch has joined through GVRP.
- ♦ **VLAN Name** – Name of a VLAN this switch has joined through GVRP.
- ♦ **Status** – Indicates if this VLAN is currently operational. (Display Values: Enabled, Disabled)

Show Dynamic VLAN - Show VLAN Member

- ♦ **VLAN** – Identifier of a VLAN this switch has joined through GVRP.
- ♦ **Interface** – Displays a list of ports or trunks which have joined the selected VLAN through GVRP.

Web Interface

To configure GVRP on the switch:

1. Click **VLAN> Dynamic**.
2. Select Configure General from the Step list.
3. Enable or disable GVRP.
4. Click **Apply**.

VLAN > Dynamic

Step: 1. Configure General

GVRP Status Enabled

To configure GVRP status and timers on a port or trunk:

1. Click **VLAN> Dynamic**.
2. Select Configure Interface from the Step list.
3. Set the Interface type to display as Port or Trunk.
4. Modify the GVRP status or timers for any interface.
5. Click **Apply**.

VLAN > Dynamic

Step: 2. Configure Interface

Interface: Port Trunk

Port List Total: 28

Port	GVRP Status	GARP Timer (centiseconds)		
		Join (20-1000)	Leave (60-3000)	LeaveAll (500-18000)
1	<input type="checkbox"/> Enabled	20	60	1000
2	<input type="checkbox"/> Enabled	20	60	1000
3	<input type="checkbox"/> Enabled	20	60	1000
4	<input type="checkbox"/> Enabled	20	60	1000

To show the dynamic VLAN joined by this switch:

1. Click **VLAN> Dynamic**.
2. Select Show Dynamic VLAN from the Step list.
3. Select Show VLAN from the Action list.

VLAN > Dynamic

Step: 3. Show Dynamic VLAN Action: Show VLAN

Dynamic VLAN List Total: 2

VLAN ID	VLAN Name	Status
120		Enabled
150		Enabled

To show the members of a dynamic VLAN:

1. Click **VLAN > Dynamic**.
2. Select Show Dynamic VLAN from the Step list.
3. Select Show VLAN Members from the Action list.

VLAN > Dynamic

Step: 3. Show Dynamic VLAN Action: Show VLAN Member

VLAN 120

Dynamic VLAN Member List Total: 10

Interface
Unit 1 / Port 1
Unit 1 / Port 4
Unit 1 / Port 10
Unit 1 / Port 16
Unit 1 / Port 19

IEEE 802.1Q Tunneling

IEEE 802.1Q Tunneling (QinQ) is designed for service providers carrying traffic for multiple customers across their networks. QinQ tunneling is used to maintain customer-specific VLAN and Layer 2 protocol configurations even when different customers use the same internal VLAN IDs. This is accomplished by inserting Service Provider VLAN (SPVLAN) tags into the customer's frames when they enter the service provider's network, and then stripping the tags when the frames leave the network.

A service provider's customers may have specific requirements for their internal VLAN IDs and number of VLANs supported. VLAN ranges required by different customers in the same service-provider network might easily overlap, and traffic passing through the infrastructure might be mixed. Assigning a unique range of VLAN IDs to each customer would restrict customer configurations, require intensive processing of VLAN mapping tables, and could easily exceed the maximum VLAN limit of 4096.

QinQ tunneling uses a single Service Provider VLAN (SPVLAN) for customers who have multiple VLANs. Customer VLAN IDs are preserved and traffic from different customers is segregated within the service provider's network even when they use the same customer-specific VLAN IDs. QinQ tunneling expands VLAN space by using a VLAN-in-VLAN hierarchy, preserving the customer's original tagged packets, and adding SPVLAN tags to each frame (also called double tagging).

A port configured to support QinQ tunneling must be set to tunnel port mode. The Service Provider VLAN (SPVLAN) ID for the specific customer must be assigned to the QinQ tunnel access port on the edge switch where the customer traffic enters the service provider's network. Each customer requires a separate SPVLAN, but this VLAN supports all of the customer's internal VLANs. The QinQ tunnel uplink port that passes traffic from the edge switch into the service provider's metro network must also be added to this SPVLAN. The uplink port can be added to multiple SPVLANs to carry inbound traffic for different customers onto the service provider's network.

When a double-tagged packet enters another trunk port in an intermediate or core switch in the service provider's network, the outer tag is stripped for packet processing. When the packet exits another trunk port on the same core switch, the same SPVLAN tag is again added to the packet.

When a packet enters the trunk port on the service provider's egress switch, the outer tag is again stripped for packet processing. However, the SPVLAN tag is not added when it is sent out the tunnel access port on the edge switch into the

customer's network. The packet is sent as a normal IEEE 802.1Q-tagged frame, preserving the original VLAN numbers used in the customer's network.

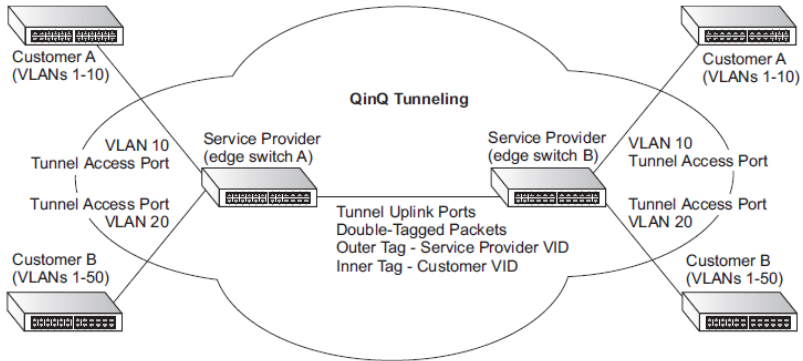

Layer 2 Flow for Packets Coming into a Tunnel Access Port

A QinQ tunnel port may receive either tagged or untagged packets. No matter how many tags the incoming packet has, it is treated as tagged packet.

The ingress process does source and destination lookups. If both lookups are successful, the ingress process writes the packet to memory. Then the egress process transmits the packet. Packets entering a QinQ tunnel port are processed in the following manner:

1. An SPVLAN tag is added to all outbound packets on the SPVLAN interface, no matter how many tags they already have. The switch constructs and inserts the outer tag (SPVLAN) into the packet based on the default VLAN ID and Tag Protocol Identifier (TPID, that is, the ether-type of the tag), unless otherwise defined as described under Creating CVLAN to SPVLAN Mapping Entries. The priority of the inner tag is copied to the outer tag if it is a tagged or priority tagged packet.
2. After successful source and destination lookup, the ingress process sends the packet to the switching process with two tags. If the incoming packet is untagged, the outer tag is an SPVLAN tag, and the inner tag is a dummy tag (8100 0000). If the incoming packet is tagged, the outer tag is an SPVLAN tag, and the inner tag is a CVLAN tag.
3. After packet classification through the switching process, the packet is written to memory with one tag (an outer tag) or with two tags (both an outer tag and inner tag).
4. The switch sends the packet to the proper egress port.

5. If the egress port is an untagged member of the SPVLAN, the outer tag will be stripped. If it is a tagged member, the outgoing packets will have two tags.

Layer 2 Flow for Packets Coming into a Tunnel Uplink Port

An uplink port receives one of the following packets:

- ◆ Untagged
- ◆ One tag (CVLAN or SPVLAN)
- ◆ Double tag (CVLAN + SPVLAN)

The ingress process does source and destination lookups. If both lookups are successful, the ingress process writes the packet to memory. Then the egress process transmits the packet. Packets entering a QinQ uplink port are processed in the following manner:

1. If incoming packets are untagged, the PVID VLAN native tag is added.
2. If the ether-type of an incoming packet (single or double tagged) is not equal to the TPID of the uplink port, the VLAN tag is determined to be a Customer VLAN (CVLAN) tag. The uplink port's PVID VLAN native tag is added to the packet. This outer tag is used for learning and switching packets within the service provider's network. The TPID must be configured on a per port basis, and the verification cannot be disabled.
3. If the ether-type of an incoming packet (single or double tagged) is equal to the TPID of the uplink port, no new VLAN tag is added. If the uplink port is not the member of the outer VLAN of the incoming packets, the packet will be dropped when ingress filtering is enabled. If ingress filtering is not enabled, the packet will still be forwarded. If the VLAN is not listed in the VLAN table, the packet will be dropped.
4. After successful source and destination lookups, the packet is double tagged. The switch uses the TPID of 0x8100 to indicate that an incoming packet is double-tagged. If the outer tag of an incoming double-tagged packet is equal to the port TPID and the inner tag is 0x8100, it is treated as a double-tagged packet. If a single-tagged packet has 0x8100 as its TPID, and port TPID is not 0x8100, a new VLAN tag is added and it is also treated as double-tagged packet.
5. If the destination address lookup fails, the packet is sent to all member ports of the outer tag's VLAN.
6. After packet classification, the packet is written to memory for processing as a single-tagged or double-tagged packet.
7. The switch sends the packet to the proper egress port.

8. If the egress port is an untagged member of the SPVLAN, the outer tag will be stripped. If it is a tagged member, the outgoing packet will have two tags.

Configuration Limitations for QinQ

- ◆ The native VLAN of uplink ports should not be used as the SPVLAN. If the SPVLAN is the uplink port's native VLAN, the uplink port must be an untagged member of the SPVLAN. Then the outer SPVLAN tag will be stripped when the packets are sent out. Another reason is that it causes non-customer packets to be forwarded to the SPVLAN.
- ◆ Static trunk port groups are compatible with QinQ tunnel ports as long as the QinQ configuration is consistent within a trunk port group.
- ◆ The native VLAN (VLAN 1) is not normally added to transmitted frames. Avoid using VLAN 1 as an SPVLAN tag for customer traffic to reduce the risk of misconfiguration. Instead, use VLAN 1 as a management VLAN instead of a data VLAN in the service provider network.
- ◆ There are some inherent incompatibilities between Layer 2 and Layer 3 switching:
 - ◆ Tunnel ports do not support IP Access Control Lists.
 - ◆ Layer 3 Quality of Service (QoS) and other QoS features containing Layer 3 information are not supported on tunnel ports.
 - ◆ Spanning tree bridge protocol data unit (BPDU) filtering is automatically disabled on a tunnel port.

General Configuration Guidelines for QinQ

1. Enable Tunnel Status, and set the Tag Protocol Identifier (TPID) value of the tunnel access port (in the Ethernet Type field). This step is required if the attached client is using a nonstandard 2-byte ethertype to identify 802.1Q tagged frames. The default ethertype value is 0x8100.
2. Create a Service Provider VLAN, also referred to as an SPVLAN.
3. Configure the QinQ tunnel access port to Access mode.
4. Configure the QinQ tunnel access port to join the SPVLAN as an untagged member.
5. Configure the SPVLAN ID as the native VID on the QinQ tunnel access port.
6. Configure the QinQ tunnel uplink port to Uplink mode.
7. Configure the QinQ tunnel uplink port to join the SPVLAN as a tagged member.

Enabling QinQ Tunneling on the Switch

Use the VLAN > Tunnel (Configure Global) page to configure the switch to operate in IEEE 802.1Q (QinQ) tunneling mode, which is used for passing Layer 2 traffic across a service provider's metropolitan area network. You can also globally set the Tag Protocol Identifier (TPID) value of the tunnel port if the attached client is using a nonstandard 2-byte ethertype to identify 802.1Q tagged frames.

Parameters

These parameters are displayed:

- ◆ **Tunnel Status** – Sets the switch to QinQ mode. (Default: Disabled)
- ◆ **Ethernet Type** – The Tag Protocol Identifier (TPID) specifies the ethertype of incoming packets on a tunnel port. (Range: hexadecimal 0800-FFFF; Default: 8100)

Use this field to set a custom 802.1Q ethertype value for the 802.1Q Tunnel TPID. This feature allows the switch to interoperate with third-party switches that do not use the standard 0x8100 ethertype to identify 802.1Q-tagged frames. For example, if 0x1234 is set as the custom 802.1Q ethertype on a trunk port, incoming frames containing that ethertype are assigned to the VLAN contained in the tag following the ethertype field, as they would be with a standard 802.1Q trunk. Frames arriving on the port containing any other ethertype are looked upon as untagged frames, and assigned to the native VLAN of that port.

The specified ethertype only applies to ports configured in Uplink mode. If the port is in normal mode, the TPID is always 8100. If the port is in Access mode, received packets are processed as untagged packets.

Avoid using well-known etherypes for the TPID unless you can eliminate all side effects. For example, setting the TPID to 0800 hexadecimal (which is used for IPv4) will interfere with management access through the web interface.

Web Interface

To enable QinQ Tunneling on the switch:

1. Click **VLAN > Tunnel**.
2. Select Configure Global from the Step list.
3. Enable Tunnel Status, and specify the TPID if a client attached to a tunnel port is using a non-standard ethertype to identify 802.1Q tagged frames.
4. Click **Apply**.

VLAN > Tunnel

Step: 1. Configure Global

Tunnel Status Enabled

Ethernet Type
(800-FFFF, hexadecimal value)

Apply Revert

Creating CVLAN to SPVLAN Mapping Entries

Use the VLAN > Tunnel (Configure Service) page to create a CVLAN to SPVLAN mapping entry.

Command Usage

- The inner VLAN tag of a customer packet entering the edge router of a service provider's network is mapped to an outer tag indicating the service provider VLAN that will carry this traffic across the 802.1Q tunnel. By default, the outer tag is based on the default VID of the edge router's ingress port. This process is performed in a transparent manner as described under IEEE 802.1Q Tunneling.
- When priority bits are found in the inner tag, these are also copied to the outer tag. This allows the service provider to differentiate service based on the indicated priority and appropriate methods of queue management at intermediate nodes across the tunnel.
- Rather than relying on standard service paths and priority queuing, QinQ VLAN mapping can be used to further enhance service by defining a set of differentiated service pathways to follow across the service provider's network for traffic arriving from specified inbound customer VLANs.
- Note that all customer interfaces should be configured as access interfaces (that is, a user-to-network interface) and service provider interfaces as uplink interfaces (that is, a network-to-network interface). Use the

Configure Interface page described in the next section to set an interface to access or uplink mode.

Parameters

These parameters are displayed:

- ◆ **Interface** – Port or trunk identifier.
- ◆ **C-VID (Customer VLAN ID)** – VLAN ID for the inner VLAN tag. (Range: 1-4094)
- ◆ **S-VID (Service VLAN ID)** – VLAN ID for the outer VLAN tag. (Range: 1-4094)

Web Interface

To configure a mapping entry:

1. Click **VLAN> Tunnel**.
2. Select Configure Service from the Step list.
3. Select Add from the Action list.
4. Select an interface from the Port list.
5. Specify the CVID to SVID mapping for packets exiting the specified port.
6. Click **Apply**.

VLAN > Tunnel

Step: 2. Configure Service Action: Add

Interface Unit 1 Trunk 1

Match Type Tagged

C-VID (1-4094)

Action:

Assign S-VID (1-4094)

Apply Revert

To show the mapping table:

1. Click **VLAN> Tunnel**.
2. Select Configure Service from the Step list.
3. Select Show from the Action list.
4. Select an interface from the Port list.

VLAN > Tunnel

Step: 2. Configure Service Action: Show

Tunnel Service Subscriptions List Total: 1

<input type="checkbox"/>	Interface	Customer VLAN ID	Service VLAN ID
<input type="checkbox"/>	Eth 1/6	55	44

Default Service Total: 0

Interface

Discard Untagged Traffic Total: 0

Interface

Delete Revert

The preceding example sets the SVID to 44 in the outer tag for egress packets exiting port 6 when the packet's CVID is 55. For a more detailed example, see the “switchport dot1q-tunnel service match cvid” command in the *CLI Reference Guide*.

Adding an Interface to a QinQ Tunnel

Follow the guidelines under Enabling QinQ Tunneling on the Switch in the preceding section to set up a QinQ tunnel on the switch. Then use the VLAN > Tunnel (Configure Interface) page to set the tunnel mode for any participating interface.

Command Usage

- ◆ Use the Configure Global page to set the switch to QinQ mode before configuring a tunnel access port or tunnel uplink port. Also set the Tag Protocol Identifier (TPID) value of the tunnel access port if the attached client is using a nonstandard 2-byte ethertype to identify 802.1Q tagged frames.
- ◆ Then use the Configure Interface page to set the access interface on the edge switch to Access mode, and set the uplink interface on the switch attached to the service provider network to Uplink mode.

Parameters

These parameters are displayed:

- ◆ **Interface** – Displays a list of ports or trunks.
- ◆ **Port** – Port Identifier. (Range: 1-28/54)
- ◆ **Trunk** – Trunk Identifier. (Range: 1-28)
- ◆ **Mode** – Sets the VLAN membership mode of the port.

- ♦ **None** – The port operates in its normal VLAN mode. (This is the default.)
- ♦ **Access** – Configures QinQ tunneling for a client access port to segregate and preserve customer VLAN IDs for traffic crossing the service provider network.
- ♦ **Uplink** – Configures QinQ tunneling for an uplink port to another device within the service provider network.
- ♦ **Priority Mapping** – Copies the inner tag priority to the outer tag priority. When priority bits are found in the inner tag, these are also copied to the outer tag. This allows the service provider to differentiate service based on the indicated priority and appropriate methods of queue management at intermediate nodes across the tunnel.

Web Interface

To add an interface to a QinQ tunnel:

1. Click **VLAN > Tunnel**.
2. Select **Configure Interface** from the Step list.
3. Set the mode for any tunnel access port to **Access** and the tunnel uplink port to **Uplink**.
4. Click **Apply**.

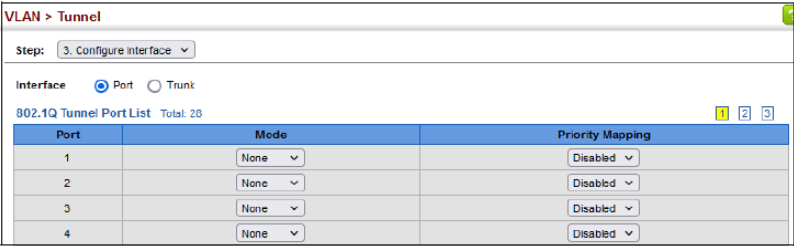

VLAN > Tunnel

Step: 3. Configure Interface

Interface: Port Trunk

802.1Q Tunnel Port List Total: 20

Port	Mode	Priority Mapping
1	None	Disabled
2	None	Disabled
3	None	Disabled
4	None	Disabled

L2PT Tunneling

When Layer 2 Protocol Tunneling (L2PT) is not used, protocol packets (e.g., STP) are flooded to 802.1Q access ports on the same edge switch, but filtered from 802.1Q tunnel ports. This creates disconnected protocol domains in the customer's network.

L2PT can be used to pass various types of protocol packets belonging to the same customer transparently across a service provider's network. In this way, normally segregated network segments can be configured to function inside a common protocol domain.

Command Usage

- ♦ L2PT encapsulates protocol packets entering ingress ports on the service provider's edge switch, replacing the destination MAC address with a proprietary MAC address (for example, the spanning tree protocol uses 10-12-CF-00-00-02), a reserved address for other specified protocol types (as defined in IEEE 802.1ad – Provider Bridges), or a user-defined address. All intermediate switches carrying this traffic across the service provider's network treat these encapsulated packets in the same way as normal data, forwarding them to the tunnel's egress port. The egress port decapsulates these packets, restores the proper protocol and MAC address information, and then floods them onto the same VLANs at the customer's remote site (via all of the appropriate tunnel ports and access ports⁴ connected to the same metro VLAN).

Note: 4. Access ports in this context are 802.1Q trunk ports.

- ♦ The way in which L2PT processes packets is based on the following criteria - (1) packet is received on a QinQ uplink port, (2) packet is received on a QinQ access port, or (3) received packet is Cisco-compatible L2PT (i.e., as indicated by a proprietary MAC address).

Processing protocol packets defined in IEEE 802.1ad – Provider Bridges

- ♦ When an IEEE 802.1ad protocol packet is received on an uplink port (i.e., an 802.1Q tunnel ingress port connecting the edge switch to the service provider network)
 - ♦ With the destination address 01-80-C2-00-00-00,0B~0F (C-VLAN tag), it is forwarded to all QinQ uplink ports and QinQ access ports in the same S-VLAN for which L2PT is enabled for that protocol.

- ◆ With the destination address 01-80-C2-00-00-01~0A (S-VLAN tag), it is filtered, decapsulated, and processed locally by the switch if the protocol is supported.
- ◆ When a protocol packet is received on an access port (i.e., an 802.1Q trunk port connecting the edge switch to the local customer network)
 - ◆ With the destination address 01-80-C2-00-00-00,0B~0F (C-VLAN), and
 - ◆ L2PT is enabled on the port, the frame is forwarded to all QinQ uplink ports and QinQ access ports on which L2PT is enabled for that protocol in the same S-VLAN.
 - ◆ L2PT is disabled on the port, the frame is decapsulated and processed locally by the switch if the protocol is supported.
 - ◆ With destination address 01-80-C2-00-00-01~0A (S-VLAN), the frame is filtered, decapsulated, and processed locally by the switch if the protocol is supported.

Processing Cisco-compatible protocol packets

- ◆ When a Cisco-compatible L2PT packet is received on an uplink port, and
 - ◆ Recognized as a CDP/VTP/STP/PVST+ protocol packet (where STP means STP/RSTP/MSTP), it is forwarded to the following ports in the same S-VLAN: (a) all access ports for which L2PT has been disabled, and (b) all uplink ports.
 - ◆ Recognized as a Generic Bridge PDU Tunneling (GBPT) protocol packet (i.e., having the destination address 01-00-0C-CD-CD-D0), it is forwarded to the following ports in the same S-VLAN:
 - ◆ Other access ports for which L2PT is enabled after decapsulating the packet and restoring the proper protocol and MAC address information.
 - ◆ All uplink ports.
- ◆ When a Cisco-compatible L2PT packet is received on an access port, and
 - ◆ Recognized as a CDP/VTP/STP/PVST+ protocol packet, and
 - ◆ L2PT is enabled on this port, it is forwarded to the following ports in the same S-VLAN: (a) other access ports for which L2PT is enabled, and (b) uplink ports after rewriting the destination address to make it a GBPT protocol packet (i.e., setting the destination address to 01-00-0C-CD-CD-D0).
 - ◆ L2PT is disabled on this port, it is forwarded to the following ports in the same S-VLAN: (a) other access ports for which L2PT is disabled, and (b) all uplink ports.

- ◆ Recognized as a GBPT protocol packet (i.e., having the destination address 01-00-0C-CD-CD-D0), and
 - ◆ L2PT is enabled on this port, it is forwarded to other access ports in the same S-VLAN for which L2PT is enabled
 - ◆ L2PT is disabled on this port, it is forwarded to the following ports in the same S-VLAN: (a) other access ports for which L2PT is disabled, and (b) all uplink ports.

L2PT Functional Requirements

- ◆ For L2PT to function properly, QinQ must be enabled on the switch (see Enabling QinQ Tunneling on the Switch), and the interface configured to 802.1Q uplink mode (see Adding an Interface to a QinQ Tunnel).

Configuring the L2PT Tunnel Address

Use the VLAN > L2PT (Configure Global) page to configure the destination MAC address for Layer 2 Protocol Tunneling.

Parameters

These parameters are displayed:

Tunnel MAC Address – The switch rewrites the destination MAC address in all upstream L2PT protocol packets (e.g., STP BPDUs) to this value, and forwards them on to uplink ports. (Format xx-xx-xx-xx-xx-xx or xxxxxxxxxxxx; Default: 01-12-CF-.00-00-02, proprietary tunnel address)

Web Interface

To configure the destination MAC address for L2PT:

1. Click **VLAN > L2PT**.
2. Select Configure Global from the Step list.
3. Set the tunnel MAC address.
4. Click **Apply**.

VLAN > L2PT

Step: 1. Configure Global ▾

Tunnel MAC Address (xx-xx-xx-xx-xx-xx or xxxxxxxxxxxx)

Enabling L2PT for Selected Interfaces

Use the VLAN > L2PT (Configure Interface) page to enable Layer 2 Protocol Tunneling on selected interfaces.

Parameters

These parameters are displayed:

- ◆ **Interface** – Port or trunk identifier
- ◆ **CDP** - Cisco Discovery Protocol
- ◆ **LACP** - Link Aggregation Control Protocol
- ◆ **LLDP** - Link Layer Discovery Protocol
- ◆ **PVST+** - Cisco Per VLAN Spanning Tree Plus
- ◆ **Spanning Tree** - Spanning Tree (STP, RSTP, MSTP)
- ◆ **VTP** - Cisco VLAN Trunking Protocol

Web Interface

To enable the L2PT on selected interfaces:

1. Click **VLAN > L2PT**.
2. Select **Configure Interface** from the Step list.
3. Mark the protocols to be passed through the L2PT tunnel on the required interfaces.
4. Click **Apply**.

The screenshot shows the 'VLAN > L2PT' configuration page. At the top, there is a 'Step:' dropdown menu set to '2. Configure Interface'. Below this is a table titled 'L2PT Interface List' with a total of 28 interfaces. The table has seven columns: Interface, CDP, LACP, LLDP, PVST+, Spanning Tree, and VTP. Each cell in the table contains a checkbox followed by the word 'Enabled'. All checkboxes are currently unchecked.

Interface	CDP	LACP	LLDP	PVST+	Spanning Tree	VTP
Eth1/1	<input type="checkbox"/> Enabled	<input type="checkbox"/> Enabled	<input type="checkbox"/> Enabled	<input type="checkbox"/> Enabled	<input type="checkbox"/> Enabled	<input type="checkbox"/> Enabled
Eth1/2	<input type="checkbox"/> Enabled	<input type="checkbox"/> Enabled	<input type="checkbox"/> Enabled	<input type="checkbox"/> Enabled	<input type="checkbox"/> Enabled	<input type="checkbox"/> Enabled
Eth1/3	<input type="checkbox"/> Enabled	<input type="checkbox"/> Enabled	<input type="checkbox"/> Enabled	<input type="checkbox"/> Enabled	<input type="checkbox"/> Enabled	<input type="checkbox"/> Enabled
Eth1/4	<input type="checkbox"/> Enabled	<input type="checkbox"/> Enabled	<input type="checkbox"/> Enabled	<input type="checkbox"/> Enabled	<input type="checkbox"/> Enabled	<input type="checkbox"/> Enabled
Eth1/5	<input type="checkbox"/> Enabled	<input type="checkbox"/> Enabled	<input type="checkbox"/> Enabled	<input type="checkbox"/> Enabled	<input type="checkbox"/> Enabled	<input type="checkbox"/> Enabled

Protocol VLANs

The network devices required to support multiple protocols cannot be easily grouped into a common VLAN. This may require non-standard devices to pass traffic between different VLANs in order to encompass all the devices participating in a specific protocol. This kind of configuration deprives users of the basic benefits of VLANs, including security and easy accessibility.

To avoid these problems, you can configure this switch with protocol-based VLANs that divide the physical network into logical VLAN groups for each required protocol. When a frame is received at a port, its VLAN membership can then be determined based on the protocol type being used by the inbound packets.

Command Usage

- ◆ To configure protocol-based VLANs, follow these steps:
 1. First configure VLAN groups for the protocols you want to use. Although not mandatory, we suggest configuring a separate VLAN for each major protocol running on your network. Do not add port members at this time.
 2. Create a protocol group for each of the protocols you want to assign to a VLAN using the Configure Protocol (Add) page.
 3. Then map the protocol for each interface to the appropriate VLAN using the Configure Interface (Add) page.
- ◆ When MAC-based, IP subnet-based, or protocol-based VLANs are supported concurrently, priority is applied in this sequence, and then port-based VLANs last.

Configuring Protocol VLAN Groups

Use the VLAN > Protocol (Configure Protocol - Add) page to create protocol groups.

Parameters

These parameters are displayed:

- ◆ **Frame Type** – Choose either Ethernet, RFC 1042, or LLC Other as the frame type used by this protocol.
- ◆ **Protocol Type** – Specifies the protocol type to match. The available options are IP, ARP, RARP, PPPOE-DIS, PPPOE-SES, and IPv6. If LLC

Other is chosen for the Frame Type, the only available Protocol Type is IPX Raw.

- ◆ **Protocol Group ID** – Protocol Group ID assigned to the Protocol VLAN Group. (Range: 1-2147483647)

Note: Traffic which matches IP Protocol Ethernet Frames is mapped to the VLAN (VLAN 1) that has been configured with the switch's administrative IP. IP Protocol Ethernet traffic must not be mapped to another VLAN or you will lose administrative network connectivity to the switch. If lost in this manner, network access can be regained by removing the offending Protocol VLAN rule via the console. Alternately, the switch can be power-cycled, however all unsaved configuration changes will be lost.

Web Interface

To configure a protocol group:

1. Click **VLAN> Protocol**.
2. Select Configure Protocol from the Step list.
3. Select Add from the Action list.
4. Select an entry from the Frame Type list.
5. Select an entry from the Protocol Type list.
6. Enter an identifier for the protocol group.
7. Click **Apply**.

VLAN > Protocol

Step: 1. Configure Protocol Action: Add

Frame Type: Ethernet

Protocol Type: 08 06 (ARP)

Protocol Group ID (1-2147483647): 1

Apply Revert

To configure a protocol group:

1. Click **VLAN> Protocol**.
2. Select Configure Protocol from the Step list.
3. Select Show from the Action list.

VLAN > Protocol

Step: 1. Configure Protocol Action: Show

Protocol to Group Mapping Table Total: 5

<input type="checkbox"/>	Frame Type	Protocol Type	Protocol Group ID
<input type="checkbox"/>	Ethernet	08 06	1
<input type="checkbox"/>	Ethernet	80 35	2
<input type="checkbox"/>	RFC 1042	08 00	1
<input type="checkbox"/>	RFC 1042	80 35	3
<input type="checkbox"/>	LLC Other	FF FF	5

Delete Revert

Mapping Protocol Groups to Interfaces

Use the VLAN > Protocol (Configure Interface - Add) page to map a protocol group to a VLAN for each interface that will participate in the group.

Command Usage

- ◆ When creating a protocol-based VLAN, only assign interfaces using this configuration screen. If you assign interfaces using any of the other VLAN menus such as the VLAN Static table, these interfaces will admit traffic of any protocol type into the associated VLAN.
- ◆ When a frame enters a port that has been assigned to a protocol VLAN, it is processed in the following manner:
 - ◆ If the frame is tagged, it will be processed according to the standard rules applied to tagged frames.
 - ◆ If the frame is untagged and the protocol type matches, the frame is forwarded to the appropriate VLAN.
 - ◆ If the frame is untagged but the protocol type does not match, the frame is forwarded to the default VLAN for this interface.

Parameters

These parameters are displayed:

- ◆ **Interface** – Displays a list of ports or trunks.
- ◆ **Port** – Port Identifier. (Range: 1-28/54)
- ◆ **Trunk** – Trunk Identifier. (Range: 1-28)
- ◆ **Protocol Group ID** – Protocol Group ID assigned to the Protocol VLAN Group. (Range: 1-2147483647)

- ♦ **VLAN ID** – VLAN to which matching protocol traffic is forwarded. (Range: 1-4094)
- ♦ **Priority** – The priority assigned to untagged ingress traffic. (Range: 0-7, where 7 is the highest priority)

Web Interface

To map a protocol group to a VLAN for a port or trunk:

1. Click **VLAN > Protocol**.
2. Select Configure Interface from the Step list.
3. Select Add from the Action list.
4. Select a port or trunk.
5. Enter the identifier for a protocol group.
6. Enter the corresponding VLAN to which the protocol traffic will be forwarded.
7. Set the priority to assign to untagged ingress frames.
8. Click **Apply**.

The screenshot shows the 'VLAN > Protocol' configuration page. At the top, the 'Step' is set to '2. Configure Interface' and the 'Action' is 'Add'. Below this, there are four main configuration fields: 'Interface' (with radio buttons for 'Port' and 'Trunk', and a dropdown for '1'), 'Protocol Group ID' (dropdown for '1'), 'VLAN ID (1-4094)' (text input), and 'Priority (0-7)' (text input). At the bottom right, there are 'Apply' and 'Revert' buttons.

To show the protocol groups mapped to a port or trunk:

1. Click **VLAN > Protocol**.
2. Select Configure Interface from the Step list.
3. Select Show from the Action list.
4. Select a port or trunk.

The screenshot shows the 'VLAN > Protocol' configuration page with the 'Action' set to 'Show'. Below the configuration fields, there is a table titled 'Port To Protocol Group Mapping Table Total: 1'. The table has four columns: a checkbox, 'Protocol Group ID', 'VLAN ID', and 'Priority'. There is one row of data with values 1, 2, and 0 respectively. At the bottom, there are 'Delete' and 'Revert' buttons.

<input type="checkbox"/>	Protocol Group ID	VLAN ID	Priority
<input type="checkbox"/>	1	2	0

IP Subnet VLANs

Use the VLAN > IP Subnet page to configure IP subnet-based VLANs.

When using port-based classification, all untagged frames received by a port are classified as belonging to the VLAN whose VID (PVID) is associated with that port.

When IP subnet-based VLAN classification is enabled, the source address of untagged ingress frames are checked against the IP subnet-to-VLAN mapping table. If an entry is found for that subnet, these frames are assigned to the VLAN indicated in the entry. If no IP subnet is matched, the untagged frames are classified as belonging to the receiving port's VLAN ID (PVID).

Command Usage

- ◆ Each IP subnet can be mapped to only one VLAN ID. An IP subnet consists of an IP address and a mask. The specified VLAN need not be an existing VLAN.
- ◆ When an untagged frame is received by a port, the source IP address is checked against the IP subnet-to-VLAN mapping table, and if an entry is found, the corresponding VLAN ID is assigned to the frame. If no mapping is found, the PVID of the receiving port is assigned to the frame.
- ◆ Packet forwarding within the IP subnet requires that the following conditions are satisfied:
 - ◆ Inbound packet must be an IP packet (EtherType 0x0800).
 - ◆ The interface must be configured as a member of the subnet VLAN.
 - ◆ The IP address and subnet mask of the inbound packet must fall within specified subnet VLAN

The above conditions mean that any ARP requests will not be forwarded within the subnet VLAN because they are EtherType 0x0806 and do not meet the requirements for an IP subnet VLAN.

Also, note that TCP/UDP port numbers are not considered when checking whether or not packets are forwarded within the subnet VLAN.

- ◆ The IP subnet cannot be a broadcast or multicast IP address.
- ◆ When MAC-based, IP subnet-based, or protocol-based VLANs are supported concurrently, priority is applied in this sequence, and then port-based VLANs last.

Parameters

These parameters are displayed:

- ♦ **IP Address** – The IP address for a subnet. Valid IP addresses consist of four decimal numbers, 0 to 255, separated by periods.
- ♦ **Subnet Mask** – This mask identifies the host address bits of the IP subnet.
- ♦ **VLAN** – VLAN to which matching IP subnet traffic is forwarded. (Range: 1-4094)
- ♦ **Priority** – The priority assigned to untagged ingress traffic. (Range: 0-7, where 7 is the highest priority; Default: 0)

Web Interface

To map an IP subnet to a VLAN:

1. Click **VLAN> IP Subnet**.
2. Select Add from the Action list.
3. Enter an address in the IP Address field.
4. Enter a mask in the Subnet Mask field.
5. Enter the identifier in the VLAN field. Note that the specified VLAN need not already be configured.
6. Enter a value to assign to untagged frames in the Priority field.
7. Click **Apply**.

VLAN > IP Subnet

Action: Add ▾

IP Address: 192.168.1.0

Subnet Mask: 255.255.255.0

VLAN (1-4094): 10

Priority (0-7): 1

Apply Revert

To show the configured IP subnet VLANs:

1. Click **VLAN> IP Subnet**.
2. Select Show from the Action list.

VLAN > IP Subnet

Action: Show ▾

IP Subnet to VLAN Mapping Table Total: 1

<input type="checkbox"/>	IP Address	Subnet Mask	VLAN	Priority
<input type="checkbox"/>	192.168.1.0	255.255.255.0	10	0

Delete Revert

MAC-based VLANs

Use the VLAN > MAC-Based page to configure VLAN based on MAC addresses. The MAC-based VLAN feature assigns VLAN IDs to ingress untagged frames according to source MAC addresses.

When MAC-based VLAN classification is enabled, untagged frames received by a port are assigned to the VLAN which is mapped to the frame's source MAC address.

When no MAC address is matched, untagged frames are assigned to the receiving port's native VLAN ID (PVID).

Command Usage

- ◆ The MAC-to-VLAN mapping applies to all ports on the switch.
- ◆ Source MAC addresses can be mapped to only one VLAN ID.
- ◆ Configured MAC addresses cannot be broadcast or multicast addresses.
- ◆ When MAC-based, IP subnet-based, or protocol-based VLANs are supported concurrently, priority is applied in this sequence, and then port-based VLANs last.

Parameters

These parameters are displayed:

- ◆ **MAC Address** – A source MAC address which is to be mapped to a specific VLAN. The MAC address must be specified in the format xx-xx-xx-xx-xx-xx.
- ◆ **Mask** – Identifies a range of MAC addresses. (Range: 00-00-00-00-00-00 to ff-ff-ff-ff-ff-ff)

The binary equivalent mask matching the characters in the front of the first non-zero character must all be 1s (e.g., 111, i.e., it cannot be 101 or 001...). A mask for the MAC address: 00-50-6e-00-5f-b1 translated into binary:

MAC: 00000000-01010000-01101110-00000000-01011111-10110001
could be: 11111111-11xxxxxx-xxxxxxxx-xxxxxxxx-xxxxxxxx

So the mask in hexadecimal for this example could be: ff-fx-xx-xx-xx-xx/
ff-c0-00-00-00-00/ff-c0-00-00-00-00

- ◆ **VLAN** – VLAN to which ingress traffic matching the specified source MAC address is forwarded. (Range: 1-4094)
- ◆ **Priority** – The priority assigned to untagged ingress traffic. (Range: 0-7, where 7 is the highest priority; Default: 0)

Web Interface

To map a MAC address to a VLAN:

1. Click **VLAN> MAC-Based**.
2. Select Add from the Action list.
3. Enter an address in the MAC Address field, and a mask to indicate a range of addresses if required.
4. Enter an identifier in the VLAN field. Note that the specified VLAN need not already be configured.
5. Enter a value to assign to untagged frames in the Priority field.
6. Click **Apply**.

The screenshot shows the 'VLAN > MAC-Based' configuration page. At the top, the title is 'VLAN > MAC-Based'. Below the title, there is an 'Action:' dropdown menu set to 'Add'. The main configuration area contains four input fields: 'MAC Address' with the value '00-ab-cd-11-22-33', 'Mask' (empty), 'VLAN (1-4094)' with the value '10', and 'Priority (0-7)' (empty). To the right of the MAC Address and Mask fields are placeholder text examples: '(XX-XX-XX-XX-XX-XX of XXXXXXXXXXXXX)' and '(XX-XX-XX-XX-XX-XX of XXXXXXXXXXXXX)'. At the bottom right of the form are 'Apply' and 'Revert' buttons.

To show the MAC address mapped to a VLAN:

1. Click **VLAN> MAC-Based**.
2. Select Show from the Action list.

The screenshot shows the 'VLAN > MAC-Based' configuration page in 'Show' mode. The title is 'VLAN > MAC-Based'. The 'Action:' dropdown menu is set to 'Show'. Below the title, there is a 'MAC-Based VLAN List' section with a 'Total: 1' indicator. A table displays the configuration details:

	MAC Address	Mask	VLAN	Priority
<input type="checkbox"/>	00-AB-CD-11-22-33	FF-FF-FF-FF-FF-FF	10	0

At the bottom of the table are 'Delete' and 'Revert' buttons.

VLAN Mirroring

Use the VLAN > Mirror (Add) page to mirror traffic from one or more source VLANs to a target port for real-time analysis. You can then attach a logic analyzer or RMON probe to the target port and study the traffic crossing the source VLAN(s) in a completely unobtrusive manner.

Command Usage

- ◆ All active ports in a source VLAN are monitored for ingress traffic only.
- ◆ All VLAN mirror sessions must share the same target port, preferably one that is not a member of the source VLAN.
- ◆ When VLAN mirroring and port mirroring are both enabled, they must use the same target port.
- ◆ When VLAN mirroring and port mirroring are both enabled, the target port can receive a mirrored packet twice; once from the source mirror port and again from the source mirrored VLAN.
- ◆ The target port receives traffic from all monitored source VLANs and can become congested. Some mirror traffic may therefore be dropped from the target port.
- ◆ When mirroring VLAN traffic or packets based on a source MAC address (see Configuring MAC Address Mirroring), the target port cannot be set to the same target ports as that used for port mirroring (see Configuring Local Port Mirroring).
- ◆ When traffic matches the rules for both port mirroring, and for mirroring of VLAN traffic or packets based on a MAC address, the matching packets will not be sent to target port specified for port mirroring.

Parameters

These parameters are displayed:

- ◆ **Source VLAN** – A VLAN whose traffic will be monitored. (Range: 1-4094)
- ◆ **Target Port** – The destination port that receives the mirrored traffic from the source VLAN. (Range: 1-28/54)

Web Interface

To configure VLAN mirroring:

1. Click **VLAN> Mirror**.
2. Select Add from the Action list.

3. Select the source VLAN, and select a target port.
4. Click **Apply**.

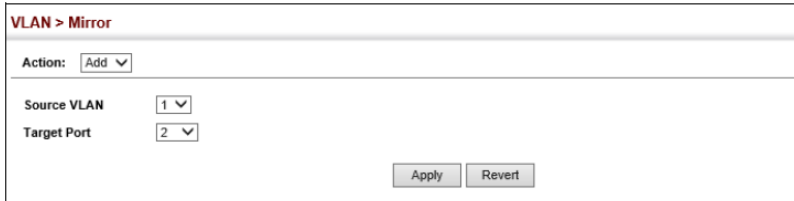

VLAN > Mirror

Action: Add ▾

Source VLAN 1 ▾

Target Port 2 ▾

Apply Revert

To show the VLANs to be mirrored:

1. Click **VLAN > Mirror**.
2. Select Show from the Action list.

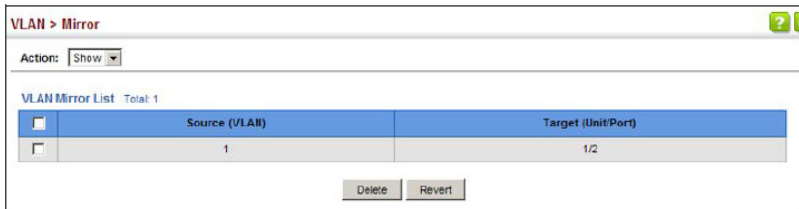

VLAN > Mirror

Action: Show ▾

VLAN Mirror List Total: 1

	Source (VLAN)	Target (Unit/Port)
<input type="checkbox"/>	1	1/2

Delete Revert

VLAN Translation

Use the [VLAN > Translation \(Add\)](#) page to map VLAN IDs between the customer and service provider for networks that do not support IEEE 802.1Q tunneling.

Command Usage

- QinQ tunneling uses double tagging to preserve the customer's VLAN tags on traffic crossing the service provider's network. However, if any switch in the path crossing the service provider's network does not support this feature, then the switches directly connected to that device can be configured to swap the customer's VLAN ID with the service provider's VLAN ID for upstream traffic, or the service provider's VLAN ID with the customer's VLAN ID for downstream traffic.

For example, assume that the upstream switch does not support QinQ tunneling. Select Port 1, and set the Old VLAN to 10 and the New VLAN to 100 to map VLAN 10 to VLAN 100 for upstream traffic entering port 1, and VLAN 100 to VLAN 10 for downstream traffic leaving port 1 as shown below.

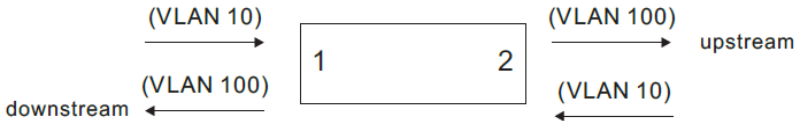

- The maximum number of VLAN translation entries is 8 per port, and up to 96 for the system. However, note that configuring a large number of entries may degrade the performance of other processes that also use the TCAM, such as IP Source Guard filter rules, Quality of Service (QoS) processes, QinQ, MAC-based VLANs, VLAN translation, or traps.
- If VLAN translation is set on an interface, and the same interface is also configured as a QinQ access port on the [VLAN > Tunnel \(Configure Interface\)](#) page, VLAN tag assignments will be determined by the QinQ process, not by VLAN translation.

Parameters

These parameters are displayed:

- Port** – Port identifier.
- Direction** - Specifies to apply VLAN translation to ingress or egress traffic, or both.

- ◆ **Old VLAN** – The original VLAN ID. (Range: 1-4094)
- ◆ **New VLAN** – The new VLAN ID. (Range: 1-4094)

Web Interface

To configure VLAN translation:

1. Click **VLAN> Translation**.
2. Select Add from the Action list.
3. Select a port, and enter the original and new VLAN IDs.
4. Click **Apply**.

VLAN > Translation

Action: Add

Interface: Port Trunk

Port: 2

Direction: Both

Old VLAN (1-4094):

New VLAN (1-4094):

Apply Revert

To show the mapping entries of VLANs translation:

1. Click **VLAN> Translation**.
2. Select Show from the Action list.
3. Select a port.

VLAN > Translation

Action: Show

Interface: Port Trunk

Port: 2

VLAN Translation Table Total: 2

	Direction	Old VLAN	New VLAN
<input type="checkbox"/>	Ingress	9	22
<input type="checkbox"/>	Egress	22	9

Delete Revert

This Page Intentionally Left Blank

Chapter 8

Address Table Settings

Overview

Switches store the addresses for all known devices. This information is used to pass traffic directly between the inbound and outbound ports. All the addresses learned by monitoring traffic are stored in the dynamic address table. You can also manually configure static addresses that are bound to a specific port.

This chapter describes the following topics:

- ♦ *Dynamic Address Cache* – Shows dynamic entries in the address table.
- ♦ *Address Aging Time* – Sets timeout for dynamically learned entries.
- ♦ *MAC Address Learning* – Enables or disables address learning on an interface.
- ♦ *Static MAC Addresses* – Configures static entries in the address table.
- ♦ *MAC Address Mirroring* – Configures the mirroring of traffic matching a specified source MAC address.
- ♦ *MAC Notification Traps* – Issue trap when a dynamic MAC address is added or removed.

Dynamic Address Cache

Use the **MAC Address > Dynamic (Show Dynamic MAC)** page to display the MAC addresses learned by monitoring the source address for traffic entering the switch. When the destination address for inbound traffic is found in the database, the packets intended for that address are forwarded directly to the associated port. Otherwise, the traffic is flooded to all ports.

Parameters

These parameters are displayed:

- ◆ **Sort Key** - You can sort the information displayed based on MAC address, VLAN or interface (port or trunk).
- ◆ **MAC Address** – Physical address associated with this interface.
- ◆ **VLAN** – ID of configured VLAN (1-4094).
- ◆ **Interface** – Indicates a port or trunk.
- ◆ **Type** – Shows that the entries in this table are learned. (Values: Learned or Security, the last of which indicates Port Security)
- ◆ **Life Time** – Shows the time to retain the specified address.

Web Interface

To show the dynamic address table:

1. Click **MAC Address > Dynamic**.
2. Select Show Dynamic MAC from the Action list.
3. Select the Sort Key (MAC Address, VLAN, or Interface).
4. Enter the search parameters (MAC Address, VLAN, or Interface).
5. Click **Query**.

MAC Address > Dynamic

Action: Show Dynamic MAC

Query by:

Sort Key: MAC Address

MAC Address

VLAN

Interface

Interface: Port Trunk

Query

Dynamic MAC Address List Total: 7

MAC Address	VLAN	Interface	Type	Life Time
00-60-61-B1-84-4A	1	Unit 1 / Port 1	Learn	Delete on Timeout
00-E0-0C-10-90-01	1	Unit 1 / Port 1	Learn	Delete on Timeout
00-E0-4C-68-12-56	1	Unit 1 / Port 1	Learn	Delete on Timeout
00-E0-4C-68-14-79	1	Unit 1 / Port 1	Learn	Delete on Timeout
CC-37-AB-A1-06-C0	1	Unit 1 / Port 3	Learn	Delete on Timeout
CC-37-AB-A1-06-C3	1	Unit 1 / Port 3	Learn	Delete on Timeout
CC-37-AB-BB-DE-60	1	Unit 1 / Port 1	Learn	Delete on Timeout

Clearing the Dynamic Address Table

Use the MAC Address > Dynamic (Clear Dynamic MAC) page to remove any learned entries from the forwarding database.

Parameters

These parameters are displayed:

- ◆ **Clear by** – All entries can be cleared; or you can clear the entries for a specific MAC address, all the entries in a VLAN, or all the entries associated with a port or trunk.

Web Interface

To clear the entries in the dynamic address table:

1. Click **MAC Address > Dynamic**.
2. Select Clear Dynamic MAC from the Action list.
3. Select the method by which to clear the entries (i.e., All, MAC Address, VLAN, or Interface).
4. Enter information in the additional fields required for clearing entries by MAC Address, VLAN, or Interface.
5. Click **Clear**.



The screenshot shows a web interface for clearing dynamic MAC addresses. At the top, it says "MAC Address > Dynamic". Below that, there is a "Step:" dropdown menu with "Clear Dynamic MAC" selected. Underneath, there is a "Clear by:" dropdown menu with "All" selected. A "Clear" button is located at the bottom right of the form.

Address Aging Time

Use the **MAC Address > Dynamic (Configure Aging)** page to set the aging time for entries in the dynamic address table. The aging time is used to age out dynamically learned forwarding information.

Parameters

These parameters are displayed:

- ◆ **Aging Status** – Enables/disables the function.
- ◆ **Aging Time** – The time after which a learned entry is discarded. (Range: 6-513 seconds; Default: 300 seconds)

Web Interface

To set the aging time for entries in the dynamic address table:

1. Click **MAC Address > Dynamic**.
2. Select **Configure Aging** from the Action list.
3. Modify the aging status if required.
4. Specify a new aging time.
5. Click **Apply**.

The screenshot shows the 'MAC Address > Dynamic' configuration page. At the top, the breadcrumb 'MAC Address > Dynamic' is displayed. Below it, there is a dropdown menu labeled 'Action:' with 'Configure Aging' selected. The main configuration area contains two settings: 'Aging Status' with a checked checkbox next to the word 'Enabled', and 'Aging Time (6-513)' with a text input field containing '300' followed by the unit 'sec'. At the bottom right of the form, there are two buttons: 'Apply' and 'Revert'.

MAC Address Learning

Use the MAC Address > Learning Status page to enable or disable MAC address learning on an interface.

Command Usage

- ◆ When MAC address learning is disabled, the switch immediately stops learning new MAC addresses on the specified interface. Only incoming traffic with source addresses stored in the static address table will be accepted as authorized to access the network through that interface.
- ◆ Dynamic addresses stored in the address table when MAC address learning is disabled are flushed from the system, and no dynamic addresses are subsequently learned until MAC address learning has been re-enabled. Any device not listed in the static address table that attempts to use the interface after MAC learning has been disabled will be prevented from accessing the switch.
- ◆ Also note that MAC address learning cannot be disabled if any of the following conditions exist:
 - ◆ 802.1X Port Authentication has been globally enabled on the switch.
 - ◆ Security Status is enabled on the same interface.

Parameters

These parameters are displayed:

- ◆ **Interface** – Displays a list of ports or trunks.
- ◆ **Port** – Port Identifier. (Range: 1-28/54)
- ◆ **Trunk** – Trunk Identifier. (Range: 1-28)
- ◆ **Status** – The status of MAC address learning. (Default: Enabled)

Web Interface

To enable or disable MAC address learning:

1. Click **MAC Address > Learning Status**.
2. Set the learning status for any interface.
3. Click **Apply**.

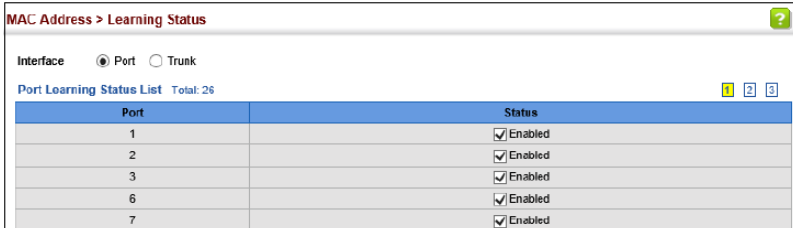

MAC Address > Learning Status ?

Interface Port Trunk

Port Learning Status List Total: 26 1 2 3

Port	Status
1	<input checked="" type="checkbox"/> Enabled
2	<input checked="" type="checkbox"/> Enabled
3	<input checked="" type="checkbox"/> Enabled
6	<input checked="" type="checkbox"/> Enabled
7	<input checked="" type="checkbox"/> Enabled

Static MAC Addresses

Use the MAC Address > Static page to configure static MAC addresses. A static address can be assigned to a specific interface on this switch. Static addresses are bound to the assigned interface and will not be moved. When a static address is seen on another interface, the address will be ignored and will not be written to the address table.

Command Usage

The static address for a host device can be assigned to a specific port within a specific VLAN. Use this command to add static addresses to the MAC Address Table. Static addresses have the following characteristics:

- ◆ Static addresses are bound to the assigned interface and will not be moved. When a static address is seen on another interface, the address will be ignored and will not be written to the address table.
- ◆ Static addresses will not be removed from the address table when a given interface link is down.
- ◆ A static address cannot be learned on another port until the address is removed from the table.

Parameters

These parameters are displayed:

Add Static Address

- ◆ **VLAN** – ID of configured VLAN. (Range: 1-4094)
- ◆ **Interface** – Port or trunk associated with the device assigned a static address.
- ◆ **MAC Address** – Physical address of a device mapped to this interface. Enter an address in the form of xx-xx-xx-xx-xx-xx or xxxxxxxxxxxx.
- ◆ **Static Status** – Sets the time to retain the specified address.
 - ◆ Delete-on-reset - Assignment lasts until the switch is reset.
 - ◆ Permanent - Assignment is permanent. (This is the default.)

Show Static Address

The following additional fields are displayed on this web page:

- ◆ **Type** – Displays the address configuration method. (Values: CPU, Config, or Security, the last of which indicates Port Security)
- ◆ **Life Time** – The duration for which this entry applies. (Values: Delete On Reset, Delete On Timeout, Permanent)

Web Interface

To configure a static MAC address:

1. Click **MAC Address > Static**.
2. Select Add from the Action list.
3. Specify the VLAN, the port or trunk to which the address will be assigned, the MAC address, and the time to retain this entry.
4. Click **Apply**.

MAC Address > Static

Action: Add ▾

VLAN: 1 ▾

Interface: Port 1 ▾ Trunk ▾

MAC Address: 00-12-cf-94-34-da (xx-xx-xx-xx-xx-xx of xxxxxxxxxxxx)

Static Status: Permanent ▾

Apply Revert

To show the static addresses in MAC address table:

1. Click **MAC Address > Static**.
2. Select Show from the Action list.

MAC Address > Static

Action: Show ▾

Static MAC Address to Interface Mapping Table Total: 2

<input type="checkbox"/>	MAC Address	VLAN	Interface	Type	Life Time
<input type="checkbox"/>	00-00-0C-00-00-FD	1	CPU	CPU	Delete on Reset
<input type="checkbox"/>	00-12-CF-94-34-DA	1	Unit 1 / Port 1	Config	Permanent

Delete Revert

MAC Address Mirroring

Use the MAC Address > Mirror (Add) page to mirror traffic matching a specified source address from any port on the switch to a target port for real-time analysis. You can then attach a logic analyzer or RMON probe to the target port and study the traffic crossing the source port in a completely unobtrusive manner.

Command Usage

- ◆ When mirroring traffic from a MAC address, ingress traffic with the specified source address entering any port in the switch, other than the target port, will be mirrored to the destination port.
- ◆ All mirror sessions must share the same destination port.
- ◆ Spanning Tree BPDU packets are not mirrored to the target port.
- ◆ When mirroring port traffic, the target port must be included in the same VLAN as the source port when using MSTP.
- ◆ When mirroring VLAN traffic or packets based on a source MAC address, the target port cannot be set to the same target ports as that used for port mirroring.
- ◆ When traffic matches the rules for both port mirroring, and for mirroring of VLAN traffic or packets based on a MAC address, the matching packets will not be sent to target port specified for port mirroring.

Parameters

These parameters are displayed:

- ◆ **Source MAC** – MAC address in the form of xx-xx-xx-xx-xx-xx or xxxxxxxxxxxx.
- ◆ **Target Port** – The port that will mirror the traffic from the source port. (Range: 1-28/54)

Web Interface

To mirror packets based on a MAC address:

1. Click **MAC Address > Mirror**.
2. Select Add from the Action list.
3. Specify the source MAC address and destination port.
4. Click **Apply**.

MAC Address > Mirror

Action: ▾

Source MAC: (xx-xx-xx-xx-xx-xx or xxxxxxxxxxxx)

Target Port: ▾

To show the MAC addresses to be mirrored:

1. Click **MAC Address > Mirror**.
2. Select Show from the Action list.

MAC Address > Mirror

Action: ▾

MAC Mirror List Total: 1

<input type="checkbox"/>	Source (MAC)	Target (Unit/Port)
<input type="checkbox"/>	11-22-33-44-55-66	1/2

MAC Notification Traps

Use the **MAC Address > MAC Notification** pages to send SNMP traps (i.e., SNMP notifications) when a dynamic MAC address is added or removed.

Parameters

These parameters are displayed:

Configure Global

- ◆ **MAC Notification Traps** – Issues a trap when a dynamic MAC address is added or removed. (Default: Disabled)
- ◆ **MAC Notification Trap Interval** – Specifies the interval between issuing two consecutive traps. (Range: 1-3600 seconds; Default: 1 second)

Configure Interface

- ◆ **Port** – Port Identifier. (Range: 1-28/54)
- ◆ **MAC Notification Trap** – Enables MAC authentication traps on the current interface. (Default: Disabled)

MAC authentication traps must be enabled at the global level for this attribute to take effect.

Web Interface

To enable MAC address traps at the global level:

1. Click **MAC Address > MAC Notification**.
2. Select **Configure Global** from the Step list.
3. Configure MAC notification traps and the transmission interval.
4. Click **Apply**.

MAC Address > MAC Notification

Step: 1. Configure Global ▼

MAC Notification Traps Enabled

MAC Notification Trap Interval (1-3600) sec

To enable MAC address traps at the interface level:

1. Click **MAC Address > MAC Notification**.
2. Select Configure Interface from the Step list.
3. Enable MAC notification traps for the required ports.
4. Click **Apply**.

MAC Address > MAC Notification

Step: 2 Configure Interface

Interface Port Trunk

Port List Total: 26

Port	MAC Notification Trap
1	<input type="checkbox"/> Enabled
2	<input type="checkbox"/> Enabled
3	<input type="checkbox"/> Enabled
6	<input type="checkbox"/> Enabled

Chapter 9

Spanning Tree Algorithm

Overview

This chapter describes the following basic topics:

- ◆ *Loopback Detection* – Configures detection and response to loopback BPDUs.
- ◆ *Global Settings for STA* – Configures global bridge settings for STP, RSTP and MSTP.
- ◆ *Interface Settings for STA* – Configures interface settings for STA, including priority, path cost, link type, and designation as an edge port.
- ◆ *Global Settings for MSTP* – Sets the VLANs and associated priority assigned to an MST instance.
- ◆ *Interface Settings for MSTP* – Configures interface settings for MSTP, including priority and path cost.

The Spanning Tree Algorithm (STA) can be used to detect and disable network loops, and to provide backup links between switches, bridges or routers. This allows the switch to interact with other bridging devices (that is, an STA-compliant switch, bridge or router) in your network to ensure that only one route exists between any two stations on the network, and provide backup links which automatically take over when a primary link goes down.

The spanning tree algorithms supported by this switch include these versions:

- ◆ STP – Spanning Tree Protocol (IEEE 802.1D)
- ◆ RSTP – Rapid Spanning Tree Protocol (IEEE 802.1w)
- ◆ MSTP – Multiple Spanning Tree Protocol (IEEE 802.1s)

STP – STP uses a distributed algorithm to select a bridging device (STP-compliant switch, bridge or router) that serves as the root of the spanning tree network. It selects a root port on each bridging device (except for the root device) which incurs the lowest path cost when forwarding a packet from that device to the root device. Then it selects a designated bridging device from each LAN which incurs the lowest path cost when forwarding a packet from that LAN to the root device. All ports connected to designated bridging devices are assigned as designated ports. After determining the lowest cost spanning tree, it enables all root ports and designated ports, and disables all other ports.

Network packets are therefore only forwarded between root ports and designated ports, eliminating any possible network loops.

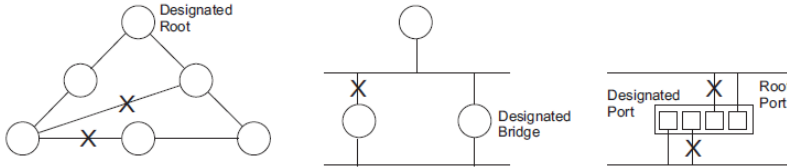

Once a stable network topology has been established, all bridges listen for Hello BPDUs (Bridge Protocol Data Units) transmitted from the Root Bridge. If a bridge does not get a Hello BPDU after a predefined interval (Maximum Age), the bridge assumes that the link to the Root Bridge is down. This bridge will then initiate negotiations with other bridges to reconfigure the network to reestablish a valid network topology.

RSTP – RSTP is designed as a general replacement for the slower, legacy STP. RSTP is also incorporated into MSTP. RSTP achieves much faster reconfiguration (i.e., around 1 to 3 seconds, compared to 30 seconds or more for STP) by reducing the number of state changes before active ports start learning, predefining an alternate route that can be used when a node or port fails, and retaining the forwarding database for ports insensitive to changes in the tree structure when reconfiguration occurs.

MSTP – When using STP or RSTP, it may be difficult to maintain a stable path between all VLAN members. Frequent changes in the tree structure can easily isolate some of the group members. MSTP (which is based on RSTP for fast convergence) is designed to support independent spanning trees based on VLAN groups. Using multiple spanning trees can provide multiple forwarding paths and enable load balancing. One or more VLANs can be grouped into a Multiple Spanning Tree Instance (MSTI). MSTP builds a separate Multiple Spanning Tree (MST) for each instance to maintain connectivity among each of the assigned VLAN groups. MSTP then builds a Internal Spanning Tree (IST) for the Region containing all commonly configured MSTP bridges.

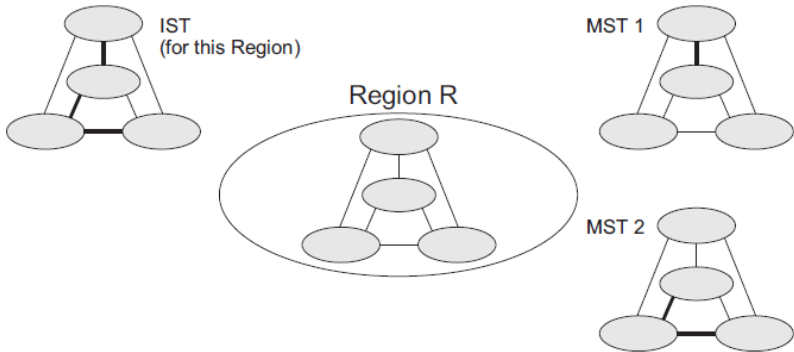

An MST Region consists of a group of interconnected bridges that have the same MST Configuration Identifiers (including the Region Name, Revision Level and Configuration Digest – see Configuring Multiple Spanning Trees). An MST Region may contain multiple MSTP Instances. An Internal Spanning Tree (IST) is used to connect all the MSTP switches within an MST region. A Common Spanning Tree (CST) interconnects all adjacent MST Regions, and acts as a virtual bridge node for communications with STP or RSTP nodes in the global network.

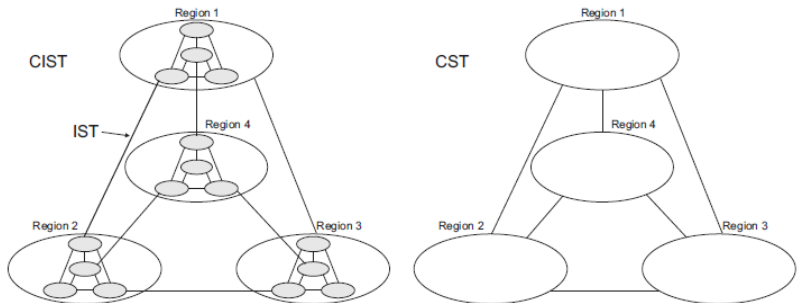

MSTP connects all bridges and LAN segments with a single Common and Internal Spanning Tree (CIST). The CIST is formed as a result of the running spanning tree algorithm between switches that support the STP, RSTP, MSTP protocols.

Once you specify the VLANs to include in a Multiple Spanning Tree Instance (MSTI), the protocol will automatically build an MSTI tree to maintain connectivity among each of the VLANs. MSTP maintains contact with the global network because each instance is treated as an RSTP node in the Common Spanning Tree (CST).

Loopback Detection

Use the Spanning Tree > Loopback Detection page to configure loopback detection on an interface. When loopback detection is enabled and a port or trunk receives its own BPDU, the detection agent drops the loopback BPDU, sends an SNMP trap, and places the interface in discarding mode. This loopback state can be released manually or automatically. If the interface is configured for automatic loopback release, then the port will only be returned to the forwarding state if one of the following conditions is satisfied:

- ◆ The interface receives any other BPDU except for its own, or;
- ◆ The interface link status changes to link down and then link up again, or;
- ◆ The interface ceases to receive its own BPDUs in a forward delay interval.

Note:

- ◆ If loopback detection is not enabled and an interface receives its own BPDU, then the interface will drop the loopback BPDU according to IEEE Standard 802.1w-2001 9.3.4 (Note 1).
- ◆ Loopback detection will not be active if Spanning Tree is disabled on the switch.
- ◆ When configured for manual release mode, then a link down/up event will not release the port from the discarding state.

Parameters

These parameters are displayed:

- ◆ **Interface** – Displays a list of ports or trunks.
- ◆ **Status** – Enables loopback detection on this interface. (Default: Disabled)
- ◆ **Trap** – Enables SNMP trap notification for loopback events on this interface. (Default: Disabled)
- ◆ **Release Mode** – Configures the interface for automatic or manual loopback release. (Default: Auto)
- ◆ **Release** – Allows an interface to be manually released from discard mode. This is only available if the interface is configured for manual release mode.
- ◆ **Action** – Sets the response for loopback detection to shut down the interface. (Default: Shutdown)

- ◆ **Shutdown Interval** – The duration to shut down the interface. (Range: 60-86400 seconds; Default: 60 seconds)

If an interface is shut down due to a detected loopback, and the release mode is set to “Auto,” the selected interface will be automatically enabled when the shutdown interval has expired.

If an interface is shut down due to a detected loopback, and the release mode is set to “Manual,” the interface can be re-enabled using the Release button.

Web Interface

To configure loopback detection:

1. Click **Spanning Tree > Loopback Detection**.
2. Click Port or Trunk to display the required interface type.
3. Modify the required loopback detection attributes.
4. Click **Apply**.

Spanning Tree > Loopback Detection ?

Interface Port Trunk

Loopback Detection Port List 1 2 3 Total: 23

Port	Status	Trap	Release Mode	Release	Action	Shutdown Interval (60-86400 sec)
1	<input type="checkbox"/> Enabled	<input type="checkbox"/> Enabled	Auto	Release	Shutdown	60
2	<input type="checkbox"/> Enabled	<input type="checkbox"/> Enabled	Auto	Release	Shutdown	60
3	<input type="checkbox"/> Enabled	<input type="checkbox"/> Enabled	Auto	Release	Shutdown	60
4	<input type="checkbox"/> Enabled	<input type="checkbox"/> Enabled	Auto	Release	Shutdown	60
5	<input type="checkbox"/> Enabled	<input type="checkbox"/> Enabled	Auto	Release	Shutdown	60
6	<input type="checkbox"/> Enabled	<input type="checkbox"/> Enabled	Auto	Release	Shutdown	60
7	<input type="checkbox"/> Enabled	<input type="checkbox"/> Enabled	Auto	Release	Shutdown	60
8	<input type="checkbox"/> Enabled	<input type="checkbox"/> Enabled	Auto	Release	Shutdown	60
9	<input type="checkbox"/> Enabled	<input type="checkbox"/> Enabled	Auto	Release	Shutdown	60
10	<input type="checkbox"/> Enabled	<input type="checkbox"/> Enabled	Auto	Release	Shutdown	60

Global Settings for STA

Use the Spanning Tree > STA (Configure Global - Configure) page to configure global settings for the spanning tree that apply to the entire switch.

Command Usage

- ◆ Spanning Tree Protocol⁵

This option uses RSTP set to STP forced compatibility mode. It uses RSTP for the internal state machine, but sends only 802.1D BPDUs. This creates one spanning tree instance for the entire network. If multiple VLANs are implemented on a network, the path between specific VLAN members may be inadvertently disabled to prevent network loops, thus isolating group members. When operating multiple VLANs, we recommend selecting the MSTP option.
- ◆ Rapid Spanning Tree Protocol⁵

RSTP supports connections to either STP or RSTP nodes by monitoring the incoming protocol messages and dynamically adjusting the type of protocol messages the RSTP node transmits, as described below:

 - ◆ STP Mode – If the switch receives an 802.1D BPDU (i.e., STP BPDU) after a port's migration delay timer expires, the switch assumes it is connected to an 802.1D bridge and starts using only 802.1D BPDUs.

Note: 5. STP and RSTP BPDUs are transmitted as untagged frames, and will cross any VLAN boundaries.

- ◆ RSTP Mode – If RSTP is using 802.1D BPDUs on a port and receives an RSTP BPDU after the migration delay expires, RSTP restarts the migration delay timer and begins using RSTP BPDUs on that port.
- ◆ Multiple Spanning Tree Protocol

MSTP generates a unique spanning tree for each instance. This provides multiple pathways across the network, thereby balancing the traffic load, preventing wide-scale disruption when a bridge node in a single instance fails, and allowing for faster convergence of a new topology for the failed instance.

 - ◆ To allow multiple spanning trees to operate over the network, you must configure a related set of bridges with the same MSTP configuration, allowing them to participate in a specific set of spanning tree instances.
 - ◆ A spanning tree instance can exist only on bridges that have compatible VLAN instance assignments.

- ♦ Be careful when switching between spanning tree modes. Changing modes stops all spanning-tree instances for the previous mode and restarts the system in the new mode, temporarily disrupting user traffic.

Parameters

These parameters are displayed:

Basic Configuration of Global Settings

- ♦ **Spanning Tree Status** – Enables/disables STA on this switch. (Default: Disabled)
- ♦ **Spanning Tree Type** – Specifies the type of spanning tree used on this switch:
 - ♦ **STP**: Spanning Tree Protocol (IEEE 802.1D); i.e., when this option is selected, the switch will use RSTP set to STP forced compatibility mode).
 - ♦ **RSTP**: Rapid Spanning Tree (IEEE 802.1w); RSTP is the default.
 - ♦ **MSTP**: Multiple Spanning Tree (IEEE 802.1s)
- ♦ **Priority** – Bridge priority is used in selecting the root device, root port, and designated port. The device with the highest priority becomes the STA root device. However, if all devices have the same priority, the device with the lowest MAC address will then become the root device. (Note that lower numeric values indicate higher priority.)
 - ♦ Default: 32768
 - ♦ Range: 0-61440, in steps of 4096
 - ♦ Options: 0, 4096, 8192, 12288, 16384, 20480, 24576, 28672, 32768, 36864, 40960, 45056, 49152, 53248, 57344, 61440
- ♦ **BPDU Flooding** – Configures how the system floods BPDUs to other ports when spanning tree is disabled globally on the switch or disabled on specific ports.
 - ♦ To VLAN: Floods BPDUs to all other spanning tree-disabled ports within the receiving port's native VLAN (i.e., as determined by port's PVID). This is the default.
 - ♦ To All: Floods BPDUs to all other spanning tree-disabled ports on the switch.

The setting has no effect if BPDU flooding is disabled on a port.
- ♦ **Cisco Prestandard Status** – Configures spanning tree operation to be compatible with Cisco prestandard versions. (Default: Disabled)

Cisco prestandard versions prior to Cisco IOS Release 12.2(25)SEC do not fully follow the IEEE standard, causing some state machine procedures to

function incorrectly. This command forces the spanning tree protocol to function in a manner compatible with Cisco prestandard versions.

Advanced Configuration Settings

The following attributes are based on RSTP, but also apply to STP since the switch uses a backwards-compatible subset of RSTP to implement STP, and also apply to MSTP which is based on RSTP according to the standard:

- ◆ **Path Cost Method** – The path cost is used to determine the best path between devices. The path cost method is used to determine the range of values that can be assigned to each interface.
 - ◆ Long: Specifies 32-bit based values that range from 1-200,000,000. (This is the default.)
 - ◆ Short: Specifies 16-bit based values that range from 1-65535.
- ◆ **Transmission Limit** – The maximum number of BPDU transmissions permitted within the Hello Time interval. (Range: 1-10; Default: 3)

When the Switch Becomes Root

- ◆ **Hello Time** – Interval (in seconds) at which the root device transmits a configuration message.
 - ◆ Default: 2
 - ◆ Minimum: 1
 - ◆ Maximum: The lower of 10 or $[(\text{Max. Message Age} / 2) - 1]$
- ◆ **Maximum Age** – The maximum time (in seconds) a device can wait without receiving a configuration message before attempting to reconverge. All device ports (except for designated ports) should receive configuration messages at regular intervals. Any port that ages out STA information (provided in the last configuration message) becomes the designated port for the attached LAN. If it is a root port, a new root port is selected from among the device ports attached to the network. (References to “ports” in this section mean “interfaces,” which includes both ports and trunks.)
 - ◆ Default: 20
 - ◆ Minimum: The higher of 6 or $[2 \times (\text{Hello Time} + 1)]$
 - ◆ Maximum: The lower of 40 or $[2 \times (\text{Forward Delay} - 1)]$
- ◆ **Forward Delay** – The maximum time (in seconds) this device will wait before changing states (i.e., discarding to learning to forwarding). This delay is required because every device must receive information about topology changes before it starts to forward frames. In addition, each port needs time to listen for conflicting information that would make it return to a discarding state; otherwise, temporary data loops might result.

- ◆ Default: 15
- ◆ Minimum: The higher of 4 or $[(\text{Max. Message Age} / 2) + 1]$
- ◆ Maximum: 30

RSTP does not depend on the forward delay timer in most cases. It is able to confirm that a port can transition to the forwarding state without having to rely on any timer configuration. To achieve fast convergence, RSTP relies on the use of edge ports, and automatic detection of point-to-point link types, both of which allow a port to directly transition to the forwarding state.

Configuration Settings for MSTP

- ◆ **Max Instance Numbers** – The maximum number of MSTP instances to which this switch can be assigned.
- ◆ **Configuration Digest** – An MD5 signature key that contains the VLAN ID to MST ID mapping table. In other words, this key is a mapping of all VLANs to the CIST.
- ◆ **Region Revision⁶** – The revision for this MSTI. (Range: 0-65535; Default: 0)
- ◆ **Region Name⁶** – The name for this MSTI. (Maximum length: 32 characters; Default: switch's MAC address)

Note: 6. The MST name and revision number are both required to uniquely identify an MST region.

- ◆ **Max Hop Count** – The maximum number of hops allowed in the MST region before a BPDU is discarded. (Range: 1-40; Default: 20)

Note: Region Revision and Region Name and are both required to uniquely identify an MST region.

Web Interface

To configure global STA settings:

1. Click **Spanning Tree > STA**.
2. Select **Configure Global** from the Step list.
3. Select **Configure** from the Action list.
4. Modify any of the required attributes. Note that the parameters displayed for the spanning tree types (STP, RSTP, MSTP) varies as described in the preceding section.

5. Click **Apply**.**Configuring Global Settings for STA (STP)**

Spanning Tree > STA

Step: 1. Configure Global Action: Configure

Spanning Tree Status Enabled

Spanning Tree Type

Priority (0-61440, in steps of 4096)

BPDU Flooding

Cisco Prestandard Status Enabled

Advanced:

Path Cost Method

Transmission Limit (1-10)

When the Switch Becomes Root:

Hello Time (1-10) sec

Maximum Age (6-40) sec

Forward Delay (4-30) sec

Note: $2 * (\text{Hello Time} + 1) \leq \text{Max Age} \leq 2 * (\text{Forward Delay} - 1)$

Configuring Global Settings for STA (RSTP)

Spanning Tree > STA

Step: 1. Configure Global Action: Configure

Spanning Tree Status Enabled

Spanning Tree Type

Priority (0-61440, in steps of 4096)

BPDU Flooding

Cisco Prestandard Status Enabled

Advanced:

Path Cost Method

Transmission Limit (1-10)

When the Switch Becomes Root:

Hello Time (1-10) sec

Maximum Age (6-40) sec

Forward Delay (4-30) sec

Note: $2 * (\text{Hello Time} + 1) \leq \text{Max Age} \leq 2 * (\text{Forward Delay} - 1)$

Configuring Global Settings for STA (MSTP)

Spanning Tree > STA

Step: 1. Configure Global Action: Configure

Spanning Tree Status Enabled

Spanning Tree Type

Priority (0-61440, in steps of 4096)

BPDU Flooding

Cisco Prestandard Status Enabled

Advanced:

Path Cost Method

Transmission Limit (1-10)

When the Switch Becomes Root

Hello Time (1-10) sec

Maximum Age (5-40) sec

Forward Delay (4-30) sec

Note: 2 * (Hello Time + 1) <= Max Age <= 2 * (Forward Delay - 1)

MSTP Configuration

Max Instance Numbers 64

Configuration Digest 0xAC36177F50283CD4B83821D6A826DE62

Region Revision (0-65535)

Region Name

Max Hop Count (1-40)

Displaying Global Settings for STA

Use the Spanning Tree > STA (Configure Global - Show Information) page to display a summary of the current bridge STA information that applies to the entire switch.

Parameters

The parameters displayed are described in the preceding section, except for the following items:

- ◆ **Bridge ID** – A unique identifier for this bridge, consisting of the bridge priority, the MST Instance ID 0 for the Common Spanning Tree when spanning tree type is set to MSTP, and MAC address (where the address is taken from the switch system).
- ◆ **Designated Root** – The priority and MAC address of the device in the Spanning Tree that this switch has accepted as the root device.
- ◆ **Root Port** – The number of the port on this switch that is closest to the root. This switch communicates with the root device through this port. If

there is no root port, then this switch has been accepted as the root device of the Spanning Tree network.

- ♦ **Root Path Cost** – The path cost from the root port on this switch to the root device.
- ♦ **Configuration Changes** – The number of times the Spanning Tree has been reconfigured.
- ♦ **Last Topology Change** – Time since the Spanning Tree was last reconfigured.

Web Interface

To display global STA settings:

1. Click **Spanning Tree > STA**.
2. Select Configure Global from the Step list.
3. Select Show Information from the Action list.

Spanning Tree > STA

Step: 1. Configure Global Action: Show Information

Spanning Tree Information

Spanning Tree Status	Enabled	Spanning Tree Type	RSTP
Designated Root	32768.0000E89382A0	Bridge ID	32768.0000E89382A0
Root Port	0	Max Age	20 sec
Root Path Cost	0	Hello Time	2 sec
Configuration Changes	2	Forward Delay	15 sec
Last Topology Change	0 days, 3 hours, 51 minutes, 11 seconds		

Interface Settings for STA

Use the Spanning Tree > STA (Configure Interface - Configure) page to configure RSTP and MSTP attributes for specific interfaces, including port priority, path cost, link type, and edge port. You may use a different priority or path cost for ports of the same media type to indicate the preferred path, link type to indicate a point-to-point connection or shared-media connection, and edge port to indicate if the attached device can support fast forwarding. (References to “ports” in this section means “interfaces,” which includes both ports and trunks.)

Parameters

These parameters are displayed:

- ◆ **Interface** – Displays a list of ports or trunks.
- ◆ **Spanning Tree** – Enables/disables STA on this interface. (Default: Enabled)
- ◆ **BPDU Flooding** - Enables/disables the flooding of BPDUs to other ports when global spanning tree is disabled or when spanning tree is disabled on a specific port. When flooding is enabled, BPDUs are flooded to all other spanning-tree disabled ports on the switch or to all other spanning-tree disabled ports within the receiving port’s native VLAN, as specified by the Spanning Tree BPDU Flooding attribute. (Default: Enabled)
- ◆ **Priority** – Defines the priority used for this port in the Spanning Tree Protocol. If the path cost for all ports on a switch are the same, the port with the highest priority (i.e., lowest value) will be configured as an active link in the Spanning Tree. This makes a port with higher priority less likely to be blocked if the Spanning Tree Protocol is detecting network loops. Where more than one port is assigned the highest priority, the port with lowest numeric identifier will be enabled.
 - ◆ Default: 128
 - ◆ Range: 0-240, in steps of 16
- ◆ **Admin Path Cost** – This parameter is used by the STA to determine the best path between devices. Therefore, lower values should be assigned to ports attached to faster media, and higher values assigned to ports with slower media. Note that path cost takes precedence over port priority. (Range: 0 for auto-configuration, 1-65535 for the short path cost method⁷, 1-200,000,000 for the long path cost method)

By default, the system automatically detects the speed and duplex mode used on each port, and configures the path cost according to the values

shown below. Path cost “0” is used to indicate auto-configuration mode. When the short path cost method is selected and the default path cost recommended by the IEEE 802.1w standard exceeds 65,535, the default is set to 65,535.

Recommended STA Path Cost Range

Port Type	IEEE 802.1D-1998	IEEE 802.1w-2001
Ethernet	50-600	200,000-20,000,000
Fast Ethernet	10-60	20,000-2,000,000
Gigabit Ethernet	3-10	2,000-200,000
10G Ethernet	1-5	200-20,000

Default STA Path Costs

Port Type	Short Path Cost (IEEE 802.1D-1998)	Long Path Cost (IEEE 802.1D-2004)
Ethernet	65,535	1,000,000
Fast Ethernet	65,535	100,000
Gigabit Ethernet	10,000	10,000
10G Ethernet	1,000	1,000

Administrative path cost cannot be used to directly determine the root port on a switch. Connections to other devices use IEEE 802.1Q-2005 to determine the root port as in the following example.

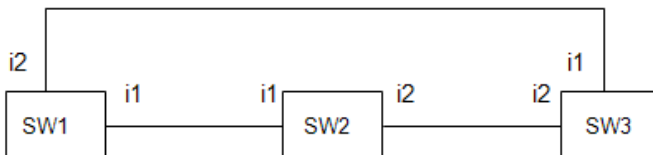

For BPDU messages received by i1 on SW3, the path cost is 0.

For BPDU messages received by i2 on SW3, the path cost is that of i1 on SW2.

Note: 7. Refer to Configuring Global Settings for STA for information on setting the path cost method. The range displayed on the STA interface configuration page shows the maximum value for path cost. However, note that the switch still enforces the rules for path cost based on the specified path cost method (long or short).

The root path cost for i1 on SW3 used to compete for the role of root port is 0 + path cost of i1 on SW3; 0 since i1 is directly connected to the root bridge.

If the path cost of i1 on SW2 is never configured/changed, it is 10000. Then the root path cost for i2 on SW3 used to compete for the role of root port is 10000 + path cost of i2 on SW3.

The path cost of i1 on SW3 is also 10000 if not configured/changed. Then even if the path cost of i2 on SW3 is configured/changed to 0, these ports will still have the same root path cost, and it will be impossible for i2 to become the root port just by changing its path cost on SW3.

For RSTP mode, the root port can be determined simply by adjusting the path cost of i1 on SW2. However, for MSTP mode, it is impossible to achieve this only by changing the path cost because external path cost is not added in the sameregion, and the regional root for i1 is SW1, but for i2 is SW2.

- ◆ **Admin Link Type** – The link type attached to this interface.
 - ◆ Point-to-Point – A connection to exactly one other bridge.
 - ◆ Shared – A connection to two or more bridges.
 - ◆ Auto – The switch automatically determines if the interface is attached to a point-to-point link or to shared media. (This is the default setting.)
- ◆ **Root Guard** – STA allows a bridge with a lower bridge identifier (or same identifier and lower MAC address) to take over as the root bridge at any time. Root Guard can be used to ensure that the root bridge is not formed at a suboptimal location. Root Guard should be enabled on any designated port connected to low-speed bridges which could potentially overload a slower link by taking over as the root port and forming a new spanning tree topology. It could also be used to form a border around part of the network where the root bridge is allowed. (Default: Disabled)
- ◆ **Admin Edge Port** – Since end nodes **cannot** cause forwarding loops, they can pass directly through to the spanning tree forwarding state. Specifying Edge Ports provides quicker convergence for devices such as workstations or servers, retains the current forwarding database to reduce the amount of frame flooding required to rebuild address tables during reconfiguration events, does not cause the spanning tree to initiate reconfiguration when the interface changes state, and also overcomes other STA-related timeout problems. However, remember that Edge Port should only be enabled for ports connected to an end-node device. (Default: Auto)
 - ◆ **Enabled** – Manually configures a port as an Edge Port.
 - ◆ **Disabled** – Disables the Edge Port setting.

- ♦ **Auto** – The port will be automatically configured as an edge port if the edge delay time expires without receiving any RSTP or MSTP BPDUs. Note that edge delay time (802.1D-2004 17.20.4) equals the protocol migration time if a port's link type is point-to-point (which is 3 seconds as defined in IEEE 802.3D-2004 17.20.4); otherwise it equals the spanning tree's maximum age for configuration messages (see maximum age under Configuring Global Settings for STA”).

An interface cannot function as an edge port under the following conditions:

- ♦ If spanning tree mode is set to STP, edge-port mode cannot automatically transition to operational edge-port state using the automatic setting.
- ♦ If loopback detection is enabled and a loopback BPDU is detected, the interface cannot function as an edge port until the loopback state is released.
- ♦ If an interface is in forwarding state and its role changes, the interface cannot continue to function as an edge port even if the edge delay time has expired.
- ♦ If the port does not receive any BPDUs after the edge delay timer expires, its role changes to designated port and it immediately enters forwarding state.

When edge port is set as auto, the operational state is determined automatically by the Bridge Detection State Machine described in 802.1D-2004, where the edge port state may change dynamically based on environment changes (e.g., receiving a BPDU or not within the required interval).

- ♦ **BPDU Guard** – This feature protects edge ports from receiving BPDUs. It prevents loops by shutting down an edge port when a BPDU is received instead of putting it into the spanning tree discarding state. In a valid configuration, configured edge ports should not receive BPDUs. If an edge port receives a BPDU an invalid configuration exists, such as a connection to an unauthorized device. The BPDU guard feature provides a secure response to invalid configurations because an administrator must manually enable the port. (Default: Disabled)

BPDU guard can only be configured on an interface if the edge port attribute is not disabled (that is, if edge port is set to enabled or auto).

- ♦ **BPDU Guard Auto Recovery** – Automatically re-enables an interface after the specified interval. (Default: Disabled)
- ♦ **BPDU Guard Auto Recovery Interval** – The time to wait before re-enabling an interface. (Range: 30-86400 seconds; Default: 300 seconds)

- ♦ **BPDU Filter** – BPDU filtering allows you to avoid transmitting BPDUs on configured edge ports that are connected to end nodes. By default, STA sends BPDUs to all ports regardless of whether administrative edge is enabled on a port. BPDU filtering is configured on a per-port basis. (Default: Disabled)
BPDU filter can only be configured on an interface if the edge port attribute is not disabled (that is, if edge port is set to enabled or auto).
- ♦ **Migration** – If at any time the switch detects STP BPDUs, including Configuration or Topology Change Notification BPDUs, it will automatically set the selected interface to forced STP-compatible mode. However, you can also use the Protocol Migration button to manually re-check the appropriate BPDU format (RSTP or STP-compatible) to send on the selected interfaces. (Default: Disabled)
- ♦ **TC Propagate Stop** – Stops the propagation of topology change notifications (TCN for STP) and topology change messages (TC for RSTP/MSTP). (Default: Disabled)

Web Interface

To configure interface settings for STA:

1. Click **Spanning Tree > STA**.
2. Select Configure Interface from the Step list.
3. Select Configure from the Action list.
4. Modify any of the required attributes.
5. Click **Apply**.

The screenshot shows the 'Spanning Tree > STA' configuration page. At the top, there is a 'Step:' dropdown set to 'Configure Interface' and an 'Action:' dropdown set to 'Configure'. Below this, there are radio buttons for 'Interface' (selected) and 'Trunk'. A 'Port List' section shows a table with 28 ports. The table has columns for Port, Spanning Tree, BPDU Flooding, Priority, Admin Path Cost, Admin Link Type, Root Guard, Admin Edge Port, BPDU Guard, BPDU Guard Auto Recovery, BPDU Guard Auto Recovery Interval, SPU Filter, Migration, TC Propagate Stop, and Restricted TCN. All 'Spanning Tree' and 'BPDU Flooding' checkboxes are checked. The 'Migration' checkbox for port 1 is checked, while others are unchecked. The 'Restricted TCN' column has checkboxes for each port, all of which are unchecked.

Port	Spanning Tree	BPDU Flooding	Priority (0-240, in steps of 16)	Admin Path Cost (0-20000000, 0: Auto)	Admin Link Type	Root Guard	Admin Edge Port	BPDU Guard	BPDU Guard Auto Recovery	BPDU Guard Auto Recovery Interval (30-65400)	SPU Filter	Migration	TC Propagate Stop	Restricted TCN
1	<input checked="" type="checkbox"/> Enabled	<input checked="" type="checkbox"/> Enabled	128	0	Auto	<input type="checkbox"/> Enabled	Auto	<input type="checkbox"/> Enabled	<input type="checkbox"/> Enabled	300	<input type="checkbox"/> Enabled	<input checked="" type="checkbox"/> Enabled	<input type="checkbox"/> Enabled	<input type="checkbox"/> Enabled
2	<input checked="" type="checkbox"/> Enabled	<input checked="" type="checkbox"/> Enabled	128	0	Auto	<input type="checkbox"/> Enabled	Auto	<input type="checkbox"/> Enabled	<input type="checkbox"/> Enabled	300	<input type="checkbox"/> Enabled	<input type="checkbox"/> Enabled	<input type="checkbox"/> Enabled	<input type="checkbox"/> Enabled
3	<input checked="" type="checkbox"/> Enabled	<input checked="" type="checkbox"/> Enabled	128	0	Auto	<input type="checkbox"/> Enabled	Auto	<input type="checkbox"/> Enabled	<input type="checkbox"/> Enabled	300	<input type="checkbox"/> Enabled	<input type="checkbox"/> Enabled	<input type="checkbox"/> Enabled	<input type="checkbox"/> Enabled
4	<input checked="" type="checkbox"/> Enabled	<input checked="" type="checkbox"/> Enabled	128	0	Auto	<input type="checkbox"/> Enabled	Auto	<input type="checkbox"/> Enabled	<input type="checkbox"/> Enabled	300	<input type="checkbox"/> Enabled	<input type="checkbox"/> Enabled	<input type="checkbox"/> Enabled	<input type="checkbox"/> Enabled

Displaying Interface Settings for STA

Use the Spanning Tree > STA (Configure Interface - Show Information) page to display the current status of ports or trunks in the Spanning Tree.

Parameters

These parameters are displayed:

- ◆ **Spanning Tree** – Shows if STA has been enabled on this interface.
- ◆ **BPDU Flooding** – Shows if BPDUs will be flooded to other ports when spanning tree is disabled globally on the switch or disabled on a specific port.
- ◆ **STA Status** – Displays current state of this port within the Spanning Tree:
 - ◆ **Discarding** - Port receives STA configuration messages, but does not forward packets.
 - ◆ **Learning** - Port has transmitted configuration messages for an interval set by the Forward Delay parameter without receiving contradictory information. Port address table is cleared, and the port begins learning addresses.
 - ◆ **Forwarding** - Port forwards packets, and continues learning addresses.

The rules defining port status are:

- ◆ A port on a network segment with no other STA compliant bridging device is always forwarding.
- ◆ If two ports of a switch are connected to the same segment and there is no other STA device attached to this segment, the port with the smaller ID forwards packets and the other is discarding.
- ◆ All ports are discarding when the switch is booted, then some of them change state to learning, and then to forwarding.
- ◆ **Forward Transitions** – The number of times this port has transitioned from the Learning state to the Forwarding state.
- ◆ **Designated Cost** – The cost for a packet to travel from this port to the root in the current Spanning Tree configuration. The slower the media, the higher the cost.
- ◆ **Designated Bridge** – The bridge priority and MAC address of the device through which this port must communicate to reach the root of the Spanning Tree.
- ◆ **Designated Port** – The port priority and number of the port on the designated bridging device through which this switch must communicate with the root of the Spanning Tree.

- ◆ **Oper Path Cost** – The contribution of this port to the path cost of paths towards the spanning tree root which include this port.
- ◆ **Oper Link Type** – The operational point-to-point status of the LAN segment attached to this interface. This parameter is determined by manual configuration or by auto-detection, as described for Admin Link Type in STA Port Configuration.
- ◆ **Oper Edge Port** – This parameter is initialized to the setting for Admin Edge Port in STA Port Configuration (i.e., true or false), but will be set to false if a BPDU is received, indicating that another bridge is attached to this port.
- ◆ **Port Role** – Roles are assigned according to whether the port is part of the active topology, that is the best port connecting a non-root bridge to the root bridge (i.e., **root port**), connecting a LAN through the bridge to the root bridge (i.e., **designated port**), is the MSTI regional root (i.e., **master port**), or is an **alternate** or **backup** port that may provide connectivity if other bridges, bridge ports, or LANs fail or are removed. The role is set to disabled (i.e., **disabled port**) if a port has no role within the spanning tree.

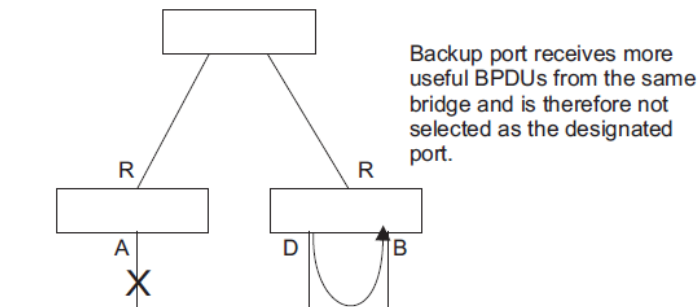
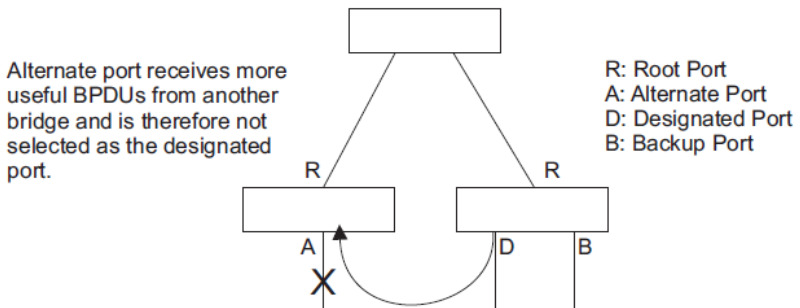

The criteria used for determining the port role is based on root bridge ID, root path cost, designated bridge, designated port, port priority, and port number, in that order and as applicable to the role under question.

Web Interface

To display interface settings for STA:

1. Click **Spanning Tree > STA**.
2. Select Configure Interface from the Step list.
3. Select Show Information from the Action list.

Spanning Tree > STA

Step: Action:

Interface Port Trunk

Spanning Tree Port List Total: 28 1 2 3

Port	Spanning Tree	BPDU Flooding	STA Status	Forward Transitions	Designated Cost	Designated Bridge	Designated Pprt	Oper Path Cost	Oper Link Type	Oper Edge Port	Port Role
1	Enabled	Enabled	Forwarding	1	0	32768.E49D731B5E00	128.1	10000	Point-to-Point	Disabled	Disabled
2	Enabled	Enabled	Discarding	0	0	32768.E49D731B5E00	128.2	10000	Point-to-Point	Disabled	Disabled
3	Enabled	Enabled	Discarding	0	0	32768.E49D731B5E00	128.3	10000	Point-to-Point	Disabled	Disabled
4	Enabled	Enabled	Discarding	0	0	32768.E49D731B5E00	128.4	10000	Point-to-Point	Disabled	Disabled

Global Settings for MSTP

Use the Spanning Tree > MSTP (Configure Global) page to create an MSTP instance, or to add VLAN groups to an MSTP instance.

Command Usage

MSTP generates a unique spanning tree for each instance. This provides multiple pathways across the network, thereby balancing the traffic load, preventing wide-scale disruption when a bridge node in a single instance fails, and allowing for faster convergence of a new topology for the failed instance.

By default all VLANs are assigned to the Internal Spanning Tree (MST Instance 0) that connects all bridges and LANs within the MST region. This switch supports up to 33 instances. You should try to group VLANs which cover the same general area of your network. However, remember that you must configure all bridges within the same MSTI Region with the same set of instances, and the same instance (on each bridge) with the same set of VLANs. Also, note that RSTP treats each MSTI region as a single node, connecting all regions to the Common Spanning Tree.

To use multiple spanning trees:

1. Set the spanning tree type to MSTP.
2. Enter the spanning tree priority for the selected MST instance on the Spanning Tree > MSTP (Configure Global - Add) page.
3. Add the VLANs that will share this MSTI on the Spanning Tree > MSTP (Configure Global - Add Member) page.

Note: All VLANs are automatically added to the IST (Instance 0).

To ensure that the MSTI maintains connectivity across the network, you must configure a related set of bridges with the same MSTI settings.

Parameters

These parameters are displayed:

- ◆ **MST ID** – Instance identifier to configure. (Range: 0-4094)
- ◆ **VLAN ID** – VLAN to assign to this MST instance. (Range: 1-4094)
- ◆ **Priority** – The priority of a spanning tree instance. (Range: 0-61440 in steps of 4096; Options: 0, 4096, 8192, 12288, 16384, 20480, 24576, 28672, 32768, 36864, 40960, 45056, 49152, 53248, 57344, 61440; Default: 32768)

Web Interface

To create instances for MSTP:

1. Click **Spanning Tree > MSTP**.
2. Select Configure Global from the Step list.
3. Select Add from the Action list.
4. Specify the MST instance identifier and the initial VLAN member. Additional member can be added using the Spanning Tree > MSTP (Configure Global - Add Member) page. If the priority is not specified, the default value 32768 is used.
5. Click **Apply**.

Spanning Tree > MSTP

Step: 1. Configure Global Action: Add

MST ID (0-4094)

VLAN ID (1-4094)

Priority (0-61440, in steps of 4096)

Apply Revert

To show the MSTP instances:

1. Click **Spanning Tree > MSTP**.
2. Select Configure Global from the Step list.
3. Select Show from the Action list.

Spanning Tree > MSTP

Step: 1. Configure Global Action: Show

MST List Total: 2

<input type="checkbox"/>	MST ID
<input type="checkbox"/>	0
<input type="checkbox"/>	1

Delete Revert

To modify the priority for an MST instance:

1. Click **Spanning Tree > MSTP**.
2. Select Configure Global from the Step list.
3. Select Modify from the Action list.
4. Modify the priority for an MSTP Instance.

5. Click **Apply**.

Spanning Tree > MSTP

Step: 1. Configure Global Action: Modify

MST Details List Total: 2

MST ID	Priority (0-61440, in steps of 4096)
0	0
1	32768

Apply Revert

To display global settings for MSTP:

1. Click **Spanning Tree > MSTP**.
2. Select Configure Global from the Step list.
3. Select Show Information from the Action list.
4. Select an MST ID. The attributes displayed on this page are described under Displaying Global Settings for STA.

Spanning Tree > MSTP

Step: 1. Configure Global Action: Show Information

MST ID: 1

Priority	0	Designated Root	32768.0030F1245660
Bridge ID	20	Root Port	2
Max Age	15 sec	Root Path Cost	32768.000001010010
Hello Time	23 sec	Configuration Changes	500000
Forward Delay	2 sec	Last Topology Change	0 days, 1 hours, 10 minutes, 0 seconds

To add additional VLAN groups to an MSTP instance:

1. Click **Spanning Tree > MSTP**.
2. Select Configure Global from the Step list.
3. Select Add Member from the Action list.
4. Select an MST instance from the MST ID list.
5. Enter the VLAN group to add to the instance in the VLAN ID field. Note that the specified member does not have to be a configured VLAN.
6. Click **Apply**.

Spanning Tree > MSTP

Step: 1. Configure Global Action: Add Member

MST ID 1

VLAN ID (1-4094) 1

Apply Revert

To show the VLAN members of an MSTP instance:

1. Click **Spanning Tree > MSTP**.
2. Select Configure Global from the Step list.
3. Select Show Member from the Action list.

Spanning Tree > MSTP

Step: 1. Configure Global Action: Show Member

MST ID 0

Member List Total: 4094

	VLAN
<input type="checkbox"/>	1
<input type="checkbox"/>	2
<input type="checkbox"/>	3
<input type="checkbox"/>	4
<input type="checkbox"/>	5

Interface Settings for MSTP

Use the Spanning Tree > MSTP (Configure Interface - Configure) page to configure the STA interface settings for an MST instance.

Parameters

These parameters are displayed:

- ◆ **MST ID** – Instance identifier to configure. (Default: 0)
- ◆ **Interface** – Displays a list of ports or trunks.
- ◆ **STA Status** – Displays the current state of this interface within the Spanning Tree. (See Displaying Interface Settings for STA for additional information.)
 - ◆ **Discarding** – Port receives STA configuration messages, but does not forward packets.
 - ◆ **Learning** – Port has transmitted configuration messages for an interval set by the Forward Delay parameter without receiving contradictory information. Port address table is cleared, and the port begins learning addresses.
 - ◆ **Forwarding** – Port forwards packets, and continues learning addresses.
- ◆ **Priority** – Defines the priority used for this port in the Spanning Tree Protocol. If the path cost for all ports on a switch are the same, the port with the highest priority (i.e., lowest value) will be configured as an active link in the Spanning Tree. This makes a port with higher priority less likely to be blocked if the Spanning Tree Protocol is detecting network loops. Where more than one port is assigned the highest priority, the port with lowest numeric identifier will be enabled. (Default: 128; Range: 0-240, in steps of 16)
- ◆ **Admin MST Path Cost** – This parameter is used by the MSTP to determine the best path between devices. Therefore, lower values should be assigned to ports attached to faster media, and higher values assigned to ports with slower media. (Path cost takes precedence over port priority.) Note that when the Path Cost Method is set to short, the maximum path cost is 65,535.

By default, the system automatically detects the speed and duplex mode used on each port, and configures the path cost according to the values shown below. Path cost “0” is used to indicate auto-configuration mode. When the short path cost method is selected and the default path cost

recommended by the IEEE 8021w standard exceeds 65,535, the default is set to 65,535.

Web Interface

To configure MSTP parameters for a port or trunk:

1. Click **Spanning Tree > MSTP**.
2. Select Configure Interface from the Step list.
3. Select Configure from the Action list.
4. Enter the priority and path cost for an interface.
5. Click **Apply**.

Spanning Tree > MSTP

Step: 2. Configure Interface Action: Configure

MST ID: 0

Interface: Port Trunk

Spanning Tree Port List Total: 28

Port	STA Status	Priority (0-240, in steps of 16)	Admin MST Path Cost (0-20000000, 0: Auto)
1	Forwarding	128	0
2	Discarding	128	0
3	Discarding	128	0
4	Discarding	128	0

To display MSTP parameters for a port or trunk:

1. Click **Spanning Tree > MSTP**.
2. Select Configure Interface from the Step list.
3. Select Show Information from the Action list.

Spanning Tree > MSTP

Step: 2. Configure Interface Action: Show Information

MST ID: 0

Interface: Port Trunk

Spanning Tree Port List Total: 28

Port	STA Status	Forward Transitions	Designated Cost	Designated Bridge	Designated Port	Oper Path Cost	Oper Link Type	Oper Edge Port	Port Role
1	Forwarding	1	0	32768.E49D731B5E00	128.1	10000	Point-to-Point	Disabled	Disabled
2	Discarding	0	0	32768.E49D731B5E00	128.2	10000	Point-to-Point	Disabled	Disabled
3	Discarding	0	0	32768.E49D731B5E00	128.3	10000	Point-to-Point	Disabled	Disabled
4	Discarding	0	0	32768.E49D731B5E00	128.4	10000	Point-to-Point	Disabled	Disabled

Chapter 10

Congestion Control

Overview

The switch can set the maximum upload or download data transfer rate for any port. It can also control traffic storms by setting a maximum threshold for broadcast traffic or multicast traffic. It can also set bounding thresholds for broadcast and multicast storms which can be used to automatically trigger rate limits or to shut down a port.

Congestion Control includes following options:

- ◆ *Rate Limiting* – Sets the input and output rate limits for a port.
- ◆ *Storm Control* – Sets the traffic storm threshold for each interface.
- ◆ *Automatic Traffic Control* – Sets thresholds for broadcast and multicast storms which can be used to trigger configured rate limits or to shut down a port.

Rate Limiting

Use the Traffic > Rate Limit page to apply rate limiting to ingress or egress ports. This function allows the network manager to control the maximum rate for traffic received or transmitted on an interface. Rate limiting is configured on interfaces at the edge of a network to limit traffic into or out of the network. Packets that exceed the acceptable amount of traffic are dropped.

Rate limiting can be applied to individual ports or trunks. When an interface is configured with this feature, the traffic rate will be monitored by the hardware to verify conformity. Non-conforming traffic is dropped, conforming traffic is forwarded without any changes.

Parameters

These parameters are displayed:

- ◆ **Interface** – Displays the switch’s ports or trunks.
- ◆ **Type** – Indicates the port type. (1000BASE-T, 10GBASE SFP+)
- ◆ **Status** – Enables or disables the rate limit. (Default: Disabled)
- ◆ **Rate** – Sets the rate limit level. (Range: 64 - 1,000,000 kbits per second for Gigabit Ethernet ports; 64 - 10,000,000 kbits per second for 10 Gigabit Ethernet ports)
- ◆ **Resolution** – Indicates the resolution at which the rate can be configured.

Web Interface

To configure rate limits:

1. Click **Traffic > Rate Limit**.
2. Set the interface type to Port or Trunk.
3. Enable the Rate Limit Status for the required interface.
4. Set the rate limit for required interfaces.
5. Click **Apply**.

The screenshot shows the 'Traffic > Rate Limit' configuration page. At the top, there is a breadcrumb 'Traffic > Rate Limit' and a green help icon. Below that, the 'Interface' section has radio buttons for 'Port' (selected) and 'Trunk'. Underneath, it says 'Port Rate Limit List Total: 28' with three numbered tabs (1, 2, 3). The main part of the page is a table with columns for 'Port', 'Type', 'Input', and 'Output'. Each of these columns is further divided into 'Status' and 'Rate (kbits/sec)'. The 'Rate' columns have input fields with the value '1000000'. The 'Status' columns have checkboxes, all of which are currently unchecked.

Port	Type	Input		Output	
		Status	Rate (kbits/sec) (64-10000000)	Status	Rate (kbits/sec) (64-10000000)
1	1000BASE-T	<input type="checkbox"/> Enabled	<input type="text" value="1000000"/>	<input type="checkbox"/> Enabled	<input type="text" value="1000000"/>
2	1000BASE-T	<input type="checkbox"/> Enabled	<input type="text" value="1000000"/>	<input type="checkbox"/> Enabled	<input type="text" value="1000000"/>
3	1000BASE-T	<input type="checkbox"/> Enabled	<input type="text" value="1000000"/>	<input type="checkbox"/> Enabled	<input type="text" value="1000000"/>
4	1000BASE-T	<input type="checkbox"/> Enabled	<input type="text" value="1000000"/>	<input type="checkbox"/> Enabled	<input type="text" value="1000000"/>
5	1000BASE-T	<input type="checkbox"/> Enabled	<input type="text" value="1000000"/>	<input type="checkbox"/> Enabled	<input type="text" value="1000000"/>

Storm Control

Use the Traffic > Storm Control page to configure broadcast, multicast, and unknown unicast storm control thresholds. Traffic storms may occur when a device on your network is malfunctioning, or if application programs are not well designed or properly configured. If there is too much traffic on your network, performance can be severely degraded or everything can come to complete halt.

You can protect your network from traffic storms by setting a threshold for broadcast, multicast or unknown unicast traffic. Any packets exceeding the specified threshold will then be dropped.

Command Usage

- ◆ Broadcast Storm Control is enabled by default.
- ◆ When traffic exceeds the threshold specified for broadcast and multicast or unknown unicast traffic, packets exceeding the threshold are dropped until the rate falls back down beneath the threshold.
- ◆ Rate limits set by the storm control function are also used by automatic storm control when the control response is set to rate control on the Auto Traffic Control (Configure Interface) page.
- ◆ Using both rate limiting and storm control on the same interface may lead to unexpected results. It is therefore not advisable to use both of these features on the same interface.

Parameters

These parameters are displayed:

- ◆ **Interface** – Displays a list of ports or trunks.
- ◆ **Type** – Indicates the port type. (1000BASE-T, 10GBASE SFP+)
- ◆ **Unknown Unicast** – Specifies storm control for unknown unicast traffic.
- ◆ **Multicast** – Specifies storm control for multicast traffic.
- ◆ **Broadcast** – Specifies storm control for broadcast traffic.
- ◆ **Status** – Enables or disables storm control. (Default: disabled for broadcast, multicast and unknown unicast storm control)
- ◆ **Rate** – Threshold level in packets per second. (Range: 500-14881000 pps; Default: Disabled for unknown unicast and multicast traffic, 500 pps for broadcast traffic)
- ◆ **Resolution** – Indicates the resolution at which the rate can be configured.

Web Interface

To configure broadcast storm control:

1. Click **Traffic > Storm Control**.
2. Set the interface type to Port or Trunk.
3. Set the Status field to enable or disable storm control.
4. Set the required threshold beyond which the switch will start dropping packets.
5. Click **Apply**.

Traffic > Storm Control

Interface Port Trunk

Port Storm Control List Total: 23 1 2 3

Port	Type	Unknown Unicast		Multicast		Broadcast	
		Status	Rate (packets/sec) (500-14681000)	Status	Rate (packets/sec) (500-14681000)	Status	Rate (packets/sec) (500-14681000)
1	1000BASE-T	<input type="checkbox"/> Enabled	500	<input type="checkbox"/> Enabled	500	<input type="checkbox"/> Enabled	500
2	1000BASE-T	<input type="checkbox"/> Enabled	500	<input type="checkbox"/> Enabled	500	<input type="checkbox"/> Enabled	500
3	1000BASE-T	<input type="checkbox"/> Enabled	500	<input type="checkbox"/> Enabled	500	<input type="checkbox"/> Enabled	500
4	1000BASE-T	<input type="checkbox"/> Enabled	500	<input type="checkbox"/> Enabled	500	<input type="checkbox"/> Enabled	500
5	1000BASE-T	<input type="checkbox"/> Enabled	500	<input type="checkbox"/> Enabled	500	<input type="checkbox"/> Enabled	500

Automatic Traffic Control

Use the Traffic > Auto Traffic Control pages to configure bounding thresholds for broadcast and multicast storms which can automatically trigger rate limits or shut down a port.

Command Usage

ATC includes storm control for broadcast or multicast traffic. The control response for either of these traffic types is the same, as shown in the following diagrams.

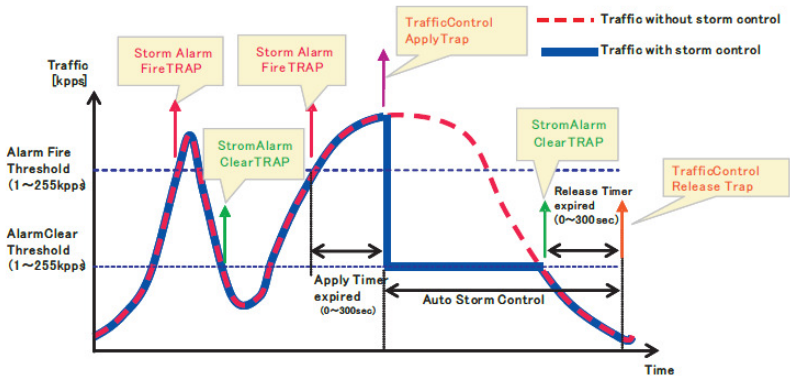

The key elements of this diagram are described below:

- ◆ Alarm Fire Threshold – The highest acceptable traffic rate. When ingress traffic exceeds the threshold, ATC sends a Storm Alarm Fire Trap and logs it.
- ◆ When traffic exceeds the alarm fire threshold and the apply timer expires, a traffic control response is applied, and a Traffic Control Apply Trap is sent and logged.
- ◆ Alarm Clear Threshold – The lower threshold beneath which a control response can be automatically terminated after the release timer expires. When ingress traffic falls below this threshold, ATC sends a Storm Alarm Clear Trap and logs it.
- ◆ When traffic falls below the alarm clear threshold after the release timer expires, traffic control (for rate limiting) will be stopped and a Traffic Control Release Trap sent and logged. Note that if the control action has shut down a port, it can only be manually re-enabled using Manual Control Release (see [page 237](#)).

- ♦ The traffic control response of rate limiting can be released automatically or manually. The control response of shutting down a port can only be released manually.

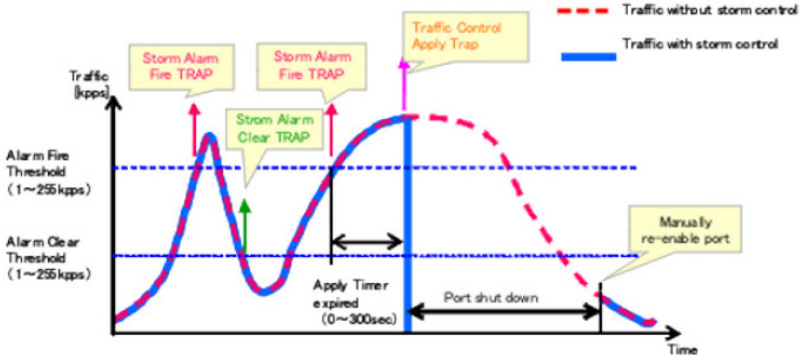

The key elements of this diagram are the same as that described in the preceding diagram, except that automatic release of the control response is not provided. When traffic control is applied, you must manually re-enable the port.

Functional Limitations

Automatic storm control is a software level control function. Traffic storms can also be controlled at the hardware level using Port Broadcast Control or Port Multicast Control. However, only one of these control types can be applied to a port. Enabling automatic storm control on a port will disable hardware-level storm control on that port.

Setting the ATC Timers

Use the Traffic > Auto Traffic Control (Configure Global) page to set the time at which to apply the control response after ingress traffic has exceeded the upper threshold, and the time at which to release the control response after ingress traffic has fallen beneath the lower threshold.

Command Usage

- ♦ After the apply timer expires, the settings in the Traffic > Automatic Traffic Control (Configure Interface) page are used to determine if a control action will be triggered (as configured under the Action field) or a trap message sent (as configured under the Trap Storm Fire field).
- ♦ The release timer only applies to a Rate Control response set in the Action field of the ATC (Interface Configuration) page. When a port has been shut

down by a control response, it must be manually re-enabled using the Manual Control Release.

Parameters

These parameters are displayed:

- ◆ **Broadcast Apply Timer** – The interval after the upper threshold has been exceeded at which to apply the control response to broadcast storms. (Range: 1-300 seconds; Default: 300 seconds)
- ◆ **Broadcast Release Timer** – The time at which to release the control response after ingress traffic has fallen beneath the lower threshold for broadcast storms. (Range: 1-900 seconds; Default: 900 seconds)
- ◆ **Multicast Apply Timer** – The interval after the upper threshold has been exceeded at which to apply the control response to multicast storms. (Range: 1-300 seconds; Default: 300 seconds)
- ◆ **Multicast Release Timer** – The time at which to release the control response after ingress traffic has fallen beneath the lower threshold for multicast storms. (Range: 1-900 seconds; Default: 900 seconds)

Web Interface

To configure the response timers for automatic storm control:

1. Click **Traffic > Auto Traffic Control**.
2. Select Configure Global from the Step field.
3. Set the apply and release timers for broadcast and multicast storms.
4. Click **Apply**.

Traffic > Auto Traffic Control

Step: 1. Configure Global ▼

Broadcast Apply Timer (5-300)	<input style="width: 60px;" type="text" value="300"/> sec
Broadcast Release Timer (5-900)	<input style="width: 60px;" type="text" value="900"/> sec
Multicast Apply Timer (5-300)	<input style="width: 60px;" type="text" value="300"/> sec
Multicast Release Timer (5-900)	<input style="width: 60px;" type="text" value="900"/> sec

Configuring ATC Threshold and Responses

Use the Traffic > Auto Traffic Control (Configure Interface) page to set the storm control mode (broadcast or multicast), the traffic thresholds, the control response, to automatically release a response of rate limiting, or to send related SNMP trap messages.

Parameters

These parameters are displayed:

- ◆ **Storm Control** – Specifies automatic storm control for broadcast traffic or multicast traffic.
- ◆ **Port** – Port identifier.
- ◆ **State** – Enables automatic traffic control for broadcast or multicast storms. (Default: Disabled)

Automatic storm control is a software level control function. Traffic storms can also be controlled at the hardware level using the Storm Control menu. However, only one of these control types can be applied to a port. Enabling automatic storm control on a port will disable hardware-level storm control on that port.

- ◆ **Action** – When the Alarm Fire Threshold (upper threshold) is exceeded and the apply timer expires, one of the following control responses will be triggered.
 - ◆ **Rate Control** – The rate of ingress traffic is limited to the level set by the Alarm Clear Threshold. Rate limiting is discontinued only after the traffic rate has fallen beneath the Alarm Clear Threshold (lower threshold), and the release timer has expired. (This is the default response.)
 - ◆ **Shutdown** – The port is administratively disabled. A port disabled by automatic traffic control can only be manually re-enabled using the Manual Control Release attribute.
- ◆ **Auto Release Control** – Automatically stops a traffic control response of rate limiting when traffic falls below the alarm clear threshold and the release timer expires as illustrated. When traffic control stops, the event is logged by the system and a Traffic Release Trap can be sent. (Default: Disabled)

If automatic control release is not enabled and a control response of rate limiting has been triggered, you can manually stop the rate limiting response using the Manual Control Release attribute. If the control response has shut down a port, it can also be re-enabled using Manual Control Release.

- ◆ **Alarm Fire Threshold** – The upper threshold for ingress traffic beyond which a storm control response is triggered after the Apply Timer expires. (Range: 1-255 kilo-packets per second; Default: 128 kpps)

Once the traffic rate exceeds the upper threshold and the Apply Timer expires, a trap message will be sent if configured by the Trap Storm Fire attribute.

- ◆ **Alarm Clear Threshold** – The lower threshold for ingress traffic beneath which a control response for rate limiting will be released after the Release Timer expires, if so configured by the Auto Release Control attribute. (Range: 1-255 kilo-packets per second; Default: 128 kpps)

If rate limiting has been configured as a control response and Auto Control Release is enabled, rate limiting will be discontinued after the traffic rate has fallen beneath the lower threshold, and the Release Timer has expired. Note that if a port has been shut down by a control response, it will not be re-enabled by automatic traffic control. It can only be manually re-enabled using Manual Control Release.

Once the traffic rate falls beneath the lower threshold and the Release Timer expires, a trap message will be sent if configured by the Trap Storm Clear attribute.

- ◆ **Trap Storm Fire** – Sends a trap when traffic exceeds the upper threshold for automatic storm control. (Default: Disabled)
- ◆ **Trap Storm Clear** – Sends a trap when traffic falls beneath the lower threshold after a storm control response has been triggered. (Default: Disabled)
- ◆ **Trap Traffic Apply** – Sends a trap when traffic exceeds the upper threshold for automatic storm control and the apply timer expires. (Default: Disabled)
- ◆ **Trap Traffic Release** – Sends a trap when traffic falls beneath the lower threshold after a storm control response has been triggered and the release timer expires. (Default: Disabled)
- ◆ **Manual Control Release** – Manually releases a control response of rate-limiting or port shutdown any time after the specified action has been triggered.

Web Interface

To configure the response timers for automatic storm control:

1. Click **Traffic > Auto Traffic Control**.
2. Select Configure Interface from the Step field.

3. Enable or disable ATC as required, set the control response, specify whether or not to automatically release the control response of rate limiting, set the upper and lower thresholds, and specify which trap messages to send.
4. Click **Apply**.

Traffic > Auto Traffic Control

Step: 2. Configure Interface

Storm Control Broadcast Multicast

Auto Traffic Control Broadcast List Total: 28

Port	State	Action	Auto Release Control	Alarm Fire Threshold (kpps) (1-255)	Alarm Clear Threshold (kpps) (1-255)	Trap Storm Fire	Trap Storm Clear	Trap Traffic Apply	Trap Traffic Release	Manual Control Release
1	<input type="checkbox"/> Enabled	Rate Control	<input type="checkbox"/> Enabled	128	128	<input type="checkbox"/> Enabled	<input type="checkbox"/> Enabled	<input type="checkbox"/> Enabled	<input type="checkbox"/> Enabled	Release
2	<input type="checkbox"/> Enabled	Rate Control	<input type="checkbox"/> Enabled	128	128	<input type="checkbox"/> Enabled	<input type="checkbox"/> Enabled	<input type="checkbox"/> Enabled	<input type="checkbox"/> Enabled	Release
3	<input checked="" type="checkbox"/> Enabled	Rate Control	<input type="checkbox"/> Enabled	128	128	<input checked="" type="checkbox"/> Enabled	<input type="checkbox"/> Enabled	<input type="checkbox"/> Enabled	<input type="checkbox"/> Enabled	Release
4	<input type="checkbox"/> Enabled	Rate Control	<input type="checkbox"/> Enabled	128	128	<input type="checkbox"/> Enabled	<input type="checkbox"/> Enabled	<input type="checkbox"/> Enabled	<input type="checkbox"/> Enabled	Release

Chapter 11

Class of Service

Overview

Class of Service (CoS) allows you to specify which data packets have greater precedence when traffic is buffered in the switch due to congestion. This switch supports CoS with eight priority queues for each port. Data packets in a port's high-priority queue will be transmitted before those in the lower-priority queues. You can set the default priority for each interface, and configure the mapping of frame priority tags to the switch's priority queues.

This chapter describes the following basic topics:

- ◆ *Layer 2 Queue Settings* – Configures each queue, including the default priority, queue mode, queue weight, and mapping of packets to queues based on CoS tags.
- ◆ *Layer 3/4 Priority Settings* – Selects the method by which inbound packets are processed (DSCP or CoS), and sets the per-hop behavior and drop precedence for internal processing.

Layer 2 Queue Settings

This section describes how to configure the default priority for untagged frames, set the queue mode, set the weights assigned to each queue, and map class of service tags to queues.

Setting the Default Priority for Interfaces

Use the Traffic > Priority > Default Priority page to specify the default port priority for each interface on the switch. All untagged packets entering the switch are tagged with the specified default port priority, and then sorted into the appropriate priority queue at the output port.

Command Usage

- ◆ This switch provides eight priority queues for each port. It uses Weighted Round Robin to prevent head-of-queue blockage, but can be configured to process each queue in strict order, or use a combination of strict and weighted queueing.
- ◆ The default priority applies for an untagged frame received on a port set to accept all frame types (i.e, receives both untagged and tagged frames). This priority does not apply to IEEE 802.1Q VLAN tagged frames. If the incoming frame is an IEEE 802.1Q VLAN tagged frame, the IEEE 802.1p User Priority bits will be used.
- ◆ If the output port is an untagged member of the associated VLAN, these frames are stripped of all VLAN tags prior to transmission.

Parameters

These parameters are displayed:

- ◆ **Interface** – Displays a list of ports or trunks.
- ◆ **CoS** – The priority that is assigned to untagged frames received on the specified interface. (Range: 0-7; Default: 0)

Web Interface

To configure the queue mode:

1. Click **Traffic > Priority > Default Priority**.
2. Select the interface type to display (Port or Trunk).
3. Modify the default priority for any interface.

4. Click **Apply**.

Port	CoS (0-7)
1	0
2	0
3	0
4	0
5	0

Selecting the Queue Mode

Use the Traffic > Priority > Queue page to set the queue mode for the egress queues on any interface. The switch can be set to service the queues based on a strict rule that requires all traffic in a higher priority queue to be processed before the lower priority queues are serviced, or Weighted Round-Robin (WRR) queuing which specifies a scheduling weight for each queue. It can also be configured to use a combination of strict and weighted queuing.

Command Usage

- ◆ Strict priority requires all traffic in a higher priority queue to be processed before lower priority queues are serviced.
- ◆ WRR queuing specifies a relative weight for each queue. WRR uses a predefined relative weight for each queue that determines the percentage of service time the switch services each queue before moving on to the next queue. This prevents the head-of-line blocking that can occur with strict priority queuing.
- ◆ If Strict and WRR mode is selected, a combination of strict service is used for the high priority queues and weighted service for the remaining queues. The queues assigned to use strict priority should be specified using the Strict Mode field parameter.
- ◆ A weight can be assigned to each of the weighted queues (and thereby to the corresponding traffic priorities). This weight sets the frequency at which each queue is polled for service, and subsequently affects the response time for software applications assigned a specific priority value. Service time is shared at the egress ports by defining scheduling weights for WRR, or one of the queuing modes that use a combination of strict and weighted queuing.
- ◆ The specified queue mode applies to all interfaces.

Parameters

These parameters are displayed:

- ◆ **Queue Mode**
 - ◆ **Strict** – Services the egress queues in sequential order, transmitting all traffic in the higher priority queues before servicing lower priority queues. This ensures that the highest priority packets are always serviced first, ahead of all other traffic.
 - ◆ **WRR** – Weighted Round-Robin shares bandwidth at the egress ports by using scheduling weights, and servicing each queue in a round-robin fashion. (This is the default setting.)
 - ◆ **Strict and WRR** – Uses strict priority on the high-priority queues and WRR on the remaining queues.
- ◆ **Queue ID** – The ID of the priority queue. (Range: 0-7)
- ◆ **Strict Mode** – If “Strict and WRR” mode is selected, then a combination of strict service is used for the high priority queues and weighted service for the remaining queues. Use this parameter to specify the queues assigned to use strict priority when using the strict-weighted queuing mode. (Default: Disabled)
- ◆ **Weight** – Sets a weight for each queue which is used by the WRR scheduler. (Range: 1-127; Default: Weights 1, 2, 4, 6, 8, 10, 12 and 14 are assigned to queues 0 - 7 respectively)

Web Interface

To configure the queue mode:

1. Click **Traffic > Priority > Queue**.
2. Set the queue mode.
3. If the weighted queue mode is selected, the queue weight can be modified if required.
4. If the queue mode that uses a combination of strict and weighted queuing is selected, the queues which are serviced first must be specified by enabling strict mode parameter in the table.
5. Click **Apply**.

Setting the Queue Mode (Strict)

Traffic > Priority > Queue

Queue Mode

Setting the Queue Mode (WRR)

Traffic > Priority > Queue

Queue Mode

Queue Setting Table Total: 8

Queue ID	Weight (1-255)
0	<input type="text" value="1"/>
1	<input type="text" value="2"/>
2	<input type="text" value="4"/>
3	<input type="text" value="6"/>
4	<input type="text" value="8"/>
5	<input type="text" value="10"/>
6	<input type="text" value="12"/>
7	<input type="text" value="14"/>

Setting the Queue Mode (Strict and WRR)

Traffic > Priority > Queue

Queue Mode

Queue Setting Table Total: 8

Queue ID	Strict Mode	Weight (1-255)
0	<input type="text" value="Disabled"/>	<input type="text" value="1"/>
1	<input type="text" value="Disabled"/>	<input type="text" value="2"/>
2	<input type="text" value="Disabled"/>	<input type="text" value="4"/>
3	<input type="text" value="Disabled"/>	<input type="text" value="6"/>
4	<input type="text" value="Disabled"/>	<input type="text" value="8"/>
5	<input type="text" value="Disabled"/>	<input type="text" value="10"/>
6	<input type="text" value="Disabled"/>	<input type="text" value="12"/>
7	<input type="text" value="Disabled"/>	<input type="text" value="14"/>

Mapping CoS Value to Egress Queues

Use the Traffic > Priority > PHB to Queue page to specify the hardware output queues to use based on the internal per-hop behavior value. (For more information on exact manner in which the ingress priority tags are mapped to egress queues for internal processing, see Mapping CoS Priorities to Internal DSCP Values).

The switch processes Class of Service (CoS) priority tagged traffic by using eight priority queues for each port, with service schedules based on strict priority, Weighted Round-Robin (WRR), or a combination of strict and weighted queuing. Up to eight separate traffic priorities are defined in IEEE 802.1p. Default priority levels are assigned according to recommendations in the IEEE 802.1p standard as shown in Table below. The following table indicates the default mapping of internal per-hop behavior to the hardware queues. The actual mapping may differ if the CoS priorities to internal DSCP values have been modified.

Priority	0	1	2	3	4	5	6	7
Queue	2	0	1	3	4	5	6	7

The priority levels recommended in the IEEE 802.1p standard for various network applications are shown in Table below. However, priority levels can be mapped to the switch's output queues in any way that benefits application traffic for the network.

Priority Level	Traffic Type
1	Background
2	(Spare)
0 (default)	Best Effort
3	Excellent Effort
4	Controlled Load
5	Video, less than 100 milliseconds latency and jitter
6	Voice, less than 10 milliseconds latency and jitter
7	Network Control

Command Usage

- ◆ Egress packets are placed into the hardware queues according to the mapping defined by this command.
- ◆ The default internal PHB to output queue mapping is shown below.

Per-hop Behavior	0	1	2	3	4	5	6	7
Hardware Queues	2	0	1	3	4	5	6	7

- ◆ The specified mapping applies to all interfaces.

Parameters

These parameters are displayed:

- ◆ **Port** – Specifies a port.
- ◆ **PHB** – Per-hop behavior, or the priority used for this router hop. (Range: 0-7, where 7 is the highest priority)
- ◆ **Queue** – Output queue buffer. (Range: 0-7, where 7 is the highest CoS priority queue)

Web Interface

To map internal PHB to hardware queues:

1. Click **Traffic > Priority > PHB to Queue**.
2. Select Configure from the Action list.
3. Select a port.
4. Map an internal PHB to a hardware queue. Depending on how an ingress packet is processed internally based on its CoS value, and the assigned output queue, the mapping done on this page can effectively determine the service priority for different traffic classes.
5. Click **Apply**.

Traffic > Priority > PHB to Queue

Action: Configure ▼

Port 1 ▼

PHB (0-7)

Queue (0-7)

Apply
Revert

To show the internal PHB to hardware queue map:

1. Click **Traffic > Priority > PHB to Queue**.
2. Select Show from the Action list.
3. Select an interface.

Traffic > Priority > PHB to Queue

Action: Show

Port: 1

PHB to Queue Mapping List Total: 8

<input type="checkbox"/>	PHB	Queue
<input type="checkbox"/>	0	2
<input type="checkbox"/>	1	0
<input type="checkbox"/>	2	1
<input type="checkbox"/>	3	3
<input type="checkbox"/>	4	4
<input type="checkbox"/>	5	5
<input type="checkbox"/>	6	6
<input type="checkbox"/>	7	7

Default Revert

Layer 3/4 Priority Settings

Mapping Layer 3/4 Priorities to CoS Values

The switch supports several common methods of prioritizing layer 3/4 traffic to meet application requirements. Traffic priorities can be specified in the IP header of a frame, using the priority bits in the Type of Service (ToS) octet, or the number of the TCP/UDP port. If priority bits are used, the ToS octet may contain three bits for IP Precedence or six bits for Differentiated Services Code Point (DSCP) service. When these services are enabled, the priorities are mapped to a Class of Service value by the switch, and the traffic then sent to the corresponding output queue.

Because different priority information may be contained in the traffic, this switch maps priority values to the output queues in the following manner – The precedence for priority mapping is DSCP Priority and then Default Port Priority.

Note: The default settings used for mapping priority values from ingress traffic to internal DSCP values are used to determine the hardware queues used for egress traffic, not to replace the priority values. These defaults are designed to optimize priority services for the majority of network applications. It should not be necessary to modify any of the default settings, unless a queuing problem occurs with a particular application.

Setting Priority Processing to IP Precedence/DSCP or CoS

The switch allows a choice between using IP Precedence, DSCP or CoS priority processing methods. Use the Priority > Trust Mode page to select the required processing method.

Command Usage

- ◆ If the QoS mapping mode is set to IP Precedence, and the ingress packet type is IPv4, then priority processing will be based on the IP Precedence value in the ingress packet.
- ◆ If the QoS mapping mode is set to DSCP, and the ingress packet type is IPv4, then priority processing will be based on the DSCP value in the ingress packet.
- ◆ If the QoS mapping mode is set to either IP Precedence or DSCP, and a non-IP packet is received, the packet's CoS and CFI (Canonical Format Indicator) values are used for priority processing if the packet is tagged.

For an untagged packet, the default port priority is used for priority processing.

- ◆ If the QoS mapping mode is set to CoS, and the ingress packet type is IPv4, then priority processing will be based on the CoS and CFI values in the ingress packet.

For an untagged packet, the default port priority is used for priority processing.

Parameters

These parameters are displayed:

- ◆ **Port** – Port identifier. (Range: 1-28/54)
- ◆ **Trust Mode**
 - ◆ **IP Precedence** – Maps layer 3/4 priorities using IP Precedence values.
 - ◆ **CoS** – Maps layer 3/4 priorities using Class of Service values. (This is the default setting.)
 - ◆ **DSCP** – Maps layer 3/4 priorities using Differentiated Services Code Point values.

Web Interface

To configure the trust mode:

1. Click **Traffic > Priority > Trust Mode**.
2. Set the trust mode for any port.
3. Click **Apply**.

Port	Trust Mode
1	CoS
2	CoS
3	CoS
4	CoS
5	CoS

Mapping Ingress DSCP Values to Internal DSCP Values

Use the Traffic > Priority > DSCP to DSCP page to map DSCP values in incoming packets to per-hop behavior and drop precedence values for internal priority processing.

The DSCP is six bits wide, allowing coding for up to 64 different forwarding behaviors. The DSCP replaces the ToS bits, but it retains backward compatibility with the three precedence bits so that non-DSCP compliant, ToS-enabled devices, will not conflict with the DSCP mapping. Based on network policies, different kinds of traffic can be marked for different kinds of forwarding.

Command Usage

- ◆ Enter per-hop behavior and drop precedence for any of the DSCP values 0 - 63.
- ◆ This map is only used when the priority mapping mode is set to DSCP, and the ingress packet type is IPv4. Any attempt to configure the DSCP mutation map will not be accepted by the switch, unless the trust mode has been set to DSCP.
- ◆ Two QoS domains can have different DSCP definitions, so the DSCP-to-PHB/Drop Precedence mutation map can be used to modify one set of DSCP values to match the definition of another domain. The mutation map should be applied at the receiving port (ingress mutation) at the boundary of a QoS administrative domain.

Parameters

These parameters are displayed:

- ◆ **Port** – Specifies a port.
- ◆ **DSCP** – DSCP value in ingress packets. (Range: 0-63)
- ◆ **PHB** – Per-hop behavior, or the priority used for this router hop. (Range: 0-7)
- ◆ **Drop Precedence** – Drop precedence used for controlling traffic congestion. (Range: 0 - Green, 3 - Yellow, 1 - Red)

	ingress-dscp1	0	1	2	3	4	5	6	7	8	9
ingress-dscp10											
0		0,0	0,1	0,0	0,3	0,0	0,1	0,0	0,3	1,0	1,1
1		1,0	1,3	1,0	1,1	1,0	1,3	2,0	2,1	2,0	2,3
2		2,0	2,1	2,0	2,3	3,0	3,1	3,0	3,3	3,0	3,1
3		3,0	3,3	4,0	4,1	4,0	4,3	4,0	4,1	4,0	4,3
4		5,0	5,1	5,0	5,3	5,0	5,1	6,0	5,3	6,0	6,1
5		6,0	6,3	6,0	6,1	6,0	6,3	7,0	7,1	7,0	7,3
6		7,0	7,1	7,0	7,3						

The ingress DSCP is composed of ingress-dscp10 (most significant digit in the left column) and ingress-dscp1 (least significant digit in the top row (in other words, $\text{ingress-dscp} = \text{ingress-dscp10} * 10 + \text{ingress-dscp1}$); and the corresponding internal-dscp is shown at the intersecting cell in the table.

The ingress DSCP is bitwise ANDed with the binary value 11 to determine the drop precedence. If the resulting value is 10 binary, then the drop precedence is set to 0.

Web Interface

To map DSCP values to internal PHB/drop precedence:

1. Click **Traffic > Priority > DSCP to DSCP**.
2. Select Configure from the Action list.
3. Select a port.
4. Set the PHB and drop precedence for any DSCP value.
5. Click **Apply**.

Traffic > Priority > DSCP to DSCP

Action: Configure ▾

Port: 1 ▾

DSCP (0-63):

PHB (0-7):

Drop Precedence: 0: Green ▾

To show the DSCP to internal PHB/drop precedence map:

1. Click **Traffic > Priority > DSCP to DSCP**.
2. Select Show from the Action list.
3. Select a port.

Traffic > Priority > DSCP to DSCP

Action: Show

Port: 1

DSCP to DSCP Mapping List Total: 64

	DSCP	PHB	Drop Precedence
<input type="checkbox"/>	0	0	0: Green
<input type="checkbox"/>	1	0	1: Red
<input type="checkbox"/>	2	0	0: Green
<input type="checkbox"/>	3	0	3: Yellow
<input type="checkbox"/>	4	0	0: Green
<input type="checkbox"/>	5	0	1: Red
<input type="checkbox"/>	6	0	0: Green
<input type="checkbox"/>	7	0	3: Yellow
<input type="checkbox"/>	8	1	0: Green
<input type="checkbox"/>	9	1	1: Red

Default Revert

Mapping CoS Priorities to Internal DSCP Values

Use the Traffic > Priority > CoS to DSCP page to maps CoS/CFI values in incoming packets to per-hop behavior and drop precedence values for priority processing.

Command Usage

- ◆ The default mapping of CoS to PHB values is shown.
- ◆ Enter up to eight CoS/CFI paired values, per-hop behavior and drop precedence.
- ◆ If a packet arrives with a 802.1Q header but it is not an IP packet, then the CoS/CFI-to-PHB/Drop Precedence mapping table is used to generate priority and drop precedence values for internal processing. Note that priority tags in the original packet are not modified by this command.
- ◆ The internal DSCP consists of three bits for per-hop behavior (PHB) which determines the queue to which a packet is sent; and two bits for drop precedence (namely color) which is used to control traffic congestion.

Parameters

These parameters are displayed:

- ◆ **Port** – Specifies a port.
- ◆ **CoS** – CoS value in ingress packets. (Range: 0-7)
- ◆ **CFI** – Canonical Format Indicator. Set to this parameter to “0” to indicate that the MAC address information carried in the frame is in canonical format. (Range: 0-1)
- ◆ **PHB** – Per-hop behavior, or the priority used for this router hop. (Range: 0-7)
- ◆ **Drop Precedence** – Drop precedence used in controlling traffic congestion. (Range: 0 - Green, 3 - Yellow, 1 - Red)

CoS	CFI	0	1
0		(0,0)	(0,0)
1		(1,0)	(1,0)
2		(2,0)	(2,0)
3		(3,0)	(3,0)
4		(4,0)	(4,0)
5		(5,0)	(5,0)
6		(6,0)	(6,0)
7		(7,0)	(7,0)

Web Interface

To map CoS/CFI values to internal PHB/drop precedence:

1. Click **Traffic > Priority > CoS to DSCP**.
2. Select Configure from the Action list.
3. Select a port.
4. Set the PHB and drop precedence for any of the CoS/CFI combinations.
5. Click **Apply**.

Traffic > Priority > CoS to DSCP

Action:

Port:

CoS (0-7):

CFI (0-1):

PHB (0-7):

Drop Precedence:

To show the Cos/CFI to internal PHB/drop precedence map:

1. Click **Traffic > Priority > CoS to DSCP**.
2. Select Show from the Action list.
3. Select a port.

Traffic > Priority > CoS to DSCP

Action:

Port:

CoS to DSCP Mapping List Total: 10

<input type="checkbox"/>	CoS	CFI	PHB	Drop Precedence
<input type="checkbox"/>	0	0	0	0: Green
<input type="checkbox"/>	0	1	0	0: Green
<input type="checkbox"/>	1	0	1	0: Green
<input type="checkbox"/>	1	1	1	0: Green
<input type="checkbox"/>	2	0	2	0: Green
<input type="checkbox"/>	2	1	2	0: Green
<input type="checkbox"/>	3	0	3	0: Green
<input type="checkbox"/>	3	1	3	0: Green
<input type="checkbox"/>	4	0	4	0: Green
<input type="checkbox"/>	4	1	4	0: Green

Mapping IP Precedence Values to Internal DSCP Values

Use the Traffic > Priority > IP Precedence to DSCP page to map IP precedence values in incoming packets to per-hop behavior and drop precedence values for priority processing.

The Type of Service (ToS) octet in the IPv4 header includes three precedence bits defining eight different priority levels ranging from highest priority for network control packets to lowest priority for routine traffic. The default IP Precedence values map one-to-one to the Class of Service values (that is, Precedence value 0 maps to PHB value 0, and so forth). Bits 6 and 7 are used for network control, and the other bits for various application types. The ToS bits are defined in the Table below.

Priority Level	Traffic Type
7	Network Control
6	Internetwork Control
5	Critical
4	Flash Override
3	Flash
2	Immediate
1	Priority
0	Routine

Command Usage

- ◆ Enter per-hop behavior and drop precedence for any of the IP Precedence values 0 - 7.
- ◆ If the priority mapping mode is set the IP Precedence and the ingress packet type is IPv4, then the IP Precedence-to-PHB/Drop Precedence mapping table is used to generate priority and drop precedence values for internal processing.
- ◆ Random Early Detection starts dropping yellow and red packets when the buffer fills up to 0x60 packets, and then starts dropping any packets regardless of color when the buffer fills up to 0x80 packets.

Parameters

These parameters are displayed in the web interface:

- ◆ **Interface** – Specifies a port or trunk.
- ◆ **IP Precedence** – IP Precedence value in ingress packets. (Range: 0-7)
- ◆ **PHB** – Per-hop behavior, or the priority used for this router hop. (Range: 0-7)
- ◆ **Drop Precedence** – Drop precedence used for Random Early Detection in controlling traffic congestion. (Range: 0 - Green, 3 - Yellow, 1 - Red)

IP Precedence Value	0	1	2	3	4	5	6	7
Per-hop Behavior	0	1	2	3	4	5	6	7
Drop Precedence	0	0	0	0	0	0	0	0

Web Interface

To map IP Precedence to internal PHB/drop precedence in the web interface:

1. Click **Traffic > Priority > IP Precedence to DSCP**.
2. Select Configure from the Action list.
3. Select an interface.
4. Set the PHB and drop precedence for any of the IP Precedence values.
5. Click **Apply**.

Traffic > Priority > IP Precedence to DSCP

Action:

Port:

IP Precedence (0-7):

PHB (0-7):

Drop Precedence:

To show the IP Precedence to internal PHB/drop precedence map in the web interface:

1. Click **Traffic > Priority > IP Precedence to DSCP**.
2. Select Show from the Action list.
3. Select an interface.

Traffic > Priority > IP Precedence to DSCP

Action:

Port:

IP Precedence to DSCP Mapping List Total: 8

IP Precedence	PHB	Drop Precedence
0	0	0
1	1	0
2	2	0
3	3	0
4	4	0
5	5	0
6	6	0
7	6	0

This Page Intentionally Left Blank

Chapter 12

Quality of Service

Overview

This chapter describes the following tasks required to apply QoS policies:

- ♦ *Class Map* – Creates a map which identifies a specific class of traffic.
- ♦ *Policy Map* – Sets the boundary parameters used for monitoring inbound traffic, and the action to take for conforming and non-conforming traffic.
- ♦ *Binding to a Port* – Applies a policy map to an ingress port.

The commands described in this section are used to configure Quality of Service (QoS) classification criteria and service policies. Differentiated Services (DiffServ) provides policy-based management mechanisms used for prioritizing network resources to meet the requirements of specific traffic types on a per hop basis. Each packet is classified upon entry into the network based on access lists, IP Precedence, DSCP values, VLAN lists, CoS values, or source ports. Using access lists allows you select traffic based on Layer 2, Layer 3, or Layer 4 information contained in each packet. Based on configured network policies, different kinds of traffic can be marked for different kinds of forwarding.

All switches or routers that access the Internet rely on class information to provide the same forwarding treatment to packets in the same class. Class information can be assigned by end hosts, or switches or routers along the path. Priority can then be assigned based on a general policy, or a detailed examination of the packet. However, note that detailed examination of packets should take place close to the network edge so that core switches and routers are not overloaded.

Switches and routers along the path can use class information to prioritize the resources allocated to different traffic classes. The manner in which an individual device handles traffic in the DiffServ architecture is called per-hop behavior. All devices along a path should be configured in a consistent manner to construct a consistent end-to-end QoS solution.

Note:

- ♦ You can configure up to 16 rules per class map. You can also include multiple classes in a policy map.
 - ♦ You should create a class map before creating a policy map. Otherwise, you will not be able to select a class map from the policy rule settings screen.
-

Class Map

A class map is used for matching packets to a specified class. Use the Traffic > DiffServ (Configure Class) page to configure a class map.

Command Usage

- ◆ The class map is used with a policy map to create a service policy for a specific interface that defines packet classification, service tagging, and bandwidth policing. Note that one or more class maps can be assigned to a policy map.
- ◆ Up to 32 class maps can be configured.

Parameters

These parameters are displayed:

Add

- ◆ **Class Name** – Name of the class map. (Range: 1-32 characters)
- ◆ **Type** – Only one match command is permitted per class map, so the match-any field refers to the lone criteria specified by this command.
- ◆ **Description** – A brief description of a class map. (Range: 1-64 characters)

Add Rule

- ◆ **Class Name** – Name of the class map.
- ◆ **Type** – Only one match command is permitted per class map, so the match-any field refers to the lone criteria specified by this command.
- ◆ **ACL** – Name of an access control list. Any type of ACL can be specified, including standard or extended IPv4/IPv6 ACLs and MAC ACLs.
- ◆ **IP DSCP** – A DSCP value. (Range: 0-63)
- ◆ **IP Precedence** – An IP Precedence value. (Range: 0-7)
- ◆ **IPv6 DSCP** – A DSCP value contained in an IPv6 packet. (Range: 0-63)
- ◆ **VLAN ID** – A VLAN. (Range:1-4094)
- ◆ **CoS** – A CoS value. (Range: 0-7)
- ◆ **Source Port** – A source port. (Range: 1-28/54)

Web Interface

To configure a class map:

1. Click **Traffic > DiffServ**.
2. Select Configure Class from the Step list.
3. Select Add from the Action list.
4. Enter a class name.
5. Enter a description.
6. Click **Add**.

Traffic > DiffServ

Step: 1. Configure Class Action: Add

Class Name: rd-class

Type: Match Any

Description: class for software group

Apply Revert

To show the configured class maps:

1. Click **Traffic > DiffServ**.
2. Select Configure Class from the Step list.
3. Select Show from the Action list.

Traffic > DiffServ

Step: 1. Configure Class Action: Show

Class List Total: 1

<input type="checkbox"/>	Class Name	Type	Description
<input type="checkbox"/>	rd-class	Match Any	class for software group

Delete Revert

To edit the rules for a class map:

1. Click **Traffic > DiffServ**.
2. Select Configure Class from the Step list.
3. Select Add Rule from the Action list.
4. Select the name of a class map.

5. Specify type of traffic for this class based on an access list, a DSCP or IP Precedence value, VLAN, CoS value, or source port. You can specify up to 16 items to match when assigning ingress traffic to a class map.
6. Click **Apply**.

Traffic > DiffServ

Step: 1. Configure Class Action: Add Rule

Class Name: rc-class

Type: Match Any

Rule:

ACL
 IP DSCP (0-63)
 IP Precedence (0-7)
 IPv6 DSCP (0-63)
 VLAN ID (1-4094)
 CoS (0-7)
 Source Port

Apply Revert

To show the rules for a class map:

1. Click **Traffic > DiffServ**.
2. Select Configure Class from the Step list.
3. Select Show Rule from the Action list.

Traffic > DiffServ

Steps: 1. Configure Class Action: Show Rule

Class Name: rc-class

Type: Match Any

Rule List Total: 2

<input type="checkbox"/>	Rule
<input type="checkbox"/>	IP DSCP 3
<input type="checkbox"/>	IP Precedence 3

Delete Revert

Policy Map

Use the Traffic > DiffServ (Configure Policy) page to create a policy map that can be attached to multiple interfaces. A policy map is used to group one or more class map statements, modify service tagging, and enforce bandwidth policing. A policy map can then be bound by a service policy to one or more interfaces.

Configuring QoS policies requires several steps. A class map must first be configured which indicates how to match the inbound packets according to an access list, a DSCP or IP Precedence value, or a member of specific VLAN, a CoS value, or a source port. A policy map must then be configured to indicate the boundary parameters used for monitoring inbound traffic, and the action to take for conforming and non-conforming traffic. A policy map may contain one or more classes based on previously defined class maps.

The class of service or per-hop behavior (i.e., the priority used for internal queue processing) can be assigned to matching packets. In addition, the flow rate of inbound traffic can be monitored and the response to conforming and non-conforming traffic based by one of three distinct policing methods as described below.

Police Flow Meter – Defines the committed information rate (maximum throughput), committed burst size (burst rate), and the action to take for conforming and non-conforming traffic. Policing is based on a token bucket, where bucket depth (that is, the maximum burst before the bucket overflows) is specified by the “burst” field (BC), and the average rate tokens are removed from the bucket is specified by the “rate” option (CIR). Action may be taken for traffic conforming to the maximum throughput, or exceeding the maximum throughput.

srTCM Police Meter – Defines an enforcer for classified traffic based on a single rate three color meter scheme defined in RFC 2697. This metering policy monitors a traffic stream and processes its packets according to the committed information rate (CIR, or maximum throughput), committed burst size (BC, or burst rate), and excess burst size (BE). Action may taken for traffic conforming to the maximum throughput, exceeding the maximum throughput, or exceeding the excess burst size.

- ◆ The PHB label is composed of five bits, three bits for per-hop behavior, and two bits for the color scheme used to control queue congestion. In addition to the actions defined by this command to transmit, remark the DSCP service value, or drop a packet, the switch will also mark the two color bits used to set the drop precedence of a packet. A packet is marked

green if it doesn't exceed the committed information rate and committed burst size, yellow if it does exceed the committed information rate and committed burst size, but not the excess burst size, and red otherwise.

- ◆ The meter operates in one of two modes. In the color-blind mode, the meter assumes that the packet stream is uncolored. In color-aware mode the meter assumes that some preceding entity has pre-colored the incoming packet stream so that each packet is either green, yellow, or red. The marker (re)colors an IP packet according to the results of the meter. The color is coded in the DS field [RFC 2474] of the packet.
- ◆ The behavior of the meter is specified in terms of its mode and two token buckets, C and E, which both share the common rate CIR. The maximum size of the token bucket C is BC and the maximum size of the token bucket E is BE.

The token buckets C and E are initially full, that is, the token count $T_c(0) = BC$ and the token count $T_e(0) = BE$. Thereafter, the token counts T_c and T_e are updated CIR times per second as follows:

- ◆ If T_c is less than BC, T_c is incremented by one, else.
- ◆ If T_e is less than BE, T_e is incremented by one, else.
- ◆ Neither T_c nor T_e is incremented.

When a packet of size B bytes arrives at time t, the following happens if srTCM is configured to operate in Color-Blind mode:

- ◆ If $T_c(t) - B \leq 0$, the packet is green and T_c is decremented by B down to the minimum value of 0, else.
- ◆ If $T_e(t) - B \leq 0$, the packets is yellow and T_e is decremented by B down to the minimum value of 0, else.
- ◆ Else the packet is red and neither T_c nor T_e is decremented.

When a packet of size B bytes arrives at time t, the following happens if srTCM is configured to operate in Color-Aware mode:

- ◆ If the packet has been precolored as green and $T_c(t) - B \leq 0$, the packet is green and T_c is decremented by B down to the minimum value of 0, else.
- ◆ If the packet has been precolored as yellow or green and if $T_e(t) - B \leq 0$, the packets is yellow and T_e is decremented by B down to the minimum value of 0, else.
- ◆ The packet is red and neither T_c nor T_e is decremented.

The metering policy guarantees a deterministic behavior where the volume of green packets is never smaller than what has been determined by the CIR and BC, that is, tokens of a given color are always spent on packets of

that color. Refer to RFC 2697 for more information on other aspects of srTCM.

trTCM Police Meter – Defines an enforcer for classified traffic based on a two rate three color meter scheme defined in RFC 2698. This metering policy monitors a traffic stream and processes its packets according to the committed information rate (CIR, or maximum throughput), peak information rate (PIR), and their associated burst sizes – committed burst size (BC, or burst rate), and peak burst size (BP). Action may taken for traffic conforming to the maximum throughput, exceeding the maximum throughput, or exceeding the peak burst size.

- ◆ The PHB label is composed of five bits, three bits for per-hop behavior, and two bits for the color scheme used to control queue congestion. In addition to the actions defined by this command to transmit, remark the DSCP service value, or drop a packet, the switch will also mark the two color bits used to set the drop precedence of a packet. A packet is marked red if it exceeds the PIR. Otherwise it is marked either yellow or green depending on whether it exceeds or doesn't exceed the CIR.

The trTCM is useful for ingress policing of a service, where a peak rate needs to be enforced separately from a committed rate.

- ◆ The meter operates in one of two modes. In the color-blind mode, the meter assumes that the packet stream is uncolored. In color-aware mode the meter assumes that some preceding entity has pre-colored the incoming packet stream so that each packet is either green, yellow, or red. The marker (re)colors an IP packet according to the results of the meter. The color is coded in the DS field [RFC 2474] of the packet.
- ◆ The behavior of the meter is specified in terms of its mode and two token buckets, P and C, which are based on the rates PIR and CIR, respectively. The maximum size of the token bucket P is BP and the maximum size of the token bucket C is BC.

The token buckets P and C are initially (at time 0) full, that is, the token count $T_p(0) = BP$ and the token count $T_c(0) = BC$. Thereafter, the token count T_p is incremented by one PIR times per second up to BP and the token count T_c is incremented by one CIR times per second up to BC.

When a packet of size B bytes arrives at time t, the following happens if trTCM is configured to operate in Color-Blind mode:

- ◆ If $T_p(t) - B < 0$, the packet is red, else.
- ◆ If $T_c(t) - B < 0$, the packet is yellow and T_p is decremented by B, else.
- ◆ The packet is green and both T_p and T_c are decremented by B.

When a packet of size B bytes arrives at time t, the following happens if trTCM is configured to operate in Color-Aware mode:

- ◆ If the packet has been precolored as red or if $Tp(t)-B < 0$, the packet is red, else.
 - ◆ If the packet has been precolored as yellow or if $Tc(t)-B < 0$, the packet is yellow and Tp is decremented by B, else.
 - ◆ The packet is green and both Tp and Tc are decremented by B.
- ◆ The trTCM can be used to mark a IP packet stream in a service, where different, decreasing levels of assurances (either absolute or relative) are given to packets which are green, yellow, or red. Refer to RFC 2698 for more information on other aspects of trTCM.

Command Usage

- ◆ A policy map can contain 512 class statements that can be applied to the same interface. Up to 32 policy maps can be configured for ingress ports.
- ◆ After using the policy map to define packet classification, service tagging, and bandwidth policing, it must be assigned to a specific interface by a service policy to take effect.

Parameters

These parameters are displayed:

Add

- ◆ **Policy Name** – Name of policy map. (Range: 1-32 characters)
- ◆ **Description** – A brief description of a policy map. (Range: 1-64 characters)

Add Rule

- ◆ **Policy Name** – Name of policy map.
- ◆ **Class Name** – Name of a class map that defines a traffic classification upon which a policy can act.
- ◆ **Action** – This attribute is used to set an internal QoS value in hardware for matching packets. The PHB label is composed of five bits, three bits for per-hop behavior, and two bits for the color scheme used to control queue congestion with the srTCM and trTCM metering functions.
 - ◆ **Set CoS** – Configures the service provided to ingress traffic by setting an internal CoS value for a matching packet (as specified in rule settings for a class map). (Range: 0-7)

See Default Mapping of CoS/CFI to Internal PHB/Drop Precedence.

- ◆ **Set PHB** – Configures the service provided to ingress traffic by setting the internal per-hop behavior for a matching packet (as specified in rule settings for a class map). (Range: 0-7)

See Default Mapping of DSCP Values to Internal PHB/Drop Values.

- ◆ **Set IP DSCP** – Configures the service provided to ingress traffic by setting an IP DSCP value for a matching packet (as specified in rule settings for a class map). (Range: 0-63)
- ◆ **Meter** – Check this to define the maximum throughput, burst rate, and the action that results from a policy violation.
- ◆ **Meter Mode** – Selects one of the following policing methods.
 - ◆ **Flow (Police Flow)** – Defines the committed information rate (CIR, or maximum throughput), committed burst size (BC, or burst rate), and the action to take for conforming and non-conforming traffic. Policing is based on a token bucket, where bucket depth (that is, the maximum burst before the bucket overflows) is specified by the “burst” field, and the average rate tokens are removed from the bucket is by specified by the “rate” option.
 - ◆ **Committed Information Rate (CIR)** – Rate in kilobits per second. (Range: 0-10000000 kbps at a granularity of 64 kbps or maximum port speed, whichever is lower)
The rate cannot exceed the configured interface speed.
 - ◆ **Committed Burst Size (BC)** – Burst in bytes. (Range: 64-16000000 at a granularity of 4k bytes)
The burst size cannot exceed 16 Mbytes.
 - ◆ **Conform** – Specifies that traffic conforming to the maximum rate (CIR) will be transmitted without any change to the DSCP service level.
 - ◆ **Transmit** – Transmits in-conformance traffic without any change to the DSCP service level.
 - ◆ **Violate** – Specifies whether the traffic that exceeds the maximum rate (CIR) will be dropped or the DSCP service level will be reduced.
 - ◆ **Set IP DSCP** – Decreases DSCP priority for out of conformance traffic. (Range: 0-63)
 - ◆ **Drop** – Drops out of conformance traffic.
 - ◆ **srTCM (Police Meter)** – Defines the committed information rate (CIR, or maximum throughput), committed burst size (BC, or burst rate) and excess burst size (BE), and the action to take for traffic conforming to the maximum throughput, exceeding the maximum throughput but

within the excess burst size, or exceeding the excess burst size. In addition to the actions defined by this command to transmit, remark the DSCP service value, or drop a packet, the switch will also mark the two color bits used to set the drop precedence of a packet.

The color modes include “Color-Blind” which assumes that the packet stream is uncolored, and “Color-Aware” which assumes that the incoming packets are pre-colored. The functional differences between these modes is described at the beginning of this section under “srTCM Police Meter.”

- ◆ **Committed Information Rate (CIR)** – Rate in kilobits per second. (Range: 0-10000000 kbps at a granularity of 64 kbps or maximum port speed, whichever is lower)
The rate cannot exceed the configured interface speed.
- ◆ **Committed Burst Size (BC)** – Burst in bytes. (Range: 64-16000000 at a granularity of 4k bytes)
The burst size cannot exceed 16 Mbytes.
- ◆ **Excess Burst Size (BE)** – Burst in excess of committed burst size. (Range: 64-16000000 at a granularity of 4k bytes)
The burst size cannot exceed 16 Mbytes.
- ◆ **Conform** – Specifies that traffic conforming to the maximum rate (CIR) will be transmitted without any change to the DSCP service level.
- ◆ **Transmit** – Transmits in-conformance traffic without any change to the DSCP service level.
- ◆ **Exceed** – Specifies whether traffic that exceeds the maximum rate (CIR) but is within the excess burst size (BE) will be dropped or the DSCP service level will be reduced.
- ◆ **Set IP DSCP** – Decreases DSCP priority for out of conformance traffic. (Range: 0-63)
- ◆ **Drop** – Drops out of conformance traffic.
- ◆ **Violate** – Specifies whether the traffic that exceeds the excess burst size (BE) will be dropped or the DSCP service level will be reduced.
- ◆ **Set IP DSCP** – Decreases DSCP priority for out of conformance traffic. (Range: 0-63)
- ◆ **Drop** – Drops out of conformance traffic.
- ◆ **trTCM (Police Meter)** – Defines the committed information rate (CIR, or maximum throughput), peak information rate (PIR), and their

associated burst sizes – committed burst size (BC, or burst rate) and peak burst size (BP), and the action to take for traffic conforming to the maximum throughput, exceeding the maximum throughput but within the peak information rate, or exceeding the peak information rate. In addition to the actions defined by this command to transmit, remark the DSCP service value, or drop a packet, the switch will also mark the two color bits used to set the drop precedence of a packet.

The color modes include “Color-Blind” which assumes that the packet stream is uncolored, and “Color-Aware” which assumes that the incoming packets are pre-colored. The functional differences between these modes is described at the beginning of this section under “trTCM Police Meter.”

- ◆ **Committed Information Rate (CIR)** – Rate in kilobits per second. (Range: 0-10000000 kbps at a granularity of 64 kbps or maximum port speed, whichever is lower)
The rate cannot exceed the configured interface speed.
- ◆ **Committed Burst Size (BC)** – Burst in bytes. (Range: 64-16000000 at a granularity of 4k bytes)
The burst size cannot exceed 16 Mbytes.
- ◆ **Peak Information Rate (PIR)** – Rate in kilobits per second. (Range: 0-10000000 kbps at a granularity of 64 kbps or maximum port speed, whichever is lower)
The rate cannot exceed the configured interface speed.
- ◆ **Peak Burst Size (BP)** – Burst size in bytes. (Range: 64-16000000 at a granularity of 4k bytes)
The burst size cannot exceed 16 Mbytes.
- ◆ **Conform** – Specifies that traffic conforming to the maximum rate (CIR) will be transmitted without any change to the DSCP service level.
- ◆ **Transmit** – Transmits in-conformance traffic without any change to the DSCP service level.
- ◆ **Exceed** – Specifies whether traffic that exceeds the maximum rate (CIR) but is within the peak information rate (PIR) will be dropped or the DSCP service level will be reduced.
- ◆ **Set IP DSCP** – Decreases DSCP priority for out of conformance traffic. (Range: 0-63).
- ◆ **Drop** – Drops out of conformance traffic.

- ♦ **Violate** – Specifies whether the traffic that exceeds the peak information rate (PIR) will be dropped or the DSCP service level will be reduced.
- ♦ **Set IP DSCP** – Decreases DSCP priority for out of conformance traffic. (Range: 0-63).
- ♦ **Drop** – Drops out of conformance traffic.

Web Interface

To configure a policy map:

1. Click **Traffic > DiffServ**.
2. Select Configure Policy from the Step list.
3. Select Add from the Action list.
4. Enter a policy name.
5. Enter a description.
6. Click **Add**.

Traffic > DiffServ

Step: 2. Configure Policy Action: Add

Policy Name: rd-policy

Description: for the software group

Apply Revert

To show the configured policy map:

1. Click **Traffic > DiffServ**.
2. Select Configure Policy from the Step list.
3. Select Show from the Action list.

Traffic > DiffServ

Step: 2. Configure Policy Action: Show

Policy List Total: 1

	Policy Name	Description
<input type="checkbox"/>	rd-policy	for the software group

Delete Revert

To edit the rules for a policy map:

1. Click **Traffic > DiffServ**.

2. Select Configure Policy from the Step list.
3. Select Add Rule from the Action list.
4. Select the name of a policy map.
5. Set the CoS or per-hop behavior for matching packets to specify the quality of service to be assigned to the matching traffic class. Use one of the metering options to define parameters such as the maximum throughput and burst rate. Then specify the action to take for conforming traffic, the action to take for traffic in excess of the maximum rate but within the peak information rate, or the action to take for a policy violation.
6. Click **Apply**.

The screenshot shows the configuration interface for DiffServ. The title is "Traffic > DiffServ". At the top, there are two dropdown menus: "Step: 2. Configure Policy" and "Action: Add Rule". Below this, the "Policy Name" is set to "rd-policy".

The "Rule:" section contains the following fields:

- Class Name:** A dropdown menu set to "rd-class".
- Action:** A checked checkbox, with a dropdown menu set to "Set" and a text input field containing "PHB (0-7)".
- Meter:** A checked checkbox.
- Meter Mode:** A dropdown menu set to "Flow".
- Committed Information Rate (0-10000000):** A text input field containing "1000000" and a unit dropdown set to "kbps".
- Committed Burst Size (64-16000000):** A text input field containing "4000" and a unit dropdown set to "bytes".
- Excess Burst Size (64-16000000):** A text input field and a unit dropdown set to "bytes".
- Peak Information Rate (0-10000000):** A text input field and a unit dropdown set to "kbps".
- Peak Burst Size (64-16000000):** A text input field and a unit dropdown set to "bytes".
- Conform:** A dropdown menu set to "Transmit".
- Exceed:** A dropdown menu set to "Set IP DSCP (0-63)" and a text input field.
- Violate:** A dropdown menu set to "Drop" and a text input field.

To show the rules for a policy map:

1. Click **Traffic > DiffServ**.
2. Select Configure Policy from the Step list.
3. Select Show Rule from the Action list.

Traffic > DiffServ

Steps: 2. Configure Policy Action: Show Rule

Policy Name: rd-policy

Rule List Total: 1

<input type="checkbox"/>	Class Name	Action	Meter									
			Meter Mode	Committed Information Rate (kbps)	Committed Burst Size (bytes)	Exceeded Burst Size (bytes)	Peak Information Rate (kbps)	Peak Burst Size (bytes)	Conform	Exceed	Violate	
<input type="checkbox"/>	rd-class	Set PHB 3	Flow	1000000	4000					Transmit		Drop

Delete Revert

Binding to a Port

Use the Traffic > DiffServ (Configure Interface) page to bind a policy map to a port.

Command Usage

First define a class map, define a policy map, and then bind the service policy to the required interface.

Parameters

These parameters are displayed:

- ◆ **Port** – Specifies a port.
- ◆ **Ingress** – Applies the selected rule to ingress traffic.
- ◆ **Egress** – Applies the selected rule to egress traffic.

Web Interface

To bind a policy map to a port:

1. Click **Traffic > DiffServ**.
2. Select Configure Interface from the Step list.
3. Check the box under the Ingress or Egress field to enable a policy map for a port.
4. Select a policy map from the scroll-down box.
5. Click **Apply**.

The screenshot shows the 'Traffic > DiffServ' web interface. At the top, there is a breadcrumb 'Traffic > DiffServ' and a 'Step:' dropdown menu set to '3. Configure Interface'. Below this is a table titled 'Port Service Policy List' with a total of 29 items. The table has three columns: 'Port', 'Ingress', and 'Egress'. Each row represents a port from 1 to 10. The 'Ingress' and 'Egress' columns contain checkboxes and dropdown menus. At the bottom of the table, there are 'Apply' and 'Revert' buttons.

Port	Ingress	Egress
1	<input type="checkbox"/> [v]	<input type="checkbox"/> [v]
2	<input type="checkbox"/> [v]	<input type="checkbox"/> [v]
3	<input type="checkbox"/> [v]	<input type="checkbox"/> [v]
4	<input type="checkbox"/> [v]	<input type="checkbox"/> [v]
5	<input type="checkbox"/> [v]	<input type="checkbox"/> [v]
6	<input type="checkbox"/> [v]	<input type="checkbox"/> [v]
7	<input type="checkbox"/> [v]	<input type="checkbox"/> [v]
8	<input type="checkbox"/> [v]	<input type="checkbox"/> [v]
9	<input type="checkbox"/> [v]	<input type="checkbox"/> [v]
10	<input type="checkbox"/> [v]	<input type="checkbox"/> [v]

This Page Intentionally Left Blank

Chapter 13

VoIP Traffic Configuration

Overview

This chapter covers the following topics:

- ♦ *Global Settings* – Enables VOIP globally, sets the Voice VLAN, and the aging time for attached ports.
- ♦ *Telephony OUI List* – Configures the list of phones to be treated as VOIP devices based on the specified Organization Unit Identifier (OUI).
- ♦ *Port Settings* – Configures the way in which a port is added to the Voice VLAN, the filtering of non-VoIP packets, the method of detecting VoIP traffic, and the priority assigned to voice traffic.

When IP telephony is deployed in an enterprise network, it is recommended to isolate the Voice over IP (VoIP) network traffic from other data traffic. Traffic isolation can provide higher voice quality by preventing excessive packet delays, packet loss, and jitter. This is best achieved by assigning all VoIP traffic to a single Voice VLAN.

The use of a Voice VLAN has several advantages. It provides security by isolating the VoIP traffic from other data traffic. End-to-end QoS policies and high priority can be applied to VoIP VLAN traffic across the network, guaranteeing the bandwidth it needs. VLAN isolation also protects against disruptive broadcast and multicast traffic that can seriously affect voice quality.

The switch allows you to specify a Voice VLAN for the network and set a CoS priority for the VoIP traffic. The VoIP traffic can be detected on switch ports by using the source MAC address of packets, or by using LLDP (IEEE 802.1AB) to discover connected VoIP devices. When VoIP traffic is detected on a configured port, the switch automatically assigns the port as a tagged member the Voice VLAN. Alternatively, switch ports can be manually configured.

Global Settings

Use the Traffic > VoIP (Configure Global) page to configure the switch for VoIP traffic. First enable automatic detection of VoIP devices attached to the switch ports, then set the Voice VLAN ID for the network. The Voice VLAN aging time can also be set to remove a port from the Voice VLAN when VoIP traffic is no longer received on the port.

Command Usage

All ports are set to VLAN hybrid mode by default. Prior to enabling VoIP for a port (by setting the VoIP mode to Auto or Manual as described below), first ensure that VLAN membership is not set to access mode.

Parameters

These parameters are displayed:

- ◆ **Auto Detection Status** – Enables the automatic detection of VoIP traffic on switch ports. (Default: Disabled)
- ◆ **Voice VLAN** – Sets the Voice VLAN ID for the network. Only one Voice VLAN is supported and it must already be created on the switch. (Range: 1-4094)
- ◆ **Voice VLAN Aging Time** – The time after which a port is removed from the Voice VLAN when VoIP traffic is no longer received on the port. (Range: 5-43200 minutes; Default: 1440 minutes)

Note: The Voice VLAN ID cannot be modified when the global Auto Detection Status is enabled.

Web Interface

To configure global settings for a Voice VLAN:

1. Click **Traffic > VoIP**.
2. Select Configure Global from the Step list.
3. Enable Auto Detection.
4. Specify the Voice VLAN ID.
5. Adjust the Voice VLAN Aging Time if required.
6. Click **Apply**.

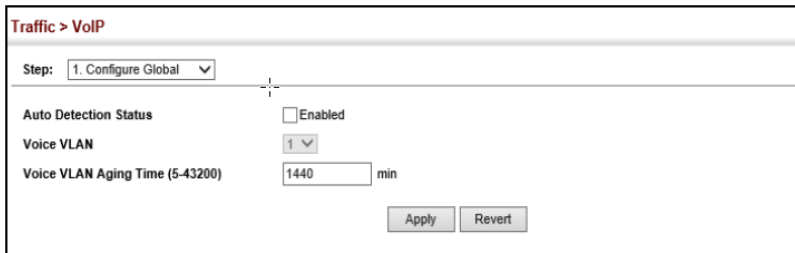

The screenshot shows a web interface for configuring VoIP settings. The title bar reads "Traffic > VoIP". Below the title bar, there is a "Step:" dropdown menu set to "1. Configure Global". The main configuration area contains three settings: "Auto Detection Status" with an unchecked checkbox labeled "Enabled"; "Voice VLAN" with a dropdown menu set to "1"; and "Voice VLAN Aging Time (5-43200)" with a text input field containing "1440" and a "min" label. At the bottom right of the configuration area, there are two buttons: "Apply" and "Revert".

Telephony OUI List

VoIP devices attached to the switch can be identified by the vendor's Organizational Unique Identifier (OUI) in the source MAC address of received packets. OUI numbers are assigned to vendors and form the first three octets of device MAC addresses. The MAC OUI numbers for VoIP equipment can be configured on the switch so that traffic from these devices is recognized as VoIP. Use the Traffic > VoIP (Configure OUI) page to configure this feature.

Parameters

These parameters are displayed:

- ♦ **Telephony OUI** – Specifies a MAC address range to add to the list. (Format: xx-xx-xx-xx-xx-xx)
- ♦ **Mask** – Identifies a range of MAC addresses. Setting a mask of FF-FF-FF-00-00-00 identifies all devices with the same OUI (the first three octets). Other masks restrict the MAC address range. Setting a mask of FF-FF-FF-FF-FF-FF specifies a single MAC address. (Format: xx-xx-xx-xx-xx-xx or xxxxxxxxxxxx; Default: FF-FF-FF-00-00-00)
- ♦ **Description** – User-defined text that identifies the VoIP devices.

Web Interface

To configure MAC OUI numbers for VoIP equipment:

1. Click **Traffic > VoIP**.
2. Select Configure OUI from the Step list.
3. Select Add from the Action list.
4. Enter a MAC address that specifies the OUI for VoIP devices in the network.
5. Select a mask from the pull-down list to define a MAC address range.
6. Enter a description for the devices.
7. Click **Apply**.

Traffic > VoIP

Step: 2. Configure OUI Action: Add

Telephony OUI: 00-e0-bb-00-00-00 (xx-xx-xx-xx-xx-xx or xxxxxxxxxxxx)

Mask: ff-ff-ff-00-00-00 (xx-xx-xx-xx-xx-xx or xxxxxxxxxxxx)

Description: old phones

Apply Revert

To show the MAC OUI numbers used for VoIP equipment:

1. Click **Traffic > VoIP**.
2. Select Configure OUI from the Step list.
3. Select Show from the Action list.

Traffic > VoIP

Step: 2. Configure OUI Actions: Show

Telephony OUI List Total: 3

<input type="checkbox"/>	Telephony OUI	Mask	Description
<input type="checkbox"/>	00-E0-BB-00-00-00	FF-FF-FF-00-00-00	old phones
<input type="checkbox"/>	00-11-22-33-44-55	FF-FF-FF-00-00-00	new phones
<input type="checkbox"/>	00-98-76-54-32-10	FF-FF-FF-FF-FF-FF	Chris' phone

Delete Revert

Port Settings

Use the Traffic > VoIP (Configure Interface) page to configure ports for VoIP traffic, you need to set the mode (Auto or Manual), specify the discovery method to use, and set the traffic priority. You can also enable security filtering to ensure that only VoIP traffic is forwarded on the Voice VLAN.

Command Usage

All ports are set to VLAN hybrid mode by default. Prior to enabling VoIP for a port (by setting the VoIP mode to Auto or Manual as described below), first ensure that VLAN membership is not set to access mode.

Parameters

These parameters are displayed:

- ♦ **Mode** – Specifies if the port will be added to the Voice VLAN when VoIP traffic is detected. (Default: None)
 - ♦ **None** – The Voice VLAN feature is disabled on the port. The port will not detect VoIP traffic or be added to the Voice VLAN.
 - ♦ **Auto** – The port will be added as a tagged member to the Voice VLAN when VoIP traffic is detected on the port. You must select a method for detecting VoIP traffic, either OUI or 802.1AB (LLDP). When OUI is selected, be sure to configure the MAC address ranges in the Telephony OUI list.
 - ♦ **Manual** – The Voice VLAN feature is enabled on the port, but the port must be manually added to the Voice VLAN.
- ♦ **Security** – Enables security filtering that discards any non-VoIP packets received on the port that are tagged with the voice VLAN ID. VoIP traffic is identified by source MAC addresses configured in the Telephony OUI list, or through LLDP that discovers VoIP devices attached to the switch. Packets received from non-VoIP sources are dropped. (Default: Disabled)
- ♦ **Discovery Protocol** – Selects a method to use for detecting VoIP traffic on the port. (Default: OUI)
 - ♦ **OUI** – Traffic from VoIP devices is detected by the Organizationally Unique Identifier (OUI) of the source MAC address. OUI numbers are assigned to vendors and form the first three octets of a device MAC address. MAC address OUI numbers must be configured in the Telephony OUI list so that the switch recognizes the traffic as being from a VoIP device.

- ◆ **LLDP** – Uses LLDP (IEEE 802.1AB) to discover VoIP devices attached to the port. LLDP checks that the “telephone bit” in the system capability TLV is turned on. See Link Layer Discovery Protocol for more information on LLDP.
- ◆ **Priority** – Defines a CoS priority for port traffic on the Voice VLAN. The priority of any received VoIP packet is overwritten with the new priority when the Voice VLAN feature is active for the port. (Range: 0-6; Default: 6)
- ◆ **Remaining Age** – Number of minutes before this entry is aged out. The Remaining Age starts to count down when the OUI’s MAC address expires from the MAC address table. Therefore, the MAC address aging time should be added to the overall aging time. For example, if you configure the MAC address table aging time to 30 seconds, and the voice VLAN aging time to 5 minutes, then after 5.5 minutes, a port will be removed from voice VLAN when VoIP traffic is no longer received on the port. Alternatively, if you clear the MAC address table manually, then the switch will also start counting down the Remaining Age.

When VoIP Mode is set to Auto, the Remaining Age will be displayed. Otherwise, if the VoIP Mode is Disabled or set to Manual, the remaining age will display “NA.”

Web Interface

To configure VoIP traffic settings for a port:

1. Click **Traffic > VoIP**.
2. Select Configure Interface from the Step list.
3. Configure any required changes to the VoIP settings each port.
4. Click **Apply**.

Traffic > VoIP					
Step: 3. Configure Interface					
VoIP Port List Total: 28					
Port	Mode	Security	Discovery Protocol	Priority (0-6)	Remaining Age (minutes)
1	None	<input type="checkbox"/> Enabled	<input checked="" type="checkbox"/> OUI <input type="checkbox"/> LLDP	6	NA
2	None	<input type="checkbox"/> Enabled	<input checked="" type="checkbox"/> OUI <input type="checkbox"/> LLDP	6	NA
3	None	<input type="checkbox"/> Enabled	<input checked="" type="checkbox"/> OUI <input type="checkbox"/> LLDP	6	NA
4	None	<input type="checkbox"/> Enabled	<input checked="" type="checkbox"/> OUI <input type="checkbox"/> LLDP	6	NA
5	None	<input type="checkbox"/> Enabled	<input checked="" type="checkbox"/> OUI <input type="checkbox"/> LLDP	6	NA

This Page Intentionally Left Blank

Chapter 14

Security Measures

Overview

You can configure this switch to authenticate users logging into the system for management access using local or remote authentication methods. Port-based authentication using IEEE 802.1X can also be configured to control either management access to the uplink ports or client access to the data ports. This switch provides secure network management access using the following options:

- ◆ *AAA (Authentication, Authorization and Accounting)* – Use local or remote authentication to configure access rights, specify authentication servers, configure remote authentication and accounting.
- ◆ *User Accounts* – Manually configure access rights on the switch for specified users.
- ◆ *Web Authentication* – Allows stations to authenticate and access the network in situations where 802.1X or Network Access authentication methods are infeasible or impractical.
- ◆ *Network Access (MAC Address Authentication) (MAC Address Authentication)* – Configure MAC authentication, intrusion response, dynamic VLAN assignment, and dynamic QoS assignment.
- ◆ *HTTPS* – Provide a secure web connection.
- ◆ *SSH* – Provide a secure shell (for secure Telnet access).
- ◆ *ACL (Access Control Lists)* – Access Control Lists provide packet filtering for IP frames (based on address, protocol, Layer 4 protocol port number or TCP control code).
- ◆ *IP Filter* – Filters management access to the web, SNMP or Telnet interface.
- ◆ *Port Security* – Configure secure addresses for individual ports.
- ◆ *Port Authentication* – Use IEEE 802.1X port authentication to control access to specific ports.
- ◆ *DoS Protection* – Protects against Denial-of-Service attacks.
- ◆ *DHCP Snooping* – Filter IP traffic on insecure ports for which the source address cannot be identified via DHCP snooping.

- ◆ *DHCPv6 Snooping* – Filter IPv6 traffic on insecure ports for which the source address cannot be identified via DHCPv6 snooping.
- ◆ *ND Snooping* – Maintains an IPv6 prefix table and user address binding table. These tables can be used for stateless address auto-configuration or for address filtering by IPv6 Source Guard.
- ◆ *IPv4 Source Guard* – Filters IPv4 traffic on insecure ports for which the source address cannot be identified via DHCPv4 snooping nor static source bindings.
- ◆ *IPv6 Source Guard* – Filters IPv6 traffic on insecure ports for which the source address cannot be identified via ND snooping, DHCPv6 snooping, nor static source bindings.
- ◆ *ARP Inspection* – Security feature that validates the MAC Address bindings for Address Resolution Protocol packets. Provides protection against ARP traffic with invalid MAC to IP Address bindings, which forms the basis for certain “man-in-the-middle” attacks.
- ◆ *Application Filter* – Discards CDP or PVST packets.

Note: The priority of execution for the filtering commands is Port Security, Port Authentication, Network Access, Web Authentication, Access Control Lists, IP Source Guard, and then DHCP Snooping.

AAA

The authentication, authorization, and accounting (AAA) feature provides the main framework for configuring access control on the switch. The three security functions can be summarized as follows:

- ◆ Authentication — Identifies users that request access to the network.
- ◆ Authorization — Determines if users can access specific services.
- ◆ Accounting — Provides reports, auditing, and billing for services that users have accessed on the network.

The AAA functions require the use of configured RADIUS or TACACS+ servers in the network. The security servers can be defined as sequential groups that are applied as a method for controlling user access to specified services. For example, when the switch attempts to authenticate a user, a request is sent to the first server in the defined group, if there is no response the second server will be tried, and so on. If at any point a pass or fail is returned, the process stops.

The switch supports the following AAA features:

- ◆ Accounting for IEEE 802.1X authenticated users that access the network through the switch.
- ◆ Accounting for users that access management interfaces on the switch through the console and Telnet.
- ◆ Accounting for commands that users enter at specific CLI privilege levels.
- ◆ Authorization of users that access management interfaces on the switch through the console and Telnet.

To configure AAA on the switch, you need to follow this general process:

1. Configure RADIUS and TACACS+ server access parameters.
2. Define RADIUS and TACACS+ server groups to support the accounting and authorization of services.
3. Define a method name for each service to which you want to apply accounting or authorization and specify the RADIUS or TACACS+ server groups to use.
4. Apply the method names to port or line interfaces.

Note: This guide assumes that RADIUS and TACACS+ servers have already been configured to support AAA. The configuration of RADIUS and TACACS+ server software is beyond the scope of this guide, refer to the

documentation provided with the RADIUS or TACACS+ server software.

Configuring Local/Remote Logon Authentication

Use the Security > AAA > System Authentication page to specify local or remote authentication. Local authentication restricts management access based on user names and passwords manually configured on the switch. Remote authentication uses a remote access authentication server based on RADIUS or TACACS+ protocols to verify management access.

Command Usage

- ◆ By default, management access is always checked against the authentication database stored on the local switch. If a remote authentication server is used, you must specify the authentication sequence. Then specify the corresponding parameters for the remote authentication protocol using the Security > AAA > Server page. Local and remote logon authentication control management access via the console port, web browser, or Telnet.
- ◆ You can specify up to three authentication methods for any user to indicate the authentication sequence. For example, if you select (1) RADIUS, (2) TACACS and (3) Local, the user name and password on the RADIUS server is verified first. If the RADIUS server is not available, then authentication is attempted using the TACACS+ server, and finally the local user name and password is checked.

Parameters

These parameters are displayed:

- ◆ **Authentication Sequence** – Select the authentication, or authentication sequence required:
 - ◆ **Local** – User authentication is performed only locally by the switch.
 - ◆ **RADIUS** – User authentication is performed using a RADIUS server only.
 - ◆ **TACACS** – User authentication is performed using a TACACS+ server only.
 - ◆ [authentication sequence] – User authentication is performed by up to three authentication methods in the indicated sequence.

Web Interface

To configure the method(s) of controlling management access:

1. Click **Security > AAA > System Authentication**.
2. Specify the authentication sequence (i.e., one to three methods).
3. Click **Apply**.



Configuring Remote Logon Authentication Servers

Use the Security > AAA > Server page to configure the message exchange parameters for RADIUS or TACACS+ remote access authentication servers.

Remote Authentication Dial-in User Service (RADIUS) and Terminal Access Controller Access Control System Plus (TACACS+) are logon authentication protocols that use software running on a central server to control access to RADIUS-aware or TACACS-aware devices on the network. An authentication server contains a database of multiple user name/password pairs with associated privilege levels for each user that requires management access to the switch.

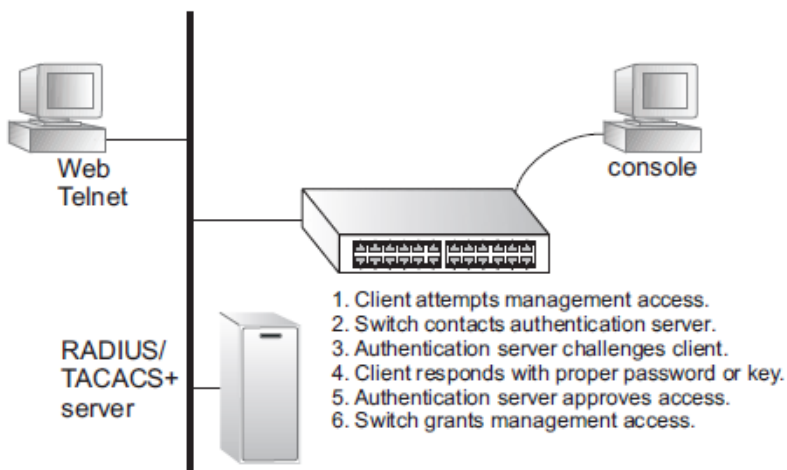

RADIUS uses UDP while TACACS+ uses TCP. UDP only offers best effort delivery, while TCP offers a more reliable connection-oriented transport. Also,

note that RADIUS encrypts only the password in the access-request packet from the client to the server, while TACACS+ encrypts the entire body of the packet.

Command Usage

- ◆ If a remote authentication server is used, you must specify the message exchange parameters for the remote authentication protocol. Both local and remote logon authentication control management access via the console port, web browser, or Telnet.
- ◆ RADIUS and TACACS+ logon authentication assign a specific privilege level for each user name/password pair. The user name, password, and privilege level must be configured on the authentication server. The encryption methods used for the authentication process must also be configured or negotiated between the authentication server and logon client. This switch can pass authentication messages between the server and client that have been encrypted using MD5 (Message-Digest 5), TLS (Transport Layer Security), or TTLS (Tunneled Transport Layer Security).

Parameters

These parameters are displayed:

Configure Server

- ◆ **RADIUS**
 - ◆ **Global** – Provides globally applicable RADIUS settings.
 - ◆ **Server Index** – Specifies one of five RADIUS servers that may be configured. The switch attempts authentication using the listed sequence of servers. The process ends when a server either approves or denies access to a user.
 - ◆ **Server IP Address** – Address of authentication server. (A Server Index entry must be selected to display this item.)
 - ◆ **Accounting Server UDP Port** – Network (UDP) port on authentication server used for accounting messages. (Range: 1-65535; Default: 1813)
 - ◆ **Authentication Server UDP Port** – Network (UDP) port on authentication server used for authentication messages. (Range: 1-65535; Default: 1812)
 - ◆ **Authentication Timeout** – The number of seconds the switch waits for a reply from the RADIUS server before it resends the request. (Range: 1-10; Default: 5)

- ◆ **Authentication Retries** – Number of times the switch tries to authenticate logon access via the authentication server. (Range: 1-5; Default: 3)
- ◆ **Set Key** – Mark this box to set or modify the encryption key.
- ◆ **Authentication Key** – Encryption key used to authenticate logon access for client. Enclose any string containing blank spaces in double quotes. (Maximum length: 48 characters)
- ◆ **Confirm Authentication Key** – Re-type the string entered in the previous field to ensure no errors were made. The switch will not change the encryption key if these two fields do not match.
- ◆ **TACACS+**
 - ◆ **Global** – Provides globally applicable TACACS+ settings.
 - ◆ **Server Index** – Specifies one of five TACACS+ servers that may be configured. The switch attempts authentication using the listed sequence of servers. The process ends when a server either approves or denies access to a user.
 - ◆ **Server IP Address** – Address of the TACACS+ server. (A Server Index entry must be selected to display this item.)
 - ◆ **Authentication Server TCP Port** – Network (TCP) port of TACACS+ server used for authentication messages. (Range: 1-65535; Default: 49)
 - ◆ **Authentication Timeout** – The number of seconds the switch waits for a reply from the TACACS+ server before it resends the request. (Range: 1-10; Default: 5)
 - ◆ **Authentication Retries** – Number of times the switch tries to authenticate logon access via the authentication server. (Range: 1-5; Default: 3)
 - ◆ **Set Key** – Mark this box to set or modify the encryption key.
 - ◆ **Authentication Key** – Encryption key used to authenticate logon access for client. Enclose any string containing blank spaces in double quotes. (Maximum length: 48 characters)
 - ◆ **Confirm Authentication Key** – Re-type the string entered in the previous field to ensure no errors were made. The switch will not change the encryption key if these two fields do not match.

Configure Group

- ◆ **Server Type** – Select RADIUS or TACACS+ server.
- ◆ **Group Name** - Defines a name for the RADIUS or TACACS+ server group. (Range: 1-64 characters)

- ◆ **Sequence at Priority** - Specifies the server and sequence to use for the group. (Range: 1-5)
When specifying the priority sequence for a sever, the server index must already be defined.

Web Interface

To configure the parameters for RADIUS or TACACS+ authentication:

1. Click **Security > AAA > Server**.
2. Select Configure Server from the Step list.
3. Select RADIUS or TACACS+ server type.
4. Select Global to specify the parameters that apply globally to all specified servers, or select a specific Server Index to specify the parameters that apply to a specific server.
5. To set or modify the authentication key, mark the Set Key box, enter the key, and then confirm it.
6. Click **Apply**.

Configuring Remote Authentication Server (RADIUS)

Security > AAA > Server

Step: 1. Configure Server

Server Type RADIUS TACACS+

Global | Server Index: 1 2 3 4 5

Server IP Address

Accounting Server UDP Port (1-65535)

Authentication Server UDP Port (1-65535)

Authentication Timeout (1-65535) sec

Authentication Retries (1-30)

Set Key

Authentication Key

Confirm Authentication Key

Configuring Remote Authentication Server (TACACS+)

Security > AAA > Server

Step: 1. Configure Server

Server Type RADIUS TACACS+

Global | Server Index: 1 2 3 4 5

Server IP Address

Authentication Server TCP Port (1-65535)

Authentication Timeout (1-640) sec

Authentication Retries (1-30)

Set Key

Authentication Key

Confirm Authentication Key

Apply Revert

To configure the RADIUS or TACACS+ server groups to use for accounting and authorization:

1. Click **Security > AAA > Server**.
2. Select Configure Group from the Step list.
3. Select Add from the Action list.
4. Select RADIUS or TACACS+ server type.
5. Enter the group name, followed by the index of the server to use for each priority level.
6. Click **Apply**.

Security > AAA > Server

Step: 2. Configure Group Action: Add

Server Type RADIUS TACACS+

RADIUS Group Name

Sequence At Priority 1

Sequence At Priority 2

Sequence At Priority 3

Sequence At Priority 4

Sequence At Priority 5

Apply Revert

To show the RADIUS or TACACS+ server groups used for accounting and authorization:

1. Click **Security > AAA > Server**.
2. Select Configure Group from the Step list.

3. Select Show from the Action list.

Security > AAA > Server

Step: 2. Configure Group Action: Show

Server Type: RADIUS TACACS+

RADIUS Group List Total: 3

<input type="checkbox"/>	Group Name	Member Index
<input type="checkbox"/>	radius	1, 2, 3, 5
<input type="checkbox"/>	radius1	3, 5, 1
<input type="checkbox"/>	radius2	1, 2, 5

Delete Revert

Configuring AAA Accounting

Use the Security > AAA > Accounting page to enable accounting of requested services for billing or security purposes, and also to display the configured accounting methods, the methods applied to specific interfaces, and basic accounting information recorded for user sessions.

Command Usage

AAA authentication through a RADIUS or TACACS+ server must be enabled before accounting is enabled.

Parameters

These parameters are displayed:

Configure Global

- ◆ **Periodic Update** - Specifies the interval at which the local accounting service updates information for all users on the system to the accounting server. (Range: 1-2147483647 minutes)

Configure Method

- ◆ **Accounting Type** – Specifies the service as:
 - ◆ **802.1X** – Accounting for end users.
 - ◆ **Command** – Administrative accounting to apply to commands entered at specific CLI privilege levels.
 - ◆ **Exec** – Administrative accounting for local console, Telnet, or SSH connections.
- ◆ **Privilege Level** – The CLI privilege levels (0-15). This parameter only applies to Command accounting.

- ◆ **Method Name** – Specifies an accounting method for service requests. The “default” methods are used for a requested service if no other methods have been defined. (Range: 1-64 characters)

Note that the method name is only used to describe the accounting method configured on the specified RADIUS or TACACS+ servers. No information is sent to the servers about the method to use.

- ◆ **Accounting Notice** – Records user activity from log-in to log-off point.
- ◆ **Server Group Name** - Specifies the accounting server group. (Range: 1-64 characters)

The group names “radius” and “tacacs+” specifies all configured RADIUS and TACACS+ hosts. Any other group name refers to a server group configured on the Security > AAA > Server (Configure Group) page.

Configure Service

- ◆ **Accounting Type** – Specifies the service as 802.1X, Command or Exec as described in the preceding section..

- ◆ **802.1X**

- ◆ **Method Name** – Specifies a user defined accounting method to apply to an interface. This method must be defined in the Configure Method page. (Range: 1-64 characters)

- ◆ **Command**

- ◆ **Privilege Level** – The CLI privilege levels (0-15).
- ◆ **Console Method Name** – Specifies a user-defined method name to apply to commands entered at the specified CLI privilege level through the console interface.
- ◆ **VTY Method Name** – Specifies a user-defined method name to apply to commands entered at the specified CLI privilege level through Telnet or SSH.

- ◆ **Exec**

- ◆ **Console Method Name** – Specifies a user defined method name to apply to console connections.
- ◆ **VTY Method Name** – Specifies a user defined method name to apply to Telnet and SSH connections.

Show Information – Summary

- ◆ **Accounting Type** - Displays the accounting service.
- ◆ **Method Name** - Displays the user-defined or default accounting method.
- ◆ **Server Group Name** - Displays the accounting server group.

- ♦ **Interface** - Displays the port, console or Telnet interface to which these rules apply. (This field is null if the accounting method and associated server group has not been assigned to an interface.)

Show Information – Statistics

- ♦ **User Name** - Displays a registered user name.
- ♦ **Accounting Type** - Displays the accounting service.
- ♦ **Interface** - Displays the receive port number through which this user accessed the switch.
- ♦ **Time Elapsed** - Displays the length of time this entry has been active.

Web Interface

To configure global settings for AAA accounting:

1. Click **Security > AAA > Accounting**.
2. Select Configure Global from the Step list.
3. Enter the required update interval.
4. Click **Apply**.

The screenshot shows a web interface window titled "Security > AAA > Accounting". Below the title bar, there is a "Step:" dropdown menu currently set to "1. Configure Global". Below this, there is a checkbox labeled "Periodic Update (1-2147483647)" which is checked, followed by a text input field containing the number "1" and the unit "min". At the bottom right of the window, there are two buttons: "Apply" and "Revert".

To configure the accounting method applied to various service types and the assigned server group:

1. Click **Security > AAA > Accounting**.
2. Select Configure Method from the Step list.
3. Select Add from the Action list.
4. Select the accounting type (802.IX, Command, Exec).
5. Specify the name of the accounting method and server group name.
6. Click **Apply**.

Security > AAA > Accounting

Step: 2. Configure Method Action: Add

Accounting Type: 802.1X

Method Name: default

Accounting Notice: Start-Stop

Server Group Name: radius

Apply Revert

To show the accounting method applied to various service types and the assigned server group:

1. Click **Security > AAA > Accounting**.
2. Select Configure Method from the Step list.
3. Select Show from the Action list.

Security > AAA > Accounting

Step: 2. Configure Method Action: Show

Method List Total: 10

<input type="checkbox"/>	Accounting Type	Method Name	Accounting Notice	Server Group Name
<input type="checkbox"/>	802.1X	default	Start-Stop	radius
<input type="checkbox"/>	Command 0	default	Start-Stop	tacacs+
<input type="checkbox"/>	Command 1	default	Start-Stop	tacacs+
<input type="checkbox"/>	Command 2	default	Start-Stop	tacacs+
<input type="checkbox"/>	Command 3	default	Start-Stop	tacacs+
<input type="checkbox"/>	Command 4	default	Start-Stop	tacacs+
<input type="checkbox"/>	Command 5	default	Start-Stop	tacacs+
<input type="checkbox"/>	Command 6	default	Start-Stop	tacacs+
<input type="checkbox"/>	Command 7	default	Start-Stop	tacacs+
<input type="checkbox"/>	Command 8	default	Start-Stop	tacacs+

Delete Revert

To configure the accounting method applied to specific interfaces, console commands entered at specific privilege levels, and local console, Telnet, or SSH connections:

1. Click **Security > AAA > Accounting**.
2. Select Configure Service from the Step list.
3. Select the accounting type (802.1X, Command, Exec).
4. Enter the required accounting method.
5. Click **Apply**.

Configuring AAA Accounting Service for 802.1X Service

Security > AAA > Accounting

Step: 3. Configure Service

Accounting Type 802.1X Command EXEC

Port Method List Total: 26

Port	Method Name
1	<input type="text"/>
2	<input type="text"/>
3	<input type="text"/>
6	<input type="text"/>
7	<input type="text"/>

Configuring AAA Accounting Service for Command Service

Security > AAA > Accounting

Step: 3. Configure Service

Accounting Type 802.1X Command EXEC

Command Method List Total: 16

Privilege Level	Console Method Name	VTY Method Name
0	<input type="text" value="default"/>	<input type="text" value="default"/>
1	<input type="text" value="default"/>	<input type="text" value="default"/>
2	<input type="text" value="default"/>	<input type="text" value="default"/>
3	<input type="text" value="default"/>	<input type="text" value="default"/>
4	<input type="text" value="command4Method"/>	<input type="text" value="default"/>
5	<input type="text" value="default"/>	<input type="text" value="command5Method"/>

Configuring AAA Accounting Service for Exec Service

Security > AAA > Accounting

Step: 3. Configure Service

Accounting Type 802.1X Command EXEC

Console Method Name

VTY Method Name

To display a summary of the configured accounting methods and assigned server groups for specified service types:

1. Click **Security > AAA > Accounting**.
2. Select Show Information from the Step list.
3. Click **Summary**.

The screenshot shows the 'Security > AAA > Accounting' page. The 'Step' dropdown is set to '4. Show information'. The 'Summary' radio button is selected. Below the navigation, the 'Method List' table is displayed with a total of 18 entries. The table has four columns: Accounting Type, Method Name, Server Group Name, and Interface.

Accounting Type	Method Name	Server Group Name	Interface
802.1X	default	radius	
Command 0	default	tacacs+	
Command 1	default	tacacs+	
Command 2	default	tacacs+	
Command 3	default	tacacs+	
Command 4	default	tacacs+	
Command 5	default	tacacs+	
Command 6	default	tacacs+	
Command 7	default	tacacs+	
Command 8	default	tacacs+	

To display basic accounting information and statistics recorded for user sessions:

1. Click **Security > AAA > Accounting**.
2. Select Show Information from the Step list.
3. Click **Statistics**.

The screenshot shows the 'Security > AAA > Accounting' page. The 'Step' dropdown is set to '4. Show information'. The 'Statistics' radio button is selected. Below the navigation, the 'Accounting Statistics' table is displayed with a total of 2 entries. The table has four columns: User Name, Accounting Type, Interface, and Time Elapsed.

User Name	Accounting Type	Interface	Time Elapsed
Bob	802.1X	Eth1/1	3:44:55
Ted	802.1X	Eth1/5	1:24:51

Configuring AAA Authorization

Use the Security > AAA > Authorization page to enable authorization of requested services, and also to display the configured authorization methods, and the methods applied to specific interfaces.

Command Usage

- ◆ This feature performs authorization to determine if a user is allowed to run an Exec shell.
- ◆ AAA authentication through a RADIUS or TACACS+ server must be enabled before authorization is enabled.

Parameters

These parameters are displayed:

Configure Method

- ◆ **Authorization Type** – Specifies the service as:
 - ◆ **Command** – Administrative authorization to apply to commands entered at specific CLI privilege levels.
 - ◆ **Exec** – Administrative authorization for local console, Telnet, or SSH connections.
- ◆ **Method Name** – Specifies an authorization method for service requests. The “default” method is used for a requested service if no other methods have been defined. (Range: 1-64 characters)
- ◆ **Server Group Name** - Specifies the authorization server group. (Range: 1-64 characters)
The group name “tacacs+” specifies all configured TACACS+ hosts. Any other group name refers to a server group configured on the TACACS+ Group Settings page. Authorization is only supported for TACACS+ servers.

Configure Service

- ◆ **Authorization Type** – Specifies the service as Exec, indicating administrative authorization for local console, Telnet, or SSH connections.
- ◆ **Console Method Name** – Specifies a user defined method name to apply to console connections.
- ◆ **VTY Method Name** – Specifies a user defined method name to apply to Telnet and SSH connections.

Show Information

- ◆ **Authorization Type** - Displays the authorization service.
- ◆ **Method Name** - Displays the user-defined or default accounting method.
- ◆ **Server Group Name** - Displays the authorization server group.
- ◆ **Interface** - Displays the console or Telnet interface to which these rules apply. (This field is null if the authorization method and associated server group has not been assigned to an interface.)

Web Interface

To configure the authorization method applied to the Exec service type and the assigned server group:

1. Click **Security > AAA > Authorization**.
2. Select Configure Method from the Step list.
3. Specify the name of the authorization method and server group name.
4. Click **Apply**.

Security > AAA > Authorization

Step: 1. Configure Method Action: Add

Authorization Type: EXEC

Method Name: default

Server Group Name: tacacs+

Apply Revert

To show the authorization method applied to the EXEC service type and the assigned server group:

1. Click **Security > AAA > Authorization**.
2. Select Configure Method from the Step list.
3. Select Show from the Action list.

Security > AAA > Authorization

Step: 1. Configure Method Action: Show

Method List Total: 2

<input type="checkbox"/>	Authorization Type	Method Name	Server Group Name
<input type="checkbox"/>	EXEC	default	tacacs+
<input type="checkbox"/>	EXEC	aaa	tacacs1

Delete Revert

To configure the authorization method applied to local console, Telnet, or SSH connections:

1. Click **Security > AAA > Authorization**.
2. Select Configure Service from the Step list.
3. Enter the required authorization method.
4. Click **Apply**.

Security > AAA > Authorization

Step: 2. Configure Service

Authorization Type: EXEC

Console Method Name: tps-auth

VTY Method Name: tps-auth

Apply Revert

To display a the configured authorization method and assigned server groups for The Exec service type:

1. Click **Security > AAA > Authorization**.
2. Select Show Information from the Step list.

Security > AAA > Authorization

Step: 3. Show Information

Method List Total: 3

Authorization Type	Method Name	Server Group Name	Interface
EXEC	default	tacacs+	
EXEC	console	tacacs+	Console
EXEC	telnet	tacacs+	Telnet

User Accounts

Use the Security > User Accounts page to control management access to the switch based on manually configured user names and passwords.

Command Usage

- ♦ The default guest name is “guest” with the password “guest.” The default administrator name is “admin” with the password “admin.”
- ♦ The guest only has read access for most configuration parameters. However, the administrator has write access for all parameters governing the onboard agent. You should therefore assign a new administrator password as soon as possible, and store it in a safe place.

Parameters

These parameters are displayed:

- ♦ **User Name** – The name of the user. (Maximum length: 32 characters; maximum number of users: 16)
- ♦ **Access Level** – Specifies command access privileges. (Range: 0-15)
Level 0, 8 and 15 are designed for users (guest), managers (network maintenance), and administrators (top-level access). The other levels can be used to configured specialized access profiles.

Level 0-7 provide the same default access to a limited number of commands which display the current status of the switch, as well as several database clear and reset functions. These commands are equivalent to those available under Normal Exec command mode in the CLI.

Level 8-14 provide the same default access privileges, including additional commands beyond those provided for Levels 0-7 (equivalent to CLI Normal Exec command mode), and a subset of the configuration commands provided for Level 15 (equivalent to CLI Privileged Exec command mode).

Level 15 provides full access to all commands.

The privilege level associated with any command can be changed using the “privilege” command described in the *CLI Reference Guide*.

Any privilege level can access all of the commands assigned to lower privilege levels. For example, privilege level 8 can access all commands assigned to privilege levels 7-0 according to default settings, and to any other commands assigned to levels 7-0 using the “privilege” command described in the *CLI Reference Guide*.

- ◆ **Password Type** – Specifies the following options:
 - ◆ **No Password** – No password is required for this user to log in.
 - ◆ **Plain Password** – Plain text unencrypted password.
 - ◆ **Encrypted Password** – Encrypted password.
The encrypted password is required for compatibility with legacy password settings (i.e., plain text or encrypted) when reading the configuration file during system bootup or when downloading the configuration file from a TFTP or FTP server. There is no need for you to manually configure encrypted passwords.
- ◆ **Password** – Specifies the user password. (Range: 0-32 characters, case sensitive)
- ◆ **Confirm Password** – Re-type the string entered in the previous field to ensure no errors were made. The switch will not change the password if these two fields do not match.

Web Interface

To configure user accounts:

1. Click **Security > User Accounts**.
2. Select Add or Modify from the Action list.
3. Specify or select a user name, select the user's access level, then enter a password if required and confirm it.
4. Click **Apply**.

Security > User Accounts

Action: Add ▾

User Name: bob

Access Level: 0 ▾

Password Type: Encrypted Password ▾

Password: *****

Confirm Password: *****

Apply Revert

To show user accounts:

1. Click **Security > User Accounts**.
2. Select Show from the Action list.

Security > User Accounts

Action:

User Account List Total: 3

<input type="checkbox"/>	User Name	Access Level
<input type="checkbox"/>	admin	15
<input type="checkbox"/>	guest	0
<input type="checkbox"/>	bob	15

Web Authentication

Web authentication allows stations to authenticate and access the network in situations where 802.1X or Network Access authentication are infeasible or impractical. The web authentication feature allows unauthenticated hosts to request and receive a DHCP assigned IP address and perform DNS queries. All other traffic, except for HTTP protocol traffic, is blocked. The switch intercepts HTTP protocol traffic and redirects it to a switch-generated web page that facilitates user name and password authentication via RADIUS. Once authentication is successful, the web browser is forwarded on to the originally requested web page. Successful authentication is valid for all hosts connected to the port.

Note:

- ♦ RADIUS authentication must be activated and configured properly for the web authentication feature to work properly.
 - ♦ Web authentication cannot be configured on trunk ports.
-

Configuring Global Settings for Web Authentication

Use the Security > Web Authentication (Configure Global) page to edit the global parameters for web authentication.

Parameters

These parameters are displayed:

- ♦ **Web Authentication Status** – Enables web authentication for the switch. (Default: Disabled)
Note that this feature must also be enabled for any port where required under the Configure Interface menu.
- ♦ **Session Timeout** – Configures how long an authenticated session stays active before it must re-authenticate itself. (Range: 300-3600 seconds; Default: 3600 seconds)
- ♦ **Quiet Period** – Configures how long a host must wait to attempt authentication again after it has exceeded the maximum allowable failed login attempts. (Range: 1-180 seconds; Default: 60 seconds)
- ♦ **Login Attempts** – Configures the amount of times a supplicant may attempt and fail authentication before it must wait the configured quiet period. (Range: 1-3 attempts; Default: 3 attempts)

Web Interface

To configure global parameters for web authentication:

1. Click **Security > Web Authentication**.
2. Select Configure Global from the Step list.
3. Enable web authentication globally on the switch, and adjust any of the protocol parameters as required.
4. Click **Apply**.

Configuring Interface Settings for Web Authentication

Use the Security > Web Authentication (Configure Interface) page to enable web authentication on a port, and display information for any connected hosts.

Parameters

These parameters are displayed:

- ◆ **Port** – Indicates the port being configured.
- ◆ **Status** – Configures the web authentication status for the port.
- ◆ **Host IP Address** – Indicates the IP address of each connected host.
- ◆ **Remaining Session Time** – Indicates the remaining time until the current authorization session for the host expires.
- ◆ **Apply** – Enables web authentication if the Status box is checked.
- ◆ **Revert** – Restores the previous configuration settings.
- ◆ **Re-authenticate** – Ends all authenticated web sessions for selected host IP addresses in the Authenticated Host List, and forces the users to re-authenticate.
- ◆ **Revert** – Restores the previous configuration settings.

Web Interface

To enable web authentication for a port:

1. Click **Security > Web Authentication**.
2. Select Configure Interface from the Step list.
3. Set the status box to enabled for any port that requires web authentication, and click **Apply**.
4. Mark the check box for any host addresses that need to be re-authenticated, and click **Re-authenticate**.

Security > Web Authentication

Steps: 2. Configure Interface

Port: 1

Status: Enabled

Apply Revert

Authenticated Host List Total 2

<input type="checkbox"/>	Host IP Address	Remaining Session Time (sec)
<input type="checkbox"/>	10.1.1.1	300
<input type="checkbox"/>	10.2.2.2	100

Re-authenticate Revert

Network Access (MAC Address Authentication)

Some devices connected to switch ports may not be able to support 802.1X authentication due to hardware or software limitations. This is often true for devices such as network printers, IP phones, and some wireless access points. The switch enables network access from these devices to be controlled by authenticating device MAC addresses with a central RADIUS server.

Note:

- ◆ RADIUS authentication must be activated and configured properly for the MAC Address authentication feature to work properly.
 - ◆ MAC authentication cannot be configured on trunk ports.
-

Command Usage

- ◆ MAC address authentication controls access to the network by authenticating the MAC address of each host that attempts to connect to a switch port. Traffic received from a specific MAC address is forwarded by the switch only if the source MAC address is successfully authenticated by a central RADIUS server. While authentication for a MAC address is in progress, all traffic is blocked until authentication is completed. On successful authentication, the RADIUS server may optionally assign VLAN and quality of service settings for the switch port.
 - ◆ When enabled on a port, the authentication process sends a Password Authentication Protocol (PAP) request to a configured RADIUS server. The user name and password are both equal to the MAC address being authenticated. On the RADIUS server, PAP user name and passwords must be configured in the MAC address format XX-XX-XX-XX-XX-XX (all in upper case).
 - ◆ Authenticated MAC addresses are stored as dynamic entries in the switch secure MAC address table and are removed when the aging time expires. The maximum number of secure MAC addresses supported for the switch system is 1024.
 - ◆ Configured static MAC addresses are added to the secure address table when seen on a switch port. Static addresses are treated as authenticated without sending a request to a RADIUS server.
 - ◆ When port status changes to down, all MAC addresses mapped to that port are cleared from the secure MAC address table. Static VLAN assignments are not restored.
-

- ◆ The RADIUS server may optionally return a VLAN identifier list to be applied to the switch port. The following attributes need to be configured on the RADIUS server.

- ◆ **Tunnel-Type** = VLAN
- ◆ **Tunnel-Medium-Type** = 802
- ◆ **Tunnel-Private-Group-ID** = 1u,2t [*VLAN ID list*]

The VLAN identifier list is carried in the RADIUS “Tunnel-Private-Group-ID” attribute. The VLAN list can contain multiple VLAN identifiers in the format “1u,2t,3u” where “u” indicates an untagged VLAN and “t” a tagged VLAN.

- ◆ The RADIUS server may optionally return dynamic QoS assignments to be applied to a switch port for an authenticated user. The “Filter-ID” attribute (attribute 11) can be configured on the RADIUS server to pass the following QoS information:

Profile	Attribute Syntax	Example
DiffServ	service-policy-in = <i>policy-map-name</i>	service-policy-in=p1
Rate Limit	rate-limit-input = <i>rate</i>	rate-limit-input=100 (kbps)
	rate-limit-output = <i>rate</i>	rate-limit-output=200 (kbps)
802.1p	switchport-priority-default = <i>value</i>	switchport-priority-default=2
IP ACL	ip-access-group-in = <i>ip-acl-name</i>	ip-access-group-in=ipv4acl
IPv6 ACL	ipv6-access-group-in = <i>ipv6-acl-name</i>	ipv6-access-group-in=ipv6acl
MAC ACL	mac-access-group-in = <i>mac-acl-name</i>	mac-access-group-in=macAcl

- ◆ Multiple profiles can be specified in the Filter-ID attribute by using a semicolon to separate each profile.
For example, the attribute “service-policy-in=pp1;rate-limit-input=100” specifies that the diffserv profile name is “pp1,” and the ingress rate limit profile value is 100 kbps.
- ◆ If duplicate profiles are passed in the Filter-ID attribute, then only the first profile is used.
For example, if the attribute is “service-policy-in=p1;service-policy-in=p2”, then the switch applies only the DiffServ profile “p1.”
- ◆ Any unsupported profiles in the Filter-ID attribute are ignored.
For example, if the attribute is “map-ip-dscp=2:3;service-policy-in=p1,” then the switch ignores the “map-ip-dscp” profile.

- ◆ When authentication is successful, the dynamic QoS information may not be passed from the RADIUS server due to one of the following conditions (authentication result remains unchanged):
 - ◆ The Filter-ID attribute cannot be found to carry the user profile.
 - ◆ The Filter-ID attribute is empty.
 - ◆ The Filter-ID attribute format for dynamic QoS assignment is unrecognizable (can not recognize the whole Filter-ID attribute).
- ◆ Dynamic QoS assignment fails and the authentication result changes from success to failure when the following conditions occur:
 - ◆ Illegal characters found in a profile value (for example, a non-digital character in an 802.1p profile value).
 - ◆ Failure to configure the received profiles on the authenticated port.
- ◆ When the last user logs off on a port with a dynamic QoS assignment, the switch restores the original QoS configuration for the port.
- ◆ When a user attempts to log into the network with a returned dynamic QoS profile that is different from users already logged on to the same port, the user is denied access.
- ◆ While a port has an assigned dynamic QoS profile, any manual QoS configuration changes only take effect after all users have logged off the port.

Configuring Global Settings for Network Access

MAC address authentication is configured on a per-port basis, however there are two configurable parameters that apply globally to all ports on the switch. Use the Security > Network Access (Configure Global) page to configure MAC address authentication aging and reauthentication time.

Parameters

These parameters are displayed:

- ◆ **Aging Status** – Enables aging for authenticated MAC addresses stored in the secure MAC address table. (Default: Disabled)

This parameter applies to authenticated MAC addresses configured by the MAC Address Authentication process described in this section, as well as to any secure MAC addresses authenticated by 802.1X, regardless of the 802.1X Operation Mode (Single-Host, Multi-Host, or MAC-Based authentication).

Authenticated MAC addresses are stored as dynamic entries in the switch's secure MAC address table and are removed when the aging time expires.

The maximum number of secure MAC addresses supported for the switch system is 1024.

- ◆ **Reauthentication Time** – Sets the time period after which the switch removes an authenticated MAC address from the secure table. When the reauthentication time expires for a secure MAC address, it is removed from the secure MAC address table, and the switch will only perform the authentication process the next time it receives the MAC address packet. (Range: 120-1000000 seconds; Default: 1800 seconds)

Web Interface

To configure aging status and reauthentication time for MAC address authentication:

1. Click **Security > Network Access**.
2. Select Configure Global from the Step list.
3. Enable or disable aging for secure addresses, and modify the reauthentication time as required.
4. Click **Apply**.

The screenshot shows a web interface titled "Security > Network Access". Below the title is a "Step:" dropdown menu set to "1. Configure Global". The main configuration area includes an "Aging Status" section with a checked checkbox labeled "Enabled". Below that is a "Reauthentication Time (120-1000000)" field with a text input containing "30000" and a "sec" label. At the bottom right of the configuration area are two buttons: "Apply" and "Revert".

Configuring Network Access for Ports

Use the Security > Network Access (Configure Interface - General) page to configure MAC authentication on switch ports, including enabling address authentication, setting the maximum MAC count, and enabling dynamic VLAN or dynamic QoS assignments.

Parameters

These parameter are displayed:

- ◆ **MAC Authentication**
 - ◆ **Status** – Enables MAC authentication on a port. (Default: Disabled)
 - ◆ **Intrusion** – Sets the port response to a host MAC authentication failure to either block access to the port or to pass traffic through. (Options: Block, Pass; Default: Block)
 - ◆ **Max MAC Count**⁸ – Sets the maximum number of MAC addresses that can be authenticated on a port via MAC authentication; that is, the Network Access process described in this section. (Range: 1-1024; Default: 1024)
 - ◆ **Network Access Max MAC Count**⁸ – Sets the maximum number of MAC addresses that can be authenticated on a port interface via all forms of authentication (including Network Access and IEEE 802.1X). (Range: 1-2048; Default: 1024)
 - ◆ **Guest VLAN** – Specifies the VLAN to be assigned to the port when 802.1X Authentication or MAC authentication fails. (Range: 0-4094, where 0 means disabled; Default: Disabled)

The VLAN must already be created and active. Also, when used with 802.1X authentication, intrusion action must be set for “Guest VLAN”.

A port can only be assigned to the guest VLAN in case of failed authentication, and switchport mode is set to Hybrid.

Note: 8. The maximum number of MAC addresses per port is 1024, and the maximum number of secure MAC addresses supported for the switch system is 1024. When the limit is reached, all new MAC addresses are treated as authentication failures.

- ◆ **Dynamic VLAN** – Enables dynamic VLAN assignment for an authenticated port. When enabled, any VLAN identifiers returned by the RADIUS server through the 802.1X authentication process are applied to the port, providing the VLANs have already been created on the switch. (GVRP is not used to create the VLANs.) (Default: Enabled)

The VLAN settings specified by the first authenticated MAC address are implemented for a port. Other authenticated MAC addresses on the port must have the same VLAN configuration, or they are treated as authentication failures.

If dynamic VLAN assignment is enabled on a port and the RADIUS server returns no VLAN configuration (to the 802.1X authentication process), the

authentication is still treated as a success, and the host is assigned to the default untagged VLAN.

When the dynamic VLAN assignment status is changed on a port, all authenticated addresses mapped to that port are cleared from the secure MAC address table.

- ◆ **Dynamic QoS** – Enables dynamic QoS assignment for an authenticated port. (Default: Disabled)
- ◆ **MAC Filter ID** – Allows a MAC Filter to be assigned to the port. MAC addresses or MAC address ranges present in a selected MAC Filter are exempt from authentication on the specified port (as described under Configuring a MAC Address Filter). (Range: 1-64; Default: None)

Web Interface

To configure MAC authentication on switch ports:

1. Click **Security > Network Access**.
2. Select Configure Interface from the Step list.
3. Click the **General** button.
4. Make any configuration changes required to enable address authentication on a port, set the maximum number of secure addresses supported, the guest VLAN to use when MAC Authentication or 802.1X Authentication fails, and the dynamic VLAN and QoS assignments.
5. Click **Apply**.

Security > Network Access

Step: 2. Configure Interface

General Link Detection

Port List Total: 28

Port	MAC Authentication			Network Access Max MAC Count (1-2048)	Guest VLAN (0-4094, 0: Disabled)	Dynamic VLAN	Dynamic QoS	MAC Filter ID (1-64)
	Status	Intrusion	Max MAC Count (1-1024)					
1	<input type="checkbox"/> Enabled	Block	1024	1024	0	<input checked="" type="checkbox"/> Enabled	<input type="checkbox"/> Enabled	<input type="checkbox"/>
2	<input type="checkbox"/> Enabled	Block	1024	1024	0	<input checked="" type="checkbox"/> Enabled	<input type="checkbox"/> Enabled	<input type="checkbox"/>
3	<input type="checkbox"/> Enabled	Block	1024	1024	0	<input checked="" type="checkbox"/> Enabled	<input type="checkbox"/> Enabled	<input type="checkbox"/>
4	<input type="checkbox"/> Enabled	Block	1024	1024	0	<input checked="" type="checkbox"/> Enabled	<input type="checkbox"/> Enabled	<input type="checkbox"/>
5	<input type="checkbox"/> Enabled	Block	1024	1024	0	<input checked="" type="checkbox"/> Enabled	<input type="checkbox"/> Enabled	<input type="checkbox"/>

Configuring Port Link Detection

Use the Security > Network Access (Configure Interface - Link Detection) page to send an SNMP trap and/or shut down a port when a link event occurs.

Parameters

These parameters are displayed:

- ◆ **Link Detection Status** – Configures whether Link Detection is enabled or disabled for a port.
- ◆ **Condition** – The link event type which will trigger the port action.
 - ◆ **Link up** – Only link up events will trigger the port action.
 - ◆ **Link down** – Only link down events will trigger the port action.
 - ◆ **Link up and down** – All link up and link down events will trigger the port action.
- ◆ **Action** – The switch can respond in three ways to a link up or down trigger event.
 - ◆ **Trap** – An SNMP trap is sent.
 - ◆ **Trap and shutdown** – An SNMP trap is sent and the port is shut down.
 - ◆ **Shutdown** – The port is shut down.

Web Interface

To configure link detection on switch ports:

1. Click **Security > Network Access**.
2. Select Configure Interface from the Step list.
3. Click the **Link Detection** button.
4. Modify the link detection status, trigger condition, and the response for any port.
5. Click **Apply**.

Security > Network Access

Step: 2. Configures Interface

General Link Detection

Port List Total: 28

Port	Link Detection Status	Condition	Action
1	<input type="checkbox"/> Enabled	Link down	Trap
2	<input type="checkbox"/> Enabled	Link down	Trap
3	<input type="checkbox"/> Enabled	Link down	Trap
4	<input type="checkbox"/> Enabled	Link down	Trap
5	<input type="checkbox"/> Enabled	Link down	Trap

Configuring a MAC Address Filter

Use the Security > Network Access (Configure MAC Filter) page to designate specific MAC addresses or MAC address ranges as exempt from authentication. MAC addresses present in MAC Filter tables activated on a port are treated as pre-authenticated on that port.

Command Usage

- ◆ Specified MAC addresses are exempt from authentication.
- ◆ Up to 65 filter tables can be defined.
- ◆ There is no limitation on the number of entries used in a filter table.

Parameters

These parameters are displayed:

- ◆ **Filter ID** – Adds a filter rule for the specified filter. (Range: 1-64)
- ◆ **MAC Address** – The filter rule will check ingress packets against the entered MAC address or range of MAC addresses (as defined by the MAC Address Mask).
- ◆ **MAC Address Mask** – The filter rule will check for the range of MAC addresses defined by the MAC bit mask. If you omit the mask, the system will assign the default mask of an exact match. (Range: 000000000000 - FFFFFFFF; Default: FFFFFFFF)

Web Interface

To add a MAC address filter for MAC authentication:

1. Click **Security > Network Access**.
2. Select Configure MAC Filter from the Step list.
3. Select Add from the Action list.
4. Enter a filter ID, MAC address, and optional mask.
5. Click **Apply**.

Security > Network Access

Step: 3. Configure MAC Filter Action: Add

Filter ID (1-64)

MAC Address (XX-XX-XX-XX-XX-XX of XXXXXXXXXXXXX)

MAC Address Mask (XX-XX-XX-XX-XX-XX of XXXXXXXXXXXXX)

To show the MAC address filter table for MAC authentication:

1. Click **Security > Network Access**.
2. Select Configure MAC Filter from the Step list.
3. Select Show from the Action list.

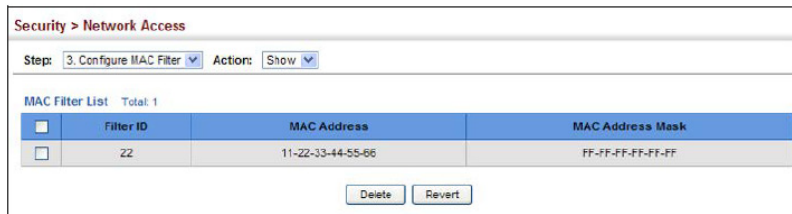

Displaying Secure MAC Address Information

Use the Security > Network Access (Show Information) page to display the authenticated MAC addresses stored in the secure MAC address table. Information on the secure MAC entries can be displayed and selected entries can be removed from the table.

Parameters

These parameters are displayed:

- ◆ **Query By** – Specifies parameters to use in the MAC address query.
 - ◆ **Sort Key** – Sorts the information displayed based on MAC address, port interface, or attribute.
 - ◆ **MAC Address** – Specifies a specific MAC address.
 - ◆ **Interface** – Specifies a port interface.
 - ◆ **Attribute** – Displays static or dynamic addresses.
- ◆ **Authenticated MAC Address List**
 - ◆ **MAC Address** – The authenticated MAC address.
 - ◆ **Interface** – The port interface associated with a secure MAC address.
 - ◆ **RADIUS Server** – The IP address of the RADIUS server that authenticated the MAC address.
 - ◆ **Time** – The time when the MAC address was last authenticated.
 - ◆ **Attribute** – Indicates a static or dynamic address.

Web Interface

To display the authenticated MAC addresses stored in the secure MAC address table:

1. Click **Security > Network Access**.
2. Select Show Information from the Step list.
3. Use the sort key to display addresses based MAC address, interface, or attribute.
4. Restrict the displayed addresses by entering a specific address in the MAC Address field, specifying a port in the Interface field, or setting the address type to static or dynamic in the Attribute field.
5. Click **Query**.

Security > Network Access

Step: 4. Show Information

Query by:

Sort Key: MAC Address

MAC Address (xx-xx-xx-xx-xx-xx or xxxxxxxxxxxx)

Interface 1

Attribute Static

Authenticated MAC Address List Total: 8

<input type="checkbox"/>	MAC Address	Interface	RADIUS Server	Time	Attribute
<input type="checkbox"/>	00-00-86-45-F2-Z3	Unit 1 / Port 23	10.2.2.10	2008y 20m 12d 11h 16m 12s	Dynamic
<input type="checkbox"/>	00-00-E8-5E-E1-DD	Unit 1 / Port 23	10.2.2.10	2008y 20m 12d 11h 32m 24s	Dynamic
<input type="checkbox"/>	00-00-E8-81-93-30	Unit 1 / Port 23	10.2.2.10	2008y 20m 12d 11h 40m 32s	Dynamic
<input type="checkbox"/>	00-01-80-31-B8-30	Unit 1 / Port 23	10.2.2.10	2008y 20m 12d 11h 18m 51s	Dynamic
<input type="checkbox"/>	00-01-80-38-95-D8	Unit 1 / Port 23	10.2.2.10	2008y 20m 12d 11h 32m 22s	Dynamic
<input type="checkbox"/>	00-01-80-38-D3-7F	Unit 1 / Port 23	10.2.2.10	2008y 20m 12d 11h 22m 26s	Dynamic
<input type="checkbox"/>	00-01-80-3C-3C-19	Unit 2 / Port 23	10.2.2.10	2008y 20m 12d 11h 15m 19s	Dynamic
<input type="checkbox"/>	00-01-80-3C-3E-B3	Unit 2 / Port 23	10.2.2.10	2008y 20m 12d 11h 17m 40s	Dynamic

HTTPS

You can configure the switch to enable the Secure Hypertext Transfer Protocol (HTTPS) over the Secure Socket Layer (SSL), providing secure access (i.e., an encrypted connection) to the switch's web interface.

Configuring Global Settings for HTTPS

Use the Security > HTTPS (Configure Global) page to enable or disable HTTPS and specify the TCP port used for this service.

Command Usage

- ◆ Both the HTTP and HTTPS service can be enabled independently on the switch. However, you cannot configure both services to use the same TCP port. (HTTP can only be configured through the CLI using the “ip http server” command described in the *CLI Reference Guide*.)
- ◆ If you enable HTTPS, you must indicate this in the URL that you specify in your browser: `https://device[:port_number]`
- ◆ When you start HTTPS, the connection is established in this way:
 - ◆ The client authenticates the server using the server's digital certificate.
 - ◆ The client and server negotiate a set of security protocols to use for the connection.
 - ◆ The client and server generate session keys for encrypting and decrypting data.
- ◆ The client and server establish a secure encrypted connection. A padlock icon should appear in the status bar for Internet Explorer 9, Mozilla Firefox 52, Google Chrome 54, or Opera 41 or more recent versions.
- ◆ The following web browsers and operating systems currently support HTTPS:

Web Browser	Operating System
Internet Explorer 9.x or later	Windows 7, 8, 10
Mozilla Firefox 52 or later	Windows 7, 8, 10, Linux
Google Chrome 54 or later	Windows 7, 8, 10
Opera 41 or later	Windows 7, 8, 10, Linux

- ◆ To specify a secure-site certificate, see Replacing the Default Secure-site Certificate.

Note:

- ♦ Users are automatically logged off of the HTTP server or HTTPS server if no input is detected for 600 seconds.
 - ♦ Connection to the web interface is not supported for HTTPS using an IPv6 link local address.
-

Parameters

These parameters are displayed:

- ♦ **HTTPS Status** – Allows you to enable/disable the HTTPS server feature on the switch. (Default: Enabled)
- ♦ **HTTPS Port** – Specifies the TCP port number used for HTTPS connection to the switch's web interface. (Default: Port 443)

Web Interface

To configure HTTPS:

1. Click **Security > HTTPS**.
2. Select Configure Global from the Step list.
3. Enable HTTPS and specify the port number if required.
4. Click **Apply**.

Security > HTTPS	
Action:	Configure Global
HTTPS Status	<input checked="" type="checkbox"/> Enabled
UDP Port (1-65535)	<input type="text" value="443"/>
<input type="button" value="Apply"/> <input type="button" value="Revert"/>	

Replacing the Default Secure-site Certificate

Use the Security > HTTPS (Copy Certificate) page to replace the default secure-site certificate.

When you log onto the web interface using HTTPS (for secure access), a Secure Sockets Layer (SSL) certificate appears for the switch. By default, the certificate that the web browser displays will be associated with a warning that the site is not recognized as a secure site. This is because the certificate has not

been signed by an approved certification authority. If you want this warning to be replaced by a message confirming that the connection to the switch is secure, you must obtain a unique certificate and a private key and password from a recognized certification authority.

Note: For maximum security, we recommend you obtain a unique Secure Sockets Layer certificate at the earliest opportunity. This is because the default certificate for the switch is not unique to the hardware you have purchased.

When you have obtained these, place them on your TFTP server and transfer them to the switch to replace the default (unrecognized) certificate with an authorized one.

Note: The switch must be reset for the new certificate to be activated. To reset the switch, see *Resetting the System* or type “reload” at the command prompt: `Console#reload`

Parameters

These parameters are displayed:

- ◆ **TFTP Server IP Address** – IP address of TFTP server which contains the certificate file.
- ◆ **Certificate Source File Name** – Name of certificate file stored on the TFTP server.
- ◆ **Private Key Source File Name** – Name of private key file stored on the TFTP server.
- ◆ **Private Password** – Password stored in the private key file. This password is used to verify authorization for certificate use, and is verified when downloading the certificate to the switch.
- ◆ **Confirm Password** – Re-type the string entered in the previous field to ensure no errors were made. The switch will not download the certificate if these two fields do not match.
- ◆ **Delete** – Deletes the HTTPS secure site certificate. You must reboot the switch to load the default certificate.

Web Interface

To replace the default secure-site certificate:

1. Click **Security > HTTPS**.

2. Select Copy Certificate from the Step list.
3. Fill in the TFTP server, certificate and private key file name, and private password.
4. Click **Apply**.

Security > HTTPS

Action: Copy Certificate ▼

TFTP Server IP Address	<input type="text" value="192.168.0.4"/>
Certificate Source File Name	<input type="text" value="site-certificate"/>
Private Key Source File Name	<input type="text" value="private-key"/>
Private Password	<input type="password" value="*****"/>
Confirm Password	<input type="password" value="*****"/>

[Click this button to delete current certificate.](#)

SSH

The Berkeley-standard includes remote access tools originally designed for Unix systems. Some of these tools have also been implemented for Microsoft Windows and other environments. These tools, including commands such as *rlogin* (remote login), *rsh* (remote shell), and *rcp* (remote copy), are not secure from hostile attacks.

Secure Shell (SSH) includes server/client applications intended as a secure replacement for the older Berkeley remote access tools. SSH can also provide remote management access to this switch as a secure replacement for Telnet. When the client contacts the switch via the SSH protocol, the switch generates a public-key that the client uses along with a local user name and password for access authentication. SSH also encrypts all data transfers passing between the switch and SSH-enabled management station clients, and ensures that data traveling over the network arrives unaltered.

Note:

- ◆ You need to install an SSH client on the management station to access the switch for management via the SSH protocol.
 - ◆ The switch supports only SSH Version 2.0 clients.
-

Command Usage

The SSH server on this switch supports both password and public key authentication. If password authentication is specified by the SSH client, then the password can be authenticated either locally or via a RADIUS or TACACS+ remote authentication server, as specified on the System Authentication page. If public key authentication is specified by the client, then you must configure authentication keys on both the client and the switch as described in the following section. Note that regardless of whether you use public key or password authentication, you still have to generate authentication keys on the switch (SSH Host Key Settings) and enable the SSH server (Authentication Settings).

To use the SSH server, complete these steps:

1. *Generate a Host Key Pair* – On the SSH Host Key Settings page, create a host public/private key pair.
2. *Provide Host Public Key to Clients* – Many SSH client programs automatically import the host public key during the initial connection setup with the switch. Otherwise, you need to manually create a known

hosts file on the management station and place the host public key in it. An entry for a public key in the known hosts file would appear similar to the following example:

```
10.1.0.54 1024 35 15684995401867669259333946775054617325313674890836547254
15020245593199868544358361651999923329781766065830956 10825913212890233
76546801726272571413428762941301196195566782
595664104869574278881462065194174677298486546861571773939016477935594230357741
309802273708779454524083971752646358058176716709574804776117
```

3. *Import Client's Public Key to the Switch* – See Importing User Public Keys to copy a file containing the public key for all the SSH client's granted management access to the switch. (Note that these clients must be configured locally on the switch via the User Accounts page. The clients are subsequently authenticated using these keys. The current firmware only accepts public key files based on standard UNIX format as shown in the following example for an RSA key:

```
-----BEGIN RSA PUBLIC KEY-----
MIIBCgKCAQEAmk9QvzWeYFgvjInC/jyvalribLTmx5ncPJcnCORHsAgbuzeFGRhV
RSdcx63mRUXiG968LksVXPKJeEa6cX02x2oLwbG96VpoarLTrnI8UC55XFw4c32I
q0FERXUIVQPFst2XgPqQHi+uIaokeKJ68V3V05CmdXwRYmSr42GQB2SjOp4cMpmY
TKIIfHxQ0L7WfSKJnBMgsk9ZyzvD1pZxXoHKdG87k4k9gn8d+fcV9d7xHf2255jI
1xNwPOZDHy57yjC63s04xoYeTE7TBrCM5vqJwr17R8ioNXorpRvWZlump2F2TzHE
nyuoYvSJMAR8iTTboFIjEonqVX6gsLFwhwIDAQAB
-----END RSA PUBLIC KEY-----
```

4. *Set the Optional Parameters* – On the SSH Settings page, configure the optional parameters, including the authentication timeout, the number of retries, and the server key size.
5. *Enable SSH Service* – On the SSH Settings page, enable the SSH server on the switch.
6. *Authentication* – One of the following authentication methods is employed:
 - Password Authentication (for SSH V2 Clients)
 - a) The client sends its password to the server.
 - b) The switch compares the client's password to those stored in memory.
 - c) If a match is found, the connection is allowed.

Note: To use SSH with only password authentication, the host public key must still be given to the client, either during initial connection or manually entered into the known host file. However, you do not need to configure the client's keys.

Public Key Authentication – When an SSH client attempts to contact the switch, the SSH server uses the host key pair to negotiate a session key and encryption method. Only clients that have a private key corresponding to the public keys stored on the switch can access it. The following exchanges take place during this process:

Authenticating SSH v2 Clients

- a) The client first queries the switch to determine if public key authentication using a preferred algorithm is acceptable.
- b) If the specified algorithm is supported by the switch, it notifies the client to proceed with the authentication process. Otherwise, it rejects the request.
- c) The client sends a signature generated using the private key to the switch.
- d) When the server receives this message, it checks whether the supplied key is acceptable for authentication, and if so, it then checks whether the signature is correct. If both checks succeed, the client is authenticated.

Note:

- ◆ The SSH server supports up to eight client sessions. The maximum number of client sessions includes both current Telnet sessions and SSH sessions.
- ◆ The SSH server can be accessed using any configured IPv4 or IPv6 interface address on the switch.

Configuring the SSH Server

Use the Security > SSH (Configure Global) page to enable the SSH server and configure basic settings for authentication.

Note: You must generate RSA host keys before enabling the SSH server.

Parameters

These parameters are displayed:

- ◆ **SSH Server Status** – Allows you to enable/disable the SSH server on the switch. (Default: Disabled)

- ◆ **Version** – The Secure Shell version number. Version 2.0 is displayed and the switch supports management access only from SSH Version 2.0 clients.
- ◆ **Authentication Timeout** – Specifies the time interval in seconds that the SSH server waits for a response from a client during an authentication attempt. (Range: 1-120 seconds; Default: 120 seconds)
- ◆ **Authentication Retries** – Specifies the number of authentication attempts that a client is allowed before authentication fails and the client has to restart the authentication process. (Range: 1-5 times; Default: 3)

Web Interface

To configure the SSH server:

1. Click **Security > SSH**.
2. Select Configure Global from the Step list.
3. Enable the SSH server.
4. Adjust the authentication parameters as required.
5. Click **Apply**.

The screenshot shows the 'Security > SSH' configuration page. At the top, there is a breadcrumb 'Security > SSH' and a 'Step:' dropdown menu set to '1. Configure Global'. Below this, the 'SSH Server Status' is shown as an unchecked checkbox labeled 'Enabled'. The 'Version' is set to '2.0'. The 'Authentication Timeout (1-120)' is set to '120' with a 'sec' label. The 'Authentication Retries (1-5)' is set to '3'. At the bottom right, there are 'Apply' and 'Revert' buttons.

Generating the Host Key Pair

Use the Security > SSH (Configure Host Key - Generate) page to generate a host public/private key pair used to provide secure communications between an SSH client and the switch. After generating this key pair, you must provide the host public key to SSH clients and import the client's public key to the switch as described in the section Importing User Public Keys.

Note: A host key pair must be configured on the switch before you can enable the SSH server. See Configuring the SSH Server.

Parameters

These parameters are displayed:

- ◆ **Host-Key Type** – The key type used to generate the host key pair (i.e., public and private keys). (Range: RSA)
The SSH server uses RSA for key exchange when the client first establishes a connection with the switch, and then negotiates with the client to select either DES (56-bit) or 3DES (168-bit) for data encryption.

Note: The switch uses only RSA keys for SSHv2 clients.

Web Interface

To generate the SSH host key pair:

1. Click **Security > SSH**.
2. Select Configure Host Key from the Step list.
3. Select Generate from the Action list.
4. Click **Apply**.

Security > SSH

Step: 2. Configure Host Key Action: Generate

Host-Key Type RSA

Apply Revert

To display or clear the SSH host key pair:

1. Click **Security > SSH**.
2. Select Configure Host Key from the Step list.
3. Select Show from the Action list.
4. Select the option to save the host key from memory to flash by clicking **Save**, or select the host-key type to clear and click **Clear**.

Security > SSH

Step: 2. Configure Host Key Action: Show

Public-Key of Host-Key

RSA

```
-----BEGIN RSA PUBLIC KEY-----
MIIBBgKCAQEAAuO/INVZiNyNdaHeuSepFOxtjih2WF1P9/GIUvyF7Hc0FEPHMzU1z
+S7R9N9OymWx1d3nsFjRzKv2XILEG2I5WaqQPxbcn3FNI1HT/JPvIxsqP1uw5uw
FCrme5Axcn31Grr3SEQbJZFLG6ZYaJoSS2w7QQ8Uhb8eajRFvsRBrerpJTq/EeVTJ
MiIF+gARRxOMA/v1c2HUqrzDtwFiyhtGGHyatxQgdstmKgxmg4TpozmkJP1rqz
```

Clear

Save Click this button to Save All Host-Key from Memory to Flash.

Importing User Public Keys

Use the Security > SSH (Configure User Key - Copy) page to upload a user's public key to the switch. This public key must be stored on the switch for the user to be able to log in using the public key authentication mechanism. If the user's public key does not exist on the switch, SSH will revert to the interactive password authentication mechanism to complete authentication.

Parameters

These parameters are displayed:

- ◆ **User Name** – This drop-down box selects the user who's public key you wish to manage. Note that you must first create users on the User Accounts page.
- ◆ **User Key Type** – The type of public key to upload.
 - ◆ **RSA**: The switch accepts an RSA encrypted public key.
The SSH server uses RSA for key exchange when the client first establishes a connection with the switch, and then negotiates with the client to select either DES (56-bit) or 3DES (168-bit) for data encryption.

The switch uses only RSA for SSHv2 clients.
- ◆ **TFTP Server IP Address** – The IP address of the TFTP server that contains the public key file you wish to import.
- ◆ **Source File Name** – The public key file to upload.

Web Interface

To copy the SSH user's public key:

1. Click **Security > SSH**.
2. Select Configure User Key from the Step list.
3. Select Copy from the Action list.
4. Select the user name from the drop-down box, input the TFTP server IP address and the public key source file name.
5. Click **Apply**.

Security > SSH

Step: 3. Configure User Key Action: Copy

User Name: admin

User-Key Type: RSA

TFTP Server IP Address:

Source File Name:

Apply Revert

To display or clear the SSH user's public key:

1. Click **Security > SSH**.
2. Select **Configure User Key** from the Step list.
3. Select **Show** from the Action list.
4. Select a user from the User Name list.
5. Select the host-key type to clear.
6. Click **Clear**.

Security > SSH

Step: 3. Configure User Key Action: Show

User Name: admin

Public Key of User-Key

RSA

Clear

ACL (Access Control Lists)

Access Control Lists (ACL) provide packet filtering for IPv4/IPv6 frames (based on address, protocol, Layer 4 protocol port number or TCP control code), IPv6 frames (based on address, DSCP traffic class, or next header type), or any frames (based on MAC address or Ethernet type). To filter incoming packets, first create an access list, add the required rules, and then bind the list to a specific port.

Configuring Access Control Lists –

An ACL is a sequential list of permit or deny conditions that apply to IP addresses, MAC addresses, or other more specific criteria. This switch tests ingress or egress packets against the conditions in an ACL one by one. A packet will be accepted as soon as it matches a permit rule, or dropped as soon as it matches a deny rule. If no rules match, the packet is accepted.

Command Usage

The following restrictions apply to ACLs:

- ◆ The maximum number of ACLs is 64.
- ◆ The maximum number of rules per system is 1024 rules.
- ◆ An ACL can have up to 1024 rules. However, due to resource restrictions, the average number of rules bound to the ports should not exceed 20.
- ◆ The maximum number of rules that can be bound to the ports is 64 for each of the following list types: MAC ACLs, IP ACLs (including Standard and Extended ACLs), IPv6 Standard ACLs, and IPv6 Extended ACLs.

The maximum number of rules (Access Control Entries, or ACEs) stated above is the worst case scenario. In practice, the switch compresses the ACEs in TCAM (a hardware table used to store ACEs), but the actual maximum number of ACEs possible depends on too many factors to be precisely determined. It depends on the amount of hardware resources reserved at runtime for this purpose.

Auto ACE Compression is a software feature used to compress all the ACEs of an ACL to utilize hardware resources more efficiency. Without compression, one ACE would occupy a fixed number of entries in TCAM. So if one ACL includes 25 ACEs, the ACL would need (25 * n) entries in TCAM, where “n” is the fixed number of TCAM entries needed for one ACE. When compression is employed, before writing the ACE into TCAM, the software compresses the ACEs to reduce the number of required TCAM entries. For example, one ACL may include 128 ACEs

which classify a continuous IP address range like 192.168.1.0~255. If compression is disabled, the ACL would occupy (128*n) entries of TCAM, using up nearly all of the hardware resources. When using compression, the 128 ACEs are compressed into one ACE classifying the IP address as 192.168.1.0/24, which requires only “n” entries in TCAM. The above example is an ideal case for compression. The worst case would be if no any ACE can be compressed, in which case the used number of TCAM entries would be the same as without compression. It would also require more time to process the ACEs.

- ◆ If no matches are found down to the end of the list, the traffic is denied. For this reason, frequently hit entries should be placed at the top of the list. There is an implied deny for traffic that is not explicitly permitted. Also, note that a single-entry ACL with only one deny entry has the effect of denying all traffic. You should therefore use at least one permit statement in an ACL or all traffic will be blocked.

Because the switch stops testing after the first match, the order of the conditions is critical. If no conditions match, the packet will be denied.

The order in which active ACLs are checked is as follows:

1. User-defined rules in IP and MAC ACLs for ingress or egress ports are checked in parallel.
2. Rules within an ACL are checked in the configured order, from top to bottom.
3. If the result of checking an IP ACL is to permit a packet, but the result of a MAC ACL on the same packet is to deny it, the packet will be denied (because the decision to deny a packet has a higher priority for security reasons). A packet will also be denied if the IP ACL denies it and the MAC ACL accepts it.

Showing TCAM Utilization

Use the Security > ACL (Configure ACL - Show TCAM) page to show utilization parameters for TCAM (Ternary Content Addressable Memory), including the number policy control entries in use, the number of free entries, and the overall percentage of TCAM in use.

Command Usage

Policy control entries (PCEs) are used by various system functions which rely on rule-based searches, including Access Control Lists (ACLs), IP Source Guard filter rules, Quality of Service (QoS) processes, QinQ, MAC-based VLANs, VLAN translation, or traps.

For example, when binding an ACL to a port, each rule in an ACL will use two PCEs; and when setting an IP Source Guard filter rule for a port, the system will also use two PCEs.

Parameters

These parameters are displayed:

- ◆ **Pool Capability Code** – Abbreviation for processes shown in the TCAM List.
- ◆ **Unit** – Stack unit identifier.
- ◆ **Device** – Memory chip used for indicated pools.
- ◆ **Pool** – Rule slice (or call group). Each slice has a fixed number of rules that are used for the specified features.
- ◆ **Total** – The maximum number of policy control entries allocated to the each pool.
- ◆ **Used** – The number of policy control entries used by the operating system.
- ◆ **Free** – The number of policy control entries available for use.
- ◆ **Capability** – The processes assigned to each pool.

Web Interface

To show information on TCAM utilization:

1. Click **Security > ACL**.
2. Select Configure ACL from the Step list.
3. Select Show TCAM from the Action list.

Security > ACL

Step: 1 Configure ACL Action: Show TCAM

Pool Capability Code:

AM - MAC ACL, A4 - IPv4 ACL, A6S - IPv6 Standard ACL,
 A6E - IPv6 extended ACL, DM - MAC diffServ, D4 - IPv4 diffServ,
 D6S - IPv6 standard diffServ, D6E - IPv6 extended diffServ,
 AEM - Egress MAC ACL, AE4 - Egress IPv4 ACL,
 AE6S - Egress IPv6 standard ACL, AE6E - Egress IPv6 extended ACL,
 DEM - Egress MAC diffServ, DE4 - Egress IPv4 diffServ,
 DE6S - Egress IPv6 standard diffServ,
 DE6E - Egress IPv6 extended diffServ, W - Web authentication,
 I - IP source guard, I6 - IPv6 source guard, C - CPU interface.
 L - Link local, Reserved - Reserved.
 ALL - All supported function.

Page Number

TCAM List Total: 1

Unit	Device	Pool	Total	Used	Free	Capability
1	0	0	3672	26	3646	ALL

Setting the ACL Name and Type

Use the Security > ACL (Configure ACL - Add) page to create an ACL.

Parameters

These parameters are displayed:

- ◆ **ACL Name** – Name of the ACL. (Maximum length: 32 characters)
- ◆ **Type** – The following filter modes are supported:
 - ◆ **IP Standard:** IPv4 ACL mode filters packets based on the source IPv4 address.
 - ◆ **IP Extended:** IPv4 ACL mode filters packets based on the source or destination IPv4 address, as well as the protocol type and protocol port number. If the “TCP” protocol is specified, then you can also filter packets based on the TCP control code.
 - ◆ **IPv6 Standard:** IPv6 ACL mode filters packets based on the source IPv6 address.
 - ◆ **IPv6 Extended:** IPv6 ACL mode filters packets based on the source or destination IP address, as well as DSCP, and the next header type.
 - ◆ **MAC** – MAC ACL mode filters packets based on the source or destination MAC address and the Ethernet frame type (RFC 1060).
 - ◆ **ARP** – ARP ACL specifies static IP-to-MAC address bindings used for ARP inspection.

Web Interface

To configure the name and type of an ACL:

1. Click **Security > ACL**.
2. Select Configure ACL from the Step list.
3. Select Add from the Action list.
4. Fill in the ACL Name field, and select the ACL type.
5. Click **Apply**.

The screenshot shows a web interface titled "Security > ACL". At the top, there is a "Step:" dropdown menu set to "1. Configure ACL" and an "Action:" dropdown menu set to "Add". Below this, there are two main configuration fields: "ACL Name" with a text input field containing "R&D", and "Type" with a dropdown menu set to "IP Standard". At the bottom right of the form, there are two buttons: "Apply" and "Revert".

To show a list of ACLs:

1. Click **Security > ACL**.
2. Select Configure ACL from the Step list.
3. Select Show from the Action list.

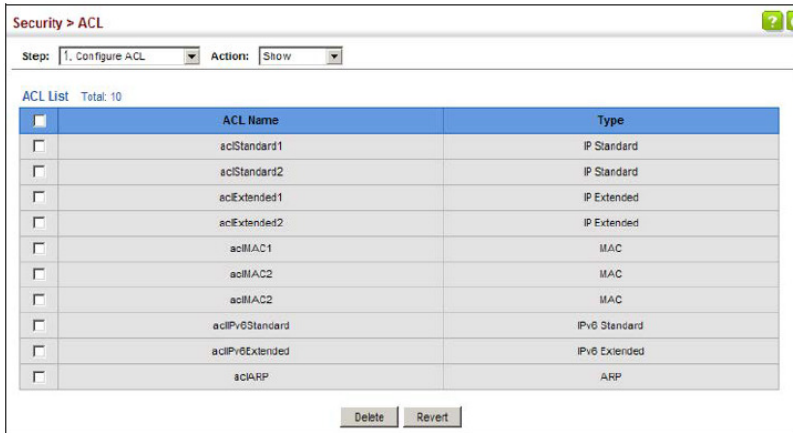

Configuring a Standard IPv4 ACL

Use the Security > ACL (Configure ACL - Add Rule - IP Standard) page to configure a Standard IPv4 ACL.

Parameters

These parameters are displayed:

- ◆ **Type** – Selects the type of ACLs to show in the Name list.
- ◆ **Name** – Shows the names of ACLs matching the selected type.
- ◆ **Action** – An ACL can contain any combination of permit or deny rules.
- ◆ **Address Type** – Specifies the source IP address. Use “Any” to include all possible addresses, “Host” to specify a specific host address in the Address field, or “IP” to specify a range of addresses with the Address and Subnet Mask fields. (Options: Any, Host, IP; Default: Any)
- ◆ **Source IP Address** – Source IP address.
- ◆ **Source Subnet Mask** – A subnet mask containing four integers from 0 to 255, each separated by a period. The mask uses 1 bits to indicate “match” and 0 bits to indicate “ignore.” The mask is bitwise ANDed with the specified source IP address, and compared with the address for each IP packet entering the port(s) to which this ACL has been assigned.
- ◆ **Time Range** – Name of a time range.

Web Interface

To add rules to an IPv4 Standard ACL:

1. Click **Security > ACL**.
2. Select Configure ACL from the Step list.
3. Select Add Rule from the Action list.
4. Select IP Standard from the Type list.
5. Select the name of an ACL from the Name list.
6. Specify the action (i.e., Permit or Deny).
7. Select the address type (Any, Host, or IP).
8. If you select “Host,” enter a specific address. If you select “IP,” enter a subnet address and the mask for an address range.
9. Click **Apply**.

The screenshot shows the 'Security > ACL' configuration page. At the top, the 'Step' is set to '1. Configure ACL' and the 'Action' is 'Add Rule'. Under 'Type', 'IP Standard' is selected with a radio button. The 'Name' field contains 'R&D'. Under 'Action', 'Permit' is selected. Under 'Address Type', 'Host' is selected. The 'Source IP Address' field contains '10.1.1.21' and the 'Source Subnet Mask' field contains '255.255.255.255'. The 'Time-Range' checkbox is checked, and its dropdown menu shows 'R&D'. At the bottom right, there are 'Apply' and 'Revert' buttons.

Configuring an Extended IPv4 ACL

Use the Security > ACL (Configure ACL - Add Rule - IP Extended) page to configure an Extended IPv4 ACL.

Parameters

These parameters are displayed:

- ◆ **Type** – Selects the type of ACLs to show in the Name list.
- ◆ **Name** – Shows the names of ACLs matching the selected type.
- ◆ **Action** – An ACL can contain any combination of permit or deny rules.

- ◆ **Source/Destination Address Type** – Specifies the source or destination IP address type. Use “Any” to include all possible addresses, “Host” to specify a specific host address in the Address field, or “IP” to specify a range of addresses with the Address and Subnet Mask fields. (Options: Any, Host, IP; Default: Any)
- ◆ **Source/Destination IP Address** – Source or destination IP address.
- ◆ **Source/Destination Subnet Mask** – Subnet mask for source or destination address.
- ◆ **Source/Destination Port** – Source/destination port number for the specified protocol type. (Range: 0-65535)
- ◆ **Source/Destination Port Bit Mask** – Decimal number representing the port bits to match. (Range: 0-65535)
- ◆ **Protocol** – Specifies the protocol type to match as ICMP, TCP, UDP or Others, where others indicates a specific protocol number (0-255). (Options: ICMP, TCP, UDP, Others; Default: Others)

The following items are under TCP

- ◆ **Control Code** – Decimal number (representing a bit string) that specifies flag bits in byte 14 of the TCP header. (Range: 0-63)
- ◆ **Control Code Bit Mask** – Decimal number representing the code bits to match. (Range: 0-63)

The control bit mask is a decimal number (for an equivalent binary bit mask) that is applied to the control code. Enter a decimal number, where the equivalent binary bit “1” means to match a bit and “0” means to ignore a bit. The following bits may be specified:

- ◆ 1 (fin) – Finish
- ◆ 2 (syn) – Synchronize
- ◆ 4 (rst) – Reset
- ◆ 8 (psh) – Push
- ◆ 16 (ack) – Acknowledgement
- ◆ 32 (urg) – Urgent pointer

For example, use the code value and mask below to catch packets with the following flags set:

- ◆ SYN flag valid, use control-code 2, control bit mask 2
- ◆ Both SYN and ACK valid, use control-code 18, control bit mask 18
- ◆ SYN valid and ACK invalid, use control-code 2, control bit mask 18
- ◆ **Service Type** – Packet priority settings based on the following criteria:
 - ◆ **Precedence** – IP precedence level. (Range: 0-7)

- ◆ **DSCP** – DSCP priority level. (Range: 0-63)
- ◆ **Time Range** – Name of a time range.

Web Interface

To add rules to an IPv4 Extended ACL:

1. Click **Security > ACL**.
2. Select Configure ACL from the Step list.
3. Select Add Rule from the Action list.
4. Select IP Extended from the Type list.
5. Select the name of an ACL from the Name list.
6. Specify the action (i.e., Permit or Deny).
7. Select the address type (Any, Host, or IP).
8. If you select “Host,” enter a specific address. If you select “IP,” enter a subnet address and the mask for an address range.
9. Set any other required criteria, such as service type, protocol type, or control code.
10. Click **Apply**.

The screenshot shows the 'Security > ACL' configuration page. At the top, the 'Step' is set to '1. Configure ACL' and the 'Action' is 'Add Rule'. The 'Type' is 'IP Extended'. The 'Name' field is empty. The 'Action' is set to 'Permit'. The 'Source Address Type' is 'Any', and the 'Destination Address Type' is also 'Any'. The 'Source IP Address' and 'Destination IP Address' are both '0.0.0.0'. The 'Source Subnet Mask' and 'Destination Subnet Mask' are both '0.0.0.0'. The 'Source Port' and 'Destination Port' are both empty. The 'Source Port Bit Mask' and 'Destination Port Bit Mask' are both empty. The 'Protocol' is 'ICMP (1)'. The 'ICMP Type' is '0-255'. The 'Control Code' and 'Control Code Bit Mask' are both empty. The 'Service Type' is 'Precedence (0-7)'. The 'Time-Range' checkbox is unchecked. At the bottom, there are 'Apply' and 'Revert' buttons.

Configuring a Standard IPv6 ACL

Use the Security > ACL (Configure ACL - Add Rule - IPv6 Standard) page to configure a Standard IPv6ACL.

Parameters

These parameters are displayed:

- ◆ **Type** – Selects the type of ACLs to show in the Name list.
- ◆ **Name** – Shows the names of ACLs matching the selected type.
- ◆ **Action** – An ACL can contain any combination of permit or deny rules.
- ◆ **Source Address Type** – Specifies the source IP address. Use “Any” to include all possible addresses, “Host” to specify a specific host address in the Address field, or “IPv6-Prefix” to specify a range of addresses. (Options: Any, Host, IPv6-Prefix; Default: Any)
- ◆ **Source IPv6 Address** – An IPv6 source address or network class. The address must be formatted according to RFC 2373 “IPv6 Addressing Architecture,” using 8 colon-separated 16-bit hexadecimal values. One double colon may be used in the address to indicate the appropriate number of zeros required to fill the undefined fields.
- ◆ **Source Prefix-Length** – A decimal value indicating how many contiguous bits (from the left) of the address comprise the prefix (i.e., the network portion of the address). (Range: 0-128 bits)
- ◆ **Time Range** – Name of a time range.

Web Interface

To add rules to a Standard IPv6 ACL:

1. Click **Security > ACL**.
2. Select Configure ACL from the Step list.
3. Select Add Rule from the Action list.
4. Select IPv6 Standard from the Type list.
5. Select the name of an ACL from the Name list.
6. Specify the action (i.e., Permit or Deny).
7. Select the source address type (Any, Host, or IPv6-prefix).
8. If you select “Host,” enter a specific address. If you select “IPv6-prefix,” enter a subnet address and the prefix length.
9. Click **Apply**.

The screenshot shows the 'Security > ACL' configuration page. The 'Step' is '1. Configure ACL' and the 'Action' is 'Add Rule'. The 'Type' is 'IPv6 Standard' (selected). The 'Name' is 'R&D#6S'. The 'Action' is 'Permit'. The 'Source Address Type' is 'Host'. The 'Source IPv6 Address' is '2009:DB9:2229::79'. The 'Source Prefix Length (0-128)' is '128'. The 'Time-Range' checkbox is unchecked, and the 'Time-Range' dropdown is 'R&D'. There are 'Apply' and 'Revert' buttons at the bottom right.

Configuring an Extended IPv6 ACL

Use the Security > ACL (Configure ACL - Add Rule - IPv6 Extended) page to configure an Extended IPv6 ACL.

Parameters

These parameters are displayed:

- ◆ **Type** – Selects the type of ACLs to show in the Name list.
- ◆ **Name** – Shows the names of ACLs matching the selected type.
- ◆ **Action** – An ACL can contain any combination of permit or deny rules.
- ◆ **Protocol** – Selects the protocol of the next header in the packet. Select TCP, UDP, ICMP, or Next Header to identify the protocol by value.
- ◆ **Next Header** – Identifies the type of header immediately following the IPv6 header. (Range: 0-255)

Optional Internet-layer information is encoded in separate headers that may be placed between the IPv6 header and the upper-layer header in a packet. There are a small number of such extension headers, each identified by a distinct Next Header value. IPv6 supports the values defined for the IPv4 Protocol field in RFC 1700, and includes these commonly used headers:

0 : Hop-by-Hop Options (RFC 2460)

6 : TCP Upper-layer Header (RFC 1700)

17 : UDP Upper-layer Header (RFC 1700)

43 : Routing (RFC 2460)

44 : Fragment (RFC 2460)

50 : Encapsulating Security Payload (RFC 2406)

51 : Authentication (RFC 2402)

60 : Destination Options (RFC 2460)

- ♦ **Source Address Type** – Specifies the source IP address type. Use “Any” to include all possible addresses, “Host” to specify a specific host address in the Address field, or “IPv6-Prefix” to specify a range of addresses. (Options: Any, Host, IPv6-Prefix; Default: Any)
- ♦ **Destination Address Type** – Specifies the destination IP address type. Use “Any” to include all possible addresses, or “IPv6-Prefix” to specify a range of addresses. (Options: Any, IPv6-Prefix; Default: Any)
- ♦ **Source/Destination IPv6 Address** – An IPv6 address or network class. The address must be formatted according to RFC 2373 “IPv6 Addressing Architecture,” using 8 colon-separated 16-bit hexadecimal values. One double colon may be used in the address to indicate the appropriate number of zeros required to fill the undefined fields.
- ♦ **Source/Destination Prefix-Length** – A decimal value indicating how many contiguous bits (from the left) of the address comprise the prefix; i.e., the network portion of the address. (Range: 0-128 bits for the source prefix; 0-8 bits for the destination prefix)
- ♦ **DSCP** – DSCP traffic class. (Range: 0-63)
- ♦ **Source Port** – Protocol⁹ source port number. (Range: 0-65535)
- ♦ **Source Port Bit Mask** – Decimal number representing the port bits to match. (Range: 0-65535)
- ♦ **Destination Port** – Protocol⁹ destination port number. (Range: 0-65535)
- ♦ **Destination Port Bit Mask** – Decimal number representing the port bits to match. (Range: 0-65535)
- ♦ **Time Range** – Name of a time range.

Note: 9. Includes TCP, UDP or other protocol types.

Web Interface

To add rules to an Extended IPv6 ACL:

1. Click **Security > ACL**.
2. Select Configure ACL from the Step list.
3. Select Add Rule from the Action list.

4. Select IPv6 Extended from the Type list.
5. Select the name of an ACL from the Name list.
6. Specify the action (i.e., Permit or Deny).
7. Select the address type (Any or IPv6-prefix).
8. If you select “Host,” enter a specific address. If you select “IPv6-prefix,” enter a subnet address and prefix length.
9. Set any other required criteria, such as DSCP or next header type.
10. Click **Apply**.

Action	Permit
<input checked="" type="checkbox"/> Protocol	Next Header
Next-Header (0-255)	
Source Address Type	Any
Source IPv6 Address	::
Source Prefix Length (0-128)	0
Destination Address Type	Any
Destination IPv6 Address	::
Destination Prefix Length (0-8)	0
DSCP (0-63)	0
<input type="checkbox"/> Time-Range	

Apply Revert

Configuring a MAC ACL

Use the Security > ACL (Configure ACL - Add Rule - MAC) page to configure a MAC ACL based on hardware addresses, packet format, and Ethernet type.

Parameters

These parameters are displayed:

- ◆ **Type** – Selects the type of ACLs to show in the Name list.
- ◆ **Name** – Shows the names of ACLs matching the selected type.
- ◆ **Action** – An ACL can contain any combination of permit or deny rules.
- ◆ **Source/Destination Address Type** – Use “Any” to include all possible addresses, “Host” to indicate a specific MAC address, or “MAC” to specify an address range with the Address and Bit Mask fields. (Options: Any, Host, MAC; Default: Any)
- ◆ **Source/Destination MAC Address** – Source or destination MAC address.

- ◆ **Source/Destination Bit Mask** – Hexadecimal mask for source or destination MAC address.
- ◆ **Packet Format** – This attribute includes the following packet types:
 - ◆ **Any** – Any Ethernet packet type.
 - ◆ **Untagged-eth2** – Untagged Ethernet II packets.
 - ◆ **Untagged-802.3** – Untagged Ethernet 802.3 packets.
 - ◆ **Tagged-eth2** – Tagged Ethernet II packets.
 - ◆ **Tagged-802.3** – Tagged Ethernet 802.3 packets.
- ◆ **VID** – VLAN ID. (Range: 1-4094)
- ◆ **VID Bit Mask** – VLAN bit mask. (Range: 0-4095)
- ◆ **Ethernet Type** – This option can only be used to filter Ethernet II formatted packets. (Range: 0-ffff hex.)

A detailed listing of Ethernet protocol types can be found in RFC 1060. A few of the more common types include 0800 (IP), 0806 (ARP), 8137 (IPX).
- ◆ **Ethernet Type Bit Mask** – Protocol bit mask. (Range: 0-ffff hex)
- ◆ **Internet Protocol** – Layer 3 or 4 information to match.
 - ◆ **No** – Not applied.
 - ◆ **IPv4** – See Configuring an Extended IPv4 ACL.
 - ◆ **IPv6** – See Configuring an Extended IPv6 ACL.
- ◆ **CoS** – CoS value. (Range: 0-7, where 7 is the highest priority)
- ◆ **CoS Bit Mask** – CoS bitmask. (Range: 0-7)
- ◆ **Time Range** – Name of a time range.

Web Interface

To add rules to a MAC ACL:

1. Click **Security > ACL**.
2. Select **Configure ACL** from the Step list.
3. Select **Add Rule** from the Action list.
4. Select **MAC** from the Type list.
5. Select the name of an ACL from the Name list.
6. Specify the action (i.e., **Permit** or **Deny**).
7. Select the address type (**Any**, **Host**, or **MAC**).

8. If you select “Host,” enter a specific address (e.g., 11-22-33-44-55-66). If you select “MAC,” enter a base address and a hexadecimal bit mask for an address range.
9. Set any other required criteria, such as VID, Ethernet type, or packet format.
10. Click **Apply**.

Configuring an ARP ACL

Use the Security > ACL (Configure ACL - Add Rule - ARP) page to configure ACLs based on ARP message addresses. ARP Inspection can then use these ACLs to filter suspicious traffic.

Parameters

These parameters are displayed:

- ◆ **Type** – Selects the type of ACLs to show in the Name list.
- ◆ **Name** – Shows the names of ACLs matching the selected type.
- ◆ **Action** – An ACL can contain any combination of permit or deny rules.
- ◆ **Packet Type** – Indicates an ARP request, ARP response, or either type. (Range: IP, Request, Response; Default: IP)
- ◆ **Source/Destination IP Address Type** – Specifies the source or destination IPv4 address. Use “Any” to include all possible addresses,

“Host” to specify a specific host address in the Address field, or “IP” to specify a range of addresses with the Address and Mask fields. (Options: Any, Host, IP; Default: Any)

- ◆ **Source/Destination IP Address** – Source or destination IP address.
- ◆ **Source/Destination IP Subnet Mask** – Subnet mask for source or destination address.
- ◆ **Source/Destination MAC Address Type** – Use “Any” to include all possible addresses, “Host” to indicate a specific MAC address, or “MAC” to specify an address range with the Address and Mask fields. (Options: Any, Host, MAC; Default: Any)
- ◆ **Source/Destination MAC Address** – Source or destination MAC address.
- ◆ **Source/Destination MAC Bit Mask** – Hexadecimal mask for source or destination MAC address.
- ◆ **Log** – Logs a packet when it matches the access control entry.

Web Interface

To add rules to an ARP ACL:

1. Click **Security > ACL**.
2. Select Configure ACL from the Step list.
3. Select Add Rule from the Action list.
4. Select ARP from the Type list.
5. Select the name of an ACL from the Name list.
6. Specify the action (i.e., Permit or Deny).
7. Select the packet type (Request, Response, All).
8. Select the address type (Any, Host, or IP).
9. If you select “Host,” enter a specific address (e.g., 11-22-33-44-55-66). If you select “IP,” enter a base address and a hexadecimal bit mask for an address range.
10. Enable logging if required.
11. Click **Apply**.

Security > ACL

Step: 1. Configure ACL Action: Add Rule

Type: P Standard IP Extended MAC IPv6 Standard Pv6 Extended ARP

Name: R&F#7ARP

Action: Permit Packet Type: IP

Source IP Address Type: Any Destination IP Address Type: Any

Source IP Address: 0.0.0.0 Destination IP Address: 0.0.0.0

Source IP Subnet Mask: 0.0.0.0 Destination IP Subnet Mask: 0.0.0.0

Source MAC Address Type: Any Destination MAC Address Type: Any

Source MAC Address: 00-00-00-00-00-00 Destination MAC Address: 00-00-00-00-00-00

Source MAC Bit Mask: 00-00-00-00-00-00 Destination MAC Bit Mask: 00-00-00-00-00-00

Log

Apply Revert

Binding a Port to an Access Control List

After configuring ACLs, use the Security > ACL (Configure Interface – Configure) page to bind the ports that need to filter traffic to the appropriate ACLs.

Parameters

These parameters are displayed:

- ◆ **Type** – Selects the type of ACLs to bind to a port.
- ◆ **Port** – Port identifier.
- ◆ **ACL** – ACL used for ingress or egress packets.
- ◆ **Time Range** – Name of a time range.
- ◆ **Counter** – Enables counter for ACL statistics.

Web Interface

To bind an ACL to a port:

1. Click **Security > ACL**.
2. Select Configure Interface from the Step list.
3. Select Configure from the Action list.
4. Select IP, MAC or IPv6 from the Type options.
5. Select a port.
6. Select the name of an ACL from the ACL list.

7. Click **Apply**.

The screenshot shows the 'Security > ACL' configuration interface. At the top, the breadcrumb 'Security > ACL' is visible. Below it, there are two dropdown menus: 'Step: 2. Configure Interface' and 'Action: Configure'. The 'Type' section has three radio buttons: 'IP' (selected), 'MAC', and 'IPv6'. The 'Port' section has a dropdown menu showing '1'. The 'Ingress' section has three checkboxes: 'ACL' (checked), 'Time-Range', and 'Counter'. The 'Egress' section also has three checkboxes: 'ACL' (checked), 'Time-Range', and 'Counter'. At the bottom right, there are two buttons: 'Apply' and 'Revert'.

Showing ACL Hardware Counters

Use the Security > ACL > Configure Interface (Show Hardware Counters) page to show statistics for ACL hardware counters.

Parameters

These parameters are displayed:

- ◆ **Port** – Port identifier. (Range: 1-28/54)
- ◆ **Type** – Selects the type of ACL.
- ◆ **Direction** – Displays statistics for ingress or egress traffic.
- ◆ **Query** – Displays statistics for selected criteria.
- ◆ **ACL Name** – The ACL bound this port.
- ◆ **Action** – Shows if action is to permit or deny specified packets.
- ◆ **Rules** – Shows the rules for the ACL bound to this port.
- ◆ **Time-Range** – Name of a time range.
- ◆ **Hit** – Shows the number of packets matching this ACL.
- ◆ **Clear Counter** – Clears the hit counter for the specified ACL.

Web Interface

To show statistics for ACL hardware counters:

1. Click **Security > ACL**.
2. Select Configure Interface from the Step list.
3. Select Show Hardware Counters from the Action list.
4. Select a port.
5. Select ingress or egress traffic.

The screenshot shows the 'Security > ACL' web interface. At the top, there is a breadcrumb 'Security > ACL' and a help icon. Below this, there are two dropdown menus: 'Step: 2.Configure Interface' and 'Action: Show Hardware Counter'. The main configuration area includes three dropdown menus: 'Port' (set to '1'), 'Type' (set to 'IP Standard'), and 'Direction' (set to 'Ingress'). A 'Query' button is located below these options. Below the configuration area, the ACL name is 'rd' and the total count is 'Total 1'. At the bottom, there is a table with the following data:

Action	Source IP Address	Time-Range	Hit	Clear Counter
Permit	Any		14	<input type="button" value="Clear"/>

IP Filter

Use the Security > IP Filter page to create a list of up to 15 IP addresses or IP address groups that are allowed management access to the switch through the web interface, SNMP, or Telnet.

Command Usage

- ◆ The management interfaces are open to all IP addresses by default. Once you add an entry to a filter list, access to that interface is restricted to the specified addresses.
- ◆ If anyone tries to access a management interface on the switch from an invalid address, the switch will reject the connection, enter an event message in the system log, and send a trap message to the trap manager.
- ◆ IP address can be configured for SNMP, web and Telnet access respectively. Each of these groups can include up to five different sets of addresses, either individual addresses or address ranges.
- ◆ When entering addresses for the same group (i.e., SNMP, web or Telnet), the switch will not accept overlapping address ranges. When entering addresses for different groups, the switch will accept overlapping address ranges.
- ◆ You cannot delete an individual address from a specified range. You must delete the entire range, and reenter the addresses.
- ◆ You can delete an address range just by specifying the start address, or by specifying both the start address and end address.

Parameters

These parameters are displayed:

- ◆ **Mode**
 - ◆ **Web** – Configures IP address(es) for the web group.
 - ◆ **SNMP** – Configures IP address(es) for the SNMP group.
 - ◆ **Telnet** – Configures IP address(es) for the Telnet group.
 - ◆ **All** – Configures IP address(es) for all groups.
- ◆ **Start IP Address** – A single IP address, or the starting address of a range.
- ◆ **End IP Address** – The end address of a range.

Web Interface

To create a list of IP addresses authorized for management access:

1. Click **Security > IP Filter**.
2. Select Add from the Action list.
3. Select the management interface to filter (Web, SNMP, Telnet, All).
4. Enter the IP addresses or range of addresses that are allowed management access to an interface.
5. Click **Apply**.

The screenshot shows the 'Security > IP Filter' configuration page. The 'Action' dropdown is set to 'Add'. Under the 'Mode' section, the 'Web' radio button is selected, while 'SNMP', 'Telnet', and 'All' are unselected. The 'Start IP Address' field contains '10.1.2.3' and the 'End IP Address' field is empty. At the bottom right, there are 'Apply' and 'Revert' buttons.

To show a list of IP addresses authorized for management access:

1. Click **Security > IP Filter**.
2. Select Show from the Action list.

The screenshot shows the 'Security > IP Filter' configuration page with the 'Action' dropdown set to 'Show'. The 'Mode' section has 'SNMP' selected, with 'Web', 'Telnet', and 'All' unselected. Below this, it says 'SNMP IP Filter LIST Total: 1'. A table displays the filter details:

<input type="checkbox"/>	Start IP Address	End IP Address
<input type="checkbox"/>	10.1.2.3	10.1.2.3

At the bottom right, there are 'Delete' and 'Revert' buttons.

Port Security

Use the Security > Port Security page to configure the maximum number of device MAC addresses that can be learned by a switch port, stored in the address table, and authorized to access the network.

When port security is enabled on a port, the switch stops learning new MAC addresses on the specified port when it has reached a configured maximum number. Only incoming traffic with source addresses already stored in the address table will be authorized to access the network through that port. If a device with an unauthorized MAC address attempts to use the switch port, the intrusion will be detected and the switch can automatically take action by disabling the port and sending a trap message.

Command Usage

- ◆ The default maximum number of MAC addresses allowed on a secure port is zero (that is, disabled). To use port security, you must configure the maximum number of addresses allowed on a port.
- ◆ To configure the maximum number of address entries which can be learned on a port, and then specify the maximum number of dynamic addresses allowed. The switch will learn up to the maximum number of allowed address pairs <source MAC address, VLAN> for frames received on the port. When the port has reached the maximum number of MAC addresses, the port will stop learning new addresses. The MAC addresses already in the address table will be retained and will not be aged out.

Note that you can manually add additional secure addresses to a port using the Static Address Table.

- ◆ When the port security state is changed from enabled to disabled, all dynamically learned entries are cleared from the address table.
- ◆ If port security is enabled, and the maximum number of allowed addresses are set to a non-zero value, any device not in the address table that attempts to use the port will be prevented from accessing the switch.
- ◆ If a port is disabled (shut down) due to a security violation, it must be manually re-enabled from the Interface > Port > General page.
- ◆ A secure port has the following restrictions:
 - ◆ It cannot be used as a member of a static or dynamic trunk.
 - ◆ It should not be connected to a network interconnection device.
 - ◆ RSPAN and port security are mutually exclusive functions. If port security is enabled on a port, that port cannot be set as an RSPAN uplink port. Also, when a port is configured as an RSPAN uplink port,

source port, or destination port, port security cannot be enabled on that port.

Parameters

These parameters are displayed:

- ◆ **Port** – Port identifier.
- ◆ **Security Status** – Enables or disables port security on a port. (Default: Disabled)
- ◆ **Port Status** – The operational status:
 - ◆ Secure/Down – Port security is disabled.
 - ◆ Secure/Up – Port security is enabled.
 - ◆ Shutdown – Port is shut down due to a response to a port security violation.
- ◆ **Action** – Indicates the action to be taken when a port security violation is detected:
 - ◆ **None**: No action should be taken. (This is the default.)
 - ◆ **Trap**: Send an SNMP trap message.
 - ◆ **Shutdown**: Disable the port.
 - ◆ **Trap and Shutdown**: Send an SNMP trap message and disable the port.
- ◆ **Max MAC Count** – The maximum number of MAC addresses that can be learned on a port. (Range: 0 - 1024, where 0 means disabled)
The maximum address count is effective when port security is enabled or disabled.
- ◆ **Current MAC Count** – The number of MAC addresses currently associated with this interface.
- ◆ **MAC Filter** – Shows if MAC address filtering has been set under Security > Network Access (Configure MAC Filter).
- ◆ **MAC Filter ID** – The identifier for a MAC address filter.
- ◆ **Last Intrusion MAC** – The last unauthorized MAC address detected.
- ◆ **Last Time Detected Intrusion MAC** – The last time an unauthorized MAC address was detected.
- ◆ **Sticky MAC** – Sticky MAC addresses that port security has learned are dynamic addresses that cannot be moved to another port. If sticky MAC addresses are received on another secure port, then the port intrusion action is taken.

Web Interface

To configure port security:

1. Click **Security > Port Security**.
2. Mark the check box in the Security Status column to enable security, set the action to take when an invalid address is detected on a port, and set the maximum number of MAC addresses allowed on the port.
3. Click **Apply**.

Security > Port Security 1 2 3

Port Security List Total: 28

Port	Security Status	Port Status	Action	Max MAC Count (0-1024)	Current MAC Count	MAC Filter	MAC Filter ID	Last Intrusion MAC	Last Time Detected Intrusion MAC	Sticky MAC
1	<input type="checkbox"/> Enabled	Secure/Down	None	0	0	Disabled	0	NA	NA	<input type="checkbox"/> Enabled
2	<input type="checkbox"/> Enabled	Secure/Down	None	0	0	Disabled	0	NA	NA	<input type="checkbox"/> Enabled
3	<input type="checkbox"/> Enabled	Secure/Down	None	0	0	Disabled	0	NA	NA	<input type="checkbox"/> Enabled
4	<input type="checkbox"/> Enabled	Secure/Down	None	0	0	Disabled	0	NA	NA	<input type="checkbox"/> Enabled

Port Authentication

Network switches can provide open and easy access to network resources by simply attaching a client PC. Although this automatic configuration and access is a desirable feature, it also allows unauthorized personnel to easily intrude and possibly gain access to sensitive network data.

The IEEE 802.1X (dot1X) standard defines a port-based access control procedure that prevents unauthorized access to a network by requiring users to first submit credentials for authentication. Access to all switch ports in a network can be centrally controlled from a server, which means that authorized users can use the same credentials for authentication from any point within the network.

This switch uses the Extensible Authentication Protocol over LANs (EAPOL) to exchange authentication protocol messages with the client, and a remote RADIUS authentication server to verify user identity and access rights. When a client (i.e., Supplicant) connects to a switch port, the switch (i.e., Authenticator) responds with an EAPOL identity request. The client provides its identity (such as a user name) in an EAPOL response to the switch, which it forwards to the RADIUS server. The RADIUS server verifies the client identity and sends an access challenge back to the client. The EAP packet from the RADIUS server contains not only the challenge, but the authentication method to be used. The client can reject the authentication method and request another, depending on the configuration of the client software and the RADIUS server. The encryption method used to pass authentication messages can be MD5 (Message-Digest 5), TLS (Transport Layer Security), PEAP (Protected Extensible Authentication Protocol), or TTLS (Tunneled Transport Layer Security). The client responds to the appropriate method with its credentials, such as a password or certificate. The RADIUS server verifies the client credentials and responds with an accept or reject packet. If authentication is successful, the switch allows the client to access the network. Otherwise, non-EAP traffic on the port is blocked or assigned to a guest VLAN based on the “intrusion-action” setting. In “multi-host” mode, only one host connected to a port needs to pass authentication for all other hosts to be granted network access. Similarly, a port can become unauthorized for all hosts if one attached host fails re-authentication or sends an EAPOL logoff message.

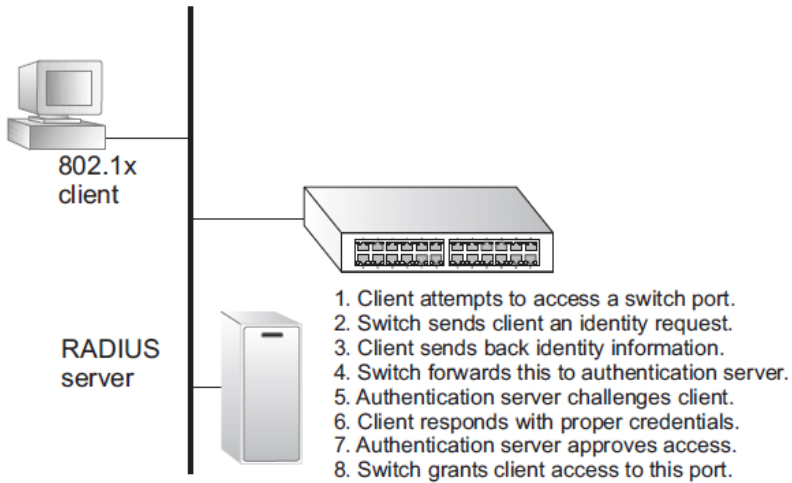

The operation of 802.1X on the switch requires the following:

- ◆ The switch must have an IP address assigned.
- ◆ RADIUS authentication must be enabled on the switch and the IP address of the RADIUS server specified.
- ◆ 802.1X must be enabled globally for the switch.
- ◆ Each switch port that will be used must be set to dot1X “Auto” mode.
- ◆ Each client that needs to be authenticated must have dot1X client software installed and properly configured.
- ◆ The RADIUS server and 802.1X client support EAP. (The switch only supports EAPOL in order to pass the EAP packets from the server to the client.)
- ◆ The RADIUS server and client also have to support the same EAP authentication type – MD5, PEAP, TLS, or TTLS. Native support for these encryption methods is provided in Windows 7, 8 and 10.

Configuring 802.1X Global Settings

Use the Security > Port Authentication (Configure Global) page to configure IEEE 802.1X port authentication. The 802.1X protocol must be enabled globally for the switch system before port settings are active.

Parameters

These parameters are displayed:

- ◆ **System Authentication Control** – Sets the global setting for 802.1X. (Default: Disabled)
- ◆ **EAPOL Pass Through** – Passes EAPOL frames through to all ports in STP forwarding state when dot1x is globally disabled. (Default: Disabled)
When this device is functioning as intermediate node in the network and does not need to perform dot1x authentication, **EAPOL Pass Through** can be enabled to allow the switch to forward EAPOL frames from other switches on to the authentication servers, thereby allowing the authentication process to still be carried out by switches located on the edge of the network.

When this device is functioning as an edge switch but does not require any attached clients to be authenticated, **EAPOL Pass Through** can be disabled to discard unnecessary EAPOL traffic.

- ◆ **Identity Profile User Name** – The dot1x supplicant user name. (Range: 1-8 characters)
The global supplicant user name and password are used to identify this switch as a supplicant when responding to an MD5 challenge from the authenticator. These parameters must be set when this switch passes client authentication requests to another authenticator on the network.
- ◆ **Set Password** – Allows the dot1x supplicant password to be entered.
- ◆ **Identity Profile Password** – The dot1x supplicant password used to identify this switch as a supplicant when responding to an MD5 challenge from the authenticator. (Range: 1-8 characters)
- ◆ **Confirm Profile Password** – This field is used to confirm the dot1x supplicant password.
- ◆ **Default** – Sets all configurable 802.1X global and port settings to their default values.

Web Interface

To configure global settings for 802.1X:

1. Click **Security > Port Authentication**.
2. Select Configure Global from the Step list.
3. Enable 802.1X globally for the switch, and configure EAPOL Pass Through if required.
4. Click **Apply**.

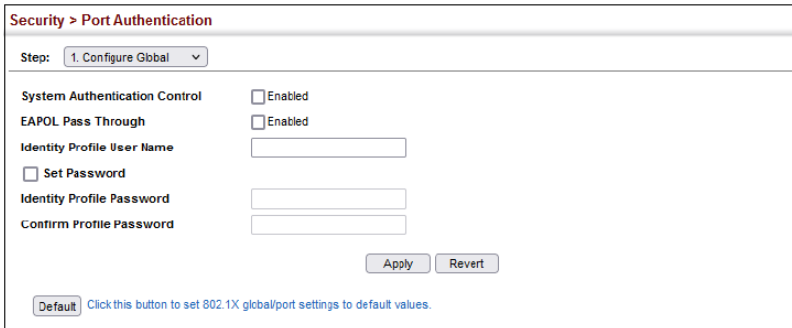

Security > Port Authentication

Step: 1. Configure Global

System Authentication Control Enabled

EAPOL Pass Through Enabled

Identity Profile User Name

Set Password

Identity Profile Password

Confirm Profile Password

Click this button to set 802.1X global/port settings to default values.

Configuring Port Authenticator Settings for 802.1X

Use the Security > Port Authentication (Configure Interface – Authenticator) page to configure 802.1X port settings for the switch as the local authenticator. When 802.1X is enabled, you need to configure the parameters for the authentication process that runs between the client and the switch (i.e., authenticator), as well as the client identity lookup process that runs between the switch and authentication server.

Command Usage

- ◆ When the switch functions as a local authenticator between supplicant devices attached to the switch and the authentication server, configure the parameters for the exchange of EAP messages between the authenticator and clients on the Authenticator configuration page.
- ◆ This switch can be configured to serve as the authenticator on selected ports by setting the Control Mode to Auto on this configuration page, and as a supplicant on other ports by the setting the control mode to Force-Authorized on this page and enabling the PAE supplicant on the Supplicant configuration page.

Parameters

These parameters are displayed:

- ◆ **Port** – Port number.
- ◆ **Status** – Indicates if authentication is enabled or disabled on the port. The status is disabled if the control mode is set to Force-Authorized.
- ◆ **Authorized** – Displays the 802.1X authorization status of connected clients.
 - ◆ **Yes** – Connected client is authorized.
 - ◆ **N/A** – Connected client is not authorized, or port is not connected.
- ◆ **Control Mode** – Sets the authentication mode to one of the following options:
 - ◆ **Auto** – Requires a dot1x-aware client to be authorized by the authentication server. Clients that are not dot1x-aware will be denied access.
 - ◆ **Force-Authorized** – Forces the port to grant access to all clients, either dot1x-aware or otherwise. (This is the default setting.)
 - ◆ **Force-Unauthorized** – Forces the port to deny access to all clients, either dot1x-aware or otherwise.
- ◆ **Operation Mode** – Allows single or multiple hosts (clients) to connect to an 802.1X-authorized port. (Default: Single-Host)
 - ◆ **Single-Host** – Allows only a single host to connect to this port.
 - ◆ **Multi-Host** – Allows multiple host to connect to this port.

In this mode, only one host connected to a port needs to pass authentication for all other hosts to be granted network access. Similarly, a port can become unauthorized for all hosts if one attached host fails re-authentication or sends an EAPOL logoff message.
- ◆ **MAC-Based** – Allows multiple hosts to connect to this port, with each host needing to be authenticated.

In this mode, each host connected to a port needs to pass authentication. The number of hosts allowed access to a port operating in this mode is limited only by the available space in the secure address table (i.e., up to 1024 addresses).
- ◆ **Max Count** – The maximum number of hosts that can connect to a port when the Multi-Host operation mode is selected. (Range: 1-1024; Default: 5)
- ◆ **Max Request** – Sets the maximum number of times the switch port will retransmit an EAP request packet to the client before it times out the authentication session. (Range: 1-10; Default 2)

- ◆ **Quiet Period** – Sets the time that a switch port waits after the Max Request Count has been exceeded before attempting to acquire a new client. (Range: 1-65535 seconds; Default: 60 seconds)
- ◆ **Tx Period** – Sets the time period during an authentication session that the switch waits before re-transmitting an EAP packet. (Range: 1-65535; Default: 30 seconds)
- ◆ **Supplicant Timeout** – Sets the time that a switch port waits for a response to an EAP request from a client before re-transmitting an EAP packet. (Range: 1-65535; Default: 30 seconds)

This command attribute sets the timeout for EAP-request frames other than EAP-request/identity frames. If dot1x authentication is enabled on a port, the switch will initiate authentication when the port link state comes up. It will send an EAP-request/identity frame to the client to request its identity, followed by one or more requests for authentication information. It may also send other EAP-request frames to the client during an active connection as required for reauthentication.

- ◆ **Server Timeout** – Sets the time that a switch port waits for a response to an EAP request from an authentication server before re-transmitting an EAP packet. (Default: 0 seconds)
A RADIUS server must be set before the correct operational value of 10 seconds will be displayed in this field.
- ◆ **Re-authentication Status** – Sets the client to be re-authenticated after the interval specified by the Re-authentication Period. Re-authentication can be used to detect if a new device is plugged into a switch port. (Default: Disabled)
- ◆ **Re-authentication Period** – Sets the time period after which a connected client must be re-authenticated. (Range: 1-65535 seconds; Default: 3600 seconds)
- ◆ **Re-authentication Max Retries** – The maximum number of times the switch port will retransmit an EAP request/identity packet to the client before it times out the authentication session. (Range: 1-10; Default: 2)
- ◆ **Intrusion Action** – Sets the port's response to a failed authentication.
 - ◆ **Block Traffic** – Blocks all non-EAP traffic on the port. (This is the default setting.)
 - ◆ **Guest VLAN** – All traffic for the port is assigned to a guest VLAN. The guest VLAN must be separately configured and mapped on each port.

Supplicant List

- ◆ **Supplicant** – MAC address of authorized client.

Authenticator PAE State Machine

- ◆ **State** – Current state (including initialize, disconnected, connecting, authenticating, authenticated, aborting, held, force_authorized, force_unauthorized).
- ◆ **Reauth Count** – Number of times connecting state is re-entered.
- ◆ **Current Identifier** – Identifier sent in each EAP Success, Failure or Request packet by the Authentication Server.

Backend State Machine

- ◆ **State** – Current state (including request, response, success, fail, timeout, idle, initialize).
- ◆ **Request Count** – Number of EAP Request packets sent to the Supplicant without receiving a response.
- ◆ **Identifier (Server)** – Identifier carried in the most recent EAP Success, Failure or Request packet received from the Authentication Server.

Reauthentication State Machine

- ◆ **State** – Current state (including initialize, reauthenticate).

Web Interface

To configure port authentication settings for 802.1X:

1. Click **Security > Port Authentication**.
2. Select Configure Interface from the Step list.
3. Modify the authentication settings for each port as required.
4. Click **Apply**.

Security > Port Authentication ?

Step: 2. Configure Interface

Type: Authenticator Supplicant

Port: 1

Status: Disabled

Authorized: Yes

Control Mode: Force-Authorized

Operation Mode: Single-Host

Max Count (1-1024): 5

Max Request (1-10): 2

Quiet Period (1-65535): 60 sec

Tx Period (1-65535): 30 sec

Supplicant Timeout (1-65535): 30 sec

Server Timeout: 0 sec

Re-authentication Status: Enabled

Re-authentication Period (1-65535): 3600 sec

Re-authentication Max Retries (1-10): 2

Intrusion Action: Block Traffic

Supplicant List Total: 0

Supplicant	Authenticator PAE State Machine			Backend State Machine			Reauthentication State Machine
	State	Reauth Count	Current Identifier	State	Request Count	Identifier (Server)	State

Apply
Revert

Configuring Port Supplicant Settings for 802.1X

Use the Security > Port Authentication (Configure Interface – Supplicant) page to configure 802.1X port settings for supplicant requests issued from a port to an authenticator on another device. When 802.1X is enabled and the control mode is set to Force-Authorized, you need to configure the parameters for the client supplicant process if the client must be authenticated through another device in the network.

Command Usage

- ◆ When devices attached to a port must submit requests to another authenticator on the network, configure the Identity Profile parameters on the Configure Global page which identify this switch as a supplicant, and configure the supplicant parameters for those ports which must authenticate clients through the remote authenticator on this configuration page. When PAE supplicant mode is enabled on a port, it will not respond to dot1x messages meant for an authenticator.
- ◆ This switch can be configured to serve as the authenticator on selected ports by setting the Control Mode to Auto on the Authenticator configuration page, and as a supplicant on other ports by the setting the

control mode to Force-Authorized on that configuration page and enabling the PAE supplicant on the Supplicant configuration page.

Parameters

These parameters are displayed:

- ◆ **Port** – Port number.
- ◆ **PAE Supplicant** – Enables PAE supplicant mode. (Default: Disabled)
If the attached client must be authenticated through another device in the network, supplicant status must be enabled.

Supplicant status can only be enabled if PAE Control Mode is set to “Force-Authorized” on this port.

PAE supplicant status cannot be enabled if a port is a member of trunk or LACP is enabled on the port.
- ◆ **Authentication Period** – The time that a supplicant port waits for a response from the authenticator. (Range: 1-65535 seconds; Default: 30 seconds)
- ◆ **Held Period** – The time that a supplicant port waits before resending its credentials to find a new an authenticator. (Range: 1-65535 seconds; Default: 30 seconds)
- ◆ **Start Period** – The time that a supplicant port waits before resending an EAPOL start frame to the authenticator. (Range: 1-65535 seconds; Default: 30 seconds)
- ◆ **Maximum Start** – The maximum number of times that a port supplicant will send an EAP start frame to the client before assuming that the client is 802.1X unaware. (Range: 1-65535; Default: 3)
- ◆ **Authenticated** – Shows whether or not the supplicant has been authenticated.

Web Interface

To configure port authenticator settings for 802.1X:

1. Click **Security > Port Authentication**.
2. Select Configure Interface from the Step list.
3. Click **Supplicant**.
4. Modify the supplicant settings for each port as required.
5. Click **Apply**.

Security > Port Authentication

Step: 2. Configure Interface ▼

Type Authenticator Supplicant

Port 1 ▼

PAE Supplicant Enabled

Authentication Period (1-65535)

Held Period (1-65535)

Start Period (1-65535)

Maximum Start (1-65535)

Authenticated No

Displaying 802.1X Statistics

Use the Security > Port Authentication (Show Statistics) page to display statistics for dot1x protocol exchanges for any port.

Parameters

These parameters are displayed:

Parameter	Description
<i>Authenticator</i>	
Rx EAPOL Start	The number of EAPOL Start frames that have been received by this Authenticator.
Rx EAPOL Logoff	The number of EAPOL Logoff frames that have been received by this Authenticator.
Rx EAPOL Invalid	The number of EAPOL frames that have been received by this Authenticator in which the frame type is not recognized.
Rx EAPOL Total	The number of valid EAPOL frames of any type that have been received by this Authenticator.
Rx Last EAPOLVer	The protocol version number carried in the most recent EAPOL frame received by this Authenticator.
Rx Last EAPOLSrc	The source MAC address carried in the most recent EAPOL frame received by this Authenticator.
Rx EAP Resp/Id	The number of EAP Resp/Id frames that have been received by this Authenticator.
Rx EAP Resp/Oth	The number of valid EAP Response frames (other than Resp/Id frames) that have been received by this Authenticator.
Rx EAP LenError	The number of EAPOL frames that have been received by this Authenticator in which the Packet Body Length field is invalid.

Parameter	Description
Tx EAP Req/Id	The number of EAP Req/Id frames that have been transmitted by this Authenticator.
Tx EAP Req/Oth	The number of EAP Request frames (other than Rq/Id frames) that have been transmitted by this Authenticator.
Tx EAPOL Total	The number of EAPOL frames of any type that have been transmitted by this Authenticator.
<i>Supplicant</i>	
Rx EAPOL Invalid	The number of EAPOL frames that have been received by this Supplicant in which the frame type is not recognized.
Rx EAPOL Total	The number of valid EAPOL frames of any type that have been received by this Supplicant.
Rx Last EAPOLVer	The protocol version number carried in the most recent EAPOL frame received by this Supplicant.
Rx Last EAPOLSrc	The source MAC address carried in the most recent EAPOL frame received by this Supplicant.
Rx EAP Resp/Id	The number of EAP Resp/Id frames that have been received by this Supplicant.
Rx EAP Resp/Oth	The number of valid EAP Response frames (other than Resp/Id frames) that have been received by this Supplicant.
Rx EAP LenError	The number of EAPOL frames that have been received by this Supplicant in which the Packet Body Length field is invalid.
Tx EAPOL Total	The number of EAPOL frames of any type that have been transmitted by this Supplicant.
Tx EAPOL Start	The number of EAPOL Start frames that have been transmitted by this Supplicant.
Tx EAPOL Logoff	The number of EAPOL Logoff frames that have been transmitted by this Supplicant.
Tx EAP Req/Id	The number of EAP Req/Id frames that have been transmitted by this Supplicant.
Tx EAP Req/Oth	The number of EAP Request frames (other than Req/Id frames) that have been transmitted by this Supplicant.

Web Interface

To display port authenticator statistics for 802.1X:

1. Click **Security > Port Authentication**.
2. Select Show Statistics from the Step list.
3. Click **Authenticator**.
4. Select a port.

Security > Port Authentication

Step: 3. Show Statistics

Type Authenticator Supplicant

Port 1

Port Authentication Authenticator Statistics

Rx EAPOL Start	0	Rx EAP Resp/Id	0
Rx EAPOL Logoff	0	Rx EAP Resp/Oth	0
Rx EAPOL Invalid	0	Rx EAP LenError	0
Rx EAPOL Total	0	Tx EAP Req/Id	0
Rx Last EAPOLVer	0	Tx EAP Req/Oth	0
Rx Last EAPOLSrc	00-00-00-00-00-00	Tx EAPOL Total	0

Refresh

To display port supplicant statistics for 802.1X:

1. Click **Security > Port Authentication**.
2. Select Show Statistics from the Step list.
3. Click **Supplicant**.
4. Select a port.

Security > Port Authentication

Step: 3. Show Statistics

Type Authenticator Supplicant

Port 1

Port Authentication Supplicant Statistics

Rx EAPOL Invalid	0	Rx EAP LenError	0
Rx EAPOL Total	0	Tx EAPOL Total	0
Rx Last EAPOLVer	0	Tx EAPOL Start	0
Rx Last EAPOLSrc	00-00-00-00-00-00	Tx EAPOL Logoff	0
Rx EAP Resp/Id	0	Tx EAP Req/Id	0
Rx EAP Resp/Oth	0	Tx EAP Req/Oth	0

Refresh

DoS Protection

Use the Security > DoS Protection page to protect against denial-of-service (DoS) attacks. A DoS attack is an attempt to block the services provided by a computer or network resource. This kind of attack tries to prevent an Internet site or service from functioning efficiently or at all. In general, DoS attacks are implemented by either forcing the target to reset, to consume most of its resources so that it can no longer provide its intended service, or to obstruct the communication media between the intended users and the target so that they can no longer communicate adequately. This section describes how to protect against DoS attacks.

Parameters

These parameters are displayed:

- ◆ **Echo/Chargen Attack** – Attacks in which the echo service repeats anything sent to it, and the chargen (character generator) service generates a continuous stream of data. When used together, they create an infinite loop and result in a denial-of-service. (Default: Disabled)
- ◆ **Echo/Chargen Attack Rate** – Maximum allowed rate. (Range: 64-2000 kbits/second; Default: 1000 kbits/second)
- ◆ **Smurf Attack** – Attacks in which a perpetrator generates a large amount of spoofed ICMP Echo Request traffic to the broadcast destination IP address (255.255.255.255), all of which uses a spoofed source address of the intended victim. The victim should crash due to the many interrupts required to send ICMP Echo response packets. (Default: Disabled)
- ◆ **TCP Flooding Attack** – Attacks in which a perpetrator sends a succession of TCP SYN requests (with or without a spoofed-Source IP) to a target and never returns ACK packets. These half-open connections will bind resources on the target, and no new connections can be made, resulting in a denial of service. (Default: Disabled)
- ◆ **TCP Flooding Attack Rate** – Maximum allowed rate. (Range: 64-2000 kbits/second; Default: 1000 kbits/second)
- ◆ **TCP Null Scan** – A TCP NULL scan message is used to identify listening TCP ports. The scan uses a series of strangely configured TCP packets which contain a sequence number of 0 and no flags. If the target's TCP port is closed, the target replies with a TCP RST (reset) packet. If the target TCP port is open, it simply discards the TCP NULL scan. (Default: Disabled)

- ◆ **TCP-SYN/FIN Scan** – A TCP SYN/FIN scan message is used to identify listening TCP ports. The scan uses a series of strangely configured TCP packets which contain SYN (synchronize) and FIN (finish) flags. If the target's TCP port is closed, the target replies with a TCP RST (reset) packet. If the target TCP port is open, it simply discards the TCP SYN FIN scan. (Default: Disabled)
- ◆ **TCP Xmas Scan** – A so-called TCP XMAS scan message is used to identify listening TCP ports. This scan uses a series of strangely configured TCP packets which contain a sequence number of 0 and the URG, PSH and FIN flags. If the target's TCP port is closed, the target replies with a TCP RST packet. If the target TCP port is open, it simply discards the TCP XMAS scan. (Default: Disabled)
- ◆ **TCP/UDP Packets with Port 0** – Protects against DoS attacks in which the TCP or UDP source port or destination port is set to zero. This technique may be used as a form of DoS attack, or it may just indicate a problem with the source device. When this command is enabled, the switch will drop these packets. (Default: Disabled)
- ◆ **UDP Flooding Attack** – Attacks in which a perpetrator sends a large number of UDP packets (with or without a spoofed-Source IP) to random ports on a remote host. The target will determine that application is listening at that port, and reply with an ICMP Destination Unreachable packet. It will be forced to send many ICMP packets, eventually leading it to be unreachable by other clients. (Default: Disabled)
- ◆ **UDP Flooding Attack Rate** – Maximum allowed rate. (Range: 64-2000 kbits/second; Default: 1000 kbits/second)
- ◆ **WinNuke Attack** – Attacks in which affected the Microsoft Windows 3.1x/95/NT operating systems. In this type of attack, the perpetrator sends the string of OOB out-of-band (OOB) packets contained a TCP URG flag to the target computer on TCP port 139 (NetBIOS), causing it to lock up and display a “Blue Screen of Death.” This did not cause any damage to, or change data on, the computer's hard disk, but any unsaved data would be lost. Microsoft made patches to prevent the WinNuke attack, but the OOB packets. (Default: Disabled)
- ◆ **WinNuke Attack Rate** – Maximum allowed rate. (Range: 64-2000 kbits/second; Default: 1000 kbits/second)

Web Interface

To protect against DoS attacks:

1. Click **Security > DoS Protection**.
2. Enable protection for specific DoS attacks, and set the maximum allowed rate as required.
3. Click **Apply**.

Security > DoS Protection

Echo/Chargen Attack	<input type="checkbox"/> Enabled
Echo/Chargen Attack Rate (64-2000)	<input type="text" value="1000"/> kbps
Smurf Attack	<input type="checkbox"/> Enabled
TCP Flooding Attack	<input type="checkbox"/> Enabled
TCP Flooding Attack Rate (64-2000)	<input type="text" value="1000"/> kbps
TCP Null Scan	<input type="checkbox"/> Enabled
TCP SYN/FILL Scan	<input type="checkbox"/> Enabled
TCP Xmas Scan	<input type="checkbox"/> Enabled
TCP/UDP Packets With Port 0	<input type="checkbox"/> Enabled
UDP Flooding Attack	<input type="checkbox"/> Enabled
UDP Flooding Attack Rate (64-2000)	<input type="text" value="1000"/> kbps
WinNuke Attack	<input type="checkbox"/> Enabled
WinNuke Attack Rate (64-2000)	<input type="text" value="1000"/> kbps

DHCP Snooping

The addresses assigned to DHCP clients on insecure ports can be carefully controlled using the dynamic bindings registered with DHCP Snooping (or using the static bindings configured with IP Source Guard). DHCP snooping allows a switch to protect a network from rogue DHCP servers or other devices which send port-related information to a DHCP server. This information can be useful in tracking an IP address back to a physical port.

Command Usage

DHCP Snooping Process

- ◆ Network traffic may be disrupted when malicious DHCP messages are received from an outside source. DHCP snooping is used to filter DHCP messages received on a non-secure interface from outside the network or fire wall. When DHCP snooping is enabled globally and enabled on a VLAN interface, DHCP messages received on an untrusted interface from a device not listed in the DHCP snooping table will be dropped.
- ◆ Table entries are only learned for trusted interfaces. An entry is added or removed dynamically to the DHCP snooping table when a client receives or releases an IP address from a DHCP server. Each entry includes a MAC address, IP address, lease time, VLAN identifier, and port identifier.
- ◆ The rate limit for the number of DHCP messages that can be processed by the switch is 100 packets per second. Any DHCP packets in excess of this limit are dropped.
- ◆ When DHCP snooping is enabled, DHCP messages entering an untrusted interface are filtered based upon dynamic entries learned via DHCP snooping.
- ◆ Filtering rules are implemented as follows:
 - ◆ If the global DHCP snooping is disabled, all DHCP packets are forwarded.
 - ◆ If DHCP snooping is enabled globally, and also enabled on the VLAN where the DHCP packet is received, all DHCP packets are forwarded for a *trusted* port. If the received packet is a DHCP ACK message, a dynamic DHCP snooping entry is also added to the binding table.
 - ◆ If DHCP snooping is enabled globally, and also enabled on the VLAN where the DHCP packet is received, but the port is *not trusted*, it is processed as follows:

- ◆ If the DHCP packet is a reply packet from a DHCP server (including OFFER, ACK or NAK messages), the packet is dropped.
- ◆ If the DHCP packet is from a client, such as a DECLINE or RELEASE message, the switch forwards the packet only if the corresponding entry is found in the binding table.
- ◆ If the DHCP packet is from a client, such as a DISCOVER, REQUEST, INFORM, DECLINE or RELEASE message, the packet is forwarded if MAC address verification is disabled. However, if MAC address verification is enabled, then the packet will only be forwarded if the client's hardware address stored in the DHCP packet is the same as the source MAC address in the Ethernet header.
 - ◆ If the DHCP packet is not a recognizable type, it is dropped.
- ◆ If a DHCP packet from a client passes the filtering criteria above, it will only be forwarded to trusted ports in the same VLAN.
- ◆ If a DHCP packet is from server is received on a trusted port, it will be forwarded to both trusted and untrusted ports in the same VLAN.
- ◆ If the DHCP snooping is globally disabled, all dynamic bindings are removed from the binding table.
- ◆ *Additional considerations when the switch itself is a DHCP client* – The port(s) through which the switch submits a client request to the DHCP server must be configured as trusted. Note that the switch will not add a dynamic entry for itself to the binding table when it receives an ACK message from a DHCP server. Also, when the switch sends out DHCP client packets for itself, no filtering takes place. However, when the switch receives any messages from a DHCP server, any packets received from untrusted ports are dropped.

DHCP Snooping Option 82

- ◆ DHCP provides a relay mechanism for sending information about its DHCP clients or the relay agent itself to the DHCP server. Also known as DHCP Option 82, it allows compatible DHCP servers to use the information when assigning IP addresses, or to set other services or policies for clients. It is also an effective tool in preventing malicious network attacks from attached clients on DHCP services, such as IP Spoofing, Client Identifier Spoofing, MAC Address Spoofing, and Address Exhaustion.
- ◆ DHCP Snooping must be enabled for Option 82 information to be inserted into request packets.

- ◆ When the DHCP Snooping Information Option 82 is enabled, the requesting client (or an intermediate relay agent that has used the information fields to describe itself) can be identified in the DHCP request packets forwarded by the switch and in reply packets sent back from the DHCP server. This information may specify the MAC address or IP address of the requesting device (that is, the switch in this context).
By default, the switch also fills in the Option 82 circuit-id field with information indicating the local interface over which the switch received the DHCP client request, including the port and VLAN ID. This allows DHCP client-server exchange messages to be forwarded between the server and client without having to flood them to the entire VLAN.
- ◆ If DHCP Snooping Information Option 82 is enabled on the switch, information may be inserted into a DHCP request packet received over any VLAN (depending on DHCP snooping filtering rules). The information inserted into the relayed packets includes the circuit-id and remote-id, as well as the gateway Internet address.
- ◆ When the switch receives DHCP packets from clients that already include DHCP Option 82 information, the switch can be configured to set the action policy for these packets. The switch can either drop the DHCP packets, keep the existing information, or replace it with the switch's relay information.

DHCP Snooping Global Configuration

Use the Security > DHCP Snooping (Configure Global) page to enable DHCP Snooping globally on the switch, or to configure MAC Address Verification.

Parameters

These parameters are displayed:

General

- ◆ **DHCP Snooping Status** – Enables DHCP snooping globally. (Default: Disabled)
- ◆ **DHCP Snooping MAC-Address Verification** – Enables or disables MAC address verification. If the source MAC address in the Ethernet header of the packet is not same as the client's hardware address in the DHCP packet, the packet is dropped. (Default: Enabled)
- ◆ **DHCP Snooping Rate Limit** – Sets the maximum number of DHCP packets that can be trapped by the switch for DHCP snooping. (Range: 1-2048 packets/second)

Information

- ◆ **DHCP Snooping Information Option Status** – Enables or disables DHCP Option 82 information relay. (Default: Disabled)
- ◆ **DHCP Snooping Information Option Sub-option Format** – Enables or disables use of sub-type and sub-length fields in circuit-ID (CID) and remote-ID (RID) in Option 82 information. (Default: Enabled)
- ◆ **DHCP Snooping Information Option Remote ID** – Specifies the MAC address, IP address, or arbitrary identifier of the requesting device (i.e., the switch in this context).
 - ◆ **MAC Address** – Inserts a MAC address in the remote ID sub-option for the DHCP snooping agent (i.e., the MAC address of the switch’s CPU). This attribute can be encoded in Hexadecimal or ASCII.
 - ◆ **IP Address** – Inserts an IP address in the remote ID sub-option for the DHCP snooping agent (i.e., the IP address of the management interface). This attribute can be encoded in Hexadecimal or ASCII.
 - ◆ *string* - An arbitrary string inserted into the remote identifier field. (Range: 1-32 characters)
- ◆ **DHCP Snooping Information Option Remote ID TR101 VLAN Field** – Adds “:VLAN” in TR101 field for untagged packets.

The format for TR101 option 82 is: “<IP> eth <SID>/<PORT>[:<VLAN>]”. Note that the SID (Switch ID) is always 0. By default the PVID is added to the end of the TR101 field for untagged packets. For tagged packets, the VLAN ID is always added.
- ◆ **DHCP Snooping Information Option TR101 Board ID** – Sets the board identifier used in Option 82 information based on TR-101 syntax. (Range: 0-9; Default: undefined)
- ◆ **DHCP Snooping Information Option Policy** – Specifies how to handle DHCP client request packets which already contain Option 82 information.
 - ◆ **Drop** – Drops the client’s request packet instead of relaying it.
 - ◆ **Keep** – Retains the Option 82 information in the client request, and forwards the packets to trusted ports.
 - ◆ **Replace** – Replaces the Option 82 information circuit-id and remote-id fields in the client’s request with information about the relay agent itself, inserts the relay agent’s address (when DHCP snooping is enabled), and forwards the packets to trusted ports. (This is the default policy.)

Web Interface

To configure global settings for DHCP Snooping:

1. Click **IP Service > DHCP > Snooping**.
2. Select Configure Global from the Step list.
3. Select the required options for the general DHCP snooping process and for the DHCP snooping information option.
4. Click **Apply**.

Security > DHCP Snooping

Step: 1. Configure Global

General

DHCP Snooping Status Enabled

DHCP Snooping MAC Address Verification Enabled

DHCP Snooping Rate Limit 0 (pkt/sec)

Information

DHCP Snooping Information Option Status Enabled

DHCP Snooping Information Option Sub-option Format Extra Subtype Included

DHCP Snooping Information Option Remcote ID MAC Address (Hex Encoded)

DHCP Snooping Information Option Remcote ID TR101 VLAN Field Enabled

DHCP Snooping Information Option TR101 Board ID none

DHCP Snooping Information Option Policy Replace

Apply Revert

DHCP Snooping VLAN Configuration

Use the Security > DHCP Snooping (Configure VLAN) page to enable or disable DHCP snooping on specific VLANs.

Command Usage

- ◆ When DHCP snooping is enabled globally on the switch, and enabled on the specified VLAN, DHCP packet filtering will be performed on any untrusted ports within the VLAN.
- ◆ When the DHCP snooping is globally disabled, DHCP snooping can still be configured for specific VLANs, but the changes will not take effect until DHCP snooping is globally re-enabled.
- ◆ When DHCP snooping is globally enabled, and DHCP snooping is then disabled on a VLAN, all dynamic bindings learned for this VLAN are removed from the binding table.

Parameters

These parameters are displayed:

- ◆ **VLAN** – ID of a configured VLAN. (Range: 1-4094)
- ◆ **DHCP Snooping Status** – Enables or disables DHCP snooping for the selected VLAN. When DHCP snooping is enabled globally on the switch, and enabled on the specified VLAN, DHCP packet filtering will be performed on any untrusted ports within the VLAN. (Default: Disabled)

Web Interface

To configure global settings for DHCP Snooping:

1. Click **IP Service > DHCP > Snooping**.
2. Select Configure VLAN from the Step list.
3. Enable DHCP Snooping on any existing VLAN.
4. Click **Apply**.

The screenshot shows a web interface for configuring DHCP Snooping. The breadcrumb path is "IP Service > DHCP > Snooping". Below the breadcrumb, there is a "Step:" dropdown menu set to "2. Configure VLAN". Underneath, there is a "VLAN" dropdown menu set to "1". Below that, there is a "DHCP Snooping Status" checkbox that is checked, with the text "Enabled" next to it. At the bottom right of the form, there are two buttons: "Apply" and "Revert".

Configuring Ports for DHCP Snooping

Use the Security > DHCP Snooping (Configure Interface) page to configure switch ports as trusted or untrusted.

Command Usage

- ◆ A trusted interface is an interface that is configured to receive only messages from within the network. An untrusted interface is an interface that is configured to receive messages from outside the network or fire wall.
- ◆ When DHCP snooping is enabled both globally and on a VLAN, DHCP packet filtering will be performed on any untrusted ports within the VLAN.
- ◆ When an untrusted port is changed to a trusted port, all the dynamic DHCP snooping bindings associated with this port are removed.

- ♦ Set all ports connected to DHCP servers within the local network or fire wall to trusted state. Set all other ports outside the local network or fire wall to untrusted state.
- ♦ The format for TR101 option 82 is: “<IP> eth <SID>/<PORT>[:<VLAN>]”. Note that the SID (Switch ID) is always 0. By default the PVID is added to the end of the TR101 field for untagged packets. For tagged packets, the VLAN ID is always added.

Parameters

These parameters are displayed:

- ♦ **Trust Status** – Enables or disables a port as trusted. (Default: Disabled)
- ♦ **Max Number** – The maximum number of DHCP clients which can be supported per interface. (Range: 1-32; Default: 16)
- ♦ **Circuit ID** – Specifies DHCP Option 82 circuit ID suboption information.
 - ♦ **Mode** – Specifies the default string “VLAN-Unit-Port” or an arbitrary string. (Default: VLAN-Unit-Port)
 - ♦ **Value** – An arbitrary string inserted into the circuit identifier field. (Range: 1-32 characters)
 - ♦ **TR101 VLAN Field** – Adds “:VLAN” in TR101 field for untagged packets.

Web Interface

To configure global settings for DHCP Snooping:

1. Click **IP Service > DHCP > Snooping**.
2. Select Configure Interface from the Step list.
3. Set any ports within the local network or firewall to trusted.
4. Specify the mode used for sending circuit ID information, and an arbitrary string if required.
5. Click **Apply**.

Security > DHCP Snooping ?

Step: 3 Configure Interface

Interface Port Trunk

DHCP Snooping Port List Total: 28 1 2 3

Port	Trust Status	Max Number (1-16)	Circuit ID		
			Mode	Value	TR101 VLAN Field
1	<input type="checkbox"/> Enabled	<input type="text" value="16"/>	VLAN-Unit-Port	<input type="text"/>	<input checked="" type="checkbox"/> Enabled
2	<input type="checkbox"/> Enabled	<input type="text" value="16"/>	VLAN-Unit-Port	<input type="text"/>	<input checked="" type="checkbox"/> Enabled
3	<input type="checkbox"/> Enabled	<input type="text" value="16"/>	VLAN-Unit-Port	<input type="text"/>	<input checked="" type="checkbox"/> Enabled
4	<input type="checkbox"/> Enabled	<input type="text" value="10"/>	VLAN-Unit-Port	<input type="text"/>	<input checked="" type="checkbox"/> Enabled
5	<input type="checkbox"/> Enabled	<input type="text" value="16"/>	VLAN-Unit-Port	<input type="text"/>	<input checked="" type="checkbox"/> Enabled

Displaying DHCP Snooping Binding Information

Use the Security > DHCP Snooping (Show Information) page to display entries in the binding table.

Parameters

These parameters are displayed:

- ◆ **MAC Address** – Physical address associated with the entry.
- ◆ **IP Address** – IP address corresponding to the client.
- ◆ **Lease Time** – The time for which this IP address is leased to the client.
- ◆ **Type** – Entry types include:
 - ◆ **DHCP-Snooping** – Dynamically snooped.
 - ◆ **Static-DHCPSNP** – Statically configured.
- ◆ **VLAN** – VLAN to which this entry is bound.
- ◆ **Interface** – Port or trunk to which this entry is bound.
- ◆ **Store** – Writes all dynamically learned snooping entries to flash memory. This function can be used to store the currently learned dynamic DHCP snooping entries to flash memory. These entries will be restored to the snooping table when the switch is reset. However, note that the lease time shown for a dynamic entry that has been restored from flash memory will no longer be valid.
- ◆ **Clear** – Removes all dynamically learned snooping entries from flash memory.

Web Interface

To display the binding table for DHCP Snooping:

1. Click **IP Service > DHCP > Snooping**.
2. Select Show Information from the Step list.
3. Use the Store or Clear function if required.

IP Service > DHCP > Snooping ?

Step: 4. Show Information

DHCP Snooping Binding List Total: 6

MAC Address	IP Address	Lease Time (seconds)	Type	VLAN	Interface
00-10-B5-F4-00-01	10.2.44.96	5	DHCP-Snooping	1	Trunk 1
00-10-B5-F4-00-02	10.3.44.96	15	Static-DHCPSPNP	1	Unit 1 / Port 2
00-10-B5-F4-00-03	10.4.44.96	25	DHCP-Snooping	1	Unit 1 / Port 3
00-10-B5-F4-00-04	10.5.44.96	10	Static-DHCPSPNP	1	Trunk 4
00-10-B5-F4-00-05	10.6.44.96	10	DHCP-Snooping	1	Unit 1 / Port 5
00-10-B5-F4-00-06	10.7.44.96	5	Static-DHCPSPNP	1	Unit 1 / Port 6

Click the button to Store DHCP Snooping binding entries to flash.

Click the button to Clear DHCP Snooping binding entries from flash.

DHCPv6 Snooping

The addresses assigned to DHCPv6 clients on insecure ports can be carefully controlled using the dynamic bindings registered with DHCPv6 Snooping (or using the static bindings configured with IPv6 Source Guard). DHCPv6 snooping allows a switch to protect a network from rogue DHCPv6 servers or other devices which send port-related information to a DHCPv6 server. This information can be useful in tracking an IP address back to a physical port.

Command Usage

DHCP Snooping Process

- ◆ Network traffic may be disrupted when malicious DHCPv6 messages are received from an outside source. DHCPv6 snooping is used to filter DHCPv6 messages received on a unsecured interface from outside the network or fire wall. When DHCPv6 snooping is enabled globally and enabled on a VLAN interface, DHCPv6 messages received on an untrusted interface from a device not listed in the DHCPv6 snooping table will be dropped.
- ◆ When enabled, DHCPv6 messages entering an untrusted interface are filtered based upon dynamic entries learned via DHCPv6 snooping.
- ◆ Table entries are only learned for trusted interfaces. Each entry includes a MAC address, IPv6 address, lease time, binding type, VLAN identifier, and port identifier.
- ◆ When DHCPv6 snooping is enabled, the rate limit for the number of DHCPv6 messages that can be processed by the switch is 100 packets per second. Any DHCPv6 packets in excess of this limit are dropped.
- ◆ Filtering rules are implemented as follows:
 - ◆ If global DHCPv6 snooping is disabled, all DHCPv6 packets are forwarded.
 - ◆ If DHCPv6 snooping is enabled globally, and also enabled on the VLAN where the DHCPv6 packet is received, DHCPv6 packets are forwarded for a *trusted* port as described below.
 - ◆ If DHCPv6 snooping is enabled globally, and also enabled on the VLAN where the DHCP packet is received, but the port is *not trusted*, DHCP packets are processed according to message type as follows:

DHCP Client Packet

- ◆ Request: Update entry in binding cache, recording client's DHCPv6 Unique Identifier (DUID), server's DUID, Identity

Association (IA) type, IA Identifier, and address (4 message exchanges to get IPv6 address), and forward to trusted port.

- ◆ Solicit: Add new entry in binding cache, recording client's DUID, IA type, IA ID (2 message exchanges to get IPv6 address with rapid commit option, otherwise 4 message exchanges), and forward to trusted port.
- ◆ Decline: If no matching entry is found in binding cache, drop this packet.
- ◆ Renew, Rebind, Release, Confirm: If no matching entry is found in binding cache, drop this packet.

If a DHCPv6 packet from a client passes the filtering criteria above, it will only be forwarded to trusted ports in the same VLAN.

DHCP Server Packet

- ◆ If a DHCP server packet is received on an *untrusted* port, drop this packet and add a log entry in the system.
- ◆ If a DHCPv6 Reply packet is received from a server on a *trusted* port, it will be processed in the following manner:
 - A. Check if IPv6 address in IA option is found in binding table:
 - ◆ If yes, continue to C.
 - ◆ If not, continue to B.
 - ◆ Check if IPv6 address in IA option is found in binding cache:
 - ◆ If yes, continue to C.
 - ◆ If not, check failed, and forward packet to trusted port.
 - B. Check status code in IA option:
 - ◆ If successful, and entry is in binding table, update lease time and forward to original destination.
 - ◆ If successful, and entry is in binding cache, move entry from binding cache to binding table, update lease time and forward to original destination.
 - ◆ Otherwise, remove binding entry. and check failed.
 - ◆ If a DHCPv6 Relay packet is received, check the relay message option in Relay-Forward or Relay-Reply packet, and process client and server packets as described above.
- ◆ If DHCPv6 snooping is globally disabled, all dynamic bindings are removed from the binding table.
- ◆ *Additional considerations when the switch itself is a DHCPv6 client* – The port(s) through which the switch submits a client request to the DHCPv6

server must be configured as trusted. Note that the switch will not add a dynamic entry for itself to the binding table when it receives an ACK message from a DHCPv6 server. Also, when the switch sends out DHCPv6 client packets for itself, no filtering takes place. However, when the switch receives any messages from a DHCPv6 server, any packets received from untrusted ports are dropped.

DHCPv6 Snooping Global Configuration

Use the Security > DHCP Snooping6 (Configure Global) page to enable DHCPv6 Snooping globally on the switch, or to configure MAC Address Verification.

Parameters

These parameters are displayed:

- ◆ **DHCPv6 Snooping Status** – Enables DHCPv6 snooping globally. (Default: Disabled)
- ◆ **DHCPv6 Snooping Option Remote ID** – Enables the insertion of remote-id option 37 information into DHCPv6 client messages. Remote-id option information such as the port attached to the client, DUID, and VLAN ID is used by the DHCPv6 server to assign preassigned configuration data specific to the DHCPv6 client. (Default: Disabled)
 - ◆ DHCPv6 provides a relay mechanism for sending information about the switch and its DHCPv6 clients to the DHCPv6 server. Known as DHCPv6 Option 37, it allows compatible DHCPv6 servers to use the information when assigning IP addresses, or to set other services or policies for clients.
 - ◆ When DHCPv6 Snooping Information Option 37 is enabled, the requesting client (or an intermediate relay agent that has used the information fields to describe itself) can be identified in the DHCPv6 request packets forwarded by the switch and in reply packets sent back from the DHCPv6 server.
 - ◆ When the DHCPv6 Snooping Option 37 is enabled, clients can be identified by the switch port to which they are connected rather than just their MAC address. DHCPv6 client-server exchange messages are then forwarded directly between the server and client without having to flood them to the entire VLAN.
 - ◆ DHCPv6 snooping must be enabled for the DHCPv6 Option 37 information to be inserted into packets. When enabled, the switch will either drop, keep or remove option 37 information in incoming DHCPv6 packets. Packets are processed as follows:

- ◆ If an incoming packet is a DHCPv6 request packet with option 37 information, it will modify the option 37 information according to the settings specified.
- ◆ If an incoming packet is a DHCPv6 request packet without option 37 information, enabling the DHCPv6 snooping information option will add option 37 information to the packet.
- ◆ If an incoming packet is a DHCPv6 reply packet with option 37 information, enabling the DHCPv6 snooping information option will remove option 37 information from the packet.
- ◆ When this switch inserts Option 37 information in DHCPv6 client request packets, the switch's MAC address (hexadecimal) is used for the remote ID.
- ◆ **DHCPv6 Snooping Option Policy** – Sets the remote-id option policy for DHCPv6 client packets that include Option 37 information.

When the switch receives DHCPv6 packets from clients that already include DHCP Option 37 information, the switch can be configured to set the action policy for these packets. The switch can either drop the DHCPv6 packets, keep the existing information, or replace it with the switch's relay agent information.

- ◆ **Drop** – Drops the client's request packet instead of relaying it. (This is the default policy.)
- ◆ **Keep** – Retains the Option 82 information in the client request, and forwards the packets to trusted ports.
- ◆ **Replace** – Replaces the Option 37 remote-ID in the client's request with the relay agent's remote-ID (when DHCPv6 snooping is enabled), and forwards the packets to trusted ports.

Web Interface

To configure global settings for DHCPv6 Snooping:

1. Click **Security > DHCP Snooping6**.
2. Select Configure Global from the Step list.
3. Select the required options for the DHCPv6 snooping process and for the DHCPv6 snooping information options.
4. Click **Apply**.

Security > DHCP Snooping6

Step: 1. Configure Global ▼

DHCPv6 Snooping Status Enabled

DHCPv6 Snooping Option Remote ID Enabled

DHCPv6 Snooping Option Policy ▼

Apply Revert

DHCPv6 Snooping VLAN Configuration

Use the Security > DHCP Snooping6 (Configure VLAN) page to enable or disable DHCPv6 snooping on specific VLANs.

Command Usage

- ◆ When DHCPv6 snooping enabled globally and enabled on a VLAN, DHCPv6 packet filtering will be performed on any untrusted ports within the VLAN.
- ◆ When the DHCPv6 snooping is globally disabled, DHCPv6 snooping can still be configured for specific VLANs, but the changes will not take effect until DHCPv6 snooping is globally re-enabled.
- ◆ When DHCPv6 snooping is enabled globally, and then disabled on a VLAN, all dynamic bindings learned for this VLAN are removed from the binding table.

Parameters

These parameters are displayed:

- ◆ **VLAN** – ID of a configured VLAN. (Range: 1-4094)

Web Interface

To configure global settings for DHCPv6 Snooping:

1. Click **Security > DHCP Snooping6**.
2. Select Configure VLAN from the Step list.
3. Select Add from the Action list.
4. Select a VLAN on which to enable DHCPv6 Snooping.
5. Click **Apply**.

Security > DHCP Snooping6

Step: 2. Configure VLAN Action: Add

VLAN ID (1-4094) 1 -

Apply Revert

To show the VLANs for which DHCPv6 Snooping is enabled:

1. Click **Security > DHCP Snooping6**.
2. Select Configure VLAN from the Step list.
3. Select Show from the Action list.

Security > DHCP Snooping6

Step: 2. Configure VLAN Action: Show

DHCPv6 Snooping VLAN List Total: 1

	VLAN
<input type="checkbox"/>	1

Apply Revert

Configuring Interfaces for DHCPv6 Snooping

Use the Security > DHCP Snooping6 (Configure Interface) page to configure switch interfaces as trusted or untrusted, and set the maximum number of entries which can be stored in the binding database for an interface.

Command Usage

- ◆ A trusted interface is an interface that is configured to receive only messages from within the network. An untrusted interface is an interface that is configured to receive messages from outside the network or fire wall.
- ◆ Set all interfaces connected to DHCv6 servers within the local network or fire wall to trusted, and all other interfaces outside the local network or fire wall to untrusted.
- ◆ When DHCPv6 snooping is enabled globally and enabled on a VLAN, DHCPv6 packet filtering will be performed on any untrusted ports within the VLAN according to the default status, or as specifically configured for an interface.
- ◆ When an untrusted port is changed to a trusted port, all the dynamic DHCPv6 snooping bindings associated with this port are removed.

- ◆ *Additional considerations when the switch itself is a DHCPv6 client* – The port(s) through which it submits a client request to the DHCPv6 server must be configured as trusted.

Parameters

These parameters are displayed:

- ◆ **Interface** – Port or trunk identifier.
- ◆ **Trust Status** – Enables or disables an interface as trusted. (Default: Disabled)
- ◆ **Max Binding** – Sets the maximum number of entries which can be stored in the binding database for an interface. (Range: 1-5; Default: 5)
- ◆ **Current Binding** – Shows the maximum number of entries which can be stored in the binding database for an interface.

Web Interface

To configure the trust status and maximum bindings for DHCPv6 Snooping:

1. Click **Security > DHCP Snooping6**.
2. Select **Configure Interface** from the Step list.
3. Set any interfaces within the local network or firewall to trusted.
4. Set the maximum number of entries which can be stored for an interface.
5. Click **Apply**.

Security > DHCP Snooping6 ?			
Step: 3. Configure Interface			
DHCPv6 Snooping Interface List Total: 28			
Interface	Trust Status	Max Binding (1 - 5)	Current Binding
Eth 1/1	<input type="checkbox"/> Enabled	<input type="text" value="5"/>	0
Eth 1/2	<input type="checkbox"/> Enabled	<input type="text" value="5"/>	0
Eth 1/3	<input type="checkbox"/> Enabled	<input type="text" value="5"/>	0
Eth 1/4	<input type="checkbox"/> Enabled	<input type="text" value="5"/>	0
Eth 1/5	<input type="checkbox"/> Enabled	<input type="text" value="5"/>	0

Displaying DHCPv6 Snooping Binding Information

Use the Security > DHCP Snooping6 (Show Information – Binding) page to display entries in the binding table.

Parameters

These parameters are displayed:

- ◆ **Link-layer Address** – IPv6 link-layer address associated with the entry.
- ◆ **IPv6 Address** – IPv6 address corresponding to the client.
- ◆ **Lifetime** – The time (number of seconds) for which this IPv6 address is leased to the client.
- ◆ **VLAN** – VLAN to which this entry is bound.
- ◆ **Interface** – Port or trunk to which this entry is bound.
- ◆ **Type** – Entry types include:
 - ◆ **NA** – Non-temporary address.
 - ◆ **TA** – Temporary address.
- ◆ **Clear** – Removes all dynamically learned snooping entries from RAM.

Web Interface

To display the binding table for DHCPv6 Snooping:

1. Click **Security > DHCP Snooping6**.
2. Select Show Information from the Step list.
3. Click **Binding**.
4. Use the Clear function if required.

The screenshot shows the 'Security > DHCP Snooping6' web interface. The 'Step' dropdown is set to '4. Show Information'. The 'Binding' radio button is selected. Below the interface is a table titled 'DHCPv6 Snooping Binding List Total: 3'.

	Link-layer Address	IPv6 Address	Lifetime	VLAN	Interface	Type
<input type="checkbox"/>	00-13-49-AA-39-26	2001:b021:1435:5612:ab3c:6792:a452:6712	2591998	1	Eth 1/5	NA
<input type="checkbox"/>	00-12-CF-01-02-03	2001:b000:1	2591912	1	Eth 1/3	NA
<input type="checkbox"/>	00-12-CF-01-02-04	2001:b000:3	2591555	1	Trunk2	TA

Below the table is a 'Clear' button.

Displaying DHCPv6 Snooping Statistics

Use the Security > DHCP Snooping6 (Show Information – Statistics) page to display information on client, server, and relay packets.

Parameters

These parameters are displayed:

- ◆ **State** – Packet states include received, sent and dropped.
- ◆ *Types*
 - ◆ **Client Packet** – Includes Solicit, Request, Confirm, Renew, Rebind, Decline, Release and Information-request.
 - ◆ **Server Packet** – Includes Advertise, Reply, and Reconfigure.
 - ◆ **Relay Packet** – Includes Relay-forward and Relay-reply.

Web Interface

To display statistics for DHCPv6 Snooping:

1. Click **Security > DHCP Snooping6**.
2. Select Show Information from the Step list.
3. Click **Statistics**.
4. Use the Clear function if required.

Security > DHCP Snooping6

Step: 4, Show Information

Binding Statistics

DHCPv6 Snooping Statistics

Client Packet: Solicit, Request, Confirm, Renew, Rebind, Decline, Release, Information-request

Server Packet: Advertise, Reply, Reconfigure

Relay Packet: Relay-forward, Relay-reply

State	Client	Server	Relay	Total
Received	0	0	0	0
Sent	0	0	0	0
Dropped	0	0	0	0

ND Snooping

Neighbor Discovery (ND) Snooping maintains an IPv6 prefix table and user address binding table. These tables can be used for stateless address auto-configuration or for address filtering by IPv6 Source Guard.

ND snooping maintains a binding table in the process of neighbor discovery. When it receives a Neighbor Solicitation (NS) packet from a host, it creates a new binding. If it subsequently receives a Neighbor Advertisement (NA) packet, this means that the address is already being used by another host, and the binding is therefore deleted. If it does not receive an NA packet after a timeout period, the binding will be bound to the original host. ND snooping can also maintain a prefix table used for stateless address auto-configuration by monitoring Router Advertisement (RA) packets sent from neighboring routers.

ND snooping can also detect if an IPv6 address binding is no longer valid. When a binding has been timed out, it checks to see if the host still exists by sending an NS packet to the target host. If it receives an NA packet in response, it knows that the target still exists and updates the lifetime of the binding; otherwise, it deletes the binding.

Usage Guidelines

- ◆ ND snooping must be enabled globally on the switch and on a specific VLAN or a range of VLANs.
- ◆ Once ND snooping is enabled both globally and on the required VLANs, the switch will start monitoring RA messages to build an address prefix table as described below:
 - ◆ If an RA message is received on an untrusted interface, it is dropped. If received on a trusted interface, the switch adds an entry in the prefix table according to the Prefix Information option in the RA message. The prefix table records prefix, prefix length, valid lifetime, as well as the VLAN and port interface which received the message.
 - ◆ If an RA message is not received updating a table entry with the same prefix for a specified timeout period, the entry is deleted.
- ◆ Once ND snooping is enabled both globally and on the required VLANs, the switch will start monitoring NS messages to build a dynamic user binding table for use in Duplicate Address Detection (DAD) or for use by other security filtering protocols (e.g., IPv6 Source Guard) as described below:
 - ◆ If an NS message is received on an trusted interface, it is forwarded without further processing.

- ◆ If an NS message is received on an untrusted interface, and the address prefix does not match any entry in the prefix table, it drops the packet.
- ◆ If the message does match an entry in the prefix table, it adds an entry to the dynamic user binding table after a fixed delay, and forwards the packet. Each entry in the dynamic binding table includes the link-layer address, IPv6 address, lifetime, as well as the VLAN and port interface which received the message.
- ◆ If an RA message is received in response to the original NS message (indicating a duplicate address) before the dynamic binding timeout period expires, the entry is deleted. Otherwise, when the timeout expires, the entry is dropped if the auto-detection process is not enabled.
- ◆ If the auto-detection process is enabled, the switch periodically sends an NS message to determine if the client still exists. If it does not receive an RA message in response after the configured timeout, the entry is dropped. If the switch receives an RA message before the timeout expires, it resets the lifetime for the dynamic binding, and the auto-detection process resumes.

ND Snooping Global Configuration

Use the Security > ND Snooping > Configure Global page to enable ND snooping globally on the switch.

Parameters

These parameters are displayed:

- ◆ **ND Snooping Status** – Enables ND Snooping globally on the switch. (Default: Disabled)
- ◆ **ND Snooping Auto-detect** – Enables automatic validation of dynamic user binding table entries by periodically sending NS messages and awaiting NA replies.

If auto-detection is enabled, the switch periodically sends an NS message to determine if a client listed in the dynamic binding table still exists. If it does not receive an RA message in response after the configured timeout, the entry is dropped. If the switch receives an RA message before the timeout expires, it resets the lifetime for the dynamic binding, and the auto-detection process resumes. (Default: Disabled)

- ◆ **ND Snooping Retransmit Count** – Sets the number of times the auto-detection process sends an NS message to determine if a dynamic user binding is still valid. (Range: 1-5 seconds; Default: 3 seconds)

- ◆ **ND Snooping Retransmit Interval** – Sets the interval between which the auto-detection process sends NS messages to determine if a dynamic user binding is still valid.

The timeout after which the switch will delete a dynamic user binding if no RA message is received is set to the retransmit count multiplied by the retransmit interval. (Range: 1-10 seconds; Default: 1 second)

- ◆ **ND Snooping Prefix Timeout** – Sets the time to wait for an RA message before deleting an entry in the prefix table. If ND snooping is enabled and an RA message is received on a trusted interface, the switch will add an entry in the prefix table based upon the Prefix Information contained in the message. If an RA message is not received for a table entry with the same prefix for the specified timeout period, the entry is deleted. (Range: 3-1800 seconds; Default: *none set*)

Web Interface

To configure ND Snooping globally for the switch:

1. Click **Security > ND Snooping > Configure Global**.
2. Enable ND Snooping Status and set other parameters as required.
3. Click **Apply**.

Security > ND Snooping

Step: 1. Configure Global

ND Snooping Status Enabled

ND Snooping Auto-detect Enabled

ND Snooping Retransmit Count(1-5)

ND Snooping Retransmit Interval(1-10) sec

ND Snooping Prefix Timeout(3-1800)

ND Snooping VLAN Configuration

Use the Security > ND Snooping > Configure VLAN (Add) page to enable ND Snooping on a specified VLAN or range of VLANs.

Parameters

These parameters are displayed:

- ◆ **VLAN ID** - A specific VLAN ID or a consecutive range of VLANs. (Range: 1-4094)

Web Interface

To configure ND Snooping on a VLAN:

1. Click **Security > ND Snooping > Configure VLAN**.
2. Specify a VLAN ID or range of VLAN IDs.
3. Click **Apply**.

Configuration Ports for ND Snooping

Use the Security > ND Snooping > Configure Interface page to configure ports as trusted interfaces from which prefix information in RA messages can be added to the prefix table, or NS messages can be forwarded without validation.

Usage Guidelines

- ◆ In general, interfaces facing toward to the network core, or toward routers supporting the Network Discovery protocol, are configured as trusted interfaces.
- ◆ RA messages received from a trusted interface are added to the prefix table and forwarded toward their destination.
- ◆ NS messages received from a trusted interface are forwarded toward their destination. Nothing is added to the dynamic user binding table.

Parameters

These parameters are displayed:

- ◆ **Trust Status** – Enables or disables a port as trusted. (Default: Disabled)
- ◆ **Max Binding** – The maximum number of address entries in the dynamic user binding table which can be bound to a port. (Range: 1-5; Default: 5)

Web Interface

To configure ND Snooping on a port interface:

1. Click **Security > ND Snooping > Configure Interface**.
2. Set the required ports' Trust Status to enabled.
3. Click **Apply**.

Interface	Trust Status	Max Binding (1 - 5)
Eth 1/1	<input type="checkbox"/> Enabled	5
Eth 1/2	<input type="checkbox"/> Enabled	5
Eth 1/3	<input type="checkbox"/> Enabled	5
Eth 1/4	<input type="checkbox"/> Enabled	5
Eth 1/5	<input type="checkbox"/> Enabled	5

Displaying ND Snooping Binding Information

Use the Security > ND Snooping > Show Information (Binding) page to display the ND Snooping binding list.

Parameters

These parameters are displayed:

- ◆ **Mac Address** – The MAC address associated with the entry.
- ◆ **IPv6 Address** – The IPv6 address corresponding to the client.
- ◆ **Lifetime** – The amount of time that the specified IPv6 prefix is advertised as being preferred. The preferred lifetime is counted down in real time.
- ◆ **VLAN** – The VLAN to which this entry is bound.
- ◆ **Interface** – The port or trunk interface to which this entry is bound.

Web Interface

To display the ND Snooping binding list:

1. Click **Security > ND Snooping**.
2. Select Show Information from the Step list.
3. Click **Binding**.

Security > ND Snooping

Step: 4 Show Information

Binding Prefix

ND Snooping Binding List Total: 0

Mac Address	IPv6 Address	Lifetime	VLAN	Interface
Total: 0				

Displaying ND Snooping Prefix Information

Use the Security > ND Snooping > Show Information (Prefix) page to display the ND Snooping prefix list.

Parameters

These parameters are displayed:

- ◆ **Prefix** – The IPv6 network prefix associated with the entry.
- ◆ **Len** – (Prefix length) A decimal value that indicates how many contiguous bits (from the left) of the IPv6 address comprise the network portion of the address.
- ◆ **Valid-Time** – The amount of time that the specified IPv6 prefix is advertised as being valid.
- ◆ **Expire** – The time before this prefix entry will be removed.
- ◆ **VLAN** – The VLAN associated with the prefix entry.
- ◆ **Interface** – The port or trunk interface associated with the prefix entry.

Web Interface

To display the ND Snooping prefix list:

1. Click **Security > ND Snooping**.
2. Select Show Information from the Step list.
3. Click **Prefix**.

Security > ND Snooping

Step: 4 Show Information

Binding Prefix

VLAN 1

ND Snooping Prefix List Total: 0

Prefix	Len	Valid-Time	Expire	VLAN	Interface
Total: 0					

IPv4 Source Guard

IPv4 Source Guard is a security feature that filters IP traffic on network interfaces based on manually configured entries in the IP Source Guard table, or dynamic entries in the DHCP Snooping table when enabled. IP source guard can be used to prevent traffic attacks caused when a host tries to use the IPv4 address of a neighbor to access the network. This section describes how to configure IPv4 Source Guard.

Configuring Ports for IPv4 Source Guard

Use the Security > IP Source Guard > General page to set the filtering type based on source IP address, or source IP address and MAC address pairs. It also specifies lookup within the ACL binding table or the MAC address binding table, as well as the maximum number of allowed binding entries for the lookup tables.

IP Source Guard is used to filter traffic on an insecure port which receives messages from outside the network or fire wall, and therefore may be subject to traffic attacks caused by a host trying to use the IP address of a neighbor.

Command Usage

Filter Type

- ◆ Setting source guard mode to SIP (Source IP) or SIP-MAC (Source IP and MAC) enables this function on the selected port. Use the SIP option to check the VLAN ID, source IP address, and port number against all entries in the binding table. Use the SIP-MAC option to check these same parameters, plus the source MAC address. If no matching entry is found, the packet is dropped.

Note: Multicast addresses cannot be used by IP Source Guard.

- ◆ When enabled, traffic is filtered based upon dynamic entries learned via DHCP snooping, or static addresses configured in the source guard binding table.
- ◆ If IP source guard is enabled, an inbound packet's IP address (SIP option) or both its IP address and corresponding MAC address (SIP-MAC option) will be checked against the binding table. If no matching entry is found, the packet will be dropped.
- ◆ An entry with same MAC address and a different VLAN ID cannot be added to the binding table.

- ◆ Filtering rules are implemented as follows:
 - ◆ If DHCP snooping is disabled, IP source guard will check the VLAN ID, source IP address, port number, and source MAC address (for the SIP-MAC option). If a matching entry is found in the binding table and the entry type is static IP source guard binding, the packet will be forwarded.
 - ◆ If DHCP snooping is enabled, IP source guard will check the VLAN ID, source IP address, port number, and source MAC address (for the SIP-MAC option). If a matching entry is found in the binding table and the entry type is static IP source guard binding, or dynamic DHCP snooping binding, the packet will be forwarded.
 - ◆ If IP source guard is enabled on an interface for which IP source bindings have not yet been configured (neither by static configuration in the IP source guard binding table nor dynamically learned from DHCP snooping), the switch will drop all IP traffic on that port, except for DHCP packets allowed by DHCP snooping.

Parameters

These parameters are displayed:

- ◆ **Port** – The port identifier.
- ◆ **Filter Type** – Configures the switch to filter inbound traffic based source IP address, or source IP address and corresponding MAC address. (Default: None)
 - ◆ **Disabled** – Disables IP source guard filtering on the port.
 - ◆ **SIP** – Enables traffic filtering based on IP addresses stored in the binding table.
 - ◆ **SIP-MAC** – Enables traffic filtering based on IP addresses and corresponding MAC addresses stored in the binding table.
- ◆ **Filter Table** – Sets the source guard learning model to search for addresses in the ACL binding table or the MAC address binding table. (Default: ACL binding table)
- ◆ **Max Binding Entry** – The maximum number of entries that can be bound to an interface. (ACL Table: 1-10, default: 5; MAC Table: 1-1024, default: 1024)

This parameter sets the maximum number of address entries that can be mapped to an interface in the binding table, including both dynamic entries discovered by DHCP snooping and static entries set by IP source guard.

Web Interface

To set the IP Source Guard filter for ports:

1. Click **Security > IP Source Guard > General**.
2. Set the required filtering type, set the table type to use ACL or MAC address binding, and then set the maximum binding entries for each port.
3. Click **Apply**.

Security > IP Source Guard > General

Port Configuration List Total: 28

Port	Filter Type	Filter Table	ACL Table Max Binding Entry (1-10)	MAC Table Max Binding Entry (1-1024)
1	Disabled	ACL	5	16
2	Disabled	ACL	5	16
3	Disabled	ACL	5	16
4	Disabled	ACL	5	16
5	Disabled	ACL	5	16
6	Disabled	ACL	5	16
7	Disabled	ACL	5	16
8	Disabled	ACL	5	16
9	Disabled	ACL	5	16
10	Disabled	ACL	5	16

Apply Revert

Configuring Static Bindings for IPv4 Source Guard

Use the Security > IP Source Guard > Static Binding (Configure ACL Table and Configure MAC Table) pages to bind a static address to a port. Table entries include a MAC address, IP address, lease time, entry type (Static, Dynamic), VLAN identifier, and port identifier. All static entries are configured with an infinite lease time, which is indicated with a value of zero in the table.

Command Usage

- ◆ Table entries include a MAC address, IP address, lease time, entry type (Static-IP-SG-Binding, Dynamic-DHCP-Binding), VLAN identifier, and port identifier.
- ◆ Static addresses entered in the source guard binding table are automatically configured with an infinite lease time.
- ◆ When source guard is enabled, traffic is filtered based upon dynamic entries learned via DHCP snooping, or static addresses configured in the source guard binding table.

- ◆ An entry with same MAC address and a different VLAN ID cannot be added to the binding table.
- ◆ Static bindings are processed as follows:
 - ◆ A valid static IP source guard entry will be added to the binding table in ACL mode if one of the following conditions is true:
 - ◆ If there is no entry with the same VLAN ID and MAC address, a new entry is added to the binding table using the type “static IP source guard binding.”
 - ◆ If there is an entry with the same VLAN ID and MAC address, and the type of entry is static IP source guard binding, then the new entry will replace the old one.
 - ◆ If there is an entry with the same VLAN ID and MAC address, and the type of the entry is dynamic DHCP snooping binding, then the new entry will replace the old one and the entry type will be changed to static IP source guard binding.
 - ◆ A valid static IP source guard entry will be added to the binding table in MAC mode if one of the following conditions are true:
 - ◆ If there is no binding entry with the same IP address and MAC address, a new entry will be added to the binding table using the type of static IP source guard binding entry.
 - ◆ If there is a binding entry with same IP address and MAC address, then the new entry shall replace the old one.
 - ◆ Only unicast addresses are accepted for static bindings.

Parameters

These parameters are displayed:

Add – Configure ACL Table

- ◆ **Port** – The port to which a static entry is bound.
- ◆ **VLAN** – ID of a configured VLAN (Range: 1-4094)
- ◆ **MAC Address** – A valid unicast MAC address.
- ◆ **IP Address** – A valid unicast IP address, including classful types A, B or C.

Add – Configure MAC Table

- ◆ **MAC Address** – A valid unicast MAC address.
- ◆ **VLAN** – ID of a configured VLAN or a range of VLANs. (Range: 1-4094)
- ◆ **IP Address** – A valid unicast IP address, including classful types A, B or C.

- ◆ **Port** – The port to which a static entry is bound. Specify a physical port number or list of port numbers. Separate nonconsecutive port numbers with a comma and no spaces; or use a hyphen to designate a range of port numbers. (Range: 1-28/54)

Show

- ◆ **MAC Address** – Physical address associated with the entry.
- ◆ **IP Address** – IP address corresponding to the client.
- ◆ **VLAN** – VLAN to which this entry is bound.
- ◆ **Interface** – The port to which this entry is bound.

Web Interface

To configure static bindings for IP Source Guard:

1. Click **Security > IP Source Guard > Static Binding**.
2. Select Configure ACL Table or Configure MAC Table from the Step list.
3. Select Add from the Action list.
4. Enter the required bindings for each port.
5. Click **Apply**.

Security > IP Source Guard > Static Binding

Step: 1. Configure ACL Table Action: Add

Port: 1

VLAN: 1

MAC Address: 00-10-b5-f4-d0-d1 (XX-XX-XX-XX-XX-XX or XXXXXXXXXXXX)

IP Address: 10.2.44.95

Apply Revert

To display static bindings for IP Source Guard:

1. Click **Security > IP Source Guard > Static Binding**.
2. Select Configure ACL Table or Configure MAC Table from the Step list.
3. Select Show from the Action list.

Security > IP Source Guard > Static Binding

Step: 1. Configure ACL Table Actions: Show

Static Binding List Total: 1

	MAC Address	IP Address	VLAN	Interface
<input type="checkbox"/>	00-10-B5-F4-D0-D1	10.2.44.95	1	Unit 1 / Port 1

Delete Revert

Displaying Information for Dynamic IPv4 Source Guard Bindings

Use the Security > IP Source Guard > Dynamic Binding page to display the source-guard binding table for a selected interface.

Parameters

These parameters are displayed:

Query by

- ◆ **Port** – A port on this switch.
- ◆ **VLAN** – ID of a configured VLAN (Range: 1-4094)
- ◆ **MAC Address** – A valid unicast MAC address.
- ◆ **IP Address** – A valid unicast IP address, including classful types A, B or C.

Dynamic Binding List

- ◆ **VLAN** – VLAN to which this entry is bound.
- ◆ **MAC Address** – Physical address associated with the entry.
- ◆ **Interface** – Port to which this entry is bound.
- ◆ **IP Address** – IP address corresponding to the client.
- ◆ **Type** – Dynamic DHCPv4 binding, stateful address.

Web Interface

To display the binding table for IP Source Guard:

1. Click **Security > IP Source Guard > Dynamic Binding**.
2. Mark the search criteria, and enter the required values.
3. Click **Query**.

Security > IP Source Guard > Dynamic Binding

Query by:

Port

VLAN

MAC Address (xx-xx-xx-xx-xx-xx or xxxxxxxxxxxx)

IP Address

Dynamic Binding List Total: 3

VLAN	MAC Address	Interface	IP Address	Type
1	00-10-B5-F4-00-01	Unit 1 / Port 2	10.2.44.96	DHCP
1	00-10-B5-F4-00-02	Unit 1 / Port 4	10.2.44.97	DHCP
2	00-10-B5-F4-00-03	Unit 1 / Port 7	10.2.44.96	DHCP

IPv6 Source Guard

IPv6 Source Guard is a security feature that filters IPv6 traffic on non-routed, Layer 2 network interfaces based on manually configured entries in the IPv6 Source Guard table, or dynamic entries in the Neighbor Discovery Snooping table or DHCPv6 Snooping table when either snooping protocol is enabled (refer to the DHCPv6 Snooping commands in the *CLI Reference Guide*). IPv6 source guard can be used to prevent traffic attacks caused when a host tries to use the IPv6 address of a neighbor to access the network. This section describes how to configure IPv6 Source Guard.

Configuring Ports for IPv6 Source Guard

Use the Security > IPv6 Source Guard > Port Configuration page to filter inbound traffic based on the source IPv6 address stored in the binding table.

IPv6 Source Guard is used to filter traffic on an insecure port which receives messages from outside the network or fire wall, and therefore may be subject to traffic attacks caused by a host trying to use the IPv6 address of a neighbor.

Command Usage

- ◆ Setting source guard mode to SIP (Source IP) enables this function on the selected port. Use the SIP option to check the VLAN ID, IPv6 global unicast source IP address, and port number against all entries in the binding table.
- ◆ After IPv6 source guard is enabled on an interface, the switch initially blocks all IPv6 traffic received on that interface, except for ND packets allowed by ND snooping and DHCPv6 packets allowed by DHCPv6 snooping. A port access control list (ACL) is applied to the interface. Traffic is then filtered based upon dynamic entries learned via ND snooping or DHCPv6 snooping, or static addresses configured in the source guard binding table. The port allows only IPv6 traffic with a matching entry in the binding table and denies all other IPv6 traffic.
- ◆ Table entries include a MAC address, IPv6 global unicast address, entry type (Static-IPv6-SG-Binding, Dynamic-ND-Binding, Dynamic-DHCPv6-Binding), VLAN identifier, and port identifier.
- ◆ Static addresses entered in the source guard binding table (using the Static Binding page) are automatically configured with an infinite lease time. Dynamic entries learned via DHCPv6 snooping are configured by the DHCPv6 server itself.

- ◆ If IPv6 source guard is enabled, an inbound packet's source IPv6 address will be checked against the binding table. If no matching entry is found, the packet will be dropped.
- ◆ Filtering rules are implemented as follows:
 - ◆ If ND snooping and DHCPv6 snooping are disabled, IPv6 source guard will check the VLAN ID, source IPv6 address, and port number. If a matching entry is found in the binding table and the entry type is static IPv6 source guard binding, the packet will be forwarded.
 - ◆ If ND snooping or DHCP snooping is enabled, IPv6 source guard will check the VLAN ID, source IP address, and port number. If a matching entry is found in the binding table and the entry type is static IPv6 source guard binding, dynamic ND snooping binding, or dynamic DHCPv6 snooping binding, the packet will be forwarded.
 - ◆ If IPv6 source guard is enabled on an interface for which IPv6 source bindings (dynamically learned via ND snooping or DHCPv6 snooping, or manually configured) are not yet configured, the switch will drop all IPv6 traffic on that port, except for ND packets and DHCPv6 packets allowed by DHCPv6 snooping.
 - ◆ Only IPv6 global unicast addresses are accepted for static bindings.

Parameters

These parameters are displayed:

- ◆ **Port** – Port identifier.
- ◆ **Filter Type** – Configures the switch to filter inbound traffic based on the following options. (Default: Disabled)
 - ◆ **Disabled** – Disables IPv6 source guard filtering on the port.
 - ◆ **SIP** – Enables traffic filtering based on IPv6 global unicast source IPv6 addresses stored in the binding table.
- ◆ **Max Binding Entry** – The maximum number of entries that can be bound to an interface. (Range: 1-5; Default: 5)
 - ◆ This parameter sets the maximum number of IPv6 global unicast source IPv6 address entries that can be mapped to an interface in the binding table, including both dynamic entries discovered by ND snooping, DHCPv6 snooping (refer to the DHCPv6 Snooping commands in the *CLI Reference Guide*), and static entries set by IPv6 Source Guard.
 - ◆ IPv6 source guard maximum bindings must be set to a value higher than DHCPv6 snooping maximum bindings and ND snooping maximum bindings.

- ◆ If IPv6 source guard, ND snooping, and DHCPv6 snooping are enabled on a port, the dynamic bindings used by ND snooping, DHCPv6 snooping, and IPv6 source guard static bindings cannot exceed the maximum allowed bindings set by this parameter. In other words, no new entries will be added to the IPv6 source guard binding table.
- ◆ If IPv6 source guard is enabled on a port, and the maximum number of allowed bindings is changed to a lower value, precedence is given to deleting entries learned through DHCPv6 snooping, ND snooping, and then manually configured IPv6 source guard static bindings, until the number of entries in the binding table reaches the newly configured maximum number of allowed bindings.

Web Interface

To set the IPv6 Source Guard filter for ports:

1. Click **Security > IPv6 Source Guard > Port Configuration**.
2. Set the required filtering type for each port.
3. Click **Apply**.

Port	Filter Type	Max Binding Entry (1-5)
1	Disabled	5
2	Disabled	5
3	Disabled	5
4	Disabled	5
5	Disabled	5

Configuring Static Bindings for IPv6 Source Guard

Use the Security > IPv6 Source Guard > Static Binding page to bind a static address to a port. Table entries include a MAC address, IPv6 global unicast address, entry type (Static-IPv6-SG-Binding, Dynamic-ND-Binding, Dynamic-DHCPv6-Binding), VLAN identifier, and port identifier.

Command Usage

- ◆ Traffic filtering is based only on the source IPv6 address, VLAN ID, and port number.
- ◆ Static addresses entered in the source guard binding table are automatically configured with an infinite lease time.

- ◆ When source guard is enabled, traffic is filtered based upon dynamic entries learned via ND snooping, DHCPv6 snooping, or static addresses configured in the source guard binding table.
- ◆ An entry with same MAC address and a different VLAN ID cannot be added to the binding table.
- ◆ Static bindings are processed as follows:
 - ◆ If there is no entry with same and MAC address and IPv6 address, a new entry is added to binding table using static IPv6 source guard binding.
 - ◆ If there is an entry with same MAC address and IPv6 address, and the type of entry is static IPv6 source guard binding, then the new entry will replace the old one.
 - ◆ If there is an entry with same MAC address and IPv6 address, and the type of the entry is either a dynamic ND snooping binding or DHCPv6 snooping binding, then the new entry will replace the old one and the entry type will be changed to static IPv6 source guard binding.
 - ◆ Only unicast addresses are accepted for static bindings.

Parameters

These parameters are displayed:

Add

- ◆ **Port** – The port to which a static entry is bound.
- ◆ **VLAN** – ID of a configured VLAN (Range: 1-4094)
- ◆ **MAC Address** – A valid unicast MAC address.
- ◆ **IPv6 Address** – A valid global unicast IPv6 address. This address must be entered according to RFC 2373 “IPv6 Addressing Architecture,” using 8 colon-separated 16-bit hexadecimal values. One double colon may be used in the address to indicate the appropriate number of zeros required to fill the undefined fields.

Show

- ◆ **VLAN** – VLAN to which this entry is bound.
- ◆ **MAC Address** – Physical address associated with the entry.
- ◆ **Interface** – The port to which this entry is bound.
- ◆ **IPv6 Address** – IPv6 address corresponding to the client.
- ◆ **Type** – Shows the entry type:
 - ◆ **DHCP** – Dynamic DHCPv6 binding, stateful address.

- ◆ **ND** – Dynamic Neighbor Discovery binding, stateless address.
- ◆ **STA** – Static IPv6 Source Guard binding.

Web Interface

To configure static bindings for IPv6 Source Guard:

1. Click **Security > IPv6 Source Guard > Static Binding**.
2. Select Add from the Action list.
3. Enter the required bindings for each port.
4. Click **Apply**.

The screenshot shows the configuration page for IPv6 Source Guard Static Binding. The breadcrumb is "Security > IPv6 Source Guard > Static Binding". The "Action" dropdown is set to "Add". The form contains the following fields:

- Port:** 1
- VLAN:** 1
- MAC Address:** 00-10-B5-F4-00-01 (with a hint: (XX-XX-XX-XX-XX-XX or XXXXXXXXXXXXX))
- IPv6 Address:** 2001::1

Buttons for "Apply" and "Revert" are located at the bottom right.

To display static bindings for IPv6 Source Guard:

1. Click **Security > IPv6 Source Guard > Static Binding**.
2. Select Show from the Action list.

The screenshot shows the configuration page for IPv6 Source Guard Static Binding in "Show" mode. The breadcrumb is "Security > IPv6 Source Guard > Static Binding". The "Action" dropdown is set to "Shew". Below the form is a table titled "Static Binding List" with a total of 3 items.

<input type="checkbox"/>	VLAN	MAC Address	Interface	IPv6 Address	Type
<input type="checkbox"/>	1	00-10-B5-F4-00-01	Eth 1/2	2001:0B9:2222:7272::26	STA
<input type="checkbox"/>	1	00-10-B5-F4-00-02	Eth 1/4	2001:0B9:2222:7272::56	DHCP
<input type="checkbox"/>	2	00-10-B5-F4-00-03	Eth 1/7	2001:0B9:2222:7272::36	ND

Buttons for "Delete" and "Revert" are located at the bottom center.

Displaying Information for Dynamic IPv6 Source Guard Bindings

Use the Security > IPv6 Source Guard > Dynamic Binding page to display the source-guard binding table for a selected interface.

Parameters

These parameters are displayed:

Query by

- ◆ **Port** – A port on this switch.
- ◆ **VLAN** – ID of a configured VLAN (Range: 1-4094)
- ◆ **MAC Address** – A valid unicast MAC address.
- ◆ **IPv6 Address** – A valid global unicast IPv6 address.

Dynamic Binding List

- ◆ **VLAN** – VLAN to which this entry is bound.
- ◆ **MAC Address** – Physical address associated with the entry.
- ◆ **Interface** – Port to which this entry is bound.
- ◆ **IPv6 Address** – IPv6 address corresponding to the client.
- ◆ **Type** – Shows the entry type:
 - ◆ **DHCP** – Dynamic DHCPv6 binding, stateful address.
 - ◆ **ND** – Dynamic Neighbor Discovery binding, stateless address.
 - ◆ **STA** – Static IPv6 Source Guard binding.

Web Interface

To display the binding table for IPv6 Source Guard:

1. Click **Security > IPv6 Source Guard > Dynamic Binding**.
2. Mark the search criteria, and enter the required values.
3. Click **Query**.

Security > IPv6 Source Guard > Dynamic Binding

Query by:

Port 1

VLAN 1

MAC Address (XX-XX-XX-XX-XX-XX Of XXXXXXXXXX)

IPv6 Address

Query

Dynamic Binding List Total: 3

VLAN	MAC Address	Interface	IPv6 Address	Type
1	00-10-B5-F4-00-01	Eth 1/2	2001:de	ND
1	00-10-B5-F4-00-02	Eth 1/4	2001:ee	ND
2	00-10-B5-F4-00-03	Pch 1	2001:fe	ND

ARP Inspection

ARP Inspection is a security feature that validates the MAC Address bindings for Address Resolution Protocol packets. It provides protection against ARP traffic with invalid MAC-to-IP address bindings, which forms the basis for certain “man-in-the-middle” attacks. This is accomplished by intercepting all ARP requests and responses and verifying each of these packets before the local ARP cache is updated or the packet is forwarded to the appropriate destination. Invalid ARP packets are dropped.

ARP Inspection determines the validity of an ARP packet based on valid IP-to-MAC address bindings stored in a trusted database – the DHCP snooping binding database. This database is built by DHCP snooping if it is enabled on globally on the switch and on the required VLANs. ARP Inspection can also validate ARP packets against user-configured ARP access control lists (ACLs) for hosts with statically configured addresses.

Command Usage

Enabling & Disabling ARP Inspection

- ◆ ARP Inspection is controlled on a global and VLAN basis.
- ◆ By default, ARP Inspection is disabled both globally and on all VLANs.
 - ◆ If ARP Inspection is globally enabled, then it becomes active only on the VLANs where it has been enabled.
 - ◆ When ARP Inspection is enabled globally, all ARP request and reply packets on inspection-enabled VLANs are redirected to the CPU and their switching behavior handled by the ARP Inspection engine.
 - ◆ If ARP Inspection is disabled globally, then it becomes inactive for all VLANs, including those where inspection is enabled.
 - ◆ When ARP Inspection is disabled, all ARP request and reply packets will bypass the ARP Inspection engine and their switching behavior will match that of all other packets.
 - ◆ Disabling and then re-enabling global ARP Inspection will not affect the ARP Inspection configuration of any VLANs.
 - ◆ When ARP Inspection is disabled globally, it is still possible to configure ARP Inspection for individual VLANs. These configuration changes will only become active after ARP Inspection is enabled globally again.
- ◆ The ARP Inspection engine in the current firmware version does not support ARP Inspection on trunk ports.

Configuring Global Settings for ARP Inspection

Use the Security > ARP Inspection (Configure General) page to enable ARP inspection globally for the switch, to validate address information in each packet, and configure logging.

Command Usage

ARP Inspection Validation

- ◆ By default, ARP Inspection Validation is disabled.
- ◆ Specifying at least one of the following validations enables ARP Inspection Validation globally. Any combination of the following checks can be active concurrently.
 - ◆ Destination MAC – Checks the destination MAC address in the Ethernet header against the target MAC address in the ARP body. This check is performed for ARP responses. When enabled, packets with different MAC addresses are classified as invalid and are dropped.
 - ◆ IP – Checks the ARP body for invalid and unexpected IP addresses. These addresses include 0.0.0.0, 255.255.255.255, and all IP multicast addresses. Sender IP addresses are checked in all ARP requests and responses, while target IP addresses are checked only in ARP responses.
 - ◆ Source MAC – Checks the source MAC address in the Ethernet header against the sender MAC address in the ARP body. This check is performed on both ARP requests and responses. When enabled, packets with different MAC addresses are classified as invalid and are dropped.

ARP Inspection Logging

- ◆ By default, logging is active for ARP Inspection, and cannot be disabled.
- ◆ The administrator can configure the log facility rate.
- ◆ When the switch drops a packet, it places an entry in the log buffer, then generates a system message on a rate-controlled basis. After the system message is generated, the entry is cleared from the log buffer.
- ◆ Each log entry contains flow information, such as the receiving VLAN, the port number, the source and destination IP addresses, and the source and destination MAC addresses.
- ◆ If multiple, identical invalid ARP packets are received consecutively on the same VLAN, then the logging facility will only generate one entry in the log buffer and one corresponding system message.

- ◆ If the log buffer is full, the oldest entry will be replaced with the newest entry.

Parameters

These parameters are displayed:

- ◆ **ARP Inspection Status** – Enables ARP Inspection globally. (Default: Disabled)
- ◆ **ARP Inspection Validation** – Enables extended ARP Inspection Validation if any of the following options are enabled. (Default: Disabled)
 - ◆ **Dst-MAC** – Validates the destination MAC address in the Ethernet header against the target MAC address in the body of ARP responses.
 - ◆ **IP** – Checks the ARP body for invalid and unexpected IP addresses. Sender IP addresses are checked in all ARP requests and responses, while target IP addresses are checked only in ARP responses.
 - ◆ **Allow Zeros** – Allows sender IP address to be 0.0.0.0.
 - ◆ **Src-MAC** – Validates the source MAC address in the Ethernet header against the sender MAC address in the ARP body. This check is performed on both ARP requests and responses.
- ◆ **Log Message Number** – The maximum number of entries saved in a log message. (Range: 0-256; Default: 20)
- ◆ **Log Interval** – The interval at which log messages are sent. (Range: 0-86400 seconds; Default: 10 seconds)

Web Interface

To configure global settings for ARP Inspection:

1. Click **Security > ARP Inspection**.
2. Select **Configure General** from the Step list.
3. Enable ARP inspection globally, enable any of the address validation options, and adjust any of the logging parameters if required.
4. Click **Apply**.

Security > ARP Inspection

Step: 1. Configure General

ARP Inspection Status Enabled

ARP Inspection Validation Dst-MAC IP Allow Zeros Src-MAC

Log Message Number (0-256)

Log Interval (0-36400) sec

Configuring VLAN Settings for ARP Inspection

Use the Security > ARP Inspection (Configure VLAN) page to enable ARP inspection for any VLAN and to specify the ARP ACL to use.

Command Usage

ARP Inspection VLAN Filters (ACLs)

- ◆ By default, no ARP Inspection ACLs are configured and the feature is disabled.
- ◆ ARP Inspection ACLs are configured within the ARP ACL configuration page.
- ◆ ARP Inspection ACLs can be applied to any configured VLAN.
- ◆ ARP Inspection uses the DHCP snooping bindings database for the list of valid IP-to-MAC address bindings. ARP ACLs take precedence over entries in the DHCP snooping bindings database. The switch first compares ARP packets to any specified ARP ACLs.
- ◆ If *Static* is specified, ARP packets are only validated against the selected ACL – packets are filtered according to any matching rules, packets not matching any rules are dropped, and the DHCP snooping bindings database check is bypassed.
- ◆ If *Static* is not specified, ARP packets are first validated against the selected ACL; if no ACL rules match the packets, then the DHCP snooping bindings database determines their validity.

Parameters

These parameters are displayed:

- ◆ **VLAN** – VLAN identifier. (Range: 1-4094)

- ◆ **DAI Status** – Enables Dynamic ARP Inspection for the selected VLAN. (Default: Disabled)
- ◆ **ACL Name** – Allows selection of any configured ARP ACLs. (Default: None)
- ◆ **Static** – When an ARP ACL is selected, and static mode also selected, the switch only performs ARP Inspection and bypasses validation against the DHCP Snooping Bindings database. When an ARP ACL is selected, but static mode is not selected, the switch first performs ARP Inspection and then validation against the DHCP Snooping Bindings database. (Default: Disabled)

Web Interface

To configure VLAN settings for ARP Inspection:

1. Click **Security > ARP Inspection**.
2. Select Configure VLAN from the Step list.
3. Enable ARP inspection for the required VLANs, select an ARP ACL filter to check for configured addresses, and select the Static option to bypass checking the DHCP snooping bindings database if required.
4. Click **Apply**.

Security > ARP Inspection

Step: 2. Configure VLAN

ARP Inspection VLAN List Total: 3

VLAN	DAI Status	ACL Name	ACL Status
1	<input checked="" type="checkbox"/> Enabled	<input checked="" type="checkbox"/> arp_acl_1	<input checked="" type="checkbox"/> Static
2	<input type="checkbox"/> Enabled	<input type="checkbox"/> arp_acl_1	<input type="checkbox"/> Static
3	<input checked="" type="checkbox"/> Enabled	<input checked="" type="checkbox"/> arp_acl_2	<input type="checkbox"/> Static

Apply Revert

Configuring Interface Settings for ARP Inspection

Use the Security > ARP Inspection (Configure Interface) page to specify the ports that require ARP inspection, and to adjust the packet inspection rate.

Parameters

These parameters are displayed:

- ◆ **Interface** – Port or trunk identifier.
- ◆ **Trust Status** – Configures the port as trusted or untrusted. (Default: Untrusted)

By default, all untrusted ports are subject to ARP packet rate limiting, and all trusted ports are exempt from ARP packet rate limiting.

Packets arriving on trusted interfaces bypass all ARP Inspection and ARP Inspection Validation checks and will always be forwarded, while those arriving on untrusted interfaces are subject to all configured ARP inspection tests.

- ◆ **Packet Rate Limit** – Sets the maximum number of ARP packets that can be processed by CPU per second on trusted or untrusted ports. (Range: 0-750 pps; Default: 15 pps)

Setting the rate limit to “0” means that there is no restriction on the number of ARP packets that can be processed by the CPU.

The switch will drop all ARP packets received on a port which exceeds the configured ARP-packets-per-second rate limit.

Web Interface

To configure interface settings for ARP Inspection:

1. Click **Security > ARP Inspection**.
2. Select Configure Interface from the Step list.
3. Specify any untrusted ports which require ARP inspection, and adjust the packet inspection rate.
4. Click **Apply**.

Security > ARP Inspection

Step: 3. Configure Interface

Interface Port Trunk

Port Configuration List Total: 28

Port	Trust Status	Packet Rate Limit (0-750 pps)
1	<input type="checkbox"/> Enabled	<input checked="" type="checkbox"/> 15
2	<input type="checkbox"/> Enabled	<input checked="" type="checkbox"/> 15
3	<input type="checkbox"/> Enabled	<input checked="" type="checkbox"/> 15
4	<input type="checkbox"/> Enabled	<input checked="" type="checkbox"/> 15
5	<input type="checkbox"/> Enabled	<input checked="" type="checkbox"/> 15

Displaying ARP Inspection Statistics

Use the Security > ARP Inspection (Show Information - Show Statistics) page to display statistics about the number of ARP packets processed, or dropped for various reasons.

Parameters

These parameters are displayed:

Parameter	Description
Received ARP packets before ARP inspection rate limit	Count of ARP packets received but not exceeding the ARP Inspection rate limit.
Dropped ARP packets in the process of ARP inspection rate limit	Count of ARP packets exceeding (and dropped by) ARP rate limiting.
ARP packets dropped by additional validation (IP)	Count of ARP packets that failed the IP address test.
ARP packets dropped by additional validation (Dst-MAC)	Count of packets that failed the destination MAC address test.
Total ARP packets processed by ARP inspection	Count of all ARP packets processed by the ARP Inspection engine.
ARP packets dropped by additional validation (Src-MAC)	Count of packets that failed the source MAC address test.
ARP packets dropped by ARP ACLs	Count of ARP packets that failed validation against ARP ACL rules.
ARP packets dropped by DHCP snooping	Count of packets that failed validation against the DHCP Snooping Binding database.

Web Interface

To display statistics for ARP Inspection:

1. Click **Security > ARP Inspection**.
2. Select Show Information from the Step list.
3. Select Show Statistics from the Action list.

Security > ARP Inspection	
Step: 4. Show information	Action: Show Statistics
Received ARP packets before ARP inspection rate limit	1000
Dropped ARP packets in processing ARP inspection rate limit	5
Total ARP packets processed by ARP inspection	200
ARP packets dropped by additional validation (Src-MAC)	300
ARP packets dropped by additional validation (Dst-MAC)	2000
ARP packets dropped by additional validation (IP)	100
ARP packets dropped by ARP ACLs	5
ARP packets dropped by DHCP snooping	5

Displaying the ARP Inspection Log

Use the Security > ARP Inspection (Show Information - Show Log) page to show information about entries stored in the log, including the associated VLAN, port, and address components.

Parameters

These parameters are displayed:

Parameter	Description
VLAN ID	The VLAN where this packet was seen.
Port	The port where this packet was seen.
Src. IP Address	The source IP address in the packet.
Dst. IP Address	The destination IP address in the packet.
Src. MAC Address	The source MAC address in the packet.
Dst. MAC Address	The destination MAC address in the packet.

Web Interface

To display the ARP Inspection log:

1. Click **Security > ARP Inspection**.
2. Select Show Information from the Step list.
3. Select Show Log from the Action list.

Security > ARP Inspection						
Step: 4. Show Information		Action: Show Log				
ARP Inspection Log List Total: 2						
VLAN ID	Port	Src. IP Address	Dst. IP Address	Src. MAC Address	Dst. MAC Address	
1	15	192.168.1.1	192.168.1.5	11-22-33-44-55-66	AA-BB-CC-DD-EE-FF	
1	17	192.168.1.3	192.168.1.23	11-4E-33-75-55-BB	A0-3B-C9-DD-4E-1F	

Application Filter

Use the Security > Application Filter page to forward CDP or PVST packets.

Command Usage

If this feature is not enabled, the switch will handle CDP or PVST packets as normal packets. In other words, they are forwarded to other ports in the same VLAN that are also configured to forward the specified packet type.

Parameters

These parameters are displayed:

- ◆ **Port** – Port identifier (Range: 1-28/54)
- ◆ **CDP** – Cisco Discovery Protocol
- ◆ **PVST** – Per-VLAN Spanning Tree

Web Interface

To discard or forward CDP or PVST packets:

1. Click **Security > Application Filter**.
2. Set the packet type to be discarded or forwarded as required.
3. Click **Apply**.

Port	CDP	PVST
1	Default	Default
2	Default	Default
3	Default	Default
4	Default	Default
5	Default	Default

Chapter 15

Basic Administration Protocols

Overview

This chapter describes basic administration tasks including:

- ◆ *Event Logging* – Sets conditions for logging event messages to system memory or flash memory, configures conditions for sending trap messages to remote log servers, and configures trap reporting to remote hosts using Simple Mail Transfer Protocol (SMTP).
- ◆ *Link Layer Discovery Protocol (LLDP)* – Configures advertisement of basic information about the local switch, or discovery of information about neighboring devices on the local broadcast domain.
- ◆ *Power over Ethernet* – Sets the priority and power budget for each port.
- ◆ *Simple Network Management Protocol (SNMP)* – Configures switch management through SNMPv1, SNMPv2c or SNMPv3.
- ◆ *Remote Monitoring (RMON)* – Configures local collection of detailed statistics or events which can be subsequently retrieved through SNMP.
- ◆ *Switch Clustering* – Configures centralized management by a single unit over a group of switches connected to the same local network.
- ◆ *Time Range* – Sets a time range during which various functions are applied, including applied ACLs.
- ◆ *Ethernet Ring Protection Switching (ERPS)* – Configures a protection switching mechanism and protocol for Ethernet layer network rings.
- ◆ *MLAG* – Configures multi-chassis link aggregation group (MLAG).
- ◆ *Operation, Administration and Maintenance (OAM)* – Provides remote management tools required to monitor and maintain the links to subscriber CPEs (Customer Premise Equipment).
- ◆ *UniDirectional Link Detection (UDLD)* – Detects general loopback conditions caused by hardware problems or faulty protocol settings.
- ◆ *Loopback Detection (LBD)* – Detects general loopback conditions caused by hardware problems or faulty protocol settings.
- ◆ *Smart Pair Configuration* – Detects general loopback conditions caused by hardware problems or faulty protocol settings.

Event Logging

The switch allows you to control the logging of error messages, including the type of events that are recorded in switch memory, logging to a remote System Log (syslog) server, and displays a list of recent event messages.

System Log Configuration

Use the Administration > Log > System (Configure Global) page to enable or disable event logging, and specify which levels are logged to RAM or flash memory.

Severe error messages that are logged to flash memory are permanently stored in the switch to assist in troubleshooting network problems. Up to 4096 log entries can be stored in the flash memory, with the oldest entries being overwritten first when the available log memory (256 kilobytes) has been exceeded.

The System Logs page allows you to configure and limit system messages that are logged to flash or RAM memory. The default is for event levels 0 to 3 to be logged to flash and levels 0 to 7 to be logged to RAM.

Parameters

These parameters are displayed:

- ♦ **System Log Status** – Enables/disables the logging of debug or error messages to the logging process. (Default: Enabled)
- ♦ **Flash Level** – Limits log messages saved to the switch's permanent flash memory for all levels up to the specified level. For example, if level 3 is specified, all messages from level 0 to level 3 will be logged to flash. (Range: 0-7, Default: 3)

Level	Severity Name	Description
7	Debugging	Debugging messages.
6	Informational	Informational messages only.
5	Notice	Normal but significant condition, such as cold start.
4	Warning	Warning conditions (e.g., return false, unexpected return).
3	Error	Error conditions (e.g., invalid input, default used).
2	Critical	Critical conditions (e.g., memory allocation, or free memory error - resource exhausted).
1	Alert	Immediate action needed.

Level	Severity Name	Description
0	Emergency	System unusable.

Note: There are only Level 2, 5 and 6 error messages for the current firmware release.

- ♦ **RAM Level** – Limits log messages saved to the switch’s temporary RAM memory for all levels up to the specified level. For example, if level 7 is specified, all messages from level 0 to level 7 will be logged to RAM. (Range: 0-7, Default: 7)

Note:

- ♦ The Flash Level must be equal to or less than the RAM Level.
- ♦ All log messages are retained in RAM and Flash after a warm restart (i.e., power is reset through the command interface).
- ♦ All log messages are retained in Flash and purged from RAM after a cold restart (i.e., power is turned off and then on through the power source).

Web Interface

To configure the logging of error messages to system memory:

1. Click **Administration > Log > System**.
2. Select Configure Global from the Step list.
3. Enable or disable system logging, set the level of event messages to be logged to flash memory and RAM.
4. Click **Apply**.

Administration > Log > System

Step: 2. Configure Global

Status Enabled

History Flash Level 3 - Error

History RAM Level 7 - Debugging

Note: The Flash Level must be equal to or less than the RAM Level.

Apply Revert

To show the error messages logged to system or flash memory:

1. Click **Administration > Log > System**.
2. Select Show System Logs from the Step list.

- Click RAM to display log messages stored in system memory, or Flash to display messages stored in flash memory.

This page allows you to scroll through the logged system and event messages. The switch can store up to 2048 log entries in temporary random access memory (RAM; i.e., memory flushed on power reset) and up to 4096 entries in permanent flash memory.

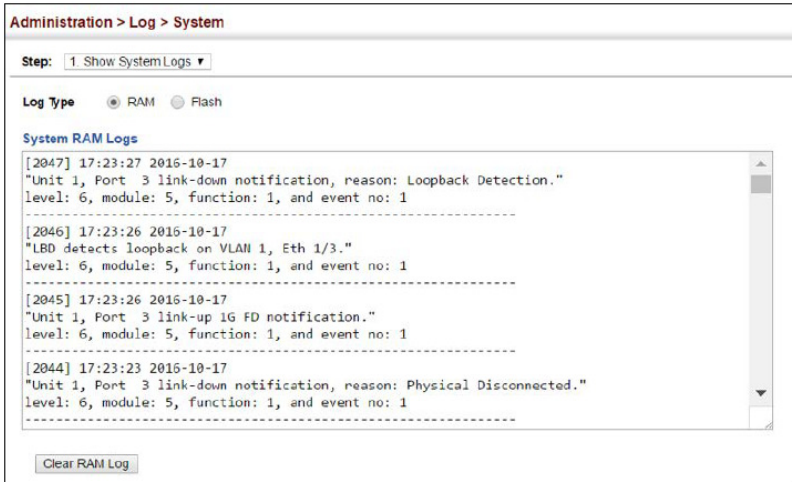

Remote Log Configuration

Use the Administration > Log > Remote page to send log messages to syslog servers or other management stations. You can also limit the event messages sent to only those messages below a specified level.

Parameters

These parameters are displayed:

- ◆ **Remote Log Status** – Enables/disables the logging of debug or error messages to the remote logging process. (Default: Disabled)
- ◆ **Logging Facility** – Sets the facility type for remote logging of syslog messages. There are eight facility types specified by values of 16 to 23. The facility type is used by the syslog server to dispatch log messages to an appropriate service.

The attribute specifies the facility type tag sent in syslog messages (see RFC 3164). This type has no effect on the kind of messages reported by the switch. However, it may be used by the syslog server to process

messages, such as sorting or storing messages in the corresponding database. (Range: 16-23, Default: 23)

- ◆ **Logging Trap Level** – Limits log messages that are sent to the remote syslog server for all levels up to the specified level. For example, if level 3 is specified, all messages from level 0 to level 3 will be sent to the remote server. (Range: 0-7, Default: 7)
- ◆ **Server IP Address** – Specifies the IPv4 or IPv6 address of a remote server which will be sent syslog messages.
- ◆ **Port** - Specifies the UDP port number used by the remote server. (Range: 1-65535; Default: 514)

Web Interface

To configure the logging of error messages to remote servers:

1. Click **Administration > Log > Remote**.
2. Enable remote logging, specify the facility type to use for the syslog messages. and enter the IP address of the remote servers.
3. Click **Apply**.

Administration > Log > Remote

Remote Log Status Enabled

Logging Facility

Logging Trap Level

Server IP Address 1 Port

Server IP Address 2 Port

Server IP Address 3 Port

Server IP Address 4 Port

Server IP Address 5 Port

Sending Simple Mail Transfer Protocol Alerts

Use the Administration > Log > SMTP page to alert system administrators of problems by sending SMTP (Simple Mail Transfer Protocol) email messages when triggered by logging events of a specified level. The messages are sent to specified SMTP servers on the network and can be retrieved using POP or IMAP clients.

Parameters

These parameters are displayed:

- ◆ **SMTP Status** – Enables/disables the SMTP function. (Default: Enabled)
- ◆ **Severity** – Sets the syslog severity threshold level used to trigger alert messages. All events at this level or higher will be sent to the configured email recipients. For example, using Level 7 will report all events from level 7 to level 0. (Default: Level 7)
- ◆ **Email Source Address** – Sets the email address used for the “From” field in alert messages. You may use a symbolic email address that identifies the switch, or the address of an administrator responsible for the switch. (Range: 1-41 characters)
- ◆ **Email Destination Address** – Specifies the email recipients of alert messages. You can specify up to five recipients.
- ◆ **Server IP Address** – Specifies a list of up to three recipient SMTP servers. IPv4 or IPv6 addresses may be specified. The switch attempts to connect to the listed servers in sequential order if the first server fails to respond.

For host name-to-IP address translation to function properly, host name lookup must be enabled, and one or more DNS servers specified.

Web Interface

To configure SMTP alert messages:

1. Click **Administration > Log > SMTP**.
2. Enable SMTP, specify a source email address, and select the minimum severity level. Specify the source and destination email addresses, and one or more SMTP servers.
3. Click **Apply**.

Administration > Log > SMTP

SMTP Status	<input checked="" type="checkbox"/> Enabled
Severity	3 - Error
E-mail Source Address	big-wheels@matel.com
E-mail Destination Address 1	chris@matel.com
E-mail Destination Address 2	
E-mail Destination Address 3	
E-mail Destination Address 4	
E-mail Destination Address 5	
Server IP Address 1	192.168.1.4
Server IP Address 2	
Server IP Address 3	

Link Layer Discovery Protocol (LLDP)

Link Layer Discovery Protocol (LLDP) is used to discover basic information about neighboring devices on the local broadcast domain. LLDP is a Layer 2 protocol that uses periodic broadcasts to advertise information about the sending device. Advertised information is represented in Type Length Value (TLV) format according to the IEEE 802.1AB standard, and can include details such as device identification, capabilities and configuration settings. LLDP also defines how to store and maintain information gathered about the neighboring network nodes it discovers.

Link Layer Discovery Protocol - Media Endpoint Discovery (LLDP-MED) is an extension of LLDP intended for managing endpoint devices such as Voice over IP phones and network switches. The LLDP-MED TLVs advertise information such as network policy, power, inventory, and device location details. LLDP and LLDP-MED information can be used by SNMP applications to simplify troubleshooting, enhance network management, and maintain an accurate network topology.

Setting LLDP Timing Attributes

Use the Administration > LLDP (Configure Global) page to set attributes for general functions such as globally enabling LLDP on the switch, setting the message ageout time, and setting the frequency for broadcasting general advertisements or reports about changes in the LLDP MIB.

Parameters

These parameters are displayed:

- ♦ **LLDP** – Enables LLDP globally on the switch. (Default: Enabled)
- ♦ **Transmission Interval** – Configures the periodic transmit interval for LLDP advertisements. (Range: 5-32768 seconds; Default: 30 seconds)
- ♦ **Hold Time Multiplier** – Configures the time-to-live (TTL) value sent in LLDP advertisements as shown in the formula below. (Range: 2-10; Default: 4)

The time-to-live tells the receiving LLDP agent how long to retain all information pertaining to the sending LLDP agent if it does not transmit updates in a timely manner.

TTL in seconds is based on the following rule: minimum value ((Transmission Interval * Holdtime Multiplier), or 65535) Therefore, the default TTL is $4 * 30 = 120$ seconds.

- ◆ **Delay Interval** – Configures a delay between the successive transmission of advertisements initiated by a change in local LLDP MIB variables. (Range: 1-8192 seconds; Default: 2 seconds)

The transmit delay is used to prevent a series of successive LLDP transmissions during a short period of rapid changes in local LLDP MIB objects, and to increase the probability that multiple, rather than single changes, are reported in each transmission.

This attribute must comply with the rule: $(4 * \text{Delay Interval}) \leq \text{Transmission Interval}$

- ◆ **Reinitialization Delay** – Configures the delay before attempting to re-initialize after LLDP ports are disabled or the link goes down. (Range: 1-10 seconds; Default: 2 seconds)

When LLDP is re-initialized on a port, all information in the remote systems LLDP MIB associated with this port is deleted.

- ◆ **Notification Interval** – Configures the allowed interval for sending SNMP notifications about LLDP MIB changes. (Range: 5-3600 seconds; Default: 5 seconds)

This parameter only applies to SNMP applications which use data stored in the LLDP MIB for network monitoring or management.

Information about changes in LLDP neighbors that occur between SNMP notifications is not transmitted. Only state changes that exist at the time of a notification are included in the transmission. An SNMP agent should therefore periodically check the value of `lldpStatsRemTableLastChangeTime` to detect any `lldpRemTablesChange` notification-events missed due to throttling or transmission loss.

- ◆ **MED Fast Start Count** – Configures the amount of LLDP MED Fast Start LLDPDUs to transmit during the activation process of the LLDP-MED Fast Start mechanism. (Range: 1-10 packets; Default: 4 packets)

The MED Fast Start Count parameter is part of the timer which ensures that the LLDP-MED Fast Start mechanism is active for the port. LLDP-MED Fast Start is critical to the timely startup of LLDP, and therefore integral to the rapid availability of Emergency Call Service.

Web Interface

To configure LLDP timing attributes:

1. Click **Administration > LLDP**.
2. Select Configure Global from the Step list.
3. Enable LLDP, and modify any of the timing parameters as required.

4. Click **Apply**.

Administration > LLDP

Step: 1. Configure Global

LLDP Enabled

Transmission Interval (5-32768) sec

Hold Time Multiplier (2-10)

Delay Interval (1-8192) sec

Reinitialization Delay (1-10) sec

Notification Interval (5-3600) sec

MED Fast Start Count (1-10)

Note: The Transmission Interval must be greater than or equal to 4 times the Delay Interval.

Configuring LLDP Interface Attributes

Use the Administration > LLDP (Configure Interface - Configure General) page to specify the message attributes for individual interfaces, including whether messages are transmitted, received, or both transmitted and received, whether SNMP notifications are sent, and the type of information advertised.

Parameters

These parameters are displayed:

- ◆ **Admin Status** – Enables LLDP message transmit and receive modes for LLDP Protocol Data Units. (Options: Tx only, Rx only, TxRx, Disabled; Default: TxRx)
- ◆ **SNMP Notification** – Enables the transmission of SNMP trap notifications about LLDP and LLDP-MED changes. (Default: Disabled)

This option sends out SNMP trap notifications to designated target stations at the interval specified by the Notification Interval in the preceding section. Trap notifications include information about state changes in the LLDP MIB (IEEE 802.1AB), the LLDP-MED MIB (ANSI/TIA-1057), or vendor-specific LLDP-EXT-DOT1 and LLDP-EXT-DOT3 MIBs.

For information on defining SNMP trap destinations, see Specifying Trap Managers.

Information about additional changes in LLDP neighbors that occur between SNMP notifications is not transmitted. Only state changes that exist at the time of a trap notification are included in the transmission. An SNMP agent should therefore periodically check the value of

lldpStatsRemTableLastChangeTime to detect any lldpRemTablesChange notification-events missed due to throttling or transmission loss.

- ◆ **MED Notification** – Enables the transmission of SNMP trap notifications about LLDP-MED changes. (Default: Disabled)
- ◆ **Basic Optional TLVs** – Configures basic information included in the TLV field of advertised messages.
 - ◆ **Management IP Address** – The management address protocol packet includes the IPv4 address of the switch. If no management address is available, the address should be the MAC address for the CPU or for the port sending this advertisement. (Default: Enabled)

The management address TLV may also include information about the specific interface associated with this address, and an object identifier indicating the type of hardware component or protocol entity associated with this address. The interface number and OID are included to assist SNMP applications in the performance of network discovery by indicating enterprise specific or other starting points for the search, such as the Interface or Entity MIB.

Since there are typically a number of different addresses associated with a Layer 3 device, an individual LLDP PDU may contain more than one management address TLV.

Every management address TLV that reports an address that is accessible on a port and protocol VLAN through the particular port should be accompanied by a port and protocol VLAN TLV that indicates the VLAN identifier (VID) associated with the management address reported by this TLV.

- ◆ **Management IPv6 Address** – The management address protocol packet includes the IPv6 address of the switch. If no management address is available, the address should be the MAC address for the CPU or for the port sending this advertisement. (Default: Disabled)
- ◆ **Port Description** – The port description is taken from the ifDescr object in RFC 2863, which includes information about the manufacturer, the product name, and the version of the interface hardware/software. (Default: Enabled)
- ◆ **System Capabilities** – The system capabilities identifies the primary function(s) of the system and whether or not these primary functions are enabled. The information advertised by this TLV is described in IEEE 802.1AB. (Default: Enabled)
- ◆ **System Description** – The system description is taken from the sysDescr object in RFC 3418, which includes the full name and

- version identification of the system's hardware type, software operating system, and networking software. (Default: Enabled)
- ◆ **System Name** – The system name is taken from the sysName object in RFC 3418, which contains the system's administratively assigned name. To configure the system name, see Displaying System Information. (Default: Enabled)
 - ◆ **802.1 Organizationally Specific TLVs** – Configures IEEE 802.1 information included in the TLV field of advertised messages.
 - ◆ **Protocol Identity** – The protocols that are accessible through this interface (see Protocol VLANs). (Default: Enabled)
 - ◆ **VLAN ID** – The port's default VLAN identifier (PVID) indicates the VLAN with which untagged or priority-tagged frames are associated (see IEEE 802.1Q VLANs). (Default: Enabled)
 - ◆ **VLAN Name** – The name of all VLANs to which this interface has been assigned (see IEEE 802.1Q VLANs). (Default: Enabled)
 - ◆ **Port and Protocol VLAN ID** – The port-based protocol VLANs configured on this interface (see Protocol VLANs). (Default: Enabled)
 - ◆ **802.3 Organizationally Specific TLVs** – Configures IEEE 802.3 information included in the TLV field of advertised messages.
 - ◆ **Link Aggregation** – The link aggregation capabilities, aggregation status of the link, and the IEEE 802.3 aggregated port identifier if this interface is currently a link aggregation member. (Default: Enabled)
 - ◆ **Max Frame Size** – The maximum frame size. (See Configuring Support for Jumbo Frames for information on configuring the maximum frame size for this switch. (Default: Enabled)
 - ◆ **MAC/PHY Configuration/Status** – The MAC/PHY configuration and status which includes information about auto-negotiation support/capabilities, and operational Multistation Access Unit (MAU) type. (Default: Enabled)
 - ◆ **MED TLVs** – Configures general information included in the MED TLV field of advertised messages.
 - ◆ **Capabilities** – This option advertises LLDP-MED TLV capabilities, allowing Media Endpoint and Connectivity Devices to efficiently discover which LLDP-MED related TLVs are supported on the switch. (Default: Enabled)
 - ◆ **Extended Power** – (ES0154/ES0154P) This option advertises extended Power-over-Ethernet capability details, such as power availability from the switch, and power state of the switch, including whether the switch is operating from primary or backup power (the

Endpoint Device could use this information to decide to enter power conservation mode). (Default: Enabled)

- ◆ **Inventory** – This option advertises device details useful for inventory management, such as manufacturer, model, software version and other pertinent information. (Default: Enabled)
- ◆ **Location** – This option advertises location identification details. (Default: Enabled)
- ◆ **Network Policy** – This option advertises network policy configuration information, aiding in the discovery and diagnosis of VLAN configuration mismatches on a port. Improper network policy configurations frequently result in voice quality degradation or complete service disruption. (Default: Enabled)
- ◆ **MED-Location Civic Address** – Configures information for the location of the attached device included in the MED TLV field of advertised messages, including the country and the device type.
 - ◆ **Country** – The two-letter ISO 3166 country code in capital ASCII letters. (Example: DK, DE or US)
 - ◆ **Device entry refers to** – The type of device to which the location applies:
 - ◆ Location of the DHCP server.
 - ◆ Location of the network element believed to be the closest to client.
 - ◆ Location of the client. (This is the default.)

Web Interface

To configure LLDP interface attributes:

1. Click **Administration > LLDP**.
2. Select Configure Interface from the Step list.
3. Select Configure General from the Action list.
4. Select an interface from the Port or Trunk list.
5. Set the LLDP transmit/receive mode, specify whether or not to send SNMP trap messages, and select the information to advertise in LLDP messages.
6. Click **Apply**.

Administration > LLDP

Step: 2: Configure Interface Action: Configure General

Interface: Port 1 Trunk

Admin Status: Tx/Rx

SNMP Notification: Enabled

MED Notification: Enabled

Basic Optional TLVs:

Management IPv4 Address Management IPv6 Address Port Description System Capabilities

System Description System Name

802.1 Organizationally Specific TLVs:

Protocol Identity VLAN ID VLAN Name Port and Protocol VLAN ID

802.3 Organizationally Specific TLVs:

Link Aggregation Max Frame Size MAC/PHY Configuration/Status

PoE

MED TLVs:

Capabilities Extended Power Inventory Location

Network Policy

MED-Location Civic Address:

Country: TW

Device entry refers to: Location of the client

Note: The country string shall be a two-letter ISO 3166 country code, e.g. US

Apply Revert

Configuring LLDP Interface Civic-Address

Use the Administration > LLDP (Configure Interface – Add CA-Type) page to specify the physical location of the device attached to an interface.

Command Usage

- Use the Civic Address type (CA-Type) to advertise the physical location of the device attached to an interface, including items such as the city, street number, building and room information. The address location is specified as a type and value pair, with the civic address type defined in RFC 4776. The following table describes some of the CA type numbers and provides examples.

CA Type	Description	CA Value Example
1	National subdivisions (state, canton, province)	California
2	County, parish	Orange
3	City, township	Irvine
4	City division, borough, city district	West Irvine
5	Neighborhood, block	Riverside
6	Group of streets below the neighborhood level	Exchange

CA Type	Description	CA Value Example
18	Street suffix or type	Avenue
19	House number	320
20	House number suffix	A
21	Landmark or vanity address	Tech Center
26	Unit (apartment, suite)	Apt 519
27	Floor	5
28	Room	509B

- ◆ Any number of CA type and value pairs can be specified for the civic address location, as long as the total does not exceed 250 characters.

Parameters

These parameters are displayed:

- ◆ **CA-Type** – Descriptor of the data civic address value. (Range: 0-255)
- ◆ **CA-Value** – Description of a location. (Range: 1-32 characters)

Web Interface

To specify the physical location of the attached device:

1. Click **Administration > LLDP**.
2. Select Configure Interface from the Step list.
3. Select Add or Modify CA-Type from the Action list.
4. Select an interface from the Port or Trunk list.
5. Specify a CA-Type and CA-Value pair.
6. Click **Apply**.

Administration > LLDP

Step: 2. Configure Interface Action: Add CA-Type

Interface Port 1 Trunk 1

CA-Type (0-255)

CA-Value

To show the physical location of the attached device:

1. Click **Administration > LLDP**.
2. Select Configure Interface from the Step list.
3. Select Show CA-Type from the Action list.
4. Select an interface from the Port or Trunk list.

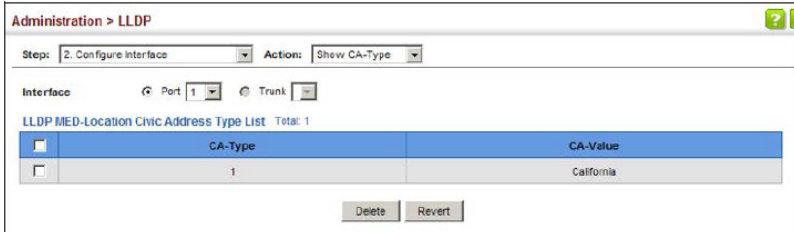

Displaying LLDP Local Device Information

Use the Administration > LLDP (Show Local Device Information) page to display information about the switch, such as its MAC address, chassis ID, management IP address, and port information.

Parameters

These parameters are displayed:

General Settings

- ♦ **Chassis Type** – Identifies the chassis containing the IEEE 802 LAN entity associated with the transmitting LLDP agent. There are several ways in which a chassis may be identified and a chassis ID subtype is used to indicate the type of component being referenced by the chassis ID field.

ID Basis	Reference
Chassis Component	EntPhysicalAlias when entPhysClass has a value of 'chassis(3)' (IETF RFC 2737)
Interface Alias	IfAlias (IETF RFC 2863)
Port Component	EntPhysicalAlias when entPhysicalClass has a value 'port(10)' or 'backplane(4)' (IETF RFC 2737)
MAC Address	MAC address (IEEE Std 802-2001)
Network Address	networkAddress
Interface Name	ifName (IETF RFC 2863)
Locally Assigned	locally assigned

- ♦ **Chassis ID** – An octet string indicating the specific identifier for the particular chassis in this system.
- ♦ **System Name** – A string that indicates the system’s administratively assigned name.
- ♦ **System Description** – A textual description of the network entity. This field is also displayed by the **show system** command.
- ♦ **System Capabilities Supported** – The capabilities that define the primary function(s) of the system.

ID Basis	Reference
Other	—
Repeater	IETF RFC 2108
Bridge	IETF RFC 2674
WLAN Access Point	IEEE 802.11 MIB
Router	IETF RFC 1812
Telephone	IETF RFC 2011
DOCSIS Cable Device	IETF RFC 2669 and IETF RFC 2670
End Station Only	IETF RFC 2011

- ♦ **System Capabilities Enabled** – The primary function(s) of the system which are currently enabled. Refer to the preceding table.
- ♦ **Management Address** – The management address associated with the local system. If no management address is available, the address should be the MAC address for the CPU or for the port sending this advertisement.

Interface Settings

The attributes listed below apply to both port and trunk interface types. When a trunk is listed, the descriptions apply to the first port of the trunk.

- ♦ **Port/Trunk Description** – A string that indicates the port or trunk description. If RFC 2863 is implemented, the ifDescr object should be used for this field.
- ♦ **Port/Trunk ID** – A string that contains the specific identifier for the port or trunk from which this LLDPDU was transmitted.

Interface Details

The attributes listed below apply to both port and trunk interface types. When a trunk is listed, the descriptions apply to the first port of the trunk.

- ♦ **Local Port/Trunk** – Local interface on this switch.

- ◆ **Port/Trunk ID Type** – There are several ways in which a port may be identified. A port ID subtype is used to indicate how the port is being referenced in the Port ID TLV.

ID Basis	Reference
Interface Alias	IfAlias (IETF RFC 2863)
Chassis Component	EntPhysicalAlias when entPhysClass has a value of 'chassis(3)' (IETF RFC 2737)
Port Component	EntPhysicalAlias when entPhysicalClass has a value 'port(10)' or 'backplane(4)' (IETF RFC 2737)
MAC Address	MAC address (IEEE Std 802-2001)
Network Address	networkAddress
Interface Name	ifName (IETF RFC 2863)
Agent Circuit ID	agent circuit ID (IETF RFC 3046)
Locally Assigned	locally assigned

- ◆ **Port/Trunk ID** – A string that contains the specific identifier for the local interface based on interface subtype used by this switch.
- ◆ **Port/Trunk Description** – A string that indicates the port or trunk description. If RFC 2863 is implemented, the ifDescr object should be used for this field.
- ◆ **MED Capability** – The supported set of capabilities that define the primary function(s) of the interface:
 - ◆ LLDP-MED Capabilities
 - ◆ Network Policy
 - ◆ Location Identification
 - ◆ Inventory

Web Interface

To display LLDP information for the local device:

1. Click **Administration > LLDP**.
2. Select Show Local Device Information from the Step list.
3. Select General, Port, Port Details, Trunk, or Trunk Details.

Displaying Local Device Information for LLDP (General)

Administration > LLDP

Step: 3. Show Local Device Information

General
 Port
 Port Details
 Trunk
 Trunk Details

LLDP Local Device Information

Chassis Type	MAC Address
Chassis ID	E4-9D-73-1B-5E-00
System Name	
System Description	ECS4150-28P
System Capabilities Supported	Bridge, Router
System Capabilities Enabled	Bridge, Router
Management Address	192.168.1.1 (IPv4)

Displaying Local Device Information for LLDP (Port)

Administration > LLDP

Step: 3. Show Local Device Information

General
 Port
 Port Details
 Trunk
 Trunk Details

LLDP Local Device Port List Total: 28

Port	Port Description	Port ID
1	Ethernet Port on unit 1, port 1	90-3C-B3-8C-44-B3
2	Ethernet Port on unit 1, port 2	90-3C-B3-8C-44-B4
3	Ethernet Port on unit 1, port 3	90-3C-B3-8C-44-B5
4	Ethernet Port on unit 1, port 4	90-3C-B3-8C-44-B6
5	Ethernet Port on unit 1, port 5	90-3C-B3-8C-44-B7

Displaying Local Device Information for LLDP (Port Details)

Administration > LLDP

Step: 3. Show Local Device Information

General
 Port
 Port Details
 Trunk
 Trunk Details

Port 1

LLDP Local Port Information Details

Port ID Type	MAC Address
Port ID	E4-9D-73-1B-5E-01
Port Description	Ethernet Port on unit 1, port 1
MED Capability	LLDP-MED Capabilities, Network Policy, Location Identification, Extended Power via MDI - PSE, Inventory

Displaying LLDP Remote Device Information

Use the Administration > LLDP (Show Remote Device Information) page to display information about devices connected directly to the switch's ports which are advertising information through LLDP, or to display detailed information about an LLDP-enabled device connected to a specific port on the local switch.

Parameters

These parameters are displayed:

Port

- ◆ **Local Port** – The local port to which a remote LLDP-capable device is attached.
- ◆ **Chassis ID** – An octet string indicating the specific identifier for the particular chassis in this system.
- ◆ **Port ID** – A string that contains the specific identifier for the port from which this LLDPDU was transmitted.
- ◆ **System Name** – A string that indicates the system's administratively assigned name.

Port Details

- ◆ **Port** – Port identifier on local switch.
- ◆ **Remote Index** – Index of remote device attached to this port.
- ◆ **Local Port** – The local port to which a remote LLDP-capable device is attached.
- ◆ **Chassis Type** – Identifies the chassis containing the IEEE 802 LAN entity associated with the transmitting LLDP agent. There are several ways in which a chassis may be identified and a chassis ID subtype is used to indicate the type of component being referenced by the chassis ID field.
- ◆ **Chassis ID** – An octet string indicating the specific identifier for the particular chassis in this system.
- ◆ **Port Type** – Indicates the basis for the identifier that is listed in the Port ID field.
- ◆ **Port ID** – A string that contains the specific identifier for the port from which this LLDPDU was transmitted.
- ◆ **Port Description** – A string that indicates the port's description. If RFC 2863 is implemented, the ifDescr object should be used for this field.
- ◆ **System Name** – A string that indicates the system's assigned name.

- ◆ **System Description** – A textual description of the network entity.
- ◆ **System Capabilities Supported** – The capabilities that define the primary function(s) of the system.
- ◆ **System Capabilities Enabled** – The primary function(s) of the system which are currently enabled.
- ◆ **Management Address List** – The management addresses for this device. Since there are typically a number of different addresses associated with a Layer 3 device, an individual LLDP PDU may contain more than one management address TLV.

If no management address is available, the address should be the MAC address for the CPU or for the port sending this advertisement.

Port Details – 802.1 Extension Information

- ◆ **Remote Port VID** – The port’s default VLAN identifier (PVID) indicates the VLAN with which untagged or priority-tagged frames are associated.
- ◆ **Remote Port-Protocol VLAN List** – The port-based protocol VLANs configured on this interface, whether the given port (associated with the remote system) supports port-based protocol VLANs, and whether the port-based protocol VLANs are enabled on the given port associated with the remote system.
- ◆ **Remote VLAN Name List** – VLAN names associated with a port.
- ◆ **Remote Protocol Identity List** – Information about particular protocols that are accessible through a port. This object represents an arbitrary local integer value used by this agent to identify a particular protocol identity, and an octet string used to identify the protocols associated with a port of the remote system.

Port Details – 802.3 Extension Port Information

- ◆ **Remote Port Auto-Neg Supported** – Shows whether the given port (associated with remote system) supports auto-negotiation.
- ◆ **Remote Port Auto-Neg Adv-Capability** – The value (bitmap) of the ifMauAutoNegCapAdvertisedBits object (defined in IETF RFC 3636) which is associated with a port on the remote system.

Bit	Capability
0	other or unknown
1	10BASE-T half duplex mode
2	10BASE-T full duplex mode
3	100BASE-T4

Bit	Capability
4	100BASE-TX half duplex mode
5	100BASE-TX full duplex mode
6	100BASE-T2 half duplex mode
7	100BASE-T2 full duplex mode
8	PAUSE for full-duplex links
9	Asymmetric PAUSE for full-duplex links
10	Symmetric PAUSE for full-duplex links
11	Asymmetric and Symmetric PAUSE for full-duplex links
12	1000BASE-X, -LX, -SX, -CX half duplex mode
13	1000BASE-X, -LX, -SX, -CX full duplex mode
14	1000BASE-T half duplex mode
15	1000BASE-T full duplex mode

- ◆ **Remote Port Auto-Neg Status** – Shows whether port auto-negotiation is enabled on a port associated with the remote system.
- ◆ **Remote Port MAU Type** – An integer value that indicates the operational MAU type of the sending device. This object contains the integer value derived from the list position of the corresponding dot3MauType as listed in IETF RFC 3636 and is equal to the last number in the respective dot3MauType OID.

Port Details – 802.3 Extension Power Information

- ◆ **Remote Power Class** – The port Class of the given port associated with the remote system (PSE – Power Sourcing Equipment or PD – Powered Device).
- ◆ **Remote Power MDI Status** – Shows whether MDI power is enabled on the given port associated with the remote system.
- ◆ **Remote Power Pairs** – “Signal” means that the signal pairs only are in use, and “Spare” means that the spare pairs only are in use.
- ◆ **Remote Power MDI Supported** – Shows whether MDI power is supported on the given port associated with the remote system.
- ◆ **Remote Power Pair Controllable** – Indicates whether the pair selection can be controlled for sourcing power on the given port associated with the remote system.
- ◆ **Remote Power Classification** – This classification is used to tag different terminals on the Power over LAN network according to their power

consumption. Devices such as IP telephones, WLAN access points and others, will be classified according to their power requirements.

Port Details – 802.3 Extension Trunk Information

- ◆ **Remote Link Aggregation Capable** – Shows if the remote port is not in link aggregation state and/or it does not support link aggregation.
- ◆ **Remote Link Aggregation Status** – The current aggregation status of the link.
- ◆ **Remote Link Port ID** – This object contains the IEEE 802.3 aggregated port identifier, aAggPortID (IEEE 802.3-2002, 30.7.2.1.1), derived from the ifNumber of the ifIndex for the port component associated with the remote system. If the remote port is not in link aggregation state and/or it does not support link aggregation, this value should be zero.

Port Details – 802.3 Extension Frame Information

- ◆ **Remote Max Frame Size** – An integer value indicating the maximum supported frame size in octets on the port component associated with the remote system.

Port Details – LLDP-MED Capability¹⁰

- ◆ **Device Class** – Any of the following categories of endpoint devices:
 - ◆ Class 1 – The most basic class of endpoint devices.
 - ◆ Class 2 – Endpoint devices that supports media stream capabilities.
 - ◆ Class 3 – Endpoint devices that directly supports end users of the IP communication systems.
 - ◆ Network Connectivity Device – Devices that provide access to the IEEE 802 based LAN infrastructure for LLDP-MED endpoint devices. These may be any LAN access device including LAN switch/router, IEEE 802.1 bridge, IEEE 802.3 repeater, IEEE 802.11 wireless access point, or any device that supports the IEEE 802.1AB and MED extensions defined by this Standard and can relay IEEE 802 frames via any method.
- ◆ **Supported Capabilities** – The supported set of capabilities that define the primary function(s) of the port:
 - ◆ LLDP-MED Capabilities
 - ◆ Network Policy
 - ◆ Location Identification
 - ◆ Extended Power via MDI – PSE
 - ◆ Extended Power via MDI – PD
 - ◆ Inventory

- ◆ **Current Capabilities** – The set of capabilities that define the primary function(s) of the port which are currently enabled.

Port Details – Network Policy¹⁰

- ◆ **Application Type** – The primary application(s) defined for this network policy:
 - ◆ Voice
 - ◆ Voice Signaling
 - ◆ Guest Signaling
 - ◆ Guest Voice Signaling
 - ◆ Softphone Voice
 - ◆ Video Conferencing
 - ◆ Streaming Video
 - ◆ Video Signaling
- ◆ **Tagged Flag** – Indicates whether the specified application type is using a tagged or untagged VLAN.
- ◆ **Layer 2 Priority** – The Layer 2 priority to be used for the specified application type. This field may specify one of eight priority levels (0-7), where a value of 0 represents use of the default priority.
- ◆ **Unknown Policy Flag** – Indicates that an endpoint device wants to explicitly advertise that this policy is required by the device, but is currently unknown.
- ◆ **VLAN ID** – The VLAN identifier (VID) for the port as defined in IEEE 802.1Q. A value of zero indicates that the port is using priority tagged frames, meaning that only the IEEE 802.1D priority level is significant and the default PVID of the ingress port is used instead.
- ◆ **DSCP Value** – The DSCP value to be used to provide Diffserv node behavior for the specified application type. This field may contain one of 64 code point values (0-63). A value of 0 represents use of the default DSCP value as defined in RFC 2475.

Port Details – Location Identification¹⁰

Note: 10. These fields are only displayed for end-node devices advertising LLDP-MED TLVs.

- ◆ **Location Data Format** – Any of these location ID data formats:

- ◆ Coordinate-based LCI¹¹ – Defined in RFC 3825, includes latitude resolution, latitude, longitude resolution, longitude, altitude type, altitude resolution, altitude, and datum.
- ◆ Civic Address LCI¹¹ – Includes What, Country code, CA type, CA length and CA value. “What” is described as the field entry “Device entry refers to” under Configuring LLDP Interface Attributes. The other items are described under Configuring LLDP Interface Civic-Address.

Note: 11. Location Configuration Information.

- ◆ ECS ELIN – Emergency Call Service Emergency Location Identification Number supports traditional PSAP-based Emergency Call Service in North America.
- ◆ **Country Code** – The two-letter ISO 3166 country code in capital ASCII letters. (Example: DK, DE or US)
- ◆ **What** – The type of device to which the location applies as described for the field entry “Device entry refers to” under Configuring LLDP Interface Attributes.

Port Details – Extended Power-via-MDI

- ◆ **Power Type** – Power Sourcing Entity (PSE) or Power Device (PD).
- ◆ **Power Priority** – Shows power priority for a port. (Unknown, Low, High, Critical)
- ◆ **Power Source** – Shows information based on the type of device:
 - ◆ **PD** – Unknown, PSE, Local, PSE and Local
 - ◆ **PSE** – Unknown, Primary Power Source, Backup Power Source - Power conservation mode
- ◆ **Power Value** – The total power in watts required by a PD device from a PSE device, or the total power a PSE device is capable of sourcing over a maximum length cable based on its current configuration. This parameter supports a maximum power required or available value of 102.3 Watts to allow for future expansion. (Range: 0 - 102.3 Watts)

Port Details – Inventory¹⁰

Note: 10. These fields are only displayed for end-node devices advertising LLDP-MED TLVs.

- ◆ **Hardware Revision** – The hardware revision of the end-point device.
- ◆ **Software Revision** – The software revision of the end-point device.

- ◆ **Manufacture Name** – The manufacturer of the end-point device.
- ◆ **Asset ID** – The asset identifier of the end-point device. End-point devices are typically assigned asset identifiers to facilitate inventory management and assets tracking.
- ◆ **Firmware Revision** – The firmware revision of the end-point device.
- ◆ **Serial Number** – The serial number of the end-point device.
- ◆ **Model Name** – The model name of the end-point device.

Web Interface

To display LLDP information for a remote port:

1. Click **Administration > LLDP**.
2. Select Show Remote Device Information from the Step list.
3. Select Port, Port Details, Trunk, or Trunk Details.
4. When the next page opens, select a port on this switch and the index for a remote device attached to this port.
5. Click **Query**.

Displaying Remote Device Information for LLDP (Port)

The screenshot shows the 'Administration > LLDP' page. The 'Step' dropdown is set to '4. Show Remote Device Information'. Below this, there are radio buttons for 'Port', 'Port Details', 'Trunk', and 'Trunk Details', with 'Port' selected. A table titled 'LLDP Remote Device Port List' shows a total of 1 entry. The table has four columns: Local Port, Chassis ID, Port ID, and System Name.

Local Port	Chassis ID	Port ID	System Name
1	70-72-CF-32-DD-FD	70-72-CF-32-DD-FF	RD93

The screenshot shows the 'Administration > LLDP' page with the 'Step' dropdown set to '4. Show Remote Device Information'. Below this, there are radio buttons for 'Port', 'Port Details', 'Trunk', and 'Trunk Details', with 'Port Details' selected. There are two dropdown menus: 'Port' with '1' selected and 'Remote Index' with '2' selected. A 'Query' button is located at the bottom right.

Displaying Remote Device Information for LLDP (Port Details)

Administration > LLDP

Step: 4. Show Remote Device Information

Port
 Port Details
 Trunk
 Trunk Details

Port:
 Remote Index:

LLDP Remote Device Port Information

Local Port: 1
Chassis Type: 00-08-83-08-DB-20
Chassis ID: 1
Port Type: MAC Address
Port ID: 00-08-83-08-DB-20
Port Description: Ethernet Port on unit 1, port 15
System Name: Ethernet Switch
System Description: Bridge
System Capabilities Supported: ES0154
System Capabilities Enabled: Bridge

Management Address List Total: 3

Address	Address Type
192.168.2.3	IPv4 Address
2000::2009	IPv6 Address
00-01-02-03-04-05	MAC Address

802.1 Extension Information

Remote Port VID: 1

Remote Port-Protocol VLAN List Total: 1

VLAN	Support	Status
1	Yes	Enabled

Remote VLAN Name List Total: 1

VLAN	Name
1	DefaultVlan

Remote Protocol Identity List Total: 1

Remote Protocol Identity (Hex)
88-CC

802.3 Extension Port Information

Remote Port Auto-Neg Supported	Yes	Remote Port Auto-Neg Status	Enabled
Remote Port Auto-Neg Adv-Capability	0000	Remote Port MAU Type	6

802.3 Extension Power Information

Remote Power Class	PSE	Remote Power MDI Supported	Yes
Remote Power MDI Status	Enabled	Remote Power Pair Controlable	No
Remote Power Pairs	Spare	Remote Power Classification	Class1

802.3 Extension Trunk Information

Remote Link Aggregation Capable	Yes	Remote Link Aggregation Status	Disabled
Remote Link Port ID	0		

802.3 Extension Frame Information

Remote Max Frame Size	1518
-----------------------	------

Additional information displayed by an end-point device which advertises LLDP-MED TLVs is shown in the following figure.

Displaying Remote Device Information for LLDP (End Node)

Administration > LLDP

Step: 4. Show Remote Device Information

LLDP-MED Capability

Device Class Network Connectivity

Supported Capabilities LLDP-MED Capabilities, Network Policy, Location Identification, Inventory

Current Capabilities LLDP-MED Capabilities, Network Policy, Location Identification, Inventory

Network Policy

Application Type	Guest Voice Signaling	Unknown Policy Flag	Disabled
Tagged Flag	Disabled	VLAN ID	7
Layer 2 Priority	2	DSCP Value	62

Location Identification

Location Data Format Coordinate-based LCI

Country Code	TW	What	2
---------------------	----	-------------	---

Location Identification

Location Data Format Civic Address LCI

Country Code	US	What	2
---------------------	----	-------------	---

Extended Power-via-MDI

Power Type	PSE	Power Source	Unknown
Power Priority	Unknown	Power Value	0 W Watts

Inventory

Hardware Revision	R01	Firmware Revision	1.2.2.1
Software Revision	1.2.2.1	Serial Number	LN10230692
Manufacture Name		Model Name	L
Asset ID			

Displaying Device Statistics

Use the Administration > LLDP (Show Device Statistics) page to display statistics for LLDP-capable devices attached to the switch, and for LLDP protocol messages transmitted or received on all local interfaces.

Parameters

These parameters are displayed:

General Statistics on Remote Devices

- ◆ **Neighbor Entries List Last Updated** – The time the LLDP neighbor entry list was last updated.
- ◆ **New Neighbor Entries Count** – The number of LLDP neighbors for which the remote TTL has not yet expired.

- ◆ **Neighbor Entries Deleted Count** – The number of LLDP neighbors which have been removed from the LLDP remote systems MIB for any reason.
- ◆ **Neighbor Entries Dropped Count** – The number of times which the remote database on this switch dropped an LLDPDU because of insufficient resources.
- ◆ **Neighbor Entries Age-out Count** – The number of times that a neighbor's information has been deleted from the LLDP remote systems MIB because the remote TTL timer has expired.

Port/Trunk

- ◆ **Frames Discarded** – Number of frames discarded because they did not conform to the general validation rules as well as any specific usage rules defined for the particular TLV.
- ◆ **Frames Invalid** – A count of all LLDPDUs received with one or more detectable errors.
- ◆ **Frames Received** – Number of LLDP PDUs received.
- ◆ **Frames Sent** – Number of LLDP PDUs transmitted.
- ◆ **TLVs Unrecognized** – A count of all TLVs not recognized by the receiving LLDP local agent.
- ◆ **TLVs Discarded** – A count of all LLDPDUs received and then discarded due to insufficient memory space, missing or out-of-sequence attributes, or any other reason.
- ◆ **Neighbor Ageouts** – A count of the times that a neighbor's information has been deleted from the LLDP remote systems MIB because the remote TTL timer has expired.

Web Interface

To display statistics for LLDP-capable devices attached to the switch:

1. Click **Administration > LLDP**.
2. Select Show Device Statistics from the Step list.
3. Select General, Port, or Trunk.

Displaying LLDP Device Statistics (General)

Administration > LLDP

Step:

General
 Port
 Trunk

LLDP Device Statistics

Neighbor Entries List Last Updated	2 sec
New Neighbor Entries Count	20
Neighbor Entries Deleted Count	20
Neighbor Entries Dropped Count	0
Neighbor Entries Age-out Count	20

Displaying LLDP Device Statistics (Port)

Administration > LLDP

Step:

General
 Port
 Trunk

Port:

LLDP Device Port Statistics

Frames Discarded	0	TLVs Unrecognized	0
Frames Invalid	0	TLVs Discarded	0
Frames Received	97	Neighbor Ageouts	0
Frames Sent	104		

Power over Ethernet

The switch can provide DC power to a wide range of connected devices, eliminating the need for an additional power source and cutting down on the amount of cables attached to each device. Once configured to supply power, an automatic detection process is initialized by the switch that is authenticated by a PoE signature from the connected device. Detection and authentication prevent damage to non-compliant devices (prior to IEEE 802.3af).

The switch's power management enables individual port power to be controlled within the switch's power budget. Port power can be automatically turned on and off for connected devices, and a per-port power priority can be set so that the switch never exceeds its power budget. When a device is connected to a switch port, its power requirements are detected by the switch before power is supplied. If the power required by a device exceeds the power budget of the port or the whole switch, port power priority settings are used to control the supplied power.

Ports can be set to one of three power priority levels, critical, high or low. To control the power supply within the switch's budget, ports set at critical to high priority have power enabled in preference to those ports set at low priority. For example, when a device connected to a port is set to critical priority, the switch supplies the required power, if necessary by denying power to ports set for a lower priority.

Setting the Switch's Overall PoE Power Budget

Use the Administration > PoE > PSE (Global Information) page to view the maximum PoE power budget for the switch (power available to all RJ-45 ports). The maximum power budget is fixed at the maximum available setting, which prevents overload conditions at the power source. If the power demand from devices connected to the switch exceeds the power budget, the switch uses port power priority settings to limit the supplied power.

Parameters

These parameters are displayed:

- ◆ **PoE Maximum Available Power** – The power budget for the switch. If devices connected to the switch require more power than the switch budget, the port power priority settings are used to control the supplied power.
- ◆ **PoE Maximum Allocation Power** – The maximum power allocated to switch ports.

- ◆ **System Operation Status** – Status of the PoE power service provided to the switch ports.
- ◆ **PoE Power Consumption** – The amount of power being consumed by PoE devices connected to the switch.
- ◆ **Software Version** – The version of software running on the PoE controller subsystem in the switch.

Web Interface

To view the overall PoE power budget for switch:

1. Click **Administration > PoE**.
2. Select Global Information from the Step list.

Administration > PoE > PSE	
Step:	1. Global Information
PoE Maximum Available Power	370000 milliwatts using main power
PoE Maximum Allocation Power	370000 milliwatts
System Operation Status	Off
PoE Power Consumption	0 milliwatts
Software Version	Version 0007 (Hex)

Setting the Port PoE Power Budget

Use the Administration > PoE (Configure Interface) page to set the PoE power allocation priority and maximum power provided to a port.

Command Usage

- ◆ The switches support the IEEE 802.3af PoE and IEEE 802.3at-2009 PoE+ standards, and the switch also supports the IEEE 802.3bt PoE++ standard on ports 41-48.
- ◆ The total PoE power delivered by all ports cannot exceed the maximum power budget of the switch. The maximum number of ports which can supply power simultaneously at the specified levels are shown in the following table.

Maximum Port Power	ES0154/ES0154P
4 W (Class 1)	48
7 W (Class 2)	48
15.4 W (Class 3)	48

Maximum Port Power	ES0154/ES0154P
30 W (Class 4)	24
45 W (Class 5)	8 (Ports 41-48 only)
60 W (Class 6)	8 (Ports 41-48 only)
75 W (Class 7)	8 (Ports 41-48 only)
90 W (Class 8)	8 (Ports 41-48 only)

- ◆ If a device is connected to a switch port and the switch detects that it requires more than the power budget set for the port, no power is supplied to the device (i.e., port power remains off).
- ◆ If the power demand from devices connected to all switch ports exceeds the power budget set for the switch, the port power priority settings are used to control the supplied power.
 - ◆ If a device connected to a low-priority port causes the switch to exceed its budget, power will be dropped from low-priority ports starting in reverse sequence from the highest RJ-45 port number.
For example, with all ports low priority and ports 2-13 on, when you connect port 1, power to port 13 will turn off and power to port 1 will turn on.
 - ◆ If a device is connected to a critical or high-priority port that would cause the switch to exceed its power budget as determined during bootup, power is provided to the port only if the switch can drop power to one or more lower-priority ports and thereby remain within its overall budget. Power will be dropped from lower-priority ports starting in reverse sequence from the highest RJ-45 port number.
For example, if ports 2 to 14 request 30W and ports 2-12 are low priority with ports 13-14 high priority, port 12 will turn off and ports 2-11 and 13-14 will turn on.
 - ◆ If priority is not set for any ports, and PoE consumption exceeds the maximum power provided by the switch, power is shut down starting in reverse sequence from the highest RJ-45 port number.

Parameters

These parameters are displayed:

- ◆ **Port** – The port number on the switch. (Range: 1-24/48)
- ◆ **Admin Status** – Enables PoE power on a port. Power is automatically supplied when a device is detected on a port, providing that the power

demanded does not exceed the switch or port power budget. (Default: Enabled)

- ♦ **Mode** – Shows whether or not PoE power is being supplied to a port.
- ♦ **Time Range Name** – Name of a time range. If a time range is set, then PoE will be provided to an interface during the specified period.
- ♦ **Time Range Status** – Indicates if a time range has been applied to an interface, and whether it is currently active or inactive.
- ♦ **Class** – The power class of a connected device.
- ♦ **Priority** – Sets the power priority for a port. (Options: Low, High or Critical; Default: Low)
- ♦ **Power Allocation** – Sets the power budget for a port.
- ♦ **Power Consumption** – Current power consumption on a port.

Web Interface

To set the PoE power budget for a port:

1. Click **Administration > PoE > PSE**.
2. Select Configure Interface from the Step list.
3. Enable PoE power on selected ports. Set the priority and the power budget.
4. Click **Apply**.

Administration > PoE > PSE ?

Step: 2. Configure Interface

PoE Port List Total: 24 1 2 3

Port	Admin Status	Mode	Time-Range Name	Time-Range Status	Class	Priority	Power Allocation	Power Consumption (milliwatts)
1	<input checked="" type="checkbox"/> Enabled	off	<input type="checkbox"/> <input type="text"/>	NA	-	Low	<input type="text" value="30000"/>	0
2	<input checked="" type="checkbox"/> Enabled	off	<input type="checkbox"/> <input type="text"/>	NA	-	Low	<input type="text" value="30000"/>	0
3	<input checked="" type="checkbox"/> Enabled	off	<input type="checkbox"/> <input type="text"/>	NA	-	Low	<input type="text" value="30000"/>	0
4	<input checked="" type="checkbox"/> Enabled	off	<input type="checkbox"/> <input type="text"/>	NA	-	Low	<input type="text" value="30000"/>	0
5	<input checked="" type="checkbox"/> Enabled	off	<input type="checkbox"/> <input type="text"/>	NA	-	Low	<input type="text" value="30000"/>	0
6	<input checked="" type="checkbox"/> Enabled	off	<input type="checkbox"/> <input type="text"/>	NA	-	Low	<input type="text" value="30000"/>	0
7	<input checked="" type="checkbox"/> Enabled	off	<input type="checkbox"/> <input type="text"/>	NA	-	Low	<input type="text" value="30000"/>	0
8	<input checked="" type="checkbox"/> Enabled	off	<input type="checkbox"/> <input type="text"/>	NA	-	Low	<input type="text" value="30000"/>	0
9	<input checked="" type="checkbox"/> Enabled	off	<input type="checkbox"/> <input type="text"/>	NA	-	Low	<input type="text" value="30000"/>	0
10	<input checked="" type="checkbox"/> Enabled	off	<input type="checkbox"/> <input type="text"/>	NA	-	Low	<input type="text" value="30000"/>	0

Apply Revert

Simple Network Management Protocol (SNMP)

Simple Network Management Protocol (SNMP) is a communication protocol designed specifically for managing devices on a network. Equipment commonly managed with SNMP includes switches, routers and host computers. SNMP is typically used to configure these devices for proper operation in a network environment, as well as to monitor them to evaluate performance or detect potential problems.

Managed devices supporting SNMP contain software, which runs locally on the device and is referred to as an agent. A defined set of variables, known as managed objects, is maintained by the SNMP agent and used to manage the device. These objects are defined in a Management Information Base (MIB) that provides a standard presentation of the information controlled by the agent. SNMP defines both the format of the MIB specifications and the protocol used to access this information over the network.

The switch includes an onboard agent that supports SNMP versions 1, 2c, and 3. This agent continuously monitors the status of the switch hardware, as well as the traffic passing through its ports. A network management station can access this information using network management software. Access to the onboard agent from clients using SNMP v1 and v2c is controlled by community strings. To communicate with the switch, the management station must first submit a valid community string for authentication.

Access to the switch from clients using SNMPv3 provides additional security features that cover message integrity, authentication, and encryption; as well as controlling user access to specific areas of the MIB tree.

The SNMPv3 security structure consists of security models, with each model having its own security levels. There are three security models defined, SNMPv1, SNMPv2c, and SNMPv3. Users are assigned to “groups” that are defined by a security model and specified security levels. Each group also has a defined security access to set of MIB objects for reading and writing, which are known as “views.” The switch has a default view (all MIB objects) and default groups defined for security models v1 and v2c. The following table shows the security models and levels available and the system default settings.

Model	Level	Group	Read View	Write View	Notify View	Security
v1	noAuthNoPriv	public (read only)	defaultview	none	none	Community string only
v1	noAuthNoPriv	private (read/write)	defaultview	defaultview	none	Community string only
v1	noAuthNoPriv	<i>user defined</i>	<i>user defined</i>	<i>user defined</i>	<i>user defined</i>	Community string only
v2c	noAuthNoPriv	public (read only)	defaultview	none	none	Community string only
v2c	noAuthNoPriv	private (read/write)	defaultview	defaultview	none	Community string only
v2c	noAuthNoPriv	<i>user defined</i>	<i>user defined</i>	<i>user defined</i>	<i>user defined</i>	Community string only
v3	noAuthNoPriv	<i>user defined</i>	<i>user defined</i>	<i>user defined</i>	<i>user defined</i>	A user name match only
v3	AuthNoPriv	<i>user defined</i>	<i>user defined</i>	<i>user defined</i>	<i>user defined</i>	Provides user authentication via MD5 or SHA algorithms
v3	AuthPriv	<i>user defined</i>	<i>user defined</i>	<i>user defined</i>	<i>user defined</i>	Provides user authentication via MD5 or SHA algorithms and data privacy using DES 56-bit encryption

Note: The predefined default groups and view can be deleted from the system. You can then define customized groups and views for the SNMP clients that require access.

Command Usage

Configuring SNMPv1/2c Management Access

To configure SNMPv1 or v2c management access to the switch, follow these steps:

1. Use the Administration > SNMP (Configure Global) page to enable SNMP on the switch, and to enable trap messages.
2. Use the Administration > SNMP (Configure Community - Add) page to configure the community strings authorized for management access.
3. Use the Administration > SNMP (Configure Trap) page to specify trap managers so that key events are reported by this switch to your management station.

Configuring SNMPv3 Management Access

1. Use the Administration > SNMP (Configure Global) page to enable SNMP on the switch, and to enable trap messages.
2. Use the Administration > SNMP (Configure Trap) page to specify trap managers so that key events are reported by this switch to your management station.
3. Use the Administration > SNMP (Configure Engine) page to change the local engine ID. If you want to change the default engine ID, it must be changed before configuring other parameters.

4. Use the Administration > SNMP (Configure View) page to specify read and write access views for the switch MIB tree.
5. Use the Administration > SNMP (Configure User) page to configure SNMP user groups with the required security model (i.e., SNMP v1, v2c or v3) and security level (i.e., authentication and privacy).
6. Use the Administration > SNMP (Configure Group) page to assign SNMP users to groups, along with their specific authentication and privacy passwords.

Configuring Global Settings for SNMP

Use the Administration > SNMP (Configure Global) page to enable SNMPv3 service for all management clients (i.e., versions 1, 2c, 3), and to enable trap messages.

Parameters

These parameters are displayed:

- ◆ **Agent Status** – Enables SNMP on the switch. (Default: Enabled)
- ◆ **Authentication Traps**¹² – Issues a notification message to specified IP trap managers whenever an invalid community string is submitted during the SNMP access authentication process. (Default: Enabled)

Note: 12. These are legacy notifications and therefore when used for SNMPv3 hosts, they must be enabled in conjunction with the corresponding entries in the Notification View.

Web Interface

To configure global settings for SNMP:

1. Click **Administration > SNMP**.
2. Select Configure Global from the Step list.
3. Enable SNMP and the required trap types.
4. Click **Apply**.

Administration > SNMP

Step: 1. Configure Global

Agent Status Enabled

Authentication Traps Enabled

Apply Revert

Setting Community Access Strings

Use the Administration > SNMP (Configure Community) page to configure up to five community strings authorized for management access by clients using SNMP v1 and v2c. For security reasons, you should consider removing the default strings.

Parameters

These parameters are displayed:

- ♦ **Community String** – A community string that acts like a password and permits access to the SNMP protocol.
Range: 1-32 characters, case sensitive
Default strings: “public” (Read-Only), “private” (Read/Write)
- ♦ **Access Mode** – Specifies the access rights for the community string:
 - ♦ **Read-Only** – Authorized management stations are only able to retrieve MIB objects.
 - ♦ **Read/Write** – Authorized management stations are able to both retrieve and modify MIB objects.

Web Interface

To set a community access string:

1. Click **Administration > SNMP**.
2. Select Configure Community from the Step list.
3. Select Add from the Action list.
4. Add new community strings as required, and select the corresponding access rights from the Access Mode list.
5. Click **Apply**.

Administration > SNMP

Step: 2. Configure Community Action: Add

Community String: spiderman

Access Mode: Read/Write

Apply Revert

To show the community access strings:

1. Click **Administration > SNMP**.
2. Select Configure Community from the Step list.
3. Select Show from the Action list.

Administration > SNMP

Step: 2. Configure Community Action: Show

SNMP Community String List Total: 3

	Community String	Access Mode
<input type="checkbox"/>	public	Read-Only
<input type="checkbox"/>	private	Read/Write
<input type="checkbox"/>	spiderman	Read/Write

Delete Revert

Setting the Local Engine ID

Use the Administration > SNMP (Configure Engine - Set Engine ID) page to change the local engine ID. An SNMPv3 engine is an independent SNMP agent that resides on the switch. This engine protects against message replay, delay, and redirection. The engine ID is also used in combination with user passwords to generate the security keys for authenticating and encrypting SNMPv3 packets.

Command Usage

A local engine ID is automatically generated that is unique to the switch. This is referred to as the default engine ID. If the local engine ID is deleted or changed, all SNMP users will be cleared. You will need to reconfigure all existing users.

Parameters

These parameters are displayed:

- ♦ **Engine ID** – A new engine ID can be specified by entering 9 to 64 hexadecimal characters (5 to 32 octets in hexadecimal format). If an odd number of characters are specified, a trailing zero is added to the value to fill in the last octet. For example, the value “123456789” is equivalent to “1234567890”.
- ♦ **Engine Boots** – The number of times that the engine has (re-)initialized since the SNMP Engine ID was last configured.

Web Interface

To configure the local SNMP engine ID:

1. Click **Administration > SNMP**.
2. Select **Configure Engine** from the Step list.
3. Select **Set Engine ID** from the Action list.
4. Enter an ID of at least 9 hexadecimal characters.
5. Click **Apply**.

The screenshot shows a web interface titled "Administration > SNMP". It features a "Step:" dropdown menu set to "2. Configure Engine" and an "Action:" dropdown menu set to "Set Engine ID". Below these, there are two input fields: "Engine ID" containing the hexadecimal string "800001030300000c000f0000" and "Engine Boots" set to the value "5". At the bottom right of the form, there are two buttons labeled "Default" and "Save".

Specifying a Remote Engine ID

Use the **Administration > SNMP (Configure Engine - Add Remote Engine)** page to configure a engine ID for a remote management station. To allow management access from an SNMPv3 user on a remote device, you must first specify the engine identifier for the SNMP agent on the remote device where the user resides. The remote engine ID is used to compute the security digest for authentication and encryption of packets passed between the switch and a user on the remote host.

Command Usage

SNMP passwords are localized using the engine ID of the authoritative agent. For informs, the authoritative SNMP agent is the remote agent. You therefore

need to configure the remote agent's SNMP engine ID before you can send proxy requests or informs to it.

Parameters

These parameters are displayed:

- ◆ **Remote Engine ID** – The engine ID can be specified by entering 9 to 64 hexadecimal characters (5 to 32 octets in hexadecimal format). If an odd number of characters are specified, a trailing zero is added to the value to fill in the last octet. For example, the value “123456789” is equivalent to “1234567890”.
- ◆ **Remote IP Host** – The IPv4 address of a remote management station which is using the specified engine ID.

Web Interface

To configure a remote SNMP engine ID:

1. Click **Administration > SNMP**.
2. Select Configure Engine from the Step list.
3. Select Add Remote Engine from the Action list.
4. Enter an ID of a least 9 hexadecimal characters, and the IP address of the remote host.
5. Click **Apply**.

The screenshot shows a web interface titled "Administration > SNMP". At the top, there are two dropdown menus: "Step:" with "2. Configure Engine" selected, and "Action:" with "Add Remote Engine" selected. Below these are two input fields: "Remote Engine ID" containing the value "5432100000" and "Remote IP Host" containing the value "192.168.1.19". At the bottom right of the form are two buttons: "Apply" and "Revert".

To show the remote SNMP engine IDs:

1. Click **Administration > SNMP**.
2. Select Configure Engine from the Step list.
3. Select Show Remote Engine from the Action list.

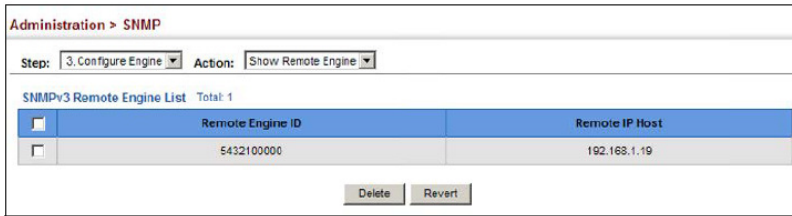

Setting SNMPv3 Views

Use the Administration > SNMP (Configure View) page to configure SNMPv3 views which are used to restrict user access to specified portions of the MIB tree. The predefined view “defaultview” includes access to the entire MIB tree.

Parameters

These parameters are displayed:

Add View

- ♦ **View Name** – The name of the SNMP view. (Range: 1-32 characters)
- ♦ **OID Subtree** – Specifies the initial object identifier of a branch within the MIB tree. Wild cards can be used to mask a specific portion of the OID string. Use the Add OID Subtree page to configure additional object identifiers. (Range: 1-64 characters)
- ♦ **Type** – Indicates if the object identifier of a branch within the MIB tree is included or excluded from the SNMP view.

Add OID Subtree

- ♦ **View Name** – Lists the SNMP views configured in the Add View page. (Range: 1-32 characters)
- ♦ **OID Subtree** – Adds an additional object identifier of a branch within the MIB tree to the selected View. Wild cards can be used to mask a specific portion of the OID string. (Range: 1-64 characters)
- ♦ **Type** – Indicates if the object identifier of a branch within the MIB tree is included or excluded from the SNMP view.

Web Interface

To configure an SNMP view of the switch’s MIB database:

1. Click **Administration > SNMP**.
2. Select Configure View from the Step list.

3. Select Add View from the Action list.
4. Enter a view name and specify the initial OID subtree in the switch's MIB database to be included or excluded in the view. Use the Add OID Subtree page to add additional object identifier branches to the view.
5. Click **Apply**.

Administration > SNMP

Step: 3. Configure View Action: Add View

View Name: ifEntry.a

OID Subtree: 1.3.6.1.2.1.2.2.1.1.*

Type: included

Apply Revert

To show the SNMP views of the switch's MIB database:

1. Click **Administration > SNMP**.
2. Select Configure View from the Step list.
3. Select Show View from the Action list.

Administration > SNMP

Step: 3. Configure View Action: Show View

SNMPv3 View List Total: 2

<input type="checkbox"/>	View name
<input type="checkbox"/>	ifEntry.a
<input type="checkbox"/>	defaultview

Delete Revert

To add an object identifier to an existing SNMP view of the switch's MIB database:

1. Click **Administration > SNMP**.
2. Select Configure View from the Step list.
3. Select Add OID Subtree from the Action list.
4. Select a view name from the list of existing views, and specify an additional OID subtree in the switch's MIB database to be included or excluded in the view.
5. Click **Apply**.

Administration > SNMP

Step: 3. Configure View Action: Add OID Subtree

View Name: ifEntry.a

OID Subtree: 1.3.6.1.2.1.2.2.1.2.*

Type: Included

Apply Revert

To show the OID branches configured for the SNMP views of the switch's MIB database:

1. Click **Administration > SNMP**.
2. Select Configure View from the Step list.
3. Select Show OID Subtree from the Action list.
4. Select a view name from the list of existing views.

Administration > SNMP

Step: 3. Configure View Action: Show OID Subtree

View Name: ifEntry.a

SNMPv3 View OID Subtree List Total: 2

<input type="checkbox"/>	OID Subtree	Type
<input type="checkbox"/>	1.3.6.1.2.1.2.2.1.1.*	Included
<input type="checkbox"/>	1.3.6.1.2.1.2.2.1.2.*	Included

Delete Revert

Configuring SNMPv3 Groups

Use the Administration > SNMP (Configure Group) page to add an SNMPv3 group which can be used to set the access policy for its assigned users, restricting them to specific read, write, and notify views. You can use the pre-defined default groups or create new groups to map a set of SNMP users to SNMP views.

Parameters

These parameters are displayed:

- ◆ **Group Name** – The name of the SNMP group to which the user is assigned. (Range: 1-32 characters)
- ◆ **Security Model** – The user security model; SNMP v1, v2c or v3.

- ◆ **Security Level** – The following security levels are only used for the groups assigned to the SNMP security model:
 - ◆ **noAuthNoPriv** – There is no authentication or encryption used in SNMP communications. (This is the default security level.)
 - ◆ **AuthNoPriv** – SNMP communications use authentication, but the data is not encrypted.
 - ◆ **AuthPriv** – SNMP communications use both authentication and encryption.
- ◆ **Read View** – The configured view for read access. (Range: 1-32 characters)
- ◆ **Write View** – The configured view for write access. (Range: 1-32 characters)
- ◆ **Notify View** – The configured view for notifications. (Range: 1-32 characters)

Model	Level	Group
<i>SNMPv2 Traps</i>		
coldStart	1.3.6.1.6.3.1.1.5.1	A coldStart trap signifies that the SNMPv2 entity, acting in an agent role, is reinitializing itself and that its configuration may have been altered.
warmStart	1.3.6.1.6.3.1.1.5.2	A warmStart trap signifies that the SNMPv2 entity, acting in an agent role, is reinitializing itself such that its configuration is unaltered.
linkDown*	1.3.6.1.6.3.1.1.5.3	A linkDown trap signifies that the SNMP entity, acting in an agent role, has detected that the ifOperStatus object for one of its communication links is about to enter the down state from some other state (but not from the notPresent state). This other state is indicated by the included value of ifOperStatus.
linkUp*	1.3.6.1.6.3.1.1.5.4	A linkUp trap signifies that the SNMP entity, acting in an agent role, has detected that the ifOperStatus object for one of its communication links left the down state and transitioned into some other state (but not into the notPresent state). This other state is indicated by the included value of ifOperStatus.

Model	Level	Group
authenticationFailure*	1.3.6.1.6.3.1.1.5.5	An authenticationFailure trap signifies that the SNMPv2 entity, acting in an agent role, has received a protocol message that is not properly authenticated. While all implementations of the SNMPv2 must be capable of generating this trap, the snmpEnableAuthenTraps object indicates whether this trap will be generated.
<i>RMON Events (V2)</i>		
risingAlarm	1.3.6.1.2.1.16.0.1	The SNMP trap that is generated when an alarm entry crosses its rising threshold and generates an event that is configured for sending SNMP traps.
fallingAlarm	1.3.6.1.2.1.16.0.2	The SNMP trap that is generated when an alarm entry crosses its falling threshold and generates an event that is configured for sending SNMP traps.
<i>Private Traps</i>		
swPowerStatusChangeTrap	1.3.6.1.4.1.259.10.1.55.102.2.1.0.1	This trap is sent when the power state changes.
swPortSecurityTrap	1.3.6.1.4.1.259.10.1.55.102.2.1.0.36	This trap is sent when the port is being intruded. This trap will only be sent when the portSecActionTrap is enabled.
swIpFilterRejectTrap	1.3.6.1.4.1.259.10.1.55.102.2.1.0.40	This trap is sent when an incorrect IP address is rejected by the IP Filter.
swAtcBcastStormAlarmFireTrap	1.3.6.1.4.1.259.10.1.55.102.2.1.0.70	When broadcast traffic is detected as a storm, this trap is fired.
swAtcBcastStormAlarmClearTrap	1.3.6.1.4.1.259.10.1.55.102.2.1.0.71	When a broadcast storm is detected as normal traffic, this trap is fired.
swAtcBcastStormTcApplyTrap	1.3.6.1.4.1.259.10.1.55.102.2.1.0.72	When ATC is activated, this trap is fired.
swAtcBcastStormTcReleaseTrap	1.3.6.1.4.1.259.10.1.55.102.2.1.0.73	When ATC is released, this trap is fired.
swAtcMcastStormAlarmFireTrap	1.3.6.1.4.1.259.10.1.55.102.2.1.0.74	When multicast traffic is detected as the storm, this trap is fired.

Model	Level	Group
swAtcMcastStormAlarmClearTrap	1.3.6.1.4.1.259.10.1.55.102.2.1.0.75	When multicast storm is detected as normal traffic, this trap is fired.
swAtcMcastStormTcApplyTrap	1.3.6.1.4.1.259.10.1.55.102.2.1.0.76	When ATC is activated, this trap is fired.
swAtcMcastStormTcReleaseTrap	1.3.6.1.4.1.259.10.1.55.102.2.1.0.77	When ATC is released, this trap is fired.
stpBpduGuardPortShutdownTrap	1.3.6.1.4.1.259.10.1.55.102.2.1.0.91	This trap will be sent when an interface is shut down because of BPDU guard.
swLoopbackDetectionTrap	1.3.6.1.4.1.259.10.1.55.102.2.1.0.95	This trap is sent when loopback BPDUs have been detected.
autoUpgradeTrap	1.3.6.1.4.1.259.10.1.55.102.2.1.0.104	This trap is sent when auto upgrade is executed.
swCpuUtiRisingNotification	1.3.6.1.4.1.259.10.1.55.102.2.1.0.107	This notification indicates that the CPU utilization has risen from cpuUtiFallingThreshold to cpuUtiRisingThreshold.
swCpuUtiFallingNotification	1.3.6.1.4.1.259.10.1.55.102.2.1.0.108	This notification indicates that the CPU utilization has fallen from cpuUtiRisingThreshold to cpuUtiFallingThreshold.
swMemoryUtiRisingThresholdNotification	1.3.6.1.4.1.259.10.1.55.102.2.1.0.109	This notification indicates that the memory utilization has risen from memoryUtiFallingThreshold to memoryUtiRisingThreshold.
swMemoryUtiFallingThresholdNotification	1.3.6.1.4.1.259.10.1.55.102.2.1.0.110	This notification indicates that the memory utilization has fallen from memoryUtiRisingThreshold to memoryUtiFallingThreshold.
dhcpRougeServerAttackTrap	1.3.6.1.4.1.259.10.1.55.102.2.1.0.114	This trap is sent when receiving a DHCP packet from a rouge server.
macNotificationTrap	1.3.6.1.4.1.259.10.1.55.102.2.1.0.138	This trap is sent when there are changes of the dynamic MAC addresses on the switch.
lbdDetectionTrap	1.3.6.1.4.1.259.10.1.55.102.2.1.0.141	This trap is sent when a loopback condition is detected by LBD.
lbdRecoveryTrap	1.3.6.1.4.1.259.10.1.55.102.2.1.0.142	This trap is sent when a recovery is done by LBD.
sfpThresholdAlarmWarnTrap	1.3.6.1.4.1.259.10.1.55.102.2.1.0.189	This trap is sent when the sfp's A/D quantity is not within alarm/warning thresholds.

Model	Level	Group
userAuthenticationFailureTrap	1.3.6.1.4.1.259.10.1.55.102.2.1.0.199	This trap will be triggered if authentication fails.
userAuthenticationSuccessTrap	1.3.6.1.4.1.259.10.1.55.102.2.1.0.200	This trap will be triggered if authentication is successful.
loginTrap	1.3.6.1.4.1.259.10.1.55.102.2.1.0.201	This trap is sent when user logs in.
logoutTrap	1.3.6.1.4.1.259.10.1.55.102.2.1.0.202	This trap is sent when user logs out.
fileCopyTrap	1.3.6.1.4.1.259.10.1.55.102.2.1.0.208	This trap is sent when file copy is executed. If the copy action is triggered by the system, the login user information (trapVarLoginUserName/ trapVarSessionType/ trapVarLoginInetAddressTypes/ trapVarLoginInetAddress) will be a null value.
userauthCreateUserTrap	1.3.6.1.4.1.259.10.1.55.102.2.1.0.209	This trap is sent when a user account is created.
userauthDeleteUserTrap	1.3.6.1.4.1.259.10.1.55.102.2.1.0.210	This trap is sent when a user account is deleted.
userauthModifyUserPrivilegeTrap	1.3.6.1.4.1.259.10.1.55.102.2.1.0.211	This trap is sent when user privilege is modified.
cpuGuardControlTrap	1.3.6.1.4.1.259.10.1.55.102.2.1.0.213	This trap is sent when CPU utilization rises above the high-watermark the first time or when CPU utilization rises from below the low-watermark to above the high-watermark.
cpuGuardReleaseTrap	1.3.6.1.4.1.259.10.1.55.102.2.1.0.214	This trap is sent when CPU utilization falls from above the high-watermark to below the low-watermark.

Note: * These are legacy notifications and therefore must be enabled in conjunction with the corresponding traps on the SNMP Configuration menu.

Web Interface

To configure an SNMP group:

1. Click **Administration > SNMP**.
2. Select Configure Group from the Step list.
3. Select Add from the Action list.

4. Enter a group name, assign a security model and level, and then select read, write, and notify views.
5. Click **Apply**.

Administration > SNMP

Step: 4. Configure Group Action: Add

Group Name:

Security Model:

Security Level:

Read View: ifEntry.a

Write View: ifEntry.a

Notify View: ifEntry.a

To show SNMP groups:

1. Click **Administration > SNMP**.
2. Select Configure Group from the Step list.
3. Select Show from the Action list.

Administration > SNMP

Step: 4. Configure Group Action: Show

SNMPv3 Group List Total: 4

<input type="checkbox"/>	Group Name	Model	Level	Read View	Write View	Notify View
<input type="checkbox"/>	public	v1	noAuthNoPriv	defaultview	No writeview specified	No notifyview specified
<input type="checkbox"/>	public	v2c	noAuthNoPriv	defaultview	No writeview specified	No notifyview specified
<input type="checkbox"/>	private	v1	noAuthNoPriv	defaultview	defaultview	No notifyview specified
<input type="checkbox"/>	private	v2c	noAuthNoPriv	defaultview	defaultview	No notifyview specified

Configuring Local SNMPv3 Users

Use the Administration > SNMP (Configure User - Add SNMPv3 Local User) page to authorize management access for SNMPv3 clients, or to identify the source of SNMPv3 trap messages sent from the local switch. Each SNMPv3 user is defined by a unique name. Users must be configured with a specific security level and assigned to a group. The SNMPv3 group restricts users to a specific read, write, and notify view.

Parameters

These parameters are displayed:

- ◆ **User Name** – The name of user connecting to the SNMP agent. (Range: 1-32 characters)
- ◆ **Group Name** – The name of the SNMP group to which the user is assigned. (Range: 1-32 characters)
- ◆ **Security Model** – The user security model; SNMP v1, v2c, or v3.
- ◆ **Security Level** – The following security levels are only used for the groups assigned to the SNMP security model:
 - ◆ **noAuthNoPriv** – There is no authentication or encryption used in SNMP communications. (This is the default security level.)
 - ◆ **AuthNoPriv** – SNMP communications use authentication, but the data is not encrypted.
 - ◆ **AuthPriv** – SNMP communications use both authentication and encryption.
- ◆ **Authentication Protocol** – The method used for user authentication. (Options: MD5, SHA; Default: MD5)
- ◆ **Authentication Password** – A minimum of eight plain text characters is required. (Range: 8-32 characters)
- ◆ **Privacy Protocol** – The encryption algorithm use for data privacy; only 56-bit DES is currently available.
- ◆ **Privacy Password** – A minimum of eight plain text characters is required.

Web Interface

To configure a local SNMPv3 user:

1. Click **Administration > SNMP**.
2. Select Configure User from the Step list.
3. Select Add SNMPv3 Local User from the Action list.
4. Enter a name and assign it to a group. If the security model is set to SNMPv3 and the security level is authNoPriv or authPriv, then an authentication protocol and password must be specified. If the security level is authPriv, a privacy password must also be specified.
5. Click **Apply**.

Administration > SNMP

Step: Action:

SNMPv3 User

User Name:

Group Name: public

Security Model:

Security Level:

User Authentication

Authentication Protocol:

Authentication Password:

Data Privacy

Privacy Protocol:

Privacy Password:

To show local SNMPv3 users:

1. Click **Administration > SNMP**.
2. Select Configure User from the Step list.
3. Select Show SNMPv3 Local User from the Action list.

Administration > SNMP

Step: Action:

SNMPv3 Local User List Total: 1

<input type="checkbox"/>	User Name	Group Name	Model	Level	Authentication	Privacy
<input type="checkbox"/>	chris	r&d	v3	authPriv	MD5	DES56

To change a local SNMPv3 local user group:

1. Click **Administration > SNMP**.
2. Select Change SNMPv3 Local User Group from the Action list.
3. Select the User Name.
4. Enter a new group name.
5. Click **Apply**.

Administration > SNMP

Step: 5. Configure User Action: Change SNMPv3 Local User Group

User Name:

Group Name: bart public

Configuring Remote SNMPv3 Users

Use the Administration > SNMP (Configure User - Add SNMPv3 Remote User) page to identify the source of SNMPv3 inform messages sent from the local switch. Each SNMPv3 user is defined by a unique name. Users must be configured with a specific security level and assigned to a group. The SNMPv3 group restricts users to a specific read, write, and notify view.

Command Usage

- ◆ To grant management access to an SNMPv3 user on a remote device, you must first specify the engine identifier for the SNMP agent on the remote device where the user resides. The remote engine ID is used to compute the security digest for authentication and encryption of packets passed between the switch and the remote user.

Parameters

These parameters are displayed:

- ◆ **User Name** – The name of user connecting to the SNMP agent. (Range: 1-32 characters)
- ◆ **Group Name** – The name of the SNMP group to which the user is assigned. (Range: 1-32 characters)
- ◆ **Remote IP** – IPv4 address of the remote device where the user resides.
- ◆ **Security Model** – The user security model; SNMP v1, v2c or v3. (Default: v3)
- ◆ **Security Level** – The following security levels are only used for the groups assigned to the SNMP security model:
 - ◆ **noAuthNoPriv** – There is no authentication or encryption used in SNMP communications. (This is the default security level.)
 - ◆ **AuthNoPriv** – SNMP communications use authentication, but the data is not encrypted.

- ◆ **AuthPriv** – SNMP communications use both authentication and encryption.
- ◆ **Authentication Protocol** – The method used for user authentication. (Options: MD5, SHA; Default: MD5)
- ◆ **Authentication Password** – A minimum of eight plain text characters is required.
- ◆ **Privacy Protocol** – The encryption algorithm use for data privacy; only 56-bit DES is currently available.
- ◆ **Privacy Password** – A minimum of eight plain text characters is required.

Web Interface

To configure a remote SNMPv3 user:

1. Click **Administration > SNMP**.
2. Select Configure User from the Step list.
3. Select Add SNMPv3 Remote User from the Action list.
4. Enter a name and assign it to a group. Enter the IP address to identify the source of SNMPv3 inform messages sent from the local switch. If the security model is set to SNMPv3 and the security level is authNoPriv or authPriv, then an authentication protocol and password must be specified. If the security level is authPriv, a privacy password must also be specified.
5. Click **Apply**.

The screenshot shows the 'Administration > SNMP' web interface. At the top, the breadcrumb 'Administration > SNMP' is visible. Below it, the 'Step:' dropdown is set to '5. Configure User' and the 'Action:' dropdown is set to 'Add SNMPv3 Remote User'. The main configuration area is titled 'SNMPv3 User' and contains the following fields:

- User Name:** mark
- Group Name:** public (selected in dropdown), with a radio button selected for 'r&d' and an input field containing 'r&d'.
- Remote IP:** 192.168.1.19
- Security Model:** v3
- Security Level:** authPriv
- User Authentication:**
 - Authentication Protocol:** MD5
 - Authentication Password:** greenpeace
- Data Privacy:**
 - Privacy Protocol:** DES56
 - Privacy Password:** einsten

At the bottom right of the form, there are two buttons: 'Apply' and 'Revert'.

To show remote SNMPv3 users:

1. Click **Administration > SNMP**.
2. Select Configure User from the Step list.
3. Select Show SNMPv3 Remote User from the Action list.

Administration > SNMP

Step: 5. Configure User Action: Show SNMPv3 Remote User

SNMPv3 Remote User List Total: 1

<input type="checkbox"/>	User Name	Group Name	Engine ID	Model	Level	Authentication	Privacy
<input type="checkbox"/>	mark	r&d	5432100030	v3	authPriv	NDS	DESS6

Delete
Revert

Specifying Trap Managers

Use the Administration > SNMP (Configure Trap) page to specify the host devices to be sent traps and the types of traps to send. Traps indicating status changes are issued by the switch to the specified trap managers. You must specify trap managers so that key events are reported by this switch to your management station (using network management software). You can specify up to five management stations that will receive authentication failure messages and other trap messages from the switch.

Command Usage

- Notifications are issued by the switch as trap messages by default. The recipient of a trap message does not send a response to the switch. Traps are therefore not as reliable as inform messages, which include a request for acknowledgment of receipt. Informs can be used to ensure that critical information is received by the host. However, note that informs consume more system resources because they must be kept in memory until a response is received. Informs also add to network traffic. You should consider these effects when deciding whether to issue notifications as traps or informs.

To send an inform to a SNMPv2c host, complete these steps:

1. Enable the SNMP agent.
2. Create a view with the required notification messages.
3. Configure the group (matching the community string specified on the Configure Trap - Add page) to include the required notify view.
4. Enable trap informs as described in the following pages.

To send an inform to a SNMPv3 host, complete these steps:

1. Enable the SNMP agent.
2. Create a remote SNMPv3 user to use in the message exchange process. If the user specified in the trap configuration page does not exist, an SNMPv3 group will be automatically created using the name of the specified remote user, and default settings for the read, write, and notify view.
3. Create a view with the required notification messages.
4. Create a group that includes the required notify view.
5. Enable trap informs as described in the following pages.

Parameters

These parameters are displayed:

SNMP Version 1

- ♦ **IP Address** – IPv4 or IPv6 address of a new management station to receive notification message (i.e., the targeted recipient).
- ♦ **Version** – Specifies whether to send notifications as SNMP v1, v2c, or v3 traps. (Default: v1)
- ♦ **Community String** – Specifies a valid community string for the new trap manager entry. (Range: 1-32 characters, case sensitive)
Although you can set this string in the Configure Trap – Add page, we recommend defining it in the Configure User – Add Community page.
- ♦ **UDP Port** – Specifies the UDP port number used by the trap manager. (Default: 162)

SNMP Version 2c

- ♦ **IP Address** – IPv4 or IPv6 address of a new management station to receive notification message (i.e., the targeted recipient).
- ♦ **Version** – Specifies whether to send notifications as SNMP v1, v2c, or v3 traps.
- ♦ **Notification Type**
 - ♦ **Traps** – Notifications are sent as trap messages.
 - ♦ **Inform** – Notifications are sent as inform messages. Note that this option is only available for version 2c and 3 hosts. (Default: traps are used)
 - ♦ **Timeout** – The number of seconds to wait for an acknowledgment before resending an inform message. (Range: 0-2147483647 centiseconds; Default: 1500 centiseconds)

- ♦ **Retry times** – The maximum number of times to resend an inform message if the recipient does not acknowledge receipt. (Range: 0-255; Default: 3)
- ♦ **Community String** – Specifies a valid community string for the new trap manager entry. (Range: 1-32 characters, case sensitive)
Although you can set this string in the Configure Trap – Add page, we recommend defining it in the Configure User – Add Community page.
- ♦ **UDP Port** – Specifies the UDP port number used by the trap manager. (Default: 162)

SNMP Version 3

- ♦ **IP Address** – IPv4 or IPv6 address of a new management station to receive notification message (i.e., the targeted recipient).
- ♦ **Version** – Specifies whether to send notifications as SNMP v1, v2c, or v3 traps.
- ♦ **Notification Type**
 - ♦ **Traps** – Notifications are sent as trap messages.
 - ♦ **Inform** – Notifications are sent as inform messages. Note that this option is only available for version 2c and 3 hosts. (Default: traps are used)
 - ♦ **Timeout** – The number of seconds to wait for an acknowledgment before resending an inform message. (Range: 0-2147483647 centiseconds; Default: 1500 centiseconds)
 - ♦ **Retry times** – The maximum number of times to resend an inform message if the recipient does not acknowledge receipt. (Range: 0-255; Default: 3)
- ♦ **Local User Name** – The name of a local user which is used to identify the source of SNMPv3 trap messages sent from the local switch. (Range: 1-32 characters)
If an account for the specified user has not been created, one will be automatically generated.
- ♦ **Remote User Name** – The name of a remote user which is used to identify the source of SNMPv3 inform messages sent from the local switch. (Range: 1-32 characters)
If an account for the specified user has not been created, one will be automatically generated.
- ♦ **UDP Port** – Specifies the UDP port number used by the trap manager. (Default: 162)

- ◆ **Security Level** – When trap version 3 is selected, you must specify one of the following security levels. (Default: noAuthNoPriv)
 - ◆ **noAuthNoPriv** – There is no authentication or encryption used in SNMP communications.
 - ◆ **AuthNoPriv** – SNMP communications use authentication, but the data is not encrypted.
 - ◆ **AuthPriv** – SNMP communications use both authentication and encryption.

Web Interface

To configure trap managers:

1. Click **Administration > SNMP**.
2. Select Configure Trap from the Step list.
3. Select Add from the Action list.
4. Fill in the required parameters based on the selected SNMP version.
5. Click **Apply**.

Configuring Trap Managers (SNMPv1)

The screenshot shows a web interface for configuring SNMP trap managers. The breadcrumb navigation is "Administration > SNMP". Below the breadcrumb, there are two dropdown menus: "Step:" with "6. Configure Trap" selected, and "Action:" with "Add" selected. The main configuration area contains four fields: "IP Address" with the value "192.168.0.3", "Version" with a dropdown menu showing "v1", "Community String" with the value "private", and "UDP Port (1-65535)" with the value "162". At the bottom right of the form, there are two buttons: "Apply" and "Revert".

Configuring Trap Managers (SNMPv2c)

Administration > SNMP

Step: 6. Configure Trap Action: Add

IP Address: 192.168.2.9

Version: v2c

Notification Type: Inform

Timeout (0-2147483647): centiseconds

Retry Times (0-255):

Community String: venus

UDP Port (1-65535):

Apply Revert

Configuring Trap Managers (SNMPv3)

Administration > SNMP

Step: 6. Configure Trap Action: Add

IP Address: 192.168.2.9

Version: v3

Notification Type: Inform

Timeout (0-2147483647): centiseconds

Retry Times (0-255):

Remote User Name:

UDP Port (1-65535):

Security Level: authPriv

Apply Revert

To show configured trap managers:

1. Click **Administration > SNMP**.
2. Select Configure Trap from the Step list.
3. Select Show from the Action list.

Administration > SNMP

Step: 6. Configure Trap Action: Show

SNMP Trap Manager List Total: 5

<input type="checkbox"/>	IP Address	Version	Community String/User Name	UDP Port	Security Level	Timeout	Retry Times
<input type="checkbox"/>	192.168.0.4	v3	steve	162	noAuthNoPriv		
<input type="checkbox"/>	192.168.0.5	v3	bobby	162	noAuthNoPriv		
<input type="checkbox"/>	192.168.0.6	v3	betty	162	authNoPriv		
<input type="checkbox"/>	192.168.2.9	v2c	venus	162		1800	5
<input type="checkbox"/>	192.168.5.8	v3	margaret	162	authPriv	1600	5

Delete Revert

Creating SNMP Notification Logs

Use the Administration > SNMP (Configure Notify Filter - Add) page to create an SNMP notification log.

Command Usage

- ◆ Systems that support SNMP often need a mechanism for recording Notification information as a hedge against lost notifications, whether there are Traps or Informs that may be exceeding retransmission limits. The Notification Log MIB (NLM, RFC 3014) provides an infrastructure in which information from other MIBs may be logged.
- ◆ Given the service provided by the NLM, individual MIBs can now bear less responsibility to record transient information associated with an event against the possibility that the Notification message is lost, and applications can poll the log to verify that they have not missed any important Notifications.
- ◆ If notification logging is not configured, when the switch reboots, some SNMP traps (such as warm start) cannot be logged.
- ◆ To avoid this problem, notification logging should be configured as described in this section, and these commands stored in the startup configuration file using the System > File (Copy – Running-Config) page as described. Then when the switch reboots, SNMP traps (such as warm start) can now be logged.
- ◆ Based on the default settings used in RFC 3014, a notification log can contain up to 256 entries, and the entry aging time is 1440 minutes. Information recorded in a notification log, and the entry aging time can only be configured using SNMP from a network management station.
- ◆ When a trap host is created using the Administration > SNMP (Configure Trap – Add) page described, a default notify filter will be created.

Parameters

These parameters are displayed:

- ◆ **IP Address** – The IPv4 or IPv6 address of a remote device. The specified target host must already have been configured using the Administration > SNMP (Configure Trap – Add) page.

The notification log is stored locally. It is not sent to a remote device. This remote host parameter is only required to complete mandatory fields in the SNMP Notification MIB.

- ◆ **Filter Profile Name** – Notification log profile name. (Range: 1-32 characters)

Web Interface

To create an SNMP notification log:

1. Click **Administration > SNMP**.
2. Select Configure Notify Filter from the Step list.
3. Select Add from the Action list.
4. Fill in the IP address of a configured trap manager and the filter profile name.
5. Click **Apply**.

Administration > SNMP

Step: 7. Configure Notify Filter Action: Add

IP Address: 192.168.0.99

Filter Profile Name: R&D

Apply Revert

To show configured SNMP notification logs:

1. Click **Administration > SNMP**.
2. Select Configure Notify Filter from the Step list.
3. Select Show from the Action list..

Administration > SNMP

Step: 7. Configure Notify Filter Action: Show

SNMP NOTIFY FILTER LIST Total: 1

<input type="checkbox"/>	filter profile name	IP Address
<input type="checkbox"/>	R&D	192.168.0.99

Delete Revert

Showing SNMP Statistics

Use the Administration > SNMP (Show Statistics) page to show counters for SNMP input and output protocol data units.

Parameters

The following counters are displayed:

- ◆ **SNMP packets input** – The total number of messages delivered to the SNMP entity from the transport service.
- ◆ **Bad SNMP version errors** – The total number of SNMP messages which were delivered to the SNMP entity and were for an unsupported SNMP version.
- ◆ **Unknown community name** – The total number of SNMP messages delivered to the SNMP entity which used a SNMP community name not known to said entity.
- ◆ **Illegal operation for community name supplied** – The total number of SNMP messages delivered to the SNMP entity which represented an SNMP operation which was not allowed by the SNMP community named in the message.
- ◆ **Encoding errors** – The total number of ASN.1 or BER errors encountered by the SNMP entity when decoding received SNMP messages.
- ◆ **Number of requested variables** – The total number of MIB objects which have been retrieved successfully by the SNMP protocol entity as the result of receiving valid SNMP Get-Request and Get-Next PDUs.
- ◆ **Number of altered variables** – The total number of MIB objects which have been altered successfully by the SNMP protocol entity as the result of receiving valid SNMP Set-Request PDUs.
- ◆ **Get-request PDUs** – The total number of SNMP Get-Request PDUs which have been accepted and processed, or generated, by the SNMP protocol entity.
- ◆ **Get-next PDUs** – The total number of SNMP Get-Next PDUs which have been accepted and processed, or generated, by the SNMP protocol entity.
- ◆ **Set-request PDUs** – The total number of SNMP Set-Request PDUs which have been accepted and processed, or generated, by the SNMP protocol entity.
- ◆ **SNMP packets output** – The total number of SNMP Messages which were passed from the SNMP protocol entity to the transport service.
- ◆ **Too big errors** – The total number of SNMP PDUs which were generated by the SNMP protocol entity and for which the value of the error-status field is “tooBig.”
- ◆ **No such name errors** – The total number of SNMP PDUs which were delivered to, or generated by, the SNMP protocol entity and for which the value of the error-status field is “noSuchName.”

- ◆ **Bad values errors** – The total number of SNMP PDUs which were delivered to, or generated by, the SNMP protocol entity and for which the value of the error-status field is “badValue.”
- ◆ **General errors** – The total number of SNMP PDUs which were delivered to, or generated by, the SNMP protocol entity and for which the value of the error-status field is “genErr.”
- ◆ **Response PDUs** – The total number of SNMP Get-Response PDUs which have been accepted and processed by, or generated by, the SNMP protocol entity.
- ◆ **Trap PDUs** – The total number of SNMP Trap PDUs which have been accepted and processed by, or generated by, the SNMP protocol entity.

Web Interface

To show SNMP statistics:

1. Click **Administration > SNMP**.
2. Select Show Statistics from the Step list.

Administration > SNMP

Step: 8. Show Statistics

SNMP Statistics

SNMP packets Input	0	SNMP packets Output	0
Bad SNMP version errors	0	Too big errors	0
Unknown community name	0	No such name errors	0
Illegal operation for community name supplied	0	Bad values errors	0
Encoding errors	0	General errors	0
Number of requested variables	0	Response PDUs	0
Number of altered variables	0	Trap PDUs	0
Get-request PDUs	0		
Get-next PDUs	0		
Set-request PDUs	0		

Refresh

Remote Monitoring (RMON)

Remote Monitoring allows a remote device to collect information or respond to specified events on an independent basis. This switch is an RMON-capable device which can independently perform a wide range of tasks, significantly reducing network management traffic. It can continuously run diagnostics and log information on network performance. If an event is triggered, it can automatically notify the network administrator of a failure and provide historical information about the event. If it cannot connect to the management agent, it will continue to perform any specified tasks and pass data back to the management station the next time it is contacted.

The switch supports mini-RMON, which consists of the Statistics, History, Event and Alarm groups. When RMON is enabled, the system gradually builds up information about its physical interfaces, storing this information in the relevant RMON database group. A management agent then periodically communicates with the switch using the SNMP protocol. However, if the switch encounters a critical event, it can automatically send a trap message to the management agent which can then respond to the event if so configured.

Configuring RMON Alarms

Use the Administration > RMON (Configure Global - Add - Alarm) page to define specific criteria that will generate response events. Alarms can be set to test data over any specified time interval, and can monitor absolute or changing values (such as a statistical counter reaching a specific value, or a statistic changing by a certain amount over the set interval). Alarms can be set to respond to rising or falling thresholds. (However, note that after an alarm is triggered it will not be triggered again until the statistical value crosses the opposite bounding threshold and then back across the trigger threshold.

Command Usage

- ◆ If an alarm is already defined for an index, the entry must be deleted before any changes can be made.

Parameters

These parameters are displayed:

- ◆ **Index** – Index to this entry. (Range: 1-65535)
- ◆ **Variable** – The object identifier of the MIB variable to be sampled. Only variables of the type etherStatsEntry.n.n may be sampled.

Note that `etherStatsEntry.n` uniquely defines the MIB variable, and `etherStatsEntry.n.n` defines the MIB variable, plus the `etherStatsIndex`. For example, `1.3.6.1.2.1.16.1.1.1.6.1` denotes `etherStatsBroadcastPkts`, plus the `etherStatsIndex` of 1.

- ◆ **Interval** – The polling interval. (Range: 1-31622400 seconds)
- ◆ **Sample Type** – Tests for absolute or relative changes in the specified variable.
 - ◆ **Absolute** – The variable is compared directly to the thresholds at the end of the sampling period.
 - ◆ **Delta** – The last sample is subtracted from the current value and the difference is then compared to the thresholds.
- ◆ **Rising Threshold** – If the current value is greater than or equal to the rising threshold, and the last sample value was less than this threshold, then an alarm will be generated. After a rising event has been generated, another such event will not be generated until the sampled value has fallen below the rising threshold, reaches the falling threshold, and again moves back up to the rising threshold. (Range: 0-2147483647)
- ◆ **Rising Event Index** – The index of the event to use if an alarm is triggered by monitored variables reaching or crossing above the rising threshold. If there is no corresponding entry in the event control table, then no event will be generated. (Range: 0-65535)
- ◆ **Falling Threshold** – If the current value is less than or equal to the falling threshold, and the last sample value was greater than this threshold, then an alarm will be generated. After a falling event has been generated, another such event will not be generated until the sampled value has risen above the falling threshold, reaches the rising threshold, and again moves back down to the falling threshold. (Range: 0-2147483647)
- ◆ **Falling Event Index** – The index of the event to use if an alarm is triggered by monitored variables reaching or crossing below the falling threshold. If there is no corresponding entry in the event control table, then no event will be generated. (Range: 0-65535)
- ◆ **Owner** – Name of the person who created this entry. (Range: 1-32 characters)

Web Interface

To configure an RMON alarm:

1. Click **Administration > RMON**.
2. Select **Configure Global** from the Step list.

3. Select **Add** from the Action list.
4. Click **Alarm**.
5. Enter an index number, the MIB object to be polled (etherStatsEntry.n.n), the polling interval, the sample type, the thresholds, and the event to trigger.
6. Click **Apply**.

Administration > RMON

Step: 1. Configure Global Action: Add

Alarm Event

Index (1-65535)

Variable

Interval (1-31622400) sec

Sample Type

Rising Threshold (0-2147483647)

Rising Event Index (0-65535)

Falling Threshold (0-2147483647)

Falling Event Index (0-65535)

Owner

To show configured RMON alarms:

1. Click **Administration > RMON**.
2. Select **Configure Global** from the Step list.
3. Select **Show** from the Action list.
4. Click **Alarm**.

Administration > RMON

Step: 1. Configure Global Action: Show

Alarm Event

RMON Alarm List Total: 20 1 2 3

<input type="checkbox"/>	Index	Status	Variable	Interval	Type	Last Value	Rising Threshold	Rising Event Index	Falling Threshold	Falling Event Index	Owner
<input type="checkbox"/>	1	Valid	1.3.6.1.2.1.16.1.1.1.6.1	30	Delta	0	892800	0	446400	0	
<input type="checkbox"/>	2	Valid	1.3.6.1.2.1.16.1.1.1.6.2	30	Delta	0	892800	0	446400	0	
<input type="checkbox"/>	3	Valid	1.3.6.1.2.1.16.1.1.1.6.3	30	Delta	0	892800	0	446400	0	
<input type="checkbox"/>	4	Valid	1.3.6.1.2.1.16.1.1.1.6.4	30	Delta	0	892800	0	446400	0	
<input type="checkbox"/>	5	Valid	1.3.6.1.2.1.16.1.1.1.6.5	30	Delta	0	892800	0	446400	0	

Configuring RMON Events

Use the Administration > RMON (Configure Global - Add - Event) page to set the action to take when an alarm is triggered. The response can include logging the alarm or sending a message to a trap manager. Alarms and corresponding events provide a way of immediately responding to critical network problems.

Command Usage

- ◆ If an alarm is already defined for an index, the entry must be deleted before any changes can be made.
- ◆ One default event is configured as follows:
 - ◆ event Index = 1
 - ◆ Description: RMON_TRAP_LOG
 - ◆ Event type: log & trap
 - ◆ Event community name is public
 - ◆ Owner is RMON_SNMP

Parameters

These parameters are displayed:

- ◆ **Index** – Index to this entry. (Range: 1-65535)
- ◆ **Type** – Specifies the type of event to initiate:
 - ◆ **None** – No event is generated.
 - ◆ **Log** – Generates an RMON log entry when the event is triggered. Log messages are processed based on the current configuration settings for event logging.
 - ◆ **Trap** – Sends a trap message to all configured trap managers.
 - ◆ **Log and Trap** – Logs the event and sends a trap message.
- ◆ **Community** – A password-like community string sent with the trap operation to SNMP v1 and v2c hosts.

Although the community string can be set on this configuration page, it is recommended that it be defined on the SNMP trap configuration page prior to configuring it here. (Range: 1-32 characters)
- ◆ **Description** – A comment that describes this event. (Range: 1-127 characters)
- ◆ **Owner** – Name of the person who created this entry. (Range: 1-32 characters)

Web Interface

To configure an RMON event:

1. Click **Administration > RMON**.
2. Select Configure Global from the Step list.
3. Select Add from the Action list.
4. Click **Event**.
5. Enter an index number, the type of event to initiate, the community string to send with trap messages, the name of the person who created this event, and a brief description of the event.
6. Click **Apply**.

The screenshot shows the 'Administration > RMON' web interface. At the top, the breadcrumb 'Administration > RMON' is visible. Below it, the 'Step' is set to '1. Configure Global' and the 'Action' is 'Add'. There are two radio buttons: 'Alarm' (unselected) and 'Event' (selected). The form contains the following fields:

- Index (1-65535):** 2
- Type:** Log and Trap
- Community:** private
- Description:** for software group
- Owner:** david

At the bottom right, there are 'Apply' and 'Revert' buttons.

To show configured RMON events:

1. Click **Administration > RMON**.
2. Select Configure Global from the Step list.
3. Select Show from the Action list.
4. Click **Event**.

The screenshot shows the 'Administration > RMON' web interface. At the top, the breadcrumb 'Administration > RMON' is visible. Below it, the 'Step' is set to '1. Configure Global' and the 'Action' is 'Show'. There are two radio buttons: 'Alarm' (unselected) and 'Event' (selected). Below the radio buttons, the text 'RMON Event List Total: 4' is displayed. A table lists the configured events:

<input type="checkbox"/>	Index	Status	Type	Community	Description	Owner	Last Fired
<input type="checkbox"/>	1	Valid	None		None	None	00:00:00
<input type="checkbox"/>	2	Valid	Log		Log	Log	00:00:00
<input type="checkbox"/>	3	Valid	Trap	Trap	Trap	Trap	00:00:00
<input type="checkbox"/>	4	Valid	Log and Trap	Log and Trap	Log and Trap	Log and Trap	00:00:00

At the bottom right, there are 'Delete' and 'Revert' buttons.

Configuring RMON History Samples

Use the Administration > RMON (Configure Interface - Add - History) page to collect statistics on a physical interface to monitor network utilization, packet types, and errors. A historical record of activity can be used to track down intermittent problems. The record can be used to establish normal baseline activity, which may reveal problems associated with high traffic levels, broadcast storms, or other unusual events. It can also be used to predict network growth and plan for expansion before your network becomes too overloaded.

Command Usage

- ◆ Each index number equates to a port on the switch.
- ◆ If history collection is already enabled on an interface, the entry must be deleted before any changes can be made.
- ◆ The information collected for each sample includes:
input octets, packets, broadcast packets, multicast packets, undersize packets, oversize packets, fragments, jabbers, CRC alignment errors, collisions, drop events, and network utilization.

For a description of the statistics displayed on the Show Details page.

- ◆ The switch reserves two index entries for each port. If a default index entry is re-assigned to another port using the Add page, this index will not appear in the Show nor Show Details page for the port to which is normally assigned. For example, if control entry 15 is assigned to port 5, this index entry will be removed from the Show and Show Details page for port 8.

Parameters

These parameters are displayed:

- ◆ **Port** – The port number on the switch.
- ◆ **Index** - Index to this entry. (Range: 1-65535)
- ◆ **Interval** - The polling interval. (Range: 1-3600 seconds; Default: 1800 seconds)
- ◆ **Buckets** - The number of buckets requested for this entry. (Range: 1-65535; Default: 50)

The number of buckets granted are displayed on the Show page.

- ◆ **Owner** - Name of the person who created this entry. (Range: 1-32 characters)

Web Interface

To periodically sample statistics on a port:

1. Click **Administration > RMON**.
2. Select Configure Interface from the Step list.
3. Select Add from the Action list.
4. Click **History**.
5. Select a port from the list as the data source.
6. Enter an index number, the sampling interval, the number of buckets to use, and the name of the owner for this entry.
7. Click **Apply**.

The screenshot shows the 'Administration > RMON' web interface. At the top, there is a breadcrumb 'Administration > RMON'. Below it, there are two dropdown menus: 'Step: 2. Configure Interface' and 'Action: Add'. There are two radio buttons: 'History' (selected) and 'Statistics'. Below the radio buttons, there is a 'Port' dropdown menu with '2' selected. There are four input fields: 'Index (1-65535)' with '100', 'Interval (1-3600)' with '60' and 'sec' to its right, 'Buckets (1-65535)' with '10', and 'Owner' with 'david'. At the bottom right, there are two buttons: 'Apply' and 'Revert'.

To show configured RMON history samples:

1. Click **Administration > RMON**.
2. Select Configure Interface from the Step list.
3. Select Show from the Action list.
4. Select a port from the list.
5. Click **History**.

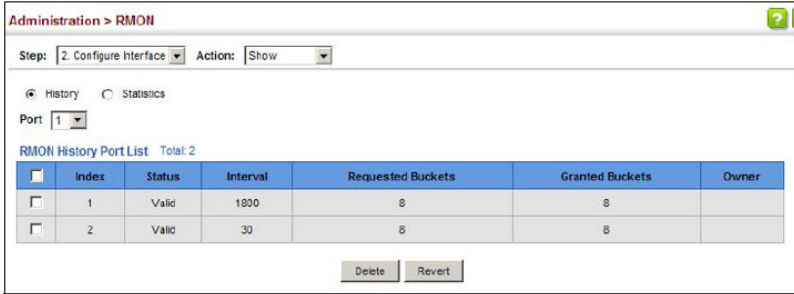

To show collected RMON history samples:

1. Click **Administration > RMON**.
2. Select Configure Interface from the Step list.
3. Select Show Details from the Action list.
4. Select a port from the list.
5. Click **History**.

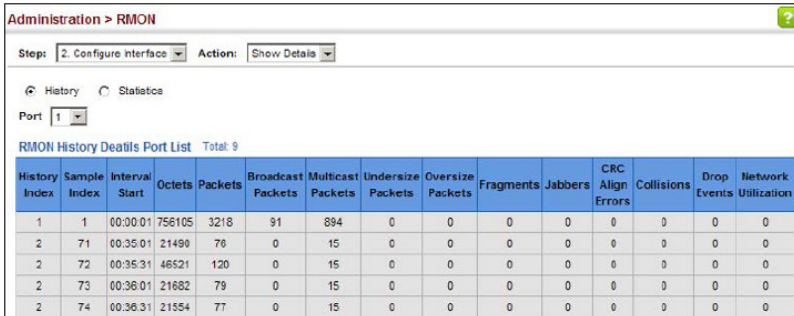

Configuring RMON Statistical Samples

Use the Administration > RMON (Configure Interface - Add - Statistics) page to collect statistics on a port, which can subsequently be used to monitor the network for common errors and overall traffic rates.

Command Usage

- ◆ If statistics collection is already enabled on an interface, the entry must be deleted before any changes can be made.
- ◆ The information collected for each entry includes:

input octets, packets, broadcast packets, multicast packets, undersize packets, oversize packets, CRC alignment errors, jabbers, fragments, collisions, drop events, and frames of various sizes.

Parameters

These parameters are displayed:

- ◆ **Port** – The port number on the switch.
- ◆ **Index** - Index to this entry. (Range: 1-65535)
- ◆ **Owner** - Name of the person who created this entry. (Range: 1-32 characters)

Web Interface

To enable regular sampling of statistics on a port:

1. Click **Administration > RMON**.
2. Select Configure Interface from the Step list.
3. Select Add from the Action list.
4. Click **Statistics**.
5. Select a port from the list as the data source.
6. Enter an index number, and the name of the owner for this entry.
7. Click **Apply**.

To show configured RMON statistical samples:

1. Click **Administration > RMON**.
2. Select Configure Interface from the Step list.
3. Select Show from the Action list.
4. Select a port from the list.

5. Click **Statistics**.

Administration > RMON

Step: 2. Configure interface Action: Show

History Statistics

Port: 2

RMON Statistics Port List Total: 2

<input type="checkbox"/>	Index	Status	Owner
<input type="checkbox"/>	1	Valid	abc
<input type="checkbox"/>	2	Valid	test

Delete Revert

To show collected RMON statistical samples:

1. Click **Administration > RMON**.
2. Select Configure Interface from the Step list.
3. Select Show Details from the Action list.
4. Select a port from the list.
5. Click **Statistics**.

Administration > RMON

Step: 2. Configure interface Action: Show Details

History Statistics

Port: 2

RMON Statistics Port Details

Received Octets	9613105	Collisions	0
Received Packets	24621	Drop Events	0
Broadcast Packets	608	Frames of 64 Octets	13595
Multicast Packets	5538	Frames of 65 to 127 Octets	2606
Undersize Packets	0	Frames of 128 to 255 Octets	1222
Oversize Packets	0	Frames of 256 to 511 Octets	56
CRC Align Errors	0	Frames of 512 to 1023 Octets	2028
Jabbers	0	Frames of 1024 to 1518 Octets	5114
Fragments	0		

Refresh

Switch Clustering

Switch clustering is a method of grouping switches together to enable centralized management through a single unit. Switches that support clustering can be grouped together regardless of physical location or switch type, as long as they are connected to the same local network.

Command Usage

- ◆ A switch cluster has a primary unit called the “Commander” which is used to manage all other “Member” switches in the cluster. The management station can use either Telnet or the web interface to communicate directly with the Commander through its IP address, and then use the Commander to manage Member switches through the cluster’s “internal” IP addresses.
- ◆ Clustered switches must be in the same Ethernet broadcast domain. In other words, clustering only functions for switches which can pass information between the Commander and potential Candidates or active Members through VLAN 4093.
- ◆ Once a switch has been configured to be a cluster Commander, it automatically discovers other cluster-enabled switches in the network. These “Candidate” switches only become cluster Members when manually selected by the administrator through the management station.
- ◆ There can be up to 100 candidates and 36 member switches in one cluster.
- ◆ A switch can only be a member of one cluster.
- ◆ The cluster VLAN 4093 is not configured by default. Before using clustering, take the following actions to set up this VLAN:
 1. Create VLAN 4093.
 2. Add the participating ports to this VLAN, and set them to hybrid mode, tagged members, PVID = 1, and acceptable frame type = all.
- ◆ After the Commander and Members have been configured, any switch in the cluster can be managed from the web agent by choosing the desired Member ID from the Show Member page.

Configuring General Settings for Clusters

Use the Administration > Cluster (Configure Global) page to create a switch cluster.

Command Usage

First be sure that clustering is enabled on the switch (the default is disabled), then set the switch as a Cluster Commander. Set a Cluster IP Pool that does not conflict with the network IP subnet. Cluster IP addresses are assigned to switches when they become Members and are used for communication between Member switches and the Commander.

Parameters

These parameters are displayed:

- ◆ **Cluster Status** – Enables or disables clustering on the switch. (Default: Disabled)
- ◆ **Commander Status** – Enables or disables the switch as a cluster Commander. (Default: Disabled)
- ◆ **IP Pool** – An “internal” IP address pool that is used to assign IP addresses to Member switches in the cluster. Internal cluster IP addresses are in the form 10.x.x.member-ID. Only the base IP address of the pool needs to be set since Member IDs can only be between 1 and 36. Note that you cannot change the cluster IP pool when the switch is currently in Commander mode. Commander mode must first be disabled. (Default: 10.254.254.1)
- ◆ **Role** – Indicates the current role of the switch in the cluster; either Commander, Member, or Candidate. (Default: Candidate)
- ◆ **Number of Members** – The current number of Member switches in the cluster.
- ◆ **Number of Candidates** – The current number of Candidate switches discovered in the network that are available to become Members.

Web Interface

To configure a switch cluster:

1. Click **Administration > Cluster**.
2. Select Configure Global from the Step list.
3. Set the required attributes for a Commander or a managed candidate.
4. Click **Apply**.

Administration > Cluster

Step: 1. Configure Global

Cluster Status	<input checked="" type="checkbox"/> Enabled
Commander Status	<input checked="" type="checkbox"/> Enabled
IP Pool	<input type="text" value="10.254.254.1"/>
Role	Commander
Number of Members	2
Number of Candidates	3

Cluster Member Configuration

Use the Administration > Cluster (Configure Member - Add) page to add Candidate switches to the cluster as Members.

Parameters

These parameters are displayed:

- ◆ **Member ID** – Specify a Member ID number for the selected Candidate switch. (Range: 1-36)
- ◆ **MAC Address** – Select a discovered switch MAC address from the Candidate Table, or enter a specific MAC address of a known switch.

Web Interface

To configure cluster members:

1. Click **Administration > Cluster**.
2. Select Configure Member from the Step list.
3. Select Add from the Action list.
4. Select one of the cluster candidates discovered by this switch, or enter the MAC address of a candidate.
5. Click **Apply**.

Administration > Cluster

Step: 2. Configure Member Action: Add

Member ID (1-36)	<input type="text"/>
MAC Address	<input checked="" type="radio"/> Candidate <input type="text" value="11-22-33-44-55-11"/> <input type="radio"/> <input type="text"/>

To show the cluster members:

1. Click **Administration > Cluster**.
2. Select Configure Member from the Step list.
3. Select Show from the Action list.

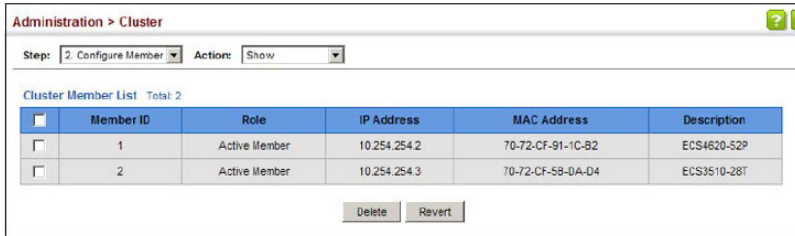

Administration > Cluster

Step: 2. Configure Member Action: Show

Cluster Member List Total: 2

<input type="checkbox"/>	Member ID	Role	IP Address	MAC Address	Description
<input type="checkbox"/>	1	Active Member	10.254.254.2	70-72-CF-91-1C-B2	ECS4620-52P
<input type="checkbox"/>	2	Active Member	10.254.254.3	70-72-CF-5B-DA-D4	ECS3510-28T

Delete Revert

To show cluster candidates:

1. Click **Administration > Cluster**.
2. Select Configure Member from the Step list.
3. Select Show Candidate from the Action list.

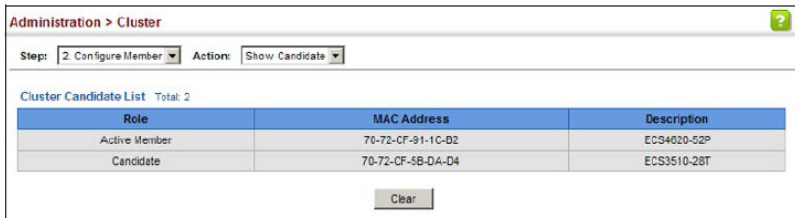

Administration > Cluster

Step: 2. Configure Member Action: Show Candidate

Cluster Candidate List Total: 2

Role	MAC Address	Description
Active Member	70-72-CF-91-1C-B2	ECS4620-52P
Candidate	70-72-CF-5B-DA-D4	ECS3510-28T

Clear

Managing Cluster Members

Use the Administration > Cluster (Show Member) page to manage another switch in the cluster.

Parameters

These parameters are displayed:

- ◆ **Member ID** – The ID number of the Member switch. (Range: 1-36)
- ◆ **Role** – Indicates the current status of the switch in the cluster.
- ◆ **IP Address** – The internal cluster IP address assigned to the Member switch.
- ◆ **MAC Address** – The MAC address of the Member switch.
- ◆ **Description** – The system description string of the Member switch.

- ◆ **Operate** – Remotely manage a cluster member.

Web Interface

To manage a cluster member:

1. Click **Administration > Cluster**.
2. Select Show Member from the Step list.
3. Select an entry from the Cluster Member List.
4. Click **Operate**.

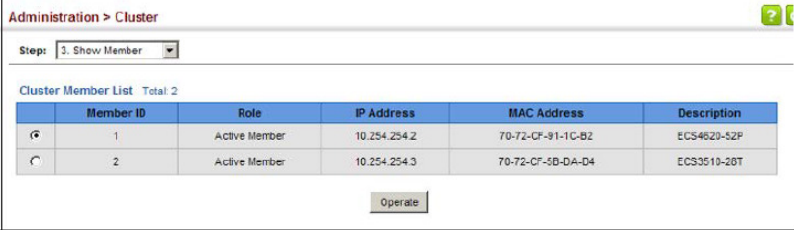

The screenshot displays the web interface for managing cluster members. At the top, the breadcrumb navigation shows "Administration > Cluster". Below this, a "Step:" dropdown menu is set to "3. Show Member". The main content area is titled "Cluster Member List Total: 2" and contains a table with the following data:

	Member ID	Role	IP Address	MAC Address	Description
☐	1	Active Member	10.254.254.2	70-72-CF-91-1C-B2	ECS4629-52P
☐	2	Active Member	10.254.254.3	70-72-CF-50-DA-D4	ECS3519-26T

Below the table, there is an "Operate" button.

Time Range

Use the Administration > Time Range page to set a time range during which various functions are applied, including applied ACLs or PoE.

Command Usage

- ◆ If both an absolute rule and one or more periodic rules are configured for the same time range (i.e., named entry), that entry will only take effect if the current time is within the absolute time range and one of the periodic time ranges.
- ◆ A maximum of eight rules can be configured for a time range.

Parameters

These parameters are displayed:

Add

- ◆ **Time-Range Name** – Name of a time range. (Range: 1-32 characters)

Add Rule

- ◆ **Time-Range** – Name of a time range.
- ◆ **Mode**
 - ◆ **Absolute** – Specifies a specific time or time range.
 - ◆ **Start/End** – Specifies the hours, minutes, month, day, and year at which to start or end.
 - ◆ **Periodic** – Specifies a periodic interval.
 - ◆ **Start/To** – Specifies the days of the week, hours, and minutes at which to start or end.

Web Interface

To configure a time range:

1. Click **Administration > Time Range**.
2. Select Add from the Action list.
3. Enter the name of a time range.
4. Click **Apply**.

Administration > Time Range

Action: Add ▾

Time-Range Name

Apply Revert

To show a list of time ranges:

1. Click **Administration > Time Range**.
2. Select Show from the Action list.

The screenshot shows the 'Administration > Time Range' interface. At the top, the 'Action' dropdown is set to 'Show'. Below this, a table titled 'Time-Range List' shows a total of 1 item. The table has a header row with a checkbox, a 'Time-Range Name' column, and a data row with a checkbox and the name 'r&d'. Below the table are 'Delete' and 'Revert' buttons.

	Time-Range Name
<input type="checkbox"/>	r&d

To configure a rule for a time range:

1. Click **Administration > Time Range**.
2. Select Add Rule from the Action list.
3. Select the name of time range from the drop-down list.
4. Select a mode option of Absolute or Periodic.
5. Fill in the required parameters for the selected mode.
6. Click **Apply**.

The screenshot shows the 'Administration > Time Range' configuration form. The 'Action' dropdown is set to 'Add Rule'. The 'Time-Range' dropdown is set to 'r&d' and the 'Mode' dropdown is set to 'Periodic'. The 'Start' section includes 'Days of the week' (vWeekend), 'Hours (0-23)' (5), and 'Minutes (0-59)' (0). The 'To' section includes 'Days of the week' (Sunday), 'Hours (0-23)' (6), and 'Minutes (0-59)' (0). 'Apply' and 'Revert' buttons are at the bottom.

To show the rules configured for a time range:

1. Click **Administration > Time Range**.
2. Select Show Rule from the Action list.

The screenshot shows the 'Administration > Time Range' interface with the 'Action' dropdown set to 'Show Rule'. Below, a table titled 'Time-Range Rule List' shows a total of 1 rule. The table has columns for a checkbox, 'Mode', 'Start', and 'End'. The data row shows a checkbox, 'Periodic', 'Weekend 05:00', and 'Weekend 06:00'. 'Delete' and 'Revert' buttons are at the bottom.

	Mode	Start	End
<input type="checkbox"/>	Periodic	Weekend 05:00	Weekend 06:00

Ethernet Ring Protection Switching (ERPS)

Note: Information in this section is based on ITU-T G.8032/Y.1344.

The ITU G.8032 recommendation specifies a protection switching mechanism and protocol for Ethernet layer network rings. Ethernet rings can provide wide-area multipoint connectivity more economically due to their reduced number of links. The mechanisms and protocol defined in G.8032 achieve highly reliable and stable protection; and never form loops, which would fatally affect network operation and service availability.

The G.8032 recommendation, also referred to as Ethernet Ring Protection Switching (ERPS), can be used to increase the availability and robustness of Ethernet rings. An Ethernet ring built using ERPS can provide resilience at a lower cost and than that provided by SONET or EAPS rings.

ERPS is more economical than EAPS in that only one physical link is required between each node in the ring. However, since it can tolerate only one break in the ring, it is not as robust as EAPS. ERPS supports up to 255 nodes in the ring structure. ERPS requires a higher convergence time when more than 16 nodes are used, but should always run under 500 ms.

Operational Concept

Loop avoidance in the ring is achieved by guaranteeing that, at any time, traffic may flow on all but one of the ring links. This particular link is called the ring protection link (RPL), and under normal conditions this link is blocked to traffic. One designated node, the RPL owner, is responsible for blocking traffic over the RPL. When a ring failure occurs, the RPL owner is responsible for unblocking the RPL, allowing this link to be used for traffic.

Ring nodes may be in one of two states:

Idle – normal operation, no link/node faults detected in ring

Protection – Protection switching in effect after identifying a signal fault

In Idle state, the physical topology has all nodes connected in a ring. The logical topology guarantees that all nodes are connected without a loop by blocking the RPL.

A link/node failure is detected by the nodes adjacent to the failure. These nodes block the failed link and report the failure to the ring using R-APS (SF) messages. This message triggers the RPL owner to unblock the RPL, and all nodes to flush their forwarding database. The ring is now in protection state, but it remains connected in a logical topology.

rings ERP1 and ERP2. On their own ERP2 ring links do not form a closed loop. A closed loop may be formed by the ring links of ERP2 and the ring link between the interconnection nodes that is controlled by ERP1. ERP2 is a sub-ring. Ring node A is the RPL owner node for ERP1, and ring node E is the RPL owner node for ERP2. These ring nodes (A and E) are responsible for blocking the traffic channel on the RPL for ERP1 and ERP2 respectively. There is no restriction on which ring link on a ring may be set as the RPL. For example the RPL of ERP1 could be set as the link between ring node C and D.

Ring nodes C and D, that are common to both ERP1 and ERP2, are called interconnection nodes. The ring link between the interconnection nodes are controlled and protected by the ring it belongs to. In the example for the Normal Condition, the ring link between ring nodes C and D is part of ERP1, and, as such, are controlled and protected by ERP1. Ethernet characteristic information traffic corresponding to the traffic channel may be transferred over a common Ethernet connection for ERP1 and ERP2 through the interconnection nodes C and D. Interconnection nodes C and D have separate ERP Control Processes for each Ethernet Ring.

(Signal Fail Condition) illustrates a situation where protection switching has occurred due to an SF condition on the ring link between interconnection nodes C and D. The failure of this ring link triggers protection only on the ring to which it belongs, in this case ERP1. The traffic and R-APS channels are blocked bi-directionally on the ports where the failure is detected and bi-directionally unblocked at the RPL connection point on ERP1. The traffic channels remain bi-directionally blocked at the RPL connection point on ERP2. This prevents the formation of a loop.

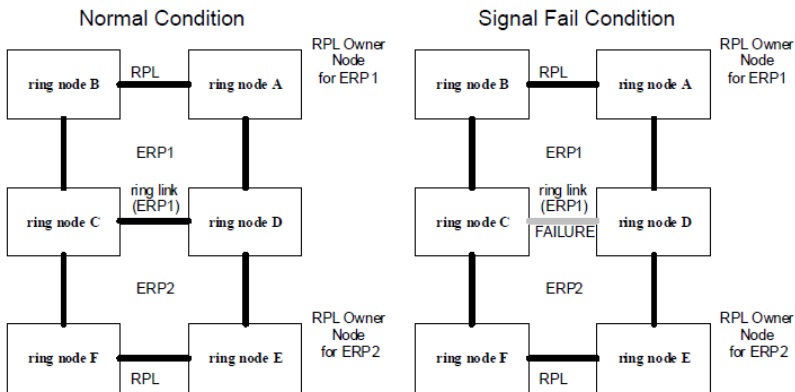

Configuration Guidelines for ERPS

1. Create an ERPS ring (Configure Ring – Add): The ring name is used as an index in the G.8032 database. Specify the east and west interfaces. Each node on the ring connects to it through two ring ports. Configure one port connected to the next node in the ring to the east (or clockwise direction) and another port facing west in the ring.
2. Configure VLAN groups to assign to specific ERPS instances (Configure VLAN Group – Add).
3. Create ERPS instances (Configure Instance – Add): Specify an instance name and optionally an ID number.
4. Configure the RPL owner (Configure Instance – Configure Details): Configure one node in the ring as the Ring Protection Link (RPL) owner. When this switch is configured as the RPL owner, the west ring port is set as being connected to the RPL. Under normal operations (Idle state), the RPL is blocked to ensure that a loop cannot form in the ring. If a signal failure brings down any other link in the ring, the RPL will be unblocked (Protection state) to ensure proper connectivity among all ring nodes until the failure is recovered.
5. Configure ERPS timers (Configure Instance – Configure Details): Set the Guard timer to prevent ring nodes from receiving outdated R-APS messages, the Hold-off timer to filter out intermittent link faults, and the WTR timer to verify that the ring has stabilized before blocking the RPL after recovery from a signal failure.
6. Configure the ERPS Control VLAN (Configure Instance – Configure Details): Specify the Control VLAN (CVLAN) used to pass R-APS ring maintenance commands. The CVLAN must NOT be configured with an IP address. In addition, only ring ports may be added to the CVLAN (prior to configuring the VLAN as a CVLAN). No other ports can be members of this VLAN (once set as a CVLAN). Also, the ring ports of the CVLAN must be tagged. Failure to observe these restrictions can result in a loop in the network.
7. Select the Inclusion VLAN groups (Configure Instance – Configure Details): Select the ERPS VLAN groups to assign to the instances.
8. Enable ERPS (Configure Global): Before enabling a ring and instance as described in the next steps, first globally enable ERPS on the switch. If ERPS has not yet been enabled or has been disabled, no ERPS rings will work.
9. Enable an ERPS ring (Configure Ring – Add/Modify): Before an ERPS instance can work, the physical ring must be enabled.

10. Enable an ERPS instance (Configure Instance – Configure Details):
Before an ERPS instance can work, it must be enabled. When configuration is completed and the instance enabled, R-APS messages will start flowing in the control VLAN, and normal traffic will begin to flow in the data VLANs. A ring can be stopped by disabling the Status on any node.
11. Display ERPS status information (Configure Instance – Show): Display ERPS status information for all configured rings.

Configuration Limitations for ERPS

The following configuration limitations apply to ERPS:

- ◆ Ring ports cannot be a member of a trunk, nor an LACP-enabled port.
- ◆ Dynamic VLANs are not supported as protected data ports.
- ◆ Exclusive use of **STP** or **ERPS** on any port.
- ◆ One VLAN must be added to an ERPS instance as the CVLAN. This can be designated as any VLAN, other than the management VLAN. The CVLAN should only contain ring ports, and must not be configured with an IP address.

ERPS Global Configuration

Use the Administration > ERPS (Configure Global) page to globally enable or disable ERPS on the switch.

Parameters

These parameters are displayed:

- ◆ **ERPS Status** – Enables ERPS on the switch. (Default: Disabled)
ERPS must be enabled globally on the switch before it can be enabled on an ERPS instance (by setting the Status on the Configure Instance – Configure Details page).
- ◆ **ERPS Node ID** – A MAC address unique to the ring node. The MAC address must be specified in the format xx-xx-xx-xx-xx-xx or xxxxxxxxxxxx. (Default: CPU MAC address)

The ring node identifier is used to identify a node in R-APS messages for both automatic and manual switching recovery operations.

For example, a node that has one ring port in SF condition and detects that the condition has been cleared, will continuously transmit R-APS (NR) messages with its own Node ID as priority information over both ring ports, informing its neighbors that no request is present at this node. When

another recovered node holding the link blocked receives this message, it compares the Node ID information with its own. If the received R-APS (NR) message has a higher priority, this unblocks its ring ports. Otherwise, the block remains unchanged.

The node identifier may also be used for debugging, such as to distinguish messages when a node is connected to more than one ring.

Web Interface

To globally enable ERPS on the switch:

1. Click **Administration > ERPS**.
2. Select Configure Global from the Step list.
3. Mark the ERPS Status check box.
4. Set the ERPS Node ID or leave it as the CPU MAC address.
5. Click **Apply**.

ERPS VLAN Group Configuration

Use the Administration > ERPS (Configure VLAN Group) pages to configure ERPS VLAN groups.

Command Usage

- ◆ A set of VLANs in an Ethernet ring can be grouped into several subsets and applied to an ERPS instance.
- ◆ A VLAN group configuration is allowed to be deleted only if all associations are removed.

Parameters

These parameters are displayed:

- ◆ **VLAN Group Name** – Name of the VLAN group. (Range: 1-12 characters).

- ♦ **VLAN List** – A single VLAN ID, a list of VLAN IDs separated by commas, or a range of VLANs defined by two VLAN IDs separated by a hyphen.

Web Interface

To configure ERPS VLAN groups on the switch:

1. Click **Administration > ERPS**.
2. Select Configure VLAN Group from the Step list.
3. Select Add from the Action list.
4. Define a VLAN Group name.
5. Configure VLANs to add to the group.
6. Click **Apply**.

The screenshot shows a web interface for configuring ERPS. The breadcrumb is 'Administration > ERPS'. Below it, there's a 'Step:' dropdown menu with '2. Configure VLAN Group' selected, and an 'Action:' dropdown menu with 'Add' selected. There are two input fields: 'VLAN Group Name' and 'VLAN List'. At the bottom right, there are two buttons: 'Apply' and 'Revert'.

ERPS Ring Configuration

Use the Administration > ERPS (Configure Ring) pages to configure a physical ERPS ring.

Command Usage

- ♦ The switch can support ERPS rings up to half the number of physical ports on the switch.
- ♦ Each node must be connected to two neighbors on the ring. For convenience, the ports connected are referred to as east and west ports. Alternatively, the closest neighbor to the east should be the next node in the ring in a clockwise direction, and the closest neighbor to the west should be the next node in the ring in a counter-clockwise direction.
- ♦ Note that a ring port cannot be configured as a member of a spanning tree, a dynamic trunk, or a static trunk.
- ♦ If a port channel (static trunk) is specified as a ring port, it can not be destroyed before it is removed from the ring configuration. A static trunk will be treated as a signal fault, if it contains no member ports or all of its

member ports are in signal fault. If a static trunk is configured as a ring port prior to assigning any member ports, spanning tree will be disabled for the first member port assigned to the static trunk.

- ◆ VLANs that are on the exclusion list are **not** protected by the ERPS ring. Any VLAN not listed on either the inclusion or exclusion list will be blocked on ring ports.
- ◆ Traffic from control VLANs, inclusion VLANs, and exclusion VLANs of an ERPS ring will be forwarded by non-ERPS ring ports.

Parameters

These parameters are displayed:

- ◆ **Ring Name** – Name of the VLAN group. (Range: 1-12 characters).
- ◆ **West** – The port that connects to the next ring node to the west.
- ◆ **East** – The port that connects to the next ring node to the east.
- ◆ **Exclusion VLANs** – VLAN groups that are to be on the exclusion list of a physical ERPS ring.
- ◆ **Status** – Enables ERPS on the configured ring. (Default: Disabled)
ERPS must be enabled globally on the switch before it can be enabled on an ERPS ring.

Web Interface

To configure a physical ERPS ring on the switch:

1. Click **Administration > ERPS**.
2. Select Configure Ring from the Step list.
3. Select Add from the Action list.
4. Define a ring name.
5. Select the West and East ports for ring connections.
6. Select any VLAN groups to exclude from the ERPS ring.
7. Mark the Status check box to enable the ERPS ring.
8. Click **Apply**.

Administration > ERPS

Step: 3. Configure Ring Action: Add

Ring Name

West

East

Exclusion VLANs Total: 1

<input type="checkbox"/>	VLAN Group
<input type="checkbox"/>	test-group

Status Enabled

Apply Revert

ERPS Instance Configuration

Use the Administration > ERPS (Configure Instance) pages to configure an ERPS instance.

Command Usage

An ERPS instance containing one Control VLAN and one or more protected Data VLANs must be configured, and the global ERPS function enabled on the switch before a ring instance can start running. Once enabled, the RPL owner node and non-owner node state machines will start, and the ring instance will enter the active state.

Parameters

These parameters are displayed:

Add

- ◆ **Instance Name** – Name of an ERPS ring. (Range: 1-12 characters)
- ◆ **ID** – ERPS instance identifier used in R-APS messages. (Range: 1-255)

Show

- ◆ **Name** – Name of a configured ERPS instance.
- ◆ **ID** – ERPS ring identifier used in R-APS messages.
- ◆ **Status** – Shows whether ERPS is enabled on the switch.
- ◆ **Physical Ring** – Shows the ERPS ring name.
- ◆ **Control VLAN** – Shows the Control VLAN ID.
- ◆ **Node State** – Shows the following ERPS states:
 - ◆ **Init** – The ERPS ring has started but has not yet determined the status of the ring.

- ♦ **Idle** – If all nodes in a ring are in this state, it means that all the links in the ring are up. This state will switch to protection state if a link failure occurs.
- ♦ **Protection** – If a node in this state, it means that a link failure has occurred. This state will switch to idle state if all the failed links recover.
- ♦ **Type** – Shows node type as None, RPL Owner or RPL Neighbor.
- ♦ **W/E** – Shows information on the west and east ring port for this node.
 - ♦ **West Port** – Shows the west ring port for this node.
 - ♦ **East Port** – Shows the east ring port for this node.
- ♦ **Interface** – The port or trunk which is configured as a ring port.
- ♦ **Port State** – The operational state:
 - ♦ **Blocking** – The transmission and reception of traffic is blocked and the forwarding of R-APS messages is blocked, but the transmission of locally generated R-APS messages is allowed and the reception of all R-APS messages is allowed.
 - ♦ **Forwarding** – The transmission and reception of traffic is allowed; transmission, reception and forwarding of R-APS messages is allowed.
 - ♦ **Down** – The interface is not linked up.
 - ♦ **Unknown** – The interface is not in a known state (includes the domain being disabled).
- ♦ **Local SF** – A signal fault generated on a link to the local node.
- ♦ **Local FS** – Shows if a forced switch command was issued on this interface.
- ♦ **Local MS** – Shows if a manual switch command was issued on this interface.
- ♦ **MEP** – The MEP used to monitor the status on this link.
- ♦ **RPL** – Shows if this node is connected to the RPL.
- ♦ **Inclusion VLAN Groups** – ERPS VLAN groups configured for this instance.

Configure Details

- ♦ **Instance Name** – Name of a configured ERPS instance. (Range: 1-12 characters)

Service Instances within each ring are based on a unique maintenance association for the specific users, distinguished by the ring name, maintenance level, maintenance association's name, and assigned VLAN. Up to 6 ERPS rings can be configured on the switch.

- ◆ **Instance ID** – ERPS ring identifier used in R-APS messages. (Range: 1-255; Default: None)

R-APS information is carried in an R-APS PDUs. The last octet of the MAC address is designated as the Ring ID (01-19-A7-00-00-[Ring ID]). If use of the default MAC address is disabled for the R-APS Def MAC parameter, then the Domain ID will be used in R-APS PDUs.

- ◆ **Control VLAN** – A dedicated VLAN used for sending and receiving E-APS protocol messages. (Range: 1-4094)

Configure one control VLAN for each ERPS ring. First create the VLAN to be used as the control VLAN, add the ring ports for the east and west interface as tagged members to this VLAN, and then use this parameter to add it to the ring.

The following restrictions are recommended to avoid creating a loop in the network or other problems which may occur under some situations:

- ◆ The Control VLAN must not be configured as a Layer 3 interface (with an IP address), a dynamic VLAN (with GVRP enabled), nor as a private VLAN.
- ◆ In addition, only ring ports may be added to the Control VLAN. No other ports can be members of this VLAN.
- ◆ Also, the ring ports of the Control VLAN must be tagged.

Once the ring has been activated, the configuration of the control VLAN cannot be modified. Use the Admin Status parameter to stop the ERPS ring before making any configuration changes to the control VLAN.

- ◆ **Node State** – Refer to the parameters for the Show page.
- ◆ **Node Type** – Shows ERPS node type as one of the following:
 - ◆ **None** – Node is neither Ring Protection Link (RPL) owner nor neighbor. (This is the default setting.)
 - ◆ **RPL Owner** – Specifies a ring node to be the RPL owner.
 - ◆ Only one RPL owner can be configured on a ring. The owner blocks traffic on the RPL during Idle state, and unblocks it during Protection state (that is, when a signal fault is detected on the ring or the protection state is enabled with the Forced Switch or Manual Switch commands on the Configure Operation page).
 - ◆ The east and west connections to the ring must be specified for all ring nodes. When this switch is configured as the RPL owner, the west ring port is automatically set as being connected to the RPL.
 - ◆ **RPL Neighbor** – Specifies a ring node to be the RPL neighbor.

- ◆ The RPL neighbor node, when configured, is a ring node adjacent to the RPL that is responsible for blocking its end of the RPL under normal conditions (i.e., the ring is established and no requests are present in the ring) in addition to the block at the other end by the RPL Owner Node. The RPL neighbor node may participate in blocking or unblocking its end of the RPL, but is not responsible for activating the reversion behavior.
 - ◆ Only one RPL owner can be configured on a ring. If the switch is set as the RPL owner for an ERPS domain, the west ring port is set as one end of the RPL. If the switch is set as the RPL neighbor for an ERPS domain, the east ring port is set as the other end of the RPL.
 - ◆ The east and west connections to the ring must be specified for all ring nodes. When this switch is configured as the RPL neighbor, the east ring port is set as being connected to the RPL.
 - ◆ Note that is not mandatory to declare a RPL neighbor.
- ◆ **Major Ring** – The ERPS instance used for sending control packets.

This switch can support multiple instances. However, ERPS control packets can only be sent on one instance. This parameter is used to indicate that the current ring instance is a secondary ring, and to specify the major ring instance that will be used to send ERPS control packets.

The Ring Protection Link (RPL) is always the west port. So the physical port on a secondary ring must be the west port. In other words, if a ring has two physical ports, this ring can only be a major ring, not a secondary ring (or sub-ring) which can have only one physical ring port. The major ring therefore cannot be set if the east port is already configured.

- ◆ **Version** – Specifies compatibility with the following ERPS versions:
- ◆ 1 - ERPS version 1 based on ITU-T G.8032/Y.1344.
 - ◆ 2 - ERPS version 2 based on ITU-T G.8032/Y.1344 Version 2. (This is the default setting.)

In addition to the basic features provided by version 1, version 2 also supports:

- ◆ Multi-ring/ladder network support
- ◆ Revertive/Non-revertive recovery
- ◆ Forced Switch (FS) and Manual Switch (MS) commands for manually blocking a particular ring port
- ◆ Flush FDB (forwarding database) logic which reduces amount of flush FDB operations in the ring
- ◆ Support of multiple ERP instances on a single ring

Version 2 is backward compatible with Version 1. If version 2 is specified, the inputs and commands are forwarded transparently. If set to version 1, MS and FS operator commands are filtered, and the switch set to revertive mode.

The version number is automatically set to “1” when a ring node, supporting only the functionalities of G.8032v1, exists on the same ring with other nodes that support G.8032v2.

When ring nodes running G.8032v1 and G.8032v2 co-exist on a ring, the ring ID of each node is configured as “1”.

In version 1, the MAC address 01-19-A7-00-00-01 is used for the node identifier. The R-APS Def MAC parameter has no effect.

- ◆ **MEG Level** – The maintenance entity group (MEG) level which provides a communication channel for ring automatic protection switching (R-APS) information. (Range: 0-7)

This parameter is used to ensure that received R-APS PDUs are directed for this ring. A unique level should be configured for each local ring if there are many R-APS PDUs passing through this switch.

- ◆ **Revertive** – Sets the method of recovery to Idle State through revertive or non-revertive mode. (Default: Enabled)
 - ◆ Revertive behavior allows the switch to automatically return the RPL from Protection state to Idle state through the exchange of protocol messages.

Non-revertive behavior for Protection, Forced Switch (FS), and Manual Switch (MS) states are basically the same. Non-revertive behavior requires the RPL to be restored from Protection state to Idle state using the Clear command (Configure Operation page).

- ◆ **Recovery for Protection Switching** – A ring node that has one or more ring ports in an SF (Signal Fail) condition, upon detecting the SF condition cleared, keeps at least one of its ring ports blocked for the traffic channel and for the R-APS channel, until the RPL is blocked as a result of ring protection reversion, or until there is another higher priority request (e.g., an SF condition) in the ring.

A ring node that has one ring port in an SF condition and detects the SF condition cleared, continuously transmits the R-APS (NR – no request) message with its own Node ID as the priority information over both ring ports, informing that no request is present at this ring node and initiates a guard timer. When another recovered ring node (or nodes) holding the link block receives this message, it compares the Node ID information with its own Node ID. If the received R-APS (NR)

message has the higher priority, this ring node unblocks its ring ports. Otherwise, the block remains unchanged. As a result, there is only one link with one end blocked.

The ring nodes stop transmitting R-APS (NR) messages when they accept an R-APS (NR, RB – RPL Blocked), or when another higher priority request is received.

- ◆ Recovery with Revertive Mode – When all ring links and ring nodes have recovered and no external requests are active, reversion is handled in the following way:
 - a. The reception of an R-APS (NR) message causes the RPL Owner Node to start the WTR (Wait-to-Restore) timer.
 - b. The WTR timer is cancelled if during the WTR period a higher priority request than NR is accepted by the RPL Owner Node or is declared locally at the RPL Owner Node.
 - c. When the WTR timer expires, without the presence of any other higher priority request, the RPL Owner Node initiates reversion by blocking its traffic channel over the RPL, transmitting an R-APS (NR, RB) message over both ring ports, informing the ring that the RPL is blocked, and performing a flush FDB action.
 - d. The acceptance of the R-APS (NR, RB) message causes all ring nodes to unblock any blocked non-RPL link that does not have an SF condition. If it is an R-APS (NR, RB) message without a DNF (do not flush) indication, all ring nodes flush the FDB.
- ◆ Recovery with Non-revertive Mode – In non-revertive operation, the ring does not automatically revert when all ring links and ring nodes have recovered and no external requests are active. Non-revertive operation is handled in the following way:
 - a. The RPL Owner Node does not generate a response on reception of an R-APS (NR) messages.
 - b. When other healthy ring nodes receive the NR (Node ID) message, no action is taken in response to the message.
 - c. When the operator issues the Clear command (Configure Operation page) for non-revertive mode at the RPL Owner Node, the non-revertive operation is cleared, the RPL Owner Node blocks its RPL port, and transmits an R-APS (NR, RB) message in both directions, repeatedly.

d. Upon receiving an R-APS (NR, RB) message, any blocking node should unblock its non-failed ring port. If it is an R-APS (NR, RB) message without a DNF indication, all ring nodes flush the FDB.

- ◆ Recovery for Forced Switching – A Forced Switch command is removed by issuing the Clear command (Configure Operation page) to the same ring node where Forced Switch mode is in effect. The clear command removes any existing local operator commands, and triggers reversion if the ring is in revertive behavior mode.

The ring node where the Forced Switch was cleared continuously transmits the R-APS (NR) message on both ring ports, informing other nodes that no request is present at this ring node. The ring nodes stop transmitting R-APS (NR) messages when they accept an RAPS (NR, RB) message, or when another higher priority request is received.

If the ring node where the Forced Switch was cleared receives an R-APS (NR) message with a Node ID higher than its own Node ID, it unblocks any ring port which does not have an SF condition and stops transmitting R-APS (NR) message over both ring ports.

- ◆ Recovery with revertive mode is handled as follows:
 - a. The reception of an R-APS (NR) message causes the RPL Owner Node to start the WTB timer.
 - b. The WTB timer is canceled if during the WTB period a higher priority request than NR is accepted by the RPL Owner Node or is declared locally at the RPL Owner Node.
 - c. When the WTB timer expires, in the absence of any other higher priority request, the RPL Owner Node initiates reversion by blocking the traffic channel over the RPL, transmitting an R-APS (NR, RB) message over both ring ports, informing the ring that the RPL is blocked, and flushes the FDB.
 - d. The acceptance of the R-APS (NR, RB) message causes all ring nodes to unblock any blocked non-RPL that does not have an SF condition. If it is an R-APS (NR, RB) message without a DNF indication, all ring nodes flush their FDB. This action unblocks the ring port which was blocked as a result of an operator command.
- ◆ Recovery with non-revertive mode is handled as follows:

- a. The RPL Owner Node, upon reception of an R-APS(NR) message and in the absence of any other higher priority request does not perform any action.
 - b. Then, after the operator issues the Clear command (Configure Operation page) at the RPL Owner Node, this ring node blocks the ring port attached to the RPL, transmits an R-APS (NR, RB) message on both ring ports, informing the ring that the RPL is blocked, and flushes its FDB.
 - c. The acceptance of the R-APS (NR, RB) message triggers all ring nodes to unblock any blocked non-RPL which does not have an SF condition. If it is an R-APS (NR, RB) message without a DNF indication, all ring nodes flush their FDB. This action unblocks the ring port which was blocked as result of an operator command.
- ◆ Recovery for Manual Switching – A Manual Switch command is removed by issuing the Clear command (Configure Operation page) at the same ring node where the Manual Switch is in effect. The clear command removes any existing local operator commands, and triggers reversion if the ring is in revertive behavior mode.

The ring node where the Manual Switch was cleared keeps the ring port blocked for the traffic channel and for the R-APS channel, due to the previous Manual Switch command. This ring port is kept blocked until the RPL is blocked as a result of ring protection reversion, or until there is another higher priority request (e.g., an SF condition) in the ring.

The Ethernet Ring Node where the Manual Switch was cleared continuously transmits the R-APS (NR) message on both ring ports, informing that no request is present at this ring node. The ring nodes stop transmitting R-APS (NR) messages when they accept an RAPS (NR, RB) message, or when another higher priority request is received.

If the ring node where the Manual Switch was cleared receives an R-APS (NR) message with a Node ID higher than its own Node ID, it unblocks any ring port which does not have an SF condition and stops transmitting R-APS (NR) message on both ring ports.

- ◆ Recovery with revertive mode is handled as follows:
- a. The RPL Owner Node, upon reception of an R-APS (NR) message and in the absence of any other higher priority request, starts the WTB timer and waits for it to expire. While the WTB timer is running, any latent R-APS (MS) message is ignored due to the higher priority of the WTB running signal.

b. When the WTB timer expires, it generates the WTB expire signal. The RPL Owner Node, upon reception of this signal, initiates reversion by blocking the traffic channel on the RPL, transmitting an R-APS (NR, RB) message over both ring ports, informing the ring that the RPL is blocked, and flushes its FDB.

c. The acceptance of the R-APS (NR, RB) message causes all ring nodes to unblock any blocked non-RPL that does not have an SF condition. If it is an R-APS (NR, RB) message without a DNF indication, all Ethernet Ring Nodes flush their FDB. This action unblocks the ring port which was blocked as a result of an operator command.

- ◆ Recovery with non-revertive mode is handled as follows:
 - a. The RPL Owner Node, upon reception of an R-APS (NR) message and in the absence of any other higher priority request does not perform any action.
 - b. Then, after the operator issues the Clear command (Configure Operation page) at the RPL Owner Node, this ring node blocks the ring port attached to the RPL, transmits an R-APS (NR, RB) message over both ring ports, informing the ring that the RPL is blocked, and flushes its FDB.
 - c. The acceptance of the R-APS (NR, RB) message triggers all ring nodes to unblock any blocked non-RPL which does not have an SF condition. If it is an R-APS (NR, RB) message without a DNF indication, all ring nodes flush their FDB. This action unblocks the ring port which was blocked as result of an operator command.
- ◆ **R-APS with VC** – Configures an R-APS virtual channel to connect two interconnection points on a sub-ring, allowing ERPS protocol traffic to be tunneled across an arbitrary Ethernet network. (Default: Enabled)
 - ◆ A sub-ring may be attached to a primary ring with or without a virtual channel. A virtual channel is used to connect two interconnection points on the sub-ring, tunneling R-APS control messages across an arbitrary Ethernet network topology. If a virtual channel is not used to cross the intermediate Ethernet network, data in the traffic channel will still flow across the network, but the all R-APS messages will be terminated at the interconnection points.
 - ◆ Sub-ring with R-APS Virtual Channel – When using a virtual channel to tunnel R-APS messages between interconnection points on a sub-ring, the R-APS virtual channel may or may not follow the same path

as the traffic channel over the network. R-APS messages that are forwarded over the sub-ring's virtual channel are broadcast or multicast over the interconnected network. For this reason the broadcast/multicast domain of the virtual channel should be limited to the necessary links and nodes. For example, the virtual channel could span only the interconnecting rings or sub-rings that are necessary for forwarding R-APS messages of this sub-ring. Care must also be taken to ensure that the local RAPS messages of the sub-ring being transported over the virtual channel into the interconnected network can be uniquely distinguished from those of other interconnected ring R-APS messages. This can be achieved by, for example, by using separate VIDs for the virtual channels of different sub-rings.

Note that the R-APS virtual channel requires a certain amount of bandwidth to forward R-APS messages on the interconnected Ethernet network where a sub-ring is attached. Also note that the protection switching time of the sub-ring may be affected if R-APS messages traverse a long distance over an R-APS virtual channel.

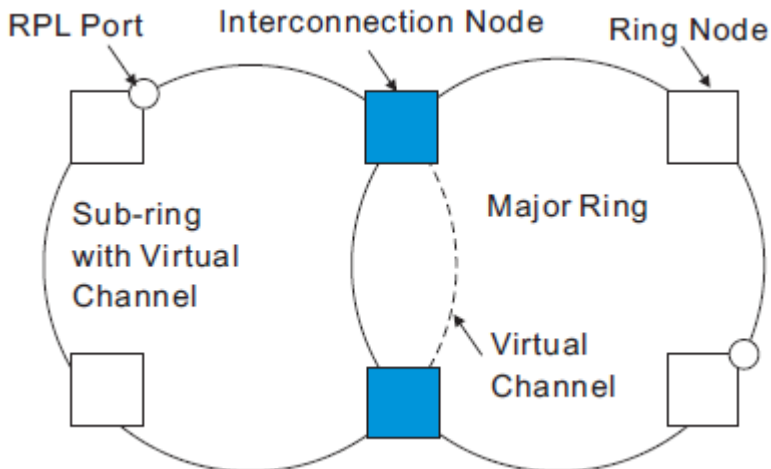

- ◆ Sub-ring without R-APS Virtual Channel – Under certain circumstances it may not be desirable to use a virtual channel to interconnect the sub-ring over an arbitrary Ethernet network. In this situation, the R-APS messages are terminated on the interconnection points. Since the sub-ring does not provide an R-APS channel nor R-APS virtual channel beyond the interconnection points, R-APS channel blocking is not employed on the normal ring links to avoid channel segmentation. As a result, a failure at any ring link in the sub-ring will cause the R-APS channel of the sub-ring to be segmented,

thus preventing R-APS message exchange between some of the sub-ring's ring nodes.

No R-APS messages are inserted or extracted by other rings or sub-rings at the interconnection nodes where a sub-ring is attached. Hence there is no need for either additional bandwidth or for different VIDs/ Ring IDs for the ring interconnection. Furthermore, protection switching time for a sub-ring is independent from the configuration or topology of the interconnected rings. In addition, this option always ensures that an interconnected network forms a tree topology regardless of its interconnection configuration. This means that it is not necessary to take precautions against forming a loop which is potentially composed of a whole interconnected network.

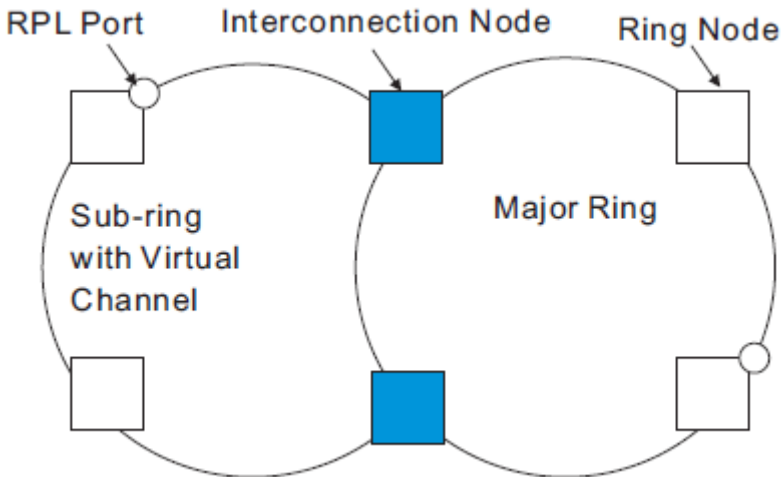

- ◆ **R-APS Def MAC** – Sets the switch's MAC address to be used as the node identifier in R-APS messages. (Default: Enabled)

When ring nodes running ERPSv1 and ERPSv2 co-exist on the same ring, the Ring ID of each ring node must be configured as "1".

If this command is disabled, the following strings are used as the node identifier:

- ◆ ERPSv1: 01-19-A7-00-00-01
- ◆ ERPSv2: 01-19-A7-00-00-[Ring ID]
- ◆ **Propagate TC** – Enables propagation of topology change messages from a secondary ring to the primary ring. (Default: Disabled)

When a secondary ring detects a topology change, it can pass a message about this event to the major ring. When the major ring receives this kind

of message from a secondary ring, it can clear the MAC addresses on its ring ports to help the secondary ring restore its connections more quickly through protection switching.

When the MAC addresses are cleared, data traffic may flood onto the major ring. The data traffic will become stable after the MAC addresses are learned again. The major ring will not be broken, but the bandwidth of data traffic on the major ring may suffer for a short period of time due to this flooding behavior.

- ♦ **Holdoff Timer** – The hold-off timer is used to filter out intermittent link faults. Faults will only be reported to the ring protection mechanism if this timer expires. (Range: 0-10000 milliseconds, in steps of 100 milliseconds)
In order to coordinate timing of protection switches at multiple layers, a hold-off timer may be required. Its purpose is to allow, for example, a server layer protection switch to have a chance to fix the problem before switching at a client layer.

When a new defect or more severe defect occurs (new Signal Failure), this event will not be reported immediately to the protection switching mechanism if the provisioned hold-off timer value is non-zero. Instead, the hold-off timer will be started. When the timer expires, whether a defect still exists or not, the timer will be checked. If one does exist, that defect will be reported to the protection switching mechanism. The reported defect need not be the same one that started the timer.

- ♦ **Guard Timer** – The guard timer is used to prevent ring nodes from receiving outdated R-APS messages. During the duration of the guard timer, all received R-APS messages are ignored by the ring protection control process, giving time for old messages still circulating on the ring to expire. (Range: 10-2000 milliseconds, in steps of 10 milliseconds)

The guard timer duration should be greater than the maximum expected forwarding delay for an R-APS message to pass around the ring. A side-effect of the guard timer is that during its duration, a node will be unaware of new or existing ring requests transmitted from other nodes.

- ♦ **WTB Timer** – The Wait to Block (WTB) timer is used when clearing Forced Switch (FS) and Manual Switch (MS) commands. As multiple FS commands are allowed to co-exist in a ring, the WTB timer ensures that clearing of a single FS command does not trigger re-blocking of the RPL. When clearing an MS command, the WTB timer prevents the formation of a closed loop due to possible a timing anomaly where the RPL owner node receives an outdated remote MS request during the recovery process.
When recovering from an FS or MS command, the delay timer must be long enough to receive any latent remote FS or MS commands. This delay

timer called the WTB timer is defined to be 5 seconds longer than the guard timer. This is enough time to allow a reporting ring node to transmit two R-APS messages and allow the ring to identify the latent condition.

This delay timer is activated on the RPL owner node. When the relevant delay timer expires, the RPL owner node initiates the reversion process by transmitting an R-APS (NR, RB) message. The delay timer, (i.e., WTR or WTB) is deactivated when any higher priority request preempts this delay timer.

The delay timers (i.e. WTR and WTB) may be started and stopped by the system. A request to start running the delay timer does not restart the delay timer. A request to stop the delay timer stops the delay timer and resets its value. The Clear command (Configure Operation page) can be used to stop the delay timer.

- ◆ **WTR Timer** – The wait-to-restore timer is used to verify that the ring has stabilized before blocking the RPL after recovery from a signal failure. (Range: 1-12 minutes)

If the switch goes into ring protection state due to a signal failure, after the failure condition is cleared, the RPL owner will start the wait-to-restore timer and wait until it expires to verify that the ring has stabilized before blocking the RPL and returning to the Idle (normal operating) state.

- ◆ **WTB Expire** – The time before the wait-to-block timer expires.
- ◆ **WTR Expire** – The time before the wait-to-restore timer expires.
- ◆ **Physical Ring** – Specifies the name of the physical ring on which the configured instance runs.
- ◆ **West/East** – Connects to next ring node to the west/east.

Each node must be connected to two neighbors on the ring. For convenience, the ports connected are referred to as east and west ports. Alternatively, the closest neighbor to the east should be the next node in the ring in a clockwise direction, and the closest neighbor to the west should be the next node in the ring in a counter-clockwise direction.

- ◆ **Interface** – The port or trunk attached to the west or east ring port. Note that a ring port cannot be configured as a member of a spanning tree, a dynamic trunk, or a static trunk.
- ◆ **Port State** – Once configured, this field shows the operational state of the ring ports for this node:
 - ◆ **Blocking** – The transmission and reception of traffic is blocked and the forwarding of R-APS messages is blocked, but the transmission of

locally generated R-APS messages is allowed and the reception of all R-APS messages is allowed.

- ◆ Forwarding – The transmission and reception of traffic is allowed; transmission, reception and forwarding of R-APS messages is allowed.
- ◆ Down – The interface is not linked up.
- ◆ Unknown – The interface is not in a known state.
- ◆ **Local SF** – Shows if a signal fault exists on a link to the local node.
- ◆ **Local FS** – Shows if a forced switch command was issued on this interface.
- ◆ **Local MS** – Shows if a manual switch command was issued on this interface.
- ◆ **MEP** – Specifies the MEPs used to monitor the link on a ring node.
- ◆ **RPL** – If node is connected to the RPL, this shows by which interface.
- ◆ **Inclusion VLANs** – Specifies VLAN groups that are to be on the inclusion list of an the ERPS instance. VLANs that are on the inclusion list are protected by the ERPS instance. Any VLAN not listed on either the inclusion or exclusion list will be blocked on ring ports.
- ◆ **Status** – Activates the current ERPS instance. (Default: Disabled)

Before enabling a ring instance, the global ERPS function should be enabled see (ERPS Global Configuration), the physical ring east and west ports configured on each node, the RPL owner specified, and the control VLAN configured.

Once enabled, the RPL owner node and non-owner node state machines will start, and the ring will enter idle state if no signal failures are detected.

Web Interface

To create an ERPS instance:

1. Click **Administration > ERPS**.
2. Select Configure Instance from the Step list.
3. Select Add from the Action list.
4. Enter a name and optional identifier for the instance.
5. Click **Apply**.

The screenshot shows a web interface titled "Administration > ERPS". At the top, there are two dropdown menus: "Step:" with "4. Configure Instance" selected, and "Action:" with "Add" selected. Below these, there is a form with two input fields. The first is labeled "Instance Name" and is empty. The second is labeled "ID (1-255)" and has a small square checkbox to its left, which is unchecked. At the bottom right of the form are two buttons: "Apply" and "Revert".

To configure the ERPS parameters for an instance:

1. Click **Administration > ERPS**.
2. Select Configure Instance from the Step list.
3. Select Configure Details from the Action list.
4. Configure the ERPS instance parameters for this node. Note that spanning tree protocol cannot be configured on the ring ports, nor can these ports be members of a static or dynamic trunk. And the control VLAN must be unique for each ring. Adjust the protocol timers as required. The RPL owner must be set on one of the rings. And the administrative status enabled once all of the other settings have been entered.
5. Click **Apply**.

Administration > ERPS ?

Step: 4. Configure Instance Action: Configure Details

Instance Name:

Instance ID:

Control VLAN:

Node State:

Node Type:

Major Ring:

Version:

MEG Level (0-7):

Revertive: Enabled

R-APS with VC: Enabled

R-APS Def MAC: Enabled

Propagate TC: Enabled

Holdoff Timer (0-10000): ms

Guard Timer (10-2000): ms

WTB Timer: ms

WTR Timer (1-12): min

WTB Expire:

WTR Expire:

Physical Ring:

<p>West</p> <p>Interface: <input type="text" value=""/></p> <p>Port State: <input type="text" value="Unknown"/></p> <p>Local SF: <input type="text" value="No"/></p> <p>Local FS: <input type="text" value="No"/></p> <p>Local MS: <input type="text" value="No"/></p> <p>MEP: <input type="text" value=""/></p> <p>RPL: <input type="text" value="No"/></p>	<p>East</p> <p>Interface: <input type="text" value=""/></p> <p>Port State: <input type="text" value="Unknown"/></p> <p>Local SF: <input type="text" value="No"/></p> <p>Local FS: <input type="text" value="No"/></p> <p>Local MS: <input type="text" value="No"/></p> <p>MEP: <input type="text" value=""/></p> <p>RPL: <input type="text" value=""/></p>
---	---

Inclusion VLANs Total: 5

<input type="checkbox"/>	VLAN Group
<input checked="" type="checkbox"/>	test-group
<input type="checkbox"/>	ERPgroup2
<input type="checkbox"/>	ERPgroup3
<input type="checkbox"/>	ERPgroup4
<input type="checkbox"/>	ERPgroup5

Status: Enabled

To show the configured ERPS instances:

1. Click **Administration > ERPS**.
2. Select Configure Instance from the Step list.
3. Select Show from the Action list.

Administration > ERPS

Step: 4. Configure Instance Action: Show

Instance List Total: 3

	Name	ID	Status	Physical Ring	Control VLAN	Node State	Type	W/E	Interface	Port State	Local SF	Local FS	Local MS	MEP	RPL	Inclusion VLAN Groups
<input type="checkbox"/>	test1	1	Disabled	test-ring	1	Init	None	West		Unknown	No	No	No	No	No	1
<input type="checkbox"/>	ERPInst12	12	Disabled			Init	None	West		Unknown	No	No	No	No	No	
<input type="checkbox"/>	ERPInst13	13	Disabled			Init	None	West		Unknown	No	No	No	No	No	

Delete Revert

ERPS Forced and Manual Mode Operations

Use the Administration > ERPS (Configure Instance - Configure Operation) page to block a ring port using Forced Switch or Manual Switch commands.

Parameters

These parameters are displayed:

- ◆ **Instance Name** – Name of a configured ERPS instance.
- ◆ **Operation** – Specifies a Forced Switch (FS) or Manual Switch (MS) operation on the east or west ring port.
 - ◆ **Forced Switch** – Blocks specified ring port. (Options: West or East)
 - ◆ A ring with no pending request has a logical topology with the traffic channel blocked at the RPL and unblocked on all other ring links. In this situation, the FS command triggers protection switching as follows:
 - a. The ring node where an FS command was issued blocks the traffic channel and R-APS channel on the ring port to which the command was issued, and unblocks the other ring port.
 - b. The ring node where the FS command was issued transmits R-APS messages indicating FS over both ring ports. R-APS (FS) messages are continuously transmitted by this ring node while the local FS command is the ring node's highest priority command.

The R-APS (FS) message informs other ring nodes of the FS command and that the traffic channel is blocked on one ring port.

- c. A ring node accepting an R-APS (FS) message, without any local higher priority requests unblocks any blocked ring port. This action subsequently unblocks the traffic channel over the RPL.
 - d. The ring node accepting an R-APS (FS) message, without any local higher priority requests stops transmission of R-APS messages.
 - e. The ring node receiving an R-APS (FS) message flushes its FDB.
- ◆ Protection switching on a forced switch request is completed when the above actions are performed by each ring node. At this point, traffic flows around the ring are resumed. From this point on the following rules apply regarding processing of further forced switch commands:
 - ◆ While an existing forced switch request is present in a ring, any new forced switch request is accepted, except on a ring node having a prior local forced switch request. The ring nodes where further forced switch commands are issued block the traffic channel and R-APS channel on the ring port at which the forced switch was issued. The ring node where the forced switch command was issued transmits an R-APS message over both ring ports indicating FS. R-APS (FS) messages are continuously transmitted by this ring node while the local FS command is the ring node's highest priority command. As such, two or more forced switches are allowed in the ring, which may inadvertently cause the segmentation of a ring. It is the responsibility of the operator to prevent this effect if it is undesirable.

Ring protection requests, commands and R-APS signals have the priorities as specified in the following table.

Request / State and Status	Type	Priority
Clear	local	highest
FS	local	
R-APS (FS)	remote	
local SF*	local	
local clear SF	local	

Request / State and Status	Type	Priority
R-APS (SF)	remote	
R-APS (MS)	remote	
MS	local	
WTR Expires	local	
WTR Running	local	
WTB Expires	local	
WTB Running	local	
R-APS (NR, RB)	remote	
R-APS (NR)	remote	lowest

Note: * If an Ethernet Ring Node is in the Forced Switch state, local SF is ignored.

- ◆ Recovery for forced switching under revertive and non-revertive mode is described under the Revertive parameter.
- ◆ When a ring is under an FS condition, and the node at which an FS command was issued is removed or fails, the ring remains in FS state because the FS command can only be cleared at node where the FS command was issued. This results in an unrecoverable FS condition.

When performing a maintenance procedure (e.g., replacing, upgrading) on a ring node (or a ring link), it is recommended that FS commands be issued at the two adjacent ring nodes instead of directly issuing a FS command at the ring node under maintenance in order to avoid falling into the above mentioned unrecoverable situation.

- ◆ **Manual Switch** – Blocks specified ring port, in the absence of a failure or an FS command. (Options: West or East)
 - ◆ A ring with no request has a logical topology with the traffic channel blocked at the RPL and unblocked on all other ring links. In this situation, the Manual Switch command triggers protection switching as follows:
 - a. If no other higher priority commands exist, the ring node, where a manual switch command was issued, blocks the traffic channel and R-APS channel on the ring port to which the command was issued, and unblocks the other ring port.

- b. If no other higher priority commands exist, the ring node where the manual switch command was issued transmits R-APS messages over both ring ports indicating MS. R-APS (MS) messages are continuously transmitted by this ring node while the local MS command is the ring node's highest priority command. The R-APS (MS) message informs other ring nodes of the MS command and that the traffic channel is blocked on one ring port.
 - c. If no other higher priority commands exist and assuming the ring node was in Idle state before the manual switch command was issued, the ring node flushes its local FDB.
 - d. A ring node accepting an R-APS (MS) message, without any local higher priority requests unblocks any blocked ring port which does not have an SF condition. This action subsequently unblocks the traffic channel over the RPL.
 - e. A ring node accepting an R-APS (MS) message, without any local higher priority requests stops transmitting R-APS messages.
 - f. A ring node receiving an R-APS (MS) message flushes its FDB.
- ◆ Protection switching on a manual switch request is completed when the above actions are performed by each ring node. At this point, traffic flows around the ring are resumed. From this point on, the following rules apply regarding processing of further manual switch commands:
 - a. While an existing manual switch request is present in the ring, any new manual switch request is rejected. The request is rejected at the ring node where the new request is issued and a notification is generated to inform the operator that the new MS request was not accepted.
 - b. A ring node with a local manual switch command which receives an R-APS (MS) message with a different Node ID clears its manual switch request and starts transmitting R-APS (NR) messages. The ring node keeps the ring port blocked due to the previous manual switch command.
 - c. An ring node with a local manual switch command that receives an R-APS message or a local request of higher priority than R-APS (MS) clear its manual switch request. The ring node then processes the new higher priority request.
 - ◆ Recovery for manual switching under revertive and non-revertive mode is described under the Revertive parameter.

- ◆ **Clear** – Manually clears the protection state which has been invoked by a forced switch or manual switch command, and the node is operating under non-revertive mode; or before the WTR or WTB timer expires when the node is operating in revertive mode.
 - ◆ Two steps are required to make a ring operating in non-revertive mode return to Idle state from forced switch or manual switch state:
 1. Issue a Clear command to remove the forced switch command on the node where a local forced switch command is active.
 2. Issue a Clear command on the RPL owner node to trigger the reversion.
 - ◆ The Clear command will also stop the WTR and WTB delay timers and reset their values.
 - ◆ More detailed information about using this command for non-revertive mode is included under the Revertive parameter. (See the Command Usage section under ERPS Instance Configuration.)

Web Interface

To block a ring port:

1. Click **Administration > ERPS**.
2. Select Configure Instance from the Step list.
3. Select Configure Operation from the Action list.
4. Select the instance name from the drop-down list.
5. Specify a Forced Switch, Manual Switch, or Clear operation.
6. Click **Apply**.

Administration > ERPS	
Step:	4. Configure Instance ▼
Action:	Configure Operation ▼
Instance Name	test1 ▼
Operation	Forced-switch West ▼
<input type="button" value="Apply"/>	

MLAG

A multi-chassis link aggregation group (MLAG) is a pair of links that terminate on two cooperating switches and appear as an ordinary link aggregation group (LAG). The cooperating switches are MLAG peer switches and communicate through an interface called a peer link. While the peer link's primary purpose is exchanging MLAG control information between peer switches, but also carries data traffic from devices that are attached to only one MLAG peer and have no alternative path. An MLAG domain consists of the peer switches and the control links that connect these switches.

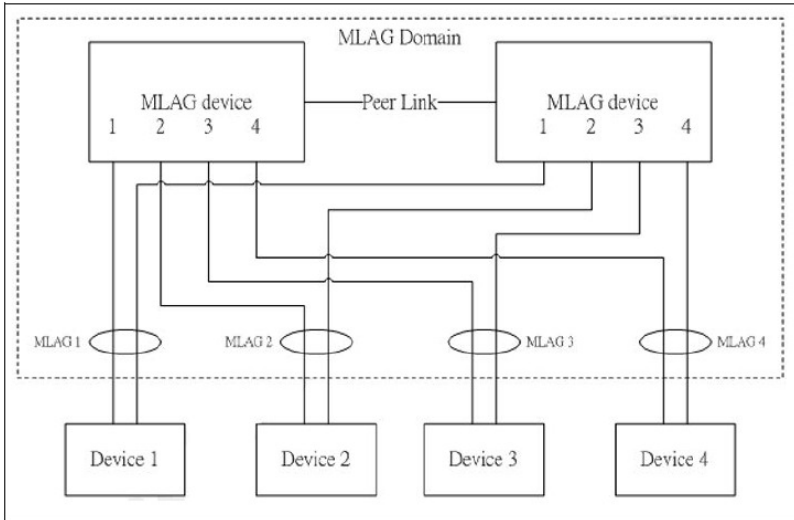

Usage Guidelines

- ◆ MLAG must be enabled globally from the Configure Global page.
- ◆ The MLAG domain ID and peer link must be set using the Configure Domain - Add page.
- ◆ The MLAG ID, associated MLAG domain ID and MLAG member must be configured using the Configure Group - Add page. The associated MLAG domain may be nonexistent, which causes MLAG to be inactive locally.
- ◆ For a port to be configured as MLAG peer link or member:
 - ◆ STP status of the port must be disabled.
 - ◆ LACP status of the port must be disabled.
 - ◆ The port must not be any type of traffic segmentation port.

MLAG Restrictions

- ◆ Traffic segmentation up-link/down-link port cannot be configured on an MLAG member or peer link.
- ◆ All actions that cause a port to become nonexistent, such as deleting a trunk port, adding a port to a trunk, or enabling LACP, are not allowed for an MLAG member or peer link. Also, a trunk member port is not allowed to be an MLAG member or peer link.
- ◆ STP cannot be enabled on a peer link or an MLAG member. An STP enabled port cannot be configured as a peer link or an MLAG member.

MLAG Global Configuration

Use the Administration > MLAG > Global page to enable MLAG functionality on the switch.

Parameters

These parameters are displayed:

- ◆ **MLAG Status** – Enables or disables MLAG functions. (Default: Enabled)

Web Interface

To enable MLAG functionality on the switch:

1. Click **Administration > MLAG**.
2. Select Configure Global from the Step list.
3. Set the MLAG administrative status to enabled.
4. Click **Apply**.

The screenshot shows a web interface for configuring MLAG. At the top, it says "Administration > MLAG". Below that, there is a "Step:" dropdown menu set to "1. Configure Global". The main configuration area shows "MLAG Status" with a checked checkbox and the text "Enabled". At the bottom right, there are two buttons: "Apply" and "Revert".

MLAG Domain Configuration

Use the Administration > MLAG > Domain page to configure MLAG domains and peer links on the switch.

Usage Guidelines

- ◆ There shall be one and only one peer link for a pair of MLAG devices in the same MLAG domain.
- ◆ The peer link can be a normal port or a static trunk.
- ◆ MAC learning is automatically disabled for the peer link.
- ◆ An MLAG domain is active if the domain ID and a peer link are set.

Parameters

These parameters are displayed:

- ◆ **Domain ID** – Domain identifier. (Range: 1-16 characters)
- ◆ **Interface** – The peer link port or trunk identifier.

Web Interface

To enable MLAG functionality on the switch:

1. Click **Administration > MLAG**.
2. Select Configure Domain from the Step list.
3. Set an MLAG domain identifier.
4. Select one port or trunk interface as the peer link to another MLAG device.
5. Click **Apply**.

The screenshot shows a web interface titled "Administration > MLAG". At the top, there is a "Step:" dropdown menu set to "2. Configure Domain" and an "Action:" dropdown menu set to "Add". Below this, there is a "Domain ID" label followed by a text input field. Underneath, there is an "Interface" label with two radio button options: "Port" (which is selected) and "Trunk". The "Port" option has a dropdown menu showing "1". At the bottom right of the form, there are two buttons: "Apply" and "Revert".

MLAG Group Configuration

Use the Administration > MLAG > Group page to configure MLAG member interfaces on the switch.

Usage Guidelines

- ◆ An MLAG domain can have two and only two MLAG devices.
- ◆ An MLAG domain may have many MLAGs.
- ◆ An MLAG can belong to one and only one MLAG domain.

- ◆ The associated MLAG domain may be nonexistent, which causes the MLAG to be inactive locally.
- ◆ There can be one and only one MLAG member for each MLAG on an MLAG device.
- ◆ The MLAG member can be a normal port or a static trunk.
- ◆ An MLAG member is active if the MLAG ID is set and the associated MLAG domain is active.
- ◆ An MLAG is formed when the peer MLAG members are both active.
- ◆ The following items apply when an MLAG is formed.
 - ◆ When an MLAG member is operationally up and the MLAG peer member is not operationally down, all traffic from the peer link can not be forwarded to the MLAG member.
 - ◆ When an MLAG member is operationally up and the MLAG peer member is operationally down, all traffic from the peer link can be forwarded to the MLAG member.
 - ◆ When an MLAG member is operationally up, all updates for learned MAC addresses on the MLAG peer member will be synced to the MLAG member automatically.
 - ◆ When an MLAG member is operationally down, all updates for learned MAC addresses on the MLAG peer member will be synced through the peer link automatically.

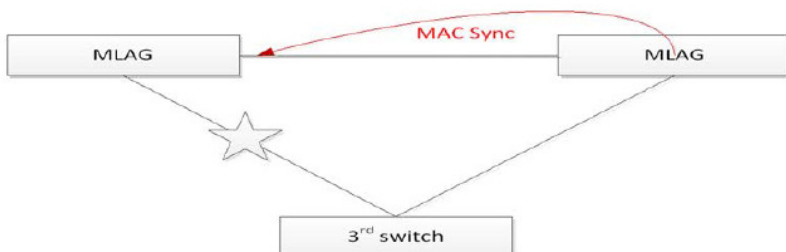

- ◆ When the MLAG peer member is down or nonexistent, learned MAC addresses are synced through the peer link for the MLAG will be removed automatically.

Parameters

These parameters are displayed:

- ◆ **MLAG ID** – MLAG identifier. (Range: 1-1000)
- ◆ **Domain ID** – Domain identifier. (Range: 1-16 characters)

- ◆ **Interface** – The MLAG member port or trunk identifier.

Web Interface

To enable MLAG functionality on the switch:

1. Click **Administration > MLAG**.
2. Select Configure Group from the Step list.
3. Set an MLAG identifier.
4. Set the MLAG domain identifier.
5. Select a port or trunk interface as an MLAG member.
6. Click **Apply**.

The screenshot shows the 'Administration > MLAG' configuration page. At the top, there is a breadcrumb 'Administration > MLAG'. Below it, a 'Step:' dropdown is set to '3. Configure Group' and an 'Action:' dropdown is set to 'Add'. The main configuration area contains three fields: 'MLAG ID' with an empty text box, 'Domain ID' with an empty text box, and 'Interface' with radio buttons for 'Port' (selected) and 'Trunk', and a dropdown menu showing '1'. At the bottom right, there are 'Apply' and 'Revert' buttons.

Operation, Administration and Maintenance (OAM)

The switch provides OAM (Operation, Administration, and Maintenance) remote management tools required to monitor and maintain the links to subscriber CPEs (Customer Premise Equipment). This section describes functions including enabling OAM for selected ports, loopback testing, and displaying remote device information.

Enabling OAM on Local Ports

Use the Administration > OAM > Interface page to enable OAM functionality on the selected port. Not all CPEs support operation and maintenance functions, so OAM is therefore disabled by default. If a CPE supports OAM, this functionality must first be enabled on the connected port to gain access to the configuration functions provided under the OAM menu.

Parameters

These parameters are displayed:

- ◆ **Port** – Port identifier. (Range: 1-28/54)
- ◆ **Admin Status** – Enables or disables OAM functions. (Default: Disabled)
- ◆ **Operation State** – Shows the operational state between the local and remote OAM devices. This value is always “disabled” if OAM is disabled on the local interface.

State	Description
Disabled	OAM is disabled on this interface via the OAM Admin Status.
Link Fault	The link has detected a fault or the interface is not operational.
Passive Wait	This value is returned only by OAM entities in passive mode and indicates the OAM entity is waiting to see if the peer device is OAM capable.
Active Send Local	This value is used by active mode devices and indicates the OAM entity is actively trying to discover whether the peer has OAM capability but has not yet made that determination.
Send Local And Remote	The local OAM entity has discovered the peer but has not yet accepted or rejected the configuration of the peer.
Send Local And Remote OK	OAM peering is allowed by the local device.
OAM Peering Locally Rejected	The local OAM entity rejects the peering.
OAM Peering Remotely Rejected	The remote OAM entity rejects the peering.

State	Description
Operational	When the local OAM entity learns that both it and the remote OAM entity have accepted the peering, the state moves to this state.
Non Oper Half Duplex	This state is returned whenever Ethernet OAM is enabled but the interface is in half-duplex operation.

- ◆ **Mode** – Sets the OAM operation mode. (Default: Active)
 - ◆ **Active** – All OAM functions are enabled.
 - ◆ **Passive** – All OAM functions are enabled, except for OAM discovery, sending variable request OAMPDUs, and sending loopback control OAMPDUs.
- ◆ **Critical Link Event** – Controls reporting of critical link events to its OAM peer.
 - ◆ **Dying Gasp** – If an unrecoverable condition occurs, the local OAM entity (i.e., this switch) indicates this by immediately sending a trap message. (Default: Enabled)
Dying gasp events are caused by an unrecoverable failure, such as a power failure or device reset.

Note: When system power fails, the switch will always send a dying gasp trap message prior to power down.

- ◆ **Critical Event** – If a critical event occurs, the local OAM entity indicates this to its peer by setting the appropriate flag in the next OAMPDU to be sent and stores this information in its OAM event log. (Default: Enabled)
Critical events include various failures, such as abnormal voltage fluctuations, out-of-range temperature detected, fan failure, CRC error in flash memory, insufficient memory, or other hardware faults.
- ◆ **Errored Frame** – Controls reporting of errored frame link events.
An errored frame is a frame in which one or more bits are errored.
An errored frame link event occurs if the threshold is reached or exceeded within the specified period.
If reporting is enabled and an errored frame link event occurs, the local OAM entity (this switch) sends an Event Notification OAMPDU to the remote OAM entity. The Errored Frame Event TLV includes the number of errored frames detected during the specified period.
 - ◆ **Status** – Enables reporting of errored frame link events. (Default: Enabled)

- ◆ **Window Size** – The period of time in which to check the reporting threshold for errored frame link events. (Range: 10-65535 in units of 10 milliseconds; Default: 10 units of 10 milliseconds, or the equivalent of 1 second)
- ◆ **Threshold Count** – The threshold for errored frame link events. (Range: 1-65535; Default: 1)

Web Interface

To enable OAM functionality on the selected port:

1. Click **Administration > OAM > Interface**.
2. Set the OAM administrative status and operational mode for the required ports. Specify whether or not critical link events will be reported by the switch. Specify whether errored frame link events will be reported, as well as the required window size and threshold.
3. Click **Apply**.

The screenshot shows the 'Administration > OAM > Interface' web interface. At the top, there is a breadcrumb trail and a help icon. Below that, the 'OAM Port List' is displayed with a total of 26 ports. The table has columns for Port, Admin Status, Operation State, Mode, Critical Link Event (Dying Gasp, Critical Event, Status), Errored Frame (Window Size, str, Threshold Count). All ports are currently disabled and in 'Active' mode. The Critical Link Event and Errored Frame settings are consistent across all ports.

Port	Admin Status	Operation State	Mode	Critical Link Event			Errored Frame	
				Dying Gasp	Critical Event	Status	Window Size (10-65535 1/10 sec)	str, Threshold Count (1-65535)
1	<input type="checkbox"/> Enabled	Disabled	Active	<input checked="" type="checkbox"/> Enabled	<input checked="" type="checkbox"/> Enabled	<input checked="" type="checkbox"/> Enabled	10	1
2	<input type="checkbox"/> Enabled	Disabled	Active	<input checked="" type="checkbox"/> Enabled	<input checked="" type="checkbox"/> Enabled	<input checked="" type="checkbox"/> Enabled	10	1
3	<input type="checkbox"/> Enabled	Disabled	Active	<input checked="" type="checkbox"/> Enabled	<input checked="" type="checkbox"/> Enabled	<input checked="" type="checkbox"/> Enabled	10	1
4	<input type="checkbox"/> Enabled	Disabled	Active	<input checked="" type="checkbox"/> Enabled	<input checked="" type="checkbox"/> Enabled	<input checked="" type="checkbox"/> Enabled	10	1
5	<input type="checkbox"/> Enabled	Disabled	Active	<input checked="" type="checkbox"/> Enabled	<input checked="" type="checkbox"/> Enabled	<input checked="" type="checkbox"/> Enabled	10	1

Displaying Statistics for OAM Messages

Use the Administration > OAM > Counters page to display statistics for the various types of OAM messages passed across each port.

Parameters

These parameters are displayed:

- ◆ **Port** – Port identifier. (Range: 1-28/54)
- ◆ **Clear** – Clears statistical counters for the selected ports.
- ◆ **OAMPDU** – Message types transmitted and received by the OAM protocol, including Information OAMPDUs, unique Event OAMPDUs, Loopback Control OAMPDUs, and Organization Specific OAMPDUs.

Web Interface

To display statistics for OAM messages:

1. Click **Administration > OAM > Counters**.

Administration > OAM > Counters ?

OAM Port Counters Total: 28 1 2 3

Port	OAMPDU							
	Information		Event Notification		Loopback Control		Organization Specific	
	Transmitted	Received	Transmitted	Received	Transmitted	Received	Transmitted	Received
<input type="checkbox"/> 1	0	0	0	0	0	0	0	0
<input type="checkbox"/> 2	0	0	0	0	0	0	0	0
<input type="checkbox"/> 3	0	0	0	0	0	0	0	0
<input type="checkbox"/> 4	0	0	0	0	0	0	0	0
<input type="checkbox"/> 5	0	0	0	0	0	0	0	0
<input type="checkbox"/> 6	0	0	0	0	0	0	0	0
<input type="checkbox"/> 7	0	0	0	0	0	0	0	0
<input type="checkbox"/> 8	0	0	0	0	0	0	0	0
<input type="checkbox"/> 9	0	0	0	0	0	0	0	0
<input type="checkbox"/> 10	0	0	0	0	0	0	0	0

Clear

Displaying the OAM Event Log

Use the Administration > OAM > Event Log page to display link events for the selected port.

Command Usage

- ◆ When a link event occurs, no matter whether the location is local or remote, this information is entered in OAM event log.
- ◆ When the log system becomes full, older events are automatically deleted to make room for new entries.
- ◆ The time of locally generated events can be accurately retrieved from the sysUpTime variable. For remotely generated events, the time of an event is indicated by the reception of an Event Notification OAMPDU from the peer.

Web Interface

To display link events for the selected port:

1. Click **Administration > OAM > Event Log**.
2. Select a port from the drop-down list.

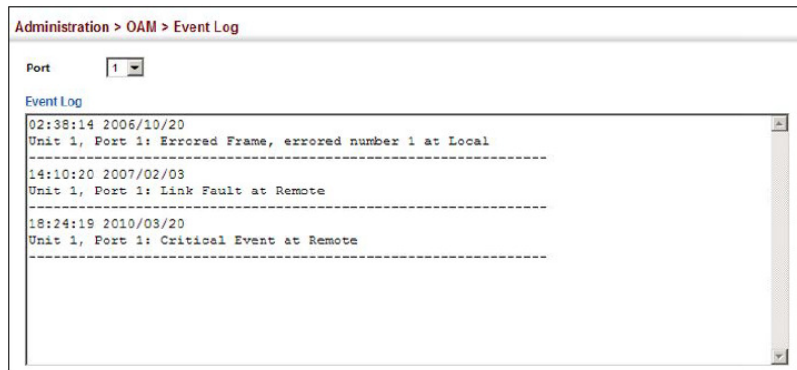

Displaying the Status of Remote Interfaces

Use the Administration > OAM > Remote Interface page to display information about attached OAM-enabled devices.

Parameters

These parameters are displayed:

- ◆ **Port** – Port identifier. (Range: 1-28/54)
- ◆ **MAC Address** – MAC address of the OAM peer.
- ◆ **OUI** – Organizational Unit Identifier of the OAM peer.
- ◆ **Remote Loopback** – Shows if remote loopback is supported by the OAM peer.
- ◆ **Unidirectional Function** – Shows if this function is supported by the OAM peer.

If supported, this indicates that the OAM entity supports the transmission of OAMPDUs on links that are operating in unidirectional mode (where traffic flows in one direction only). Some newer physical layer devices support the optional ability to encode and transmit data while one direction of the link is non-operational. This function allows OAM remote fault indication during fault conditions. This switch does not support the unidirectional function, but can parse error messages sent from a peer with unidirectional capability.

- ◆ **Link Monitor** – Shows if the OAM entity can send and receive Event Notification OAMPDUs.
- ◆ **MIB Variable Retrieval** – Shows if the OAM entity can send and receive Variable Request and Response OAMPDUs.

Web Interface

To display information about attached OAM-enabled devices:

1. Click **Administration > OAM > Remote Interface**.

Administration > OAM > Remote Interface

OAM Remote Port List Total: 28

Port	MAC Address	OUI	Remote Loopback	Unidirectional Function	Link Monitor	MIB Variable Retrieval
1	00-00-00-00-00-00	00-00-00	Disabled	Disabled	Disabled	Disabled
2	00-00-00-00-00-00	00-00-00	Disabled	Disabled	Disabled	Disabled
3	00-00-00-00-00-00	00-00-00	Disabled	Disabled	Disabled	Disabled
4	00-00-00-00-00-00	00-00-00	Disabled	Disabled	Disabled	Disabled
5	00-00-00-00-00-00	00-00-00	Disabled	Disabled	Disabled	Disabled
6	00-00-00-00-00-00	00-00-00	Disabled	Disabled	Disabled	Disabled
7	00-00-00-00-00-00	00-00-00	Disabled	Disabled	Disabled	Disabled
8	00-00-00-00-00-00	00-00-00	Disabled	Disabled	Disabled	Disabled
9	00-00-00-00-00-00	00-00-00	Disabled	Disabled	Disabled	Disabled
10	00-00-00-00-00-00	00-00-00	Disabled	Disabled	Disabled	Disabled

Configuring a Remote Loopback Test

Use the Administration > OAM > Remote Loopback (Remote Loopback Test) page to initiate a loop back test to the peer device attached to the selected port.

Command Usage

- You can use this command to perform an OAM remote loop back test on the specified port. The port that you specify to run this test must be connected to a peer OAM device capable of entering into OAM remote loop back mode.
- During a remote loop back test, the remote OAM entity loops back every frame except for OAMPDUs and pause frames.
- OAM remote loopback can be used for fault localization and link performance testing. Statistics from both the local and remote DTE can be queried and compared at any time during loop back testing.
- To perform a loopback test, first enable Remote Loop Back Mode, click Test, and then click End. The number of packets transmitted and received will be displayed.

Parameters

These parameters are displayed:

Loopback Mode of Remote Device

- **Port** – Port identifier. (Range: 1-28/54)

- ◆ **Loopback Mode** – Shows if loop back mode is enabled on the peer. This attribute must be enabled before starting the loopback test.
- ◆ **Loopback Status** – Shows if loopback testing is currently running.

Loopback Test Parameters

- ◆ **Packet Number** – Number of packets to send. (Range: 1-99999999; Default: 10000)
- ◆ **Packet Size** – Size of packets to send. (Range: 64-1518 bytes; Default: 64 bytes)
- ◆ **Test** – Starts the loop back test.
- ◆ **End** – Stops the loop back test.

Loop Back Status of Remote Device

- ◆ **Result** – Shows the loop back status on the peer. The loop back states shown in this field are described below.

State	Description
No Loopback	Operating in normal mode with no loopback in progress.
Initiating Loopback	The local OAM entity is starting the loopback process with its peer. It has yet to receive any acknowledgement that the remote OAM entity has received its loopback command request.
Remote Loopback	The local OAM client knows that the remote OAM entity is in loopback mode.
Terminating Loopback	The local OAM client is in the process of terminating the remote loopback.
Local Loopback	The remote OAM client has put the local OAM entity in loopback mode.
Unknown	This status may be returned if the OAM loopback is in a transition state but should not persist.

- ◆ **Packets Transmitted** – The number of loop back frames transmitted during the last loopback test on this interface.
- ◆ **Packets Received** – The number of loop back frames received during the last loopback test on this interface.
- ◆ **Loss Rate** – The percentage of packets for which there was no response.

Web Interface

To initiate a loop back test to the peer device attached to the selected port:

1. Click **Administration > OAM > Remote Loop Back**.
2. Select Remote Loopback Test from the Action list.
3. Select the port on which to initiate remote loop back testing, enable the Loop Back Mode attribute, and click **Apply**.
4. Set the number of packets to send and the packet size, and then click **Test**.

Administration > OAM > Remote Loopback

Action: Remote Loopback Test

Port: 2

Loopback Mode: Enabled

Loopback Status: Remote Loopback

Apply Revert

Packet Number (1-9999999):

Packet Size (64-1518) bytes

Test End

Result

10 packets transmitted. 10 packets received. Loss rate is 0.00 %

Displaying Results of Remote Loopback Testing

Use the Administration > OAM > Remote Loopback (Show Test Result) page to display the results of remote loop back testing for each port for which this information is available.

Parameters

These parameters are displayed:

- ◆ **Port** – Port identifier. (Range: 1-28/54)
- ◆ **Packets Transmitted** – The number of loop back frames transmitted during the last loop back test on this interface.
- ◆ **Packets Received** – The number of loop back frames received during the last loop back test on this interface.
- ◆ **Loss Rate** – The percentage of packets transmitted for which there was no response.



Web Interface

To display the results of remote loop back testing for each port for which this information is available:

1. Click **Administration > OAM > Remote Loop Back**.
2. Select Show Test Result from the Action list.

Administration > OAM > Remote Loopback 

Action:

Port Remote Test Result List Total: 28   

Port	Packets Transmitted	Packets Received	Loss Rate
1	0	0	0.00 %
2	0	0	0.00 %
3	0	0	0.00 %
4	0	0	0.00 %
5	0	0	0.00 %
6	0	0	0.00 %
7	0	0	0.00 %
8	0	0	0.00 %
9	0	0	0.00 %
10	0	0	0.00 %

UniDirectional Link Detection (UDLD)

The switch can be configured to detect general loopback conditions caused by hardware problems or faulty protocol settings. When enabled, a control frame is transmitted on the participating ports, and the switch monitors inbound traffic to see if the frame is looped back.

Usage Guidelines

- ◆ The default settings for the control frame transmit interval and recover time may be adjusted to improve performance for your specific environment. The shutdown mode may also need to be changed once you determine what kind of packets are being looped back.
- ◆ General loopback detection provided by the commands described in this section and loopback detection provided by the spanning tree protocol cannot both be enabled at the same time. If loopback detection is enabled for the spanning tree protocol, general loopback detection cannot be enabled on the same interface.
- ◆ When a loopback event is detected on an interface or when an interface is released from a shutdown state caused by a loopback event, a trap message is sent and the event recorded in the system log.
- ◆ Loopback detection must be enabled both globally and on an interface for loopback detection to take effect.

Configuring UDLD Protocol Intervals

Use the Administration > UDLD > Configure Global page to configure the UniDirectional Link Detection message probe interval, detection interval, and recovery interval.

Parameters

These parameters are displayed:

- ◆ **Message Interval** – Configures the message interval between UDLD probe messages for ports in the advertisement phase and determined to be bidirectional. (Range: 7-90 seconds; Default: 15 seconds)

UDLD probe messages are sent after linkup or detection phases. During the detection phase, messages are exchanged at the maximum rate of one per second. After that, if the protocol reaches a stable state and determines that the link is bidirectional, the message interval is increased to a configurable value based on a curve known as M1(t), a time-based function described in RFC 5171.

If the link is deemed anything other than bidirectional at the end of the detection phase, this curve becomes a flat line with a fixed value of Mfast (7 seconds).

If the link is instead deemed bidirectional, the curve will use Mfast for the first four subsequent message transmissions and then transition to an Mslow value for all other steady-state transmissions. Mslow is the value configured by this command.

- ◆ **Detection Interval** – Sets the amount of time the switch remains in detection state after discovering a neighbor. (Range: 5-255 seconds; Default: 5 seconds)

When a neighbor device is discovered by UDLD, the switch enters “detection state” and remains in this state for specified detection-interval. After the detection-interval expires, the switch tries to decide whether or the link is unidirectional based on the information collected during the “detection state.”

- ◆ **Recovery Status** – Configures the switch to automatically recover from UDLD disabled port state after a period specified by the Recovery Interval. (Default: Disabled)

When automatic recovery state is changed, any ports shut down by UDLD will be reset.

- ◆ **Recovery Interval** – Specifies the period after which to automatically recover from UDLD disabled port state. (Range: 30-86400 seconds; Default: 300 seconds)

When the recovery interval is changed, any ports shut down by UDLD will be reset.

Web Interface

To configure the UDLD message probe interval, detection interval, and recovery interval:

1. Click **Administration > UDLD > Configure Global**.
2. Select Configure Global from the Step list.
3. Configure the message and detection intervals.
4. Enable automatic recovery if required, and set the recovery interval.
5. Click **Apply**.

Administration > UDLD

Step: 1. Configure Global

Message Interval (7-90) 15 seconds

Detection Interval (5-255) 5 seconds

Recovery Status Enabled

Recovery Interval (30-86400) 300 seconds

Apply Revert

Configuring UDLD Interface Settings

Use the Administration > UDLD (Configure Interface) page to enable UDLD and aggressive mode which reduces the shut-down delay after loss of bidirectional connectivity is detected.

Parameters

These parameters are displayed:

- ♦ **Port** – Port identifier. (Range: 1-28/54)
- ♦ **UDLD** – Enables UDLD on a port. (Default: Disabled)
 - ♦ UDLD requires that all the devices connected to the same LAN segment be running the protocol in order for a potential mis-configuration to be detected and for prompt corrective action to be taken.
 - ♦ Whenever a UDLD device learns about a new neighbor or receives a resynchronization request from an out-of-synch neighbor, it (re)starts the detection process on its side of the connection and sends N echo messages in reply. (This mechanism implicitly assumes that N packets are sufficient to get through a link and reach the other end, even though some of them might get dropped during the transmission.)

Since this behavior must be the same on all the neighbors, the sender of the echoes expects to receive an echo in reply. If the detection process ends without the proper echo information being received, the link is considered to be unidirectional.

- ♦ **Aggressive Mode** – Reduces the shut-down delay after loss of bidirectional connectivity is detected. (Default: Disabled)

UDLD can function in two modes: normal mode and aggressive mode.

- ♦ In normal mode, determination of link status at the end of the detection process is always based on information received in UDLD messages:

whether that's information about the exchange of proper neighbor identification or the absence of such. Hence, albeit bound by a timer, normal mode determinations are always based on gleaned information, and as such are "event-based." If no such information can be obtained (e.g., because of a bidirectional loss of connectivity), UDLD follows a conservative approach to minimize false positives during the detection process and deems a port to be in "undetermined" state. In other words, normal mode will shut down a port only if it can explicitly determine that the associated link is faulty for an extended period of time.

- ◆ In aggressive mode, UDLD will also shut down a port if it loses bidirectional connectivity with the neighbor for the same extended period of time (as that mentioned above for normal mode) and subsequently fails repeated last-resort attempts to re-establish communication with the other end of the link. This mode of operation assumes that loss of communication with the neighbor is a meaningful network event in itself, and a symptom of a serious connectivity problem. Because this type of detection can be event-less, and lack of information cannot always be associated to an actual malfunction of the link, this mode is recommended only in certain scenarios (typically only on point-to-point links where no communication failure between two neighbors is admissible).
- ◆ **Operation State** – Shows the UDLD operational state (Disabled, Link down, Link up, Advertisement, Detection, Disabled port, Advertisement - Single neighbor, Advertisement - Multiple neighbors)
- ◆ **Port State** – Shows the UDLD port state (Unknown, Bidirectional, Unidirectional, Transmit-to-receive loop, Mismatch with neighbor state reported, Neighbor's echo is empty)
The state is Unknown if the link is down or not connected to a UDLD-capable device. The state is Bidirectional if the link has a normal two-way connection to a UDLD-capable device. All other states indicate miswiring.
- ◆ **Message Interval** – The interval between UDLD probe messages used for the indicated operational state.
- ◆ **Detection Interval** – The period the switch remains in detection state after discovering a neighbor.

Web Interface

To enable UDLD and aggressive mode:

1. Click **Administration > UDLD > Configure Interface**.
2. Enable UDLD and aggressive mode on the required ports.
3. Click **Apply**.

Port	UDLD	Aggressive Mode	Operation State	Port State	Message Interval (seconds)	Detection Interval (seconds)
1	<input checked="" type="checkbox"/> Enabled	<input checked="" type="checkbox"/> Enabled	Disabled	Unknown	7	5
2	<input checked="" type="checkbox"/> Enabled	<input checked="" type="checkbox"/> Enabled	Disabled	Unknown	7	5
3	<input checked="" type="checkbox"/> Enabled	<input checked="" type="checkbox"/> Enabled	Disabled	Unknown	7	5
4	<input checked="" type="checkbox"/> Enabled	<input checked="" type="checkbox"/> Enabled	Disabled	Unknown	7	5
5	<input checked="" type="checkbox"/> Enabled	<input checked="" type="checkbox"/> Enabled	Disabled	Unknown	7	5

Displaying UDLD Neighbor Information

Use the Administration > UDLD (Show Information) page to show UDLD neighbor information, including neighbor state, expiration time, and protocol intervals.

Parameters

These parameters are displayed:

- ♦ **Port** – Port identifier. (Range: 1-28/52)
- ♦ **Entry** – Table entry number uniquely identifying the neighbor device discovered by UDLD on a port interface.
- ♦ **Device ID** – Device identifier of neighbor sending the UDLD packet.
- ♦ **Port ID** – The physical port the UDLD packet is sent from.
- ♦ **Device Name** – The device name of this neighbor.
- ♦ **Neighbor State** – Link status of neighbor device (Values: unknown, neighborsEchoIsEmpty, bidirectional, mismatchWithneighborStateReported, unidirectional).
- ♦ **Expire** – The amount of time remaining before this entry will expire.
- ♦ **Message Interval** – The interval between UDLD probe messages for ports in advertisement phase.
- ♦ **Detection Interval** – The period the switch remains in detection state after discovering a neighbor.

Web Interface

To display UDLD neighbor information:

1. Click **Administration > UDLD > Show Information**.
2. Select an interface from the Port list.

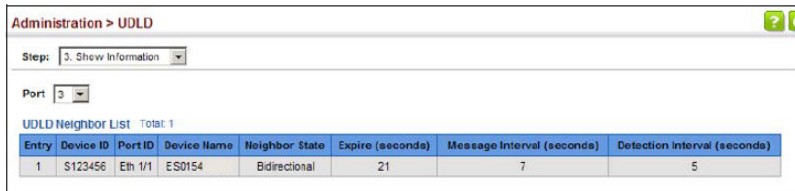

The screenshot shows a web interface titled "Administration > UDLD". It includes a "Step:" dropdown menu set to "3. Show Information" and a "Port:" dropdown menu set to "3". Below these is a table titled "UDLD Neighbor List" with a "Total: 1" indicator. The table has the following columns: Entry, Device ID, Port ID, Device Name, Neighbor State, Expire (seconds), Message Interval (seconds), and Detection Interval (seconds). The table contains one row of data.

Entry	Device ID	Port ID	Device Name	Neighbor State	Expire (seconds)	Message Interval (seconds)	Detection Interval (seconds)
1	S123456	Eth 1/1	ES0154	Bidirectional	21	7	5

Loopback Detection (LBD)

The switch can be configured to detect general loopback conditions caused by hardware problems or faulty protocol settings. When loopback detection (LBD) is enabled, a control frame is transmitted on the participating ports, and the switch monitors inbound traffic to see if the frame is looped back.

Usage Guidelines

- ◆ The default settings for the control frame transmit interval and recover time may be adjusted to improve performance for your specific environment. The shutdown mode may also need to be changed once you determine what kind of packets are being looped back.
- ◆ When a loopback event is detected on an interface or when an interface is released from a shutdown state caused by a loopback event, a trap message is sent and the event recorded in the system log.
- ◆ Loopback detection must be enabled both globally and on an interface for loopback detection to take effect.

Configuring Global Settings for LBD

Use the Administration > LBD (Configure Global) page to enable loopback detection globally, specify the interval at which to transmit control frames, the interval to wait before releasing an interface from shutdown state, the response to a detected loopback, and the traps to send.

Parameters

These parameters are displayed:

- ◆ **Global Status** – Enables loopback detection globally on the switch. (Default: Enabled)
- ◆ **Transmit Interval** – Specifies the interval at which to transmit loopback detection control frames. (Range: 1-32767 seconds; Default: 10 seconds)
- ◆ **Recover Time** – Specifies the interval to wait before the switch automatically releases an interface from shutdown state. (Range: 60-1,000,000 seconds; Default: 60 seconds)

If the recover time is not enabled (checkbox unmarked), all ports placed in shutdown state can be restored to operation using the Release button. To restore a specific port, re-enable Admin status on the Configure Interface page.

The recover-time is the maximum time when recovery is triggered after a loop is detected. The actual interval between recovery and detection will be less than or equal to the recover-time.

- ◆ **Action** – Specifies the protective action the switch takes when a loopback condition is detected. (Options: Block, None, Shutdown; Default: Shutdown)
 - ◆ **Block** – When the response to a detected loopback condition is set to block user traffic, and a loopback is detected on a port which a member of a specific VLAN, packets belonging to that VLAN are dropped at the offending port. Under these conditions, loopback detection control frames may be untagged or tagged depending on the port's VLAN membership type. Ingress filtering for the port is enabled automatically if not already enabled by other commands. The port's original setting for ingress filtering will be restored when loopback detection is disabled.
 - ◆ **None** - No action is taken.
 - ◆ **Shutdown** – When the response to a detected loopback condition is set to shut down a port, and a port receives a control frame sent by itself, this means that the port is in looped state, and the VLAN in the frame payload is also in looped state with the wrong VLAN tag. The looped port is therefore shut down.

When the loopback detection response is changed, any ports placed in shutdown state by the loopback detection process will be immediately restored to operation regardless of the remaining recover time.
- ◆ **Trap** – Sends a trap when a loopback condition is detected, or when the switch recovers from a loopback condition. (Options: Both, Detect, None, Recover; Default: None)
 - ◆ **Both** – Sends an SNMP trap message when a loopback condition is detected, or when the switch recovers from a loopback condition.
 - ◆ **Detect** – Sends an SNMP trap message when a loopback condition is detected.
 - ◆ **None** – Does not send an SNMP trap for loopback detection or recovery.
 - ◆ **Recover** – Sends an SNMP trap message when the switch recovers from a loopback condition.
- ◆ **Release** – Releases all interfaces currently shut down by the loopback detection feature.

Web Interface

To configure global settings for LBD:

1. Click **Administration > LBD > Configure Global**.
2. Make the required configuration changes.
3. Click **Apply**.

Administration > LBD

Step: 1. Configure Global ▼

Global Status Enabled

Transmit Interval (1-32767) sec

Recover Time (60-1000000) sec

Action ▼

Trap ▼

Click this button to release all looped ports manually

Configuring Interface Settings for LBD

Use the Administration > LBD (Configure Interface) page to enable loopback detection on an interface, to display the loopback operational state, and the VLANs that are looped back.

Parameters

These parameters are displayed:

- ♦ **Interface** – Displays a list of ports or trunks.
 - ♦ **Port** – Port Identifier. (Range: 1-28/54)
 - ♦ **Trunk** – Trunk Identifier. (Range: 1-28)
- ♦ **Admin State** – Manually enables or disables an interface. (Default: Enabled)
- ♦ **Operation State** – Valid states include Normal or Looped.
- ♦ **Looped VLAN** – Shows the VLANs that are in a looped state.

Web Interface

To configure interface settings for LBD:

1. Click **Administration > LBD > Configure Interface**.
2. Make the required configuration changes.
3. Click **Apply**.

Administration > LBD ?

Step: 2. Configure Interface ▼

Interface Port Trunk

Port List Total 28 1 2 3

Port	Admin State	Operation State	Looped VLAN
1	<input checked="" type="checkbox"/> Enabled	Normal	None
2	<input checked="" type="checkbox"/> Enabled	Normal	None
3	<input checked="" type="checkbox"/> Enabled	Normal	None
4	<input checked="" type="checkbox"/> Enabled	Normal	None
5	<input checked="" type="checkbox"/> Enabled	Normal	None

Smart Pair Configuration

A Smart Pair consists of two ports which are paired to provide layer 2 link redundancy. The pair consists of a primary port and a backup port. All traffic is forwarded through the primary port and the backup port will be set to standby. If the primary port link goes down, the backup port is activated and all traffic is forwarded through it. If the primary port recovers, all traffic will again be forwarded through the primary port after a configured delay (wait-to-restore delay).

Under the Administration > Smart Pair menus you can configure the Smart Pair ports and set the wait to restore delay for a globally configured Smart Pair. Additionally you can show the Smart Pairs configured on the switch and in the show menu restore traffic manually to a configured Smart Pair.

Usage Guidelines

- ◆ Spanning-Tree must be disabled on the port in order to configure it as part of a Smart Pair.
- ◆ A configured backup port can only be a member of a single Smart Pair.
- ◆ Dynamic trunk ports cannot be configured as a Smart Pair port (only static trunk ports).
- ◆ When a trunk group is identified as a backup port of a Smart Pair, any members removed from the trunk group will not retain the Smart Pair settings.
- ◆ When all members of trunk group set as a backup port are removed, the backup port is also removed.
- ◆ The VLAN mode of the backup port should not be changed after it is configured otherwise the behavior becomes unpredictable.

Configuring the Smart Pair Global Settings

Use the Administration > Smart Pair (Configure Global) page to create a Smart Pair ID. The Smart pair ID will be used to specify two ports that are the primary and secondary members of the Smart Pair.

Parameters

These parameters are displayed:

- ◆ **Smart Pair ID** – Specifies a Smart Pair on the switch. (Default: None, Range: 1-1000 IDs can be specified.)

Web Interface

To configure global settings for a Smart Pair:

1. Click **Administration > Smart Pair > Configure Global**.
2. Select Add from the Action menu.
3. Enter an ID in the Smart Pair ID field.
4. Click **Apply**.

The screenshot shows a web interface window titled "Administration > Smart Pair". At the top, there are two dropdown menus: "Step: 1. Configure Global" and "Action: Add". Below these is a text input field labeled "Smart Pair ID (1-1000)". At the bottom right of the window, there are two buttons: "Apply" and "Revert".

Configuring Smart Pair Interface Settings

Use the Administration > Smart Pair (Configure Smart Pair Global) to add the port members of a Smart Pair. The ports must have spanning tree turned off to be available for selection.

Parameters

These parameters are displayed:

- ◆ **ID** – Selects the Smart Pair ID for configuration of its ports and wait-to-restore delay timer.
- ◆ **Primary Port** – Displays a list of Ethernet ports for selection as the primary port of a Smart Pair.
 - ◆ **Port** – Ethernet port Identifier. (Range: 1-28/54)
- ◆ **Backup Port** – Displays a list of Ethernet ports for selection as the backup port of a Smart Pair.
 - ◆ **Port** – Ethernet port Identifier. (Range: 1-28/54)
- ◆ **WTR Delay** Sets the wait-to-restore delay for a Smart Pair in seconds (Default: 30 seconds, Range: 0, 5-3600)

Web Interface

To configure the interface settings for a Smart Pair:

1. Click **Administration > Smart Pair > Configure Smart Pair**.
2. Select Configure from the Action menu.

3. Select the ID of the Smart Pair to be configured from the ID pull down-menu.
4. Select the Smart Pair primary port from the Primary Port pull-down menu and check the box in front of the port ID.
5. Select the Smart Pair Backup Port from the Primary Port pull-down menu and check the box in front of the port ID.
6. Input the WTR delay time in seconds and check the box in front of the field.
7. Click **Apply**.

Administration > Smart Pair

Step: 2. Configure Smart Pair Action: Configure

ID: 1

Primary Port: [dropdown]

Backup Port: [dropdown]

WTR Delay: 30 seconds

Apply Revert

Show the Configured Smart Pair IDs

Use the Administration > Smart Pair (Configure Global) to show the configured Smart Pair IDs.

Web Interface

To show the configured Smart Pair IDs.

1. Click **Administration > Smart Pair > Configure Global**.
2. Select Show from the Action menu.

Administration > Smart Pair

Step: 1. Configure Global Action: Show

Smart Pair ID List Total: 1

ID
1

Delete Revert

Display the Configured Smart Pair Port Members and Restore the Traffic

Use the Administration > Smart Pair (Configure Smart Pair Global) to display the port members of a Smart Pair.

Web Interface

To configure the interface settings for a Smart Pair:

1. Click **Administration > Smart Pair > Configure Smart Pair**.
2. Select Configure from the Show menu.
3. Select the Smart Pair ID from the ID pull-down menu.
4. Click the Restore button to manually restore traffic to the primary port of a specified Smart Pair.

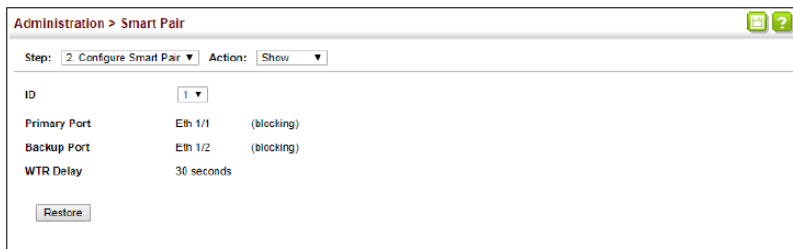

The screenshot shows a web interface window titled "Administration > Smart Pair". At the top right, there are icons for help and search. Below the title bar, there is a "Step:" dropdown menu set to "2. Configure Smart Pair" and an "Action:" dropdown menu set to "Show". The main content area displays the following configuration details:

ID	1
Primary Port	Eth 1/1 (blocking)
Backup Port	Eth 1/2 (blocking)
WTR Delay	30 seconds

At the bottom of the configuration area, there is a "Restore" button.

This Page Intentionally Left Blank

Chapter 16

Multicast Filtering

Overview

This chapter describes how to configure the following multicast services:

- ♦ *IGMP Snooping* – Configures snooping and query parameters.
- ♦ *IGMP Filtering and Throttling* – Filters specified multicast service, or throttles the maximum of multicast groups allowed on an interface.
- ♦ *MLD Snooping* – Configures snooping and query parameters for IPv6.
- ♦ *MLD Filtering and Throttling* – Filters specified multicast service, or throttles the maximum of multicast groups allowed on an interface.
- ♦ *Filtering MLD Query Packets on an Interface* – Configures the interface to drop MLD query packets.
- ♦ *Multicast VLAN Registration for IPv4* – Configures a single network-wide multicast VLAN shared by hosts residing in other standard or private VLAN groups, preserving security and data isolation.

Multicasting is used to support real-time applications such as video conferencing or streaming audio. A multicast server does not have to establish a separate connection with each client. It merely broadcasts its service to the network, and any hosts that want to receive the multicast register with their local multicast switch/router. Although this approach reduces the network overhead required by a multicast server, the broadcast traffic must be carefully pruned at every multicast switch/router it passes through to ensure that traffic is only passed on to the hosts which subscribed to this service.

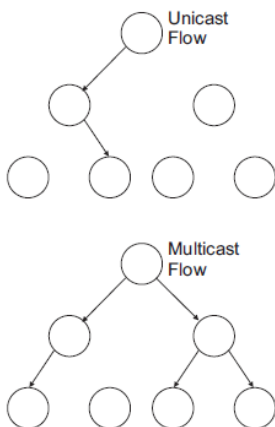

This switch can use Internet Group Management Protocol (IGMP) to filter multicast traffic. IGMP Snooping can be used to passively monitor or “snoop” on exchanges between attached hosts and an IGMP-enabled device, most commonly a multicast router. In this way, the switch can discover the ports that want to join a multicast group, and set its filters accordingly.

If there is no multicast router attached to the local subnet, multicast traffic and query messages may not be received by the switch. In this case (Layer 2) IGMP Query can be used to actively ask the attached hosts if they want to receive a specific multicast service. IGMP Query thereby identifies the ports containing hosts requesting to join the service and sends data out to those ports only. It then propagates the service request up to any neighboring multicast switch/router to ensure that it will continue to receive the multicast service.

The purpose of IP multicast filtering is to optimize a switched network’s performance, so multicast packets will only be forwarded to those ports containing multicast group hosts or multicast routers/switches, instead of flooding traffic to all ports in the subnet (VLAN).

IGMP Snooping

IGMP Snooping and Query – If multicast routing is not supported on other switches in your network, you can use IGMP Snooping and IGMP Query to monitor IGMP service requests passing between multicast clients and servers, and dynamically configure the switch ports which need to forward multicast traffic. IGMP Snooping conserves bandwidth on network segments where no node has expressed interest in receiving a specific multicast service. For switches that do not support multicast routing, or where multicast routing is already enabled on other switches in the local network segment, IGMP Snooping is the only service required to support multicast filtering.

When using IGMPv3 snooping, service requests from IGMP Version 1, 2 or 3 hosts are all forwarded to the upstream router as IGMPv3 reports. The primary enhancement provided by IGMPv3 snooping is in keeping track of information about the specific multicast sources which downstream IGMPv3 hosts have requested or refused. The switch maintains information about both multicast groups and channels, where a group indicates a multicast flow for which the hosts have *not* requested a specific source (the only option for IGMPv1 and v2 hosts unless statically configured on the switch), and a channel indicates a flow for which the hosts have requested service from a specific source. For IGMPv1/v2 hosts, the source address of a channel is always null (indicating that any source is acceptable), but for IGMPv3 hosts, it may include a specific address when requested.

Only IGMPv3 hosts can request service from a specific multicast source. When downstream hosts request service from a specific source for a multicast service, these sources are all placed in the Include list, and traffic is forwarded to the hosts from each of these sources. IGMPv3 hosts may also request that service be forwarded from any source except for those specified. In this case, traffic is filtered from sources in the Exclude list, and forwarded from all other available sources.

Note:

- ◆ When the switch is configured to use IGMPv3 snooping, the snooping version may be downgraded to version 2 or version 1, depending on the version of the IGMP query packets detected on each VLAN.
- ◆ IGMP snooping will not function unless a multicast router port is enabled on the switch. This can be accomplished in one of two ways. A static router port can be manually configured. Using this method, the router port is never timed out, and will continue to function until explicitly removed. The other method relies on the switch to dynamically create multicast

routing ports whenever multicast routing protocol packets or IGMP query packets are detected on a port.

- ◆ A maximum of up to 1023 multicast entries can be maintained for IGMP snooping. Once the table is full, no new entries are learned. Any subsequent multicast traffic not found in the table is dropped if unregistered-flooding is disabled (default behavior) and no router port is configured in the attached VLAN, or flooded throughout the VLAN if unregistered-flooding is enabled.

Static IGMP Router Interface – If IGMP snooping cannot locate the IGMP querier, you can manually designate a known IGMP querier (i.e., a multicast router/switch) connected over the network to an interface on your switch. This interface will then join all the current multicast groups supported by the attached router/switch to ensure that multicast traffic is passed to all appropriate interfaces within the switch.

Static IGMP Host Interface – For multicast applications that you need to control more carefully, you can manually assign a multicast service to specific interfaces on the switch.

IGMP Snooping with Proxy Reporting – The switch supports last leave, and query suppression (as defined in DSL Forum TR-101, April 2006):

- ◆ When proxy reporting is disabled, all IGMP reports received by the switch are forwarded natively to the upstream multicast routers.
- ◆ Last Leave: Intercepts, absorbs and summarizes IGMP leaves coming from IGMP hosts. IGMP leaves are relayed upstream only when necessary, that is, when the last user leaves a multicast group.
- ◆ Query Suppression: Intercepts and processes IGMP queries in such a way that IGMP specific queries are never sent to client ports.

The only deviation from TR-101 is that the marking of IGMP traffic initiated by the switch with priority bits as defined in R-250 is not supported.

Configuring IGMP Snooping and Query Parameters

Use the Multicast > IGMP Snooping > General page to configure the switch to forward multicast traffic intelligently. Based on the IGMP query and report messages, the switch forwards multicast traffic only to the ports that request it. This prevents the switch from broadcasting the traffic to all ports and possibly disrupting network performance.

Command Usage

- ◆ **IGMP Snooping** – This switch can passively snoop on IGMP Query and Report packets transferred between IP multicast routers/switches and IP multicast host groups to identify the IP multicast group members. It simply monitors the IGMP packets passing through it, picks out the group registration information, and configures the multicast filters accordingly.

Note: If unknown multicast traffic enters a VLAN which has been configured with a router port, the traffic is forwarded to that port. However, if no router port exists on the VLAN, the traffic is dropped if unregistered data flooding is disabled (default behavior), or flooded throughout the VLAN if unregistered data flooding is enabled (see “Unregistered Data Flooding” in the Command Attributes section).

- ◆ **IGMP Querier** – A router, or multicast-enabled switch, can periodically ask their hosts if they want to receive multicast traffic. If there is more than one router/switch on the LAN performing IP multicasting, one of these devices is elected “querier” and assumes the role of querying the LAN for group members. It then propagates the service requests on to any upstream multicast switch/router to ensure that it will continue to receive the multicast service.

Note: Multicast routers use this information from IGMP snooping and query reports, along with a multicast routing protocol such as DVMRP or PIM, to support IP multicasting across the Internet.

Parameters

These parameters are displayed:

- ◆ **IGMP Snooping Status** – When enabled, the switch will monitor network traffic to determine which hosts want to receive multicast traffic. This is referred to as IGMP Snooping. (Default: Enabled)
When IGMP snooping is enabled globally, the per VLAN interface settings for IGMP snooping take precedence.
When IGMP snooping is disabled globally, snooping can still be configured per VLAN interface, but the interface settings will not take effect until snooping is re-enabled globally.
- ◆ **Proxy Reporting Status** – Enables IGMP Snooping with Proxy Reporting. (Default: Disabled)

When proxy reporting is enabled with this command, the switch performs “IGMP Snooping with Proxy Reporting” (as defined in DSL Forum TR-101, April 2006), including last leave, and query suppression.

Last leave sends out a proxy query when the last member leaves a multicast group, and query suppression means that specific queries are not forwarded from an upstream multicast router to hosts downstream from this device.

When proxy reporting is disabled, all IGMP reports received by the switch are forwarded natively to the upstream multicast routers.

- ◆ **TCN Flood** – Enables flooding of multicast traffic if a spanning tree topology change notification (TCN) occurs. (Default: Disabled)

When a spanning tree topology change occurs, the multicast membership information learned by switch may be out of date. For example, a host linked to one port before the topology change (TC) may be moved to another port after the change. To ensure that multicast data is delivered to all receivers, by default, a switch in a VLAN (with IGMP snooping enabled) that receives a Bridge Protocol Data Unit (BPDU) with TC bit set (by the root bridge) will enter into “multicast flooding mode” for a period of time until the topology has stabilized and the new locations of all multicast receivers are learned.

If a topology change notification (TCN) is received, and all the uplink ports are subsequently deleted, a time out mechanism is used to delete all of the currently learned multicast channels.

When a new uplink port starts up, the switch sends unsolicited reports for all currently learned channels out the new uplink port.

By default, the switch immediately enters into “multicast flooding mode” when a spanning tree topology change occurs. In this mode, multicast traffic will be flooded to all VLAN ports. If many ports have subscribed to different multicast groups, flooding may cause excessive packet loss on the link between the switch and the end host. Flooding may be disabled to avoid this, causing multicast traffic to be delivered only to those ports on which multicast group members have been learned. Otherwise, the time spent in flooding mode can be manually configured to reduce excessive loading.

When the spanning tree topology changes, the root bridge sends a proxy query to quickly re-learn the host membership/port relations for multicast channels. The root bridge also sends an unsolicited Multicast Router Discover (MRD) request to quickly locate the multicast routers in this VLAN.

The proxy query and unsolicited MRD request are flooded to all VLAN ports except for the receiving port when the switch receives such packets.

- ◆ **TCN Query Solicit** – Sends out an IGMP general query solicitation when a spanning tree topology change notification (TCN) occurs. (Default: Disabled)

When the root bridge in a spanning tree receives a TCN for a VLAN where IGMP snooping is enabled, it issues a global IGMP leave message (or query solicitation). When a switch receives this solicitation, it floods it to all ports in the VLAN where the spanning tree change occurred. When an upstream multicast router receives this solicitation, it immediately issues an IGMP general query.

A query solicitation can be sent whenever the switch notices a topology change, even if it is not the root bridge in spanning tree.

- ◆ **Router Alert Option** – Discards any IGMPv2/v3 packets that do not include the Router Alert option. (Default: Disabled)

As described in Section 9.1 of RFC 3376 for IGMP Version 3, the Router Alert Option can be used to protect against DOS attacks. One common method of attack is launched by an intruder who takes over the role of querier, and starts overloading multicast hosts by sending a large number of group-and-source-specific queries, each with a large source list and the Maximum Response Time set to a large value.

To protect against this kind of attack, (1) routers should not forward queries. This is easier to accomplish if the query carries the Router Alert option. (2) Also, when the switch is acting in the role of a multicast host (such as when using proxy routing), it should ignore version 2 or 3 queries that do not contain the Router Alert option.

- ◆ **Unregistered Data Flooding** – Floods unregistered multicast traffic into the attached VLAN. (Default: Enabled)

Once the table used to store multicast entries for IGMP snooping and multicast routing is filled, no new entries are learned. If no router port is configured in the attached VLAN, and unregistered-flooding is disabled, any subsequent multicast traffic not found in the table is dropped, otherwise it is flooded throughout the VLAN.

- ◆ **Version Exclusive** – Discards any received IGMP messages which use a version different to that currently configured by the IGMP Version attribute. (Default: Disabled)
- ◆ **IGMP Unsolicited Report Interval** – Specifies how often the upstream interface should transmit unsolicited IGMP reports when proxy reporting is enabled. (Range: 1-65535 seconds, Default: 400 seconds)

When a new upstream interface (that is, uplink port) starts up, the switch sends unsolicited reports for all currently learned multicast channels via the new upstream interface.

This command only applies when proxy reporting is enabled.

- ◆ **Router Port Expire Time** – The time the switch waits after the previous querier stops before it considers it to have expired. (Range: 1-65535, Recommended Range: 300-500 seconds, Default: 300)

- ◆ **IGMP Snooping Version** – Sets the protocol version for compatibility with other devices on the network. This is the IGMP Version the switch uses to send snooping reports. (Range: 1-3; Default: 2)

This attribute configures the IGMP report/query version used by IGMP snooping. Versions 1 - 3 are all supported, and versions 2 and 3 are backward compatible, so the switch can operate with other devices, regardless of the snooping version employed.

- ◆ **Querier Status** – When enabled, the switch can serve as the Querier, which is responsible for asking hosts if they want to receive multicast traffic. This feature is not supported for IGMPv3 snooping. (Default: Enabled)
- ◆ **Router Port Mode** – Configures multicast router ports to forward multicast streams only when multicast groups are joined. (Options: Forward, Dynamic; Default: Forward)
- ◆ **Report Suppression** – Enables report suppression on VLANs, which intercepts, absorbs and summarizes IGMP reports coming from downstream hosts. All multicast group membership states are included in a single proxy report, thereby limiting the amount of IGMP traffic sent to neighboring multicast routers. (Default: Disabled)

Web Interface

To configure general settings for IGMP Snooping and Query:

1. Click **Multicast > IGMP Snooping > General**.
2. Adjust the IGMP settings as required.
3. Click **Apply**.

Multicast > IGMP Snooping > General	
IGMP Snooping Status	<input type="checkbox"/> Enabled
Proxy Reporting Status	<input type="checkbox"/> Enabled
TCN Flood	<input type="checkbox"/> Enabled
TCN Query Solicit	<input type="checkbox"/> Enabled
Router Alert Option	<input type="checkbox"/> Enabled
Unregistered Data Flooding	<input type="checkbox"/> Enabled
Version Exclusive	<input type="checkbox"/> Enabled
IGMP Unsolicited Report Interval (1-65535)	<input type="text" value="400"/> seconds
Router Port Expire Time (1-65535)	<input type="text" value="300"/> seconds
IGMP Snooping Version (1-3)	<input type="text" value="2"/>
Querier Status	<input type="checkbox"/> Enabled
Router Port Mode	<input type="button" value="Forward"/> ▾
Report Suppression	<input type="checkbox"/> Enabled
<input type="button" value="Apply"/> <input type="button" value="Revert"/>	

Specifying Static Interfaces for a Multicast Router

Use the Multicast > IGMP Snooping > Multicast Router (Add Static Multicast Router) page to statically attach an interface to a multicast router/switch.

Depending on network connections, IGMP snooping may not always be able to locate the IGMP querier. Therefore, if the IGMP querier is a known multicast router/switch connected over the network to an interface (port or trunk) on the switch, the interface (and a specified VLAN) can be manually configured to join all the current multicast groups supported by the attached router. This can ensure that multicast traffic is passed to all the appropriate interfaces within the switch.

Command Usage

IGMP Snooping must be enabled globally on the switch before a multicast router port can take effect.

Parameters

These parameters are displayed:

Add Static Multicast Router

- ◆ **VLAN** – Selects the VLAN which is to propagate all multicast traffic coming from the attached multicast router. (Range: 1-4094)
- ◆ **Interface** – Activates the Port or Trunk scroll down list.
- ◆ **Port or Trunk** – Specifies the interface attached to a multicast router.

Show Static Multicast Router

- ♦ **VLAN** – Selects the VLAN for which to display any configured static multicast routers.
- ♦ **Interface** – Shows the interface to which the specified static multicast routers are attached.

Show Current Multicast Router

- ♦ **VLAN** – Selects the VLAN for which to display any currently active multicast routers.
- ♦ **Interface** – Shows the interface to which an active multicast router is attached.
- ♦ **Type** – Shows if this entry is static or dynamic.
- ♦ **Expire** – Time until this dynamic entry expires.

Web Interface

To specify a static interface attached to a multicast router:

1. Click **Multicast > IGMP Snooping > Multicast Router**.
2. Select Add Static Multicast Router from the Action list.
3. Select the VLAN which will forward all the corresponding multicast traffic, and select the port or trunk attached to the multicast router.
4. Click **Apply**.

The screenshot shows a web interface window titled "Multicast > IGMP Snooping > Multicast Router". Below the title bar, there is an "Action:" dropdown menu set to "Add Static Multicast Router". Underneath, there are two rows of configuration options. The first row is labeled "VLAN" and has a dropdown menu with "1" selected. The second row is labeled "Interface" and has two radio buttons: "Port" (which is selected) and "Trunk". Next to the "Port" radio button is a dropdown menu with "1" selected. At the bottom right of the form, there are two buttons: "Apply" and "Revert".

To show the static interfaces attached to a multicast router:

1. Click **Multicast > IGMP Snooping > Multicast Router**.
2. Select Show Static Multicast Router from the Action list.
3. Select the VLAN for which to display this information.

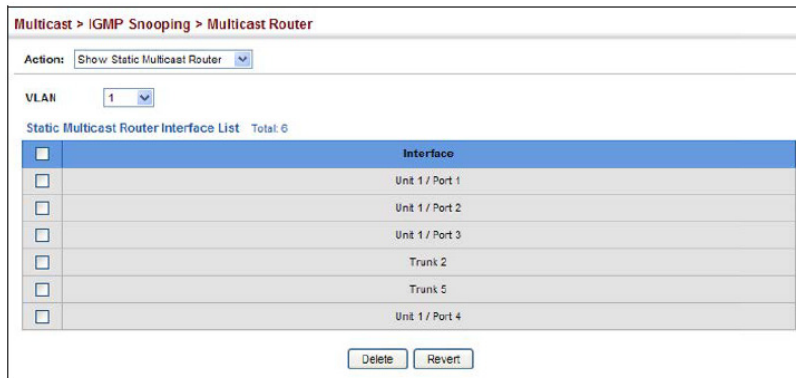

Multicast routers that are attached to ports on the switch use information obtained from IGMP, along with a multicast routing protocol (such as PIM) to support IP multicasting across the Internet. These routers may be dynamically discovered by the switch or statically assigned to an interface on the switch.

To show the all interfaces attached to a multicast router:

1. Click **Multicast > IGMP Snooping > Multicast Router**.
2. Select Current Multicast Router from the Action list.
3. Select the VLAN for which to display this information. Ports in the selected VLAN which are attached to a neighboring multicast router/switch are displayed.

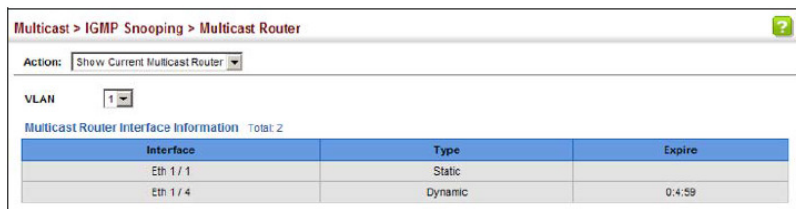

Assigning Interfaces to Multicast Services

Use the Multicast > IGMP Snooping > IGMP Member (Add Static Member) page to statically assign a multicast service to an interface.

Multicast filtering can be dynamically configured using IGMP Snooping and IGMP Query messages. However, for certain applications that require tighter control, it may be necessary to statically configure a multicast service on the switch. First add all the ports attached to participating hosts to a common VLAN, and then assign the multicast service to that VLAN group.

Command Usage

- ◆ Static multicast addresses are never aged out.
- ◆ When a multicast address is assigned to an interface in a specific VLAN, the corresponding traffic can only be forwarded to ports within that VLAN.

Parameters

These parameters are displayed:

- ◆ **VLAN** – Specifies the VLAN which is to propagate the multicast service. (Range: 1-4094)
- ◆ **Interface** – Activates the Port or Trunk scroll down list.
- ◆ **Port or Trunk** – Specifies the interface assigned to a multicast group.
- ◆ **Multicast IP** – The IP address for a specific multicast service.

Web Interface

To statically assign an interface to a multicast service:

1. Click **Multicast > IGMP Snooping > IGMP Member**.
2. Select Add Static Member from the Action list.
3. Select the VLAN that will propagate the multicast service, specify the interface attached to a multicast service (through an IGMP-enabled switch or multicast router), and enter the multicast IP address.
4. Click **Apply**.

The screenshot shows the web interface for configuring a static multicast member. The breadcrumb navigation is "Multicast > IGMP Snooping > IGMP Member". The "Action:" dropdown menu is set to "Add Static Member". The "VLAN" field is a dropdown menu with "1" selected. The "Interface" field has two radio buttons: "Port" (selected) and "Trunk". The "Port" dropdown menu has "1" selected, and the "Trunk" dropdown menu also has "1" selected. The "Multicast IP" field is a text input box containing "224.1.1.1". At the bottom right, there are two buttons: "Apply" and "Revert".

To show the static interfaces assigned to a multicast service:

1. Click **Multicast > IGMP Snooping > IGMP Member**.

2. Select Show Static Member from the Action list.
3. Select the VLAN for which to display this information.

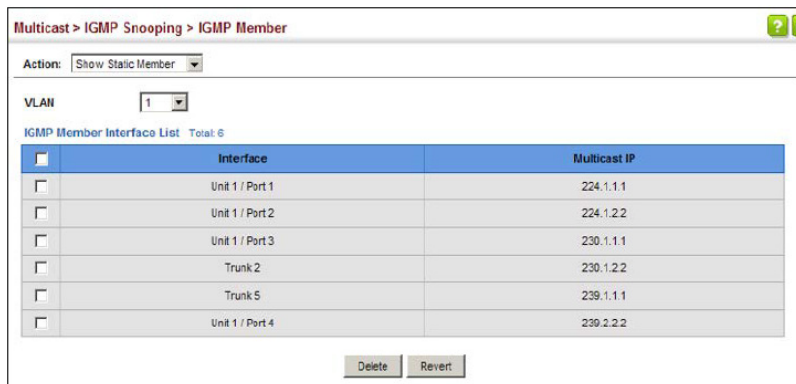

Setting IGMP Snooping Status per Interface

Use the Multicast > IGMP Snooping > Interface (Configure VLAN) page to configure IGMP snooping attributes for a VLAN. To configure snooping globally, refer to Configuring IGMP Snooping and Query Parameters.

Command Usage

Multicast Router Discovery

There have been many mechanisms used in the past to identify multicast routers. This has led to interoperability issues between multicast routers and snooping switches from different vendors. In response to this problem, the Multicast Router Discovery (MRD) protocol has been developed for use by IGMP snooping and multicast routing devices. MRD is used to discover which interfaces are attached to multicast routers, allowing IGMP-enabled devices to determine where to send multicast source and group membership messages. (MRD is specified in draft-ietf-magma-mrdisc-07.)

Multicast source data and group membership reports must be received by all multicast routers on a segment. Using the group membership protocol query messages to discover multicast routers is insufficient due to query suppression. MRD therefore provides a standardized way to identify multicast routers without relying on any particular multicast routing protocol.

Note: The default values recommended in the MRD draft are implemented in the switch.

Multicast Router Discovery uses the following three message types to discover multicast routers:

- ◆ Multicast Router Advertisement – Advertisements are sent by routers to advertise that IP multicast forwarding is enabled. These messages are sent unsolicited periodically on all router interfaces on which multicast forwarding is enabled. They are sent upon the occurrence of these events:
 - ◆ Upon the expiration of a periodic (randomized) timer.
 - ◆ As a part of a router's start up procedure.
 - ◆ During the restart of a multicast forwarding interface.
 - ◆ On receipt of a Solicitation message.
- ◆ Multicast Router Solicitation – Devices send Solicitation messages in order to solicit Advertisement messages from multicast routers. These messages are used to discover multicast routers on a directly attached link. Solicitation messages are also sent whenever a multicast forwarding interface is initialized or re-initialized. Upon receiving a solicitation on an interface with IP multicast forwarding and MRD enabled, a router will respond with an Advertisement.
- ◆ Multicast Router Termination – These messages are sent when a router stops IP multicast routing functions on an interface. Termination messages are sent by multicast routers when:
 - ◆ Multicast forwarding is disabled on an interface.
 - ◆ An interface is administratively disabled.
 - ◆ The router is gracefully shut down.

Advertisement and Termination messages are sent to the All-Snoopers multicast address. Solicitation messages are sent to the All-Routers multicast address.

Note: MRD messages are flooded to all ports in a VLAN where IGMP snooping or routing has been enabled. To ensure that older switches which do not support MRD can also learn the multicast router port, the switch floods IGMP general query packets, which do not have a null source address (0.0.0.0), to all ports in the attached VLAN. IGMP packets with a null source address are only flooded to all ports in the VLAN if the system is operating in multicast flooding mode, such as when a new VLAN or new router port is being established, or a spanning tree topology change has occurred. Otherwise, this kind of packet is only forwarded to known multicast routing ports.

Parameters

These parameters are displayed:

- ♦ **VLAN** – ID of configured VLANs. (Range: 1-4094)
- ♦ **IGMP Snooping Status** – When enabled, the switch will monitor network traffic on the indicated VLAN interface to determine which hosts want to receive multicast traffic. This is referred to as IGMP Snooping. (Default: Enabled)

When IGMP snooping is enabled globally, the per VLAN interface settings for IGMP snooping take precedence.

When IGMP snooping is enabled globally, snooping can still be configured per VLAN interface, but the interface settings will not take effect until snooping is re-disabled globally.

- ♦ **Version Exclusive** – Discards any received IGMP messages (except for multicast protocol packets) which use a version different to that currently configured by the IGMP Version attribute. (Options: Enabled, Using Global Status; Default: Using Global Status)

If version exclusive is disabled on a VLAN, then this setting is based on the global setting configured on the Multicast > IGMP Snooping > General page. If it is enabled on a VLAN, then this setting takes precedence over the global setting.

- ♦ **Immediate Leave Status** – Immediately deletes a member port of a multicast service if a leave packet is received at that port and immediate leave is enabled for the parent VLAN. (Default: Disabled)

If immediate leave is not used, a multicast router (or querier) will send a group-specific query message when an IGMPv2 group leave message is received. The router/querier stops forwarding traffic for that group only if no host replies to the query within the specified time out period. Note that this time out is set to Last Member Query Interval * Robustness Variable (fixed at 2) as defined in RFC 2236.

If immediate leave is enabled, the switch assumes that only one host is connected to the interface. Therefore, immediate leave should only be enabled on an interface if it is connected to only one IGMP-enabled device, either a service host or a neighbor running IGMP snooping.

This attribute is only effective if IGMP snooping is enabled, and IGMPv2 or IGMPv3 snooping is used.

If immediate leave is enabled, the following options are provided:

- ♦ **By Group** – The switch assumes that only one host is connected to the interface. Therefore, immediate leave should only be enabled on an

interface if it is connected to only one IGMP-enabled device, either a service host or a neighbor running IGMP snooping.

- ◆ **By Host IP** – The switch will not send out a group-specific query when an IGMPv2/v3 leave message is received. But will check if there are other hosts joining the multicast group. Only when all hosts on that port leave the group will the member port be deleted.
- ◆ **Multicast Router Discovery** – MRD is used to discover which interfaces are attached to multicast routers. (Default: Disabled)
- ◆ **General Query Suppression** – Suppresses general queries except for ports attached to downstream multicast hosts. (Default: Disabled)
By default, general query messages are flooded to all ports, except for the multicast router through which they are received.

If general query suppression is enabled, then these messages are forwarded only to downstream ports which have joined a multicast service.

- ◆ **Proxy Reporting** – Enables IGMP Snooping with Proxy Reporting. (Options: Enabled, Disabled, Using Global Status; Default: Using Global Status)

When proxy reporting is enabled with this command, the switch performs “IGMP Snooping with Proxy Reporting” (as defined in DSL Forum TR-101, April 2006), including last leave, and query suppression.

Last leave sends out a proxy query when the last member leaves a multicast group, and query suppression means that specific queries are not forwarded from an upstream multicast router to hosts downstream from this device.

Rules Used for Proxy Reporting

When IGMP Proxy Reporting is disabled, the switch will use a null IP address for the source of IGMP query and report messages unless a proxy query address has been set.

When IGMP Proxy Reporting is enabled, the source address is based on the following criteria:

- ◆ If a proxy query address is configured, the switch will use that address as the source IP address in general and group-specific query messages sent to downstream hosts, and in report and leave messages sent upstream from the multicast router port.
- ◆ If a proxy query address is not configured, the switch will use the VLAN’s IP address as the IP source address in general and group-specific query messages sent downstream, and use the source address

of the last IGMP message received from a downstream host in report and leave messages sent upstream from the multicast router port.

- ♦ **Interface Version** – Sets the protocol version for compatibility with other devices on the network. This is the IGMP Version the switch uses to send snooping reports. (Options: 1-3, Using Global Version; Default: Using Global Version)

This attribute configures the IGMP report/query version used by IGMP snooping. Versions 1 - 3 are all supported, and versions 2 and 3 are backward compatible, so the switch can operate with other devices, regardless of the snooping version employed.

- ♦ **Query Interval** – The interval between sending IGMP general queries. (Range: 2-31744 seconds; Default: 125 seconds)

An IGMP general query message is sent by the switch at the interval specified by this attribute. When this message is received by downstream hosts, all receivers build an IGMP report for the multicast groups they have joined.

This attribute applies when the switch is serving as the querier, or as a proxy host when IGMP snooping proxy reporting is enabled.

- ♦ **Query Response Interval** – The maximum time the system waits for a response to general queries. (Range: 10-31740 tenths of a second in multiples of 10; Default: 100 seconds)

This attribute applies when the switch is serving as the querier, or as a proxy host when IGMP snooping proxy reporting is enabled.

- ♦ **Last Member Query Interval** – The interval to wait for a response to a group-specific or group-and-source-specific query message. (Range: 1-31744 tenths of a second in multiples of 10; Default: 10 seconds)

When a multicast host leaves a group, it sends an IGMP leave message. When the leave message is received by the switch, it checks to see if this host is the last to leave the group by sending out an IGMP group-specific or group-and-source-specific query message, and starts a timer. If no reports are received before the timer expires, the group record is deleted, and a report is sent to the upstream multicast router.

A reduced value will result in reduced time to detect the loss of the last member of a group or source, but may generate more burst traffic.

This attribute will take effect only if IGMP snooping proxy reporting is enabled or IGMP querier is enabled.

- ♦ **Last Member Query Count** – The number of IGMP proxy group-specific or group-and-source-specific query messages that are sent out before the

system assumes there are no more local members. (Range: 1-255; Default: 2)

This attribute will take effect only if IGMP snooping proxy reporting or IGMP querier is enabled.

- ◆ **Proxy Query Address** – A static source address for locally generated query and report messages used by IGMP Proxy Reporting. (Range: Any valid IP unicast address; Default: 0.0.0.0)

IGMP Snooping uses a null IP address of 0.0.0.0 for the source of IGMP query messages which are proxied to downstream hosts to indicate that it is not the elected querier, but is only proxying these messages as defined in RFC 4541. The switch also uses a null address in IGMP reports sent to upstream ports.

Many hosts do not implement RFC 4541, and therefore do not understand query messages with the source address of 0.0.0.0. These hosts will therefore not reply to the queries, causing the multicast router to stop sending traffic to them.

To resolve this problem, the source address in proxied IGMP query messages can be replaced with any valid unicast address (other than the router's own address).

- ◆ **Report Suppression** – Enables report suppression on the VLAN, which intercepts, absorbs and summarizes IGMP reports coming from downstream hosts. All multicast group membership states are included in a single proxy report, thereby limiting the amount of IGMP traffic sent to neighboring multicast routers. (Default: Disabled)

Web Interface

To configure IGMP snooping on a VLAN:

1. Click **Multicast > IGMP Snooping > Interface**.
2. Select Configure VLAN from the Action list.
3. Select the VLAN to configure and update the required parameters.
4. Click **Apply**.

Multicast > IGMP Snooping > Interface

Action: Configure VLAN

VLAN: 1

IGMP Snooping Status: Enabled

Version Exclusive: Using Global Status

Immediate Leave Status: Enabled By-Group

Multicast Router Discovery: Enabled

General Query Suppression: Enabled

Proxy Reporting: Using Global Status

Interface Version: Using Global Version

Query Interval (2-31744): 125 seconds

Query Response Interval (10-31740): 100 (1/10 seconds, multiple of 10)

Last Member Query Interval (1-31744): 10 (1/10 seconds, multiple of 10)

Last Member Query Count (1-255): 2

Proxy (Query) Address: 0.0.0.0

Report Suppression: Enabled

Apply Revert

To show the interface settings for IGMP snooping:

1. Click **Multicast > IGMP Snooping > Interface**.
2. Select Show VLAN Information from the Action list.

Multicast > IGMP Snooping > Interface

Action: Show VLAN Information

IGMP Snooping VLAN List Total: 5

VLAN	IGMP Snooping Status	Immediate Leave Status	Query Interval	Query Response Interval	Last Member Query Interval	Last Member Query Count	Proxy (Query) Address	Proxy Reporting	Multicast Router Discovery	General Query Suppression	Version Exclusive	Interface Version	Report Suppression
1	Disabled	Disabled	125	100	10	2	0.0.0.0	Using global status (Disabled)	Disabled	Disabled	Using global status (Disabled)	Using global version (2)	Disabled

Filtering IGMP Packets on an Interface

Use the Multicast > IGMP Snooping > Interface (Configure Interface) page to configure an interface to drop IGMP query packets or multicast data packets, or enable IGMP authentication.

Parameters

These parameters are displayed:

- ◆ **Interface** – Port or Trunk identifier.
- ◆ **IGMP Query Drop** – Configures an interface to drop any IGMP query packets received on the specified interface. If this switch is acting as a

Querier, this prevents it from being affected by messages received from another Querier.

- ◆ **Multicast Data Drop** – Configures an interface to stop multicast services from being forwarded to users attached to the downstream port (i.e., the interfaces specified by this command).
- ◆ **IGMP Authentication** – Enables IGMP authentication on the specified interface. When enabled and an IGMP JOIN request is received, an authentication request is sent to a configured RADIUS server.

Web Interface

To drop IGMP query packets or multicast data packets:

1. Click **Multicast > IGMP Snooping > Interface**.
2. Select Configure Interface from the Action list.
3. Select Port or Trunk interface.
4. Enable the required drop functions for any interface.
5. Click **Apply**.

Port	IGMP Query Drop	Multicast Data Drop	IGMP Authentication
1	<input type="checkbox"/> Enabled	<input type="checkbox"/> Enabled	<input type="checkbox"/> Enabled
2	<input type="checkbox"/> Enabled	<input type="checkbox"/> Enabled	<input type="checkbox"/> Enabled
3	<input type="checkbox"/> Enabled	<input type="checkbox"/> Enabled	<input type="checkbox"/> Enabled
4	<input type="checkbox"/> Enabled	<input type="checkbox"/> Enabled	<input type="checkbox"/> Enabled
5	<input type="checkbox"/> Enabled	<input type="checkbox"/> Enabled	<input type="checkbox"/> Enabled

Displaying Multicast Groups Discovered by IGMP Snooping

Use the Multicast > IGMP Snooping > Forwarding Entry page to display the forwarding entries learned through IGMP Snooping.

Command Usage

To display information about multicast groups, IGMP Snooping must first be enabled on the switch.

Parameters

These parameters are displayed:

- ◆ **VLAN** – An interface on the switch that is forwarding traffic to downstream ports for the specified multicast group address.
- ◆ **Group Address** – IP multicast group address with subscribers directly attached or downstream from the switch, or a static multicast group assigned to this interface.
- ◆ **Interface** – A downstream port or trunk that is receiving traffic for the specified multicast group. This field may include both dynamically and statically configured multicast router ports.
- ◆ **Up Time** – Time that this multicast group has been known.
- ◆ **Expire** – Time until this entry expires.
- ◆ **Count** – The number of times this address has been learned by IGMP snooping.

Web Interface

To show multicast groups learned through IGMP snooping:

1. Click **Multicast > IGMP Snooping > Forwarding Entry**.

Displaying IGMP Snooping Statistics

Use the Multicast > IGMP Snooping > Statistics pages to display IGMP snooping protocol-related statistics for the specified interface. There are four Action pages with separate statistics:

- ◆ Show Query Statistics
- ◆ Show VLAN Statistics
- ◆ Show Port Statistics
- ◆ Show Trunk Statistics

Statistic Pages

These parameters are displayed:

Show VLAN Statistics

- ♦ **VLAN** – VLAN identifier. (Range: 1-4094)
- ♦ **Port** – Port identifier. (Range: 1-28/54)
- ♦ **Trunk** – Trunk identifier. (Range: 1-28)

Query Statistics

- ♦ **Other Querier** – IP address of remote querier on this interface.
- ♦ **Other Querier Expire** – Time after which remote querier is assumed to have expired.
- ♦ **Other Querier Uptime** – Time remote querier has been up.
- ♦ **Self Querier** – IP address of local querier on this interface.
- ♦ **Self Querier Expire** – Time after which local querier is assumed to have expired.
- ♦ **Self Querier Uptime** – Time local querier has been up.
- ♦ **General Query Received** – The number of general queries received on this interface.
- ♦ **General Query Sent** – The number of general queries sent from this interface.
- ♦ **Specific Query Received** – The number of specific queries received on this interface.
- ♦ **Specific Query Sent** – The number of specific queries sent from this interface.
- ♦ **Warn Rate Limit** – The rate at which received query messages of the wrong version type cause the Vx warning count to increment. Note that “0 sec” means that the Vx warning count is incremented for each wrong message version received.
- ♦ **V1 Warning Count** – The number of times the query version received (Version 1) does not match the version configured for this interface.
- ♦ **V2 Warning Count** – The number of times the query version received (Version 2) does not match the version configured for this interface.
- ♦ **V3 Warning Count** – The number of times the query version received (Version 3) does not match the version configured for this interface.

VLAN, Port, and Trunk Statistics

Input Statistics

- ♦ **Report** – The number of IGMP membership reports received on this interface.
- ♦ **Leave** – The number of leave messages received on this interface.
- ♦ **G Query** – The number of general query messages received on this interface.
- ♦ **G(-S)-S Query** – The number of group specific or group-and-source specific query messages received on this interface.
- ♦ **Drop** – The number of times a report, leave or query was dropped. Packets may be dropped due to invalid format, rate limiting, packet content not allowed, or IGMP group report received.
- ♦ **Join Success** – The number of times a multicast group was successfully joined.
- ♦ **Group** – The number of IGMP groups active on this interface.

Output Statistics

- ♦ **Report** – The number of IGMP membership reports sent from this interface.
- ♦ **Leave** – The number of leave messages sent from this interface.
- ♦ **G Query** – The number of general query messages sent from this interface.
- ♦ **G(-S)-S Query** – The number of group specific or group-and-source specific query messages sent from this interface.

Web Interface

To display statistics for IGMP snooping query-related messages:

1. Click **Multicast > IGMP Snooping > Statistics**.
2. Select Show Query Statistics from the Action list.
3. Select a VLAN.

Action: Show Query Statistics

VLAN: 1

Query Statistics

Other Querier	None
Other Querier Expire	00(m):00(s)
Other Querier Uptime	00(h):00(m):00(s)
Self Querier	192.168.1.1
Self Querier Expire	00(m):00(s)
Self Querier Uptime	00(h):00(m):00(s)
General Query Received	0
General Query Sent	0
Specific Query Received	0
Specific Query Sent	0
Warn Rate Limit	0 sec.
V1 Warning Count	0
V2 Warning Count	0
V3 Warning Count	0

Clear All [Click this button to clear all IGMP Snooping statistics.](#)

Refresh

To display IGMP snooping protocol-related statistics for a VLAN:

1. Click **Multicast > IGMP Snooping > Statistics**.
2. Select Show VLAN Statistics from the Action list.
3. Select a VLAN.

Multicast > IGMP Snooping > Statistics

Action: Show VLAN Statistics

VLAN: 1

Input Statistics

Report	0	Drop	0
Leave	0	Join Success	0
G Query	0	Group	0
G(-S)-S Query	0		

Output Statistics

Report	0
Leave	0
G Query	0
G(-S)-S Query	0

Clear Refresh

To display IGMP snooping protocol-related statistics for a port:

1. Click **Multicast > IGMP Snooping > Statistics**.
2. Select Show Port Statistics from the Action list.
3. Select a Port.

The screenshot shows the 'Multicast > IGMP Snooping > Statistics' page. The 'Action' dropdown is set to 'Show Port Statistics'. A 'Port' dropdown menu is set to '1'. The page displays two sections: 'Input Statistics' and 'Output Statistics'. Each section contains a table of statistics with values of 0.

Input Statistics			
Report	0	Drop	0
Leave	0	Join Success	0
G Query	0	Group	0
G(-S)-S Query	0		

Output Statistics			
Report	0		
Leave	0		
G Query	0		
G(-S)-S Query	0		

A 'Refresh' button is located at the bottom right of the page.

To display IGMP snooping protocol-related statistics for a trunk:

1. Click **Multicast > IGMP Snooping > Statistics**.
2. Select Show Trunk Statistics from the Action list.
3. Select a Trunk.

The screenshot shows the 'Multicast > IGMP Snooping > Statistics' page. The 'Action' dropdown is set to 'Show Trunk Statistics'. A 'Trunk' dropdown menu is set to '1'. The page displays two sections: 'Input Statistics' and 'Output Statistics'. Each section contains a table of statistics with values of 0.

Input Statistics			
Report	0	Drop	0
Leave	0	Join Success	0
G Query	0	Group	0
G(-S)-S Query	0		

Output Statistics			
Report	0	Drop	0
Leave	0	Group	0
G Query	0		
G(-S)-S Query	0		

'Clear' and 'Refresh' buttons are located at the bottom right of the page.

IGMP Filtering and Throttling

In certain switch applications, the administrator may want to control the multicast services that are available to end users. For example, an IP/TV service based on a specific subscription plan. The IGMP filtering feature fulfills this requirement by restricting access to specified multicast services on a switch port, and IGMP throttling limits the number of simultaneous multicast groups a port can join.

IGMP filtering enables you to assign a profile to a switch port that specifies multicast groups that are permitted or denied on the port. An IGMP filter profile can contain one or more addresses, or a range of multicast addresses; but only one profile can be assigned to a port. When enabled, IGMP join reports received on the port are checked against the filter profile. If a requested multicast group is permitted, the IGMP join report is forwarded as normal. If a requested multicast group is denied, the IGMP join report is dropped.

IGMP throttling sets a maximum number of multicast groups that a port can join at the same time. When the maximum number of groups is reached on a port, the switch can take one of two actions; either “deny” or “replace.” If the action is set to deny, any new IGMP join reports will be dropped. If the action is set to replace, the switch randomly removes an existing group and replaces it with the new multicast group.

Enabling IGMP Filtering and Throttling

Use the Multicast > IGMP Snooping > Filter (Configure General) page to enable IGMP filtering and throttling globally on the switch.

Parameters

These parameters are displayed:

- ♦ **IGMP Filter Status** – Enables IGMP filtering and throttling globally for the switch. (Default: Enabled)

Web Interface

To enable IGMP filtering and throttling on the switch:

1. Click **Multicast > IGMP Snooping > Filter**.
2. Select Configure General from the Step list.
3. Enable IGMP Filter Status.
4. Click **Apply**.

Configuring IGMP Filter Profiles

Use the Multicast > IGMP Snooping > Filter (Configure Profile – Add) page to create an IGMP profile and set its access mode. Then use the (Add Multicast Group Range) page to configure the multicast groups to filter.

Command Usage

Specify a range of multicast groups by entering a start and end IP address; or specify a single multicast group by entering the same IP address for the start and end of the range.

Parameters

These parameters are displayed:

Add

- ◆ **Profile ID** – Creates an IGMP profile. (Range: 1-4294967295)
- ◆ **Access Mode** – Sets the access mode of the profile; either permit or deny. (Default: Deny)

When the access mode is set to permit, IGMP join reports are processed when a multicast group falls within the controlled range. When the access mode is set to deny, IGMP join reports are only processed when the multicast group is not in the controlled range.

Add Multicast Group Range

- ◆ **Profile ID** – Selects an IGMP profile to configure.
- ◆ **Start Multicast IP Address** – Specifies the starting address of a range of multicast groups.
- ◆ **End Multicast IP Address** – Specifies the ending address of a range of multicast groups.

Web Interface

To create an IGMP filter profile and set its access mode:

1. Click **Multicast > IGMP Snooping > Filter**.
2. Select Configure Profile from the Step list.
3. Select Add from the Action list.
4. Enter the number for a profile, and set its access mode.
5. Click **Apply**.

Multicast > IGMP Snooping > Filter

Step: 2. Configure Profile Action: Add

Profile ID (1-4294967295) 19

Access Mode Permit

Apply Revert

To show the IGMP filter profiles:

1. Click **Multicast > IGMP Snooping > Filter**.
2. Select Configure Profile from the Step list.
3. Select Show from the Action list.

Multicast > IGMP Snooping > Filter

Step: 2. Configure Profile Action: Show

IGMP Snooping Filter Profile List Total 1

	Profile ID	Action Mode
<input type="checkbox"/>	19	Permit

Delete Revert

To add a range of multicast groups to an IGMP filter profile:

1. Click **Multicast > IGMP Snooping > Filter**.
2. Select Configure Profile from the Step list.
3. Select Add Multicast Group Range from the Action list.
4. Select the profile to configure, and add a multicast group address or range of addresses.
5. Click **Apply**.

Multicast > IGMP Snooping > Filter

Step: 2. Configure Profile Action: Add Multicast Group Range

Profile ID: 19

Start Multicast IP Address: 239.2.3.1

End Multicast IP Address: 239.2.3.200

Apply Revert

To show the multicast groups configured for an IGMP filter profile:

1. Click **Multicast > IGMP Snooping > Filter**.
2. Select Configure Profile from the Step list.
3. Select Show Multicast Group Range from the Action list.
4. Select the profile for which to display this information.

Multicast > IGMP Snooping > Filter

Step: 2. Configure Profile Action: Show Multicast Group Range

Profile ID: 19

Multicast IP Address Range List Total: 1

<input type="checkbox"/>	Start Multicast IP Address	End Multicast IP Address
<input type="checkbox"/>	239.2.3.1	239.2.3.200

Delete Revert

Configuring IGMP Filtering and Throttling for Interfaces

Use the Multicast > IGMP Snooping > Filter (Configure Interface) page to assign an IGMP filter profile to interfaces on the switch, or to throttle multicast traffic by limiting the maximum number of multicast groups an interface can join at the same time.

Command Usage

- ◆ IGMP throttling sets a maximum number of multicast groups that a port can join at the same time. When the maximum number of groups is reached on a port, the switch can take one of two actions; either “deny” or “replace.” If the action is set to deny, any new IGMP join reports will be dropped. If the action is set to replace, the switch randomly removes an existing group and replaces it with the new multicast group.

Parameters

These parameters are displayed:

- ◆ **Interface** – Port or trunk identifier.
An IGMP profile or throttling setting can be applied to a port or trunk. When ports are configured as trunk members, the trunk uses the settings applied to the first port member in the trunk.
- ◆ **Profile ID** – Selects an existing profile to assign to an interface.
- ◆ **Max Multicast Groups** – Sets the maximum number of multicast groups an interface can join at the same time. (Range: 1-1024; Default: 1024)
- ◆ **Current Multicast Groups** – Displays the current multicast groups the interface has joined.
- ◆ **Throttling Action Mode** – Sets the action to take when the maximum number of multicast groups for the interface has been exceeded. (Default: Deny)
 - ◆ **Deny** - The new multicast group join report is dropped.
 - ◆ **Replace** - The new multicast group replaces an existing group.
- ◆ **Throttling Status** – Indicates if the throttling action has been implemented on the interface. (Options: True or False)

Web Interface

To configure IGMP filtering or throttling for a port or trunk:

1. Click **Multicast > IGMP Snooping > Filter**.
2. Select Configure Interface from the Step list.
3. Select a profile to assign to an interface, then set the maximum number of allowed multicast groups and the throttling response.
4. Click **Apply**.

Multicast > IGMP Snooping > Filter

Step: 3. Configure interface

Interface: Port Trunk

IGMP Filter and Throttling Port List Total: 28

Port	Profile ID	Max Multicast Groups (1-1024)	Current Multicast Groups	Throttling Action Mode	Throttling Status
1	<input type="text" value=""/>	<input type="text" value="1024"/>	0	Deny <input type="text" value=""/>	False
2	<input type="text" value=""/>	<input type="text" value="1024"/>	0	Deny <input type="text" value=""/>	False
3	<input type="text" value=""/>	<input type="text" value="1024"/>	0	Deny <input type="text" value=""/>	False
4	<input type="text" value=""/>	<input type="text" value="1024"/>	0	Deny <input type="text" value=""/>	False
5	<input type="text" value=""/>	<input type="text" value="1024"/>	0	Deny <input type="text" value=""/>	False

MLD Snooping

Multicast Listener Discovery (MLD) snooping operates on IPv6 traffic and performs a similar function to IGMP snooping for IPv4. That is, MLD snooping dynamically configures switch ports to limit IPv6 multicast traffic so that it is forwarded only to ports with users that want to receive it. This reduces the flooding of IPv6 multicast packets in the specified VLANs.

There are two versions of the MLD protocol, version 1 and version 2. MLDv1 control packets include Listener Query, Listener Report, and Listener Done messages (equivalent to IGMPv2 query, report, and leave messages). MLDv2 control packets include MLDv2 query and report messages, as well as MLDv1 report and done messages.

Remember that IGMP Snooping and MLD Snooping are independent functions, and can therefore both function at the same time.

Configuring MLD Snooping and Query Parameters

Use the Multicast > MLD Snooping > General page to configure the switch to forward multicast traffic intelligently. Based on the MLD query and report messages, the switch forwards multicast traffic only to the ports that request it. This prevents the switch from broadcasting the traffic to all ports and possibly disrupting network performance.

Parameters

These parameters are displayed:

- ◆ **MLD Snooping Status** – When enabled, the switch will monitor network traffic to determine which hosts want to receive multicast traffic. (Default: Disabled)
- ◆ **Querier Status** – When enabled, the switch can serve as the querier for MLDv2 snooping if elected. The querier is responsible for asking hosts if they want to receive multicast traffic. (Default: Disabled)

An IPv6 address must be configured on the VLAN interface from which the querier will act if elected. When serving as the querier, the switch uses this IPv6 address as the query source address.

The querier will not start or will disable itself after having started if it detects an IPv6 multicast router on the network.

- ◆ **Robustness** – MLD Snooping robustness variable. A port will be removed from the receiver list for a multicast service when no MLD reports are detected in response to a number of MLD queries. The robustness variable

sets the number of queries on ports for which there is no report. (Range: 2-10 Default: 2)

- ◆ **Query Interval** – The interval between sending MLD general queries. (Range: 60-125 seconds; Default: 125 seconds)

This attribute applies when the switch is serving as the querier.

An MLD general query message is sent by the switch at the interval specified by this attribute. When this message is received by downstream hosts, all receivers build an MLD report for the multicast groups they have joined.

- ◆ **Query Max Response Time** – The maximum response time advertised in MLD general queries. (Range: 5-25 seconds; Default: 10 seconds)

This attribute controls how long the host has to respond to an MLD Query message before the switch deletes the group if it is the last member.

- ◆ **Router Port Expiry Time** – The time the switch waits after the previous querier stops before it considers the router port (i.e., the interface that had been receiving query packets) to have expired. (Range: 300-500 seconds; Default: 300 seconds)

- ◆ **MLD Snooping Version** – The protocol version used for compatibility with other devices on the network. This is the MLD version the switch uses to send snooping reports. (Range: 1-2; Default: 1)

- ◆ **Unknown Multicast Mode** – The action for dealing with unknown multicast packets. Options include:

- ◆ **Flood** – Floods any received IPv6 multicast packets that have not been requested by a host to all ports in the VLAN.
- ◆ **To Router Port** – Forwards any received IPv6 multicast packets that have not been requested by a host to ports that are connected to a detected multicast router. (This is the default action.)

- ◆ **Proxy Reporting** – Enables MLD Snooping with Proxy Reporting. (Default: Disabled)

When proxy reporting is enabled, reports received from downstream hosts are summarized and used to build internal membership states. Proxy-reporting devices may use the all-zeros IP source address when forwarding any summarized reports upstream. For this reason, IGMP membership reports received by the snooping switch must not be rejected because the source IP address is set to 0.0.0.0.

- ◆ **Unsolicited Report Interval** – Specifies how often the upstream interface should transmit unsolicited MLD snooping reports when proxy reporting is enabled. (Default: 400 seconds)

Web Interface

To configure general settings for MLD Snooping:

1. Click **Multicast > MLD Snooping > General**.
2. Adjust the settings as required.
3. Click **Apply**.

Multicast > MLD Snooping > General

MLD Snooping Status	<input checked="" type="checkbox"/> Enabled
Querier Status	<input checked="" type="checkbox"/> Enabled
Robustness (2-10)	<input type="text" value="2"/>
Query Interval (60-125)	<input type="text" value="125"/> seconds
Query Max Response Time (5-25)	<input type="text" value="10"/> seconds
Router Port Expiry Time (300-500)	<input type="text" value="300"/> seconds
MLD Snooping Version (1-2)	<input type="text" value="2"/>
Unknown Multicast Mode	<input type="text" value="To Router Port"/> ▼
Proxy Reporting	<input checked="" type="checkbox"/> Enabled
Unsolicited Report Interval (1-65535)	<input type="text" value="400"/> seconds

Setting Immediate Leave Status for MLD Snooping per Interface

Use the Multicast > MLD Snooping > Interface page to configure Immediate Leave status for a VLAN.

Parameters

These parameters are displayed:

- ♦ **VLAN** – A VLAN identification number. (Range: 1-4094)
- ♦ **Immediate Leave** – Immediately deletes a member port of an IPv6 multicast service when a leave packet is received at that port and immediate leave is enabled for the parent VLAN. (Default: Disabled)

If MLD immediate-leave is *not* used, a multicast router (or querier) will send a group-specific query message when an MLD group leave message is received. The router/querier stops forwarding traffic for that group only if no host replies to the query within the specified timeout period.

If MLD immediate-leave is enabled, the switch assumes that only one host is connected to the interface. Therefore, immediate leave should only be enabled on an interface if it is connected to only one MLD-enabled device, either a service host or a neighbor running MLD snooping.

- ◆ **Immediate Leave By Host** – Specifies that the member port will be deleted only when there are no hosts joining this group.

If the “By Host” option is used, the router/querier will not send out a group-specific query when an MLD leave message is received. But will check if there are other hosts joining the multicast group. Only when all hosts on that port leave the group will the member port be deleted.

Web Interface

To configure immediate leave for MLD Snooping:

1. Click **Multicast > MLD Snooping > Interface**.
2. Select a VLAN, and set the status for immediate leave.
3. Click **Apply**.

Multicast > MLD Snooping > Interface

VLAN

Immediate Leave Enabled

Immediate Leave By Host Enabled

Specifying Static Interfaces for an IPv6 Multicast Router

Use the Multicast > MLD Snooping > Multicast Router (Add Static Multicast Router) page to statically attach an interface to an IPv6 multicast router/switch.

Depending on your network connections, MLD snooping may not always be able to locate the MLD querier. Therefore, if the MLD querier is a known multicast router/switch connected over the network to an interface (port or trunk) on the switch, you can manually configure that interface to join all the current multicast groups.

Command Usage

MLD Snooping must be enabled globally on the switch before a multicast router port can take effect.

Parameters

These parameters are displayed:

- ◆ **VLAN** – Selects the VLAN which is to propagate all IPv6 multicast traffic coming from the attached multicast router. (Range: 1-4094)

- ◆ **Interface** – Activates the Port or Trunk scroll down list.
- ◆ **Port or Trunk** – Specifies the interface attached to a multicast router.

Web Interface

To specify a static interface attached to a multicast router:

1. Click **Multicast > MLD Snooping > Multicast Router**.
2. Select Add Static Multicast Router from the Action list.
3. Select the VLAN which will forward all the corresponding IPv6 multicast traffic, and select the port or trunk attached to the multicast router.
4. Click **Apply**.

The screenshot shows the web interface for adding a static multicast router. The breadcrumb path is "Multicast > MLD Snooping > Multicast Router". The "Action" dropdown is set to "Add Static Multicast Router". The "VLAN" dropdown is set to "1". The "Interface" section has radio buttons for "Port" and "Trunk", with "Port" selected and a dropdown set to "1". There are "Apply" and "Revert" buttons at the bottom right.

To show the static interfaces attached to a multicast router:

1. Click **Multicast > MLD Snooping > Multicast Router**.
2. Select Show Static Multicast Router from the Action list.
3. Select the VLAN for which to display this information.

The screenshot shows the web interface for showing static multicast router interface lists. The breadcrumb path is "Multicast > MLD Snooping > Multicast Router". The "Action" dropdown is set to "Shew Static Multicast Router". The "VLAN" dropdown is set to "1". Below the dropdowns, the text "Static Multicast Router Interface List Total 2" is displayed. A table with two columns, "Interface" and "Unit", is shown. The table has two rows: "Unit 1 / Port 1" and "Unit 1 / Port 2". There are "Delete" and "Revert" buttons at the bottom right.

	Interface
<input type="checkbox"/>	Unit 1 / Port 1
<input type="checkbox"/>	Unit 1 / Port 2

To show all the interfaces attached to a multicast router:

1. Click **Multicast > MLD Snooping > Multicast Router**.
2. Select Current Multicast Router from the Action list.
3. Select the VLAN for which to display this information. Ports in the selected VLAN which are attached to a neighboring multicast router/switch are displayed.

Multicast Router Interface Information Total: 4	
Interface	Type
Unit 1 / Port 4	Static
Unit 1 / Port 5	Dynamic
Trunk 2	Dynamic
Trunk 3	Dynamic

Assigning Interfaces to IPv6 Multicast Services

Use the Multicast > MLD Snooping > MLD Member (Add Static Member) page to statically assign an IPv6 multicast service to an interface.

Multicast filtering can be dynamically configured using MLD snooping and query messages. However, for certain applications that require tighter control, it may be necessary to statically configure a multicast service on the switch. First add all the ports attached to participating hosts to a common VLAN, and then assign the multicast service to that VLAN group.

Command Usage

- Static multicast addresses are never aged out.
- When a multicast address is assigned to an interface in a specific VLAN, the corresponding traffic can only be forwarded to ports within that VLAN.

Parameters

These parameters are displayed:

- **VLAN** – Specifies the VLAN which is to propagate the multicast service. (Range: 1-4094)
- **Multicast IPv6 Address** – The IP address for a specific multicast service.
- **Interface** – Activates the Port or Trunk scroll down list.
- **Port** or **Trunk** – Specifies the interface assigned to a multicast group.
- **Type** (Show Current Member) – Shows if this multicast stream was statically configured by the user, discovered by MLD Snooping, or is a data stream to which no other ports are subscribing (i.e., the stream is flooded onto VLAN instead of being trapped to the CPU for processing, or is being processed by MVR6).

Web Interface

To statically assign an interface to an IPv6 multicast service:

1. Click **Multicast > MLD Snooping > MLD Member**.
2. Select Add Static Member from the Action list.
3. Select the VLAN that will propagate the multicast service, specify the interface attached to a multicast service (through an MLD-enabled switch or multicast router), and enter the multicast IP address.
4. Click **Apply**.

The screenshot shows the configuration page for MLD Member. The breadcrumb is "Multicast > MLD Snooping > MLD Member". The "Action" dropdown is set to "Add Static Member". The "VLAN" dropdown is set to "1". The "Multicast IPv6 Address" text box contains "FF00:0:0:0:0:10C". The "Interface" section has radio buttons for "Port" (selected) and "Trunk", with a dropdown menu set to "1". At the bottom right, there are "Apply" and "Revert" buttons.

To show the static interfaces assigned to an IPv6 multicast service:

1. Click **Multicast > MLD Snooping > MLD Member**.
2. Select Show Static Member from the Action list.
3. Select the VLAN for which to display this information.

The screenshot shows the configuration page for MLD Member with the "Action" dropdown set to "Show Static Member". The "VLAN" dropdown is set to "1". Below the form is a table titled "MLD Member Interface List" with a "Total: 8" count. The table has three columns: a checkbox, "Multicast IPv6 Address", and "Interface".

<input type="checkbox"/>	Multicast IPv6 Address	Interface
<input type="checkbox"/>	FF02:01:01:01:01	Unit 1 / Port 1
<input type="checkbox"/>	FF02:01:01:01:02	Unit 1 / Port 2
<input type="checkbox"/>	FF01:1	Unit 1 / Port 12
<input type="checkbox"/>	FF01:2	Unit 1 / Port 13
<input type="checkbox"/>	FF01:3	Unit 1 / Port 14
<input type="checkbox"/>	FF01:4	Unit 1 / Port 15
<input type="checkbox"/>	FF01:5	Unit 1 / Port 16
<input type="checkbox"/>	FF02:01:01:01:FF	Trunk 3

At the bottom of the table, there are "Delete" and "Revert" buttons.

To display information about all IPv6 multicast groups, MLD Snooping or multicast routing must first be enabled on the switch. To show all of the interfaces statically or dynamically assigned to an IPv6 multicast service:

1. Click **Multicast > MLD Snooping > MLD Member**.
2. Select Show Current Member from the Action list.
3. Select the VLAN for which to display this information.

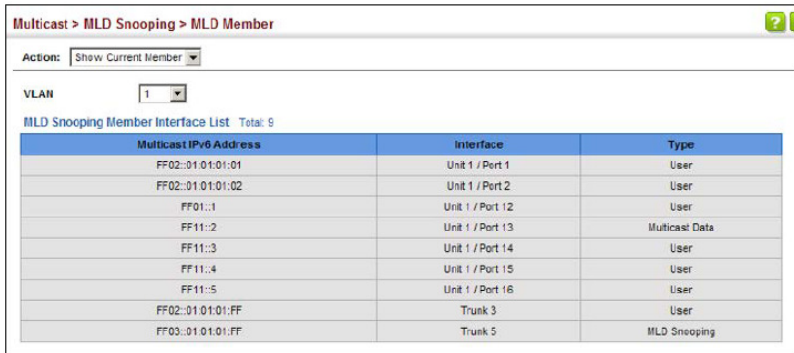

Multicast IPv6 Address	Interface	Type
FF02::01:01:01:01	Unit 1 / Port 1	User
FF02::01:01:01:02	Unit 1 / Port 2	User
FF01::1	Unit 1 / Port 12	User
FF11::2	Unit 1 / Port 13	Multicast Data
FF11::3	Unit 1 / Port 14	User
FF11::4	Unit 1 / Port 15	User
FF11::5	Unit 1 / Port 16	User
FF02::01:01:01:FF	Trunk 3	User
FF03::01:01:01:FF	Trunk 5	MLD Snooping

Filtering MLD Query Packets on an Interface

Use the Multicast > MLD Snooping > Query Drop page to configure an interface to drop MLDF query packets.

Parameters

These parameters are displayed:

- ♦ **Interface** – Port or trunk identifier.
- ♦ **Query Drop** – Drops any received MLD query packets. (Default: Disabled)

This feature can be used to drop any query packets received on the specified interface. If this switch is acting as a Querier, this prevents it from being affected by messages received from another Querier.

Web Interface

To drop IGMP query packets:

1. Click **Multicast > MLD Snooping > Query Drop**.
2. Select Port or Trunk interface.
3. Enable query drop for any interface.

4. Click **Apply**.

Port	Query Drop	Multicast Data Drop
1	<input type="checkbox"/> Enabled	<input type="checkbox"/> Enabled
2	<input type="checkbox"/> Enabled	<input type="checkbox"/> Enabled
3	<input type="checkbox"/> Enabled	<input type="checkbox"/> Enabled
4	<input type="checkbox"/> Enabled	<input type="checkbox"/> Enabled
5	<input type="checkbox"/> Enabled	<input type="checkbox"/> Enabled

Showing MLD Snooping Groups and Source List

Use the Multicast > MLD Snooping > Group Information page to display known multicast groups, member ports, the means by which each group was learned, and the corresponding source list.

Parameters

These parameters are displayed:

- ◆ **VLAN** – VLAN identifier. (Range: 1-4094)
- ◆ **Interface** – Port or trunk identifier.
- ◆ **Group Address** – The IP address for a specific multicast service.
- ◆ **Type** – The means by which each group was learned – MLD Snooping or Multicast Data.
- ◆ **Filter Mode** – The filter mode is used to summarize the total listening state of a multicast address to a minimum set such that all nodes' listening states are respected. In Include mode, the router only uses the request list, indicating that the reception of packets sent to the specified multicast address is requested only from those IP source addresses listed in the hosts' source-list. In Exclude mode, the router uses both the request list and exclude list, indicating that the reception of packets sent to the given multicast address is requested from all IP source addresses, except for those listed in the exclude source-list and for any other sources where the source timer status has expired.
- ◆ **Filter Timer Elapse** – The Filter timer is only used when a specific multicast address is in Exclude mode. It represents the time for the multicast address filter mode to expire and change to Include mode.
- ◆ **Request List** – Sources included on the router's request list.
- ◆ **Exclude List** – Sources included on the router's exclude list.

Web Interface

To display known MLD multicast groups:

1. Click **Multicast > MLD Snooping > Group Information**.
2. Select the port or trunk, and then select a multicast service assigned to that interface.

Multicast > MLD Snooping > Group Information

VLAN: 1

Interface: Port 1 (selected), Trunk 1

Group Address: FF02::01:01:01:01

Type: MLD Snooping

Filter Mode: Exclude

Filter Timer: 10 seconds

Elapse: 10 seconds

Request List Total: 3

IPv6 Address
::01:02:03:01
::01:02:03:02
::01:02:03:03

Exclude List Total: 3

IPv6 Address
::02:02:03:01
::02:02:03:02
::02:02:03:03

Displaying MLD Snooping Statistics

Use the **Multicast > IGMP Snooping > Statistics** pages to display MLD snooping protocol-related statistics.

Parameters

These parameters are displayed:

Input

- ♦ **Interface** – The unit/port or VLAN interface.
- ♦ **Report** – The number of MLD membership reports received on this interface.
- ♦ **Leave** – The number of leave messages received on this interface.
- ♦ **G Query** – The number of general query messages received on this interface.
- ♦ **G(-S)-S Query** – The number of group specific or group-and-source specific query messages received on this interface.

- ◆ **Drop** – The number of times a report, leave or query was dropped. Packets may be dropped due to invalid format, rate limiting, packet content not allowed, or MLD group report received.
- ◆ **Join Success** – The number of times a multicast group was successfully joined.
- ◆ **Group** – The number of MLD groups active on this interface.

Output

Same as input parameters listed above, except that the direction of transmission is outbound.

Query

- ◆ **Other Querier Address** – IP address of remote querier on this interface.
- ◆ **Other Querier Expire** – Time after which remote querier is assumed to have expired.
- ◆ **Other Querier Uptime** – Time remote querier has been up.
- ◆ **Self Querier Address** – IP address of local querier on this interface.
- ◆ **Self Querier Expire Time** – Time after which local querier is assumed to have expired.
- ◆ **Self Querier Uptime** – Time local querier has been up.
- ◆ **General Query Received** – The number of general queries received on this interface.
- ◆ **General Query Sent** – The number of general queries sent from this interface.
- ◆ **Specific Query Received** – The number of group specific queries received on this interface.
- ◆ **Specific Query Sent** – The number of group specific queries sent from this interface.

Summary

Physical Interface (Port/Trunk)

- ◆ **Number of Groups** – Number of active MLD groups active on the specified interface.
- ◆ *Querier*
 - ◆ *Transmit*
 - ◆ **General** – The number of general queries sent from this interface.
 - ◆ **Group Specific** – The number of group specific queries sent from this interface.
 - ◆ *Received*

- ◆ **General** – The number of general queries received on this interface.
- ◆ **Group Specific** – The number of group specific queries received on this interface.
- ◆ *Report & Leave*
 - ◆ *Transmit*
 - ◆ **Report** – The number of MLD membership reports sent from this interface.
 - ◆ **Leave** – The number of leave messages sent from this interface.
 - ◆ *Received*
 - ◆ **Report** – The number of MLD membership reports received on this interface.
 - ◆ **Leave** – The number of leave messages received on this interface.
 - ◆ **Join Success** – The number of times a multicast group was successfully joined.
 - ◆ **Filter Drop** – The number of messages dropped due to filter settings.
 - ◆ **Source Port Drop** – The number of dropped messages that are received on MVR source port or mrouter port.
 - ◆ **Others Drop** – The number of received invalid messages.

Logical Interface (VLAN) – The following parameters are included for a VLAN.

- ◆ **Number of Groups** – Number of active MLD groups active on the specified interface.
- ◆ *Querier*
 - ◆ **Other Querier** – IPv6 address of remote querier on this interface.
 - ◆ **Other Uptime** – Time remote querier has been up.
 - ◆ **Other Expire** – Time after which remote querier is assumed to have expired.
 - ◆ **Self Addr** – IPv6 address of local querier on this interface.
 - ◆ **Self Expire** – Time after which local querier is assumed to have expired.
 - ◆ **Self Uptime** – Time local querier has been up.
- ◆ *Transmit*
 - ◆ **General** – The number of general queries sent from this interface.
 - ◆ **Group Specific** – The number of group specific queries sent from this interface.
- ◆ *Received*

- ♦ **General** – The number of general queries received on this interface.
- ♦ **Group Specific** – The number of group specific queries received on this interface.
- ♦ *Report & Leave*
 - ♦ **Host Addr** – The link-local or global IPv6 address that is assigned on that VLAN.
 - ♦ **Unsolicit Expire** – The number of group leaves resulting from timeouts instead of explicit leave messages.
 - ♦ *Transmit*
 - ♦ **Report** – The number of MLD membership reports sent from this interface.
 - ♦ **Leave** – The number of leave messages sent from this interface.
 - ♦ *Received*
 - ♦ **Report** – The number of MLD membership reports received on this interface.
 - ♦ **Leave** – The number of leave messages received on this interface.

Clear

Parameters

These parameters are displayed:

- ♦ **All** – Clears statistics for all MLD messages.
- ♦ **VLAN** – VLAN identifier. (Range: 1-4094)
- ♦ **Unit** – Stack unit. (Range: 1)
- ♦ **Port** – Port identifier. (Range: 1-28/54)
- ♦ **Trunk** – Trunk identifier. (Range: 1-28)

Web Interface

To display MLD snooping input-related message statistics:

1. Click **Multicast > MLD Snooping > Statistics**.
2. Select Input.

Multicast > MLD Snooping > Statistics

Type Input Output Query Summary Clear

Input Statistics Total: 19

Interface	Report	Leave	G Query	G(-S)-S Query	Drop	Join Success	Group
Eth 1/1	0	0	0	0	0	0	0
Eth 1/2	0	0	0	0	0	0	0
Eth 1/3	0	0	0	0	0	0	0
Eth 1/4	0	0	0	0	0	0	0
Eth 1/5	0	0	0	0	0	0	0
Eth 1/6	0	0	0	0	0	0	0

To display MLD snooping output-related message statistics:

1. Click **Multicast > MLD Snooping > Statistics**.
2. Select Output.

Multicast > MLD Snooping > Statistics

Type Input Output Query Summary Clear

Output Statistics Total: 19

Interface	Report	Leave	G Query	G(-S)-S Query	Drop	Group
Eth 1/1	0	0	0	0	0	0
Eth 1/2	0	0	0	0	0	0
Eth 1/3	0	0	0	0	0	0
Eth 1/4	0	0	0	0	0	0
Eth 1/5	0	0	0	0	0	0
Eth 1/6	0	0	0	0	0	0

To display MLD query message statistics:

1. Click **Multicast > MLD Snooping > Statistics**.
2. Select Query.

Multicast > MLD Snooping > Statistics

Type Input Output Query Summary Clear

VLAN

Query Statistics

Other Querier Address	None
Other Querier Expire	0(m):0(s)
Other Querier Uptime	0(h):0(m):0(s)
Self Querier Address	::
Self Querier Expire Time	0(m):0(s)
Self Querier Uptime	0(h):0(m):0(s)
General Query Received	0
General Query Sent	0
Specific Query Received	0
Specific Query Sent	0

To display MLD summary statistics for a port or trunk:

1. Click **Multicast > MLD Snooping > Statistics**.
2. Select Summary.

3. Select a port or trunk.

Multicast > MLD Snooping > Statistics

Type Input Output Query Summary Clear

Interface VLAN Unit / Port Trunk

Summary Statistics

Number of Groups 0

Querier		Report & Leave	
Transmit		Transmit	
General	0	Report	0
Group Specific	0	Leave	0
Recieved		Recieved	
General	0	Report	0
Group Specific	0	Leave	0
		Join Success	0
		Source Port Drop	0
		Others Drop	0

To display MLD summary statistics for a VLAN:

1. Click **Multicast > MLD Snooping > Statistics**.
2. Select Summary.
3. Select a VLAN.

Multicast > MLD Snooping > Statistics

Type Input Output Query Summary Clear

Interface VLAN Unit / Port Trunk

Summary Statistics

Number of Groups 0

Querier		Report & Leave	
Other Querier	None	Host Addr	None
Other Uptime	0(h):0(m):0(s)	Unsolicit Expire	0 sec
Other Expire	0(m):0(s)		
Self Addr	None		
Self Expire	0(m):0(s)		
Self Uptime	0(h):0(m):0(s)		
Transmit		Transmit	
General	0	Report	0
Group Specific	0	Leave	0
Recieved		Recieved	
General	0	Report	0
Group Specific	0	Leave	0
		Join Success	0
		Source Port Drop	0
		Others Drop	0

To clear MLD statistics:

1. Click **Multicast > MLD Snooping > Statistics**.
2. Select Clear.
3. Select All or enter the required interface.
4. Click **Clear**.

Multicast > MLD Snooping > Statistics

Type Input Output Query Summary Clear

Interface All

VLAN

Unk / Port

Trunk

Clear

MLD Filtering and Throttling

In certain switch applications, the administrator may want to control the multicast services that are available to end users. For example, an IP/TV service based on a specific subscription plan. The MLD filtering feature fulfills this requirement by restricting access to specified multicast services on a switch port, and MLD throttling limits the number of simultaneous multicast groups a port can join.

MLD filtering enables you to assign a profile to a switch port that specifies multicast groups that are permitted or denied on the port. An MLD filter profile can contain one or more addresses, or a range of multicast addresses; but only one profile can be assigned to a port. When enabled, MLD join reports received on the port are checked against the filter profile. If a requested multicast group is permitted, the MLD join report is forwarded as normal. If a requested multicast group is denied, the MLD join report is dropped.

MLD throttling sets a maximum number of multicast groups that a port can join at the same time. When the maximum number of groups is reached on a port, the switch can take one of two actions; either “deny” or “replace.” If the action is set to deny, any new MLD join reports will be dropped. If the action is set to replace, the switch randomly removes an existing group and replaces it with the new multicast group.

Enabling MLD Filtering and Throttling

Use the Multicast > MLD Snooping > Filter (Configure General) page to enable IGMP filtering and throttling globally on the switch.

Parameters

These parameters are displayed:

- ◆ **MLD Filter Status** – Enables MLD filtering and throttling globally for the switch. (Default: Disabled)

Web Interface

To enable MLD filtering and throttling on the switch:

1. Click **Multicast > MLD Snooping > Filter**.
2. Select Configure General from the Step list.
3. Enable MLD Filter Status.
4. Click **Apply**.

Multicast > MLD Snooping > Filter

Step: 1. Configure General

MLD Filter Status Enabled

Apply Revert

Configuring MLD Filter Profiles

Use the Multicast > MLD Snooping > Filter (Configure Profile – Add) page to create an MLD profile and set its access mode. Then use the (Add Multicast Group Range) page to configure the multicast groups to filter.

Command Usage

Specify a range of multicast groups by entering a start and end IPv6 address; or specify a single multicast group by entering the same IPv6 address for the start and end of the range.

Parameters

These parameters are displayed:

Add

- ◆ **Profile ID** – Creates an IGMP profile. (Range: 1-4294967295)
- ◆ **Access Mode** – Sets the access mode of the profile; either permit or deny. (Default: Deny)

When the access mode is set to permit, MLD join reports are processed when a multicast group falls within the controlled range. When the access mode is set to deny, MLD join reports are only processed when the multicast group is not in the controlled range.

Add Multicast Group Range

- ◆ **Profile ID** – Selects an IGMP profile to configure.
- ◆ **Start Multicast IPv6 Address** – Specifies the starting address of a range of multicast groups.
- ◆ **End Multicast IPv6 Address** – Specifies the ending address of a range of multicast groups.

Web Interface

To create an MLD filter profile and set its access mode:

1. Click **Multicast > MLD Snooping > Filter**.
2. Select Configure Profile from the Step list.
3. Select Add from the Action list.
4. Enter the number for a profile, and set its access mode.
5. Click **Apply**.

The screenshot shows the 'Multicast > MLD Snooping > Filter' page. At the top, the breadcrumb is 'Multicast > MLD Snooping > Filter'. Below it, there are two dropdown menus: 'Step: 2. Configure Profile' and 'Action: Add'. The main form area contains a text input for 'Profile ID (1-4294967295)' with the value '19' entered, and a dropdown for 'Access Mode' set to 'Permit'. At the bottom right, there are two buttons: 'Apply' and 'Revert'.

To show the MLD filter profiles:

1. Click **Multicast > MLD Snooping > Filter**.
2. Select Configure Profile from the Step list.
3. Select Show from the Action list.

The screenshot shows the 'Multicast > MLD Snooping > Filter' page with the 'Action' dropdown set to 'Show'. Below the dropdowns, there is a table titled 'MLD Snooping Filter Profile List' with a 'Total: 1' indicator. The table has three columns: a checkbox, 'Profile ID', and 'Action Mode'. One row is visible with a checked checkbox, '19' in the Profile ID column, and 'Permt' in the Action Mode column. At the bottom right, there are two buttons: 'Delete' and 'Revert'.

	Profile ID	Action Mode
<input checked="" type="checkbox"/>	19	Permt

To add a range of multicast groups to an MLD filter profile:

1. Click **Multicast > MLD Snooping > Filter**.
2. Select Configure Profile from the Step list.
3. Select Add Multicast Group Range from the Action list.
4. Select the profile to configure, and add a multicast group address or range of addresses.
5. Click **Apply**.

Multicast > MLD Snooping > Filter

Step: 2. Configure Profile Action: Add Multicast Group Range

Profile ID: 19

Start Multicast IPv6 Address: ff01::0101

End Multicast IPv6 Address: ff01::0202

Apply Revert

To show the multicast groups configured for an MLD filter profile:

1. Click **Multicast > MLD Snooping > Filter**.
2. Select Configure Profile from the Step list.
3. Select Show Multicast Group Range from the Action list.
4. Select the profile for which to display this information.

Multicast > MLD Snooping > Filter

Step: 2. Configure Profile Action: Show Multicast Group Range

Profile ID: 19

Multicast IPv6 Address Range List Total: 1

	Start Multicast IPv6 Address	End Multicast IPv6 Address
<input type="checkbox"/>	ff01::101	ff01::202

Delete Revert

Configuring MLD Filtering and Throttling for Interfaces

Use the Multicast > MLD Snooping > Filter (Configure Interface) page to assign an MLD filter profile to interfaces on the switch, or to throttle multicast traffic by limiting the maximum number of multicast groups an interface can join at the same time.

Command Usage

- MLD throttling sets a maximum number of multicast groups that a port can join at the same time. When the maximum number of groups is reached on a port, the switch can take one of two actions; either “deny” or “replace.” If the action is set to deny, any new MLD join reports will be dropped. If the action is set to replace, the switch randomly removes an existing group and replaces it with the new multicast group.

Parameters

These parameters are displayed:

- ◆ **Interface** – Port or trunk identifier.
An MLD profile or throttling setting can be applied to a port or trunk. When ports are configured as trunk members, the trunk uses the settings applied to the first port member in the trunk.
- ◆ **Profile ID** – Selects an existing profile to assign to an interface.
- ◆ **Max Multicast Groups** – Sets the maximum number of multicast groups an interface can join at the same time. (Range: 1-255; Default: 255)
- ◆ **Current Multicast Groups** – Displays the current multicast groups the interface has joined.
- ◆ **Throttling Action Mode** – Sets the action to take when the maximum number of multicast groups for the interface has been exceeded. (Default: Deny)
 - ◆ **Deny** - The new multicast group join report is dropped.
 - ◆ **Replace** - The new multicast group replaces an existing group.
- ◆ **Throttling Status** – Indicates if the throttling action has been implemented on the interface. (Options: True or False)

Web Interface

To configure MLD filtering or throttling for a port or trunk:

1. Click **Multicast > MLD Snooping > Filter**.
2. Select Configure Interface from the Step list.
3. Select a profile to assign to an interface, then set the maximum number of allowed multicast groups and the throttling response.
4. Click **Apply**.

Multicast > MLD Snooping > Filter

Step: 3 Configure Interface

Interface Port Trunk

MLD Filter and Throttling Port List Total: 28

Port	Profile ID	Max Multicast Groups (1-255)	Current Multicast Groups	Throttling Action Mode	Throttling Status
1	▼	255	0	Deny	False
2	▼	255	0	Deny	False
3	▼	255	0	Deny	False
4	▼	255	0	Deny	False
5	▼	255	0	Deny	False

Filtering MLD Query Packets on an Interface

Use the Multicast > MLD Snooping > Query Drop page to configure an interface to drop MLDF query packets.

Parameters

These parameters are displayed:

- ◆ **Interface** – Port or trunk identifier.
- ◆ **Query Drop** – Drops any received MLD query packets. (Default: Disabled)

This feature can be used to drop any query packets received on the specified interface. If this switch is acting as a Querier, this prevents it from being affected by messages received from another Querier.

Web Interface

To drop IGMP query packets:

1. Click **Multicast > MLD Snooping > Query Drop**.
2. Select Port or Trunk interface.
3. Enable query drop for any interface.
4. Click **Apply**.

Port	Query Drop	Multicast Data Drop
1	<input type="checkbox"/> Enabled	<input type="checkbox"/> Enabled
2	<input type="checkbox"/> Enabled	<input type="checkbox"/> Enabled
3	<input type="checkbox"/> Enabled	<input type="checkbox"/> Enabled
4	<input type="checkbox"/> Enabled	<input type="checkbox"/> Enabled
5	<input type="checkbox"/> Enabled	<input type="checkbox"/> Enabled

Multicast VLAN Registration for IPv4

Multicast VLAN Registration (MVR) is a protocol that controls access to a single network-wide VLAN most commonly used for transmitting multicast traffic (such as television channels or video-on-demand) across a service provider's network. Any multicast traffic entering an MVR VLAN is sent to all attached subscribers. This protocol can significantly reduce the processing overhead required to dynamically monitor and establish the distribution tree for a normal multicast VLAN. This makes it possible to support common multicast services over a wide part of the network without having to use any multicast routing protocol.

MVR maintains the user isolation and data security provided by VLAN segregation by passing only multicast traffic into other VLANs to which the subscribers belong. Even though common multicast streams are passed onto different VLAN groups from the MVR VLAN, users in different IEEE 802.1Q or private VLANs cannot exchange any information (except through upper-level routing services).

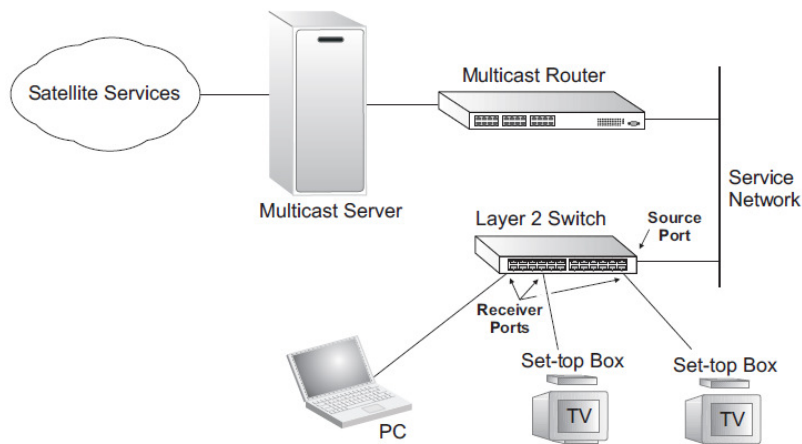

Command Usage

- ◆ General Configuration Guidelines for MVR:
 1. Enable MVR for a domain on the switch, and select the MVR VLAN.
 2. Create an MVR profile by specifying the multicast groups that will stream traffic to attached hosts, and assign the profile to an MVR domain.

3. Set the interfaces that will join the MVR as source ports or receiver ports.
 4. For multicast streams that will run for a long term and be associated with a stable set of hosts, you can statically bind the multicast group to the participating interfaces.
- ◆ Although MVR operates on the underlying mechanism of IGMP snooping, the two features operate independently of each other. One can be enabled or disabled without affecting the behavior of the other. However, if IGMP snooping and MVR are both enabled, MVR reacts only to join and leave messages from multicast groups configured under MVR. Join and leave messages from all other multicast groups are managed by IGMP snooping. Also, note that only IGMP version 2 or 3 hosts can issue multicast join or leave messages. Since IGMP version 1 hosts do not support leave messages, they are timed out by the switch.

Configuring MVR Global Settings

Use the Multicast > MVR (Configure Global) page to configure proxy switching and the robustness variable.

Parameters

These parameters are displayed:

- ◆ **Proxy Switching** – Configures MVR proxy switching, where the source port acts as a host, and the receiver port acts as an MVR router with querier service enabled. (Default: Enabled)
 - ◆ When MVR proxy-switching is enabled, an MVR source port serves as the upstream or host interface, and the MVR receiver port serves as the querier. The source port performs only the host portion of MVR by sending summarized membership reports, and automatically disables MVR router functions.
 - ◆ Receiver ports are known as downstream or router interfaces. These interfaces perform the standard MVR router functions by maintaining a database of all MVR subscriptions on the downstream interface. Receiver ports must therefore be configured on all downstream interfaces which require MVR proxy service.
 - ◆ When the source port receives report and leave messages, it only forwards them to other source ports.
 - ◆ When receiver ports receive any query messages, they are dropped.
 - ◆ When changes occurring in the downstream MVR groups are learned by the receiver ports through report and leave messages, an MVR state

change report is created and sent to the upstream source port, which in turn forwards this information upstream.

- ◆ When MVR proxy switching is disabled:
 - ◆ Any membership reports received from receiver/source ports are forwarded to all source ports.
 - ◆ When a source port receives a query message, it will be forwarded to all downstream receiver ports.
 - ◆ When a receiver port receives a query message, it will be dropped.
- ◆ **Robustness Value** – Configures the expected packet loss, and thereby the number of times to generate report and group-specific queries. (Range: 1-255; Default: 2)
 - ◆ This parameter is used to set the number of times report messages are sent upstream when changes are learned about downstream groups, and the number of times group-specific queries are sent to downstream receiver ports.
 - ◆ This parameter only takes effect when MVR proxy switching is enabled.
- ◆ **Proxy Query Interval** – Configures the interval at which the receiver port sends out general queries. (Range: 2-31744 seconds; Default: 125 seconds)
 - ◆ This parameter sets the general query interval at which active receiver ports send out general queries.
 - ◆ This interval is only effective when proxy switching is enabled.
- ◆ **Source Port Mode** – Configures the switch to forward any multicast streams within the parameters set by a profile, or to only forward multicast streams which the source port has dynamically joined.
 - ◆ **Always Forward** – By default, the switch forwards any multicast streams within the address range set by a profile, and bound to a domain. The multicast streams are sent to all source ports on the switch and to all receiver ports that have elected to receive data on that multicast address. (This is the default setting.)
 - ◆ **Dynamic** – When dynamic mode is enabled, the switch only forwards multicast streams which the source port has dynamically joined. In other words, both the receiver port and source port must subscribe to a multicast group before a multicast stream is forwarded to any attached client. Note that the requested streams are still restricted to the address range which has been specified in a profile and bound to a domain.

Web Interface

To configure global settings for MVR:

1. Click **Multicast > MVR**.
2. Select Configure Global from the Step list.
3. Set the status for MVR proxy switching, the robustness value used for report and query messages, the proxy query interval, and source port mode.
4. Click **Apply**.

Multicast > MVR

Step: 1. Configure Global

Proxy Switching Enabled

Robustness Value (1-255)

Proxy Query Interval (2-31744) sec

Source Port Mode

Configuring MVR Domain Settings

Use the Multicast > MVR (Configure Domain) page to enable MVR globally on the switch, and select the VLAN that will serve as the sole channel for common multicast streams supported by the service provider.

Parameters

These parameters are displayed:

- ♦ **Domain ID** – An independent multicast domain. (Range: 1-5)
- ♦ **MVR Status** – When MVR is enabled on the switch, any multicast data associated with an MVR group is sent from all designated source ports, to all receiver ports that have registered to receive data from that multicast group. (Default: Disabled)
- ♦ **MVR VLAN** – Identifier of the VLAN that serves as the channel for streaming multicast services using MVR. MVR source ports should be configured as members of the MVR VLAN (see Adding Static Members to VLANs), but MVR receiver ports should not be manually configured as members of this VLAN. (Default: 1)
- ♦ **MVR Running Status** – Indicates whether or not all necessary conditions in the MVR environment are satisfied. Running status is Active as long as

MVR is enabled, the specified MVR VLAN exists, and a source port with a valid link has been configured.

- ◆ **MVR Current Learned Groups** – The number of MVR groups currently assigned to this domain.
- ◆ **Forwarding Priority** – The CoS priority assigned to all multicast traffic forwarded into this domain. (Range: 0-7, where 7 is the highest priority)
This parameter can be used to set a high priority for low-latency multicast traffic such as a video-conference, or to set a low priority for normal multicast traffic not sensitive to latency.
- ◆ **Upstream Source IP** – The source IP address assigned to all MVR control packets sent upstream on the specified domain. By default, all MVR reports sent upstream use a null source IP address.

Web Interface

To configure settings for an MVR domain:

1. Click **Multicast > MVR**.
2. Select Configure Domain from the Step list.
3. Select a domain from the scroll-down list.
4. Enable MVR for the selected domain, select the MVR VLAN, set the forwarding priority to be assigned to all ingress multicast traffic, and set the source IP address for all control packets sent upstream as required.
5. Click **Apply**.

Configuring MVR Group Address Profiles

Use the Multicast > MVR (Configure Profile and Associate Profile) pages to assign the multicast group address for required services to one or more MVR domains.

Command Usage

- ◆ Use the Configure Profile page to statically configure all multicast group addresses that will join the MVR VLAN. Any multicast data associated with an MVR group is sent from all source ports to all receiver ports that have registered to receive data from that multicast group.
- ◆ The IP address range from 224.0.0.0 to 239.255.255.255 is used for multicast streams. MVR group addresses cannot fall within the reserved IP multicast address range of 224.0.0.x.
- ◆ IGMP snooping and MVR share a maximum number of 1024 groups. Any multicast streams received in excess of this limitation will be flooded to all ports in the associated domain.

Parameters

These parameters are displayed:

Configure Profile

- ◆ **Profile Name** – The name of a profile containing one or more MVR group addresses. (Range: 1-21 characters)
- ◆ **Start IP Address** – Starting IP address for an MVR multicast group. (Range: 224.0.1.0 - 239.255.255.255)
- ◆ **End IP Address** – Ending IP address for an MVR multicast group. (Range: 224.0.1.0 - 239.255.255.255)

Associate Profile

- ◆ **Domain ID** – An independent multicast domain. (Range: 1-5)
- ◆ **Profile Name** – The name of a profile to be assigned to this domain. (Range: 1-21 characters)

Web Interface

To configure an MVR group address profile:

1. Click **Multicast > MVR**.
2. Select Configure Profile from the Step list.
3. Select Add from the Action list.
4. Enter the name of a group profile to be assigned to one or more domains, and specify a multicast group that will stream traffic to participating hosts.
5. Click **Apply**.

Multicast > MVR

Step: 2. Configure Profile Action: Add

Profile Name: sales

Start IP Address: 234.5.6.8

End IP Address: 234.5.6.10

Apply Revert

To show the configured MVR group address profiles:

1. Click **Multicast > MVR**.
2. Select Configure Profile from the Step list.
3. Select Show from the Action list.

Multicast > MVR

Step: 3. Configure Profile Action: Show

MVR Profile List Total: 2

<input type="checkbox"/>	Profile Name	Start IP Address - End IP Address
<input type="checkbox"/>	profile1	224.1.1.1 - 224.1.1.10
<input type="checkbox"/>	profile2	224.1.2.1 - 224.1.2.100

Delete Revert

To assign an MVR group address profile to a domain:

1. Click **Multicast > MVR**.
2. Select Associate Profile from the Step list.
3. Select Add from the Action list.
4. Select a domain from the scroll-down list, and enter the name of a group profile.
5. Click **Apply**.

Multicast > MVR

Step: 4. Associate Profile Action: Add

Domain ID: 1

Profile Name: sales

Apply Revert

To show the MVR group address profiles assigned to a domain:

1. Click **Multicast > MVR**.
2. Select Associate Profile from the Step list.
3. Select Show from the Action list.

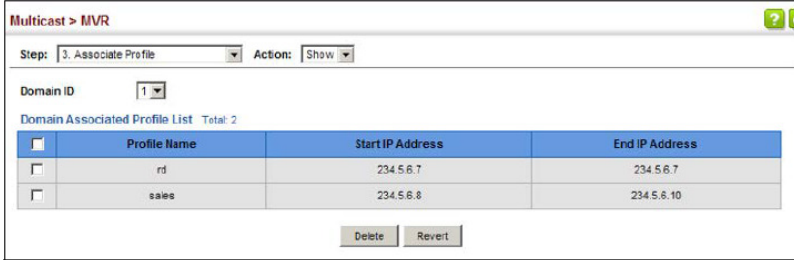

Configuring MVR Interface Status

Use the Multicast > MVR (Configure Interface) page to configure each interface that participates in the MVR protocol as a source port or receiver port. If you are sure that only one subscriber attached to an interface is receiving multicast services, you can enable the immediate leave function.

Command Usage

- ◆ A port configured as an MVR receiver or source port can join or leave multicast groups configured under MVR. However, note that these ports can also use IGMP snooping to join or leave any other multicast groups using the standard rules for multicast filtering.
- ◆ Receiver ports can belong to different VLANs, but should not be configured as a member of the MVR VLAN. MVR allows a receiver port to dynamically join or leave multicast groups sourced through the MVR VLAN. Multicast groups can also be statically assigned to a receiver port. Receiver ports should not be statically configured as a member of the MVR VLAN. If so configured, its MVR status will be inactive. Also, note that VLAN membership for MVR receiver ports cannot be set to access mode.
- ◆ One or more interfaces may be configured as MVR source ports. A source port is able to both receive and send data for configured MVR groups or for groups which have been statically assigned. All source ports must belong to the MVR VLAN. Subscribers should not be directly connected to source ports.

- ◆ Immediate leave applies only to receiver ports. When enabled, the receiver port is immediately removed from the multicast group identified in the leave message. When immediate leave is disabled, the switch follows the standard rules by sending a query message to the receiver port and waiting for a response to determine if there are any remaining subscribers for that multicast group before removing the port from the group list.
 - ◆ Using immediate leave can speed up leave latency, but should only be enabled on a port attached to one multicast subscriber to avoid disrupting services to other group members attached to the same interface.
 - ◆ Immediate leave does not apply to multicast groups which have been statically assigned to a port.

Parameters

These parameters are displayed:

- ◆ **Domain ID** – An independent multicast domain. (Range: 1-5)
- ◆ **Port/Trunk** – Interface identifier.
- ◆ **Type** – The following interface types are supported:
 - ◆ **Source** – An uplink port that can send and receive multicast data for the groups assigned to the MVR VLAN. Note that the source port must be manually configured as a member of the MVR VLAN.
 - ◆ **Receiver** – A subscriber port that can receive multicast data sent through the MVR VLAN. Any port configured as a receiver port will be dynamically added to the MVR VLAN when it forwards an IGMP report or join message from an attached host requesting any of the designated multicast services supported by the MVR VLAN. Just remember that only IGMP version 2 or 3 hosts can issue multicast join or leave messages. If MVR must be configured for an IGMP version 1 host, the multicast groups must be statically assigned.
 - ◆ **Non-MVR** – An interface that does not participate in the MVR VLAN. (This is the default type.)
- ◆ **Forwarding Status** – Shows if MVR traffic is being forwarded or discarded.
- ◆ **MVR Status** – Shows the MVR status. MVR status for source ports is “Active” if MVR is globally enabled on the switch. MVR status for receiver ports is “Active” only if there are subscribers receiving multicast traffic from one of the MVR groups, or a multicast group has been statically assigned to an interface.

- ◆ **Immediate Leave** – Configures the switch to immediately remove an interface from a multicast stream as soon as it receives a leave message for that group. This option only applies to an interface configured as an MVR receiver. (Default: Disabled)
 - ◆ **By Group** – The receiver port is immediately removed from the multicast group identified in the leave message.
 - ◆ **By Host IP** – The router/querier will not send out a group-specific query when an IGMPv2/v3 leave message is received (the same as it would without this option having been used). Instead of immediately deleting that group, it will look up the record, and only delete the group if there are no other subscribers for it on the member port. Only when all hosts on that port leave the group will the member port be deleted.

Web Interface

To configure interface settings for MVR:

1. Click **Multicast > MVR**.
2. Select Configure Interface from the Step list.
3. Select an MVR domain.
4. Click **Port** or **Trunk**.
5. Set each port that will participate in the MVR protocol as a source port or receiver port, and optionally enable Immediate Leave on any receiver port to which only one subscriber is attached.
6. Click **Apply**.

Multicast > MVR

Step: 5. Configure Interface

Domain ID: 1

Interface: Port Trunk

Port List Total: 28

Port	Type	Forwarding Status	MVR Status	Immediate Leave
1	Non-MVR	Forwarding	Inactive	<input type="checkbox"/> By-Group
2	Non-MVR	Discarding	Inactive	<input type="checkbox"/> By-Group
3	Non-MVR	Discarding	Inactive	<input type="checkbox"/> By-Group
4	Non-MVR	Discarding	Inactive	<input type="checkbox"/> By-Group
5	Non-MVR	Discarding	Inactive	<input type="checkbox"/> By-Group

Assigning Static MVR Multicast Groups to Interfaces

Use the Multicast > MVR (Configure Static Group Member) page to statically bind multicast groups to a port which will receive long-term multicast streams associated with a stable set of hosts.

Command Usage

- ◆ Multicast groups can be statically assigned to a receiver port using this configuration page.
- ◆ The IP address range from 224.0.0.0 to 239.255.255.255 is used for multicast streams. MVR group addresses cannot fall within the reserved IP multicast address range of 224.0.0.x.
- ◆ Only IGMP version 2 or 3 hosts can issue multicast join or leave messages. If MVR must be configured for an IGMP version 1 host, the multicast groups must be statically assigned.
- ◆ The MVR VLAN cannot be specified as the receiver VLAN for static bindings.

Parameters

These parameters are displayed:

- ◆ **Domain ID** – An independent multicast domain. (Range: 1-5)
- ◆ **Interface** – Port or trunk identifier.
- ◆ **VLAN** – VLAN identifier. (Range: 1-4094)
- ◆ **Group IP Address** – Defines a multicast service sent to the selected port. Multicast groups must be assigned from the MVR group range configured on the Configure General page.

Web Interface

To assign a static MVR group to an interface:

1. Click **Multicast > MVR**.
2. Select Configure Static Group Member from the Step list.
3. Select Add from the Action list.
4. Select an MVR domain.
5. Select a VLAN and interface to receive the multicast stream, and then enter the multicast group address.
6. Click **Apply**.

Multicast > MVR

Step: 5. Configure Static Group Member Action: Add

Domain ID: 1

Interface: Port 2 Trunk

VLAN: 2

Group IP Address: 234.5.6.8

Apply Revert

To show the static MVR groups assigned to an interface:

1. Click **Multicast > MVR**.
2. Select Configure Static Group Member from the Step list.
3. Select Show from the Action list.
4. Select an MVR domain.
5. Select the port or trunk for which to display this information.

Multicast > MVR

Step: 5. Configure Static Group Member Action: Show

Domain ID: 1

Interface: Port 2 Trunk 3

MVR Static Group Member List Total: 3

<input type="checkbox"/>	VLAN	Group IP Address
<input type="checkbox"/>	2	224.1.1.1
<input type="checkbox"/>	2	224.1.1.2
<input type="checkbox"/>	3	224.1.1.3

Delete Revert

Displaying MVR Receiver Groups

Use the Multicast > MVR (Show Member) page to show the multicast groups either statically or dynamically assigned to the MVR receiver groups on each interface.

Parameters

These parameters are displayed:

- ◆ **Domain ID** – An independent multicast domain. (Range: 1-5)
- ◆ **Group IP Address** – Multicast groups assigned to the MVR VLAN.

- ◆ **VLAN** – The VLAN through which the service is received. Note that this may be different from the MVR VLAN if the group address has been statically assigned.
- ◆ **Port** – Indicates the source address of the multicast service (these entries are marked as “Source”), or displays an asterisk if the group address has been statically assigned. Also shows the interfaces with subscribers for multicast services provided through the MVR VLAN (these entries are marked as “Receiver”).
- ◆ **Up Time** – Time this service has been forwarded to attached clients.
- ◆ **Expire** – Time before this entry expires if no membership report is received from currently active or new clients.
- ◆ **Count** – The number of multicast services currently being forwarded from the MVR VLAN.
- ◆ **Clear MVR Group** – Clears multicast group information dynamically learned through MVR6. Statically configured multicast addresses are not cleared.

Web Interface

To display the interfaces assigned to the MVR receiver groups:

1. Click **Multicast > MVR**.
2. Select Show Member from the Step list.
3. Select an MVR domain.

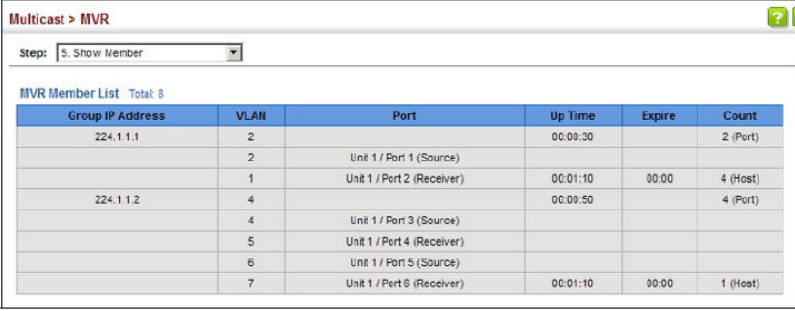

The screenshot shows the 'Multicast > MVR' web interface. At the top, there is a breadcrumb 'Multicast > MVR' and a 'Step:' dropdown menu set to '5. Show Member'. Below this is a table titled 'MVR Member List Total: 8'. The table has six columns: Group IP Address, VLAN, Port, Up Time, Expire, and Count. The data is as follows:

Group IP Address	VLAN	Port	Up Time	Expire	Count
224.1.1.1	2		00:09:30		2 (Port)
		Unit 1 / Port 1 (Source)			
224.1.1.2	1	Unit 1 / Port 2 (Receiver)	00:01:10	00:00	4 (Host)
	4		00:09:50		4 (Port)
		Unit 1 / Port 3 (Source)			
	5	Unit 1 / Port 4 (Receiver)			
	6	Unit 1 / Port 5 (Source)			
	7	Unit 1 / Port 6 (Receiver)	00:01:10	00:00	1 (Host)

Displaying MVR Statistics

Use the Multicast > MVR > Show Statistics pages to display MVR protocol-related statistics for the specified interface. There are four Action pages with separate statistics:

- ◆ Show Query Statistics

- ◆ Show VLAN Statistics
- ◆ Show Port Statistics
- ◆ Show Trunk Statistics

Parameters

These parameters are displayed:

- ◆ **Domain ID** – An independent multicast domain. (Range: 1-5)
- ◆ **VLAN** – VLAN identifier. (Range: 1-4094)
- ◆ **Port** – Port identifier. (Range: 1-28/54)
- ◆ **Trunk** – Trunk identifier. (Range: 1-28)

Query Statistics

- ◆ **Querier IP Address** – The IP address of the querier on this interface.
- ◆ **Querier Expire Time** – The time after which this querier is assumed to have expired.
- ◆ **General Query Received** – The number of general queries received on this interface.
- ◆ **General Query Sent** – The number of general queries sent from this interface.
- ◆ **Specific Query Received** – The number of specific queries received on this interface.
- ◆ **Specific Query Sent** – The number of specific queries sent from this interface.
- ◆ **Number of Reports Sent** – The number of reports sent from this interface.
- ◆ **Number of Leaves Sent** – The number of leaves sent from this interface.

VLAN, Port, and Trunk Statistics

Input Statistics

- ◆ **Report** – The number of IGMP membership reports received on this interface.
- ◆ **Leave** – The number of leave messages received on this interface.
- ◆ **G Query** – The number of general query messages received on this interface.
- ◆ **G(-S)-S Query** – The number of group specific or group-and-source specific query messages received on this interface.

- ♦ **Drop** – The number of times a report, leave or query was dropped. Packets may be dropped due to invalid format, rate limiting, packet content not allowed, or MVR group report received.
- ♦ **Join Success** – The number of times a multicast group was successfully joined.
- ♦ **Group** – The number of MVR groups active on this interface.

Output Statistics

- ♦ **Report** – The number of IGMP membership reports sent from this interface.
- ♦ **Leave** – The number of leave messages sent from this interface.
- ♦ **G Query** – The number of general query messages sent from this interface.
- ♦ **G(-S)-S Query** – The number of group specific or group-and-source specific query messages sent from this interface.

Web Interface

To display statistics for MVR query-related messages:

1. Click **Multicast > MVR**.
2. Select Show Statistics from the Step list.
3. Select Show Query Statistics from the Action list.
4. Select an MVR domain.

Multicast > MVR

Step: 7. Show Statistics Action: Show Query Statistics

Domain ID 1

Query Statistics

Querier IP Address	None
Querier Expire Time	00(h):00(m):00(s)
General Query Received	0
General Query Sent	0
Specific Query Received	0
Specific Query Sent	0
Number of Reports Sent	0
Number of Leaves Sent	0

Clear All [Click this button to clear all MVR statistics of the domain.](#)

Refresh

To display MVR protocol-related statistics for a VLAN, Port or Trunk:

1. Click **Multicast > MVR**.
2. Select Show Statistics from the Step list.
3. Select Show VLAN/Port/Trunk Statistics from the Action list.
4. Select an MVR domain.
5. Select a VLAN/Port/Trunk.

Multicast > MVR

Step: Action:

Domain ID

VLAN

Input Statistics

Report	0	Drop	0
Leave	0	Join Success	0
G Query	0	Group	0
G(-S)-S Query	0		

Output Statistics

Report	0		
Leave	0		
G Query	0		
G(-S)-S Query	0		

To display MVR protocol-related statistics for a port:

1. Click **Multicast > MVR**.
2. Select Show Statistics from the Step list.
3. Select Show Port Statistics from the Action list.
4. Select an MVR domain.
5. Select a Port.

Multicast > MVR

Step: Action:

Domain ID:

Port:

Input Statistics

Report	0	Drop	0
Leave	0	Join Success	0
G Query	0	Group	0
G(-S)-S Query	0		

Output Statistics

Report	0		
Leave	0		
G Query	0		
G(-S)-S Query	0		

This Page Intentionally Left Blank

Chapter 17

IP Tools

Overview

This chapter provides information on network functions including:

- ♦ *Ping* – Sends ping message to another node on the network.
- ♦ *Trace Route* – Sends ICMP echo request packets to another node on the network.
- ♦ *Address Resolution Protocol* – Describes how to configure proxy ARP or static addresses, and how to display entries in the ARP cache.

Ping

Use the Tools > Ping page to send ICMP echo request packets to another node on the network.

Parameters

These parameters are displayed:

- ◆ **Host Name/IP Address** – Alias or IPv4/IPv6 address of the host.
- ◆ **Probe Count** – Number of packets to send. (Range: 1-16)
- ◆ **Packet Size** – Number of bytes in a packet. (Range: 32-512 bytes for IPv4, 0-1500 bytes for IPv6)

The actual packet size will be eight bytes larger than the size specified because the switch adds header information.

Command Usage

- ◆ Use the ping command to see if another site on the network can be reached.
- ◆ The following are some results of the **ping** command:
 - ◆ *Normal response* - The normal response occurs in one to ten seconds, depending on network traffic.
 - ◆ *Destination does not respond* - If the host does not respond, a “timeout” appears in ten seconds.
 - ◆ *Destination unreachable* - The gateway for this destination indicates that the destination is unreachable.
 - ◆ *Network or host unreachable* - The gateway found no corresponding entry in the route table.
- ◆ The same link-local address may be used by different interfaces/nodes in different zones (RFC 4007). Therefore, when specifying a link-local address, include zone-id information indicating the VLAN identifier after the % delimiter. For example, FE80::7272%1 identifies VLAN 1 as the interface.

Web Interface

To ping another device on the network:

1. Click **Tools > Ping**.
2. Specify the target device and ping parameters.
3. Click **Apply**.

Tool > Ping

Host Name/IP Address

Probe Count (1-16)

Data Size (IPv4 : 32-512, IPv6 : 0-1500) bytes

Note: For IPv4 Data Size,
0 - 31 changed to 32 bytes
32 - 512 is valid input
513 - 1500 changed to 512 bytes
< 0 or > 1500 not valid input

Result

```
PING to 192.168.2.99, by 5 of 32-byte payload ICMP packets, timeout is 3 seconds
response time: 0 ms
response time: 0 ms
response time: 0 ms
response time: 0 ms
response time: 0 ms

Ping statistics for 192.168.2.99:
    5 packets transmitted, 5 packets received (100%), 0 packets lost (0%)
Approximate round trip times:
    Minimum = 0 ms, Maximum = 0 ms, Average = 0 ms
```

Trace Route

Use the Tools > Trace Route page to show the route packets take to the specified destination.

Parameters

These parameters are displayed:

- ◆ **Host Name/IP Address** – Alias or IPv4/IPv6 address of the host.
- ◆ **IPv4 Max Failures** – The maximum number of failures before which the trace route is terminated. (Fixed: 5)
- ◆ **IPv6 Max Failures** – The maximum number of failures before which the trace route is terminated. (Range: 1-255; Default: 5)

Command Usage

- ◆ Use the trace route function to determine the path taken to reach a specified destination.
- ◆ A trace terminates when the destination responds, when the maximum timeout (TTL) is exceeded, or the maximum number of hops is exceeded.
- ◆ The trace route function first sends probe datagrams with the TTL value set at one. This causes the first router to discard the datagram and return an error message. The trace function then sends several probe messages at each subsequent TTL level and displays the round-trip time for each message. Not all devices respond correctly to probes by returning an “ICMP port unreachable” message. If the timer goes off before a response is returned, the trace function prints a series of asterisks and the “Request Timed Out” message. A long sequence of these messages, terminating only when the maximum timeout has been reached, may indicate this problem with the target device.
- ◆ The same link-local address may be used by different interfaces/nodes in different zones (RFC 4007). Therefore, when specifying a link-local address, include zone-id information indicating the VLAN identifier after the % delimiter. For example, FE80::7272%1 identifies VLAN 1 as the interface from which the trace route is sent.

Web Interface

To trace the route to another device on the network:

1. Click **Tools > Trace Route**.
2. Specify the target device.
3. Click **Apply**.

The screenshot shows the 'Tools > Trace Route' configuration page in a web browser. The configuration fields are:

- Host Name/IP Address:
- IPv4 Max Failures:
- IPv6 Max Failurea (1-256):

Buttons:

The browser window shows the 'Traceroute Result' page. The destination IP address is 192.168.1.9. The results table is as follows:

Hop	IP Address	Packet 1	Packet 2	Packet 3
1	Unknown Route	*NoResponse	*NoResponse	*NoResponse
2	Unknown Route	*NoResponse	*NoResponse	*NoResponse
3	Unknown Route	*NoResponse	*NoResponse	*NoResponse
4	Unknown Route	*NoResponse		

Address Resolution Protocol

If IP routing is enabled, the router uses its routing tables to make routing decisions, and uses Address Resolution Protocol (ARP) to forward traffic from one hop to the next. ARP is used to map an IP address to a physical layer (i.e., MAC) address. When an IP frame is received by this router (or any standards-based router), it first looks up the MAC address corresponding to the destination IP address in the ARP cache. If the address is found, the router writes the MAC address into the appropriate field in the frame header, and forwards the frame on to the next hop. IP traffic passes along the path to its final destination in this way, with each routing device mapping the destination IP address to the MAC address of the next hop toward the recipient, until the packet is delivered to the final destination.

If there is no entry for an IP address in the ARP cache, the router will broadcast an ARP request packet to all devices on the network. The ARP request contains the following fields similar to that shown in this example:

destination IP address	10.1.0.19
destination MAC address	?
source IP address	10.1.0.253
source MAC address	00-00-ab-cd-00-00

When devices receive this request, they discard it if their address does not match the destination IP address in the message. However, if it does match, they write their own hardware address into the destination MAC address field and send the message back to the source hardware address. When the source device receives a reply, it writes the destination IP address and corresponding MAC address into its cache, and forwards the IP traffic on to the next hop. As long as this entry has not timed out, the router will be able forward traffic directly to the next hop for this destination without having to broadcast another ARP request.

Also, if the switch receives a request for its own IP address, it will send back a response, and also cache the MAC of the source device's IP address.

Basic ARP Configuration

Use the Tools > ARP (Configure General) page to specify the timeout for ARP cache entries, or to enable Proxy ARP for specific VLAN interfaces.

Command Usage

Proxy ARP

When a node in the attached subnetwork does not have routing or a default gateway configured, Proxy ARP can be used to forward ARP requests to a remote subnetwork. When the router receives an ARP request for a remote network and Proxy ARP is enabled, it determines if it has the best route to the remote network, and then answers the ARP request by sending its own MAC address to the requesting node. That node then sends traffic to the router, which in turn uses its own routing table to forward the traffic to the remote destination.

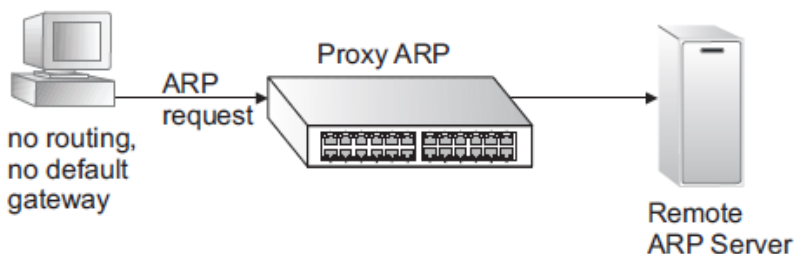

Parameters

These parameters are displayed:

- ◆ **Timeout** – Sets the aging time for dynamic entries in the ARP cache. (Range: 300 - 86400 seconds; Default: 1200 seconds or 20 minutes)

The ARP aging timeout can be set for any configured VLAN.

The aging time determines how long dynamic entries remain in the cache. If the timeout is too short, the router may tie up resources by repeating ARP requests for addresses recently flushed from the table.

When a ARP entry expires, it is deleted from the cache and an ARP request packet is sent to re-establish the MAC address.

- ◆ **Proxy ARP** – Enables or disables Proxy ARP for specified VLAN interfaces, allowing a non-routing device to determine the MAC address of a host on another subnet or network. (Default: Disabled)

End stations that require Proxy ARP must view the entire network as a single network. These nodes must therefore use a smaller subnet mask than that used by the router or other relevant network devices.

Extensive use of Proxy ARP can degrade router performance because it may lead to increased ARP traffic and increased search time for larger ARP address tables.

Web Interface

To configure the timeout for the ARP cache or to enable Proxy ARP for a VLAN (i.e., IP subnetwork):

1. Click **Tools** > **ARP**.
2. Select Configure General from the Step List.
3. Enable Proxy ARP for subnetworks that do not have routing or a default gateway.
4. Click **Apply**.

The screenshot shows the 'Tools > ARP' configuration page. At the top, there is a 'Step:' dropdown menu set to '1. Configure General'. Below this, there is a 'Timeout (300-86400)' field with a value of '1200' and a unit of 'sec'. Underneath, there is a 'Proxy ARP' section with a 'VLAN' dropdown menu set to '1' and a 'Status' checkbox labeled 'Enabled' which is currently unchecked. At the bottom right of the form, there are two buttons: 'Apply' and 'Revert'.

Configuring Static ARP Addresses

For devices that do not respond to ARP requests or do not respond in a timely manner, traffic will be dropped because the IP address cannot be mapped to a physical address. If this occurs, use the Tools > ARP (Configure Static Address – Add) page to manually map an IP address to the corresponding physical address in the ARP cache.

Command Usage

- ◆ The ARP cache is used to map 32-bit IP addresses into 48-bit hardware (that is, Media Access Control) addresses. This cache includes entries for hosts and other routers on local network interfaces defined on this router.
- ◆ You can define up to 128 static entries in the ARP cache.

- ◆ A static entry may need to be used if there is no response to an ARP broadcast message. For example, some applications may not respond to ARP requests or the response arrives too late, causing network operations to time out.
- ◆ Static entries will not be aged out or deleted when power is reset. You can only remove a static entry via the configuration interface.
- ◆ Static entries are only displayed on the Show page for VLANs that are up. In other words, static entries are only displayed when configured for the IP subnet of an existing VLAN, and that VLAN is linked up.

Parameters

These parameters are displayed:

- ◆ **IP Address** – IP address statically mapped to a physical MAC address. (Valid IP addresses consist of four numbers, 0 to 255, separated by periods.)
- ◆ **MAC Address** – MAC address statically mapped to the corresponding IP address. (Valid MAC addresses are hexadecimal numbers in the format: xx-xx-xx-xx-xx-xx or xxxxxxxxxxxxxx)

Web Interface

To map an IP address to the corresponding physical address in the ARP cache:

1. Click **Tools > ARP**.
2. Select Configure Static Address from the Step List.
3. Select Add from the Action List.
4. Enter the IP address and the corresponding MAC address.
5. Click **Apply**.

Tools > ARP

Step: 2. Configure Static Address Action: Add

IP Address: 10.2.78.105

MAC Address: 00-e0-0c-00-00-fd (xx-xx-xx-xx-xx-xx or xxxxxxxxxxxxxx)

Apply Revert

To display static entries in the ARP cache:

1. Click **Tools > ARP**.
2. Select Configure Static Address from the Step List.
3. Select Show from the Action List.

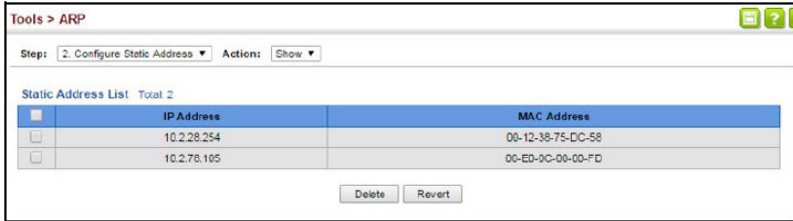

Displaying Dynamic or Local ARP Entries

Use the Tools > ARP page to display dynamic or local entries in the ARP cache. The ARP cache contains static entries, and entries for local interfaces, including subnet, host, and broadcast addresses. However, most entries will be dynamically learned through replies to broadcast messages.

Web Interface

To display all dynamic and local entries in the ARP cache:

1. Click **Tools > ARP**.
2. Select Show Information from the Step List.
3. Click **ARP Addresses**.

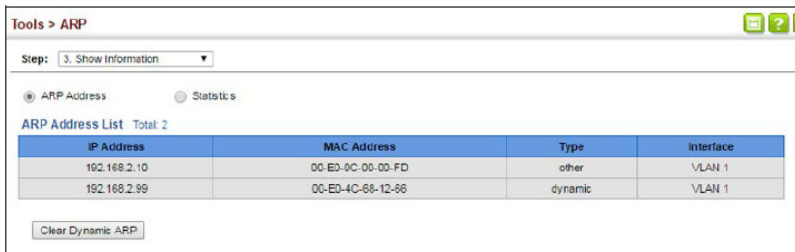

Displaying ARP Statistics

Use the Tools > ARP (Show Information) page to display statistics for ARP messages crossing all interfaces on this switch.

Parameters

These parameters are displayed:

Parameter	Description
Received Request	Number of ARP Request packets received by the router.
Received Reply	Number of ARP Reply packets received by the router.
Sent Request	Number of ARP Request packets sent by the router.
Sent Reply	Number of ARP Reply packets sent by the router.

Web Interface

To display ARP statistics:

1. Click **Tools > ARP**.
2. Select Show Information from the Step List.
3. Click **Statistics**.

The screenshot shows a web interface for ARP statistics. At the top, it says "Tools > ARP". Below that, there is a "Step:" dropdown menu set to "3. Show Information". There are two radio buttons: "ARP Address" (unselected) and "Statistics" (selected). Under "ARP Statistics", there are four data points: "Received Request" (13), "Received Reply" (0), "Sent Request" (0), and "Sent Reply" (1). A "Refresh" button is located at the bottom right.

ARP Statistics			
Received Request	13	Sent Request	0
Received Reply	0	Sent Reply	1

This Page Intentionally Left Blank

Chapter 18

IP Configuration

Overview

This chapter describes how to configure an IP interface for management access to the switch over the network. This switch supports both IP Version 4 and Version 6, and can be managed simultaneously through either of these address types. You can manually configure a specific IPv4 or IPv6 address, or direct the switch to obtain an IPv4 address from a BOOTP or DHCP server. An IPv6 address can either be manually configured or dynamically generated.

This chapter provides information on network functions including:

- ♦ *IPv4 Configuration* – Sets an IPv4 address for management access.
- ♦ *IPv6 Configuration* – Sets an IPv6 address for management access.

IPv4 Configuration

This section describes how to configure an initial IPv4 interface for management access over the network, and how to create an interface to multiple subnets. This switch supports both IPv4 and IPv6, and can be managed through either of these address types. You can manually configure a specific IPv4 or IPv6 address or direct the switch to obtain an IPv4 address from a BOOTP or DHCP server. An IPv6 global unicast or link-local address can be manually configured, or a link-local address can be dynamically generated. For information on configuring the switch with an IPv6 address.

Configuring IPv4 Interface Settings

Use the IP > General > Routing Interface (Add Address) page to configure an IPv4 address for the switch. An IPv4 address is obtained via DHCP by default for VLAN 1. To configure a static address, you need to change the switch's default settings to values that are compatible with your network. You may also need to establish a default gateway between the switch and management stations that exist on another network segment. To configure this device as the default gateway, use the IP > Routing > Static Routes (Add) page, set the destination address to the required interface, and the next hop to null address 0.0.0.0.

You can direct the device to obtain an address from a BOOTP or DHCP server, or manually configure a static IP address. Valid IP addresses consist of four decimal numbers, 0 to 255, separated by periods. Anything other than this format will not be accepted.

Command Usage

- ◆ This section describes how to configure a single local interface for initial access to the switch. To configure multiple IP interfaces, set up an IP interface for each VLAN.
- ◆ Once an IP address has been assigned to an interface, routing between different interfaces on the switch is enabled.
- ◆ To enable routing between interfaces defined on this switch and external network interfaces, you can configure static routes. or a default gateway using the IP > Routing > Static Routes (Add) page (see Configuring Static Routes) or the IP > IPv6 Configuration (Configure Global) page (see Configuring the IPv6 Default Gateway)
- ◆ The precedence for configuring IP interfaces is the IP > General > Routing Interface (Add Address) menu, and then static routes.

Parameters

These parameters are displayed:

- ♦ **VLAN** – ID of the configured VLAN (1-4094). By default, all ports on the switch are members of VLAN 1. However, the management station can be attached to a port belonging to any VLAN, as long as that VLAN has been assigned an IP address. (Default: VLAN 1)
- ♦ **IP Address Mode** – Specifies whether IP functionality is enabled via manual configuration (User Specified), Dynamic Host Configuration Protocol (DHCP), or Boot Protocol (BOOTP). If DHCP/BOOTP is enabled, IP will not function until a reply has been received from the server. Requests will be broadcast periodically by the switch for an IP address. DHCP/BOOTP responses can include the IP address, subnet mask, and default gateway. (Default: DHCP)
- ♦ **IP Address Type** – Specifies a primary or secondary IP address. An interface can have only one primary IP address, but can have many secondary IP addresses. In other words, secondary addresses need to be specified if more than one IP subnet can be accessed through this interface. For initial configuration, set this parameter to Primary. (Options: Primary, Secondary; Default: Primary)

Note that a secondary address cannot be configured prior to setting the primary IP address, and the primary address cannot be removed if a secondary address is still present. Also, if any router or switch in a network segment uses a secondary address, all other routers/switches in that segment must also use a secondary address from the same network or subnet address space.

- ♦ **IP Address** – IP Address of the VLAN. Valid IP addresses consist of four numbers, 0 to 255, separated by periods. (Default: None)

Note: You can manage the switch through any configured IP interface.

- ♦ **Subnet Mask** – This mask identifies the host address bits used for routing to specific subnets. (Default: None)
- ♦ **Restart DHCP** – Requests a new IP address from the DHCP server.

Web Interface

To set a static IPv4 address for the switch:

1. Click **IP > General > Routing Interface**.
2. Select Add Address from the Action list.
3. Select any configured VLAN, set IP Address Mode to “User Specified,” set IP Address Type to “Primary” if no address has yet been configured for this interface, and then enter the IP address and subnet mask.
4. Click **Apply**.

The screenshot shows the web interface for configuring a static IPv4 address. The breadcrumb navigation is "IP > General > Routing Interface". The "Action" dropdown is set to "Add Address". The "VLAN" dropdown is set to "1". The "IP Address Mode" dropdown is set to "User Specified". The "IP Address Type" dropdown is set to "Primary". There are two empty text input fields for "IP Address" and "Subnet Mask". Below these fields is a "Restart DHCP" button and a link that says "Click this button to resend DHCP client request." At the bottom right, there are "Apply" and "Revert" buttons.

To obtain a dynamic IPv4 address through DHCP/BOOTP for the switch:

1. Click **IP > General > Routing Interface**.
2. Select Add Address from the Action list.
3. Select any configured VLAN, and set IP Address Mode to “BOOTP” or “DHCP.”
4. Click **Apply** to save your changes.
5. Then click Restart DHCP to immediately request a new address.

IP will be enabled but will not function until a BOOTP or DHCP reply is received. Requests are broadcast every few minutes using exponential backoff until IP configuration information is obtained from a BOOTP or DHCP server.

IP > General > Routing Interface

Action: Add Address ▼

VLAN: 1 ▼

IP Address Mode: DHCP ▼

IP Address Type: Primary ▼

IP Address:

Subnet Mask:

[Click this button to resend DHCP client request.](#)

Note:

- ◆ The switch will also broadcast a request for IP configuration settings on each power reset.
- ◆ If you lose the management connection, make a console connection to the switch and enter “show ip interface” to determine the new switch address.

Renewing DHCP – DHCP may lease addresses to clients indefinitely or for a specific period of time. If the address expires or the switch is moved to another network segment, you will lose management access to the switch. In this case, you can reboot the switch or submit a client request to restart DHCP service via the CLI.

If the address assigned by DHCP is no longer functioning, you will not be able to renew the IP settings via the web interface. You can only restart DHCP service via the web interface if the current address is still available.

To show the IPv4 address configured for an interface:

1. Click **IP > General > Routing Interface**.
2. Select Show Address from the Action list.
3. Select an entry from the VLAN list.

IP > General > Routing Interface ?

Action: Show Address ▼

VLAN: 1 ▼

IP Address Mode: User Specified

Routing Interface IP List Total: 1

<input type="checkbox"/>	IP Address Type	IP Address	Subnet Mask
<input type="checkbox"/>	Primary	192.168.1.1	255.255.255.0

IPv6 Configuration

This section describes how to configure an IPv6 interface for management access over the network, or for creating an interface to multiple subnets. This switch supports both IPv4 and IPv6, and can be managed through either of these address types. For information on configuring the switch with an IPv4 address.

Command Usage

- ◆ IPv6 includes two distinct address types – link-local unicast and global unicast. A link-local address makes the switch accessible over IPv6 for all devices attached to the same local subnet. Management traffic using this kind of address cannot be passed by any router outside of the subnet. A link-local address is easy to set up, and may be useful for simple networks or basic troubleshooting tasks. However, to connect to a larger network with multiple segments, the switch must be configured with a global unicast address. Both link-local and global unicast address types can either be dynamically assigned (using the Configure Interface page) or manually configured (using the Add IPv6 Address page).
- ◆ An IPv6 global unicast or link-local address can be manually configured (using the Add IPv6 Address page), or a link-local address can be dynamically generated (using the Configure Interface page).

Configuring the IPv6 Default Gateway

Use the IP > IPv6 Configuration (Configure Global) page to configure an IPv6 default gateway for the switch.

Parameters

These parameters are displayed:

- ◆ **Default Gateway** – Sets the IPv6 address of the default next hop router to use when no routing information is known about an IPv6 address.
 - ◆ If no static routes are defined, you must define a gateway if the target device is located in a different subnet.
 - ◆ An IPv6 default gateway can only be successfully set when a network interface that directly connects to the gateway has been configured on the switch.
 - ◆ An IPv6 address must be configured according to RFC 2373 “IPv6 Addressing Architecture,” using 8 colon-separated 16-bit hexadecimal

values. One double colon may be used in the address to indicate the appropriate number of zeros required to fill the undefined fields.

Web Interface

To configure an IPv6 default gateway for the switch:

1. Click **IP > IPv6 Configuration**.
2. Select Configure Global from the Action list.
3. Enter the IPv6 default gateway.
4. Click **Apply**.

The screenshot shows a web interface for configuring IPv6 settings. At the top, it says "IP > IPv6". Below that, there is a dropdown menu for "Action:" with "Configure Global" selected. Underneath, there is a field for "Default Gateway" containing the IPv6 address "2001:DB8:2222:7272::254". At the bottom right of the form, there are two buttons: "Apply" and "Revert".

Configuring IPv6 Interface Settings

Use the IP > IPv6 Configuration (Configure Interface – VLAN or RA Guard) page to configure general IPv6 settings for the selected VLAN, including auto-configuration of a global unicast interface address, and explicit configuration of a link local interface address, the MTU size, and neighbor discovery protocol settings for duplicate address detection and the neighbor solicitation interval.

Command Usage

- ◆ The switch must be configured with a link-local address. The switch's address auto-configuration function will automatically create a link-local address, as well as an IPv6 global address if router advertisements are detected on the local interface.
- ◆ The option to explicitly enable IPv6 creates a link-local address, but will not generate a global IPv6 address if auto-configuration is not enabled. In this case, you can manually configure a global unicast address.
- ◆ The “managed-address configuration” flag tells hosts that they should use stateless address autoconfiguration to get IPv6 address (based on the IPv6 prefixes found in router advertisements) and stateful autoconfiguration to get other non-address parameters (such as DNS server addresses) from DHCPv6 servers. This flag is only a suggestion to attached hosts. They may still use stateful and/or stateless address autoconfiguration. If hosts

must be forced to use DHCPv6 for security reasons, ensure that no route prefixes are sent in router advertisements.

- ◆ The “other-stateful-configuration” flag tells hosts that they should use stateful autoconfiguration to obtain information other than addresses from a DHCPv6 server. Some hosts interpret the “other stateful configuration” flag to indicate that they should use stateless address autoconfiguration to get IPv6 address (based on the IPv6 prefixes found in router advertisements) and stateful autoconfiguration to get other non-address parameters from DHCPv6 servers. In this case, the absence of both the “managed address configuration” flag and the “other stateful configuration” flag is interpreted to mean that they should use only stateless autoconfiguration to obtain addresses.
- ◆ IPv6 Neighbor Discovery Protocol supersedes IPv4 Address Resolution Protocol in IPv6 networks. IPv6 nodes on the same network segment use Neighbor Discovery to discover each other's presence, to determine each other's link-layer addresses, to find routers and to maintain reachability information about the paths to active neighbors. The key parameters used to facilitate this process are the number of attempts made to verify whether or not a duplicate address exists on the same network segment, and the interval between neighbor solicitations used to verify reachability information.

Parameters

These parameters are displayed:

VLAN Mode

- ◆ **VLAN** – ID of a configured VLAN which is to be used for management access, or as a standard interface for a subnet. By default, all ports on the switch are members of VLAN 1. However, the management station can be attached to a port belonging to any VLAN, as long as that VLAN has been assigned an IP address. (Range: 1-4094)
- ◆ **Enable IPv6 Explicitly** – Enables IPv6 on an interface and assigns it a link-local address. Note that when an explicit address is assigned to an interface, IPv6 is automatically enabled, and cannot be disabled until all assigned addresses have been removed. (Default: Disabled)
Disabling this parameter does not disable IPv6 for an interface that has been explicitly configured with an IPv6 address.
- ◆ **Enable ND managed-config-flag** – Configures IPv6 router advertisements to indicate to attached hosts that they can use stateful autoconfiguration to obtain addresses. (Default: Disabled)

- ◆ **Enable ND other-config-flag** – Configures IPv6 router advertisements to indicate to attached hosts that they can obtain stateful autoconfiguration information other than addresses. (Default: Disabled)
- ◆ **Enable ND ra suppress** – Suppresses periodic unsolicited router advertisements on an interface. It does not suppress advertisements sent in response to a router solicitation. (Default: Disabled)
- ◆ **MTU** – Sets the size of the maximum transmission unit (MTU) for IPv6 packets sent on an interface. (Range: 1280-65535 bytes; Default: 1500 bytes)
 - ◆ The maximum value set in this field cannot exceed the MTU of the physical interface, which is currently fixed at 1500 bytes.
 - ◆ If a non-default value is configured, an MTU option is included in the router advertisements sent from this device. This option is provided to ensure that all nodes on a link use the same MTU value in cases where the link MTU is not otherwise well known.
 - ◆ IPv6 routers do not fragment IPv6 packets forwarded from other routers. However, traffic originating from an end-station connected to an IPv6 router may be fragmented.
 - ◆ All devices on the same physical medium must use the same MTU in order to operate correctly.
 - ◆ IPv6 must be enabled on an interface before the MTU can be set. If an IPv6 address has not been assigned to the switch, “N/A” is displayed in the MTU field.
- ◆ **ND DAD Attempts** – The number of consecutive neighbor solicitation messages sent on an interface during duplicate address detection. (Range: 0-255, Default: 1)
 - ◆ Configuring a value of 0 disables duplicate address detection.
 - ◆ Duplicate address detection determines if a new unicast IPv6 address already exists on the network before it is assigned to an interface.
 - ◆ Duplicate address detection is stopped on any interface that has been suspended. While an interface is suspended, all unicast IPv6 addresses assigned to that interface are placed in a “pending” state. Duplicate address detection is automatically restarted when the interface is administratively re-activated.
 - ◆ An interface that is re-activated restarts duplicate address detection for all unicast IPv6 addresses on the interface. While duplicate address detection is performed on the interface’s link-local address, the other IPv6 addresses remain in a “tentative” state. If no duplicate link-local address is found, duplicate address detection is started for the remaining IPv6 addresses.

- ◆ If a duplicate address is detected, it is set to “duplicate” state, and a warning message is sent to the console. If a duplicate link-local address is detected, IPv6 processes are disabled on the interface. If a duplicate global unicast address is detected, it is not used. All configuration commands associated with a duplicate address remain configured while the address is in “duplicate” state.
- ◆ If the link-local address for an interface is changed, duplicate address detection is performed on the new link-local address, but not for any of the IPv6 global unicast addresses already associated with the interface.
- ◆ **ND NS Interval** – The interval between transmitting IPv6 neighbor solicitation messages on an interface. (Range: 1000-3600000 milliseconds)

Default: 1000 milliseconds is used for neighbor discovery operations, 0 milliseconds is advertised in router advertisements.

This attribute specifies the interval between transmitting neighbor solicitation messages when resolving an address, or when probing the reachability of a neighbor. Therefore, avoid using very short intervals for normal IPv6 operations.

When a non-default value is configured, the specified interval is used both for router advertisements and by the router itself.

- ◆ **ND Reachable-Time** – The amount of time that a remote IPv6 node is considered reachable after some reachability confirmation event has occurred. (Range: 0-3600000 milliseconds)
- Default: 30000 milliseconds is used for neighbor discovery operations, 0 milliseconds is advertised in router advertisements.
- ◆ The time limit configured by this parameter allows the router to detect unavailable neighbors. During the neighbor discover process, an IPv6 node will multicast neighbor solicitation messages to search for neighbor nodes. For a neighbor node to be considered reachable, it must respond to the neighbor soliciting node with a neighbor advertisement message to become a confirmed neighbor, after which the reachable timer will be considered in effect for subsequent unicast IPv6 layer communications.
 - ◆ This time limit is included in all router advertisements sent out through an interface, ensuring that nodes on the same link use the same time value.
 - ◆ Setting the time limit to 0 means that the configured time is unspecified by this router.

RA Guard Mode

- ♦ **Interface** – Shows port or trunk configuration page.
- ♦ **RA Guard** – Blocks incoming Router Advertisement and Router Redirect packets. (Default: Disabled)

IPv6 Router Advertisements (RA) convey information that enables nodes to auto-configure on the network. This information may include the default router address taken from the observed source address of the RA message, as well as on-link prefix information. However, note that unintended misconfigurations, or possibly malicious attacks on the network, may lead to bogus RAs being sent, which in turn can cause operational problems for hosts on the network.

RA Guard can be used to block RAs and Router Redirect (RR) messages on the specified interface. Determine which interfaces are connected to known routers, and enable RA Guard on all other untrusted interfaces.

Web Interface

To configure general IPv6 settings for the switch:

1. Click **IP > IPv6 Configuration**.
2. Select Configure Interface from the Action list.
3. Select VLAN mode.
4. Specify the VLAN to configure.
5. Enable IPv6 explicitly to automatically configure a link-local address and enable IPv6 on the selected interface. (To manually configure the link-local address, use the Add IPv6 Address page.) Set the MTU size, the maximum number of duplicate address detection messages, the neighbor solicitation message interval, and the amount of time that a remote IPv6 node is considered reachable.
6. Click **Apply**.

IP > IPv6 Configuration

Step: 2. Configure Interface

Mode VLAN RA Guard

VLAN

Enable IPv6 Explicitly Enabled

Enable ND managed-config-flag Enabled

Enable ND other-config-flag Enabled

Enable ND ra suppress Enabled

MTU (1280-85535) bytes

ND DAD Attempts (0-255)

ND NS Interval (1000-3600000) ms

ND Reachable-Time (0-3600000) ms

To configure RA Guard for the switch:

1. Click **IP > IPv6 Configuration**.
2. Select Configure Interface from the Action list.
3. Select RA Guard mode.
4. Enable RA Guard for untrusted interfaces.
5. Click **Apply**.

IP > IPv6 Configuration

Action: Configure Interface

Mode VLAN RA Guard

Interface Port Trunk

Port List Total: 18

Port	RA Guard
1	<input type="checkbox"/> Enabled
2	<input type="checkbox"/> Enabled
3	<input type="checkbox"/> Enabled
4	<input type="checkbox"/> Enabled
5	<input type="checkbox"/> Enabled

Configuring IPv6 Neighbor Addresses

Use the IP > IPv6 Configuration > Configure Neighbor page to configure a static entry in the IPv6 neighbor discovery cache.

Usage Guidelines

- ◆ Address Resolution Protocol (ARP) has been replaced in IPv6 with the Neighbor Discovery Protocol (NDP). Configuring IPv6 neighbor

addresses is similar to configuring static MAC addresses that are implemented using ARP.

- ◆ Static entries can only be configured on an IPv6-enabled interface.
- ◆ The switch does not determine whether a static entry is reachable before placing it in the IPv6 neighbor discovery cache.
- ◆ If the specified entry was dynamically learned through the IPv6 neighbor discovery process, and already exists in the neighbor discovery cache, it is converted to a static entry. Static entries in the IPv6 neighbor discovery cache are not modified if subsequently detected by the neighbor discovery process.
- ◆ Disabling IPv6 on an interface deletes all dynamically learned entries in the IPv6 neighbor discovery cache for that interface, but does not delete static entries.

Parameters

These parameters are displayed:

- ◆ **IPv6 Address** - The IPv6 address of a neighbor device that can be reached through one of the network interfaces configured on this switch. You can specify either a link-local or global unicast address formatted according to RFC 2373 “IPv6 Addressing Architecture,” using 8 colon-separated 16-bit hexadecimal values. One double colon may be used in the address to indicate the appropriate number of zeros required to fill the undefined fields.
- ◆ **VLAN** - VLAN ID (Range: 1-4094)
- ◆ **MAC Address** - The 48-bit MAC layer address for the neighbor device. This address must be formatted as six hexadecimal pairs separated by hyphens.

Web Interface

To configure an IPv6 address:

1. Click **IP > IPv6 Configuration**.
2. Select Configure Neighbor from the Step list.
3. Select Add from the Action list.
4. Enter the IPv6 address and MAC address, then specify the VLAN ID.
5. Click **Apply**.

The screenshot shows a web interface for configuring IPv6. At the top, it says "IP > IPv6 Configuration". Below that, there's a "Step:" dropdown set to "3. Configure Neighbor" and an "Action:" dropdown set to "Add". The main form has three input fields: "IPv6 Address" (empty), "VLAN" (set to "1"), and "MAC Address" (empty). To the right of the MAC Address field is a placeholder text: "(xx-xx-xx-xx-xx-xx or xxxxxxxxxx)". At the bottom right of the form are two buttons: "Apply" and "Revert".

Configuring an IPv6 Address

Use the IP > IPv6 Configuration (Add IPv6 Address) page to configure an IPv6 interface for management access over the network, or for creating an interface to multiple subnets.

Command Usage

- ◆ All IPv6 addresses must be formatted according to RFC 2373 “IPv6 Addressing Architecture,” using 8 colon-separated 16-bit hexadecimal values. One double colon may be used in the address to indicate the appropriate number of zeros required to fill the undefined fields.
- ◆ The switch must always be configured with a link-local address. Therefore any configuration process that enables IPv6 functionality, or assigns a global unicast address to the switch, including address auto-configuration or explicitly enabling IPv6 IPv6 (see Configuring IPv6 Interface Settings), will also automatically generate a link-local unicast address. The prefix length for a link-local address is fixed at 64 bits, and the host portion of the default address is based on the modified EUI-64 (Extended Universal Identifier) form of the interface identifier (i.e., the physical MAC address). Alternatively, you can manually configure the link-local address by entering the full address with a network prefix in the range of FE80~FEBF.
- ◆ To connect to a larger network with multiple subnets, you must configure a global unicast address. There are several alternatives to configuring this address type:
 - ◆ The global unicast address can be automatically configured by taking the network prefix from router advertisements observed on the local interface, and using the modified EUI-64 form of the interface identifier to automatically create the host portion of the address (see Configuring IPv6 Interface Settings).
 - ◆ It can be manually configured by specifying the entire network prefix and prefix length, and using the EUI-64 form of the interface identifier

to automatically create the low-order 64 bits in the host portion of the address.

- ◆ You can also manually configure the global unicast address by entering the full address and prefix length.
- ◆ You can configure multiple IPv6 global unicast addresses per interface, but only one link-local address per interface.
- ◆ If a duplicate link-local address is detected on the local segment, this interface is disabled and a warning message displayed on the console. If a duplicate global unicast address is detected on the network, the address is disabled on this interface and a warning message displayed on the console.
- ◆ When an explicit address is assigned to an interface, IPv6 is automatically enabled, and cannot be disabled until all assigned addresses have been removed.

Parameters

These parameters are displayed:

- ◆ **VLAN** – ID of a configured VLAN which is to be used for management access, or for creating an interface to multiple subnets. By default, all ports on the switch are members of VLAN 1. However, the management station can be attached to a port belonging to any VLAN, as long as that VLAN has been assigned an IP address. (Range: 1-4094)
- ◆ **IPv6 Address Mode** – Defines the IPv6 address mode for the VLAN interface.
 - ◆ **User Specified** – Configures a specific IPv6 address based on the Address Type setting.
 - ◆ **AUTOCONFIG** – Enables stateless autoconfiguration of IPv6 addresses on an interface. The network portion of the address is based on prefixes received in IPv6 router advertisement messages; the host portion is based on the modified EUI-64 form of the interface identifier (i.e., the switch's MAC address).
 - ◆ **DHCP** – IPv6 address for the interface must be obtained from a DHCPv6 server.
- ◆ **Address Type** – Defines the address type configured for this interface.
 - ◆ **Global** – Configures an IPv6 global unicast address with a full IPv6 address including the network prefix and host address bits, followed by a forward slash, and a decimal value indicating how many contiguous bits (from the left) of the address comprise the prefix (i.e., the network portion of the address).

- ◆ **EUI-64** (Extended Universal Identifier) – Configures an IPv6 address for an interface using an EUI-64 interface ID in the low order 64 bits.
 - ◆ When using EUI-64 format for the low-order 64 bits in the host portion of the address, the value entered in the IPv6 Address field includes the network portion of the address, and the prefix length indicates how many contiguous bits (starting at the left) of the address comprise the prefix (i.e., the network portion of the address). Note that the value specified in the IPv6 Address field may include some of the high-order host bits if the specified prefix length is less than 64 bits. If the specified prefix length exceeds 64 bits, then the bits used in the network portion of the address will take precedence over the interface identifier.
 - ◆ IPv6 addresses are 16 bytes long, of which the bottom 8 bytes typically form a unique host identifier based on the device's MAC address. The EUI-64 specification is designed for devices that use an extended 8-byte MAC address. For devices that still use a 6-byte MAC address (also known as EUI-48 format), it must be converted into EUI-64 format by inverting the universal/local bit in the address and inserting the hexadecimal number FFFE between the upper and lower three bytes of the MAC address.

For example, if a device had an EUI-48 address of 28-9F-18-1C-82-35, the global/local bit must first be inverted to meet EUI-64 requirements (i.e., 1 for globally defined addresses and 0 for locally defined addresses), changing 28 to 2A. Then the two bytes FFFE are inserted between the OUI (i.e., organizationally unique identifier, or company identifier) and the rest of the address, resulting in a modified EUI-64 interface identifier of 2A-9F-18-FF-FE-1C-82-35.
 - ◆ This host addressing method allows the same interface identifier to be used on multiple IP interfaces of a single device, as long as those interfaces are attached to different subnets.
- ◆ **Link Local** – Configures an IPv6 link-local address.
 - ◆ The address prefix must be in the range of FE80~FEBF.
 - ◆ You can configure only one link-local address per interface.
 - ◆ The specified address replaces a link-local address that was automatically generated for the interface.
- ◆ **IPv6 Address** – IPv6 address assigned to this interface.

Web Interface

To configure an IPv6 address:

1. Click **IP > IPv6 Configuration**.
2. Select Add IPv6 Address from the Action list.
3. Specify the VLAN to configure and select the address mode. For the User Specified mode, also select the type and then enter an IPv6 address and prefix length.
4. Click **Apply**.

The screenshot shows the 'IP > IPv6 Configuration' web interface. At the top, it says 'Step: 4. Add IPv6 Address'. Below this, there are several configuration options:

- VLAN:** A dropdown menu with the value '1' selected.
- IPv6 Address Mode:** A dropdown menu with 'User Specified' selected.
- IPv6 Address Type:** A dropdown menu with 'Global' selected.
- IPv6 Address:** An empty text input field.

 At the bottom right of the form, there are two buttons: 'Apply' and 'Revert'.

Configuring IPv6 ND Prefixes

Use the IP > IPv6 Configuration > Configure IPv6 ND Prefix (Add) page to configure IPv6 prefixes to include in router advertisements.

Usage Guidelines

- ◆ Prefixes configured as addresses on an interface are advertised in router advertisements. If prefixes are configured for advertisement using this page, then only these prefixes are advertised.
- ◆ The preferred lifetime and valid lifetime are counted down in real time. After the preferred lifetime expires, no new connections are made using this prefix. When the valid lifetime expires, this prefix will no longer be advertised.
- ◆ All prefixes are inserted in the routing table as Connected (i.e., on-line), unless specified with the off-link option. If the off-link option is specified, and the prefix is already present in the routing table as a Connected prefix, it will be removed.
- ◆ Do not include the link-local prefix in the list of advertised prefixes.

Parameters

These parameters are displayed:

- ♦ **VLAN** – ID of a configured VLAN which is to be used for management access, or for creating an interface to multiple subnets. (Range: 1-4094)
- ♦ **IPv6 Prefix** – An IPv6 address network prefix.
- ♦ **Default Value** – Uses default values for remaining parameters or can be set to User Specified.
- ♦ **Valid Lifetime** – The amount of time that the specified IPv6 prefix is advertised as being valid. (Range: 0-4294967295 seconds)
- ♦ **Preferred Lifetime** – The amount of time that the specified IPv6 prefix is advertised as being preferred. The preferred lifetime is counted down in real time. (Range: 0-4294967295 seconds)
- ♦ **No-autoconfig** – Indicates to hosts on the local link that the specified prefix cannot be used for IPv6 autoconfiguration.
- ♦ **Off-link** – Indicates that the specified prefix is assigned to the link. Nodes sending traffic to addresses that contain the prefix consider the destination to be locally reachable on the link.

Web Interface

To configure an IPv6 address:

1. Click **IP > IPv6 Configuration**.
2. Select Configure IPv6 ND Prefix from the Step list.
3. Select Add from the Action list.
4. Specify the VLAN and enter an IPv6 prefix. Set other parameters as needed.
5. Click **Apply**.

IP > IPv6 Configuration

Step: 5. Configure IPv6 nd prefix Action: Add

VLAN: 1

IPv6 Prefix:

Default Value: User Specified

Valid lifetime: 2592000

Preferred lifetime: 604800

No-autoconfig: Enabled

Off-link: Enabled

Apply Revert

Showing IPv6 Addresses

Use the IP > IPv6 Configuration (Show IPv6 Address) page to display the IPv6 addresses assigned to an interface.

Parameters

These parameters are displayed:

- ♦ **VLAN** – ID of a configured VLAN. By default, all ports on the switch are members of VLAN 1. However, the management station can be attached to a port belonging to any VLAN, as long as that VLAN has been assigned an IP address. (Range: 1-4094)
- ♦ **IPv6 Address Type** – The address type (Global, EUI-64, Link Local).
- ♦ **IPv6 Address** – An IPv6 address assigned to this interface.

In addition to the unicast addresses assigned to an interface, a node is also required to listen to the all-nodes multicast addresses FF01::1 (interface-local scope) and FF02::1 (link-local scope).

FF01::1/16 is the transient interface-local multicast address for all attached IPv6 nodes, and FF02::1/16 is the link-local multicast address for all attached IPv6 nodes. The interface-local multicast address is only used for loopback transmission of multicast traffic. Link-local multicast addresses cover the same types as used by link-local unicast addresses, including all nodes (FF02::1), all routers (FF02::2), and solicited nodes (FF02::1:FFXX:XXXX) as described below.

A node is also required to compute and join the associated solicited-node multicast addresses for every unicast and anycast address it is assigned. IPv6 addresses that differ only in the high-order bits, e.g. due to multiple high-order prefixes associated with different aggregations, will map to the same solicited-node address, thereby reducing the number of multicast addresses a node must join. In this example, FF02::1:FF90:0/104 is the solicited-node multicast address which is formed by taking the low-order 24 bits of the address and appending those bits to the prefix.

Note that the solicited-node multicast address (link-local scope FF02) is used to resolve the MAC addresses for neighbor nodes since IPv6 does not support the broadcast method used by the Address Resolution Protocol in IPv4.

These additional addresses are displayed by the “show ip interface” command described in the *CLI Reference Guide*).

- ♦ **Configuration Mode** – Indicates if this address was automatically generated or manually configured.

Web Interface

To show the configured IPv6 addresses:

1. Click **IP > IPv6 Configuration**.
2. Select Show IPv6 Address from the Action list.
3. Select a VLAN from the list.



Showing the IPv6 Neighbor Cache

Use the IP > IPv6 Configuration (Show IPv6 Neighbor Cache) page to display the IPv6 addresses detected for neighbor devices.

Parameters

These parameters are displayed:

Field	Description
IPv6 Address	IPv6 address of neighbor.
Age	The time since the address was verified as reachable (in seconds). A static entry is indicated by the value "Permanent."
Link-layer Address	Physical layer MAC address.

Field	Description
State	<p>The following states are used for dynamic entries:</p> <ul style="list-style-type: none"> ◆ Incomplete - Address resolution is being carried out on the entry. A neighbor solicitation message has been sent to the multicast address of the target, but it has not yet returned a neighbor advertisement message. ◆ Invalid - An invalidated mapping. Setting the state to invalid dis-associates the interface identified with this entry from the indicated mapping (RFC 4293). ◆ Reachable - Positive confirmation was received within the last ReachableTime interval that the forward path to the neighbor was functioning. While in Reachable state, the device takes no special action when sending packets. ◆ Stale - More than the ReachableTime interval has elapsed since the last positive confirmation was received that the forward path was functioning. While in Stale state, the device takes no action until a packet is sent. ◆ Delay - More than the ReachableTime interval has elapsed since the last positive confirmation was received that the forward path was functioning. A packet was sent within the last DELAY_FIRST_PROBE_TIME interval. If no reachability confirmation is received within this interval after entering the Delay state, the switch will send a neighbor solicitation message and change the state to Probe. ◆ Probe - A reachability confirmation is actively sought by re-sending neighbor solicitation messages every RetransTimer interval until confirmation of reachability is received. ◆ Unknown - Unknown state. <p>The following states are used for static entries:</p> <ul style="list-style-type: none"> ◆ Incomplete - The interface for this entry is down. ◆ Permanent - Indicates a static entry. ◆ Reachable - The interface for this entry is up. Reachability detection is not applied to static entries in the IPv6 neighbor discovery cache.
VLAN	VLAN interface from which the address was reached.

Web Interface

To show neighboring IPv6 devices:

1. Click **IP > IPv6 Configuration**.
2. Select Show IPv6 Neighbors from the Action list.

IP > IPv6 Configuration

Action: Show IPv6 Neighbor Cache

Current Neighbor Cache Table Total: 1

IPv6 Address	Age	Link-layer Address	State	VLAN
2001:DB8:2222:7272::74	20	00-E0-0C-9C-CA-10	Reachable	1

Clear

Showing IPv6 Statistics

Use the IP > IPv6 Configuration (Show Statistics) page to display statistics about IPv6 traffic passing through this switch.

Command Usage

This switch provides statistics for the following traffic types:

- ♦ **IPv6** – The Internet Protocol for Version 6 addresses provides a mechanism for transmitting blocks of data (often called packets or frames) from a source to a destination, where these network devices (that is, hosts) are identified by fixed length addresses. The Internet Protocol also provides for fragmentation and reassembly of long packets, if necessary, for transmission through “small packet” networks.
- ♦ **ICMPv6** – Internet Control Message Protocol for Version 6 addresses is a network layer protocol that transmits message packets to report errors in processing IPv6 packets. ICMP is therefore an integral part of the Internet Protocol. ICMP messages may be used to report various situations, such as when a datagram cannot reach its destination, when the gateway does not have the buffering capacity to forward a datagram, and when the gateway can direct the host to send traffic on a shorter route. ICMP is also used by routers to feed back information about more suitable routes (that is, the next hop router) to use for a specific destination.
- ♦ **UDP** – User Datagram Protocol provides a datagram mode of packet switched communications. It uses IP as the underlying transport mechanism, providing access to IP-like services. UDP packets are delivered just like IP packets – connection-less datagrams that may be discarded before reaching their targets. UDP is useful when TCP would be too complex, too slow, or just unnecessary.

Parameters

These parameters are displayed:

Field	Description
IPv6 Statistics	
<i>IPv6 Received</i>	
Total	The total number of input datagrams received by the interface, including those received in error.
Header Errors	The number of input datagrams discarded due to errors in their IPv6 headers, including version number mismatch, other format errors, hop count exceeded, IPv6 options, etc.

Field	Description
Too Big Errors	The number of input datagrams that could not be forwarded because their size exceeded the link MTU of outgoing interface.
No Routes	The number of input datagrams discarded because no route could be found to transmit them to their destination.
Address Errors	The number of input datagrams discarded because the IPv6 address in their IPv6 header's destination field was not a valid address to be received at this entity. This count includes invalid addresses (e.g., ::0) and unsupported addresses (e.g., addresses with unallocated prefixes). For entities which are not IPv6 routers and therefore do not forward datagrams, this counter includes datagrams discarded because the destination address was not a local address.
Unknown Protocols	The number of locally-addressed datagrams received successfully but discarded because of an unknown or unsupported protocol. This counter is incremented at the interface to which these datagrams were addressed which might not be necessarily the input interface for some of the datagrams.
Truncated Packets	The number of input datagrams discarded because datagram frame didn't carry enough data.
Discards	The number of input IPv6 datagrams for which no problems were encountered to prevent their continued processing, but which were discarded (e.g., for lack of buffer space). Note that this counter does not include any datagrams discarded while awaiting re-assembly.
Delivers	The total number of datagrams successfully delivered to IPv6 user-protocols (including ICMP). This counter is incremented at the interface to which these datagrams were addressed which might not be necessarily the input interface for some of the datagrams.
Reassembly Request Datagrams	The number of IPv6 fragments received which needed to be reassembled at this interface. Note that this counter is incremented at the interface to which these fragments were addressed which might not be necessarily the input interface for some of the fragments.
Reassembled Succeeded	The number of IPv6 datagrams successfully reassembled. Note that this counter is incremented at the interface to which these datagrams were addressed which might not be necessarily the input interface for some of the fragments.
Reassembled Failed	The number of failures detected by the IPv6 re-assembly algorithm (for whatever reason: timed out, errors, etc.). Note that this is not necessarily a count of discarded IPv6 fragments since some algorithms (notably the algorithm in RFC 815) can lose track of the number of fragments by combining them as they are received. This counter is incremented at the interface to which these fragments were addressed which might not be necessarily the input interface for some of the fragments.
<i>IPv6 Transmitted</i>	

Field	Description
Forwards Datagrams	The number of output datagrams which this entity received and forwarded to their final destinations. In entities which do not act as IPv6 routers, this counter will include only those packets which were Source-Routed via this entity, and the Source-Route processing was successful. Note that for a successfully forwarded datagram the counter of the outgoing interface is incremented.
Requests	The total number of IPv6 datagrams which local IPv6 user-protocols (including ICMP) supplied to IPv6 in requests for transmission. Note that this counter does not include any datagrams counted in <code>ipv6IfStatsOutForwDatagrams</code> .
Discards	The number of output IPv6 datagrams for which no problem was encountered to prevent their transmission to their destination, but which were discarded (e.g., for lack of buffer space). Note that this counter would include datagrams counted in <code>ipv6IfStatsOutForwDatagrams</code> if any such packets met this (discretionary) discard criterion.
No Routes	The number of input datagrams discarded because no route could be found to transmit them to their destination.
Generated Fragments	The number of output datagram fragments that have been generated as a result of fragmentation at this output interface.
Fragment Succeeded	The number of IPv6 datagrams that have been successfully fragmented at this output interface.
Fragment Failed	The number of IPv6 datagrams that have been discarded because they needed to be fragmented at this output interface but could not be.
ICMPv6 Statistics	
<i>ICMPv6 received</i>	
Input	The total number of ICMP messages received by the interface which includes all those counted by <code>ipv6IfIcmpInErrors</code> . Note that this interface is the interface to which the ICMP messages were addressed which may not be necessarily the input interface for the messages.
Errors	The number of ICMP messages which the interface received but determined as having ICMP-specific errors (bad ICMP checksums, bad length, etc.).
Destination Unreachable Messages	The number of ICMP Destination Unreachable messages received by the interface.
Packet Too Big Messages	The number of ICMP Packet Too Big messages received by the interface.
Time Exceeded Messages	The number of ICMP Time Exceeded messages received by the interface.
Parameter Problem Messages	The number of ICMP Parameter Problem messages received by the interface.
Echo Request Messages	The number of ICMP Echo (request) messages received by the interface.

Field	Description
Echo Reply Messages	The number of ICMP Echo Reply messages received by the interface.
Router Solicit Messages	The number of ICMP Router Solicit messages received by the interface.
Router Advertisement Messages	The number of ICMP Router Advertisement messages received by the interface.
Neighbor Solicit Messages	The number of ICMP Neighbor Solicit messages received by the interface.
Neighbor Advertisement Messages	The number of ICMP Neighbor Advertisement messages received by the interface.
Redirect Messages	The number of Redirect messages received by the interface.
Group Membership Query Messages	The number of ICMPv6 Group Membership Query messages received by the interface.
Group Membership Response Messages	The number of ICMPv6 Group Membership Response messages received by the interface.
Group Membership Reduction Messages	The number of ICMPv6 Group Membership Reduction messages received by the interface.
Multicast Listener Discovery Version 2 Reports	The number of MLDv2 reports received by the interface.
<i>ICMPv6 Transmitted</i>	
Output	The total number of ICMP messages which this interface attempted to send. Note that this counter includes all those counted by icmpOutErrors.
Destination Unreachable Messages	The number of ICMP Destination Unreachable messages sent by the interface.
Packet Too Big Messages	The number of ICMP Packet Too Big messages sent by the interface.
Time Exceeded Messages	The number of ICMP Time Exceeded messages sent by the interface.
Echo Request Messages	The number of ICMP Echo (request) messages sent by the interface.
Echo Reply Messages	The number of ICMP Echo Reply messages sent by the interface.
Router Solicit Messages	The number of ICMP Router Solicitation messages sent by the interface.
Router Advertisement Messages	The number of ICMP Router Advertisement messages sent by the interface.
Neighbor Solicit Messages	The number of ICMP Neighbor Solicit messages sent by the interface.

Field	Description
Neighbor Advertisement Messages	The number of ICMP Router Advertisement messages sent by the interface.
Redirect Messages	The number of Redirect messages sent. For a host, this object will always be zero, since hosts do not send redirects.
Group Membership Query Messages	The number of ICMPv6 Group Membership Query messages sent by the interface.
Group Membership Response Messages	The number of ICMPv6 Group Membership Response messages sent.
Group Membership Reduction Messages	The number of ICMPv6 Group Membership Reduction messages sent.
Multicast Listener Discovery Version 2 Reports	The number of MLDv2 reports sent by the interface.
UDP Statistics	
Input	The total number of UDP datagrams delivered to UDP users.
No Port Errors	The total number of received UDP datagrams for which there was no application at the destination port.
Other Errors	The number of received UDP datagrams that could not be delivered for reasons other than the lack of an application at the destination port.
Output	The total number of UDP datagrams sent from this entity.

Web Interface

To show the IPv6 statistics:

1. Click **IP > IPv6 Configuration**.
2. Select Show Statistics from the Action list.
3. Click **IPv6, ICMPv6** or **UDP**.

Showing IPv6 Statistics (IPv6)

IP > IPv6

Action: Show Statistics

Type IPv6 ICMPv6 UDP

IPv6 Statistics

Total Received	55	Received Reassembled Succeeded
Received Header Errors	0	Received Reassembled Failed
Received Too Big Errors	0	Transmitted Forwards Datagrams
Received No Routes	0	Transmitted Requests
Received Address Errors	0	Transmitted Discards
Received Unknown Protocols	0	Transmitted No Routes
Received Truncated Packets	0	Transmitted Generated Fragments
Received Discards	0	Transmitted Fragment Succeeded
Received Delivers	55	Transmitted Fragment Failed
Received Reassembly Request Datagrams	0	

Clear

Showing IPv6 Statistics (ICMPv6)

IP > IPv6 Configuration

Action: Show Statistics

Type IPv6 ICMPv6 UDP

ICMPv6 Statistics

Received Input	0	Transmitted Output	0
Received Errors	0	Transmitted Destination Unreachable Messages	0
Received Destination Unreachable Messages	0	Transmitted Packet Too Big Messages	0
Received Packet Too Big Messages	0	Transmitted Time Exceeded Messages	0
Received Time Exceeded Messages	0	Transmitted Parameter Problem Message	0
Received Parameter Problem Messages	0	Transmitted Echo Request Messages	0
Received Echo Request Messages	0	Transmitted Echo Reply Messages	0
Received Echo Reply Messages	0	Transmitted Router Solicit Messages	0
Received Router Solicit Messages	0	Transmitted Router Advertisement Messages	0
Received Router Advertisement Messages	0	Transmitted Neighbor Solicit Messages	0
Received Neighbor Solicit Messages	0	Transmitted Neighbor Advertisement Messages	0
Received Neighbor Advertisement Messages	0	Transmitted Redirect Messages	0
Received Redirect Messages	0	Transmitted Group Membership Query Messages	0
Received Group Membership Query Messages	0	Transmitted Group Membership Response Messages	0
Received Group Membership Response Messages	0	Transmitted Group Membership Reduction Messages	0
Received Group Membership Reduction Messages	0	Transmitted Multicast Listener Discovery Version 2 Reports	0
Received Multicast Listener Discovery Version 2 Reports	0		

Clear

Showing IPv6 Statistics (UDP)

The screenshot shows the 'IP > IPv6' configuration page. At the top, there is a header 'IP > IPv6'. Below it, an 'Action:' dropdown menu is set to 'Show Statistics'. Underneath, there are three radio buttons for 'Type': 'IPv6', 'ICMPv6', and 'UDP', with 'UDP' selected. Below the radio buttons, the text 'UDP Statistics' is displayed. A table shows the following statistics:

Input	10
No Port Errors	0
Other Errors	0
Output	1

At the bottom right of the statistics section, there is a 'Clear' button.

Showing the MTU for Responding Destinations

Use the IP > IPv6 Configuration (Show MTU) page to display the maximum transmission unit (MTU) cache for destinations that have returned an ICMP packet-too-big message along with an acceptable MTU to this switch.

Parameters

These parameters are displayed:

Field	Description
MTU	Adjusted MTU contained in the ICMP packet-too-big message returned from this destination, and now used for all traffic sent along this path.
Since	Time since an ICMP packet-too-big message was received from this destination.
Destination Address	Address which sent an ICMP packet-too-big message.

Web Interface

To show the MTU reported from other devices:

1. Click **IP > IPv6 Configuration**.
2. Select Show MTU from the Action list.

The screenshot shows the 'IP > IPv6 Configuration' page. At the top, there is a header 'IP > IPv6 Configuration'. Below it, an 'Action:' dropdown menu is set to 'Show MTU'. Underneath, the text 'MTU Table Total: 2' is displayed. A table shows the following MTU data:

MTU	Since	Destination Address
1400	00:04:21	5000::3
1280	00:04:50	FE80::203:A0FF:FED6:141D

Chapter 19

General IP Routing

Overview

This chapter provides information on network functions including:

- ♦ *Static Routes* – Configures static routes to other network segments.
- ♦ *Routing Table* – Displays routing entries learned through statically configured entries.

This switch supports IP routing and routing path management via static routing definitions. When IP routing is functioning, this switch acts as a wire-speed router, passing traffic between VLANs with different IP interfaces, and routing traffic to external IP networks. However, when the switch is first booted, default routing can only forward traffic between local IP interfaces. As with all traditional routers, static routing must first be configured to work.

Initial Configuration

By default, all ports belong to the same VLAN and the switch provides only Layer 2 functionality. To segment the attached network, first create VLANs for each unique user group or application traffic, assign all ports that belong to the same group to these VLANs, and then assign an IP interface to each VLAN. By separating the network into different VLANs, it can be partitioned into subnetworks that are disconnected at Layer 2. Network traffic within the same subnet is still switched using Layer 2 switching. And the VLANs can now be interconnected (as required) with Layer 3 switching.

Each VLAN represents a virtual interface to Layer 3. You just need to provide the network address for each virtual interface, and the traffic between different subnetworks will be routed by Layer 3 switching.

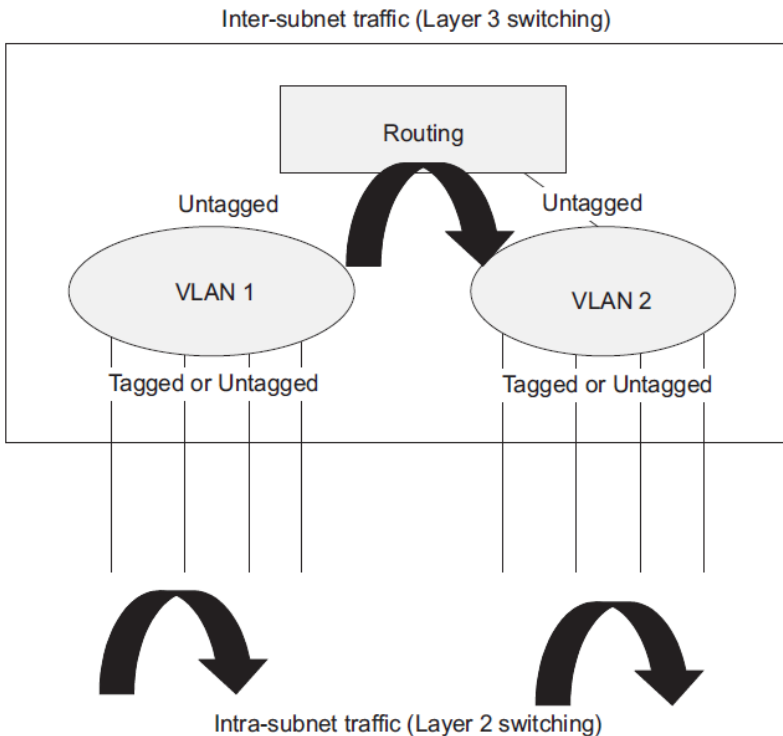

IP Routing and Switching

IP Switching (or packet forwarding) encompasses tasks required to forward packets for both Layer 2 and Layer 3, as well as traditional routing. These functions include:

- ◆ Layer 2 forwarding (switching) based on the Layer 2 destination MAC address
- ◆ Layer 3 forwarding (routing):
 - ◆ Based on the Layer 3 destination address
 - ◆ Replacing destination/source MAC addresses for each hop
 - ◆ Incrementing the hop count
 - ◆ Decrementing the time-to-live
 - ◆ Verifying and recalculating the Layer 3 checksum

If the destination node is on the same subnetwork as the source network, then the packet can be transmitted directly without the help of a router. However, if the MAC address is not yet known to the switch, an Address Resolution Protocol (ARP) packet with the destination IP address is broadcast to get the

destination MAC address from the destination node. The IP packet can then be sent directly with the destination MAC address.

If the destination belongs to a different subnet on this switch, the packet can be routed directly to the destination node. However, if the packet belongs to a subnet not included on this switch, then the packet should be sent to the next hop router (with the MAC address of the router itself used as the destination MAC address, and the destination IP address of the destination node). The router will then forward the packet to the destination node through the correct path. The router can also use the ARP protocol to find out the MAC address of the destination node of the next hop router as necessary.

Note: In order to perform IP switching, the switch should be recognized by other network nodes as an IP router, either by setting it as the default gateway or by redirection from another router via the ICMP process.

When the switch receives an IP packet addressed to its own MAC address, the packet follows the Layer 3 routing process. The destination IP address is checked against the Layer 3 address table. If the address is not already there, the switch broadcasts an ARP packet to all the ports on the destination VLAN to find out the destination MAC address. After the MAC address is discovered, the packet is reformatted and sent out to the destination. The reformat process includes decreasing the Time-To-Live (TTL) field of the IP header, recalculating the IP header checksum, and replacing the destination MAC address with either the MAC address of the destination node or that of the next hop router.

When another packet destined to the same node arrives, the destination MAC can be retrieved directly from the Layer 3 address table; the packet is then reformatted and sent out the destination port. IP switching can be done at wire-speed when the destination address entry is already in the Layer 3 address table.

If the switch determines that a frame must be routed, the route is calculated only during setup. Once the route has been determined, all packets in the current flow are simply switched or forwarded across the chosen path. This takes advantage of the high throughput and low latency of switching by enabling the traffic to bypass the routing engine once the path calculation has been performed.

Routing Path Management

Routing Path Management involves the determination and updating of all the routing information required for packet forwarding, including:

- ♦ Updating the routing table
- ♦ Updating the Layer 3 switching database

Routing Protocols

The switch supports static routing.

- ♦ Static routing requires routing information to be stored in the switch either manually or when a connection is set up by an application outside the switch.

Static Routes

You can enter static routes in the routing table using the IP > Routing > Static Routes (Add) page. Static routes may be required to force the use of a specific route to a subnet. Static routes do not automatically change in response to changes in network topology, so you should only configure a small number of stable routes to ensure network accessibility.

Command Usage

- ◆ Up to 512 static routes can be configured.
- ◆ If more than one static routes have the same lowest cost, the first route stored in the routing table will be used.

Parameters

These parameters are displayed:

- ◆ **Destination IP Address** – IP address of the destination network, subnetwork, or host.
- ◆ **Net Mask / Prefix Length** – Network mask for the associated IP subnet. This mask identifies the host address bits used for routing to specific subnets.
- ◆ **Next Hop** – IP address of the next router hop used for this route.
- ◆ **Distance** – An administrative distance indicating that this route can be overridden by other routing information. (Range: 1-255, Default: 1)

Web Interface

To configure static routes:

1. Click **IP > Routing > Static Routes**.
2. Select Add from the Action List.
3. Enter the destination address, subnet mask, and next hop router.
4. Click **Apply**.

IP > Routing > Static Routes

Action: ▾

Destination IP Address

Net Mask / Prefix Length

Next Hop

Distance (1-255) (Optional)

To display static routes:

1. Click **IP > Routing > Static Routes**.
2. Select Show from the Action List.

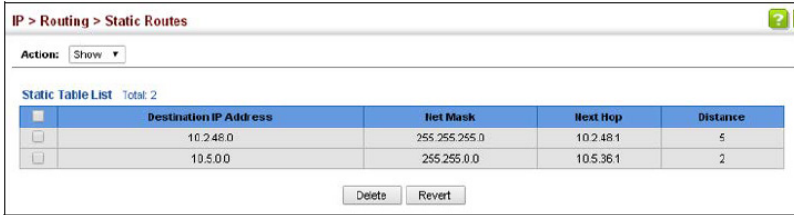

The screenshot shows a web interface for configuring static routes. The breadcrumb navigation is "IP > Routing > Static Routes". Below the navigation is an "Action:" dropdown menu set to "Show". The main content area is titled "Static Table List" with a "Total: 2" indicator. It contains a table with the following data:

<input type="checkbox"/>	Destination IP Address	Net Mask	Next Hop	Distance
<input type="checkbox"/>	10.248.0	255.255.255.0	10.248.1	5
<input type="checkbox"/>	10.5.0.0	255.255.0.0	10.5.36.1	2

Below the table are two buttons: "Delete" and "Revert".

Routing Table

Use the IP > Routing > Routing Table (Show Information) page to display all routes that can be accessed via local network interfaces through static routes. If route information is available through more than one of these methods, the priority for route selection is local and then static. Also note that the route for a local interface is not enabled (i.e., listed in the routing table) unless there is at least one active link connected to that interface.

Command Usage

- ◆ The Forwarding Information Base (FIB) contains information required to forward IP traffic. It contains the interface identifier and next hop information for each reachable destination network prefix based on the IP routing table. When routing or topology changes occur in the network, the routing table is updated, and those changes are immediately reflected in the FIB.

The FIB is distinct from the routing table (or, Routing Information Base – RIB), which holds all routing information received from routing peers.

The FIB contains unique paths only. It does not contain any secondary paths. A FIB entry consists of the minimum amount of information necessary to make a forwarding decision on a particular packet. The typical components within a FIB entry are a network prefix, a router (i.e., VLAN) interface, and next hop information.

- ◆ The Routing Table (and the “show ip route” command described in the *CLI Reference Guide*) only displays routes which are currently accessible for forwarding. The router must be able to directly reach the next hop, so the VLAN interface associated with any route entry must be up. Note that routes currently not accessible for forwarding, may still be displayed by using the “show ip route database” command described in the *CLI Reference Guide*.

Parameters

These parameters are displayed:

- ◆ **Interface** – VLAN identifier (i.e., configured as a valid IP subnet).
- ◆ **Destination IP Address** – IP address of the destination network, subnetwork, or host. Note that the address 0.0.0.0 indicates the default gateway for this router.

- ◆ **Net Mask / Prefix Length** – Network mask for the associated IP subnet. This mask identifies the host address bits used for routing to specific subnets.
- ◆ **Next Hop** – The IP address of the next hop (or gateway) in this route.
- ◆ **Metric** – Cost for this interface.
- ◆ **Protocol** – The protocol which generated this route information. (Options: Local, Static, Others)

Web Interface

To display the routing table:

1. Click **IP > Routing > Routing Table**.
2. Select Show Information from the Action List.

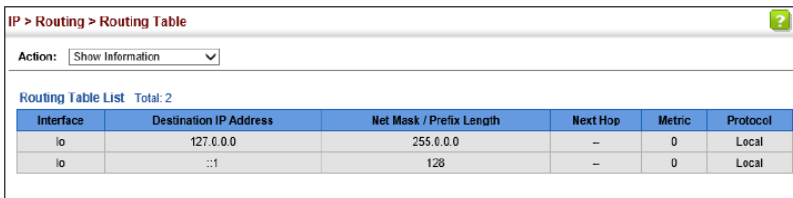

Interface	Destination IP Address	Net Mask / Prefix Length	Next Hop	Metric	Protocol
lo	127.0.0.0	255.0.0.0	–	0	Local
lo	::1	128	–	0	Local

Chapter 20

IP Services

Overview

This chapter describes the following IP services:

- ♦ *DNS* – Configures default domain names, identifies servers to use for dynamic lookup, and shows how to configure static entries.
- ♦ *Multicast DNS* – Configures multicast DNS host name-to-address mapping on the local network without the need for a dedicated DNS server.
- ♦ *DHCP* – Configures client, relay, dynamic provisioning, and DHCP server.
- ♦ *DHCPv6 Relay* – Enables the switch as a DHCPv6 Relay Agent and configures destination addresses or VLAN IDs to which client DHCPv6 messages are forwarded.
- ♦ *PPPoE Intermediate Agent* – Configures PPPoE Intermediate Agent (PPPoE IA) relay parameters required for passing authentication messages between a client and broadband remote access servers.

DNS

DNS service on this switch allows host names to be mapped to IP addresses using static table entries or by redirection to other name servers on the network. When a client device designates this switch as a DNS server, the client will attempt to resolve host names into IP addresses by forwarding DNS queries to the switch, and waiting for a response.

You can manually configure entries in the DNS table used for mapping domain names to IP addresses, configure default domain names, or specify one or more name servers to use for domain name to address translation.

Configuring General DNS Service Parameters

Use the IP Service > DNS - General (Configure Global) page to enable domain lookup and set the default domain name.

Command Usage

- ◆ To enable DNS service on this switch, enable domain lookup status, and configure one or more name servers.
- ◆ If one or more name servers are configured, but DNS is not yet enabled and the switch receives a DHCP packet containing a DNS field with a list of DNS servers, then the switch will automatically enable DNS host name-to-address translation.

Parameters

These parameters are displayed:

- ◆ **Domain Lookup** – Enables DNS host name-to-address translation. (Default: Disabled)
- ◆ **Default Domain Name** – Defines the default domain name appended to incomplete host names. Do not include the initial dot that separates the host name from the domain name. (Range: 1-127 alphanumeric characters)

Web Interface

To configure general settings for DNS:

1. Click **IP Service > DNS**.
2. Select **Configure Global** from the Action list.
3. Enable domain lookup, and set the default domain name.

4. Click **Apply**.

IP Service > DNS > General

Action: Configure Global

Domain Lookup Enabled

Default Domain Name

Apply Revert

Configuring a List of Domain Names

Use the IP Service > DNS - General (Add Domain Name) page to configure a list of domain names to be tried in sequential order.

Command Usage

- ◆ Use this page to define a list of domain names that can be appended to incomplete host names (i.e., host names passed from a client that are not formatted with dotted notation).
- ◆ If there is no domain list, the default domain name is used. If there is a domain list, the system will search it for a corresponding entry. If none is found, it will use the default domain name.
- ◆ When an incomplete host name is received by the DNS service on this switch and a domain name list has been specified, the switch will work through the domain list, appending each domain name in the list to the host name, and checking with the specified name servers for a match.
- ◆ If all name servers are deleted, DNS will automatically be disabled.

Parameters

These parameters are displayed:

- ◆ **Domain Name** – Name of the host. Do not include the initial dot that separates the host name from the domain name. (Range: 1-127 characters)

Web Interface

To create a list domain names:

1. Click **IP Service > DNS**.
2. Select Add Domain Name from the Action list.
3. Enter one domain name at a time.

4. Click **Apply**.

IP Service > DNS > General

Action: Add Domain Name

Domain Name: sample.com.uk

Apply Revert

To show the list domain names:

1. Click **IP Service > DNS**.
2. Select Show Domain Names from the Action list.

IP Service > DNS > General

Action: Show Domain Names

Domain Name List Total: 2

<input type="checkbox"/>	Domain Name
<input type="checkbox"/>	google.com
<input type="checkbox"/>	hinet.net

Delete Revert

Configuring a List of Name Servers

Use the IP Service > DNS - General (Add Name Server) page to configure a list of name servers to be tried in sequential order.

Command Usage

- ◆ To enable DNS service on this switch, configure one or more name servers, and enable domain lookup status.
- ◆ When more than one name server is specified, the servers are queried in the specified sequence until a response is received, or the end of the list is reached with no response.
- ◆ If all name servers are deleted, DNS will automatically be disabled. This is done by disabling the domain lookup status.

Parameters

These parameters are displayed:

- ◆ **Name Server IP Address** – Specifies the IPv4 or IPv6 address of a domain name server to use for name-to-address resolution. Up to six IP addresses can be added to the name server list.

Web Interface

To create a list name servers:

1. Click **IP Service > DNS**.
2. Select Add Name Server from the Action list.
3. Enter one name server at a time.
4. Click **Apply**.

The screenshot shows the 'IP Service > DNS > General' configuration page. The 'Action' dropdown menu is set to 'Add Name Server'. Below it, there is a text input field labeled 'Name Server IP Address' containing the value '192.168.1.10'. At the bottom right, there are two buttons: 'Apply' and 'Revert'.

To show the list name servers:

1. Click **IP Service > DNS**.
2. Select Show Name Servers from the Action list.

The screenshot shows the 'IP Service > DNS > General' configuration page. The 'Action' dropdown menu is set to 'Show Name Servers'. Below it, there is a table titled 'Name Server IP Address List' with a 'Total: 3' indicator. The table has a header row with a checkbox and the text 'Name Server IP Address'. Below the header, there are three rows, each with a checkbox and an IP address: 192.168.1.10, 140.113.5.7, and 10.7.231.5. At the bottom right, there are two buttons: 'Delete' and 'Revert'.

<input type="checkbox"/>	Name Server IP Address
<input type="checkbox"/>	192.168.1.10
<input type="checkbox"/>	140.113.5.7
<input type="checkbox"/>	10.7.231.5

Configuring Static DNS Host to Address Entries

Use the IP Service > DNS - Static Host Table (Add) page to manually configure static entries in the DNS table that are used to map domain names to IP addresses.

Command Usage

Static entries may be used for local devices connected directly to the attached network, or for commonly used resources located elsewhere on the network.

Parameters

These parameters are displayed:

- ♦ **Host Name** – Name of a host device that is mapped to one or more IP addresses. (Range: 1-127 characters)
- ♦ **IP Address** – IPv4 or IPv6 address(es) associated with a host name.

Web Interface

To configure static entries in the DNS table:

1. Click **IP Service > DNS > Static Host Table**.
2. Select Add from the Action list.
3. Enter a host name and the corresponding address.
4. Click **Apply**.

The screenshot shows the 'IP Service > DNS > Static Host Table' configuration page. The 'Actions' dropdown menu is set to 'Add'. Below this, there are two input fields: 'Host Name' containing 'yahoo.com' and 'IP Address' containing '10.2.78.3'. At the bottom right, there are 'Apply' and 'Revert' buttons.

To show static entries in the DNS table:

1. Click **IP Service > DNS > Static Host Table**.
2. Select Show from the Action list.

The screenshot shows the 'IP Service > DNS > Static Host Table' configuration page with the 'Actions' dropdown menu set to 'Show'. Below this, there is a table titled 'IP Address List Total: 3'. The table has three columns: 'Host', 'IP Address', and a checkbox column. The table contains three entries: 'yahoo.com' with IP '10.2.78.3', 'hinet.net' with IP '124.26.31.155', and 'google.com' with IP '133.45.211.18'. At the bottom right, there are 'Delete' and 'Revert' buttons.

<input type="checkbox"/>	Host	IP Address
<input type="checkbox"/>	yahoo.com	10.2.78.3
<input type="checkbox"/>	hinet.net	124.26.31.155
<input type="checkbox"/>	google.com	133.45.211.18

Displaying the DNS Cache

Use the IP Service > DNS - Cache page to display entries in the DNS cache that have been learned via the designated name servers.

Command Usage

Servers or other network devices may support one or more connections via multiple IP addresses. If more than one IP address is associated with a host name via information returned from a name server, a DNS client can try each address in succession, until it establishes a connection with the target device.

Parameters

These parameters are displayed:

- ◆ **No.** – The entry number for each resource record.
- ◆ **Flag** – The flag is always “4” indicating a cache entry and therefore unreliable.
- ◆ **Type** – This field includes CNAME which specifies the host address for the owner, and ALIAS which specifies an alias.
- ◆ **IP** – The IP address associated with this record.
- ◆ **TTL** – The time to live reported by the name server.
- ◆ **Host** – The host name associated with this record.

Web Interface

To display entries in the DNS cache:

1. Click **IP Service > DNS > Cache**.

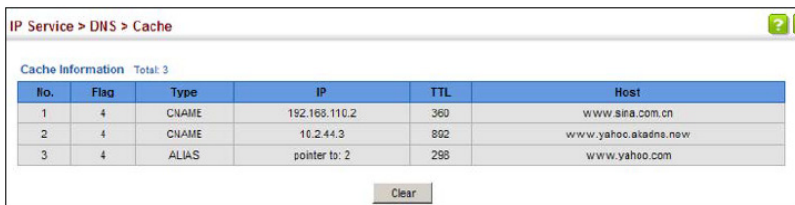

The screenshot shows a web interface window titled "IP Service > DNS > Cache". Below the title bar, there is a "Cache Information" section with a "Total: 3" count. A table displays the following data:

No.	Flag	Type	IP	TTL	Host
1	4	CNAME	192.168.110.2	360	www.sina.com.cn
2	4	CNAME	10.2.44.3	892	www.yahoo.akadns.net
3	4	ALIAS	pointer to: 2	298	www.yahoo.com

Below the table, there is a "Clear" button.

Multicast DNS

Use the IP Service > Multicast DNS page to enable multicast DNS host name-to-address mapping on the local network without the need for a dedicated DNS server.

Command Usage

- ◆ Multicast DNS allows a network device to choose a domain name in the local DNS name space and announce it using a special multicast IP address. This allows any user to give their computers a link-local mDNS host name of the form “single-dns-label.local.” Any name ending in “.local.” is therefore link-local, and names within this domain are meaningful only on the link where they originate.
- ◆ When looking for the given host’s IP address, the client sends a single-shot mDNS IP multicast query message to all the hosts sharing its local network. Any DNS query for a name ending with “.local.” is sent to the mDNS multicast address 224.0.0.251 (or its IPv6 equivalent FF02::FB). The corresponding host replies with a multicast message announcing itself. All machines in the subnet can then update their mDNS cache with the host’s information sent in the reply message.
- ◆ To maintain an on-going cache of host names requires a process of continuous multicast DNS querying. This is done in several phases:
 - ◆ Probing – The DNS responder sends a probe message to the local network in order to verify that each entry its local cache is unique.
 - ◆ Announcing – The responder sends an unsolicited mDNS Response containing all of its newly registered resource records (both shared records, and unique records that have completed the probing step).
 - ◆ Updating – The responder repeats the Announcing step to update neighbor caches when the data for any local mDNS record changes.

Parameters

These parameters are displayed:

- ◆ **Multicast DNS Status** – Enables multicast DNS host name-to-address mapping on the local network. (Default: Enabled)

Web Interface

To configure multicast DNS:

1. Click **IP Service > Multicast DNS**.
2. Mark the check box to enable or disable mDNS as required
3. Click **Apply**.

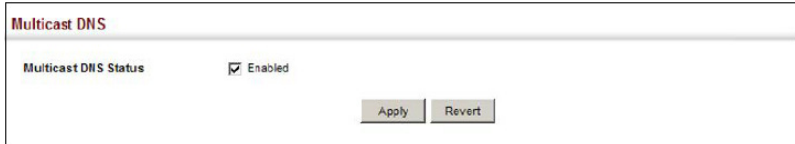

The screenshot shows a web interface for configuring Multicast DNS. At the top left, the text "Multicast DNS" is displayed in red. Below this, the label "Multicast DNS Status" is followed by a checked checkbox and the text "Enabled". At the bottom right of the interface, there are two buttons: "Apply" and "Revert".

DHCP

Dynamic Host Configuration Protocol (DHCP) can dynamically allocate an IP address and other configuration information to network clients when they boot up. If a subnet does not already include a BOOTP or DHCP server, you can relay DHCP client requests to a DHCP server on another subnet, or configure the DHCP server on this switch to support that subnet.

When configuring the DHCP server on this switch, you can configure an address pool for each unique IP interface, or manually assign a static IP address to clients based on their hardware address or client identifier. The DHCP server can provide the host's IP address, domain name, gateway router and DNS server, information about the host's boot image including the TFTP server to access for download and the name of the boot file, or boot information for NetBIOS Windows Internet Naming Service (WINS).

Specifying a DHCP Client Identifier

Use the IP Service > DHCP > Client page to specify the DHCP client identifier for a VLAN interface.

Command Usage

- ◆ The class identifier is used identify the vendor class and configuration of the switch to the DHCP server, which then uses this information to decide on how to service the client or the type of information to return.
- ◆ The general framework for this DHCP option is set out in RFC 2132 (Option 60). This information is used to convey configuration settings or other identification information about a client, but the specific string to use should be supplied by your service provider or network administrator. Options 60, 66 and 67 statements can be added to the server daemon's configuration file.

Option	Statement	
	Keyword	Parameter
60	vendor-class-identifier	a string indicating the vendor class identifier
66	tftp-server-name	a string indicating the tftp server name
67	bootfile-name	a string indicating the bootfile name

- ◆ By default, DHCP option 66/67 parameters are not carried in a DHCP server reply. To ask for a DHCP reply with option 66/67 information, the DHCP client request sent by this switch includes a "parameter request list"

asking for this information. Besides, the client request also includes a “vendor class identifier” that allows the DHCP server to identify the device, and select the appropriate configuration file for download. This information is included in Option 55 and 124.

Option	Statement	
	Keyword	Parameter
55	dhcp-parameter-request-list	a list of parameters, separated by ;
124	vendor-class-identifier	a string indicating the vendor class identifier

- ◆ The server should reply with the TFTP server name and boot file name.
- ◆ Note that the vendor class identifier can be formatted in either text or hexadecimal, but the format used by both the client and server must be the same.

Parameters

These parameters are displayed:

- ◆ **VLAN** – ID of configured VLAN.
- ◆ **Vendor Class ID** – The following options are supported when the check box is marked to enable this feature:
 - ◆ **Default** – The default string is the model number.
 - ◆ **Text** – A text string. (Range: 1-32 characters)
 - ◆ **Hex** – A hexadecimal value. (Range: 1-64 characters)

Web Interface

To configure a DHCP client identifier:

1. Click **IP Service > DHCP > Client**.
2. Mark the check box to enable this feature. Select the default setting, or the format for a vendor class identifier. If a non-default value is used, enter a text string or hexadecimal value.
3. Click **Apply**.

IP Service > DHCP > Client

VLAN: 1

Vendor Class ID: Default | ECS4130-28T-AC

Apply Revert

Configuring DHCP L3 Relay Service

If the switch is configured to provide L3 DHCP Relay service use the IP Service > DHCP > Relay page to configure L3 DHCP relay service for attached host devices. To configure L2 or L3 DHCP relay service refer to the CLI Reference Guide DHCP Relay settings of the CLI Reference Guide - specifically the command: *ip dhcp l2/l3 relay*.

If L3 DHCP relay is enabled, and this switch sees a DHCP request broadcast, it inserts its own IP address into the request so that the DHCP server will know the subnet where the client is located. Then, the switch forwards the packet to the DHCP server. When the server receives the DHCP request, it allocates a free IP address for the DHCP client from its defined scope for the DHCP client's subnet, and sends a DHCP response back to the DHCP relay agent (i.e., this switch). This switch then passes the DHCP response received from the server to the client.

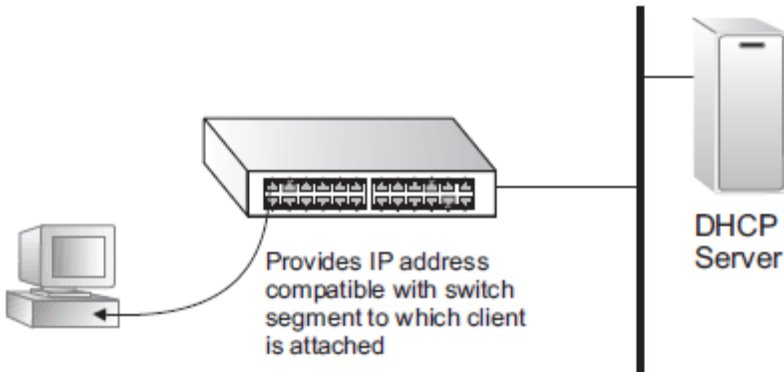

Command Usage

- ◆ You must specify the IP address for at least one active DHCP server. Otherwise, the switch's DHCP relay agent will not be able to forward client requests to a DHCP server. Up to five DHCP servers can be specified in order of preference.

If any of the specified DHCP server addresses are not located in the same network segment with this switch, specify the default router through which this switch can reach other IP subnetworks using the IP > Routing > Static Routes (Add) page or the IP > IPv6 Configuration (Configure Global) page.

- ◆ DHCP relay configuration will be disabled if an active DHCP server is detected on the same network segment.

Parameters

These parameters are displayed:

- ◆ **VLAN ID** – ID of configured VLAN.
- ◆ **Server IP Address** – Addresses of DHCP servers or relay servers to be used by the switch's DHCP relay agent in order of preference.
- ◆ **Restart DHCP Relay** – Use this button to re-initialize DHCP relay service.

Web Interface

To configure DHCP relay service:

1. Click **IP Service > DHCP > Relay** (just below Client).
2. Enter up to five IP addresses for DHCP servers or relay servers in order of preference for any VLAN.
3. Click **Apply**.

IP Service > DHCP > L3 Relay

Note: DHCP relay configuration will be disabled if an active DHCP server is detected on the same network segment.

DHCP Server by VLAN List Total: 1

VLAN	Server IP Address				
1	192.168.3.33	0.0.0.0	0.0.0.0	0.0.0.0	0.0.0.0

Click this button to restart DHCP Relay service.

Configuring DHCP Relay Service with Option 82

Use the IP Service > DHCP > Relay Option 82 page to configure DHCP relay service for attached host devices, including DHCP Option 82 information. DHCP provides an option for sending information about its DHCP clients to the DHCP server (specifically, the interface on the relay server through which the DHCP client request was received). Also known as DHCP Relay Option 82, it allows compatible DHCP servers to use this information when assigning IP addresses, or to set other services or policies for clients.

Option 82 information contains information which can identify both the relay agent and the interface through which the DHCP request was received:

- ◆ The DHCP Relay Information Option Remote ID (RID) is the access node identifier – a string used to identify the switch to the DHCP server.
- ◆ The DHCP Relay Information Option Fields are the Option 82 circuit identification fields (CID – including VLAN ID, stack unit, and port).

These fields identify the requesting device by indicating the interface through which the relay agent received the request.

If DHCP relay is enabled, and this switch sees a DHCP client request, it inserts its own IP address into the request so that the DHCP server will know the subnet where the client is located. Depending on the selected frame format set for the remote-id, this information may specify the MAC address, IP address, or an arbitrary string for the requesting device (that is, the relay agent in this context).

By default, the relay agent also fills in the Option 82 circuit-id field with information indicating the local interface over which the switch received the DHCP client request, including the VLAN ID, stack unit, and port. This allows DHCP client-server exchange messages to be forwarded between the server and client without having to flood them onto the entire VLAN.

The switch then forwards the packet to the DHCP server. When the server receives the DHCP request, it allocates a free IP address for the DHCP client from its defined scope for the DHCP client's subnet, and sends a DHCP response back to the DHCP relay agent (i.e., this switch). This switch then passes the DHCP response received from the server to the client.

Command Usage

- ◆ You must specify the IP address for at least one active DHCP server. Otherwise, the switch's DHCP relay agent will not be able to forward client requests to a DHCP server. Up to five DHCP servers can be specified in order of preference.

If any of the specified DHCP server addresses are not located in the same network segment with this switch, specify the default router through which this switch can reach other IP subnetworks.

- ◆ DHCP Snooping Information Option 82 and DHCP Relay Information Option 82 cannot both be enabled at the same time.
- ◆ DHCP request packets received by the switch are handled as follows:
 - ◆ If a DHCP relay server has been set on the switch, when the switch receives a DHCP request packet *without* Option 82 information from the management VLAN or a non-management VLAN, it will add Option 82 relay information and the relay agent's address to the DHCP request packet, and then unicast it to the DHCP server.
 - ◆ If a DHCP relay server has been set on the switch, when the switch receives a DHCP request packet *with* Option 82 information from the management VLAN or a non-management VLAN, it will process it according to the configured relay information option policy:

- ◆ If the policy is “replace,” the DHCP request packet’s Option 82 content (the RID and CID sub-option) is replaced with information provided by the switch. The relay agent address is inserted into the DHCP request packet, and the switch then unicasts this packet to the DHCP server.
 - ◆ If the policy is “keep,” the DHCP request packet’s Option 82 content will be retained. The relay agent address is inserted into the DHCP request packet, and the switch then unicasts this packet to the DHCP server.
 - ◆ If the policy is “drop,” the original DHCP request packet is flooded onto the VLAN which received the packet but is not relayed.
- ◆ DHCP reply packets received by the relay agent are handled as follows: When the relay agent receives a DHCP reply packet with Option 82 information over the management VLAN, it first ensures that the packet is destined for it.
 - ◆ If the RID in the DHCP reply packet is not identical with that configured on the switch, the Option 82 information is retained, and the packet is flooded onto the VLAN through which it was received.
 - ◆ If the RID in the DHCP reply packet matches that configured on the switch, it then removes the Option 82 information from the packet, and sends it on as follows:
 - ◆ If the DHCP packet’s broadcast flag is on, the switch uses the circuit-id information contained in the Option 82 information fields to identify the VLAN connected to the requesting client and then broadcasts the DHCP reply packet to this VLAN.
 - ◆ If the DHCP packet’s broadcast flag is off, the switch uses the circuit-id information in Option 82 fields to identify the interface connected to the requesting client and unicasts the reply packet to the client.
 - ◆ DHCP packets are flooded onto the VLAN which received them if DHCP relay service is enabled on the switch and any of the following situations apply:
 - ◆ There is no DHCP relay server set on the switch, when the switch receives a DHCP packet.
 - ◆ A DHCP relay server has been set on the switch, when the switch receives a DHCP request packet with a non-zero relay agent address field (that is not the address of this switch).

- ◆ A DHCP relay server has been set on the switch, when the switch receives DHCP reply packet without Option 82 information from the management VLAN.
- ◆ The reply packet contains a valid relay agent address field (that is not the address of this switch), or receives a reply packet with a zero relay agent address through the management VLAN.
- ◆ A DHCP relay server has been set on the switch, and the switch receives a reply packet on a non-management VLAN.

Parameters

These parameters are displayed:

- ◆ **Insertion of Relay Information** – Enable DHCP Option 82 information relay. (Default: Disabled)
- ◆ **DHCP Option Policy** – Specifies how to handle client requests which already contain DHCP Option 82 information:
 - ◆ **Drop** - Floods the original request packet onto the VLAN that received it instead of relaying it. (This is the default.)
 - ◆ **Keep** - Retains the Option 82 information in the client request, inserts the relay agent's address, and unicasts the packet to the DHCP server.
 - ◆ **Replace** - Replaces the Option 82 information circuit-id and remote-id fields in the client's request with information provided by the relay agent itself, inserts the relay agent's address, and unicasts the packet to the DHCP server.
- ◆ **DHCP Sub-option Format** – Specifies whether or not to use the sub-type and sub-length fields in the circuit-ID (CID) and remote-ID (RID) in Option 82 information. (Default: Included)
- ◆ **DHCP Remote ID Sub-option** – Sets the remote ID to the switch's IP address, MAC address, or a user-specified string. (Default: MAC Address (Hex Encoded))
 - ◆ **IP Address (Hex/ASCII encoded)** - Inserts an IP address in the remote ID sub-option for the DHCP relay (that is, the IP address of the of the switch's CPU).
 - ◆ **MAC Address (Hex/ASCII encoded)** - Inserts a MAC address in the remote ID sub-option for the DHCP relay (that is, the MAC address of the switch's CPU).
 - ◆ **String** - An arbitrary string inserted into the remote identifier field. (Range: 1-32 characters)

Web Interface

To configure DHCP relay service:

1. Click **IP Service > DHCP > Relay Option 82**.
2. Enable or disable the Option 82 relay information.
3. Set the Option 82 policy to specify how to handle Option 82 information already contained in DHCP client request packets.
4. Specify whether or not include “type” and “length” sub-options.
5. Select how to set the Remote ID sub-option.
6. Click **Apply**.

The screenshot shows a web interface for configuring DHCP Relay Option 82. The breadcrumb path is "IP Service > DHCP > Relay Option 82". Under the "Information" section, there are four configuration items:

- Insertion of Relay Information:** A checkbox labeled "Enabled" which is currently unchecked.
- DHCP Option Policy:** A dropdown menu currently set to "Drop".
- DHCP Sub-option Format:** A dropdown menu currently set to "Extra Subtype Included".
- DHCP Remote ID Sub-option:** A dropdown menu currently set to "MAC Address (Hex Encoded)" followed by an empty text input field.

At the bottom of the configuration area, there are two buttons: "Apply" and "Revert".

Enabling DHCP Dynamic Provision

Use the IP Service > DHCP > Dynamic Provision to enable dynamic provisioning via DHCP.

Command Usage

DHCPD is the daemon used by Linux to dynamically configure TCP/IP information for client systems. To support DHCP option 66/67, you have to add corresponding statements to the configuration file of DHCPD. Information on how to complete this process are described in “Downloading a Configuration File and Other Parameters Provided by a DHCP Server” as described in the *CLI Reference Guide*.

Some alternative commands which can be added to the DHCPD to complete the dynamic provisioning process are also described under the **ip dhcp dynamic-provision** command in the *CLI Reference Guide*.

By default, the parameters for DHCP option 66/67 are not carried by the reply sent from the DHCP server. To ask for a DHCP reply with option 66/67, the client can inform the server that it is interested in option 66/67 by sending a DHCP request that includes a 'parameter request list' option. Besides this, the client can also send a DHCP request that includes a 'vendor class identifier'

option to the server so that the DHCP server can identify the device, and determine what information should be given to requesting device.

Parameters

These parameters are displayed:

- ◆ **Dynamic Provision via DHCP Status** – Enables dynamic provisioning via DHCP. (Default: Disabled)

Web Interface

To enable dynamic provisioning via DHCP:

1. Click **IP Service > DHCP > Dynamic Provision**.
2. Mark the Enable box if dynamic provisioning is configured on the DHCP daemon, and required for bootup.
3. Click **Apply**.

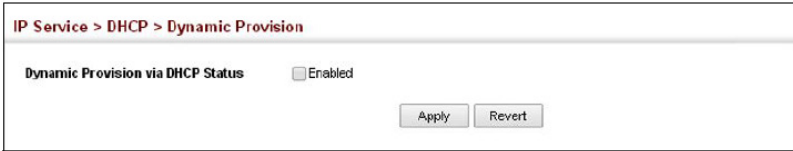

Configuring the DHCP Server

This switch includes a Dynamic Host Configuration Protocol (DHCP) server that can assign temporary IP addresses to any attached host requesting service. It can also provide other network settings such as the domain name, default gateway, Domain Name Servers (DNS), Windows Internet Naming Service (WINS) name servers, or information on the bootup file for the host device to download.

Addresses can be assigned to clients from a common address pool configured for a specific IP interface on this switch, or fixed addresses can be assigned to hosts based on the client identifier code or MAC address.

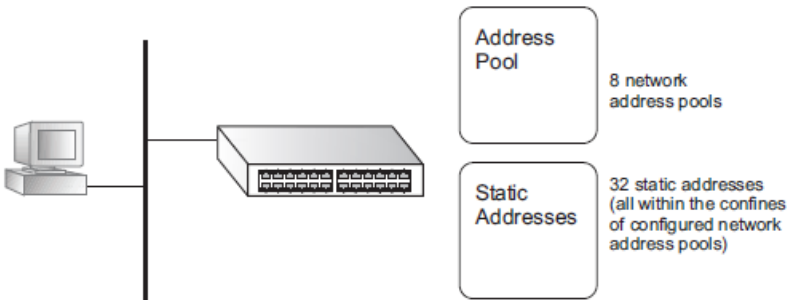

Command Usage

- ◆ First configure any excluded addresses, including the address for this switch.
- ◆ Then configure address pools for the network interfaces. You can configure up to 8 network address pools. You can also manually bind an address to a specific client if required. However, any fixed addresses must fall within the range of an existing network address pool. You can configure up to 32 fixed host addresses (i.e., entering one address per pool).
- ◆ If the DHCP server is running, you must disable it and then re-enable it to implement any configuration changes. This can be done on the IP Service > DHCP > Server (Configure Global) page.

Enabling the Server

Use the IP Service > DHCP > Server (Configure Global) page to enable the DHCP Server.

Parameters

These parameters are displayed:

- ◆ **DHCP Server** – Enables or disables the DHCP server on this switch. (Default: Disabled)

Web Interface

To enable the DHCP server:

1. Click **IP Service > DHCP > Server**.
2. Select Configure Global from the Step list.
3. Mark the Enabled box.
4. Click **Apply**.

IP Service > DHCP > Server

Step: 1. Configure Global

DHCP Server Enabled

Note:
 You must configure an address pool before enabling the DHCP server.
 If the DHCP server is running, you must restart it to implement any configuration changes.

Apply Revert

Setting Excluded Addresses

Use the IP Service > DHCP > Server (Configure Excluded Addresses – Add) page to specify the IP addresses that should not be assigned to clients.

Parameters

These parameters are displayed:

- ◆ **Start IP Address** – Specifies a single IP address or the first address in a range that the DHCP server should not assign to DHCP clients.
- ◆ **End IP Address** – The last address in a range that the DHCP server should not assign to DHCP clients.

Note: Be sure you exclude the address for this switch and other key network devices.

Web Interface

To configure IP addresses excluded for DHCP clients:

1. Click **IP Service > DHCP > Server**.
2. Select Configure Excluded Addresses from the Step list.
3. Select Add from the Action list.
4. Enter a single address or an address range.
5. Click **Apply**.

The screenshot shows a web interface for configuring DHCP excluded addresses. At the top, it says "IP Service > DHCP > Server". Below that, there are two dropdown menus: "Step: 2. Configure Excluded Address" and "Action: Add". The main form has two input fields: "Start IP Address" with the value "10.1.0.250" and "End IP Address" with the value "10.1.0.254". The "End IP Address" field has "(optional)" written next to it. At the bottom right of the form, there are two buttons: "Apply" and "Revert".

To show the IP addresses excluded for DHCP clients:

1. Click **IP Service > DHCP > Server**.
2. Select Configure Excluded Addresses from the Step list.
3. Select Show from the Action list.

The screenshot shows the configuration page for DHCP Excluded Address List. At the top, the breadcrumb is "IP Service > DHCP > Server". Below it, the "Step" is "2. Configure Excluded Address" and the "Action" is "Show". The main section is titled "DHCP Excluded Address List" with a "Total: 1" count. It contains a table with two columns: "Start IP Address" and "End IP Address". There is one entry in the table with a checkbox in the first column, a start address of "10.1.0.250", and an end address of "10.1.0.254". Below the table are "Delete" and "Revert" buttons.

<input type="checkbox"/>	Start IP Address	End IP Address
<input type="checkbox"/>	10.1.0.250	10.1.0.254

Configuring Address Pools

Use the IP Service > DHCP > Server (Configure Pool – Add) page configure IP address pools for each IP interface that will provide addresses to attached clients via the DHCP server.

Command Usage

- ◆ First configure address pools for the network interfaces. Then you can manually bind an address to a specific client if required. However, note that any static host address must fall within the range of an existing network address pool. You can configure up to 8 network address pools, and up to 32 manually bound host address pools (i.e., one address per host pool). Just note that any address specified in a host address pool must fall within the range of a configured network address pool.
- ◆ When a client request is received, the switch first checks for a network address pool matching the gateway where the request originated (i.e., if the request was forwarded by a relay server). If there is no gateway in the client request (i.e., the request was not forwarded by a relay server), the switch searches for a network pool matching the interface through which the client request was received. It then searches for a manually configured host address that falls within the matching network pool. If no manually configured host address is found, it assigns an address from the matching network address pool. However, if no matching address pool is found the request is ignored.
- ◆ When searching for a manual binding, the switch compares the client identifier and then the hardware address for DHCP clients. Since BOOTP clients cannot transmit a client identifier, you must configure a hardware address for this host type. If no manual binding has been specified for a host entry with a hardware address or client identifier, the switch will assign an address from the first matching network pool.
- ◆ If the subnet mask is not specified for network or host address pools, the class A, B, or C natural mask is used. The DHCP server assumes that all host addresses are available. You can exclude subsets of the address space

by using the IP Service > DHCP > Server (Configure Excluded Addresses – Add) page.

Parameters

These parameters are displayed:

Creating a New Address Pool

- ◆ **Pool Name** – A string or integer. (Range: 1-32 characters)
- ◆ **Type** – Sets the address pool type to Network or Host.

Setting Parameters for a Network Pool

- ◆ **IP** – The IP address of the DHCP address pool.
- ◆ **Subnet Mask** – The bit combination that identifies the network (or subnet) and the host portion of the DHCP address pool.

Setting Parameters for a Static Host

- ◆ **IP** – The IP address to assign to the host.
- ◆ **Subnet Mask** – Specifies the network mask of the client.
- ◆ **Client-Identifier** – A unique designation for the client device, either a text string (1-15 characters) or hexadecimal value. The information included in the identifier is based on RFC 2132 Option 60, and must be unique for all clients in the same administrative domain.
- ◆ **Hardware Address** – Specifies the MAC address and protocol used on the client. (Options: Ethernet, IEEE802, FDDI, None; Default: Ethernet)

Setting Optional Parameters

- ◆ **Default Router** – The IP address of the primary and alternate gateway router. The IP address of the router should be on the same subnet as the client.
- ◆ **DNS Server** – The IP address of the primary and alternate DNS server. DNS servers must be configured for a DHCP client to map host names to IP addresses.
- ◆ **Netbios Server** – IP address of the primary and alternate NetBIOS Windows Internet Naming Service (WINS) name server used for Microsoft DHCP clients.
- ◆ **Netbios Type** – NetBIOS node type for Microsoft DHCP clients. (Options: Broadcast, Hybrid, Mixed, Peer to Peer; Default: Hybrid)
- ◆ **Domain Name** – The domain name of the client. (Range: 1-128 characters)

- ◆ **Bootfile** – The default boot image for a DHCP client. This file should be placed on the Trivial File Transfer Protocol (TFTP) server specified as the Next Server.
- ◆ **Next Server** – The IP address of the next server in the boot process, which is typically a Trivial File Transfer Protocol (TFTP) server.
- ◆ **Lease Time** – The duration that an IP address is assigned to a DHCP client. (Options: Finite, Infinite; Default: Infinite)
The lease time configured by this attribute will be overridden by a DHCP client request that includes an Option 51 lease time.

Web Interface

To configure DHCP address pools:

1. Click **IP Service > DHCP > Server**.
2. Select Configure Pool from the Step list.
3. Select Add from the Action list.
4. Input a Pool Name and click Apply.
5. Select Configure Detail from the Action list.
6. Set the pool Type to Network or Host.
7. Enter the IP address and subnet mask for a network pool or host. If configuring a static binding for a host, enter the client identifier or hardware address for the host device. Configure the optional parameters such as a gateway server and DNS server.
8. Click **Apply**.

Configuring DHCP Server Address Pools (Network)

IP Service > DHCP > Server

Step: 3. Configure Pool Action: Configure Detail

Pool Name: tps
 Type: Network
 IP: 10.1.0.0
 Subnet Mask: 255.255.255.0

<<Option>>

Default Router	10.1.0.253	Default Router 2	0.0.0.0
DNS Server	10.2.3.4	DNS Server 2	0.0.0.0
Netbios Server	10.1.0.33	Netbios Server 2	0.0.0.0
Netbios Type	Hybrid	Domain Name	example.com
Bootfile	wme.bat	Next Server	10.1.0.21
Lease Time	Infinite		

Apply Revert

Configuring DHCP Server Address Pools (Host)

IP Service > DHCP > Server

Step: 3. Configure Pool Action: Configure Detail

Pool Name: mgr
 Type: Host
 IP: 10.1.0.19
 Subnet Mask: 255.255.255.0
 Client Identifier: Text bear
 Hardware Address: Ethernet 00-e0-29-34-26 (xx-xx-xx-xx-xx-xx or xxxxxxxxxxxx)

<<Option>>

Default Router	10.1.0.253	Default Router 2	0.0.0.0
DNS Server	10.2.3.4	DNS Server 2	0.0.0.0
Netbios Server	0.0.0.0	Netbios Server 2	0.0.0.0
Netbios Type	Hybrid	Domain Name	example.com
Bootfile	wme.bat	Next Server	10.1.0.21
Lease Time	Infinite		

Apply Revert

To show the configured DHCP address pools:

1. Click **IP Service > DHCP > Server**.
2. Select Configure Pool from the Step list.
3. Select Show from the Action list.

The screenshot shows the configuration page for IP Service > DHCP > Server. The 'Step' is set to '3. Configure Pool' and the 'Action' is 'Show'. Below this, the 'DHCP Pool List' is displayed with a total of 2 pools. The table has two columns: a checkbox and 'Pool Name'. The rows are 'mgr' and 'tps'. At the bottom, there are 'Delete' and 'Revert' buttons.

IP Service > DHCP > Server	
Step: 3. Configure Pool	Action: Show
DHCP Pool List Total: 2	
<input type="checkbox"/>	Pool Name
<input type="checkbox"/>	mgr
<input type="checkbox"/>	tps
<input type="button" value="Delete"/> <input type="button" value="Revert"/>	

Displaying Address Bindings

Use the IP Service > DHCP > Server (Show IP Binding) page display the host devices which have acquired an IP address from this switch's DHCP server.

Parameters

These parameters are displayed:

- ◆ **IP Address** – IP address assigned to host.
- ◆ **MAC Address** – MAC address of host.
- ◆ **Lease Time** – Duration that this IP address can be used by the host.
- ◆ **Start Time** – Time this address was assigned by the switch.

Web Interface

To show the addresses assigned to DHCP clients:

1. Click **IP Service > DHCP > Server**.
2. Select Show IP Binding from the Step list.

The screenshot shows the configuration page for IP Service > DHCP > Server. The 'Step' is set to '4. Show IP Binding'. Below this, the 'IP Binding List' is displayed with a total of 1 binding. The table has five columns: a checkbox, 'IP Address', 'MAC Address', 'Lease Time', and 'Start Time'. The row shows '192.168.2.61', '00-60-8E-00-5F-A1', 'Infinite', and 'Dec 7 12:20:50 2009'. At the bottom, there are 'Delete' and 'Revert' buttons.

IP Service > DHCP > Server				
Step: 4. Show IP Binding				
IP Binding List Total: 1				
<input type="checkbox"/>	IP Address	MAC Address	Lease Time	Start Time
<input type="checkbox"/>	192.168.2.61	00-60-8E-00-5F-A1	Infinite	Dec 7 12:20:50 2009
<input type="button" value="Delete"/> <input type="button" value="Revert"/>				

DHCPv6 Relay

Use IP Service > DHCPv6 > Relay (Add) page to enable the switch as a DHCPv6 Relay Agent and configure destination addresses or VLAN IDs to which client DHCPv6 messages are forwarded. When the relay agent is enabled on a specified VLAN, the switch listens to UDP port 547 for DHCPv6 messages on that VLAN. The agent will forward the messages to the configured unicast addresses or to a multicast address on configured VLANs or all VLANs.

Command Usage

- ◆ When the unicast addresses of the DHCPv6 servers or other relay agents are known, configure the addresses for each VLAN that will use the IPv6 DHCP relay service.
- ◆ Up to five DHCPv6 server or relay agent unicast addresses can be configured.
- ◆ Use the “Multicast mode”, if you do not know the Unicast destination address of the DHCPv6 servers or other relay agents.
- ◆ All associated VLANs must have their L3 interface enabled using the VLAN > Static (Action:Modify) page.
- ◆ The relay agent is enabled when at least one configured VLAN has an entry is listed in the IP Service > DHCPv6 > Relay (Action: Show) page.
- ◆ The relay agent is disabled if there are no entries for all configured VLANs in the IP Service > DHCPv6 > Relay (Action: Show) page.

Parameters

These parameters are displayed:

- ◆ **VLAN** – ID of the configured VLAN.
- ◆ **Mode:**
 - ◆ **Unicast** - To forward the client IPv6 DHCP messages to a specific destination address(es), select the Unicast mode.
 - ◆ **Multicast** - To forward the client IPv6 DHCP messages to all available servers on configured VLANs, select the Multicast mode. In this mode the DHCPv6 agent forwards DHCPv6 messages to the IPv6 DHCP multicast address known as “All_DHCP_Servers” (FF05::1:3) which both DHCPv6 servers and relay agents listen to.

- ◆ **Destination IP** - When Unicast mode is selected, enter an IPv6 address of a DHCPv6 server or relay agent (Maximum: 5 for each configured VLAN).
- ◆ **Destination VLAN** – When Multicast mode is selected, select a configured VLAN or “All” (all VLANs). The DHCPv6 messages will be forwarded on the configured VLANs or all VLANs using the “All_DHCP_Servers” address.

Web Interface

To enable the switch’s DHCPv6 Relay Agent for Unicast mode:

1. Click **IP Service > DHCPv6 > Relay (Action:Add)**.
2. Select a VLAN from the VLAN drop-down list.
3. Select Unicast from the Mode drop-down list.
4. Input the server or relay agent’s IPv6 address in the destination IP field.
5. Click **Apply**.

The screenshot shows the configuration page for the DHCPv6 Relay Agent in Unicast mode. The breadcrumb navigation is "IP Service > DHCPv6 > Relay". The "Action" dropdown is set to "Add". The "VLAN" dropdown is set to "1". The "Mode" dropdown is set to "Unicast". The "Destination IP" field contains the IPv6 address "2001:0db6:85a3:0000:0000:0a2e:0370:7334". At the bottom right, there are "Apply" and "Revert" buttons.

To enable the switch’s DHCPv6 Relay Agent for Multicast mode:

1. Click **IP Service > DHCPv6 > Relay (Action:Add)**.
2. Select a VLAN from the VLAN drop-down list.
3. Select Multicast from the Mode drop-down list.
4. Select a destination VLAN or All (VLANs) from the Destination VLAN drop-down list.
5. Click **Apply**.

The screenshot shows the configuration page for the DHCPv6 Relay Agent in Multicast mode. The breadcrumb navigation is "IP Service > DHCPv6 > Relay". The "Action" dropdown is set to "Add". The "VLAN" dropdown is set to "1". The "Mode" dropdown is set to "Multicast". The "Destination VLAN" dropdown is set to "All". At the bottom right, there are "Apply" and "Revert" buttons.

To show and delete the DHCP Relay Agent Unicast and Multicast entries:

1. Click **IP Service > DHCPv6 > Relay (Action:Show)**.
2. From the VLAN drop-down list, select a VLAN.
3. Either click the upper-left-most box to select all entries or click the box to the left of the specific entry(s).
4. Click **Delete**.

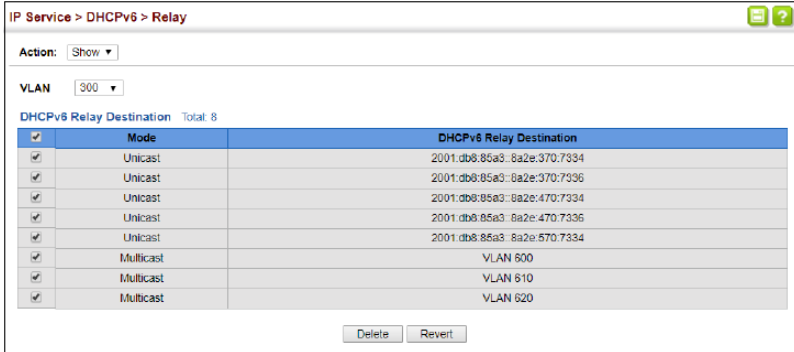

Enabling DHCPv6 Dynamic Provision

Use the IP Service > DHCPv6 > Dynamic Provision to enable dynamic provisioning via DHCPv6.

Command Usage

DHCPD is the daemon used by Linux to dynamically configure TCP/IP information for client systems. To support DHCPv6 option 59/60, you have to add corresponding statements to the configuration file of DHCPD. Information on how to complete this process are described in “Downloading a Configuration File and Other Parameters Provided by a DHCP Server” as described in the *CLI Reference Guide*.

By default, the parameters for DHCPv6 option 59/60 are not carried by the reply sent from the DHCPv6 server. To ask for a DHCPv6 reply with option 59/60, the client can inform the server that it is interested in option 59/60 by sending a DHCPv6 information request.

Parameters

These parameters are displayed:

- ♦ **Dynamic Provision via DHCPv6 Status** – Enables dynamic provisioning via DHCP. (Default: Disabled)

Web Interface

To enable dynamic provisioning via DHCPv6:

1. Click **IP Service > DHCPv6 > Dynamic Provision**.
2. Mark the Enable box if dynamic provisioning is configured on the DHCP daemon, and required for bootup.
3. Click **Apply**.

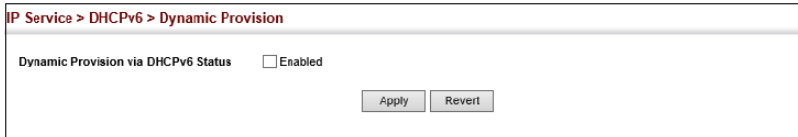

The screenshot shows a web interface window titled "IP Service > DHCPv6 > Dynamic Provision". Inside the window, there is a section labeled "Dynamic Provision via DHCPv6 Status" with a checkbox labeled "Enabled" that is currently unchecked. Below this section, there are two buttons: "Apply" and "Revert".

PPPoE Intermediate Agent

This section describes how to configure the PPPoE Intermediate Agent (PPPoE IA) relay parameters required for passing authentication messages between a client and broadband remote access servers.

Configuring PPPoE IA Global Settings

Use the IP Service > PPPoE Intermediate Agent (Configure Global) page to enable the PPPoE IA on the switch, set the access node identifier, and set the generic error message.

Command Usage

When PPPoE IA is enabled, the switch inserts a tag identifying itself as a PPPoE IA residing between the attached client requesting network access and the ports connected to broadband remote access servers (BRAS). The switch extracts access-loop information from the client's PPPoE Active Discovery Request, and forwards this information to all trusted ports (designated on the Configure Interface page). The BRAS detects the presence of the subscriber's circuit-ID tag inserted by the switch during the PPPoE discovery phase, and sends this tag as a NAS-port-ID attribute in PPP authentication and AAA accounting requests to a RADIUS server.

Parameters

These parameters are displayed:

- ◆ **PPPoE IA Global Status** – Enables the PPPoE Intermediate Agent globally on the switch. (Default: Disabled)
Note that PPPoE IA must be enabled globally before it can be enabled on an interface.
- ◆ **Access Node Identifier** – String identifying this switch as an PPPoE IA to the PPPoE server. (Range: 1-48 ASCII characters; Default: IP address of first IPv4 interface on the switch.)
The switch uses the access-node-identifier to generate the circuit-id for PPPoE discovery stage packets sent to the BRAS, but does not modify the source or destination MAC address of these PPPoE discovery packets. These messages are forwarded to all trusted ports designated on the Configure Interface page.
- ◆ **Operational Access Node Identifier** – The configured access node identifier.

- ◆ **Generic Error Message** – An error message notifying the sender that the PPPoE Discovery packet was too large. (Range: 0-127; Default: PPPoE Discover packet too large to process. Try reducing the number of tags added.)
- ◆ **Operational Generic Error Message** – The configured generic error message.

Web Interface

To configure global settings for PPPoE IA:

1. Click **IP Service > PPPoE Intermediate Agent**.
2. Select **Configure Global** from the Step list.
3. Enable the PPPoE IA on the switch, set the access node identifier, and set the generic error message.
4. Click **Apply**.

The screenshot shows the web interface for configuring PPPoE IA. The breadcrumb is "IP Service > PPPoE Intermediate Agent". The current step is "1. Configure Global". The configuration options are:

- PPPoE IA Global Status:** A checkbox labeled "Enabled" which is currently unchecked.
- Access Node Identifier:** An empty text input field.
- Operational Access Node Identifier:** A text input field containing the value "10.254.254.1".
- Generic Error Message:** An empty text input field.
- Operational Generic Error Message:** A text input field containing the default message: "PPPoE Discover packet too large to process. Try reducing the number of tags added.".

At the bottom of the form are two buttons: "Apply" and "Revert".

Configuring PPPoE IA Interface Settings

Use the IP Service > PPPoE Intermediate Agent (Configure Interface) page to enable PPPoE IA on an interface, set trust status, enable vendor tag stripping, and set the circuit ID and remote ID.

Parameters

These parameters are displayed:

- ◆ **Interface** – Port or trunk selection.
- ◆ **PPPoE IA Status** – Enables the PPPoE IA on an interface. (Default: Disabled)

Note that PPPoE IA must also be enabled globally on the switch for this command to take effect.

- ◆ **Trust Status** – Sets an interface to trusted mode to indicate that it is connected to a PPPoE server. (Default: Disabled)
 - ◆ Set any interfaces connecting the switch to a PPPoE Server as trusted. Interfaces that connect the switch to users (PPPoE clients) should be set as untrusted.
 - ◆ At least one trusted interface must be configured on the switch for the PPPoE IA to function.
- ◆ **Vendor Tag Strip** – Enables the stripping of vendor tags from PPPoE Discovery packets sent from a PPPoE server. (Default: Disabled)

This parameter only applies to trusted interfaces. It is used to strip off vendor-specific tags (which carry subscriber and line identification information) in PPPoE Discovery packets received from an upstream PPPoE server before forwarding them to a user.
- ◆ **Circuit ID** – String identifying the circuit identifier (or interface) on this switch to which the user is connected. (Range: 1-10 ASCII characters; Default: Unit/Port:VLAN-ID, or 0/Trunk-ID:VLAN-ID)
 - ◆ The PPPoE server extracts the Line-ID tag from PPPoE discovery stage messages, and uses the Circuit-ID field of that tag as a NAS-Port-ID attribute in AAA access and accounting requests.
 - ◆ The switch intercepts PPPoE discovery frames from the client and inserts a unique line identifier using the PPPoE Vendor-Specific tag (0x0105) to PPPoE Active Discovery Initiation (PADI) and Request (PADR) packets. The switch then forwards these packets to the PPPoE server. The tag contains the Line-ID of the customer line over which the discovery packet was received, entering the switch (or access node) where the intermediate agent resides.
 - ◆ Outgoing PAD Offer (PADO) and Session-confirmation (PADS) packets sent from the PPPoE Server include the Circuit-ID tag inserted by the switch, and should be stripped out of PADO and PADS packets which are to be passed directly to end-node clients.
- ◆ **Operation Circuit ID** – The configured circuit identifier.
- ◆ **Remote ID** – String identifying the remote identifier (or interface) on this switch to which the user is connected. (Range: 1-63 ASCII characters; Default: Port MAC address)
- ◆ **Operation Remote ID** – The configured circuit identifier.
- ◆ **Remote ID Delimiter** – Enables a user-specified delimiter for the remote ID.
- ◆ **Delimiter ASCII** – A character used to separate components in the remote circuit ID value. (Range: 0-255; Default: 35, ASCII character “#”)

Web Interface

To configure interface settings for PPPoE IA:

1. Click **IP Service > PPPoE Intermediate Agent**.
2. Select Configure Interface from the Step list.
3. Select Port or Trunk interface type.
4. Enable PPPoE IA on an interface, set trust status, enable vendor tag stripping if required, set the circuit ID, remote ID, or remote ID delimiter.
5. Click **Apply**.

Port	PPPoE IA Status	Trust Status	Vendor Tag Strip	Circuit ID	Operation Circuit ID	Remote ID	Operation Remote ID	Remote ID Delimiter	Delimiter ASCII (0-255)
1	<input type="checkbox"/> Enabled	<input type="checkbox"/> Enabled	<input type="checkbox"/> Enabled	<input type="text"/>	1/1.vd	<input type="text"/>	90-3C-B3-8C-44-B3	<input type="checkbox"/> Enabled	35
2	<input type="checkbox"/> Enabled	<input type="checkbox"/> Enabled	<input type="checkbox"/> Enabled	<input type="text"/>	1/2.vd	<input type="text"/>	90-3C-B3-8C-44-B4	<input type="checkbox"/> Enabled	35
3	<input type="checkbox"/> Enabled	<input type="checkbox"/> Enabled	<input type="checkbox"/> Enabled	<input type="text"/>	1/3.vd	<input type="text"/>	90-3C-B3-8C-44-B5	<input type="checkbox"/> Enabled	35
4	<input type="checkbox"/> Enabled	<input type="checkbox"/> Enabled	<input type="checkbox"/> Enabled	<input type="text"/>	1/4.vd	<input type="text"/>	90-3C-B3-8C-44-B6	<input type="checkbox"/> Enabled	35
5	<input type="checkbox"/> Enabled	<input type="checkbox"/> Enabled	<input type="checkbox"/> Enabled	<input type="text"/>	1/5.vd	<input type="text"/>	90-3C-B3-8C-44-B7	<input type="checkbox"/> Enabled	35

Showing PPPoE IA Statistics

Use the IP Service > PPPoE Intermediate Agent (Show Statistics) page to show statistics on PPPoE IA protocol messages.

Parameters

These parameters are displayed:

- ◆ **Interface** – Port or trunk selection.
- ◆ **Received** – Received PPPoE active discovery messages.
 - ◆ **All** – All PPPoE active discovery message types.
 - ◆ **PADI** – PPPoE Active Discovery Initiation messages.
 - ◆ **PADO** – PPPoE Active Discovery Offer messages.
 - ◆ **PADR** – PPPoE Active Discovery Request messages.
 - ◆ **PADS** – PPPoE Active Discovery Session-Confirmation messages.
 - ◆ **PADT** – PPPoE Active Discovery Terminate messages.
- ◆ **Dropped** – Dropped PPPoE active discovery messages.

- ◆ **Response from untrusted** – Response from an interface which not been configured as trusted.
- ◆ **Request towards untrusted** – Request sent to an interface which not been configured as trusted.
- ◆ **Malformed** – Corrupted PPPoE message.

Web Interface

To show statistics for PPPoE IA protocol messages:

1. Click **IP Service > PPPoE Intermediate Agent**.
2. Select Show Statistics from the Step list.
3. Select Port or Trunk interface type.

IP Service > PPPoE Intermediate Agent											
Step: 3 Show Statistics											
Interface <input checked="" type="radio"/> Port <input type="radio"/> Trunk											
PPPoE Intermediate Agent Statistics Total: 28											
Port	Received						Dropped				
	All	PADr	PAdR	PADr	PADs	PADt	Response from untrusted	Request towards untrusted	Malformed		
1	0	0	0	0	0	0	0	0	0	0	
2	0	0	0	0	0	0	0	0	0	0	
3	0	0	0	0	0	0	0	0	0	0	
4	0	0	0	0	0	0	0	0	0	0	
5	0	0	0	0	0	0	0	0	0	0	

Chapter 21

Appendices

Overview

This section provides additional information and includes these items:

- ♦ *Software Specifications*, page 696
- ♦ *Troubleshooting*, page 700
- ♦ *License Information*, page 702

Software Specifications

Software Features

Management Authentication	Local, RADIUS, TACACS+, Port Authentication (802.1X), HTTPS, SSH, Port Security, IP Filter
General Security Measures	Access Control Lists (512 rules), Port Authentication (802.1X), MAC Authentication, Port Security, DHCP Snooping, IP Source Guard
Port Configuration	1000BASE-T: 10/100 Mbps at half/full duplex, 1000 Mbps at full duplex 10GBASE-SR/LR/ER: 10 Gbps at full duplex (SFP+) 25GBASE-SR/LR: 25 Gbps at full duplex (SFP28)
Flow Control	Full Duplex: IEEE 802.3-2005 Half Duplex: Back pressure
Storm Control	Broadcast, multicast, or unknown unicast traffic throttled above a critical threshold
Port Mirroring	3 sessions, one or more source ports to one destination port
Rate Limits	Input/Output Limits Range configured per port
Port Trunking	Static trunks (Cisco EtherChannel compliant) Dynamic trunks (Link Aggregation Control Protocol)
Spanning Tree Algorithm	Spanning Tree Protocol (STP, IEEE 802.1D-2004) Rapid Spanning Tree Protocol (RSTP, IEEE 802.1D-2004) Multiple Spanning Tree Protocol (MSTP, IEEE 802.1D-2004)
VLAN Support	Up to 4094 groups; port-based, protocol-based, tagged (802.1Q), voice VLANs, IP subnet, MAC-based, QinQ tunnel, GVRP for automatic VLAN learning
Class of Service	Supports eight levels of priority Strict, Weighted Round Robin (WRR), or a combination of strict and weighted queuing Layer 3/4 priority mapping: IP DSCP
Quality of Service	DiffServ ¹³ supports class maps, policy maps, and service policies Note: 13. Only supported for IPv4.
Multicast Filtering	IGMP Snooping (Layer 2 IPv4) MLD Snooping (Layer 2 IPv6) Multicast VLAN Registration (IPv4)
IP Routing	ARP, CIDR (Classless Inter-Domain Routing)

Additional Features	BOOTP Client DHCP Client, Relay, Option 82 DNS Client, Proxy ERPS (Ethernet Ring Protection Switching) LLDP (Link Layer Discover Protocol) OAM (Operation, Administration, and Maintenance) RMON (Remote Monitoring, groups 1,2,3,9) SMTP Email Alerts SNMP (Simple Network Management Protocol) SNTP (Simple Network Time Protocol)
---------------------	---

Management Features

In-Band Management	Telnet, web-based HTTP or HTTPS, SNMP manager, or Secure Shell
Out-of-Band Management	RS-232 DB-9 console port
Software Loading	HTTP, FTP, SFTP, SCP, TFTP in-band, or XModem out-of-band
SNMP	Management access via MIB database Trap management to specified hosts
RMON	Groups 1, 2, 3, 9 (Statistics, History, Alarm, Event)

Standards

IEEE 802.1AB Link Layer Discovery Protocol

IEEE 802.1D-2004 Spanning Tree Algorithm and traffic priorities

Spanning Tree Protocol

Rapid Spanning Tree Protocol

Multiple Spanning Tree Protocol

IEEE 802.1p Priority tags

IEEE 802.1Q VLAN

IEEE 802.1v Protocol-based VLANs

IEEE 802.1X Port Authentication

IEEE 802.3-2005

Ethernet, Fast Ethernet, Gigabit Ethernet

Link Aggregation Control Protocol (LACP)

Full-duplex flow control (ISO/IEC 8802-3)

IEEE 802.3ac VLAN tagging

ARP (RFC 826)

DHCP Client (RFC 2131)

DHCP Relay (RFC 951, 2132, 3046)

HTTPS

ICMP (RFC 792)

IGMP (RFC 1112)

IGMPv2 (RFC 2236)

IGMP Proxy (RFC 4541)

IPv4 IGMP (RFC 3228)

MLD Snooping (RFC 4541)

NTP (RFC 1305)

RADIUS+ (RFC 2618)

RMON (RFC 2819 groups 1,2,3,9)

SNMP (RFC 1157)

SNMPv2c (RFC 1901, 2571)

SNMPv3 (RFC DRAFT 2273, 2576, 3410, 3411, 3413, 3414, 3415)

SNTP (RFC 2030)

SSH (Version 2.0)

TELNET (RFC 854, 855, 856)

TFTP (RFC 1350)

Management Information Bases

Bridge MIB (RFC 1493)

Differentiated Services MIB (RFC 3289)

DNS Resolver MIB (RFC 1612)

ERPS MIB (ITU-T G.8032)

Entity MIB (RFC 2737)

Ether-like MIB (RFC 2665)

Extended Bridge MIB (RFC 2674)

Extensible SNMP Agents MIB (RFC 2742)

Forwarding Table MIB (RFC 2096)

IGMP MIB (RFC 2933)

Interface Group MIB (RFC 2233)

Interfaces Evolution MIB (RFC 2863)

IP MIB (RFC 2011)

IP Forwarding Table MIB (RFC 2096)

IP Multicasting related MIBs

IPV6-MIB (RFC 2065)

IPV6-ICMP-MIB (RFC 2066)

IPV6-TCP-MIB (RFC 2052)

IPV6-UDP-MIB (RFC2054)

Link Aggregation MIB (IEEE 802.3ad)

MAU MIB (RFC 3636)

MIB II (RFC 1213)

NTP (RFC 1305)

P-Bridge MIB (RFC 2674P)

Port Access Entity MIB (IEEE 802.1X)

Port Access Entity Equipment MIB

Private MIB

Q-Bridge MIB (RFC 2674Q)

QinQ Tunneling (IEEE 802.1ad Provider Bridges)

Quality of Service MIB

RADIUS Accounting Server MIB (RFC 2621)

RADIUS Authentication Client MIB (RFC 2619)

RMON MIB (RFC 2819)

RMON II Probe Configuration Group (RFC 2021, partial implementation)

SNMP Community MIB (RFC 3584)

SNMP Framework MIB (RFC 3411)

SNMP-MPD MIB (RFC 3412)

SNMP Target MIB, SNMP Notification MIB (RFC 3413)

SNMP User-Based SM MIB (RFC 3414)

SNMP View Based ACM MIB (RFC 3415)

SNMPv2 IP MIB (RFC 2011)

TACACS+ Authentication Client MIB

TCP MIB (RFC 2012)

Trap (RFC 1215)

UDP MIB (RFC 2013)

Troubleshooting

Problems Accessing the Management Interface

Symptom	Action
Cannot connect using Telnet, web browser, or SNMP software	<ul style="list-style-type: none"> ◆ Be sure the switch is powered on. ◆ Check network cabling between the management station and the switch. Make sure the ends are properly connected and there is no damage to the cable. Test the cable if necessary. ◆ Check that you have a valid network connection to the switch and that the port you are using has not been disabled. ◆ Be sure you have configured the VLAN interface through which the management station is connected with a valid IP address, subnet mask and default gateway. ◆ Be sure the management station has an IP address in the same subnet as the switch's IP interface to which it is connected. ◆ If you are trying to connect to the switch via the IP address for a tagged VLAN group, your management station, and the ports connecting intermediate switches in the network, must be configured with the appropriate tag. ◆ If you cannot connect using Telnet, you may have exceeded the maximum number of concurrent Telnet/SSH sessions permitted. Try connecting again at a later time.
Cannot connect using Secure Shell	<ul style="list-style-type: none"> ◆ If you cannot connect using SSH, you may have exceeded the maximum number of concurrent Telnet/SSH sessions permitted. Try connecting again at a later time. ◆ Be sure the control parameters for the SSH server are properly configured on the switch, and that the SSH client software is properly configured on the management station. ◆ Be sure you have generated an RSA public key on the switch, exported this key to the SSH client, and enabled SSH service. Try using another SSH client or check for updates to your SSH client application. ◆ Be sure you have set up an account on the switch for each SSH user, including user name, authentication level, and password. ◆ Be sure you have imported the client's public key to the switch (if public key authentication is used).
Cannot access the on-board configuration program via a serial port connection	<ul style="list-style-type: none"> ◆ Check to see if you have set the terminal emulator program to VT100 compatible, 8 data bits, 1 stop bit, no parity, and the baud rate set to 115200 bps. ◆ Verify that you are using the DB-9 null-modem serial cable supplied with the switch. If you use any other cable, be sure that it conforms to the pin-out connections provided in the Installation Guide.

Symptom	Action
Forgot or lost the password	◆ Contact your local distributor.

Using System Logs

If a fault does occur, refer to the Installation Guide to ensure that the problem you encountered is actually caused by the switch. If the problem appears to be caused by the switch, follow these steps:

1. Enable logging.
2. Set the error messages reported to include all categories.
3. Enable SNMP.
4. Enable SNMP traps.
5. Designate the SNMP host that is to receive the error messages.
6. Repeat the sequence of commands or other actions that lead up to the error.
7. Make a list of the commands or circumstances that led to the fault. Also make a list of any error messages displayed.
8. Set up your terminal emulation software so that it can capture all console output to a file. Then enter the “show tech-support” command to record all system settings in this file.
9. Contact your distributor’s service engineer, and send a detailed description of the problem, along with the file used to record your system settings.

For example:

```
Console(config)#logging on
Console(config)#logging history flash 7
Console(config)#snmp-server host 192.168.1.23
:
```

License Information

This product includes copyrighted third-party software subject to the terms of the GNU General Public License (GPL), GNU Lesser General Public License (LGPL), or other related free software licenses. The GPL code used in this product is distributed WITHOUT ANY WARRANTY and is subject to the copyrights of one or more authors. For details, refer to the section "The GNU General Public License" below, or refer to the applicable license as included in the source-code archive.

The GNU General Public License

GNU GENERAL PUBLIC LICENSE

Version 2, June 1991

Copyright (C) 1989, 1991 Free Software Foundation, Inc.

59 Temple Place, Suite 330, Boston, MA 02111-1307 USA

Everyone is permitted to copy and distribute verbatim copies of this license document, but changing it is not allowed.

Preamble

The licenses for most software are designed to take away your freedom to share and change it. By contrast, the GNU General Public License is intended to guarantee your freedom to share and change free software--to make sure the software is free for all its users. This General Public License applies to most of the Free Software Foundation's software and to any other program whose authors commit to using it. (Some other Free Software Foundation software is covered by the GNU Library General Public License instead.) You can apply it to your programs, too.

When we speak of free software, we are referring to freedom, not price. Our General Public Licenses are designed to make sure that you have the freedom to distribute copies of free software (and charge for this service if you wish), that you receive source code or can get it if you want it, that you can change the software or use pieces of it in new free programs; and that you know you can do these things.

To protect your rights, we need to make restrictions that forbid anyone to deny you these rights or to ask you to surrender the rights. These restrictions translate to certain responsibilities for you if you distribute copies of the software, or if you modify it.

For example, if you distribute copies of such a program, whether gratis or for a fee, you must give the recipients all the rights that you have. You must make sure that they, too, receive or can get the source code. And you must show them these terms so they know their rights.

We protect your rights with two steps: (1) copyright the software, and (2) offer you this license which gives you legal permission to copy, distribute and/or modify the software.

Also, for each author's protection and ours, we want to make certain that everyone understands that there is no warranty for this free software. If the software is modified by someone else and passed on, we want its recipients to know that what they have is not the original, so that any problems introduced by others will not reflect on the original authors' reputations.

Finally, any free program is threatened constantly by software patents. We wish to avoid the danger that redistributors of a free program will individually obtain patent licenses, in effect making the program proprietary. To prevent this, we have made it clear that any patent must be licensed for everyone's free use or not licensed at all.

The precise terms and conditions for copying, distribution and modification follow.

GNU GENERAL PUBLIC LICENSE TERMS AND CONDITIONS FOR COPYING, DISTRIBUTION AND MODIFICATION

1. This License applies to any program or other work which contains a notice placed by the copyright holder saying it may be distributed under the terms of this General Public License. The "Program", below, refers to any such program or work, and a "work based on the Program" means either the Program or any derivative work under copyright law: that is to say, a work containing the Program or a portion of it, either verbatim or with modifications and/or translated into another language. (Hereinafter, translation is included without limitation in the term "modification".) Each licensee is addressed as "you".

Activities other than copying, distribution and modification are not covered by this License; they are outside its scope. The act of running the Program is not restricted, and the output from the Program is covered only if its contents constitute a work based on the Program (independent of having been made by running the Program). Whether that is true depends on what the Program does.

2. You may copy and distribute verbatim copies of the Program's source code as you receive it, in any medium, provided that you conspicuously and appropriately publish on each copy an appropriate copyright notice and

disclaimer of warranty; keep intact all the notices that refer to this License and to the absence of any warranty; and give any other recipients of the Program a copy of this License along with the Program.

You may charge a fee for the physical act of transferring a copy, and you may at your option offer warranty protection in exchange for a fee.

3. You may modify your copy or copies of the Program or any portion of it, thus forming a work based on the Program, and copy and distribute such modifications or work under the terms of Section 1 above, provided that you also meet all of these conditions:
 - a) You must cause the modified files to carry prominent notices stating that you changed the files and the date of any change.
 - b) You must cause any work that you distribute or publish, that in whole or in part contains or is derived from the Program or any part thereof, to be licensed as a whole at no charge to all third parties under the terms of this License.
 - c) If the modified program normally reads commands interactively when run, you must cause it, when started running for such interactive use in the most ordinary way, to print or display an announcement including an appropriate copyright notice and a notice that there is no warranty (or else, saying that you provide a warranty) and that users may redistribute the program under these conditions, and telling the user how to view a copy of this License. (Exception: if the Program itself is interactive but does not normally print such an announcement, your work based on the Program is not required to print an announcement.)

These requirements apply to the modified work as a whole. If identifiable sections of that work are not derived from the Program, and can be reasonably considered independent and separate works in themselves, then this License, and its terms, do not apply to those sections when you distribute them as separate works. But when you distribute the same sections as part of a whole which is a work based on the Program, the distribution of the whole must be on the terms of this License, whose permissions for other licensees extend to the entire whole, and thus to each and every part regardless of who wrote it.

Thus, it is not the intent of this section to claim rights or contest your rights to work written entirely by you; rather, the intent is to exercise the right to control the distribution of derivative or collective works based on the Program.

In addition, mere aggregation of another work not based on the Program with the Program (or with a work based on the Program) on a volume of a

storage or distribution medium does not bring the other work under the scope of this License.

4. You may copy and distribute the Program (or a work based on it, under Section 2) in object code or executable form under the terms of Sections 1 and 2 above provided that you also do one of the following:
 - a) Accompany it with the complete corresponding machine-readable source code, which must be distributed under the terms of Sections 1 and 2 above on a medium customarily used for software interchange; or,
 - b) Accompany it with a written offer, valid for at least three years, to give any third party, for a charge no more than your cost of physically performing source distribution, a complete machine-readable copy of the corresponding source code, to be distributed under the terms of Sections 1 and 2 above on a medium customarily used for software interchange; or,
 - c) Accompany it with the information you received as to the offer to distribute corresponding source code. (This alternative is allowed only for noncommercial distribution and only if you received the program in object code or executable form with such an offer, in accord with Subsection b above.)

The source code for a work means the preferred form of the work for making modifications to it. For an executable work, complete source code means all the source code for all modules it contains, plus any associated interface definition files, plus the scripts used to control compilation and installation of the executable. However, as a special exception, the source code distributed need not include anything that is normally distributed (in either source or binary form) with the major components (compiler, kernel, and so on) of the operating system on which the executable runs, unless that component itself accompanies the executable.

If distribution of executable or object code is made by offering access to copy from a designated place, then offering equivalent access to copy the source code from the same place counts as distribution of the source code, even though third parties are not compelled to copy the source along with the object code.

5. You may not copy, modify, sublicense, or distribute the Program except as expressly provided under this License. Any attempt otherwise to copy, modify, sublicense or distribute the Program is void, and will automatically terminate your rights under this License. However, parties who have received copies, or rights, from you under this License will not

have their licenses terminated so long as such parties remain in full compliance.

6. You are not required to accept this License, since you have not signed it. However, nothing else grants you permission to modify or distribute the Program or its derivative works. These actions are prohibited by law if you do not accept this License. Therefore, by modifying or distributing the Program (or any work based on the Program), you indicate your acceptance of this License to do so, and all its terms and conditions for copying, distributing or modifying the Program or works based on it.
7. Each time you redistribute the Program (or any work based on the Program), the recipient automatically receives a license from the original licensor to copy, distribute or modify the Program subject to these terms and conditions. You may not impose any further restrictions on the recipients' exercise of the rights granted herein. You are not responsible for enforcing compliance by third parties to this License.
8. If, as a consequence of a court judgment or allegation of patent infringement or for any other reason (not limited to patent issues), conditions are imposed on you (whether by court order, agreement or otherwise) that contradict the conditions of this License, they do not excuse you from the conditions of this License. If you cannot distribute so as to satisfy simultaneously your obligations under this License and any other pertinent obligations, then as a consequence you may not distribute the Program at all. For example, if a patent license would not permit royalty-free redistribution of the Program by all those who receive copies directly or indirectly through you, then the only way you could satisfy both it and this License would be to refrain entirely from distribution of the Program.

If any portion of this section is held invalid or unenforceable under any particular circumstance, the balance of the section is intended to apply and the section as a whole is intended to apply in other circumstances.

It is not the purpose of this section to induce you to infringe any patents or other property right claims or to contest validity of any such claims; this section has the sole purpose of protecting the integrity of the free software distribution system, which is implemented by public license practices. Many people have made generous contributions to the wide range of software distributed through that system in reliance on consistent application of that system; it is up to the author/donor to decide if he or she is willing to distribute software through any other system and a licensee cannot impose that choice.

This section is intended to make thoroughly clear what is believed to be a consequence of the rest of this License.

9. If the distribution and/or use of the Program is restricted in certain countries either by patents or by copyrighted interfaces, the original copyright holder who places the Program under this License may add an explicit geographical distribution limitation excluding those countries, so that distribution is permitted only in or among countries not thus excluded. In such case, this License incorporates the limitation as if written in the body of this License.
10. The Free Software Foundation may publish revised and/or new versions of the General Public License from time to time. Such new versions will be similar in spirit to the present version, but may differ in detail to address new problems or concerns.
Each version is given a distinguishing version number. If the Program specifies a version number of this License which applies to it and "any later version", you have the option of following the terms and conditions either of that version or of any later version published by the Free Software Foundation. If the Program does not specify a version number of this License, you may choose any version ever published by the Free Software Foundation.
11. If you wish to incorporate parts of the Program into other free programs whose distribution conditions are different, write to the author to ask for permission. For software which is copyrighted by the Free Software Foundation, write to the Free Software Foundation; we sometimes make exceptions for this. Our decision will be guided by the two goals of preserving the free status of all derivatives of our free software and of promoting the sharing and reuse of software generally.

NO WARRANTY

1. BECAUSE THE PROGRAM IS LICENSED FREE OF CHARGE, THERE IS NO WARRANTY FOR THE PROGRAM, TO THE EXTENT PERMITTED BY APPLICABLE LAW. EXCEPT WHEN OTHERWISE STATED IN WRITING THE COPYRIGHT HOLDERS AND/OR OTHER PARTIES PROVIDE THE PROGRAM "AS IS" WITHOUT WARRANTY OF ANY KIND, EITHER EXPRESSED OR IMPLIED, INCLUDING, BUT NOT LIMITED TO, THE IMPLIED WARRANTIES OF MERCHANTABILITY AND FITNESS FOR A PARTICULAR PURPOSE. THE ENTIRE RISK AS TO THE QUALITY AND PERFORMANCE OF THE PROGRAM IS WITH YOU. SHOULD THE

PROGRAM PROVE DEFECTIVE, YOU ASSUME THE COST OF ALL NECESSARY SERVICING, REPAIR OR CORRECTION.

2. IN NO EVENT UNLESS REQUIRED BY APPLICABLE LAW OR AGREED TO IN WRITING WILL ANY COPYRIGHT HOLDER, OR ANY OTHER PARTY WHO MAY MODIFY AND/OR REDISTRIBUTE THE PROGRAM AS PERMITTED ABOVE, BE LIABLE TO YOU FOR DAMAGES, INCLUDING ANY GENERAL, SPECIAL, INCIDENTAL OR CONSEQUENTIAL DAMAGES ARISING OUT OF THE USE OR INABILITY TO USE THE PROGRAM (INCLUDING BUT NOT LIMITED TO LOSS OF DATA OR DATA BEING RENDERED INACCURATE OR LOSSES SUSTAINED BY YOU OR THIRD PARTIES OR A FAILURE OF THE PROGRAM TO OPERATE WITH ANY OTHER PROGRAMS), EVEN IF SUCH HOLDER OR OTHER PARTY HAS BEEN ADVISED OF THE POSSIBILITY OF SUCH DAMAGES.

END OF TERMS AND CONDITIONS

Safety Instructions

General

- ◆ This product is for indoor use only.
- ◆ Read all of these instructions. Save them for future reference.
- ◆ Follow all warnings and instructions marked on the device.
- ◆ Do not place the device on any unstable surface (cart, stand, table, etc.). If the device falls, serious damage will result.
- ◆ Do not use the device near water.
- ◆ Do not place the device near, or over, radiators or heat registers.
- ◆ The device cabinet is provided with slots and openings to allow for adequate ventilation. To ensure reliable operation, and to protect against overheating, these openings must never be blocked or covered.
- ◆ The device should never be placed on a soft surface (bed, sofa, rug, etc.) as this will block its ventilation openings. Likewise, the device should not be placed in a built in enclosure unless adequate ventilation has been provided.
- ◆ Never spill liquid of any kind on the device.
- ◆ Avoid circuit overloads. Before connecting equipment to a circuit, know the power supply's limit and never exceed it. Always review the electrical specifications of a circuit to ensure that you are not creating a dangerous condition or that one doesn't already exist. Circuit overloads can cause a fire and destroy equipment.
- ◆ Unplug the device from the wall outlet before cleaning. Do not use liquid or aerosol cleaners. Use a damp cloth for cleaning.
- ◆ The device should be operated from the type of power source indicated on the marking label. If you are not sure of the type of power available, consult your dealer or local power company.
- ◆ To prevent damage to your installation it is important that all devices are properly grounded.
- ◆ The device is designed for IT power distribution systems with 230V phase-to-phase voltage.
- ◆ The device is equipped with a 3-wire grounding type plug. This is a safety feature. If you are unable to insert the plug into the outlet, contact your

electrician to replace your obsolete outlet. Do not attempt to defeat the purpose of the grounding-type plug. Always follow your local/national wiring codes.

- ◆ Do not allow anything to rest on the power cord or cables. Route the power cord and cables so that they cannot be stepped on or tripped over.
- ◆ If an extension cord is used with this device make sure that the total of the ampere ratings of all products used on this cord does not exceed the extension cord ampere rating. Make sure that the total of all products plugged into the wall outlet does not exceed 15 amperes.
- ◆ To help protect your system from sudden, transient increases and decreases in electrical power, use a surge suppressor, line conditioner, or un-interruptible power supply (UPS).
- ◆ Position system cables and power cables carefully; Be sure that nothing rests on any cables.
- ◆ When connecting or disconnecting power to hot-pluggable power supplies, observe the following guidelines:
 - ◆ Install the power supply before connecting the power cable to the power supply.
 - ◆ Unplug the power cable before removing the power supply.
 - ◆ If the system has multiple sources of power, disconnect power from the system by unplugging all power cables from the power supplies.
- ◆ Never push objects of any kind into or through cabinet slots. They may touch dangerous voltage points or short out parts resulting in a risk of fire or electrical shock.
- ◆ Do not attempt to service the device yourself. Refer all servicing to qualified service personnel.
- ◆ If the following conditions occur, unplug the device from the wall outlet and bring it to qualified service personnel for repair.
 - ◆ The power cord or plug has become damaged or frayed.
 - ◆ Liquid has been spilled into the device.
 - ◆ The device has been exposed to rain or water.
 - ◆ The device has been dropped, or the cabinet has been damaged.
 - ◆ The device exhibits a distinct change in performance, indicating a need for service.
 - ◆ The device does not operate normally when the operating instructions are followed.

-
- ◆ Only adjust those controls that are covered in the operating instructions. Improper adjustment of other controls may result in damage that will require extensive work by a qualified technician to repair.
 - ◆ Additional protection to secure and fix the equipment is needed if the equipment is installed by stacking; by locking it to the rack, screwing it to the frame, or other similar methods.
 - ◆ Keep the Cat 5e/6 cable as far away as possible from potential sources of EMI, such as electrical cables, transformers, and light fixtures. Do not tie the cables to electrical conduits or lay the cables on electrical fixtures.
 - ◆ The SFP module to be installed must comply with
 - ◆ CLASS 1 LASER PRODUCT according to IEC/EN 60825-1”
 - ◆ 21 CFR 1040.10 and 1040.11 except for deviations pursuant to Laser Notice No. 50, dated June 24, 2007

Rack Mounting

- ◆ Before working on the rack, make sure that the stabilizers are secured to the rack, extended to the floor, and that the full weight of the rack rests on the floor. Install front and side stabilizers on a single rack or front stabilizers for joined multiple racks before working on the rack.
- ◆ Always load the rack from the bottom up, and load the heaviest item in the rack first.
- ◆ Make sure that the rack is level and stable before extending a device from the rack.
- ◆ Use caution when pressing the device rail release latches and sliding a device into or out of a rack; the slide rails can pinch your fingers.
- ◆ After a device is inserted into the rack, carefully extend the rail into a locking position, and then slide the device into the rack.
- ◆ Do not overload the AC supply branch circuit that provides power to the rack. The total rack load should not exceed 80 percent of the branch circuit rating.
- ◆ Make sure that all equipment used on the rack – including power strips and other electrical connectors – is properly grounded.
- ◆ Ensure that proper airflow is provided to devices in the rack.
- ◆ Ensure that the operating ambient temperature of the rack environment does not exceed the maximum ambient temperature specified for the equipment by the manufacturer

- ◆ Do not step on or stand on any device when servicing other devices in a rack.

Consignes de sécurité

Général

- ◆ Ce produit est destiné exclusivement à une utilisation à l'intérieur.
- ◆ Veuillez lire la totalité de ces instructions. Conservez-les afin de pouvoir vous y référer ultérieurement.
- ◆ Respectez l'ensemble des avertissements et instructions inscrits sur l'appareil.
- ◆ Ne placez jamais l'unité sur une surface instable (chariot, pied, table, etc.). Si l'unité venait à tomber, elle serait gravement endommagée.
- ◆ N'utilisez pas l'unité à proximité de l'eau.
- ◆ Ne placez pas l'unité à proximité de ou sur des radiateurs ou bouches de chaleur.
- ◆ Le boîtier de l'unité est doté de fentes et d'ouvertures destinées à assurer une ventilation adéquate. Pour garantir un fonctionnement fiable et protéger l'unité contre les surchauffes, ces ouvertures ne doivent jamais être bloquées ou couvertes.
- ◆ L'unité ne doit jamais être placée sur une surface molle (lit, canapé, tapis, etc.) car ses ouvertures de ventilation se trouveraient bloquées. De même, l'unité ne doit pas être placée dans un meuble fermé à moins qu'une ventilation adaptée ne soit assurée.
- ◆ Ne renversez jamais de liquides de quelque sorte que ce soit sur l'unité.
- ◆ Evitez toute surcharge du circuit. Avant de connecter l'équipement à un circuit, vérifiez la limite de l'alimentation et ne la dépassez pas. Contrôlez toujours les caractéristiques électriques d'un circuit pour vous assurer de ne pas créer de situation dangereuse ou qu'il n'y en a pas déjà. Les surcharges du circuit peuvent provoquer un incendie et détruire l'équipement.
- ◆ Débranchez l'unité de la prise murale avant de la nettoyer. N'utilisez pas de produits de nettoyage liquide ou sous forme d'aérosol. Utilisez un chiffon humide pour le nettoyage de l'unité.
- ◆ L'appareil doit être alimenté par le type de source indiqué sur l'étiquette. Si vous n'êtes pas sûr du type d'alimentation disponible, consultez votre revendeur ou le fournisseur local d'électricité.
- ◆ Afin de ne pas endommager votre installation, vérifiez que tous les périphériques sont correctement mis à la terre.

- ♦ L'unité est équipée d'une fiche de terre à trois fils. Il s'agit d'une fonction de sécurité. Si vous ne parvenez pas à insérer la fiche dans la prise murale, contactez votre électricité afin qu'il remplace cette dernière qui doit être obsolète. N'essayez pas d'aller à l'encontre de l'objectif de la fiche de terre. Respectez toujours les codes de câblage en vigueur dans votre région/pays.
- ♦ L'équipement doit être installé à proximité de la prise murale et le dispositif de déconnexion (prise de courant femelle) doit être facile d'accès.
- ♦ La prise murale doit être installée à proximité de l'équipement et doit être facile d'accès.
- ♦ Veillez à ce que rien ne repose sur le cordon d'alimentation ou les câbles. Acheminez le cordon d'alimentation et les câbles de sorte que personne ne puisse marcher ou trébucher dessus.
- ♦ En cas d'utilisation d'une rallonge avec cette unité, assurez-vous que le total des ampérages de tous les produits utilisés sur cette rallonge ne dépasse pas l'ampérage nominal de cette dernière. Assurez-vous que le total des ampérages de tous les produits branchés sur la prise murale ne dépasse pas 15 ampères.
- ♦ Pour contribuer à protéger votre système contre les augmentations et diminutions soudaines et transitoires de puissance électrique, utilisez un parasurtenseur, un filtre de ligne ou un système d'alimentation sans coupure (UPS).
- ♦ Placez les câbles du système et les câbles d'alimentation avec précaution ; veillez à ce que rien ne repose sur aucun des câbles.
- ♦ Lors du branchement ou du débranchement à des blocs d'alimentation permettant la connexion à chaud, veuillez respecter les lignes directrices suivantes:
- ♦ Installez le bloc d'alimentation avant de brancher le câble d'alimentation à celui-ci.
- ♦ Débranchez le câble d'alimentation avant de retirer le bloc d'alimentation.
- ♦ Si le système présente plusieurs sources d'alimentation, déconnectez le système de l'alimentation en débranchant tous les câbles d'alimentation des blocs d'alimentation.
- ♦ N'insérez jamais d'objets de quelque sorte que ce soit dans ou à travers les fentes du boîtier. Ils pourraient entrer en contact avec des points de tension dangereuse ou court-circuiter des pièces, entraînant ainsi un risque d'incendie ou de choc électrique.

-
- ♦ N'essayez pas de réparer l'unité vous-même. Confiez toute opération de réparation à du personnel qualifié.
 - ♦ Si les conditions suivantes se produisent, débranchez l'unité de la prise murale et amenez-la à un technicien qualifié pour la faire réparer:
 - ♦ Le cordon d'alimentation ou la fiche ont été endommagés ou éraillés.
 - ♦ Du liquide a été renversé dans l'unité.
 - ♦ L'unité a été exposée à la pluie ou à l'eau.
 - ♦ L'unité est tombée ou le boîtier a été endommagé.
 - ♦ Les performances de l'unité sont visiblement altérées, ce qui indique la nécessité d'une réparation.
 - ♦ L'unité ne fonctionne pas normalement bien que les instructions d'utilisation soient respectées.
 - ♦ N'utilisez que les commandes qui sont abordées dans le mode d'emploi. Le réglage incorrect d'autres commandes peut être à l'origine de dommages qui nécessiteront beaucoup de travail pour qu'un technicien qualifié puisse réparer l'unité.
 - ♦ Tenez le câble de catégorie 5e/6 le plus éloigné possible des sources potentielles d'interférences électromagnétiques, telles que les câbles électriques, transformateurs et appareils d'éclairage. Ne nouez pas les câbles à des conduits électriques et ne les faites pas passer sur des installations électriques.

Montage sur bâti

- ♦ Avant de travailler sur le bâti, assurez-vous que les stabilisateurs sont bien fixés sur le bâti, qu'ils sont étendus au sol et que tout le poids du bâti repose sur le sol. Installez les stabilisateurs avant et latéraux sur un même bâti ou bien les stabilisateurs avant si plusieurs bâtis sont réunis, avant de travailler sur le bâti.
- ♦ Chargez toujours le bâti de bas en haut et chargez l'élément le plus lourd en premier.
- ♦ Assurez-vous que le bâti est à niveau et qu'il est stable avant de sortir une unité du bâti.
- ♦ Agissez avec précaution lorsque vous appuyez sur les loquets de libération du rail d'unité et lorsque vous faites coulisser une unité dans et hors d'un bâti ; vous pourriez vous pincer les doigts dans les rails.
- ♦ Une fois qu'une unité a été insérée dans le bâti, étendez avec précaution le rail dans une position de verrouillage puis faites glisser l'unité dans le bâti.
- ♦ Ne surchargez pas le circuit de l'alimentation CA qui alimente le bâti. La charge totale du bâti ne doit pas dépasser 80 % de la capacité du circuit.
- ♦ Assurez-vous que tous les équipements utilisés sur le bâti, y-compris les multiprises et autres connecteurs électriques, sont correctement mis à la terre.
- ♦ Assurez-vous que les unités présentes dans le bâti bénéficie d'une circulation d'air suffisante.
- ♦ Assurez-vous que la température ambiante de fonctionnement de l'environnement du bâti ne dépasse pas la température ambiante maximale spécifiée pour l'équipement par le fabricant.
- ♦ Ne marchez sur aucun appareil lors de la maintenance d'autres appareils d'un bâti.

Technical Support

International

- ◆ For online technical support – including troubleshooting, documentation, and software updates: <http://eservice.aten.com>
- ◆ For telephone support, see *Telephone Support*, page iii.

North America

Email Support		support@aten-usa.com
Online Technical Support	Troubleshooting Documentation Software Updates	http://eservice.aten.com
Telephone Support		1-888-999-ATEN ext 4988 1-949-428-1111

When you contact us, please have the following information ready beforehand:

- ◆ Product model number, serial number, and date of purchase.
- ◆ Your computer configuration, including operating system, revision level, expansion cards, and software.
- ◆ Any error messages displayed at the time the error occurred.
- ◆ The sequence of operations that led up to the error.
- ◆ Any other information you feel may be of help.

Troubleshoot

Faults	Possible Causes	Suggested Solutions
System LED is Off	The switch is not receiving power.	<ol style="list-style-type: none"> 1. Check if correct power cord is connected firmly to the switch and to the AC outlet socket. 2. Perform power cycling the switch by unplugging and plugging the power cord back into the switch. 3. If the LED is still off, try to plug power cord into different AC outlet socket to make sure correct AC source is supplied.
System LED is Red	An abnormal state has been detected by the switch.	Check the system log within the switch from WEB UI to understand the abnormal state (e.g. exceeding operating temperature range) and take corresponding actions to resolve.
Port Status LED is Off in Link/Act/Speed Mode	The port is not connected or the connection is not working.	<ol style="list-style-type: none"> 1. Check if the cable connector plug is firmly inserted and locked into the port at both the switch and the connected device. 2. Make sure the connected device is up and running correctly. 3. If the symptom still exists, try different cable or different port, in order to identify if it is related to the cable or specific port. 4. Check if the port is disabled in the configuration settings via WEB user interface.
Port Status LED is Off in PoE Mode	The port is not supplying power.	<ol style="list-style-type: none"> 1. Check if the cable connector plug is firmly inserted and locked into the port at both the switch and the connected device. 2. Make sure the correct Ethernet cables are used. 3. If the symptom still exists, try different cable or different port, in order to identify if it is related to the cable or specific port. 4. Check if the port is disabled in the configuration settings via WEB user interface.

Specifications

Function	ES0154	ES0154P
Connectors		
RJ-45 10/100/1000 Ports	48	
SFP28 Uplink Ports	6	
Console Ports	1 x RJ-45	
Remote Console	1 x RJ-45	
USB Port	1	
Performance		
Switching Capacity	396 Gbps	
Forwarding Rate	295 Mpps	
Flash Memory	256 MB	
DRAM	1 GB	
MAC Address Table Size	32 K	
Jumbo Frames	10 KB	
Auto-negotiation	Yes	
Maximum Input Power Rating	100 – 240 V AC, 50 – 60 Hz	100 – 240 V AC, 50 – 60 Hz
Power Consumption	52WBTU	835WBTU
Environmental		
Operating Temperature	-5 – 45°C	
Storage Temperature	-40 – 70 °C	
Humidity	5 – 95% RH, Non-condensing	
Physical Properties		
Rack Space	19"	
Housing	Metal	
Weight	4.68 kg (10.32 lb)	5.42 kg (11.94 lb)
Dimensions (L x W x H)	44.20 x 42.00 x 4.36 cm (17.40 x 16.54 x 1.72 in)	
PoE		
Standard Compliance	N/A	802.3af PoE / 802.3at PoE+ / 802.3bt PoE++ (41-48 ports only)

Function	ES0154	ES0154P
Number of Ports That Support PoE/PoE +	N/A	48
Total PoE Power Budget	N/A	740W
Max. PoE Power Budget per Port	N/A	PoE: 15.4W / PoE+: 30W / PoE++: 90W (41-48 port only)

ATEN Standard Warranty Policy

Limited Hardware Warranty

ATEN warrants its hardware in the country of purchase against flaws in materials and workmanship for a Warranty Period of two [2] years (warranty period may vary in certain regions/countries) commencing on the date of original purchase. This warranty period includes the [LCD panel of ATEN LCD KVM switches](#). For UPS products, the device warranty is two [2] years but battery is one [1] year. Select products are warranted for an additional year (see [A+ Warranty](#) for further details). Cables and accessories are not covered by the Standard Warranty.

What is covered by the Limited Hardware Warranty

ATEN will provide a repair service, without charge, during the Warranty Period. If a product is defective, ATEN will, at its discretion, have the option to (1) repair said product with new or repaired components, or (2) replace the entire product with an identical product or with a similar product which fulfills the same function as the defective product. Replaced products assume the warranty of the original product for the remaining period or a period of 90 days, whichever is longer. When the products or components are replaced, the replacing articles shall become customer property and the replaced articles shall become the property of ATEN.

To learn more about our warranty policies, please visit our website:

<http://www.aten.com/global/en/legal/policies/warranty-policy/>

© Copyright 2024 ATEN® International Co., Ltd.
Released: 2024-02-07

ATEN and the ATEN logo are registered trademarks of ATEN International Co., Ltd. All rights reserved. All other brand names and trademarks are the registered property of their respective owners.

