

Category 6A field termination plug



Category 6A field termination plug (PGSmc, PGSmc#12)

TUK's Cat6A field termination plug is the RJ45 plug for time-saving and efficient on-site assembly for all networks, from Voice right through to 10 Gigabit Ethernet. It can be assembled on all standard types of cable, quickly and with no requirement of special tools. Whether in the office, data centre, in industry or in home networks – the Cat6A field termination plug offers flexibility and saves time and money on installation, repairs and maintenance.

Features

- Category 6A Class EA Field Termination Plug, with 568A/B and PNO wiring label
- Robust industrial fully shielded design
- Works with solid or stranded cable
- Suitable for use with a wide range of cable outer diameter and core sizes – 6-9mm cable OD, 22-27 AWG cores (core including insulation up to OD 1.6mm)
- Reusable (27AWG cable only reusable up to 5 times)
- No tools required for time saving and efficient termination on site
- Supplied with plug cover.
- Rated for 750 mechanical cycles
- IP20 rated and UL approved
- Operating temperature: -40°C to 60°C

- Compliant with PoE+ and 4PPoE
- Note: not ideal for short length (4m or less) Category 6A patch cords

Specifications

- **Materials:**
 - RJ45 plug: housing: nickel-plated zinc-alloy, contacts: 50 μ "/1.27 μ m gold plating over phosphor bronze
plug cover: ABS, plug latch: POM
 - RJ45 jack: housing nickel-plated zinc-alloy
 - IDC: housing and cover: PC FR, terminals/contacts: tin-plated phosphor bronze
 - Earthing plate: SUS304
 - Strain relief: PP

- **Net Weights (including primary packaging):**

- PGSmc: 22g
- PGSmc#12: 268g

- **Dimensions (including primary packaging):**

- PGSmc: 60 x 70 x 20 mm
- PGSmc#12: 105 x 220 x 25 mm

- **Packaging:**

PGSmc: in individual poly bag then in bags of 20
PGSmc#12: single use plastic minimised, in a carton of 12

- **EAN:**

PGSmc: 5055386505934
PGSmc#12: 5055386510181

- **Commodity Code:** 85444920

- **Country of Origin:** China

Illustrative image of packaging:



Instruction Manual

	TIA / EIA T568A	TIA / EIA T568B	INDUSTRIAL	
JACK PIN DESIGNATIONS	1	White/Green	Yellow Orange	
	2	Green	Orange	
	3	White/Orange	White/Green	White Blue
	6	Orange	Green	
	4	Blue	Blue	
	5	White/Blue	White/Blue	
	7	White/Brown	White/Brown	
	8	Brown	Brown	

①

Remove the stopper before installation.

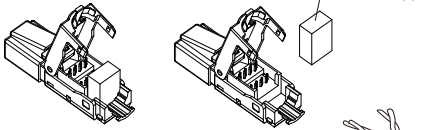

②

Insert cable into strain relief boot, strip off 1.2 inch of cable jacket, fold back the drain wire.

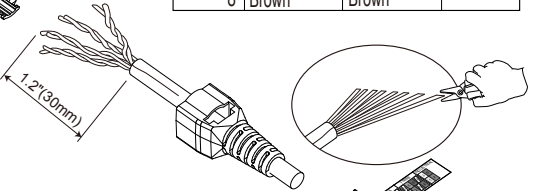

③

Fan out all four twisted pairs, following the color coding label and allocate each conductors into proper slots on wiring cap. Trim the ends of conductors.

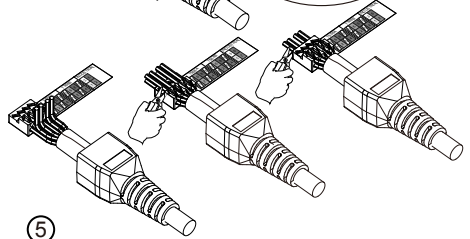

④

Remove the wiring label before place wiring cap on plug.

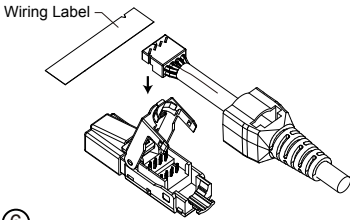

⑤

Place the wiring cap onto plug, use plier to clamp wiring cap until it completely snap-in to effect the connection.

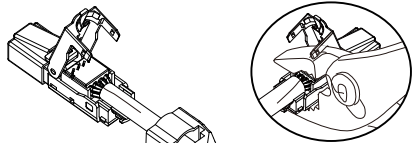

⑥

Close plug cover, make sure the drain wire is in proper contact with grounding clip on plug. Pull back strain relief boot to cover the plug, fasten supplied cable tie to secure grounding contact.

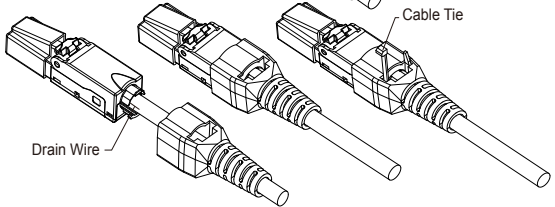

Unload the cable

Cut off cable tie, remove the boot. Using flat screw driver and pry gently on plug cover one end first and the other end subsequently to open it.

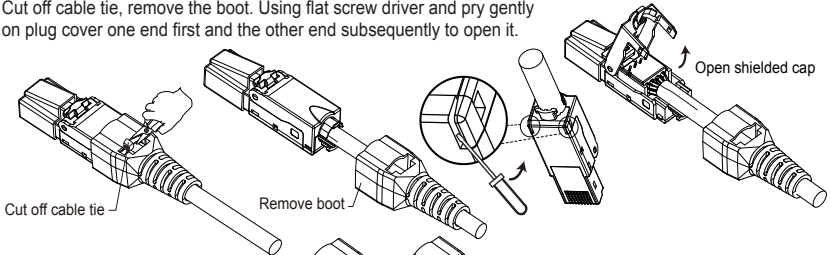

Boot adjustment

Cut the end of boot to fit your cable OD.

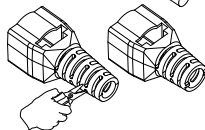

NB. Designed for lengths of 4m or more. Shorter lengths may not have full Category 6A performance



PGSmc



ROHS Compliant

Code: PGSmc

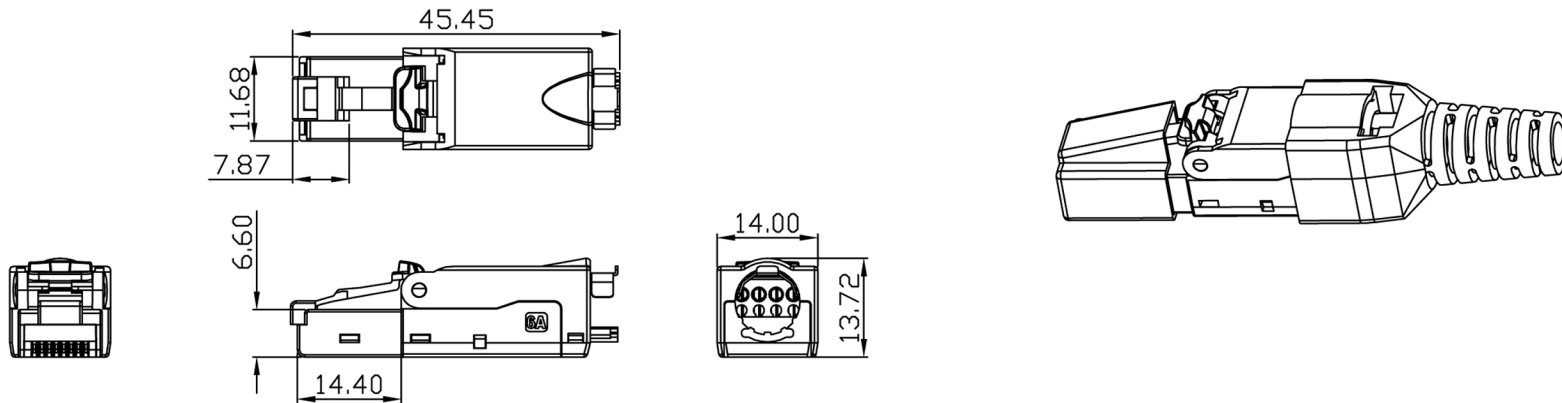

SPECIFICATION

- Current rating : 1.5A
- Dielectric withstanding voltage :
Contact/contact:mated or terminated connectors 1000V DC
All contacts to screen:mated or terminated connectors 1000V DC
- Insulation resistance : 500M Ω MIN.
- Contact resistance : 20m Ω MAX.
- Durability:750 mechanical cycles
- Wiring properties: 27~22 AWG(resuable up to 5 times only for 27AWG)
- Supporting cable diameter: 6~9mm

MATERIAL

- (1) RJ45 Plug cover:ABS
- (2) RJ45 Plug Contact:Phosphor bronze, 50u" Glod plating
- (3) RJ45 Plug Housing: Zinc-alloy ,Nickel Plated
- (4) RJ45 Plug Latch:POM
- (5) IDC Housing: PC FR
- (6) RJ45 JACK Bottom cover: Zinc-alloy ,Nickel Plated
- (7) IDC Housing cover: PC FR
- (8) IDC Terminals: Phosphor bronze,Tin Plated
- (9) Grounding plate:SUS304
- (10) Cable cover:PP

